

# 2005 Pontiac Bonneville Owner Manual

<b>Seats and Restraint Systems</b> .....	1-1	Secondary Information Center (SIC) .....	3-70
Front Seats .....	1-2	Audio System(s) .....	3-72
Safety Belts .....	1-7	<b>Driving Your Vehicle</b> .....	4-1
Child Restraints .....	1-28	Your Driving, the Road, and Your Vehicle .....	4-2
Airbag System .....	1-47	Towing .....	4-34
Restraint System Check .....	1-56	<b>Service and Appearance Care</b> .....	5-1
<b>Features and Controls</b> .....	2-1	Service .....	5-3
Keys .....	2-2	Fuel .....	5-5
Doors and Locks .....	2-9	Checking Things Under the Hood .....	5-10
Windows .....	2-17	Bulb Replacement .....	5-67
Theft-Deterrent Systems .....	2-19	Windshield Wiper Blade Replacement .....	5-73
Starting and Operating Your Vehicle .....	2-23	Tires .....	5-74
Mirrors .....	2-36	Appearance Care .....	5-101
OnStar <sup>®</sup> System .....	2-39	Vehicle Identification .....	5-110
HomeLink <sup>®</sup> Transmitter .....	2-40	Electrical System .....	5-111
Storage Areas .....	2-44	Capacities and Specifications .....	5-121
Sunroof .....	2-45	Normal Maintenance Replacement Parts .....	5-122
Vehicle Personalization .....	2-46	<b>Maintenance Schedule</b> .....	6-1
<b>Instrument Panel</b> .....	3-1	Maintenance Schedule .....	6-2
Instrument Panel Overview .....	3-4	<b>Customer Assistance and Information</b> .....	7-1
Climate Controls .....	3-25	Customer Assistance and Information .....	7-2
Warning Lights, Gages, and Indicators .....	3-33	Reporting Safety Defects .....	7-10
Systems Monitor .....	3-58	<b>Index</b> .....	1
Driver Information Center (DIC) .....	3-59		



GENERAL MOTORS, GM, the GM Emblem, PONTIAC, the PONTIAC Emblem, and the name BONNEVILLE are registered trademarks of General Motors Corporation.

This manual includes the latest information at the time it was printed. We reserve the right to make changes after that time without further notice. For vehicles first sold in Canada, substitute the name "General Motors of Canada Limited" for Pontiac Division whenever it appears in this manual.

Keep this manual in the vehicle, so it will be there if it is needed while you are on the road. If the vehicle is sold, leave this manual in the vehicle.

## Canadian Owners

A French language copy of this manual can be obtained from your dealer or from:

Helm, Incorporated  
P.O. Box 07130  
Detroit, MI 48207

## How to Use This Manual

Many people read the owner manual from beginning to end when they first receive their new vehicle. If this is done, it can help you learn about the features and controls for the vehicle. Pictures and words work together in the owner manual to explain things.

## Index

A good place to quickly locate information about the vehicle is the Index in the back of the manual. It is an alphabetical list of what is in the manual and the page number where it can be found.

## Safety Warnings and Symbols

There are a number of safety cautions in this book. We use a box and the word CAUTION to tell about things that could hurt you if you were to ignore the warning.

 **CAUTION:**

**These mean there is something that could hurt you or other people.**

In the caution area, we tell you what the hazard is. Then we tell you what to do to help avoid or reduce the hazard. Please read these cautions. If you do not, you or others could be hurt.

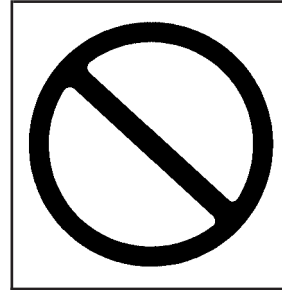

You will also find a circle with a slash through it in this book. This safety symbol means “Do Not,” “Do Not do this” or “Do Not let this happen.”

## Vehicle Damage Warnings

Also, in this manual you will find these notices:

**Notice:** These mean there is something that could damage your vehicle.

A notice tells about something that can damage the vehicle. Many times, this damage would not be covered by your vehicle's warranty, and it could be costly. But the notice will tell what to do to help avoid the damage.

When you read other manuals, you might see CAUTION and NOTICE warnings in different colors or in different words.

There are also warning labels on the vehicle. They use the same words, CAUTION or NOTICE.

































## Vehicle Symbols

The vehicle has components and labels that use symbols instead of text. Symbols are shown along with the text describing the operation or information relating to a specific component, control, message, gage, or indicator.

If you need help figuring out a specific name of a component, gage, or indicator, reference the following topics:

- Seats and Restraint Systems in Section 1
- Features and Controls in Section 2
- Instrument Panel Overview in Section 3
- Climate Controls in Section 3
- Warning Lights, Gages, and Indicators in Section 3
- Audio System(s) in Section 3
- Engine Compartment Overview in Section 5

These are some examples of symbols that may be found on the vehicle:

CAUTION POSSIBLE INJURY		LATCH BOTH LAP AND SHOULDER BELTS TO PROTECT OCCUPANT DO NOT TWIST SAFETY BELT WHEN ATTACHING	 	MASTER LIGHTING SWITCH		ENGINE COOLANT TEMP		FUSE BOX ACCESS			
PROTECT EYES BY SHIELDING		FASTEN SEAT BELTS		AIR BAG		TURN SIGNALS		BATTERY CHARGING SYSTEM		ENGINE COOLANT FAN	
CAUSTIC BATTERY ACID COULD CAUSE BURNS		MOVE SEAT FULLY REARWARD SECURE CHILD SEAT		DO NOT INSTALL A REAR-FACING CHILD RESTRAINT IN THIS SEATING POSITION		PARKING LAMPS		BRAKE		FUEL	
AVOID SPARKS OR FLAMES		PULL BELT OUT COMPLETELY THEN SECURE CHILD SEAT		DO NOT INSTALL A FORWARD-FACING CHILD RESTRAINT IN THIS SEATING POSITION		HAZARD WARNING FLASHER		COOLANT		OWNER'S MANUAL	
SPARK OR FLAME COULD EXPLODE BATTERY		POWER WINDOW		DOOR LOCK UNLOCK		DAYTIME RUNNING LAMPS		ENGINE OIL PRESSURE		SERVICE MANUAL	
						FOG LAMPS		ANTI-LOCK BRAKES			



# Section 1 Seats and Restraint Systems

---

<b>Front Seats</b> .....	1-2	Where to Put the Restraint .....	1-37
Manual Seats .....	1-2	Top Strap .....	1-38
Power Seats .....	1-2	Top Strap Anchor Location .....	1-39
Manual Lumbar .....	1-3	Lower Anchorages and Top Tethers for Children (LATCH System) .....	1-40
Power Lumbar .....	1-3	Securing a Child Restraint Designed for the LATCH System .....	1-42
Heated Seats .....	1-4	Securing a Child Restraint in a Rear Seat Position .....	1-42
Reclining Seatbacks .....	1-4	Securing a Child Restraint in the Center Front Seat Position .....	1-44
Power Reclining Seatback .....	1-5	Securing a Child Restraint in the Right Front Seat Position .....	1-45
Head Restraints .....	1-7	<b>Airbag System</b> .....	1-47
<b>Safety Belts</b> .....	1-7	Where Are the Airbags? .....	1-50
Safety Belts: They Are for Everyone .....	1-7	When Should an Airbag Inflate? .....	1-52
Questions and Answers About Safety Belts .....	1-12	What Makes an Airbag Inflate? .....	1-53
How to Wear Safety Belts Properly .....	1-12	How Does an Airbag Restrain? .....	1-53
Driver Position .....	1-13	What Will You See After an Airbag Inflates? .....	1-54
Safety Belt Use During Pregnancy .....	1-19	Servicing Your Airbag-Equipped Vehicle .....	1-56
Right Front Passenger Position .....	1-20	<b>Restraint System Check</b> .....	1-56
Center Front Passenger Position .....	1-20	Checking Your Restraint Systems .....	1-56
Rear Seat Passengers .....	1-21	Replacing Restraint System Parts After a Crash .....	1-57
Rear Safety Belt Comfort Guides for Children and Small Adults .....	1-25		
Safety Belt Extender .....	1-27		
<b>Child Restraints</b> .....	1-28		
Older Children .....	1-28		
Infants and Young Children .....	1-30		
Child Restraint Systems .....	1-34		

# Front Seats

## Manual Seats

### CAUTION:

**You can lose control of the vehicle if you try to adjust a manual driver's seat while the vehicle is moving. The sudden movement could startle and confuse you, or make you push a pedal when you do not want to. Adjust the driver's seat only when the vehicle is not moving.**

Pull up on the control bar located under the front of the seat to unlock it. Slide the seat to where you want it and release the bar. Try to move the seat with your body to make sure the seat is locked into place.

## Power Seats



If your vehicle has this feature, the control for the power seat is located on the outboard side of each front seat.

To adjust the power seats, do the following:

- Raise or lower the front of the seat cushion by pressing the forward edge of the control up or down.
- Raise or lower the rear of the seat cushion by pressing the rear edge of the control up or down.
- Move the seat forward or rearward by pressing the control toward the front or rear of the vehicle.
- Raise or lower the entire seat by holding the whole control up or down.



## Manual Lumbar



The knob that controls this feature is located on the outboard side of each front seat. Turn the knob toward the front of the vehicle to increase lumbar support. Turn the knob toward the rear of the vehicle to decrease lumbar support.

If you have the independent front cushion moved down as far as it will go, you may feel the lumbar support higher in your back. Readjust the location of the cushion until you are comfortable. You may also want to adjust the seatback for maximum comfort.

## Power Lumbar



If your vehicle has this feature, the power lumbar control is located on the outboard side of each front seat. Use the power seat control first to get the proper position. Then continue with the lumbar adjustment.

To reshape the lower seatback, press the lumbar control forward to increase support and rearward to decrease support. Press the control up or down to raise or lower the support mechanism.

Keep in mind that as your seating position changes, as it may during long trips, so should the position of your lumbar support. Adjust the seat as needed.

If you have the independent front cushion moved down as far as it will go, you may feel the lumbar support higher in your back. Readjust the location of the cushion until you are comfortable. You may also want to adjust the seatback for maximum comfort.

## Heated Seats



If your vehicle has this feature, the heated front seat controls are located on the instrument panel under the climate controls.

Press ON once for the HI setting or twice for the LO setting. The lights above the button will come on to indicate which setting has been activated. Press OFF to turn the heated seat off.

The LO setting warms the seatback and cushion until the seat approximates body temperature. The HI setting heats the seatback and cushion to a slightly higher temperature.

The heated seats can only be used when the ignition is turned on. The heating elements in the seats automatically turn off when the vehicle's ignition is turned off.

## Reclining Seatbacks

If your vehicle has the manual recliner, lift the lever on the outboard side of the seat and move the seatback to the desired position. Release the lever to lock the seatback. Pull up on the lever without pushing on the seatback and the seatback will go to an upright position.

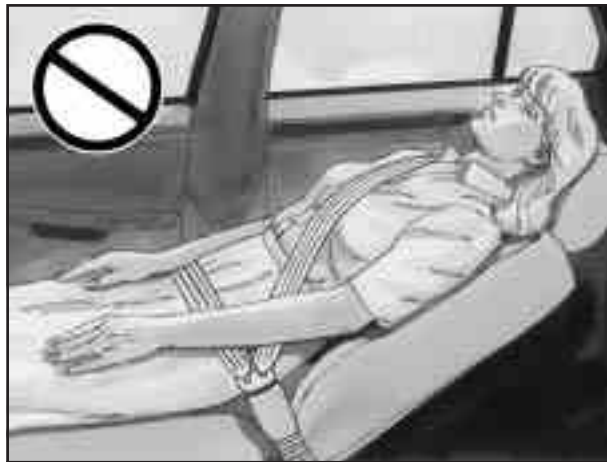

Do not have the seatback reclined if your vehicle is moving.

**⚠ CAUTION:**

**Sitting in a reclined position when your vehicle is in motion can be dangerous. Even if you buckle up, your safety belts can not do their job when you are reclined like this.**

**The shoulder belt can not do its job. In a crash, you could go into it, receiving neck or other injuries.**

**The lap belt can not do its job either. In a crash the belt could go up over your abdomen. The belt forces would be there, not at your pelvic bones. This could cause serious internal injuries.**

**For proper protection when the vehicle is in motion, have the seatback upright. Then sit well back in the seat and wear your safety belt properly.**

## Power Reclining Seatback



If your vehicle has power reclining seats, the switch is located on the outboard side of both front seats.

Press the switch toward the rear of the vehicle to recline the seat and toward the front of the vehicle to raise the seat.



Do not have the seatback reclined if your vehicle is moving.

**⚠ CAUTION:**

Sitting in a reclined position when your vehicle is in motion can be dangerous. Even if you buckle up, your safety belts can not do their job when you are reclined like this.

The shoulder belt can not do its job. In a crash, you could go into it, receiving neck or other injuries.

The lap belt can not do its job either. In a crash the belt could go up over your abdomen. The belt forces would be there, not at your pelvic bones. This could cause serious internal injuries.

For proper protection when the vehicle is in motion, have the seatback upright. Then sit well back in the seat and wear your safety belt properly.

## Head Restraints



Adjust your head restraint so that the top of the restraint is closest to the top of your head. This position reduces the chance of a neck injury in a crash.

## Safety Belts

### Safety Belts: They Are for Everyone

This part of the manual tells you how to use safety belts properly. It also tells you some things you should not do with safety belts.

#### **CAUTION:**

**Do not let anyone ride where he or she can not wear a safety belt properly. If you are in a crash and you are not wearing a safety belt, your injuries can be much worse. You can hit things inside the vehicle or be ejected from it. You can be seriously injured or killed. In the same crash, you might not be, if you are buckled up. Always fasten your safety belt, and check that your passengers' belts are fastened properly too.**

**⚠ CAUTION:**

**It is extremely dangerous to ride in a cargo area, inside or outside of a vehicle. In a collision, people riding in these areas are more likely to be seriously injured or killed. Do not allow people to ride in any area of your vehicle that is not equipped with seats and safety belts. Be sure everyone in your vehicle is in a seat and using a safety belt properly.**

You never know if you will be in a crash. If you do have a crash, you do not know if it will be a bad one.

A few crashes are mild, and some crashes can be so serious that even buckled up, a person would not survive. But most crashes are in between. In many of them, people who buckle up can survive and sometimes walk away. Without belts they could have been badly hurt or killed.

After more than 30 years of safety belts in vehicles, the facts are clear. In most crashes buckling up does matter...a lot!



Your vehicle has a light that comes on as a reminder to buckle up. See *Safety Belt Reminder Light* on page 3-38.

In most states and in all Canadian provinces, the law says to wear safety belts. Here is why: *They work.*

## Why Safety Belts Work

When you ride in or on anything, you go as fast as it goes.

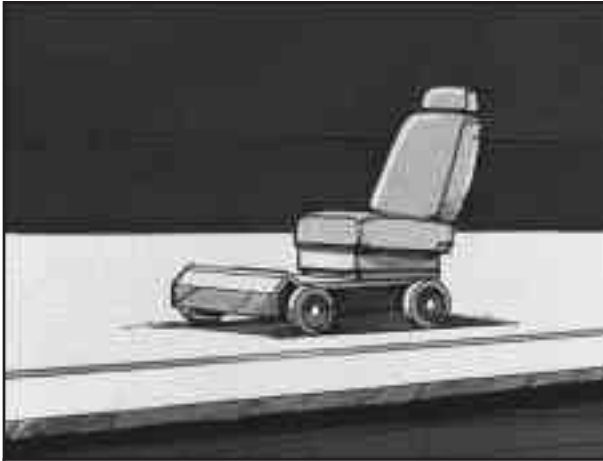

Take the simplest vehicle. Suppose it is just a seat on wheels.



Put someone on it.

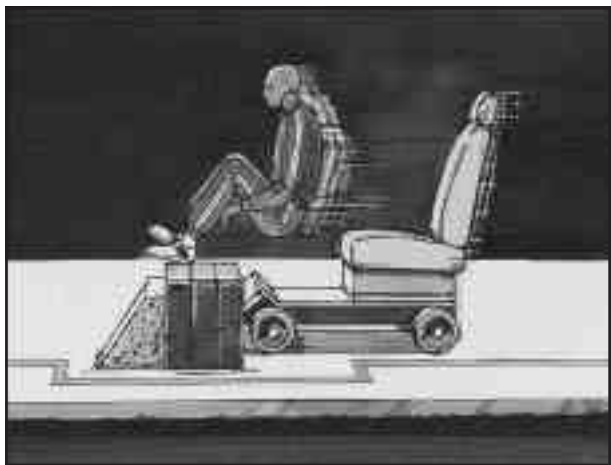

Get it up to speed. Then stop the vehicle. The rider does not stop.



The person keeps going until stopped by something. In a real vehicle, it could be the windshield...





or the instrument panel...



or the safety belts!

With safety belts, you slow down as the vehicle does. You get more time to stop. You stop over more distance, and your strongest bones take the forces. That is why safety belts make such good sense.

## Questions and Answers About Safety Belts

**Q:** Will I be trapped in the vehicle after an accident if I am wearing a safety belt?

**A:** You *could* be — whether you are wearing a safety belt or not. But you can unbuckle a safety belt, even if you are upside down. And your chance of being conscious during and after an accident, so you *can* unbuckle and get out, is *much* greater if you are belted.

**Q:** If my vehicle has airbags, why should I have to wear safety belts?

**A:** Airbags are in many vehicles today and will be in most of them in the future. But they are supplemental systems only; so they work *with* safety belts — not instead of them. Every airbag system ever offered for sale has required the use of safety belts. Even if you are in a vehicle that has airbags, you still have to buckle up to get the most protection. That is true not only in frontal collisions, but especially in side and other collisions.

**Q:** If I am a good driver, and I never drive far from home, why should I wear safety belts?

**A:** You may be an excellent driver, but if you are in an accident — even one that is not your fault — you and your passengers can be hurt. Being a good driver does not protect you from things beyond your control, such as bad drivers.

Most accidents occur within 25 miles (40 km) of home. And the greatest number of serious injuries and deaths occur at speeds of less than 40 mph (65 km/h).

Safety belts are for everyone.

## How to Wear Safety Belts Properly

This part is only for people of adult size.

Be aware that there are special things to know about safety belts and children. And there are different rules for smaller children and babies. If a child will be riding in your vehicle, see *Older Children on page 1-28* or *Infants and Young Children on page 1-30*. Follow those rules for everyone's protection.

First, you will want to know which restraint systems your vehicle has.

We will start with the driver position.

## Driver Position

### Lap-Shoulder Belt

The driver has a lap-shoulder belt. Here is how to wear it properly.

1. Close and lock the door.
2. Adjust the seat so you can sit up straight. To see how, see "Seats" in the Index.

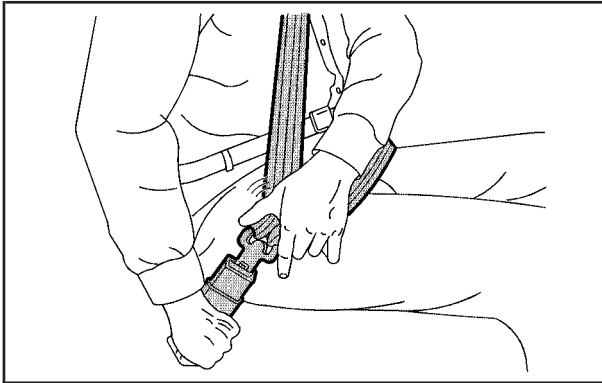

3. Pick up the latch plate and pull the belt across you. Do not let it get twisted.

The lap-shoulder belt may lock if you pull the belt across you very quickly. If this happens, let the belt go back slightly to unlock it. Then pull the belt across you more slowly.

4. Push the latch plate into the buckle until it clicks. Pull up on the latch plate to make sure it is secure. If the belt is not long enough, see *Safety Belt Extender on page 1-27*.

Make sure the release button on the buckle is positioned so you would be able to unbuckle the safety belt quickly if you ever had to.

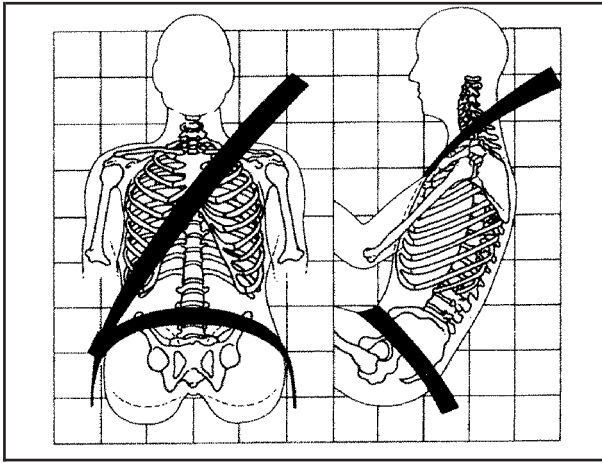

The lap part of the belt should be worn low and snug on the hips, just touching the thighs. In a crash, this applies force to the strong pelvic bones. And you would be less likely to slide under the lap belt. If you slid under it, the belt would apply force at your abdomen. This could cause serious or even fatal injuries. The shoulder belt should go over the shoulder and across the chest. These parts of the body are best able to take belt restraining forces.

The safety belt locks if there is a sudden stop or crash, or if you pull the belt very quickly out of the retractor.

**Q:** What is wrong with this?

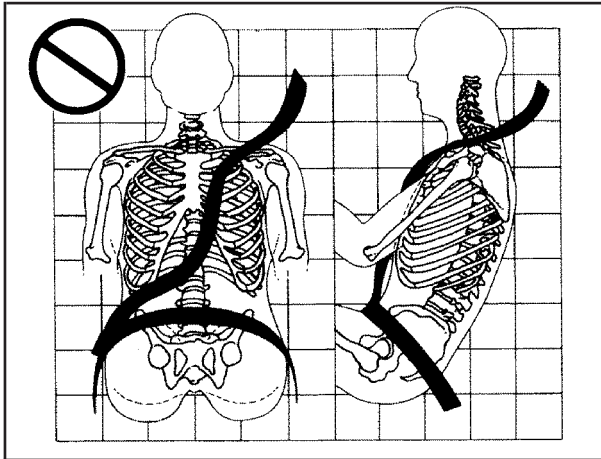

**A:** The shoulder belt is too loose. It will not give nearly as much protection this way.

**⚠ CAUTION:**

You can be seriously hurt if your shoulder belt is too loose. In a crash, you would move forward too much, which could increase injury. The shoulder belt should fit against your body.

**Q:** What is wrong with this?

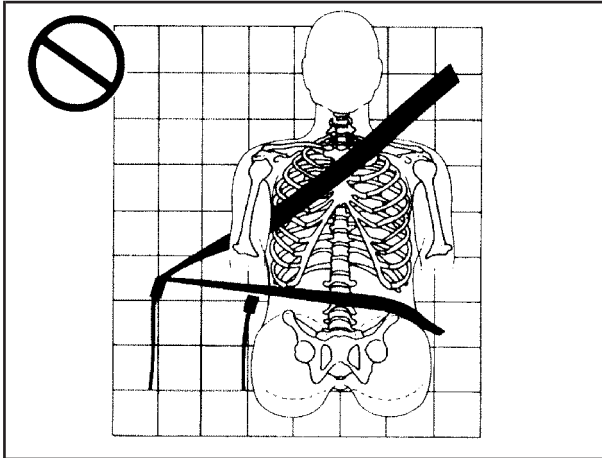

**A:** The belt is buckled in the wrong place.

**⚠ CAUTION:**

You can be seriously injured if your belt is buckled in the wrong place like this. In a crash, the belt would go up over your abdomen. The belt forces would be there, not at the pelvic bones. This could cause serious internal injuries. Always buckle your belt into the buckle nearest you.

**Q:** What is wrong with this?

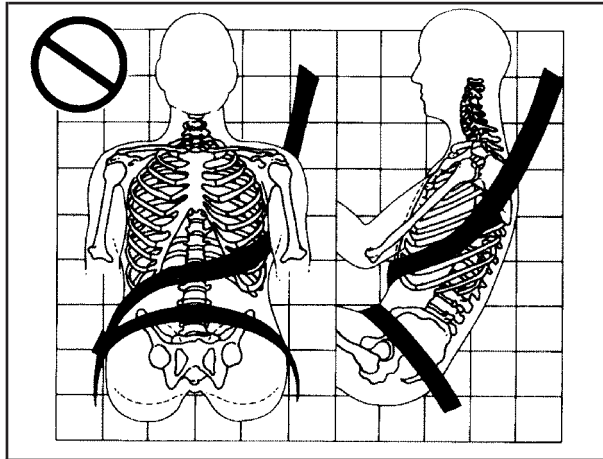

**A:** The shoulder belt is worn under the arm. It should be worn over the shoulder at all times.

**⚠ CAUTION:**

You can be seriously injured if you wear the shoulder belt under your arm. In a crash, your body would move too far forward, which would increase the chance of head and neck injury. Also, the belt would apply too much force to the ribs, which are not as strong as shoulder bones. You could also severely injure internal organs like your liver or spleen.

**Q:** What is wrong with this?

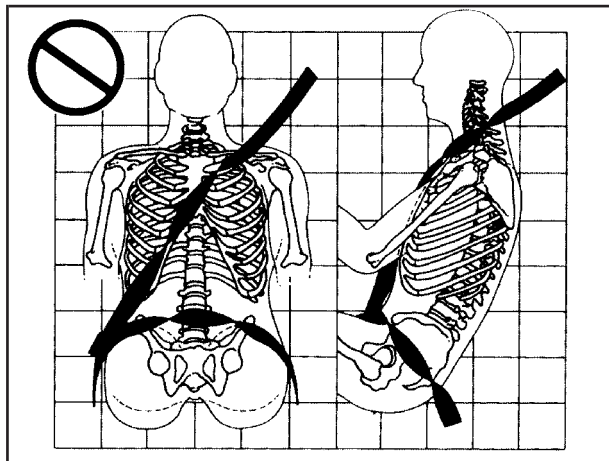

**A:** The belt is twisted across the body.

**⚠ CAUTION:**

You can be seriously injured by a twisted belt. In a crash, you would not have the full width of the belt to spread impact forces. If a belt is twisted, make it straight so it can work properly, or ask your dealer to fix it.



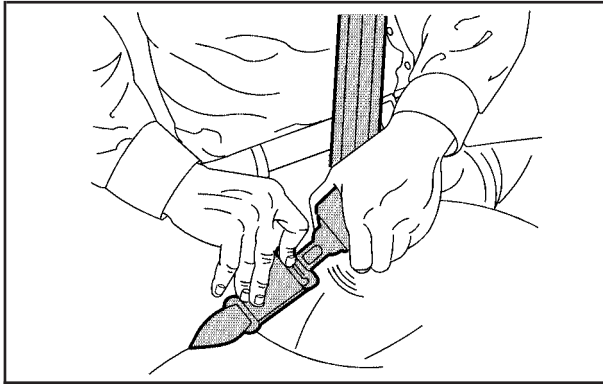

To unclatch the belt, just push the button on the buckle. The belt should go back out of the way.

Before you close the door, be sure the belt is out of the way. If you slam the door on it, you can damage both the belt and your vehicle.

## Safety Belt Use During Pregnancy

Safety belts work for everyone, including pregnant women. Like all occupants, they are more likely to be seriously injured if they do not wear safety belts.

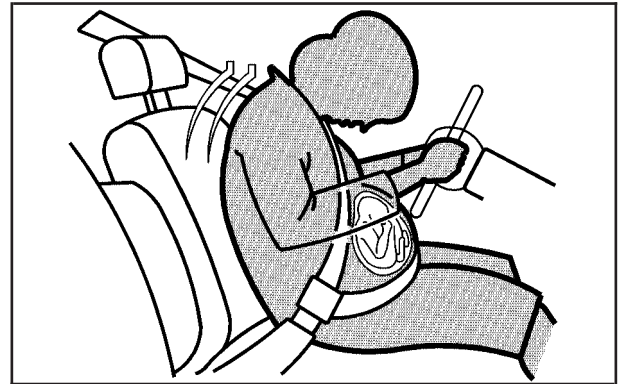

A pregnant woman should wear a lap-shoulder belt, and the lap portion should be worn as low as possible, below the rounding, throughout the pregnancy.

The best way to protect the fetus is to protect the mother. When a safety belt is worn properly, it is more likely that the fetus will not be hurt in a crash. For pregnant women, as for anyone, the key to making safety belts effective is wearing them properly.

## Right Front Passenger Position

To learn how to wear the right front passenger's safety belt properly, see *Driver Position on page 1-13*.

The right front passenger's safety belt works the same way as the driver's safety belt — except for one thing. If you ever pull the lap portion of the belt out all the way, you will engage the child restraint locking feature. If this happens, just let the belt go back all the way and start again.

If your vehicle has a center passenger position, be sure to use the correct buckle when buckling your lap-shoulder belt. If you find that the latch plate will not go fully into the buckle, see if you are using the buckle for the center passenger position.

## Center Front Passenger Position

### Lap Belt

If your vehicle has a front bench seat, someone can sit in the center position.

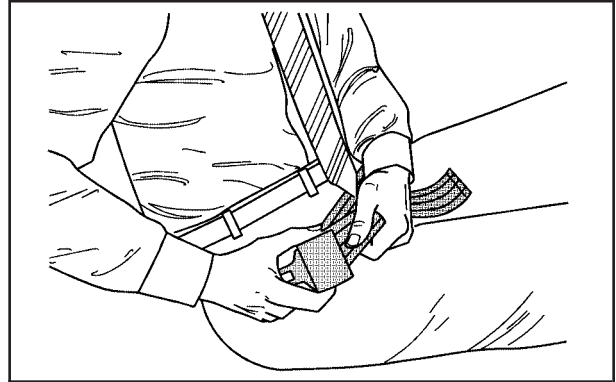

When you sit in the center front seating position, you have a lap safety belt, which has no retractor. To make the belt longer, tilt the latch plate and pull it along the belt.

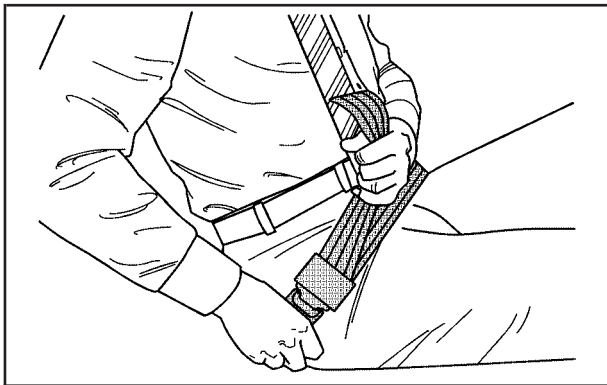

## Rear Seat Passengers

It is very important for rear seat passengers to buckle up! Accident statistics show that unbelted people in the rear seat are hurt more often in crashes than those who are wearing safety belts.

Rear passengers who are not safety belted can be thrown out of the vehicle in a crash. And they can strike others in the vehicle who are wearing safety belts.

To make the belt shorter, pull its free end as shown until the belt is snug.

Buckle, position and release it the same way as the lap part of a lap-shoulder belt. If the belt is not long enough, see *Safety Belt Extender* on page 1-27.

Make sure the release button on the buckle is positioned so you would be able to unbuckle the safety belt quickly if you ever had to.

## Lap-Shoulder Belt

All rear seating positions have lap-shoulder belts. Here is how to wear one properly.

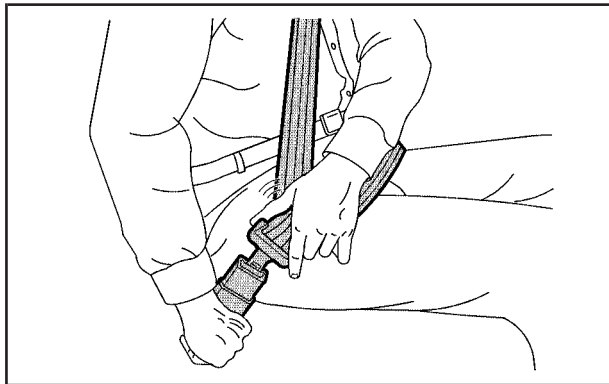

1. Pick up the latch plate and pull the belt across you. Do not let it get twisted.

The shoulder belt may lock if you pull the belt across you very quickly. If this happens, let the belt go back slightly to unlock it. Then pull the belt across you more slowly.

2. Push the latch plate into the buckle until it clicks.

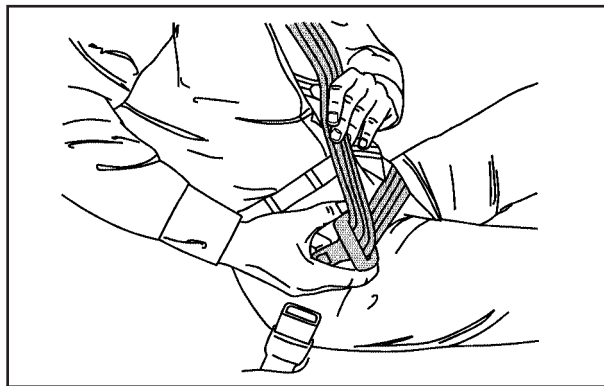

If the belt stops before it reaches the buckle, tilt the latch plate and keep pulling until you can buckle it. Pull up on the latch plate to make sure it is secure.

If the belt is not long enough, see *Safety Belt Extender* on page 1-27.

Make sure the release button on the buckle is positioned so you would be able to unbuckle the safety belt quickly if you ever had to.

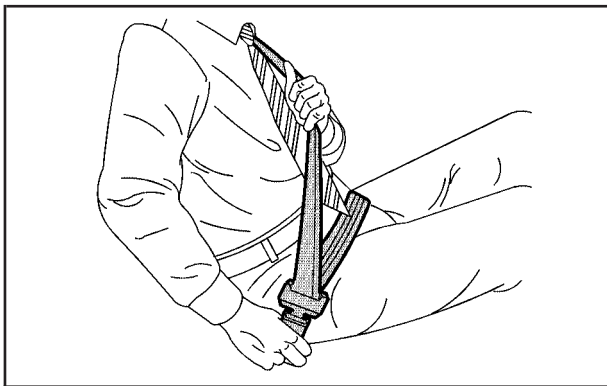

3. To make the lap part tight, pull down on the buckle end of the belt as you pull up on the shoulder part.

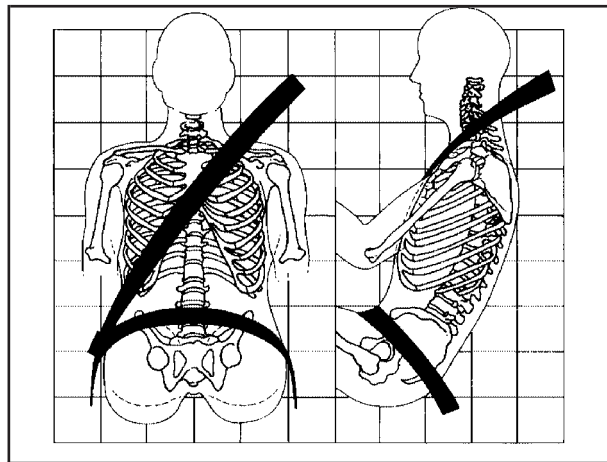

The lap part of the belt should be worn low and snug on the hips, just touching the thighs. In a crash this applies force to the strong pelvic bones. And you would be less likely to slide under the lap belt. If you slid under it, the belt would apply force at your abdomen. This could cause serious or even fatal injuries. The shoulder belt should go over the shoulder and across the chest. These parts of the body are best able to take belt restraining forces.

The safety belt locks if there is a sudden stop or a crash, or if you pull the belt very quickly out of the retractor.

**⚠ CAUTION:**

**You can be seriously hurt if your shoulder belt is too loose. In a crash, you would move forward too much, which could increase injury. The shoulder belt should fit against your body.**

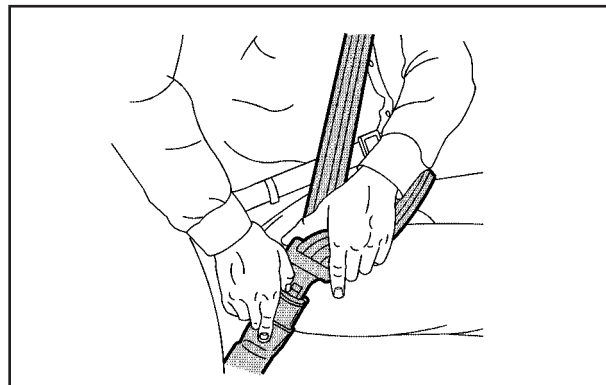

To unlatch the belt, just push the button on the buckle.

## Rear Safety Belt Comfort Guides for Children and Small Adults

Rear shoulder belt comfort guides provide added safety belt comfort for older children who have outgrown booster seats and for small adults. When installed on a shoulder belt, the comfort guide better positions the belt away from the neck and head.

There is one guide for each outside passenger position in the rear seat. To provide added safety belt comfort for children who have outgrown child restraints and booster seats and for smaller adults, the comfort guides may be installed on the shoulder belts. Here is how to install a comfort guide and use the safety belt:

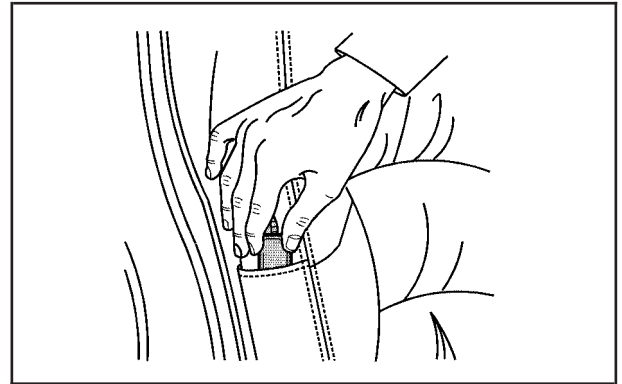

1. Remove the guide from its storage pocket on the side of the seatback.

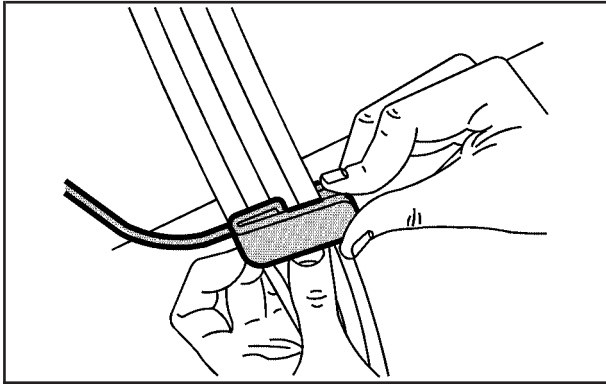

2. Slide the guide under and past the belt. The elastic cord must be under the belt. Then, place the guide over the belt, and insert the two edges of the belt into the slots of the guide.

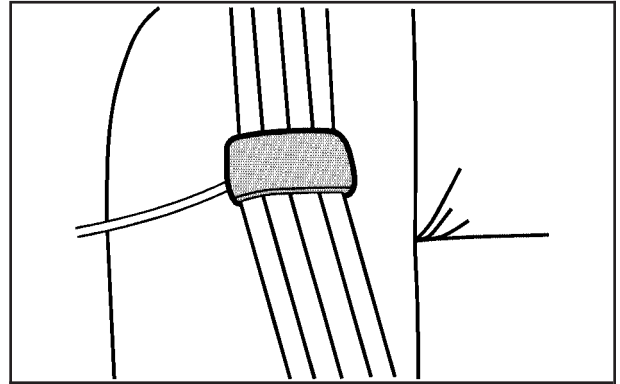

3. Be sure that the belt is not twisted and it lies flat. The elastic cord must be under the belt and the guide on top.



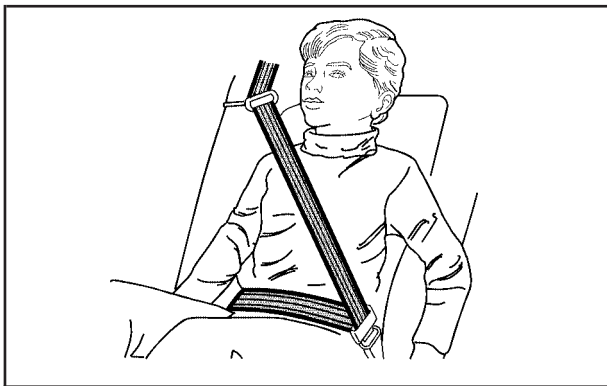

## Safety Belt Extender

If the vehicle's safety belt will fasten around you, you should use it.

But if a safety belt is not long enough, your dealer will order you an extender. It is free. When you go in to order it, take the heaviest coat you will wear, so the extender will be long enough for you. To help avoid personal injury, do not let someone else use it, and use it only for the seat it is made to fit. The extender has been designed for adults. Never use it for securing child seats. To wear it, just attach it to the regular safety belt. For more information, see the instruction sheet that comes with the extender.

4. Buckle, position and release the safety belt as described in *Rear Seat Passengers* on page 1-21. Make sure that the shoulder belt crosses the shoulder.

To remove and store the comfort guides, squeeze the belt edges together so that you can take them out of the guides. Slide the guide into its storage pocket on the side of the seatback.

# Child Restraints

## Older Children

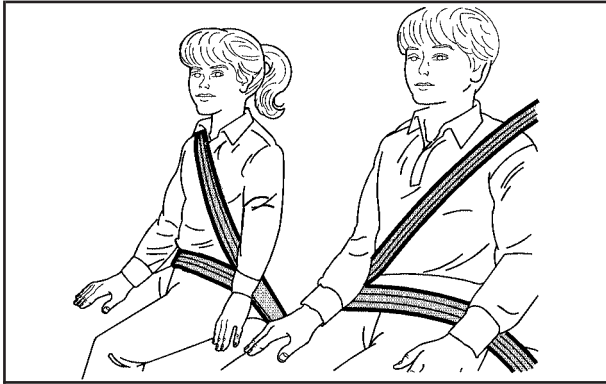

Older children who have outgrown booster seats should wear the vehicle's safety belts.

**Q:** What is the proper way to wear safety belts?

**A:** If possible, an older child should wear a lap-shoulder belt and get the additional restraint a shoulder belt can provide. The shoulder belt should not cross the face or neck. The lap belt should fit snugly below the hips, just touching the top of the thighs. It should never be worn over the abdomen, which could cause severe or even fatal internal injuries in a crash.

Accident statistics show that children are safer if they are restrained in the rear seat.

In a crash, children who are not buckled up can strike other people who are buckled up, or can be thrown out of the vehicle. Older children need to use safety belts properly.

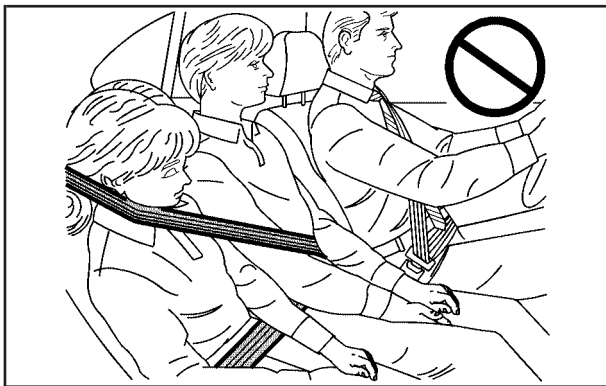

**Q:** What if a child is wearing a lap-shoulder belt, but the child is so small that the shoulder belt is very close to the child's face or neck?

**A:** If the child is sitting in a seat next to a window, move the child toward the center of the vehicle. If the child is sitting in the center rear seat passenger position, move the child toward the safety belt buckle. In either case, be sure that the shoulder belt still is on the child's shoulder, so that in a crash the child's upper body would have the restraint that belts provide.

**⚠ CAUTION:**

**Never do this.**

**Here two children are wearing the same belt. The belt can not properly spread the impact forces. In a crash, the two children can be crushed together and seriously injured. A belt must be used by only one person at a time.**



## **⚠ CAUTION:**

**Never do this.**

**Here a child is sitting in a seat that has a lap-shoulder belt, but the shoulder part is behind the child. If the child wears the belt in this way, in a crash the child might slide under the belt. The belt's force would then be applied right on the child's abdomen. That could cause serious or fatal injuries.**

Wherever the child sits, the lap portion of the belt should be worn low and snug on the hips, just touching the child's thighs. This applies belt force to the child's pelvic bones in a crash.

## **Infants and Young Children**

Everyone in a vehicle needs protection! This includes infants and all other children. Neither the distance traveled nor the age and size of the traveler changes the need, for everyone, to use safety restraints. In fact, the law in every state in the United States and in every Canadian province says children up to some age must be restrained while in a vehicle.

Every time infants and young children ride in vehicles, they should have the protection provided by appropriate restraints. Young children should not use the vehicle's adult safety belts alone, unless there is no other choice. Instead, they need to use a child restraint.

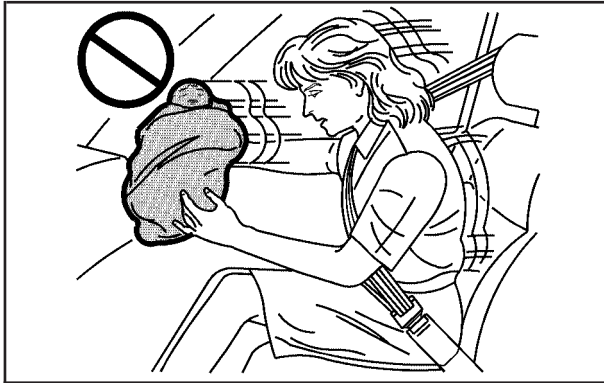

**⚠ CAUTION:**

People should never hold a baby in their arms while riding in a vehicle. A baby does not weigh much — until a crash. During a crash a baby will become so heavy it is not possible to hold it. For example, in a crash at only 25 mph (40 km/h), a 12 lb (5.5 kg) baby will suddenly become a 240 lb (110 kg) force on a person's arms. A baby should be secured in an appropriate restraint.

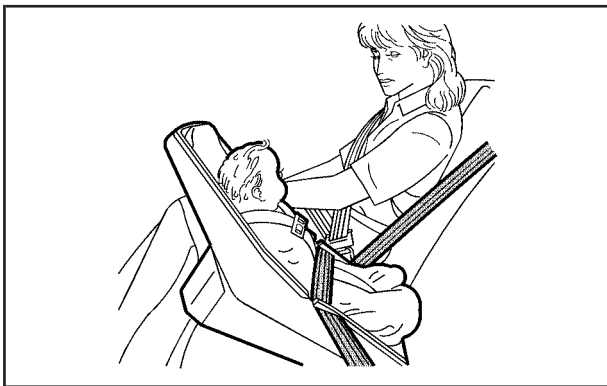

**⚠ CAUTION:**

**Children who are up against, or very close to, any airbag when it inflates can be seriously injured or killed. Airbags plus lap-shoulder belts offer protection for adults and older children, but not for young children and infants. Neither the vehicle's safety belt system nor its airbag system is designed for them. Young children and infants need the protection that a child restraint system can provide.**

**Q: What are the different types of add-on child restraints?**

**A:** Add-on child restraints, which are purchased by the vehicle's owner, are available in four basic types. Selection of a particular restraint should take into consideration not only the child's weight, height and age but also whether or not the restraint will be compatible with the motor vehicle in which it will be used.

For most basic types of child restraints, there are many different models available. When purchasing a child restraint, be sure it is designed to be used in a motor vehicle. If it is, the restraint will have a label saying that it meets federal motor vehicle safety standards.

The restraint manufacturer's instructions that come with the restraint state the weight and height limitations for a particular child restraint. In addition, there are many kinds of restraints available for children with special needs.

 **CAUTION:**

Newborn infants need complete support, including support for the head and neck. This is necessary because a newborn infant's neck is weak and its head weighs so much compared with the rest of its body. In a crash, an infant in a rear-facing seat settles into the restraint, so the crash forces can be distributed across the strongest part of an infant's body, the back and shoulders. Infants always should be secured in appropriate infant restraints.

 **CAUTION:**

The body structure of a young child is quite unlike that of an adult or older child, for whom the safety belts are designed. A young child's hip bones are still so small that the vehicle's regular safety belt may not remain low on the hip bones, as it should. Instead, it may settle up around the child's abdomen. In a crash, the belt would apply force on a body area that is unprotected by any bony structure. This alone could cause serious or fatal injuries. Young children always should be secured in appropriate child restraints.

## Child Restraint Systems

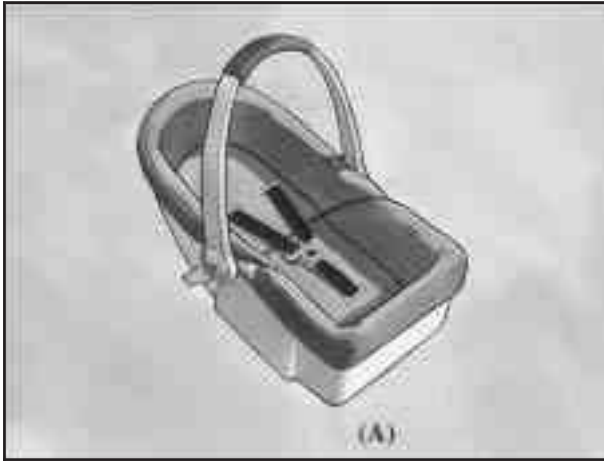

An infant car bed (A), a special bed made for use in a motor vehicle, is an infant restraint system designed to restrain or position a child on a continuous flat surface. Make sure that the infant's head rests toward the center of the vehicle.

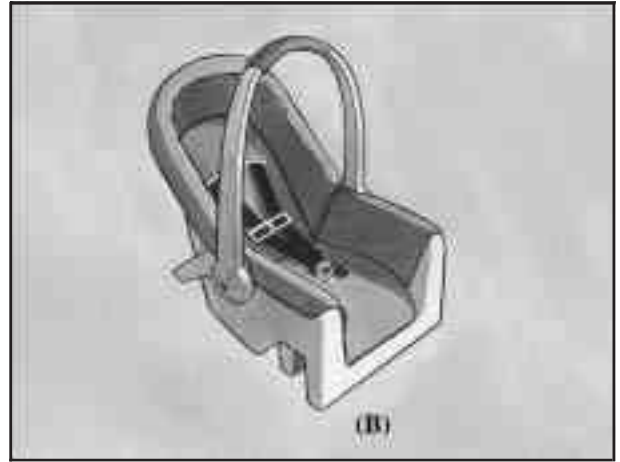

A rear-facing infant seat (B) provides restraint with the seating surface against the back of the infant. The harness system holds the infant in place and, in a crash, acts to keep the infant positioned in the restraint.



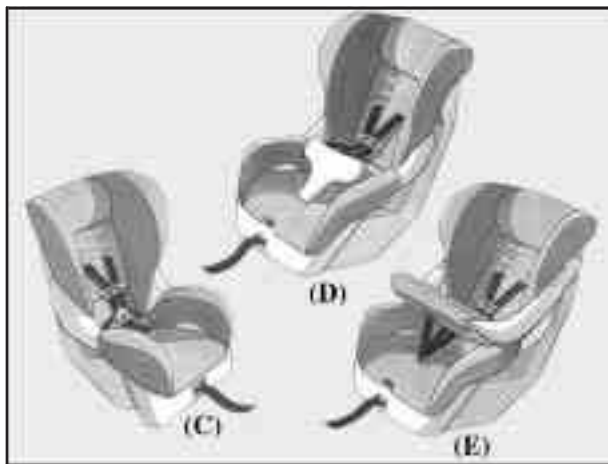

A forward-facing child seat (C-E) provides restraint for the child's body with the harness and also sometimes with surfaces such as T-shaped or shelf-like shields.

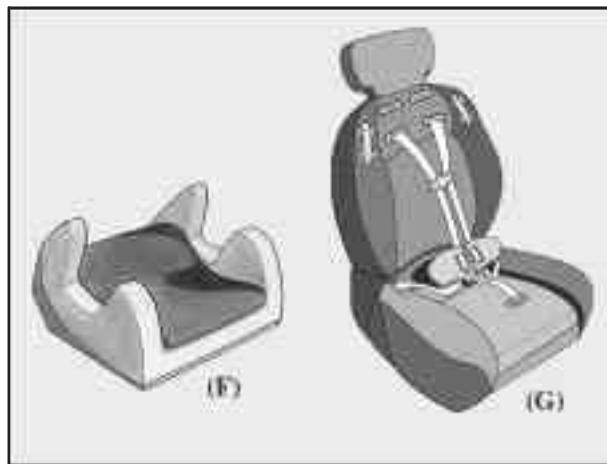

A booster seat (F-G) is a child restraint designed to improve the fit of the vehicle's safety belt system. Some booster seats have a shoulder belt positioner, and some high-back booster seats have a five-point harness. A booster seat can also help a child to see out the window.

**Q: How do child restraints work?**

**A:** A child restraint system is any device designed for use in a motor vehicle to restrain, seat, or position children. A built-in child restraint system is a permanent part of the motor vehicle. An add-on child restraint system is a portable one, which is purchased by the vehicle's owner.

For many years, add-on child restraints have used the adult belt system in the vehicle. To help reduce the chance of injury, the child also has to be secured within the restraint. The vehicle's belt system secures the add-on child restraint in the vehicle, and the add-on child restraint's harness system holds the child in place within the restraint.

One system, the three-point harness, has straps that come down over each of the infant's shoulders and buckle together at the crotch. The five-point harness system has two shoulder straps, two hip straps and a crotch strap. A shield may take the place of hip straps. A T-shaped shield has shoulder straps that are attached to a flat pad which rests low against the child's body. A shelf- or armrest-type shield has straps that are attached to a wide, shelf-like shield that swings up or to the side.

When choosing a child restraint, be sure the child restraint is designed to be used in a vehicle. If it is, it will have a label saying that it meets federal motor vehicle safety standards.

Then follow the instructions for the restraint. You may find these instructions on the restraint itself or in a booklet, or both. These restraints use the belt system or the LATCH system in your vehicle, but the child also has to be secured within the restraint to help reduce the chance of personal injury. When securing an add-on child restraint, refer to the instructions that come with the restraint which may be on the restraint itself or in a booklet, or both, and to this manual. The child restraint instructions are important, so if they are not available, obtain a replacement copy from the manufacturer.

## Where to Put the Restraint

Accident statistics show that children are safer if they are restrained in the rear rather than the front seat. We, therefore, recommend that child restraints be secured in a rear seat, including an infant riding in a rear-facing infant seat, a child riding in a forward-facing child seat and an older child riding in a booster seat. *Never* put a rear-facing child restraint in the front passenger seat. Here is why:

### CAUTION:

**A child in a rear-facing child restraint can be seriously injured or killed if the right front passenger's airbag inflates. This is because the back of the rear-facing child restraint would be very close to the inflating airbag. Always secure a rear-facing child restraint in a rear seat.**

**If you need to secure a forward-facing child restraint in the right front seat, always move the front passenger seat as far back as it will go. It is better to secure the child restraint in a rear seat.**

### CAUTION:

**A child in a child restraint in the center front seat can be badly injured or killed by the right front passenger's airbag if it inflates. Never secure a child restraint in the center front seat. It is always better to secure a child restraint in the rear seat.**

**If you need to secure a forward-facing child restraint in the right front passenger seat, always move the front passenger seat as far back as it will go. It is better to secure the child restraint in a rear seat.**

Wherever you install it, be sure to secure the child restraint properly.

Keep in mind that an unsecured child restraint can move around in a collision or sudden stop and injure people in the vehicle. Be sure to properly secure any child restraint in your vehicle — even when no child is in it.

## Top Strap

Some child restraints have a top strap, or “top tether.” It can help restrain the child restraint during a collision. For it to work, a top strap must be properly anchored to the vehicle. Some top strap-equipped child restraints are designed for use with or without the top strap being anchored. Others require the top strap always to be anchored. Be sure to read and follow the instructions for your child restraint. If yours requires that the top strap be anchored, do not use the restraint unless it is anchored properly.

If the child restraint does not have a top strap, one can be obtained, in kit form, for many child restraints. Ask the child restraint manufacturer whether or not a kit is available.

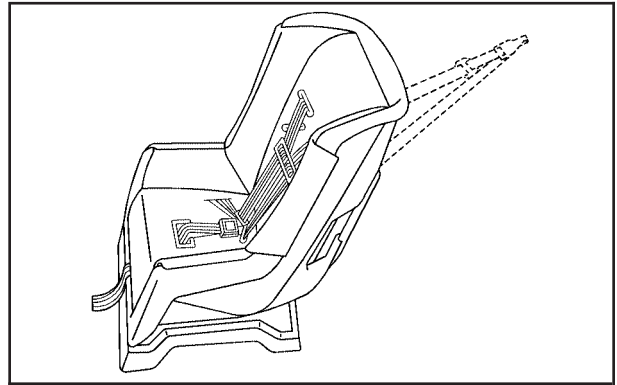

In Canada, the law requires that forward-facing child restraints have a top strap, and that the strap be anchored. In the United States, some child restraints also have a top strap. If your child restraint has a top strap, it should be anchored.

Anchor the top strap to an anchor point specified in *Top Strap Anchor Location on page 1-39*. Be sure to use an anchor point located on the same side of the vehicle as the seating position where the child restraint will be placed.

**⚠ CAUTION:**

**Each top tether bracket is designed to anchor only one child restraint. Attaching more than one child restraint to a single bracket could cause the anchor to come loose or even break during a crash. A child or others could be injured if this happens. To help prevent injury to people and damage to your vehicle, attach only one child restraint per bracket.**

Once you have the top strap anchored, you will be ready to secure the child restraint itself. Tighten the top strap when and as the child restraint manufacturer's instructions say.

## Top Strap Anchor Location

Your vehicle has top strap anchors already installed for the rear seating positions. You will find them behind the rear seat on the filler panel.

Do not secure a child restraint with a top strap in the right front passenger's position if a national or local law requires that the top strap be anchored, or if the instructions that come with the child restraint say that the top strap must be anchored. There is no place to anchor the top strap in this position.

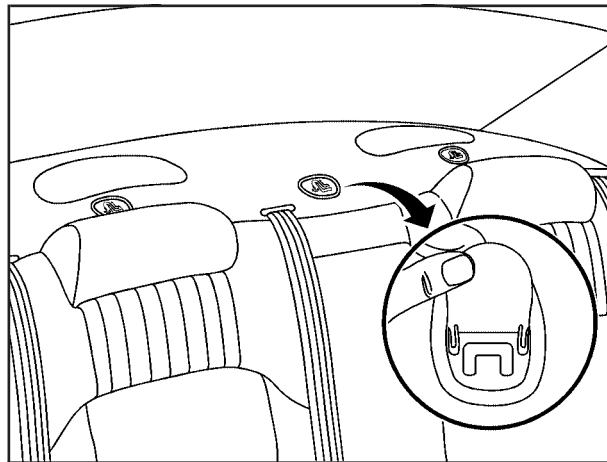

In order to get to a bracket, you will have to open the trim cover.

## Lower Anchorages and Top Tethers for Children (LATCH System)

Your vehicle has the LATCH system. You will find anchors for all three rear seating positions.

This system, designed to make installation of child restraints easier, does not use the vehicle's safety belts. Instead, it uses vehicle anchors and child restraint attachments to secure the restraints. Some restraints also use another vehicle anchor to secure a top tether strap.

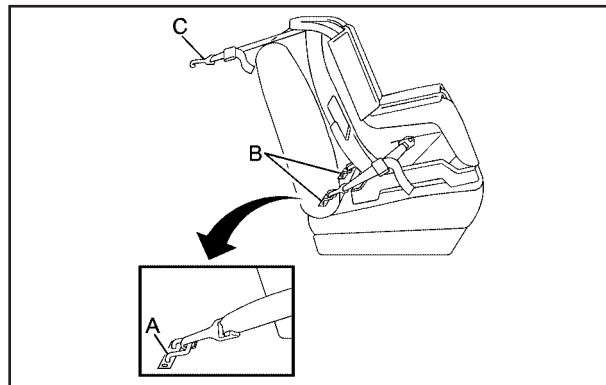

- A. Lower Anchorage
- B. Lower Anchorage
- C. Top Tether

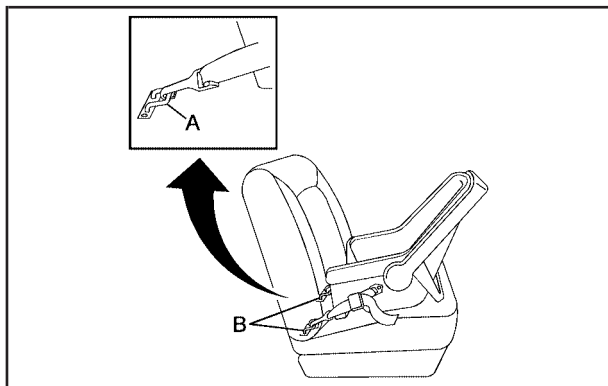

A. Lower Anchorage

B. Lower Anchorage

In order to use the LATCH system in your vehicle, you need a child restraint designed for that system.

To assist you in locating the lower anchors for this child restraint system, each seating position with the LATCH system has a label on the seatback at each lower anchor position.



The labels are located near the base of all three rear seating positions.

### CAUTION:

If a LATCH-type child restraint is not attached to its anchorage points, the restraint will not be able to protect the child correctly. In a crash, the child could be seriously injured or killed. Make sure that a LATCH-type child restraint is properly installed using the anchorage points, or use the vehicle's safety belts to secure the restraint, following the instructions that came with that restraint, and also the instructions in this manual.

## Securing a Child Restraint Designed for the LATCH System

1. Find the LATCH anchorages for the seating position you want to use, where the bottom of the seatback meets the back of the seat cushion. See *Lower Anchorages and Top Tethers for Children (LATCH System)* on page 1-40.
2. Put the child restraint on the seat.
3. Attach and tighten the LATCH attachments on the child restraint to the LATCH anchorages in the vehicle. The child restraint instructions will show you how.
4. If the child restraint is forward-facing, attach and tighten the top tether to the top tether anchorage. The child restraint instructions will show you how. Also see *Top Strap on page 1-38*.
5. Push and pull the child restraint in different directions to be sure it is secure.

To remove the child restraint, simply unhook the top tether from the top tether anchorage and then disconnect the LATCH attachments from the LATCH anchorages.

## Securing a Child Restraint in a Rear Seat Position

If your child restraint is equipped with the LATCH system, see *Lower Anchorages and Top Tethers for Children (LATCH System)* on page 1-40. See *Top Strap on page 1-38* if the child restraint has one.

If your child restraint does not have the LATCH system, you will be using the lap-shoulder belt to secure the child restraint in this position. Be sure to follow the instructions that came with the child restraint. Secure the child in the child restraint when and as the instructions say.

1. Put the child restraint on the seat.
2. Pick up the latch plate, and run the lap and shoulder portions of the vehicle's safety belt through or around the restraint. The child restraint instructions will show you how.



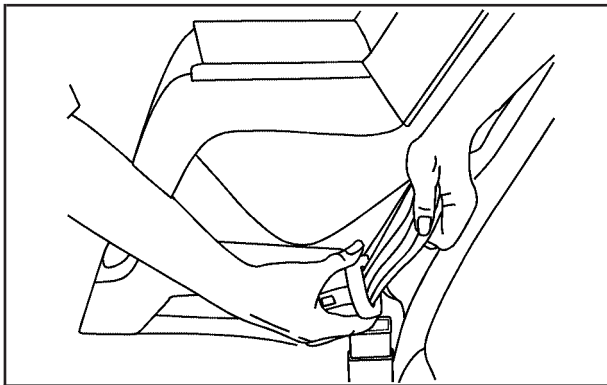

Tilt the latch plate to adjust the belt if needed.

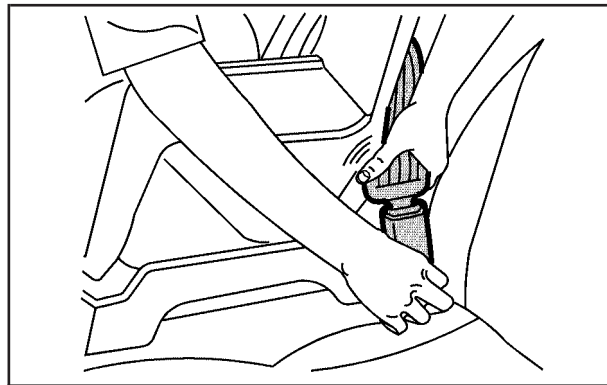

3. Buckle the belt. Make sure the release button is positioned so you would be able to unbuckle the safety belt quickly if you ever had to.

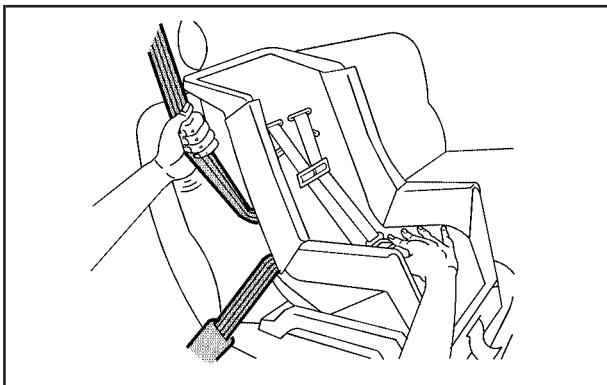

## Securing a Child Restraint in the Center Front Seat Position

### CAUTION:

A child in a child restraint in the center front seat can be badly injured or killed by the right front passenger's airbag if it inflates. Never secure a child restraint in the center front seat. It is always better to secure a child restraint in the rear seat.

If you need to secure a forward-facing child restraint in the right front passenger seat, always move the front passenger seat as far back as it will go. It is better to secure the child restraint in a rear seat.

Do not secure a child restraint in the center front seat position.

4. To tighten the belt, push down on the child restraint, pull the shoulder portion of the belt to tighten the lap portion of the belt and feed the shoulder belt back into the retractor. If you are using a forward-facing child restraint, you may find it helpful to use your knee to push down on the child restraint as you tighten the belt.
5. Push and pull the child restraint in different directions to be sure it is secure.

To remove the child restraint, just unbuckle the vehicle's safety belt and let it go back all the way. The safety belt will move freely again and be ready to work for an adult or larger child passenger.

## Securing a Child Restraint in the Right Front Seat Position

If your vehicle is equipped with the LATCH system, see *Lower Anchorages and Top Tethers for Children (LATCH System)* on page 1-40. See *Top Strap* on page 1-38 if the child restraint has one.

There is no top strap anchor in the right front passenger's position. Do not secure a child seat in this position if a national or local law requires that the top strap be anchored, or if the instructions that come with the child restraint say that the top strap must be anchored.

Your vehicle has a right front passenger airbag. *Never* put a rear facing child restraint in this seat. Here is why:

### CAUTION:

**A child in a rear-facing child restraint can be seriously injured or killed if the right front passenger's airbag inflates. This is because the back of the rear-facing child restraint would be very close to the inflating airbag. Always secure a rear-facing child restraint in a rear seat.**

A rear seat is a safer place to secure a forward-facing child restraint. If you need to secure a forward-facing child restraint in the right front seat, you will be using the lap-shoulder belt to secure the child restraint in this position. Be sure to follow the instructions that came with the child restraint. Secure the child in the child restraint when and as the instructions say.

1. Because your vehicle has a right front passenger airbag, always move the seat as far back as it will go before securing a forward-facing child restraint. See *Power Seats* on page 1-2 or *Manual Seats* on page 1-2.
2. Put the child restraint on the seat.
3. Pick up the latch plate, and run the lap and shoulder portions of the vehicle's safety belt through or around the restraint. The child restraint instructions will show you how.

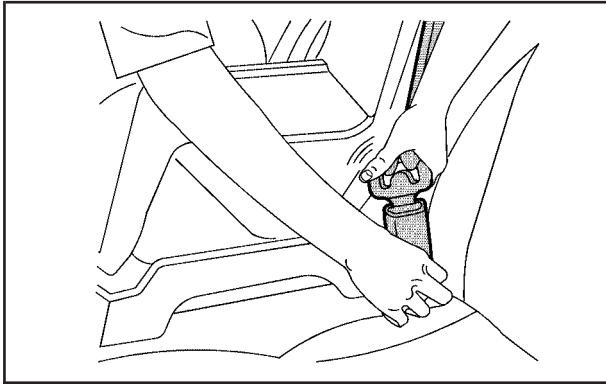

4. Buckle the belt. Make sure the release button is positioned so you would be able to unbuckle the safety belt quickly if you ever had to.

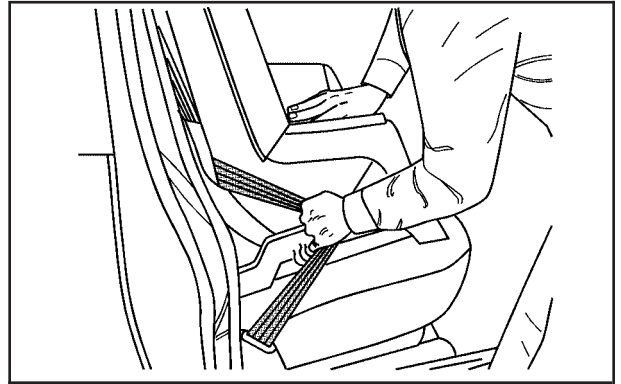

5. Pull the rest of the lap belt all the way out of the retractor to set the lock.

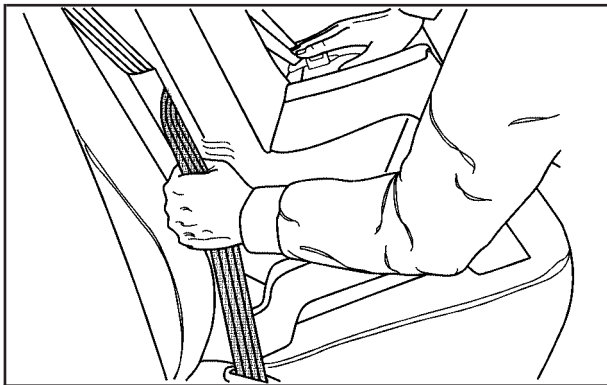

6. To tighten the belt, feed the lap belt back into the retractor while you push down on the child restraint. You may find it helpful to use your knee to push down on the child restraint as you tighten the belt.
7. Push and pull the child restraint in different directions to be sure it is secure.

To remove the child restraint, just unbuckle the vehicle's safety belt and let it go back all the way. The safety belt will move freely again and be ready to work for an adult or larger child passenger.

## Airbag System

Your vehicle has a frontal airbag for the driver and a frontal airbag for the right front passenger. Your vehicle may also have a side impact airbag for the driver, and another side impact airbag for the right front passenger.

If your vehicle has a side impact airbag for the driver and/or right front passenger, the words AIR BAG will appear on the airbag covering on the side of the seatback closest to the door.

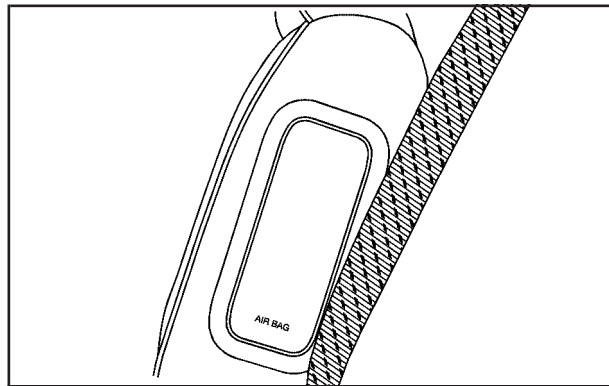

Frontal airbags are designed to help reduce the risk of injury from the force of an inflating frontal airbag. But these airbags must inflate very quickly to do their job and comply with federal regulations.

Here are the most important things to know about the airbag system:

 **CAUTION:**

**You can be severely injured or killed in a crash if you are not wearing your safety belt — even if you have airbags. Wearing your safety belt during a crash helps reduce your chance of hitting things inside the vehicle or being ejected from it. Airbags are designed to work with safety belts but do not replace them.**

**Frontal airbags for the driver and right front passenger are designed to deploy only in moderate to severe frontal and near frontal crashes. They are not designed to inflate in rollover, rear or low-speed frontal crashes, or in**

**CAUTION: (Continued)**

**CAUTION: (Continued)**

**many side crashes. And, for some unrestrained occupants, frontal airbags may provide less protection in frontal crashes than more forceful airbags have provided in the past.**

**Side impact airbags for the driver and right front passenger are designed to inflate only in moderate to severe crashes where something hits the side of your vehicle. They are not designed to inflate in frontal, in rollover or in rear crashes.**

**Everyone in your vehicle should wear a safety belt properly — whether or not there is an airbag for that person.**

 **CAUTION:**

Both frontal and side impact airbags inflate with great force, faster than the blink of an eye. If you are too close to an inflating airbag, as you would be if you were leaning forward, it could seriously injure you. Safety belts help keep you in position for airbag inflation before and during a crash. Always wear your safety belt, even with frontal airbags. The driver should sit as far back as possible while still maintaining control of the vehicle. Front occupants should not lean on or sleep against the door.

 **CAUTION:**

Anyone who is up against, or very close to, any airbag when it inflates can be seriously injured or killed. Airbags plus lap-shoulder belts offer the best protection for adults, but not for young children and infants. Neither the vehicle's safety belt system nor its airbag system is designed for them. Young children and infants need the protection that a child restraint system can provide. Always secure children properly in your vehicle. To read how, see *Older Children on page 1-28* or *Infants and Young Children on page 1-30*.

**AIR  
BAG**

There is an airbag readiness light on the instrument panel, which shows AIR BAG.

The system checks the airbag electrical system for malfunctions. The light tells you if there is an electrical problem. See *Airbag Readiness Light on page 3-38*.

## Where Are the Airbags?



The driver's frontal airbag is in the middle of the steering wheel.



The right front passenger's frontal airbag is in the instrument panel on the passenger's side.

If your vehicle has a driver's side impact airbag, it is located in the side of the driver's seatback closest to the door.





If your vehicle has a right front passenger's side impact airbag, it is located in the side of the passenger's seatback closest to the door.

**⚠ CAUTION:**

If something is between an occupant and an airbag, the airbag might not inflate properly or it might force the object into that person causing severe injury or even death. The path of an inflating airbag must be kept clear. Do not put anything between an occupant and an airbag, and do not attach or put anything on the steering wheel hub or on or near any other airbag covering. Do not let seat covers block the inflation path of a side impact airbag.

## When Should an Airbag Inflate?

The driver's and right front passenger's frontal airbags are designed to inflate in moderate to severe frontal or near-frontal crashes. But they are designed to inflate only if the impact exceeds a predetermined deployment threshold. Deployment thresholds take into account a variety of desired deployment and non-deployment events and are used to predict how severe a crash is likely to be in time for the airbags to inflate and help restrain the occupants. Whether your frontal airbags will or should deploy is not based on how fast your vehicle is traveling. It depends largely on what you hit, the direction of the impact and how quickly your vehicle slows down.

In addition, your vehicle has “dual stage” frontal airbags, which adjust the restraint according to crash severity. Your vehicle is equipped with electronic frontal sensors, which help the sensing system distinguish between a moderate frontal impact and a more severe frontal impact. For moderate frontal impacts, these airbags inflate at a level less than full deployment. For more severe frontal impacts, full deployment occurs. If the front of your vehicle goes straight into a wall that does not move or deform, the threshold level for the reduced deployment is about 10 to 16 mph (18 to 26 km/h), and the threshold level for a full deployment is about 18 to 24 mph (29 to 38.5 km/h). (The threshold level can vary, however, with specific vehicle design, so that it can be somewhat above or below this range.)

Airbags may inflate at different crash speeds. For example:

- If the vehicle hits a stationary object, the airbag could inflate at a different crash speed than if the object were moving.
- If the object deforms, the airbag could inflate at a different crash speed than if the object does not deform.
- If the vehicle hits a narrow object (like a pole) the airbag could inflate at a different crash speed than if the vehicle hits a wide object (like a wall).
- If the vehicle goes into an object at an angle the airbag could inflate at a different crash speed than if the vehicle goes straight into the object.

The frontal airbags (driver and right front passenger) are not intended to inflate during vehicle rollovers, rear impacts, or in many side impacts because inflation would not likely help the occupants.

Your vehicle may or may not have a side impact airbag. See *Airbag System on page 1-47*. Side impact airbags are designed to inflate in moderate to severe side crashes. A side impact airbag will inflate if the crash severity is above the system's designed “threshold level.” The threshold level can vary with specific vehicle design. Side impact airbags are not designed to inflate in frontal or near-frontal impacts, rollovers or

rear impacts, because inflation would not likely help the occupant. A side impact airbag will only deploy on the side of the vehicle that is struck.

In any particular crash, no one can say whether an airbag should have inflated simply because of the damage to a vehicle or because of what the repair costs were. For frontal airbags, inflation is determined by the angle of the impact and how quickly the vehicle slows down in frontal and near-frontal impacts. For side impact airbags, inflation is determined by the location and severity of the impact.

## **What Makes an Airbag Inflate?**

In an impact of sufficient severity, the airbag sensing system detects that the vehicle is in a crash. For both frontal and side impact airbags, the sensing system triggers a release of gas from the inflator, which inflates the airbag. The inflator, the airbag and related hardware are all part of the airbag modules. Frontal airbag modules are located inside the steering wheel and instrument panel. For vehicles with side impact airbags, the airbag modules are located in the seatback closest to the driver's and/or right front passenger's door.

## **How Does an Airbag Restrain?**

In moderate to severe frontal or near frontal collisions, even belted occupants can contact the steering wheel or the instrument panel. In moderate to severe side collisions, even belted occupants can contact the inside of the vehicle. The airbag supplements the protection provided by safety belts. Airbags distribute the force of the impact more evenly over the occupant's upper body, stopping the occupant more gradually. But the frontal airbags would not help you in many types of collisions, including rollovers, rear impacts, and many side impacts, primarily because an occupant's motion is not toward the airbag. Side impact airbags would not help you in many types of collisions, including frontal or near frontal collisions, rollovers, and rear impacts, primarily because an occupant's motion is not toward those airbags. Airbags should never be regarded as anything more than a supplement to safety belts, and then only in moderate to severe frontal or near-frontal collisions for the driver's and right front passenger's frontal airbags, and only in moderate to severe side collisions for vehicles with a driver's and right front passenger's side impact airbag.

## What Will You See After an Airbag Inflates?

After the airbag inflates, it quickly deflates, so quickly that some people may not even realize the airbag inflated. Some components of the airbag module will be hot for a short time. These components include the steering wheel hub for the driver's frontal airbag and the instrument panel for the right front passenger's frontal airbag. For vehicles with side impact airbags, the side of the seatback closest to the driver's and/or right front passenger's door will be hot. The parts of the bag that come into contact with you may be warm, but not too hot to touch. There will be some smoke and dust coming from the vents in the deflated airbags. Airbag inflation does not prevent the driver from seeing or being able to steer the vehicle, nor does it stop people from leaving the vehicle.

### CAUTION:

**When an airbag inflates, there is dust in the air. This dust could cause breathing problems for people with a history of asthma or other breathing trouble. To avoid this, everyone in the vehicle should get out as soon as it is safe to do so. If you have breathing problems but can not get out of the vehicle after an airbag inflates, then get fresh air by opening a window or a door. If you experience breathing problems following an airbag deployment, you should seek medical attention.**

Your vehicle has a feature that will automatically unlock the doors and turn the interior lamps on when the airbags inflate (if battery power is available). You can lock the doors again and turn the interior lamps off by using the door lock and interior lamp controls.

In many crashes severe enough to inflate an airbag, windshields are broken by vehicle deformation. Additional windshield breakage may also occur from the right front passenger airbag.

- Airbags are designed to inflate only once. After an airbag inflates, you will need some new parts for your airbag system. If you do not get them, the airbag system will not be there to help protect you in another crash. A new system will include airbag modules and possibly other parts. The service manual for your vehicle covers the need to replace other parts.
- Your vehicle is equipped with a crash sensing and diagnostic module which records information after a crash. See *Vehicle Data Collection and Event Data Recorders* on page 7-9.

- Let only qualified technicians work on your airbag system. Improper service can mean that an airbag system will not work properly. See your dealer for service.

**Notice:** If you damage the covering for the driver's or the right front passenger's airbag, or the airbag covering on the driver's and right front passenger's seatback, the airbag may not work properly. You may have to replace the airbag module in the steering wheel, both the airbag module and the instrument panel for the right front passenger's airbag, or both the airbag module and seatback for the driver's and right front passenger's side impact airbag. Do not open or break the airbag coverings.

## Servicing Your Airbag-Equipped Vehicle

Airbags affect how your vehicle should be serviced. There are parts of the airbag system in several places around your vehicle. Your dealer and the service manual have information about servicing your vehicle and the airbag system. To purchase a service manual, see *Service Publications Ordering Information on page 7-11*.

### CAUTION:

**For up to 10 seconds after the ignition key is turned off and the battery is disconnected, an airbag can still inflate during improper service. You can be injured if you are close to an airbag when it inflates. Avoid yellow connectors. They are probably part of the airbag system. Be sure to follow proper service procedures, and make sure the person performing work for you is qualified to do so.**

The airbag system does not need regular maintenance.

## Restraint System Check

### Checking Your Restraint Systems

Now and then, make sure the safety belt reminder light and all your belts, buckles, latch plates, retractors and anchorages are working properly. Look for any other loose or damaged safety belt system parts. If you see anything that might keep a safety belt system from doing its job, have it repaired.

Torn or frayed safety belts may not protect you in a crash. They can rip apart under impact forces. If a belt is torn or frayed, get a new one right away.

Also look for any opened or broken airbag covers, and have them repaired or replaced. (The airbag system does not need regular maintenance.)

## Replacing Restraint System Parts After a Crash

### CAUTION:

**A crash can damage the restraint systems in your vehicle. A damaged restraint system may not properly protect the person using it, resulting in serious injury or even death in a crash. To help make sure your restraint systems are working properly after a crash, have them inspected and any necessary replacements made as soon as possible.**

If you have had a crash, do you need new belts or LATCH system parts?

After a very minor collision, nothing may be necessary. But if the belts were stretched, as they would be if worn during a more severe crash, then you need new parts.

If the LATCH system was being used during a more severe crash, you may need new LATCH system parts.

If belts are cut or damaged, replace them. Collision damage also may mean you will need to have LATCH system, safety belt or seat parts repaired or replaced. New parts and repairs may be necessary even if the belt or LATCH system was not being used at the time of the collision.

If your seat adjuster will not work after a crash, the special part of the safety belt that goes through the seat to the adjuster may need to be replaced.

If an airbag inflates, you will need to replace airbag system parts. See the part about the airbag system earlier in this manual.

 **NOTES**

---

---

---

---

---

---

---

---

---

---

---

---

---

---

---

---

---

---

---

---

---

---

---

---



## Section 2 Features and Controls

---

<b>Keys</b> .....	2-2	Parking Brake .....	2-30
Remote Keyless Entry System .....	2-4	Shifting Into Park (P) .....	2-31
Remote Keyless Entry System Operation .....	2-5	Shifting Out of Park (P) .....	2-33
<b>Doors and Locks</b> .....	2-9	Parking Over Things That Burn .....	2-34
Door Locks .....	2-9	Engine Exhaust .....	2-34
Central Door Unlocking System .....	2-10	Running Your Engine While You Are Parked .....	2-35
Power Door Locks .....	2-10	<b>Mirrors</b> .....	2-36
Delayed Locking .....	2-11	Manual Rearview Mirror .....	2-36
Programmable Automatic Door Locks .....	2-12	Automatic Dimming Rearview Mirror .....	2-36
Rear Door Security Locks .....	2-14	Outside Power Mirrors .....	2-37
Lockout Protection .....	2-14	Outside Curb View Assist Mirror .....	2-38
Trunk .....	2-15	Outside Convex Mirror .....	2-38
<b>Windows</b> .....	2-17	Outside Heated Mirrors .....	2-38
Power Windows .....	2-18	<b>OnStar® System</b> .....	2-39
Sun Visors .....	2-19	<b>HomeLink® Transmitter</b> .....	2-40
<b>Theft-Deterrent Systems</b> .....	2-19	Programming the HomeLink® Transmitter .....	2-41
Universal Theft-Deterrent .....	2-19	<b>Storage Areas</b> .....	2-44
Content Theft-Deterrent .....	2-21	Glove Box .....	2-44
PASS-Key® III .....	2-21	Front Storage Area .....	2-45
PASS-Key® III Operation .....	2-22	Center Console Storage Area .....	2-45
<b>Starting and Operating Your Vehicle</b> .....	2-23	Rear Seat Pass Through .....	2-45
New Vehicle Break-In .....	2-23	Convenience Net .....	2-45
Ignition Positions .....	2-24	<b>Sunroof</b> .....	2-45
Retained Accessory Power (RAP) .....	2-24	<b>Vehicle Personalization</b> .....	2-46
Starting Your Engine .....	2-25	Memory Seat and Mirrors .....	2-46
Engine Coolant Heater .....	2-26		
Automatic Transaxle Operation .....	2-27		

## Keys

### CAUTION:

Leaving children in a vehicle with the ignition key is dangerous for many reasons. They could operate the power windows or other controls or even make the vehicle move. The children or others could be badly injured or even killed. Do not leave the keys in a vehicle with children.



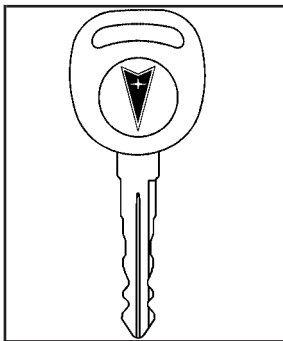

There is a master key that works in all of the lock cylinders; driver's door, trunk, ignition, and glove box.

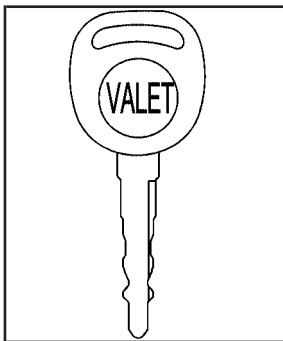

There may also be a VALET key which only operates the driver's door and the ignition.

Your vehicle has the PASS-Key<sup>®</sup> III vehicle theft system. Both the master and VALET key, if equipped, have a transponder in the key head that matches a decoder in the vehicle's instrument panel. If a replacement key or any additional key is needed, you must purchase this key from your dealer. The key will have PK3 stamped on it. Keep the bar code tag that came with the original keys. Give this tag to your dealer if you need a new key made.

Any new PASS-Key<sup>®</sup> III key must be programmed before it will start your vehicle. See *PASS-Key<sup>®</sup> III Operation* on page 2-22 for more information on programming your new key.

If your vehicle is equipped with the OnStar<sup>®</sup> System with an active subscription and you lock your keys inside the vehicle, OnStar<sup>®</sup> may be able to send a command to unlock your vehicle. See *OnStar<sup>®</sup> System* on page 2-39 for more information.

**Notice:** If you ever lock your keys in your vehicle, you may have to damage the vehicle to get in. Be sure you have spare keys.

## Remote Keyless Entry System

If equipped, the keyless entry system operates on a radio frequency subject to Federal Communications Commission (FCC) Rules and with Industry Canada.

This device complies with Part 15 of the FCC Rules. Operation is subject to the following two conditions:

1. This device may not cause interference.
2. This device must accept any interference received, including interference that may cause undesired operation of the device.

This device complies with RSS-210 of Industry Canada. Operation is subject to the following two conditions:

1. This device may not cause interference.
2. This device must accept any interference received, including interference that may cause undesired operation of the device.

Changes or modifications to this system by other than an authorized service facility could void authorization to use this equipment.

At times you may notice a decrease in range. This is normal for any remote keyless entry system. If the transmitter does not work or if you have to stand closer to your vehicle for the transmitter to work, try this:

- Check the distance. You may be too far from your vehicle. You may need to stand closer during rainy or snowy weather.
- Check the location. Other vehicles or objects may be blocking the signal. Take a few steps to the left or right, hold the transmitter higher, and try again.
- Check to determine if battery replacement is necessary. See "Battery Replacement" under *Remote Keyless Entry System Operation on page 2-5*.
- If you are still having trouble, see your dealer or a qualified technician for service.

## Remote Keyless Entry System Operation

If your vehicle has this feature, you can lock and unlock your doors or unlock your trunk from about 3 feet (1 m) up to 30 feet (9 m) away using the remote keyless entry transmitter supplied with your vehicle.



 **(Unlock):** Press this button to unlock the driver's door. The exterior lamps may also flash twice when this button is pressed.

Press this button again within five seconds to unlock all of the doors and illuminate the interior lamps. See *Entry Lighting on page 3-18* and "Security Feedback" later in this section.

 **(Lock):** Press this button to lock all of the doors. The exterior lamps may also flash once and the horn may chirp. See "Security Feedback" later in this section. Pressing this button may also turn off the interior lamps if illuminated.

 **(Trunk):** Press this button to unlock the trunk when the ignition is in OFF. It will also work when the ignition is on, but only while the transaxle is in PARK (P) or NEUTRAL (N).

 **(Remote Alarm):** Press this button to make the horn sound and the headlamps and taillamps flash for up to 30 seconds. This can be turned off by pressing the remote alarm button again or by turning the ignition to ON. If your vehicle has the Universal Theft-Deterrent feature, you may also turn off the remote alarm by unlocking the vehicle with a key. See *Universal Theft-Deterrent on page 2-19*.

## Personalization Features

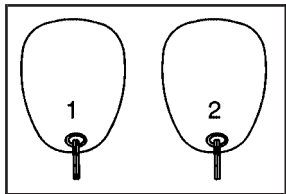

If your vehicle has the Driver Information Center (DIC), the numbers on the back of the transmitters correspond to the DIC's Driver #1 and Driver #2. See *Driver Information Center (DIC)* on page 3-59, for more information.

The following features, if available on your vehicle, can be programmed to each driver's preference.

- Programmable Automatic Door Locks
- Security Feedback
- Delayed Locking
- Perimeter Lighting
- Seat and Mirror Recall

If your vehicle is equipped with the Driver Information Center (DIC), you must program these features through the DIC. See *DIC Vehicle Personalization* on page 3-64.

## Security Feedback

This feature provides feedback to the driver when the vehicle receives a command from the remote keyless entry transmitter. Feedback is only provided if all doors are closed, the ignition is off and the Retained Accessory Power (RAP) is inactive.

If your vehicle is equipped with the Driver Information Center (DIC), you must program this feature through the DIC. See *DIC Vehicle Personalization* on page 3-64.

The following modes may be selected:

**Mode 1:** No feedback when locking or unlocking vehicle.

**Mode 2:** Parking lamps and the daytime running lamps will flash twice when unlocking the vehicle and will flash once when locking the vehicle.

**Mode 3:** Horn will chirp when all doors are unlocked (second unlock button press) and when locking the vehicle.

**Mode 4:** Parking lamps and the daytime running lamps will flash twice each time the button with the unlock symbol is pressed; the horn will chirp when all doors are unlocked. Parking lamps and the exterior lamps will flash once and the horn will chirp when locking the vehicle.

Each remote keyless entry transmitter can be programmed to a different mode according to the user's preference. To change to another mode, do the following:

1. Keep all doors closed, the vehicle in PARK (P) and the ignition on throughout this procedure.
2. Press and hold the driver's power door lock switch in LOCK through Step 4.
3. Press the button with the trunk symbol on the transmitter. The transmitter will remain in its current mode and the horn will chirp as feedback.
4. Press the button with the trunk symbol again. Each time the transmitter's trunk button is pressed, the mode will advance by one, going from Mode 2 to 3 to 4, etc. and the horn will chirp as feedback.
5. Release the power door lock switch. The security feedback will remain in the most recent mode selected.

To verify the mode selected, remove the key from the ignition and close all of the doors after you have exited the vehicle. Press the lock button on the transmitter to be verified and confirm the appropriate feedback. Repeat with the unlock button.

## Matching Transmitter(s) to Your Vehicle

Each remote keyless entry transmitter is coded to prevent another transmitter from unlocking your vehicle. If a transmitter is lost or stolen, a replacement can be purchased through your dealer. Remember to bring any remaining transmitters with you when you go to your dealer. When the dealer matches the replacement transmitter to your vehicle, any remaining transmitters must also be matched. Once your dealer has coded the new transmitter, the lost transmitter will not unlock your vehicle. Each vehicle can have a maximum of four transmitters matched to it.

See your dealer to match additional transmitters to your vehicle.

## Battery Replacement

Under normal use, the battery in your remote keyless entry transmitter should last about four years.

You can tell the battery is weak if the transmitter will not work at the normal range in any location. If you have to get close to your vehicle before the transmitter works, it is probably time to change the battery.

**Notice:** When replacing the battery, use care not to touch any of the circuitry. Static from your body transferred to these surfaces may damage the transmitter.



To replace the battery, do the following:

1. Insert a thin coin, or similar object, into the notch near the key ring. Turn it counterclockwise to separate the two halves of the transmitter.
2. Once the transmitter is separated, use a pencil eraser to remove the old battery. Do not use a metal object.
3. Remove and replace the battery. Replace it as the instructions inside the cover indicate. Use one Duracell® battery, type DL-2032, or a similar type.
4. Snap the transmitter back together tightly to be sure no moisture can enter.
5. Check the operation of the transmitter.



# Doors and Locks

## Door Locks

### CAUTION:

Unlocked doors can be dangerous.

- Passengers — especially children — can easily open the doors and fall out of a moving vehicle. When a door is locked, the handle will not open it. You increase the chance of being thrown out of the vehicle in a crash if the doors are not locked. So, wear safety belts properly and lock the doors whenever you drive.

CAUTION: (Continued)

### CAUTION: (Continued)

- Young children who get into unlocked vehicles may be unable to get out. A child can be overcome by extreme heat and can suffer permanent injuries or even death from heat stroke. Always lock your vehicle whenever you leave it.
- Outsiders can easily enter through an unlocked door when you slow down or stop your vehicle. Locking your doors can help prevent this from happening.

There are several ways to lock and unlock your vehicle.

If your vehicle has a theft-deterrent system and it is activated, unlock the doors only with the key or remote keyless entry system. This will avoid setting off the alarm. See *Universal Theft-Deterrent on page 2-19* for more information.

To unlock the door from the outside, use your door key or remote keyless entry transmitter (if equipped).

Turning the door key toward the rear of the vehicle will unlock the door. Turning the door key toward the front of the vehicle will lock it.



To lock the door from the inside, push the manual door lock forward. To unlock the door, push the manual door lock rearward.

## Central Door Unlocking System

If your vehicle has a theft-deterrent system, all doors will unlock if the key is held in the outside key cylinder unlock position for more than two seconds. The doors will also unlock if the key is turned to the unlock position twice in three seconds.

## Power Door Locks



You can lock or unlock all the doors on your vehicle using the driver's or front passenger's door lock switch.

Press the bottom of the switch to lock all the doors. Press the top of the switch to unlock all doors.

## Delayed Locking

This feature lets the driver delay the actual locking of the vehicle. When the driver's power door lock switch or the remote keyless entry transmitter lock button is pressed, with the key removed from the ignition and the driver's door open, a chime will sound three times to signal that the delayed locking system is active. When all doors have been closed, the doors will lock automatically after five seconds. If any door is opened before this, the five-second timer will reset itself once all the doors have been closed again.

Pressing a power door lock switch or the remote keyless entry transmitter lock button again will override this feature.

## Personalization Programming

The delayed locking feature can be turned on or off.

If your vehicle is equipped with the Driver Information Center (DIC), you must program this feature through the DIC. See *DIC Vehicle Personalization on page 3-64*.

If your vehicle is not equipped with remote keyless entry, the delayed locking feature can be turned on or off by using the following procedure:

1. Keep all doors closed, the vehicle in PARK (P) and the ignition on throughout this procedure.
2. Press and hold the driver's power door lock switch in LOCK through Step 4.
3. Cycle the parking lamp switch from off to on six times. On the sixth cycle, the doors will unlock to confirm that the feature has been turned on. Your doors will remain locked if delayed locking is off. If the doors unlock, delayed locking is on.
4. To change modes, cycle the parking lamp switch once more. A locking action will confirm the new mode.
5. Release the power door lock switch.

To turn the feature off, repeat the previous procedure.

If your vehicle is equipped with remote keyless entry, your vehicle can be programmed to each driver's preference for each of the transmitters. Use the following procedure to turn the feature off using the corresponding transmitter:

1. Keep all doors closed, the vehicle in PARK (P) and the ignition on throughout this procedure.
2. Press and hold the power door lock switch in LOCK throughout this procedure. All the doors will lock.
3. Press the button with the unlock symbol on the transmitter. The lock delay is still on and all the doors will unlock.
4. Press the button with the unlock symbol on the transmitter again. Lock delay is now off and all the doors will lock.
5. Release the power door lock switch.

To turn this feature on, repeat the previous procedure.

This procedure changes the mode for only the transmitter used to change this setting. The procedure will need to be repeated for the second transmitter.

## Programmable Automatic Door Locks

Close the doors and turn on the ignition. Every time you move the shift lever out of PARK (P), all of the doors will lock. And, every time you stop and move the shift lever into PARK (P), the doors will unlock. If someone needs to get out while you are not in PARK (P), have that person use the manual door lock or the power door lock switch. When the door is closed again, it will not lock automatically. Use the manual door lock or the power door lock switch to lock the door again.

## Personalization Programming

You can program the automatic door lock feature to change to the following modes:

**Mode 0:** No automatic door lock or unlock.

**Mode 1:** All doors automatically lock when shifted out of PARK (P). No automatic door unlock.

**Mode 2:** All doors automatically lock when shifted out of PARK (P). Only the driver's door automatically unlocks when shifted into PARK (P).

**Mode 3:** All doors automatically lock when shifted out of PARK (P). All doors automatically unlock when shifted into PARK (P).

**Mode 4:** All doors automatically lock when shifted out of PARK (P). Only the driver's door automatically unlocks when the key is turned to OFF (DIC equipped vehicles only).

**Mode 5:** All doors automatically lock when shifted out of PARK (P). All doors automatically unlock when the key is turned to OFF (DIC equipped vehicles only).

If your vehicle is equipped with the Driver Information Center (DIC), you must program this feature through the DIC. See *DIC Vehicle Personalization on page 3-64*.

If your vehicle is not equipped with remote keyless entry, use the following procedure to change modes:

1. Keep all doors closed, the vehicle in PARK (P) and the ignition on throughout this procedure.
2. Press and hold the driver's power door lock switch in LOCK through Step 3.
3. Cycle the shift lever, starting in PARK (P), out of PARK (P) and then back into PARK (P), to advance by one mode for each cycle.

After the first cycle, you will hear a door locking action, which identifies the current mode.

4. Release the power door lock switch. The automatic door locks will remain in the most recent mode selected.

If your vehicle is equipped with remote keyless entry, use the following procedure to change modes:

1. Keep all doors closed, the vehicle in PARK (P) and the ignition on throughout this procedure.
2. Press and hold the driver's power door lock switch in LOCK through Step 4.
3. Press the button with the lock symbol on the remote keyless entry transmitter. The automatic door locks will remain in the current mode.
4. Press the button with the lock symbol on the transmitter again. Each time the transmitter's lock button is pressed, the mode will advance by one, going from 3 to 0 to 1, etc.  
The door locks will cycle according to the mode entered. Mode 0 has no feedback.
5. Release the power door lock switch. The automatic door locks will remain in the most recent mode selected.

This procedure changes the mode for only the transmitter used to change this setting. The procedure will need to be repeated for the second transmitter.

## Overriding Lock Delay

If you need to lock your doors before shifting out of PARK (P), just use the manual door lock or the power door lock switch to lock the doors.

## Rear Door Security Locks

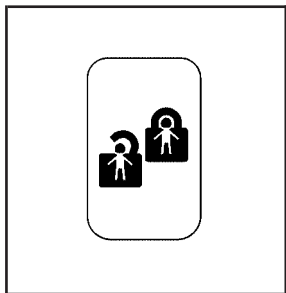

Your vehicle is equipped with rear door security locks that prevent passengers from opening the rear doors of your vehicle from the inside.

To use one of these locks, do the following:

1. Open the rear door you want to lock.
2. Move the lever located on the inside door edge, all the way to the lock symbol.
3. Close the door.
4. Do the same thing to the other rear door lock.

The rear doors of your vehicle cannot be opened from the inside when this feature is in use.

To open a rear door when the security lock is on, do the following:

1. Unlock the door.
2. Then open the door from the outside.

If you do not cancel the security lock feature, adults or older children who ride in the rear seat will not be able to open the rear door from the inside. You should let adults and older children know how these security locks work, and how to cancel the locks.

To cancel the rear door lock, do the following:

1. Unlock and open the door from the outside.
2. Move the lever all the way to the unlock symbol.
3. Do the same for the other rear door.

The rear door locks will now work normally.

## Lockout Protection

The power door locks will not work if the key is in the ignition and any door is open. You can override this feature by holding the driver's power door lock switch for more than three seconds.

## Trunk

### CAUTION:

It can be dangerous to drive with the trunk lid open because carbon monoxide (CO) gas can come into your vehicle. You cannot see or smell CO. It can cause unconsciousness and even death. If you must drive with the trunk lid open or if electrical wiring or other cable connections must pass through the seal between the body and the trunk lid:

- Make sure all other windows are shut.
- Turn the fan on your heating or cooling system to its highest speed and select the control setting that will force outside air into your vehicle. See **Climate Control System** in the Index.
- If you have air outlets on or under the instrument panel, open them all the way.

See *Engine Exhaust on page 2-34*.

## Trunk Lock Release

To unlock the trunk from the outside, insert the master key into the trunk lock cylinder and turn it.

## Remote Trunk Release



If your vehicle has this feature, press the trunk release button located in the glove box to open the trunk lid.

The key does not have to be in the ignition for the remote trunk button to work. The transaxle must be in PARK (P) or NEUTRAL (N). The system also works with the remote keyless entry system, if equipped.

In order to secure items in the trunk, lock the glove box with the master key and take your key and remote keyless entry transmitter with you. The valet key, if equipped, cannot open the trunk or the glovebox.

## Emergency Trunk Release Handle

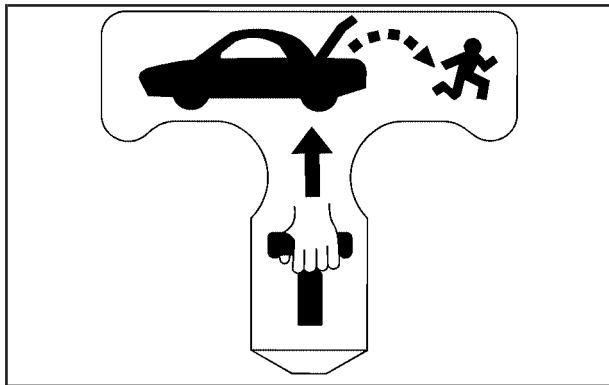

**Notice:** Using the emergency trunk release handle as a tie-down or anchor point when securing items in the trunk may damage it. Use the emergency trunk release handle only to help you open the trunk lid.

There is a glow-in-the-dark emergency trunk release handle located in the trunk near the trunk latch. This handle will glow following exposure to light. Pull the release handle up to open the trunk from the inside.



## Windows

### CAUTION:

Leaving children, helpless adults, or pets in a vehicle with the windows closed is dangerous. They can be overcome by the extreme heat and suffer permanent injuries or even death from heat stroke. Never leave a child, a helpless adult, or a pet alone in a vehicle, especially with the windows closed in warm or hot weather.



## Power Windows



Switches on the driver's door panel operate each of the windows when the ignition is on or when Retained Accessory Power (RAP) is active. In addition, each passenger door has a switch for its own window. Pull the switch toward you to lower the window. Press the switch toward the front of the vehicle to raise the window.

## Express-Down Window

When the driver's or front passenger's window switch, marked AUTO, is pushed all the way rearward, the window will lower completely. The window can be opened in smaller amounts by pressing the switch rearward slightly, to the first stop.

To stop the window while it is lowering in the express mode, press the switch again, then release it. To raise the window, hold the switch forward.

## Window Lock Out

Press the LOCK button on the driver's door armrest to disable all of the passenger window switches. If your vehicle has a Driver Information Center (DIC), you can also set this feature to only lock out the rear window switches. See *Driver Information Center (DIC)* on page 3-59. All driver's window switches will still be operable.

Press the LOCK button again to allow passengers to use their window switches.

An indicator light in the button will glow when the window lock out feature is active.

## Sun Visors

To block out glare, you can swing down the visors. You can also remove them from the center mount and swing them to the side.

## Visor Vanity Mirror

Open the cover to expose the vanity mirror.

If your vehicle has the optional lighted vanity mirrors, the lamps come on when you open the cover.

## Theft-Deterrent Systems

Vehicle theft is big business, especially in some cities. Although your vehicle has a number of theft-deterrent features, we know that nothing we put on it can make it impossible to steal.

## Universal Theft-Deterrent

If your vehicle has this feature, it has a theft-deterrent alarm system. With this system, the SECURITY light will flash as you open the door if your ignition is in OFF.



**United States and V6  
in Canada**

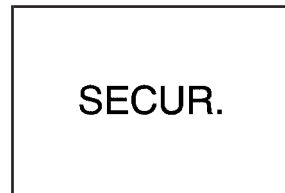

**Canada (V8 Only)**

This light on the instrument panel cluster reminds you to activate the theft-deterrent system when leaving your vehicle.

To activate the system, do the following:

1. Open the door.
2. Lock the door with the power door lock switch while the door is open, or use the remote keyless entry transmitter, if equipped. The SECURITY light should come on and stay on.
3. Close all doors. The SECURITY light should go off after about 30 seconds and the system will then be armed.

If the SECURITY light comes on for one minute and then shuts off while the ignition is on, the security system has detected a problem. See your dealer for service.

If a door is opened without the key or remote keyless entry transmitter, or if the door key cylinders are damaged, the alarm will go off. The exterior lamps will flash and the horn will sound for 30 seconds, then will go off in order to save battery power.

Remember, the theft-deterrent system will not activate if you lock the doors with a key or manual door lock. It activates only if you use a power door lock switch while the door is open, or the remote keyless entry transmitter.

Avoid setting off the alarm by accident.

Always unlock a door with a key, or use the remote keyless entry transmitter. Unlocking a door any other way will set off the alarm.

If you set off the alarm by accident, unlock the driver's door with your key. You can also turn off the alarm by pressing the button with the unlock symbol on the remote keyless entry transmitter. The alarm will not stop if you try to unlock a door any other way.

## Testing the Alarm

1. From inside the vehicle, roll down the window.
2. Activate the system by locking the doors with the power door lock switch while the door is open, or with the remote keyless entry transmitter, if equipped.
3. Get out of the vehicle, close the door and wait for the SECURITY light to go out.
4. Then, reach in through the window, unlock the door with the manual door lock and open the door. This should set off the alarm.

If the alarm does not sound when it should, check to see if the horn works. The horn fuse may be blown. To replace the fuse, see *Fuses and Circuit Breakers on page 5-111*.

If the alarm does not sound, or the exterior lamps do not flash, see your dealer.

## Content Theft-Deterrent

If your vehicle has this option, it has a content theft-deterrent alarm system.

A light located in your Twilight Sentinel® cluster, above the fog lamp button, will begin to flash 30 seconds after the vehicle ignition is turned off to let you know the system has been armed.

While armed, the doors will not unlock with the power door lock switch.

Once armed, the alarm will go off if someone tries to enter the vehicle without using the remote keyless entry transmitter or a key, breaks a window, tries to damage the vehicle or turns the ignition to ON. If any of these do occur, the horn will sound and the parking lamps will flash for up to two minutes.

## PASS-Key® III

Your PASS-Key® III system operates on a radio frequency subject to Federal Communications Commission (FCC) Rules and with Industry Canada.

This device complies with Part 15 of the FCC Rules. Operation is subject to the following two conditions:

1. This device may not cause harmful interference.
2. This device must accept any interference received, including interference that may cause undesired operation.

This device complies with RSS-210 of Industry Canada. Operation is subject to the following two conditions:

1. This device may not cause interference.
2. This device must accept any interference received, including interference that may cause undesired operation of the device.

Changes or modifications to this system by other than an authorized service facility could void authorization to use this equipment.

PASS-Key® III uses a radio frequency transponder in the key that matches a decoder in your vehicle.

## PASS-Key® III Operation

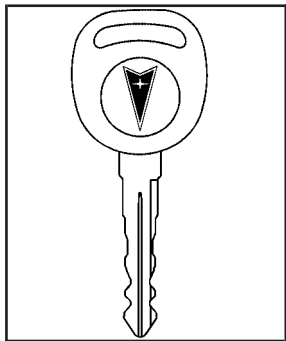

Your vehicle is equipped with the PASS-Key® III (Personalized Automotive Security System) theft-deterrent system. PASS-Key® III is a passive theft-deterrent system.

This means you do not have to do anything different to arm or disarm the system. It works when you insert or remove the key from the ignition.

When the PASS-Key® III system senses that someone is using the wrong key, it shuts down the vehicle's starter and fuel systems. The starter will not work and fuel will stop being delivered to the engine. Anyone using a trial-and-error method to start the vehicle will be discouraged because of the high number of electrical key codes.

When trying to start the vehicle, if the engine does not start and the SECURITY light comes on, the key may have a damaged transponder. Turn the ignition off and try again.

If the engine still does not start, and the key appears to be undamaged, try another ignition key. At this time, you may also want to check the fuse. See *Fuses and Circuit Breakers on page 5-111*. If the engine still does not start with the other key, your vehicle needs service. If your vehicle does start, the first key may be faulty. See your dealer who can service the PASS-Key® III to have a new key made.

It is possible for the PASS-Key® III decoder to learn the transponder value of a new or replacement key. Up to 10 keys may be programmed for the vehicle. This procedure is for programming additional keys only.

**Canadian Owners:** If you lose or damage your keys, only a GM dealer can service PASS-Key® III to have new keys made. To program additional keys you will require two current driver's keys. You must add a step to the following procedure. After Step 2 repeat Steps 1 and 2 with the second current driver's key. Then continue with Step 3.

To program the new key, do the following:

1. Verify that the new key has PK3 stamped on it.
2. Insert the current driver's key in the ignition and start the engine. If the engine will not start, see your dealer for service.
3. After the engine has started, turn the key to OFF, and remove the key.
4. Insert the key to be programmed and turn it to ON within 10 seconds of removing the previous key.
5. The SECURITY light will turn off once the key has been programmed. It may not be apparent that the SECURITY light went on due to how quickly the key is programmed.
6. Repeat Steps 1 through 4 if additional keys are to be programmed.

If you are ever driving and the SECURITY light comes on and stays on, you will be able to restart your engine if you turn it off. Your PASS-Key® III system, however, is not working properly and must be serviced by your dealer. Your vehicle is not protected by the PASS-Key® III system at this time.

If you lose or damage a PASS-Key® III key, see your dealer to have a new key made.

## Starting and Operating Your Vehicle

### New Vehicle Break-In

**Notice:** Your vehicle does not need an elaborate break-in. But it will perform better in the long run if you follow these guidelines:

- Do not drive at any one speed — fast or slow — for the first 500 miles (805 km). Do not make full-throttle starts.
- Avoid making hard stops for the first 200 miles (322 km) or so. During this time your new brake linings are not yet broken in. Hard stops with new linings can mean premature wear and earlier replacement. Follow this breaking-in guideline every time you get new brake linings.
- Do not tow a trailer during break-in. See *Towing a Trailer (V8 Engine) on page 4-36* or *Towing a Trailer (V6 Engine) on page 4-36* for more information.

## Ignition Positions

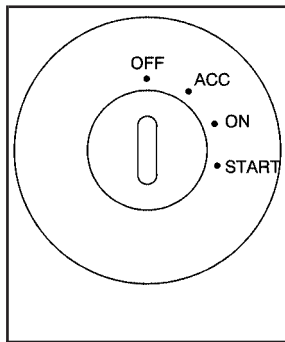

With the key in the ignition, you can turn to four different positions.

**Notice:** Using a tool to force the key from the ignition switch could cause damage or break the key. Use the correct key and turn the key only with your hand. Make sure the key is in all the way. If none of this works, then your vehicle needs service.

**OFF:** This is the only position from which you can remove the key. This position locks your ignition and transaxle. It is a theft-deterrent feature.

**ACC (Accessory):** In this position you can operate your electrical accessories such as power windows, audio system, windshield wipers, and sunroof, if equipped.

**ON:** This is the position the switch returns to after you start your engine and release the switch. Even when the engine is not running, you can use ON to operate your electrical accessories and to display some instrument panel cluster warning lights. This is the position for driving your vehicle.

**START:** This position starts the engine. When the engine starts, release the key. The ignition switch will return to ON for normal driving.

Even if the engine is not running, ACC and ON are positions that allow you to operate your electrical accessories.

## Key Reminder Warning

If you leave your key in OFF you will hear a warning tone when you open the driver's door.

## Retained Accessory Power (RAP)

After you turn the ignition off and remove the key, you will still have power to such accessories as the radio, power windows and sunroof, if equipped, for up to 10 minutes. Power is turned off if you open a door.

Always leave your key in OFF. If you leave your key in any position other than OFF, your battery will discharge prematurely.



## Starting Your Engine

Move your shift lever to PARK (P) or NEUTRAL (N). Your engine will not start in any other position — that is a safety feature. To restart when you are already moving, use NEUTRAL (N) only.

**Notice:** Shifting into PARK (P) with the vehicle moving could damage the transaxle. Shift into PARK (P) only when your vehicle is stopped.

1. With your foot off the accelerator pedal, turn your ignition key to START. When the engine starts, let go of the key. The idle speed will go down as your engine gets warm.

**Notice:** Holding your key in START for longer than 15 seconds at a time will cause your battery to be drained much sooner. And the excessive heat can damage your starter motor. Wait about 15 seconds between each try to help avoid draining your battery or damaging your starter.

2. If it does not start within 10 seconds, hold your key in START for about 10 seconds at a time until your engine starts. Wait about 15 seconds between each try.

3. If your engine still will not start, or starts but then stops, it could be flooded with too much gasoline. Try pushing your accelerator pedal all the way to the floor and holding it there as you hold the key in START for about three seconds.

If your vehicle has the V8 engine, and the engine starts briefly but then stops again, repeat the procedure.

If your vehicle has the V6 engine, and the engine starts briefly but then stops, repeat the procedure, but this time keep the pedal down for five or six seconds to clear the extra gasoline from the engine. After waiting about 15 seconds, repeat the normal starting procedure.

**Notice:** Your engine is designed to work with the electronics in your vehicle. If you add electrical parts or accessories, you could change the way the engine operates. Before adding electrical equipment, check with your dealer. If you do not, your engine might not perform properly.

## Engine Coolant Heater

If your vehicle has this feature, in very cold weather, 0°F (-18°C) or colder, the engine coolant heater can help. You will get easier starting and better fuel economy during engine warm-up. Usually, the coolant heater should be plugged in a minimum of four hours prior to starting your vehicle. At temperatures above 32°F (0°C), use of the coolant heater is not required.

### To Use the Engine Coolant Heater

1. Turn off the engine.
2. Open the hood and unwrap the electrical cord.  
The engine coolant heater cord is located on the passenger's side of the vehicle, above the headlamp assembly.
3. Plug it into a normal, grounded 110-volt AC outlet.

### CAUTION:

**Plugging the cord into an ungrounded outlet could cause an electrical shock. Also, the wrong kind of extension cord could overheat and cause a fire. You could be seriously injured. Plug the cord into a properly grounded three-prong 110-volt AC outlet. If the cord will not reach, use a heavy-duty three-prong extension cord rated for at least 15 amps.**

4. Before starting the engine, be sure to unplug and store the cord as it was before to keep it away from moving engine parts. If you do not, it could be damaged.

How long should you keep the coolant heater plugged in? The answer depends on the outside temperature, the kind of oil you have, and some other things. Instead of trying to list everything here, we ask that you contact your dealer in the area where you will be parking your vehicle. The dealer can give you the best advice for that particular area.

## Automatic Transaxle Operation

Your automatic transaxle may have a shift lever located on the console between the seats or on the steering column.

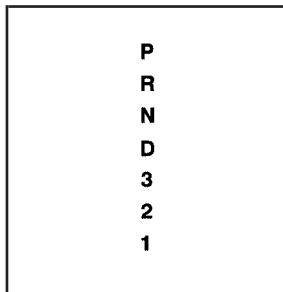

There are several different positions for your shift lever.

**PARK (P):** This position locks your front wheels. It is the best position to use when you start your engine because your vehicle can not move easily.

### **CAUTION:**

It is dangerous to get out of your vehicle if the shift lever is not fully in PARK (P) with the parking brake firmly set. Your vehicle can roll.

Do not leave your vehicle when the engine is running unless you have to. If you have left the engine running, the vehicle can move suddenly. You or others could be injured. To be sure your vehicle will not move, even when you are on fairly level ground, always set your parking brake and move the shift lever to PARK (P). See *Shifting Into Park (P)* on page 2-31. If you are pulling a trailer, see *Towing a Trailer (V8 Engine)* on page 4-36 or *Towing a Trailer (V6 Engine)* on page 4-36.

Ensure the shift lever is fully in PARK (P) before starting the engine. Your vehicle has an automatic transaxle shift lock control system. You have to fully apply your regular brakes before you can shift from PARK (P) when the ignition key is in ON. If you cannot shift out of PARK (P), ease pressure on the shift lever by pushing it all the way into PARK (P) and also release the shift lever button on console shift models as you maintain brake application. Then move the shift lever into the gear you want. Press the shift lever button before moving the shift lever on console shift models. See *Shifting Out of Park (P) on page 2-33*.

**REVERSE (R):** Use this gear to back up.

**Notice:** Shifting to REVERSE (R) while your vehicle is moving forward could damage the transaxle. The repairs would not be covered by your warranty. Shift to REVERSE (R) only after your vehicle is stopped.

To rock your vehicle back and forth to get out of snow, ice or sand without damaging your transaxle, see *If You Are Stuck: In Sand, Mud, Ice or Snow on page 4-28*.

**NEUTRAL (N):** In this position, your engine does not connect with the wheels. To restart when you are already moving, use NEUTRAL (N) only. Also, use NEUTRAL (N) when your vehicle is being towed.

 **CAUTION:**

**Shifting into a drive gear while your engine is running at high speed is dangerous. Unless your foot is firmly on the brake pedal, your vehicle could move very rapidly. You could lose control and hit people or objects. Do not shift into a drive gear while your engine is running at high speed.**

**Notice:** Shifting out of PARK (P) or NEUTRAL (N) with the engine racing may damage the transaxle. The repairs would not be covered by your warranty. Be sure the engine is not racing when shifting your vehicle.

**AUTOMATIC OVERDRIVE (D):** This position is for normal driving. If you need more power for passing, and you are:

- Going less than about 35 mph (55 km/h), push your accelerator pedal about halfway down.
- Going about 35 mph (55 km/h) or more, push the accelerator all the way down.

You will shift down to the next gear and have more power.

**THIRD (3):** This position is also used for normal driving. However, it offers more power and lower fuel economy than AUTOMATIC OVERDRIVE (D).

Here are some times you might choose THIRD (3) instead of AUTOMATIC OVERDRIVE (D):

- When driving on hilly, winding roads
- When towing a trailer, so there is less shifting between gears
- When going down a steep hill

**SECOND (2):** This position gives you more power but lower fuel economy than THIRD (3). You can use SECOND (2) on hills. It can help control your speed as you go down steep mountain roads, but then you would also want to use your brakes off and on.

**Notice:** Driving in SECOND (2) for more than 25 miles (40 km) or at speeds over 55 mph (90 km/h) may damage the transaxle. Also, shifting into SECOND (2) at speeds above 65 mph (105 km/h) can cause damage. Drive in THIRD (3) or AUTOMATIC OVERDRIVE (D) instead of SECOND (2).

**FIRST (1):** This position gives you even more power but lower fuel economy than SECOND (2). You can use it on very steep hills, or in deep snow or mud. If the shift lever is put in FIRST (1), the transaxle will not shift into first gear until the vehicle is going slowly enough.

**Notice:** Spinning the tires or holding the vehicle in one place on a hill using only the accelerator pedal may damage the transaxle. If you are stuck, do not spin the tires. When stopping on a hill, use the brakes to hold the vehicle in place.

## Parking Brake



Your vehicle has a PUSH TO RELEASE parking brake. To set the parking brake, hold the regular brake pedal down with your right foot. Push down the parking brake pedal with your left foot.

If the ignition is on, the brake system warning light will come on and four chimes will be heard.

If you start to drive with the parking brake set, a chime will sound after the vehicle has traveled approximately 40 feet (12 m).

To release the parking brake, hold the regular brake pedal down with your right foot and push the parking brake pedal with your left foot. When you lift your left foot, the parking brake pedal will follow it to the release position.

If you try to drive with the parking brake on, the brake light stays on and a chime sounds until you release the parking brake.

**Notice:** Driving with the parking brake on can overheat the brake system and cause premature wear or damage to brake system parts. Verify that the parking brake is fully released and the brake warning light is off before driving.

If you are towing a trailer and are parking on any hill, see *Towing a Trailer (V8 Engine)* on page 4-36 or *Towing a Trailer (V6 Engine)* on page 4-36. That section shows what to do first to keep the trailer from moving.

## Shifting Into Park (P)

### CAUTION:

**It can be dangerous to get out of your vehicle if the shift lever is not fully in PARK (P) with the parking brake firmly set. Your vehicle can roll. If you have left the engine running, the vehicle can move suddenly. You or others could be injured. To be sure your vehicle will not move, even when you are on fairly level ground, use the steps that follow. If you are pulling a trailer, see *Towing a Trailer (V8 Engine) on page 4-36* or *Towing a Trailer (V6 Engine) on page 4-36*.**

## Steering Column Shift Lever

If your vehicle has the steering column shift lever, hold the brake pedal down with your right foot and set the parking brake.

1. Hold the brake pedal down with your right foot and set the parking brake.
2. Move the shift lever into PARK (P) by pulling the shift lever toward you and moving it up as far as it will go.
3. Turn the ignition key to OFF.
4. Remove the key and take it with you. If you can leave your vehicle with the ignition key in your hand, your vehicle is in PARK (P).

## Console Shift Lever

If your vehicle has the console shift lever, hold the brake pedal down with your right foot and set the parking brake.

1. Hold the brake pedal down with your right foot and set the parking brake.
2. Move the shift lever into PARK (P) by holding in the button on the shift lever while pushing the lever all the way toward the front of the vehicle
  - Hold in the button on the lever.
  - Push the lever all the way toward the front of the vehicle.
3. Turn the ignition key to OFF.
4. Remove the key and take it with you. If you can leave your vehicle with the ignition key in your hand, your vehicle is in PARK (P).

## Leaving Your Vehicle With the Engine Running

### **CAUTION:**

**It can be dangerous to leave your vehicle with the engine running. Your vehicle could move suddenly if the shift lever is not fully in PARK (P) with the parking brake firmly set. And, if you leave the vehicle with the engine running, it could overheat and even catch fire. You or others could be injured. Do not leave your vehicle with the engine running.**

If you have to leave your vehicle with the engine running, be sure your vehicle is in PARK (P) and your parking brake is firmly set before you leave it. After you have moved the shift lever into PARK (P), hold the regular brake pedal down. Then, see if you can move the shift lever away from PARK (P) without first pulling it toward you. Or, if you have the console shift lever, without first pushing the button. If you can, it means that the shift lever was not fully locked into PARK (P).



## Torque Lock

If you are parking on a hill and you do not shift your transaxle into PARK (P) properly, the weight of the vehicle may put too much force on the parking pawl in the transaxle. You may find it difficult to pull the shift lever out of PARK (P). This is called “torque lock.” To prevent torque lock, set the parking brake and then shift into PARK (P) properly before you leave the driver’s seat. To find out how, see *Shifting Into Park (P)* on page 2-31.

When you are ready to drive, move the shift lever out of PARK (P) before you release the parking brake.

If torque lock does occur, you may need to have another vehicle push yours a little uphill to take some of the pressure from the parking pawl in the transaxle, so you can pull the shift lever out of PARK (P).

## Shifting Out of Park (P)

Your vehicle has an automatic transaxle shift lock control system which locks the shift lever in PARK (P) when the ignition is in OFF. In addition, you have to fully apply your regular brakes before you can shift from PARK (P) when the ignition is in ON. See *Automatic Transaxle Operation* on page 2-27.

If you cannot shift out of PARK (P), ease pressure on the shift lever and push the shift lever all the way into PARK (P) as you maintain brake application. Then, move the shift lever into the gear you want. If you have the console shift lever, press the button first.

If you ever hold the brake pedal down but still cannot shift out of PARK (P), try this:

1. Turn the key to OFF. There is no shift interlock in this key position.
2. Apply and hold the brake until the end of Step 4.
3. Shift the transaxle to NEUTRAL (N).
4. Start the vehicle and then shift to the gear you want.
5. Have the system fixed as soon as you can.

## Parking Over Things That Burn

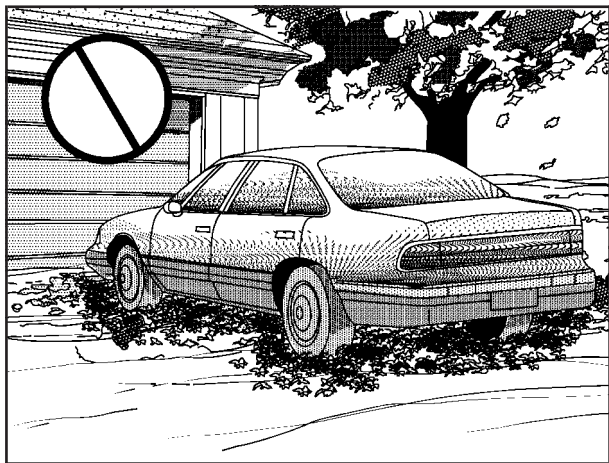

### CAUTION:

Things that can burn could touch hot exhaust parts under your vehicle and ignite. Do not park over papers, leaves, dry grass or other things that can burn.

## Engine Exhaust

### CAUTION:

Engine exhaust can kill. It contains the gas carbon monoxide (CO), which you cannot see or smell. It can cause unconsciousness and death.

You might have exhaust coming in if:

- Your exhaust system sounds strange or different.
- Your vehicle gets rusty underneath.
- Your vehicle was damaged in a collision.
- Your vehicle was damaged when driving over high points on the road or over road debris.
- Repairs were not done correctly.
- Your vehicle or exhaust system had been modified improperly.

If you ever suspect exhaust is coming into your vehicle:

- Drive it only with all the windows down to blow out any CO; and
- Have your vehicle fixed immediately.

## Running Your Engine While You Are Parked

It is better not to park with the engine running. But if you ever have to, here are some things to know.

### CAUTION:

Idling the engine with the climate control system off could allow dangerous exhaust into your vehicle. See the earlier caution under *Engine Exhaust on page 2-34*.

Also, idling in a closed-in place can let deadly carbon monoxide (CO) into your vehicle even if the climate control fan is at the highest setting. One place this can happen is a garage. Exhaust — with CO — can come in easily. **NEVER** park in a garage with the engine running.

Another closed-in place can be a blizzard. See *Winter Driving on page 4-24*.

### CAUTION:

It can be dangerous to get out of your vehicle if the shift lever is not fully in PARK (P) with the parking brake firmly set. Your vehicle can roll. Do not leave your vehicle when the engine is running unless you have to. If you have left the engine running, the vehicle can move suddenly. You or others could be injured. To be sure your vehicle will not move, even when you are on fairly level ground, always set your parking brake and move the shift lever to PARK (P).

Follow the proper steps to be sure your vehicle will not move. See *Shifting Into Park (P) on page 2-31*.

If you are parking on a hill and if you are pulling a trailer, also see *Towing a Trailer (V8 Engine) on page 4-36* or *Towing a Trailer (V6 Engine) on page 4-36*.

# Mirrors

## Manual Rearview Mirror

While sitting in a comfortable driving position, adjust the mirror so you can see clearly behind your vehicle. Grip the mirror in the center to move it up or down and side to side. The control at the bottom of the mirror is the day/night feature that allows adjustment to the mirror so that the glare of headlamps from behind is reduced. Push the tab for daytime use; pull it for night use.

## Automatic Dimming Rearview Mirror

The vehicle may have an automatic dimming rearview mirror. It may also have OnStar<sup>®</sup> controls. See *OnStar<sup>®</sup> System on page 2-39* for more information.

At night, when glare from lights is high, the mirror will gradually darken. This change may take a few seconds. The mirror will return to its clear daytime state when glare is reduced.

## Mirror Operation

**AUTO:** Press this button to turn on the automatic dimming feature.

**OFF:** Press this button to turn off the automatic dimming feature.

 **(On/Off):** For mirrors equipped with OnStar<sup>®</sup> controls, press this button to turn the automatic dimming feature on or off.

The indicator light will be illuminated when this feature is on.

## Outside Power Mirrors



The controls for the outside power mirrors are located on the driver's door armrest.

Press the left or right side of the L/R selector switch located beneath the control pad to choose the left or right mirror.

To adjust the mirror, use one of the four arrows located on the control pad to move the mirror in the direction you want it to go. When finished adjusting the mirrors, leave the L/R selector switch in the center position, to prevent unwanted mirror movement in case the control pad is accidentally bumped while driving. Adjust each outside mirror so that you can see a little of your vehicle and the area behind your vehicle.

If your vehicle is equipped with the memory function, the mirrors and driver's seat position can be stored into memory. See *Memory Seat and Mirrors* on page 2-46.

## Outside Curb View Assist Mirror

If you have the memory seat and mirrors feature, the passenger's outside power mirror also includes a tilt-down feature that operates when the shift lever is in REVERSE (R). When the vehicle is shifted out of REVERSE (R), the passenger's mirror will return to its original position after a five-second delay. This delay prevents movement of the mirror if multiple gear transitions (REVERSE (R) to AUTOMATIC OVERDRIVE (D) to REVERSE (R)) occur during a parallel parking maneuver. This feature can be programmed on or off through the DIC personalization programming menu. See *DIC Vehicle Personalization on page 3-64* for programming instructions.

## Outside Convex Mirror

The passenger's side mirror is convex. A convex mirror's surface is curved so more can be seen from the driver's seat.

### CAUTION:

**A convex mirror can make things (like other vehicles) look farther away than they really are. If you cut too sharply into the right lane, you could hit a vehicle on your right. Check your inside mirror or glance over your shoulder before changing lanes.**

## Outside Heated Mirrors

If your vehicle has this feature, when you operate the rear window defogger, the heated driver's and passenger's outside power mirrors are warmed to help clear them of ice and snow. See "Rear Window Defogger" under *Climate Control System on page 3-25* or *Automatic Climate Control System on page 3-28* for more information.

## OnStar® System

OnStar® uses global positioning system (GPS) satellite technology, wireless communications, and call centers to provide you with a wide range of safety, security, information, and convenience services.

A complete OnStar® user's guide and the terms and conditions of the OnStar® Subscription Service Agreement are included in the vehicle's glove box literature. For more information, visit [www.onstar.com](http://www.onstar.com) or [www.onstarcanada.com](http://www.onstarcanada.com). Contact OnStar® at 1-888-4-ONSTAR (1-888-466-7827), or press the OnStar® button to speak to an OnStar® advisor 24 hours a day, 7 days a week.

Terms and conditions of the Subscription Service Agreement can be found at [www.onstar.com](http://www.onstar.com) or [www.onstarcanada.com](http://www.onstarcanada.com).

## OnStar® Services

For new vehicles equipped with OnStar®, the Safe and Sound Plan is included for the first year. You can extend this plan beyond the first year, or upgrade to the Directions and Connections Plan to meet your needs. For more information, press the OnStar® button to speak with an advisor.

## Safe and Sound Plan

- Automatic Notification of Airbag Deployment
- Emergency Services
- Roadside Assistance
- Stolen Vehicle Tracking
- AccidentAssist
- Remote Door Unlock/Vehicle Alert
- Remote Diagnostics
- Online Concierge

## Directions and Connections Plan

- All Safe and Sound Plan Services
- Driving Directions
- RideAssist
- Information and Convenience Services

## OnStar® Personal Calling

As an OnStar® subscriber, the Personal Calling capability is available if your hand-held cell phone is lost, forgotten, or has a low battery. It is a hands-free wireless phone that is integrated into the vehicle. Calls can be placed nationwide using simple voice commands with no additional contracts and no additional roaming charges. To find out more about OnStar® Personal Calling, refer to the OnStar® user's guide in the vehicle's glove box or visit [www.onstar.com](http://www.onstar.com) or [www.onstarcanada.com](http://www.onstarcanada.com); or speak with an OnStar® advisor by pressing the OnStar® button or by calling 1-888-4-ONSTAR (1-888-466-7827).

## OnStar® Virtual Advisor

Virtual Advisor is a feature of OnStar® Personal Calling that uses minutes to access up-to-date weather and traffic reports for your area, news and sports updates, stock quotes, entertainment and more. You are also able to listen and reply to your E-mail through your vehicle's audio system. Customize your information profile at [www.myonstar.com](http://www.myonstar.com). See the OnStar® user's guide for more information.

## HomeLink® Transmitter

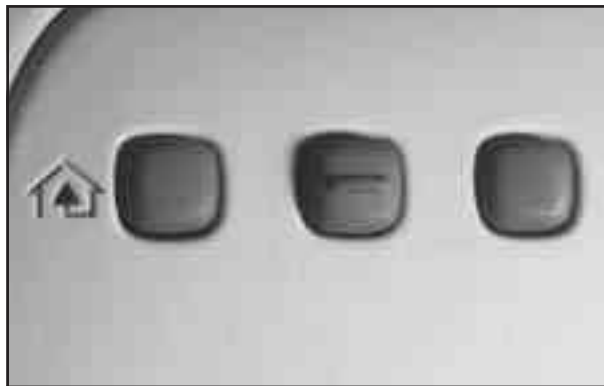

HomeLink®, a combined universal transmitter and receiver, provides a way to replace up to three hand-held transmitters used to activate devices such as gate operators, garage door openers, entry door locks, security systems and home lighting. Additional HomeLink® information can be found on the internet at [www.homelink.com](http://www.homelink.com) or by calling 1-800-355-3515.



If your vehicle is equipped with the HomeLink<sup>®</sup> Transmitter, it complies with Part 15 of the FCC Rules. Operation is subject to the following two conditions:  
(1) this device may not cause harmful interference, and  
(2) this device must accept any interference received, including interference that may cause undesired operation.

This device complies with RSS-210 of Industry Canada. Operation is subject to the following two conditions:  
(1) this device may not cause interference, and (2) this device must accept any interference, including interference that may cause undesired operation of the device.

Changes and modifications to this system by other than an authorized service facility could void authorization to use this equipment.

## **Programming the HomeLink<sup>®</sup> Transmitter**

Do not use the HomeLink<sup>®</sup> Transmitter with any garage door opener that does not have the “stop and reverse” feature. This includes any garage door opener model manufactured before April 1, 1982. If you have a newer garage door opener with rolling codes, please be sure to follow Steps 6 through 8 to complete the programming of your HomeLink<sup>®</sup> Transmitter.

Read the instructions completely before attempting to program the HomeLink<sup>®</sup> Transmitter. Because of the steps involved, it may be helpful to have another person available to assist you in programming the transmitter.

Keep the original transmitter for use in other vehicles as well as for future HomeLink<sup>®</sup> programming. It is also recommended that upon the sale of the vehicle, the programmed HomeLink<sup>®</sup> buttons should be erased for security purposes. Refer to “Erasing HomeLink<sup>®</sup> Buttons” or, for assistance, contact HomeLink<sup>®</sup> on the internet at: [www.homelink.com](http://www.homelink.com) or by calling 1-800-355-3515.

Be sure that people and objects are clear of the garage door or gate operator you are programming. When programming a garage door, it is advised to park outside of the garage.

It is recommended that a new battery be installed in your hand-held transmitter for quicker and more accurate transmission of the radio frequency.

## Programming HomeLink®

Your vehicle's engine should be turned off while programming the transmitter. Follow these steps to program up to three channels:

1. Press and hold down the two outside buttons, releasing only when the indicator light begins to flash, after 20 seconds. Do not hold down the buttons for longer than 30 seconds and do not repeat this step to program a second and/or third transmitter to the remaining two HomeLink® buttons.

2. Position the end of your hand-held transmitter about 1 to 3 inches (3 to 8 cm) away from the HomeLink® buttons while keeping the indicator light in view.

3. Simultaneously press and hold both the desired button on HomeLink® and the hand-held transmitter button. Do not release the buttons until Step 4 has been completed.

Some entry gates and garage door openers may require you to substitute Step 3 with the procedure noted in "Gate Operator and Canadian Programming" later in this section.

4. The indicator light will flash slowly at first and then rapidly after HomeLink® successfully receives the frequency signal from the hand-held transmitter. Release both buttons.

5. Press and hold the newly-trained HomeLink® button and observe the indicator light.

If the indicator light stays on constantly, programming is complete and your device should activate when the HomeLink® button is pressed and released.

To program the remaining two HomeLink® buttons, begin with Step 2 under "Programming HomeLink®." Do not repeat Step 1 as this will erase all of the programmed channels.

If the indicator light blinks rapidly for two seconds and then turns to a constant light, continue with Steps 6 through 8 following to complete the programming of a rolling-code equipped device (most commonly, a garage door opener).

6. Locate in the garage, the garage door opener receiver (motor-head unit). Locate the "Learn" or "Smart" button. This can usually be found where the hanging antenna wire is attached to the motor-head unit.
7. Firmly press and release the "Learn" or "Smart" button. The name and color of the button may vary by manufacturer.

You will have 30 seconds to start Step 8.

8. Return to the vehicle. Firmly press and hold the programmed HomeLink<sup>®</sup> button for two seconds, then release. Repeat the press/hold/release sequence a second time, and depending on the brand of the garage door opener (or other rolling code device), repeat this sequence a third time to complete the programming.

HomeLink<sup>®</sup> should now activate your rolling-code equipped device.

To program the remaining two HomeLink<sup>®</sup> buttons, begin with Step 2 of “Programming HomeLink<sup>®</sup>.” You do not want to repeat Step 1, as this will erase all previous programming.

## **Gate Operator and Canadian Programming**

Canadian radio-frequency laws require transmitter signals to “time out” or quit after several seconds of transmission. This may not be long enough for HomeLink<sup>®</sup> to pick up the signal during programming. Similarly, some U.S. gate operators are manufactured to “time out” in the same manner.

If you live in Canada, or you are having difficulty programming a gate operator by using the “Programming HomeLink<sup>®</sup>” procedures (regardless of where you live), replace Step 3 under “Programming HomeLink<sup>®</sup>” with the following:

Continue to press and hold the HomeLink<sup>®</sup> button while you press and release every two seconds (cycle) your hand-held transmitter until the frequency signal has been successfully accepted by HomeLink<sup>®</sup>. The indicator light will flash slowly at first and then rapidly. Proceed with Step 4 under “Programming HomeLink<sup>®</sup>” to complete.

## **Using HomeLink<sup>®</sup>**

Press and hold the appropriate HomeLink<sup>®</sup> button for at least half of a second. The indicator light will come on while the signal is being transmitted.

## Erasing HomeLink® Buttons

To erase programming from the three buttons do the following:

1. Press and hold down the two outside buttons until the indicator light begins to flash, after 20 seconds. Do not hold the two outside buttons for longer than 30 seconds.
2. Release both buttons.

HomeLink® is now in the train (learning) mode and can be programmed at any time beginning with Step 2 under “Programming HomeLink®” shown earlier in this section.

Individual buttons cannot be erased, but they can be reprogrammed. See “Reprogramming a Single HomeLink® Button” following this section.

## Reprogramming a Single HomeLink® Button

To program a device to HomeLink® using a HomeLink® button previously trained, follow these steps:

1. Press and hold the desired HomeLink® button. Do not release the button.
2. The indicator light will begin to flash after 20 seconds. While still holding the HomeLink® button, proceed with Step 2 under “Programming HomeLink®” shown earlier in this section.

## Resetting Defaults

To reset HomeLink® to default settings do the following:

1. Hold down the two outside buttons for about 20 seconds until the indicator light begins to flash.
2. Continue to hold both buttons until the HomeLink® indicator light turns off.
3. Release both buttons.

For questions or comments, contact HomeLink® at 1-800-355-3515, or on the internet at [www.homelink.com](http://www.homelink.com).

## Storage Areas

### Glove Box

Use the master key to lock and unlock the glove box. To open it, lift the latch release on the left side of the glove box door.

The VALET key, if equipped, will not work in the glove box door lock.

## Front Storage Area

Press the buttons on either side of the armrest to open the front storage area.

## Center Console Storage Area

If your vehicle has this feature, press the button at the front edge of the armrest to open the center console storage area.

## Rear Seat Pass Through

Your vehicle has a rear seat armrest with cupholders and a pass-through feature.

Pull down the interior door to access the trunk.

## Convenience Net

Your vehicle may have a convenience net. You will see it just inside the back wall of the trunk.

Put small loads behind the net. It can help keep them from falling over during sharp turns or quick starts and stops. For heavier loads, store them in the trunk as far forward as you can.

You can unhook the net so that it will lie flat when you are not using it.

## Sunroof

Your vehicle may be equipped with a sunroof. The sunroof has both manual and express features for opening the glass panel and sunshade.



The switch for the sunroof is located on the headliner between the sun visors.

The sunroof switch has a number of positions that control the sunroof movement.

The switch will work only when the ignition is on or when the RAP is active. See "Retained Accessory Power (RAP)" under *Ignition Positions* on page 2-24.

**Open:** Press and hold the switch rearward to the first position to open the glass panel and sunshade. The sunshade can also be opened manually.

**Comfort Stop:** Press and release the switch rearward to the second position to express open the glass panel to the comfort stop position. The comfort stop position is designed to help reduce noise and make passengers more comfortable.

**Express Open:** When the glass panel is express opening, pressing the switch in any direction will stop it in a partially-opened position. The glass panel may be fully opened by pressing the switch rearward again. If you press and hold the switch in the express open position for more than one and a half seconds, the express open operation will be overridden and the sunroof will operate manually.

**Close:** To close the glass panel, press and hold the switch forward. As the glass panel reaches the closed position, it will open slightly toward the vent position and then drop down to the closed position to provide a better seal. The sunshade must be closed manually.

**Vent:** Once the sunroof is closed, it can be opened to the vent position by pushing the switch upward. To close the glass panel, pull the switch downward. The sunshade must be opened and closed manually for vent operation.

## Vehicle Personalization

### Memory Seat and Mirrors



If your vehicle has this feature, the controls are located on the driver's door panel, and are used to program and recall memory settings for the driver's seating, outside mirror positions and climate controls. See *DIC Vehicle Personalization on page 3-64* for more information.

To save your seat and mirror positions into memory, do the following:

1. First identify the DRIVER # on the Driver Information Center (DIC) by pressing memory button 1 or 2 or by pressing the unlock button on the remote keyless entry transmitter. See *Driver Information Center (DIC) on page 3-59*.

2. Adjust the driver's seat and lumbar position to a safe and comfortable driving position. Adjust both outside mirrors to suit you. See *DIC Vehicle Personalization on page 3-64*.
3. Press and hold the memory button corresponding with your DRIVER # displayed on the DIC for longer than three seconds. You will hear two beeps confirming that the seat and mirror positions have been entered into memory.

To set the seat and mirror positions for a second driver, follow the previous steps, but start by pressing the unlock button on the remote keyless entry transmitter that displays the other DRIVER # on the DIC. Be sure to use the memory button which corresponds to the DRIVER # identified by the second remote keyless entry transmitter.

To recall your memory positions, your vehicle must be in PARK (P). Press and release the memory button corresponding to the desired driving position. The seat and mirrors will move to the position previously stored for the identified driver. You will hear one beep.

To store the exit position for an easy exit, do the following:

1. First identify the DRIVER # by pressing memory button 1 or 2 or by pressing the unlock button on the remote keyless entry transmitter.

2. Adjust the driver's seat to the desired exit position.
3. Press and hold the EXIT button for longer than three seconds. You will hear two beeps confirming that the seat exit position has been entered into memory.

To set the exit position for a second driver, follow the previous steps, but start by pressing the unlock button on the remote keyless entry transmitter that displays the other DRIVER # on the DIC. Be sure to use the memory button which corresponds to the DRIVER # identified by the other remote keyless entry transmitter.

To recall the exit position, your vehicle must be in PARK (P). Press and release the EXIT button and the seat will move to the exit position previously stored for the current identified driver. You will hear one beep. If an exit position has not been stored for the current identified driver, the seat will move all the way back.

To stop recall movement of the seat at any time, press the driver's power seat control located on the outboard side of the front seat.

Mirrors and lumbar positions will not be stored or recalled for the exit position.

If you would like your stored driving or exit position to be recalled when unlocking your vehicle with the remote keyless entry transmitter, see *DIC Vehicle Personalization on page 3-64*.



# NOTES

---

---

---

---

---

---

---

---

---

---

---

---

---

---

---

---

---

---

---

---

---

---



## Section 3 Instrument Panel

---

<b>Instrument Panel Overview</b> .....	3-4	Rear Reading Lamps .....	3-20
Hazard Warning Flashers .....	3-6	Battery Load Management .....	3-20
Other Warning Devices .....	3-6	Inadvertent Power Battery Saver .....	3-21
Horn .....	3-6	Head-Up Display (HUD) .....	3-21
Tilt Wheel .....	3-6	Accessory Power Outlets .....	3-24
Turn Signal/Multifunction Lever .....	3-7	Ashtrays and Cigarette Lighter .....	3-24
Turn and Lane-Change Signals .....	3-8	<b>Climate Controls</b> .....	3-25
Headlamp High/Low-Beam Changer .....	3-8	Climate Control System .....	3-25
Flash-to-Pass .....	3-9	Automatic Climate Control System .....	3-28
Windshield Wiper Lever .....	3-9	Outlet Adjustment .....	3-32
Cruise Control .....	3-11	Climate Controls Personalization .....	3-32
Exterior Lamps .....	3-14	<b>Warning Lights, Gages, and Indicators</b> .....	3-33
Wiper Activated Headlamps .....	3-14	Instrument Panel Cluster .....	3-33
Headlamps on Reminder .....	3-15	Speedometer and Odometer .....	3-37
Daytime Running Lamps (DRL) .....	3-15	Trip Odometer .....	3-37
Fog Lamps .....	3-16	Tachometer .....	3-38
Twilight Sentinel® .....	3-16	Safety Belt Reminder Light .....	3-38
Exterior Lighting Battery Saver .....	3-17	Airbag Readiness Light .....	3-38
Instrument Panel Brightness .....	3-17	Voltmeter Gage .....	3-40
Courtesy Lamps .....	3-17	Brake System Warning Light .....	3-41
Entry Lighting .....	3-18	Anti-Lock Brake System Warning Light .....	3-42
Delayed Entry Lighting .....	3-18	Traction Control System (TCS) Warning Light .....	3-43
Theater Dimming .....	3-18	Low Traction Active Light .....	3-44
Delayed Exit Lighting .....	3-18	Engine Coolant Temperature Gage (V6 Engine) .....	3-45
Perimeter Lighting .....	3-18		
Parade Dimming .....	3-19		
Front Reading Lamps .....	3-20		

## Section 3 Instrument Panel

---

Engine Coolant Temperature Gage (V8 Engine) .....	3-46	<b>Secondary Information Center (SIC)</b> .....	3-70
Tire Pressure Light .....	3-47	Electronic Compass .....	3-70
Malfunction Indicator Lamp .....	3-48	<b>Audio System(s)</b> .....	3-72
Oil Pressure Gage (V6 Engine) .....	3-51	Setting the Time .....	3-72
Oil Pressure Gage (V8 Engine) .....	3-52	Radio with CD .....	3-73
Check Oil Level Light .....	3-53	Radio with Cassette and CD .....	3-83
Security Light .....	3-53	Trunk-Mounted CD Changer .....	3-95
Highbeam On Light .....	3-54	Theft-Deterrent Feature .....	3-99
Low Washer Fluid Warning Light .....	3-54	Audio Steering Wheel Controls .....	3-99
Check Gages Warning Light .....	3-54	Radio Reception .....	3-100
Door Ajar Light .....	3-54	Care of Your Cassette Tape Player .....	3-101
Trunk Ajar Light .....	3-55	Care of Your CDs .....	3-102
Service Vehicle Soon Light .....	3-55	Care of Your CD Player .....	3-102
Fuel Gage (V6 Engine) .....	3-56	Diversity Antenna System .....	3-102
Fuel Gage (V8 Engine) .....	3-57	XM™ Satellite Radio Antenna System .....	3-103
<b>Systems Monitor</b> .....	3-58	Chime Level Adjustment .....	3-103
<b>Driver Information Center (DIC)</b> .....	3-59		
DIC Controls and Displays .....	3-60		
DIC Warnings and Messages .....	3-62		
Driver Identifier DIC Display .....	3-64		
DIC Vehicle Personalization .....	3-64		



# Instrument Panel Overview

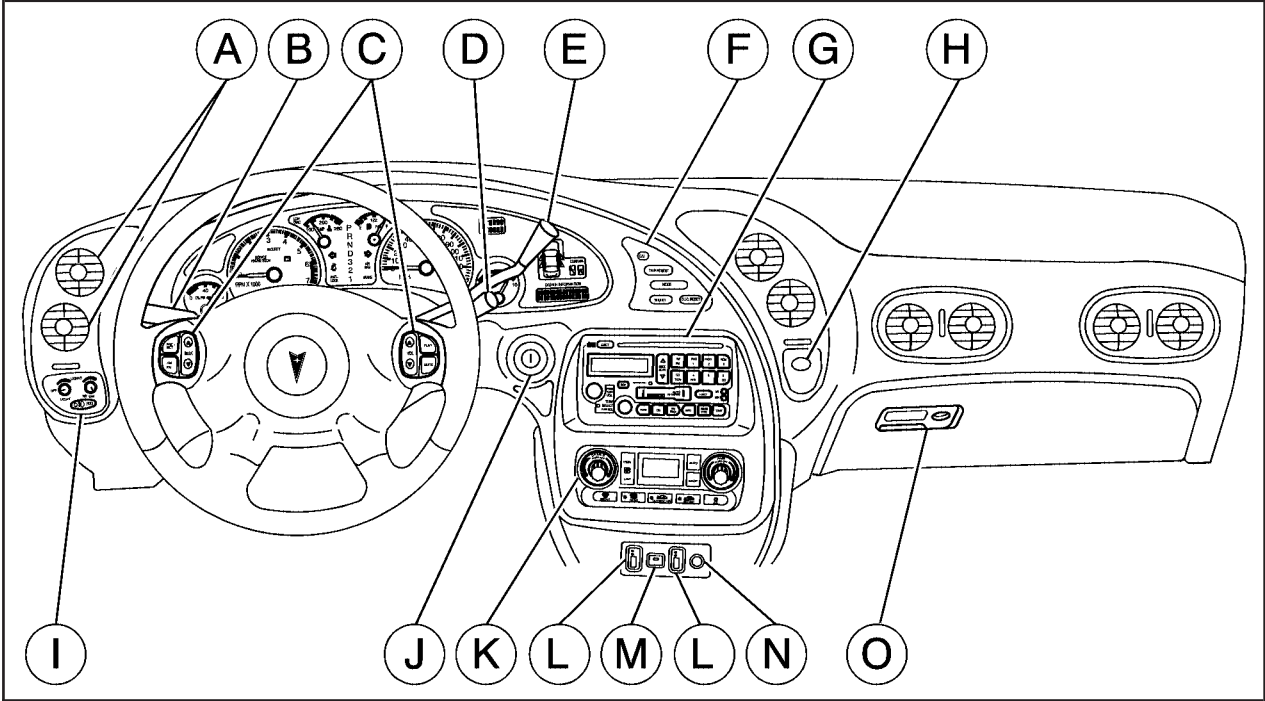

The main components of your instrument panel are the following:

- A. Air Outlets. See "Air Outlets" under *Outlet Adjustment* on page 3-32.
- B. Turn Signal/Multifunction Lever. See *Turn Signal/Multifunction Lever* on page 3-7.
- C. Audio System Steering Wheel Controls (If Equipped). See *Audio Steering Wheel Controls* on page 3-99.
- D. Windshield Wiper Lever. See "Windshield Wipers" under *Windshield Wiper Lever* on page 3-9.
- E. Steering Column Shift Lever (If Equipped). See *Automatic Transaxle Operation* on page 2-27.
- F. Driver Information Center (DIC) Controls (If Equipped). See *Driver Information Center (DIC)* on page 3-59.
- G. Audio System. See *Audio System(s)* on page 3-72.
- H. Hazard Warning Flashers Control. See *Hazard Warning Flashers* on page 3-6.
- I. Twilight Sentinel® Controls and Fog Lamps Button. See *Twilight Sentinel®* on page 3-16 and *Fog Lamps* on page 3-16.
- J. Ignition Switch. See *Ignition Positions* on page 2-24.
- K. Climate Control System. See *Climate Control System* on page 3-25 and *Automatic Climate Control System* on page 3-28.
- L. Heated Seat Switches (If Equipped). See *Heated Seats* on page 1-4.
- M. Traction Control Button (If Equipped). See *Traction Control System (TCS)* on page 4-8.
- N. Cigarette Lighter. See *Ashtrays and Cigarette Lighter* on page 3-24.
- O. Glove Box. See *Glove Box* on page 2-44.

## Hazard Warning Flashers

Your hazard warning flashers let you warn others. They also let police know you have a problem. Your front and rear turn signal lamps will flash on and off.

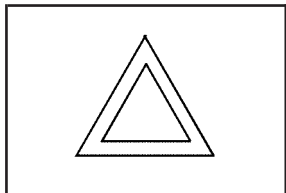

The hazard warning flasher button is located on the instrument panel, between the audio system and the glove box.

Your hazard warning flashers work no matter what position your key is in, and even if the key is not in.

Press the button to make the front and rear turn signal lamps flash on and off. Press the button again to turn the flashers off.

When the hazard warning flashers are on, your turn signals will not work.

## Other Warning Devices

If you carry reflective triangles, you can set them up at the side of the road about 300 feet (100 m) behind your vehicle.

### Horn

Press the vehicle's steering wheel pad to sound the horn.

### Tilt Wheel

A tilt wheel allows you to adjust the steering wheel before you drive. You can also raise it to the highest level to give your legs more room when you exit and enter the vehicle.





The lever that allows you to tilt the steering wheel is located on the left side of the steering column.

To tilt the wheel, hold the wheel and pull the lever toward you. Then move the steering wheel to a comfortable level and release the lever to lock the wheel in place.

## Turn Signal/Multifunction Lever



The lever on the left side of the steering column includes the following:

-  Turn and Lane-Change Signals. See *Turn and Lane-Change Signals* on page 3-8.
-  Headlamp High/Low-Beam Changer. See *Headlamp High/Low-Beam Changer* on page 3-8.
- Flash-To-Pass. See *Flash-to-Pass* on page 3-9.
- Cruise Control. See *Cruise Control* on page 3-11.

For information on the exterior lamps, see *Exterior Lamps* on page 3-14.

## Turn and Lane-Change Signals

The turn signal has two upward for right, and two downward for left, positions. These positions allow you to signal a turn or a lane change.

To signal a turn, move the lever all the way up or down. When the turn is finished, the lever will return automatically.

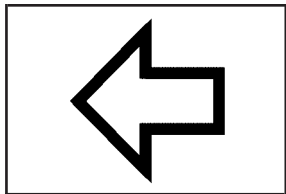

An arrow on the instrument panel cluster will flash in the direction of the turn or lane change.

To signal a lane change, just raise or lower the lever until the arrow starts to flash. Hold it there until you complete your lane change. The lever will return by itself when you release it.

If the arrows flash very fast as you signal a turn or a lane change, a signal bulb may be burned out and other drivers will not see your turn signal. If a bulb is burned out, replace it to help avoid an accident. See *Bulb Replacement on page 5-67*.

If the arrows do not go on at all when you signal a turn, check the fuse. See *Fuses and Circuit Breakers on page 5-111*.

### Turn Signal On Chime

If your turn signal is left on for more than 3/4 of a mile (1.2 km), a chime will sound at each flash of the turn signal. To turn off the chime, move the turn signal lever to the off position.

### Headlamp High/Low-Beam Changer

To change the headlamps from low beam to high beam, push the lever forward. To change from high beam to low beam, pull the turn signal lever toward you, then release it.



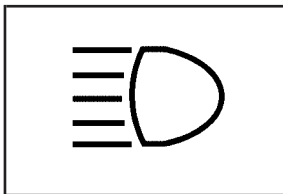

When the high beams are on, this light on the instrument panel cluster will also be on.

If you have the SE model, both the low beam and high beam headlamps will be on when you are in high beam mode. If you have the SLE or GXP models, only the high beam headlamps will be on when you are in high beam mode.

## Flash-to-Pass

This feature lets you use your high-beam headlamps to signal a driver in front of you that you want to pass. It works even if your headlamps are off.

To use it, pull the turn signal lever toward you.

If your headlamps are off or on low beam, your high-beam headlamps will turn on. They will stay on as long as you hold the lever toward you and the high-beam indicator on the instrument panel cluster will come on. Release the lever to turn the high-beam headlamps off.

## Windshield Wiper Lever



The windshield wipers are controlled by the lever on the right of your steering column.

If your windshield wipers are on for more than six seconds while you are driving, the low-beam headlamps, instrument panel cluster backlighting and the taillamps will turn on. For more information see "Wiper-Activated Headlamps" under *Exterior Lamps* on page 3-14.

**OFF:** Lower the lever to its original position to turn the wipers OFF.

**INT (Intermittent):** Push the lever up to the INT position and turn the INT ADJ band to adjust the delay time. The further you turn the band, the shorter the delay between wiping cycles.

**LO (Low Speed):** Push the lever up to LO for steady wiping at a slow speed.

**HI (High Speed):** Push the lever up to HI for steady wiping at a high speed.

**MIST:** For a single wiping cycle, push the lever down to the MIST position and let go. The wipers will stop after one cycle. If you want more cycles, hold the lever down.

Heavy snow or ice can overload your wiper motor. A circuit breaker will stop the motor until it cools. Clear away snow or ice to prevent an overload.

Keep in mind that damaged wiper blades may prevent you from seeing well enough to drive safely. To avoid damage, be sure to clear ice and snow from the wiper blades before using them. If your blades do become damaged, get new blades or blade inserts. See *Windshield Wiper Blade Replacement on page 5-73*.

## Windshield Washer

At the end of the wiper lever, there is a button. To spray washer fluid on the windshield, push the button until you have enough fluid to clean the windshield. The wipers will clear the window and either stop or return to your preset speed.

### **CAUTION:**

**In freezing weather, do not use your washer until the windshield is warmed. Otherwise the washer fluid can form ice on the windshield, blocking your vision.**

A WASHER FLUID warning light will indicate if the fluid level in the windshield washer reservoir is low. See *Low Washer Fluid Warning Light on page 3-54*.

## Cruise Control

With cruise control, you can maintain a speed of about 25 mph (40 km/h) or more without keeping your foot on the accelerator. This can really help on long trips.



The cruise control switch is located on the lever on the left side of the steering column.

Cruise control does not work at speeds below about 25 mph (40 km/h).

When you apply your brakes, the cruise control shuts off.

### CAUTION:

**Cruise control can be dangerous where you cannot drive safely at a steady speed. So, do not use your cruise control on winding roads or in heavy traffic.**

**Cruise control can be dangerous on slippery roads. On such roads, fast changes in tire traction can cause needless wheel spinning, and you could lose control. Do not use cruise control on slippery roads.**

If your vehicle is in cruise control when the optional traction control system begins to limit wheel spin, the cruise control will automatically disengage. See *Traction Control System (TCS)* on page 4-8. When road conditions allow you to safely use it again, you may turn the cruise control back on.

## Setting Cruise Control

### CAUTION:

**If you leave your cruise control on when you are not using cruise, you might hit a button and go into cruise when you do not want to. You could be startled and even lose control. Keep the cruise control switch off until you want to use cruise control.**

1. Move the cruise control switch to ON.
2. Get up to the speed you want.
3. Press the SET button.
4. Take your foot off the accelerator pedal.

## Resuming a Set Speed

Suppose you set your cruise control at a desired speed and then you apply the brake. This, of course, shuts off the cruise control. But you do not need to reset it.

Once you are going about 25 mph (40 km/h) or more, you can move the cruise lever to R/A (resume/accelerate) briefly.

You will go right back up to your chosen speed and stay there. Remember that if you hold the lever at R/A, the vehicle will keep going faster until you release the switch or apply the brake. So unless you want to go faster, do not hold the lever at R/A.

## Increasing Speed While Using Cruise Control

There are two ways to go to a higher speed.

- Use the accelerator pedal to get to the higher speed. Press the SET button and then release it as well as the accelerator pedal. You will now cruise at the higher speed.
- Move the cruise switch to R/A. Hold it there until you get up to the speed you want, and then release it. To increase your speed in very small amounts, move the switch to R/A briefly and then release it. Each time you do this, your vehicle will go about 1 mph (1.6 km/h) faster.

The accelerate feature will only work after you have set the cruise control speed by pressing the SET button.

## **Reducing Speed While Using Cruise Control**

There are two ways to reduce your speed while using cruise control:

- Press and hold the SET button until you get to the speed you want, and then release it.
- To slow down in very small amounts, press and release the SET button briefly. Each time you do this, you will go about 1 mph (1.6 km/h) slower.

## **Passing Another Vehicle While Using Cruise Control**

Use the accelerator pedal to increase your speed. When you take your foot off the pedal, your vehicle will slow down to the cruise control speed you set earlier.

## **Using Cruise Control on Hills**

How well your cruise control will work on hills depends upon your speed, load and the steepness of the hills. When going up steep hills, you may have to step on the accelerator pedal to maintain your speed. When going downhill, you may have to brake or shift to a lower gear to keep your speed down. Of course, applying the brake takes you out of cruise control. Many drivers find this to be too much trouble and do not use cruise control on steep hills.

## **Ending Cruise Control**

There are three ways to turn off the cruise control:

- Step lightly on the brake pedal.
- Move the cruise switch to OFF.
- Pull the multifunction lever toward the driver.

## **Erasing Speed Memory**

When you turn off the cruise control or the ignition, your cruise control set speed memory is erased.

## Exterior Lamps



The lever on the left side of the steering column operates the exterior lamps.

 : Turn the outside part of the lever with the symbol on it, to operate the lamps. The exterior lamp switch has three positions.

**OFF:** Turn the switch to this position to turn off all lamps and lights, except the Daytime Running Lamps (DRL).

 (**Parking Lamps**): Turn the switch to this position to turn on the parking lamps, together with the following:

- Sidemarkers Lamps
- Taillamps
- License Plate Lamps
- Instrument Panel Lights

 (**Headlamps**): Turn the switch to this position to turn on the headlamps, together with the previously listed lamps and lights.

## Wiper Activated Headlamps

This feature turns on the low-beam headlamps, instrument panel cluster backlighting and taillamps when the Twilight Sentinel<sup>®</sup> is in day mode and after the windshield wipers have been in use for about six seconds.

To operate the wiper-activated headlamps, the Twilight Sentinel<sup>®</sup> must be on. If the wiper-activated headlamps are on and the ignition switch is turned to ON, the wiper-activated headlamps will continue. When you turn the key to OFF, the wiper-activated headlamps will immediately turn off. The wiper-activated headlamps will also turn off if you turn off the Twilight Sentinel<sup>®</sup> or the windshield wipers.

## Headlamps on Reminder

If you open the driver's door while leaving the headlamps or parking lamps on and the key is in OFF, you will hear a warning chime.

## Daytime Running Lamps (DRL)

Daytime Running Lamps (DRL) can make it easier for others to see the front of your vehicle during the day. DRL can be helpful in many different driving conditions, but they can be especially helpful in the short periods after dawn and before sunset. Fully functional daytime running lamps are required on all vehicles first sold in Canada.

A light sensor on top of the instrument panel monitors the exterior light level for the operation of DRL and Twilight Sentinel<sup>®</sup>, so be sure it is not covered. The DRL system will make your low-beam headlamps come on at a reduced brightness. In order for the DRL system to be activated, the following conditions must be met:

- The ignition is on.
- The exterior lamp control is off.
- The transaxle is not in PARK (P).

When the DRL are on, only your low-beam headlamps will be on at reduced intensity. The taillamps, sidemarker and other lamps will not be on. Your instrument panel will not be lit either.

When it is dark enough outside, your regular intensity headlamps will come on at full brightness and the DRL lighting will turn off. The parking lamps that normally come on with your headlamps will also come on. When it is bright enough outside, the regular intensity headlamps and parking lamps will turn back off, and the reduced brightness DRL lighting will turn back on.

To idle your vehicle during the day with the DRL off, shift the transaxle into PARK (P). The DRL will stay off until you shift out of PARK (P).

At night, you can turn off all exterior lamps when you are in PARK (P) by turning the Twilight Sentinel<sup>®</sup> knob all the way to OFF.

If the knob was already in OFF, it must be cycled to ON and back to OFF. Turn the knob clockwise to turn the exterior lighting back on. The lamps will come back on automatically when you put the transaxle in gear.

As with any vehicle, you should turn on the regular headlamp system when you need it.

## Fog Lamps



The fog lamps button is located below the twilight knobs, to the left of the steering wheel on the instrument panel.

Press this button to turn on and off the fog lamps. An indicator light on the button will come on when the fog lamps are on and go off when the fog lamps are off. Your fog lamps will remain how you left them, on or off, when you turn your vehicle off and then on again.

Your parking lamps will also come on automatically while the fog lamps are active.

If your fog lamps are on when you use your high beams or flash-to-pass feature, the fog lamps will be disabled while the feature is being used.

## Twilight Sentinel®



The Twilight Sentinel® will keep your headlamps on for up to three minutes, to light your way when you leave your vehicle.

To operate the Twilight Sentinel®, turn the DELAY knob located to the left of the steering column on the instrument panel fully clockwise for the three-minute delay. Turn it counterclockwise to reduce the delay. Turn the knob to OFF to turn the Twilight Sentinel® off.

At night, you can turn off all exterior lamps when you are in PARK (P) by turning the Twilight Sentinel® knob all the way to OFF. If the knob was already in OFF, it must be cycled to on then back to OFF, to turn the exterior lighting off. The lamps will come back on when you turn the knob clockwise.



If the Twilight Sentinel® lighting is active, it can be disabled by turning on the manual parking lamps. This lighting will be disabled until the key is turned from ON or until the manual parking lamps are turned off.

Also, it is possible that your headlamps may go out if you drive from a dark area into a bright area like a lighted parking lot. If this happens, turn on your headlamps with the exterior lamp control.

## Exterior Lighting Battery Saver

If the exterior lamp control has been left on, the exterior lamps will turn off about 10 minutes after the ignition is turned to OFF and a door has been opened.

This protects against draining the battery in case you have accidentally left the headlamps or parking lamps on. If you need to leave the lamps on for more than 10 minutes, use the exterior lamp control to turn the lamps back on after turning the ignition to OFF and opening a door. To delay the lamps from turning off, see “Twilight Sentinel®,” listed previously.

## Instrument Panel Brightness

When it is dark outside, you can brighten or dim your instrument panel cluster lights using the DIM knob, located to the left of the steering wheel on the instrument panel.

Turn the knob clockwise to brighten the instrument panel cluster lights and displays. Turn the knob clockwise all the way to turn on the interior courtesy lamps. Turn the knob counterclockwise to dim the instrument panel cluster lights and displays and to turn off the courtesy lamps.

## Courtesy Lamps

If it is dark enough outside, when any door is opened, several lamps will come on. They make it easier for you to enter and leave the vehicle. Turn the DIM knob all the way clockwise to turn the interior courtesy lamps on.

## Entry Lighting

If it is dark enough outside and you press the unlock button on the remote keyless entry transmitter, if equipped, the interior courtesy lamps will come on and stay on for about 25 seconds. The lamps will turn off immediately by pressing the lock button on the remote keyless entry transmitter, by turning the ignition key to ON or by activating the power door locks.

If a door is left ajar, your interior lamps will turn off after 10 minutes to save your battery.

## Delayed Entry Lighting

When you open the door to enter your vehicle, the interior lamps will come on if it is dark enough outside. When you close the door with the ignition off, the interior lamps will stay on for 25 seconds or until the ignition is turned on. Locking the doors with the power door lock switch, or with the lock button on the remote keyless entry transmitter, if equipped, will override the delayed entry lighting and the lamps will turn off immediately.

## Theater Dimming

This feature allows for a three to five-second fade out of the courtesy lamps instead of immediate turn off after you remove the key from the ignition.

## Delayed Exit Lighting

This feature will turn on the interior lamps for 25 seconds after you remove the key from the ignition while the doors are closed and it is night. This will give you time to find the door handle or lock switches as you exit the vehicle.

This lighting will only be deactivated if the key is reinserted into the ignition switch or the power door locks are activated.

## Perimeter Lighting

When the unlock button on the remote keyless entry transmitter, if equipped, is pressed, the DRL headlamps, parking lamps and back-up lamps will turn on if it is dark enough outside.

## Personal Choice Programming

This feature can be programmed in the on or off mode for each transmitter.

If your vehicle is equipped with the Driver Information Center (DIC), you must program this feature through the DIC. See *DIC Vehicle Personalization on page 3-64*.

To turn the feature off, do the following:

1. Keep all doors closed, the vehicle in PARK (P) and the ignition on throughout this procedure.
2. Press and hold LOCK on the power door lock switch throughout this procedure. All the doors will lock.
3. Press the remote alarm button on the transmitter. Perimeter lighting remains on at this time and the horn will chirp twice.
4. Press the remote alarm button again. Perimeter lighting is disabled and the horn will chirp once.
5. Release the door lock switch. The perimeter lighting feature is now off.

To turn the feature on, do the following:

1. Keep all doors closed, the vehicle in PARK (P) and the ignition on throughout this procedure.
2. Press and hold LOCK on the power door lock switch throughout this procedure. All the doors will lock.
3. Press the remote alarm button on the transmitter. Perimeter lighting remains off at this time and the horn will chirp once.
4. Press the remote alarm button again. Perimeter lighting is now enabled and the horn will chirp twice.
5. Release the door lock switch. The perimeter lighting feature is now on.

This procedure only changes the mode for the transmitter used to change this setting.

## Parade Dimming

To activate the instrument panel backlighting during the day, turn the exterior lamp switch to the parking lamp or headlamp position. Dimming of the instrument panel display is not possible during daylight hours. The instrument panel display can only be adjusted when the parking lamps or headlamps are on and it is dark outside.

## Front Reading Lamps

The front reading lamps, located on the headliner, will come on as courtesy lamps when you open any of the doors while it is dark outside. They will also come on as part of the interior lighting features listed previously.

To turn on a reading lamp when the doors are closed, press either button. Press it again to turn the lamp off.

To avoid draining your vehicle's battery, be sure to turn off the reading lamps when leaving your vehicle. See "Inadvertent Power Battery Saver" later in this section for more information.

## Rear Reading Lamps

The rear reading lamps, located over each rear door, will come on as courtesy lamps when you open any of the doors while it is dark outside. They will also come on as part of the interior lighting features listed previously.

To turn on a reading lamp when the doors are closed, press either button. Press it again to turn the lamp off.

## Battery Load Management

The battery load management feature is designed to monitor the vehicle's electrical load and determine when the battery is in a heavy discharge condition. During times of high electrical loading, the engine may idle at higher revolutions per minute (RPM) than normal to make sure the battery charges. High electrical loads may occur when several of the following are on: headlamps, high beams, fog lamps, rear window defogger, fan on high speed, heated seats, and engine cooling fans.

If your vehicle's battery remains in a heavy discharge condition for a long period of time, the fan, rear defogger, heated seats and heated mirrors will be disabled and the DIC will display BATTERY SAVER ACTIVE. This can happen either under long periods of idling or low speed driving with high electrical loading, or in the event of a charging system fault.

Monitor the battery voltage when in the BATTERY SAVER ACTIVE mode.

- If the voltmeter remains in the shaded area, below 11 volts, when driving then have the charging system serviced immediately.
- If the voltage increases above 12 volts then the battery needs to be recharged. Try driving on the highway with as few electrical accessories on as possible.

## Inadvertent Power Battery Saver

This feature is designed to protect your vehicle's battery against drainage from the interior lamps, trunk lamp or glove box lamp. When the ignition is turned off, the power to these features will automatically turn off after 10 minutes. Power will be restored for an additional 10 minutes if any door is opened, the trunk is opened or the courtesy lamps are turned on.

## Head-Up Display (HUD)

### CAUTION:

**If the HUD image is too bright, or too high in your field of view, it may take you more time to see things you need to see when it is dark outside. Be sure to keep the HUD image dim and placed low in your field of view.**

If you have the optional Head-Up Display (HUD), you can see some of the driver information also available on your instrument panel cluster. The information may

be displayed in English or metric units and appears as an image focused out toward the front of your vehicle. The HUD shows the following:

- Speedometer Reading
- Turn Signal Indicators
- High-beam Indicator Symbol
- CHECK GAGES Message (for low oil pressure, high coolant temperature, low oil level, high/low battery, brake, ABS and air bag)
- Low Fuel Warning Symbol
- Radio Frequency and Playback Mode (with the exception of the XM™ radio)

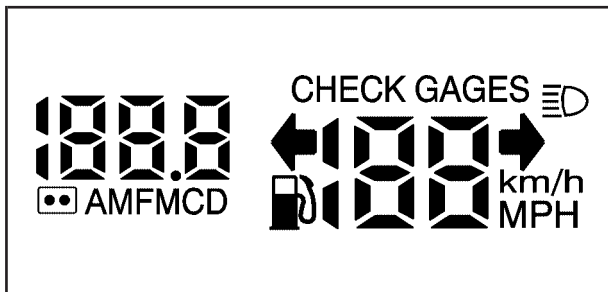

HUD shows these images when they are lighted on the instrument panel.

The speedometer may display a difference of 1.5 mph (2.4 km/h) from the HUD image. This is normal.

When the ignition key is turned to ON, all possible HUD images will come on, then the HUD will operate normally.

If you never look at your instrument panel cluster, you may not see something important, such as a warning light. So be sure to scan your displays and controls and the driving environment just as you would in a vehicle without HUD.

**Notice:** If you try to use the HUD image as a parking aid, you may misjudge the distance and damage your vehicle. Do not use the HUD image as a parking aid.



The HUD controls are located to the left of the steering column.

1. Start your engine and turn the HUD INTENSITY knob all of the way clockwise to MAX (Maximum). The brightness of the HUD image is determined by ambient light, and where you have set the HUD INTENSITY knob.

2. Adjust the seat, if necessary, before setting the height using the IMAGE switch.

Press and hold the top of the IMAGE switch, raising the HUD image as far as possible. Then press on the bottom of the HUD IMAGE switch to move the image down, so the image is as low as possible, but in full view.

3. Turn the INTENSITY knob counterclockwise until the HUD image is no brighter than necessary. To turn the HUD off, turn the HUD INTENSITY knob all the way counterclockwise.

If the sun comes out, or it becomes cloudy, or if you turn on your headlamps, you may need to adjust the HUD brightness using the HUD INTENSITY knob. Polarized sunglasses could make the HUD image harder to see.

Clean the inside of the windshield as needed to remove any dirt or film that reduces the sharpness or clarity of the HUD image.

Spray household glass cleaner on a soft, clean cloth. Wipe the HUD lens gently, then dry it. Do not spray cleaner directly on the lens, because the cleaner fluid could leak inside the unit.

If you cannot see the HUD image when the ignition is on, check to see if:

- The HUD unit is covered.
- The HUD INTENSITY knob is adjusted correctly.
- The HUD image is adjusted to the proper height.
- A fuse in the fuse panel may have blown. See *Fuses and Circuit Breakers on page 5-111*.

If the HUD image is not clear, it could be too bright. Move the HUD INTENSITY knob counterclockwise. You may need to clean the windshield and HUD lens.

Your windshield is part of the HUD system. If you ever have to have a new windshield, be sure to get one designed for HUD. If you do not, the HUD image may look blurred and out of focus.

## Accessory Power Outlets

With the accessory power outlet you can plug in auxiliary electrical equipment such as a cellular telephone or CB radio.

If your vehicle has a front console, the 12-volt accessory power outlet is located at the rear of the front console. If your vehicle has a floor console, the outlet is located at the rear of the floor console.

To use the outlet, remove the protective cap which covers it. When not using it, always cover the outlet with the protective cap.

**Notice:** Leaving electrical equipment on for extended periods will drain the battery. Always turn off electrical equipment when not in use and do not plug in equipment that exceeds the maximum amperage rating.

Certain electrical accessories may not be compatible with the accessory power outlet and could result in blown vehicle or adapter fuses. If you experience a problem, see your dealer for additional information on accessory power outlets.

**Notice:** Adding any electrical equipment to your vehicle may damage it or keep other components from working as they should. The repairs would not be covered by your warranty. Check with your dealer before adding electrical equipment.

When adding electrical equipment, be sure to follow the proper installation instructions included with the equipment.

**Notice:** Improper use of the power outlet can cause damage not covered by your warranty. Do not hang any type of accessory or accessory bracket from the plug because the power outlets are designed for accessory power plugs only.

## Ashtrays and Cigarette Lighter

Push down on the cover to reveal the front ashtray. To clean the ashtray, lift it out by pulling on the finger holes on each side.

On models without a console, an ashtray is located underneath the instrument panel. To clean the ashtray, lift it out by pulling up on the tabs on either side. It snaps back into place.



To open a rear ashtray, lift the cover.

**Notice:** If you put papers or other flammable items in the ashtray, hot cigarettes or other smoking materials could ignite them and possibly damage your vehicle. Never put flammable items in the ashtray.

The cigarette lighter is located next to the storage tray. To use a lighter, just push the center in all the way and let it go. When it is ready, the center will pop back out by itself. Pull out the entire unit to use it.

**Notice:** Holding a cigarette lighter in while it is heating will not allow the lighter to back away from the heating element when it is hot. Damage from overheating may occur to the lighter or heating element, or a fuse could be blown. Do not hold a cigarette lighter in while it is heating. Do not use anything other than the cigarette lighter in the heating element.

## Climate Controls

### Climate Control System

With this system you can control the heating, cooling and ventilation for your vehicle.





**FAN:** Turn the left knob clockwise or counterclockwise to increase or decrease the fan speed. Push this knob to turn the fan on and off. The fan must be on in order for the air conditioning compressor to run.

**TEMP (Temperature Control):** Turn the right knob clockwise or counterclockwise to manually increase or decrease the temperature inside your vehicle.

To change the current mode, select one of the following:

 **(FLOOR):** This mode directs most of the air to the floor outlets with some air directed to the outboard outlets (for the side windows) and some air directed to the windshield.

 **(Bi-Level):** This mode directs about half of the air to the instrument panel outlets, and then directs most of the remaining air to the floor outlets. There is also a small amount of air directed to the windshield and outboard outlets (for the side windows). This mode directs cooler air to the upper outlets and warmer air to the floor outlets.

 **(Vent):** This mode directs air to the instrument panel outlets.

 **RECIRC (Recirculation):** This mode keeps outside air from coming in the vehicle. It can be used to prevent outside air and odors from entering your vehicle or to help heat or cool the air inside your vehicle more quickly. Press this button to turn the recirculation mode on or off. When the button is pressed, an indicator light will come on. The recirculation mode cannot be used with the FRONT defrost mode.

 **A/C (Air Conditioning):** Press this button to turn the air conditioning compressor on and off. When A/C is pressed, an indicator light in the button will come on to let you know that air conditioning is activated. If your climate control system is off, you may also turn it back on in vent mode by selecting the A/C button.

On hot days, open the windows to let hot inside air escape; then close them. This helps to reduce the time it takes for your vehicle to cool down. It also helps the system to operate more efficiently.

For quick cool down on hot days, do the following:

1. Select the vent mode.
2. Select the recirculation mode.
3. Select A/C.
4. Select the coolest temperature.
5. Select the highest fan speed.

Using these settings together for long periods of time may cause the air inside of your vehicle to become too dry. To prevent this from happening, after the air in your vehicle has cooled, turn the recirculation mode off.

The air conditioning system removes moisture from the air, so you may sometimes notice a small amount of water dripping underneath your vehicle while idling or after turning off the engine. This is normal.

## Defogging and Defrosting

Fog on the inside of windows is a result of high humidity, or moisture, condensing on the cool window glass. This can be minimized if the climate control system is used properly. There are two modes to clear fog or frost from your windshield. Use the defog mode to clear the windows of fog or moisture and warm the passengers. Use the defrost mode to remove fog or frost from the windshield more quickly.

Press one of the available mode buttons to select the defog or defrost mode.

 **(Defog):** This mode directs most of the air to the windshield and the floor outlets. A small amount of air is also directed to the outboard outlets (for the side windows). When you select this mode, the system turns off recirculation and runs the air conditioning compressor unless the outside temperature is at or below freezing. The recirculation mode cannot be selected while in the defog mode.

 **FRONT (Defrost):** Pressing this button directs most of the air to the windshield and the outboard outlets (for the side windows), with some air directed to the floor outlets. When you select this mode, the system turns off recirculation and runs the air conditioning compressor unless the outside temperature is at or below freezing. The recirculation mode cannot be selected while in the FRONT defrost mode. Do not drive the vehicle until all windows are clear.

## Rear Window Defogger

The rear window defogger uses a warming grid to remove fog or frost from the rear window.

 **REAR:** Press this button to turn the rear window defogger on or off. Be sure to clear as much snow from the rear window as possible.

The rear window defogger will turn off about 10 minutes after the button is pressed. If turned on again, the defogger will only run for about five minutes before turning off. If you maintain a speed above 30 mph (48 km/h), the rear defogger will not turn off automatically to help keep the rear glass clear. The defogger can also be turned off by pressing the button again or by turning off the engine.

If your vehicle has outside heated mirrors, the mirrors will heat to help clear fog or frost from the surface of the mirror when the rear window defogger button is pressed.

**Notice:** Using a razor blade or sharp object to clear the inside rear window may damage the rear window defogger. Repairs would not be covered by your warranty. Do not clear the inside of the rear window with sharp objects.

## Automatic Climate Control System

With this system you can control the heating, cooling and ventilation for your vehicle.



### Automatic Operation

**AUTO (Automatic):** Press the AUTO button for automatic control of the inside temperature, the air delivery mode and the fan speed.

1. Press the AUTO button. Whenever this button is pressed, the display will show the current settings for five seconds before returning the display to the exterior temperature.

2. Adjust the temperature to 75° F (24° C).

Choosing the coldest or warmest temperature setting will not cause the system to cool or heat any faster. If you set the system at the coldest or warmest temperature setting, the system will remain at the maximum cold or hot setting and fan speed.

In cold weather, the system will start at reduced fan speeds to avoid blowing cold air into your vehicle until warmer air is available. The system will start out blowing air at the floor but may change modes automatically as the vehicle warms up to maintain the chosen temperature setting. The length of time needed for warm up will depend on the outside temperature and the length of time that has elapsed since your vehicle was last driven.

3. Wait for the system to regulate. This may take from 10 to 30 minutes. Then adjust the temperature, if necessary.

Do not cover the solar sensor located in the center of the instrument panel, near the windshield. For more information on the solar sensor, see "Sensors" later in this section.

## Manual Operation

**DRIVER (Driver's Side Temperature):** The knob on the left is used to change the temperature of the air coming through the system on the driver's side of the vehicle. Push this knob to turn the system on and off. Turn the knob toward the blue area to decrease the set temperature, and toward the red area to increase the set temperature. When this knob is adjusted, the word DRIVER will be displayed under the set temperature.

When the passenger's set temperature is not active, this knob controls both the driver's and passenger's side, and both DRIVER and PASS will be displayed under the set temperature.

**PASS (Passenger's Side Temperature):** The knob on the right is used to change the temperature of the air coming through the system on the passenger's side of the vehicle. Push this knob to turn the system on and off. Turn the knob toward the blue area to decrease the set temperature, and toward the red area to increase the set temperature. When this knob is adjusted, only the word PASS will be displayed under the set temperature.

 **(Fan):** Press the Fan button to display and hold the current fan speed while in manual mode. Press the HIGH side to increase fan speed and the LOW side to decrease the fan speed.

**MODE:** Press this button repeatedly to cycle through and choose the mode of air delivery into the vehicle. The system will stay in the selected mode until MODE is pressed again or until the AUTO button is pressed.

**FLOOR:** This mode directs most of the airflow to the floor outlets with some directed to the outboard outlets (for the side windows) and the windshield.

**BI-LEVEL:** This mode directs airflow through the instrument panel outlets and slightly warmer air through the floor outlets.

**PANEL:** This mode directs airflow through the instrument panel outlets.

Whenever MODE is pressed, the display will show the current system settings for five seconds before returning the display to the exterior temperature.

The mode button can also be used to select the DEFOG mode. Information on defogging and defrosting can be found later in this section.

 **OUTSIDE AIR:** Press this button to turn the OUTSIDE AIR mode on or off. When this mode is on, outside air will circulate through your vehicle. When the button is pressed, an indicator light in the button will come on to let you know that it is activated. The OUTSIDE AIR mode can be used with all modes except the recirculation mode.

If you are in city traffic, and your vehicle is stopped and idling, or the weather is hot, the system may switch from the OUTSIDE AIR mode to the recirculation mode. To prevent the air inside of your vehicle from becoming too stale, be sure to return to the outside air mode periodically.

 **RECIRC (Recirculation):** Press this button to limit the amount of outside air coming into the vehicle. It can be used to prevent outside air and odors from entering your vehicle or to help heat or cool the air inside your vehicle more quickly. Press this button to turn the recirculation mode on or off. When the button is pressed, an indicator light will come on. The recirculation mode cannot be used with the FRONT defrost mode.

 **A/C (Air Conditioning):** Press this button to override the automatic system and turn the air conditioning system on or off. When A/C is pressed, an indicator light in the button will come on to let you know that it is activated. When in AUTO, the air conditioning compressor will come on automatically, as necessary. The air conditioning compressor will also run when you select the FRONT defrost mode and outside temperatures are above freezing.

On hot days, open the windows to let hot inside air escape; then close them. This helps to reduce the time it takes for your vehicle to cool down. It also helps the system to operate more efficiently.

For quick cool down on hot days, press the AUTO button and the system will automatically enter recirculation mode and the temperature will be at the full cold position for maximum cooling.

Using these settings together for long periods of time may cause the air inside of your vehicle to become too dry. To prevent this from happening, after the air in your vehicle has cooled, turn the recirculation mode off.

The air conditioning system removes moisture from the air, so you may sometimes notice a small amount of water dripping underneath your vehicle while idling or after turning off the engine. This is normal.

## Sensors

The solar sensor on your vehicle monitors the solar radiation and the air inside of your vehicle, then uses the information to maintain the selected temperature by initiating needed adjustments to the temperature, the fan speed and the air delivery system. The system may also supply cooler air to the side of the vehicle facing the sun. The recirculation mode will also be activated, as necessary. Do not cover the solar sensor located in the center of the instrument panel, near the windshield, or the system will not work properly.

There is also an EXT (exterior) temperature sensor located behind the front grill. This sensor reads the outside air temperature and helps to maintain the temperature inside the vehicle. Any cover on the front of the vehicle could cause a false reading in the temperature.

## Defogging and Defrosting

Fog on the inside of windows is a result of high humidity, or moisture, condensing on the cool window glass. This can be minimized if the climate control system is used properly. There are two modes to clear fog or frost from your windshield. Use the defog mode to clear the windows of fog or moisture and warm the passengers. Use the FRONT defrost mode to remove fog or frost from the windshield more quickly.

Press the MODE button until DEFOG appears to select this function. Press the FRONT button to select the defrost function.

**DEFOG:** This mode directs the air equally between the windshield and the floor outlets.

 **FRONT (Defrost):** Pressing this button directs most of the air to the windshield and the outboard outlets for the side windows, with some air directed to the floor outlets. When you select this mode, the system turns off recirculation and runs the air conditioning compressor unless the outside temperature is at

or below freezing. The recirculation mode cannot be selected while in the FRONT defrost mode. Do not drive the vehicle until all the windows are clear.

## Rear Window Defogger

The rear window defogger uses a warming grid to remove fog or frost from the rear window.

 **REAR:** Press this button to turn the rear window defogger on or off. Be sure to clear as much snow from the rear window as possible.

The rear window defogger will turn off about 10 minutes after the button is pressed. If turned on again, the defogger will only run for about five minutes before turning off. If you maintain a speed above 30 mph (48 km/h), the rear defogger will not turn off automatically to help keep the rear glass clear. The defogger can also be turned off by pressing the button again or by turning off the engine.

If your vehicle has outside heated mirrors, the mirrors will heat to help clear fog or frost from the surface of the mirror when the rear window defogger button is pressed.

**Notice:** Using a razor blade or sharp object to clear the inside rear window may damage the rear window defogger. Repairs would not be covered by your warranty. Do not clear the inside of the rear window with sharp objects.

## Outlet Adjustment

Use the knob located in the center of each outlet to change the direction of the airflow. Use the thumbwheel located between the outlets to turn them on and off.

In vehicles equipped with rear seat outlets, you can adjust the direction of the airflow using the knob in the center of each outlet. Use the thumbwheel located between the outlets to turn them on and off.

## Operation Tips

- Clear away any ice, snow or leaves from the air inlets at the base of the windshield that may block the flow of air into your vehicle.
- Use of non-GM approved hood deflectors may adversely affect the performance of the system.
- Keep the path under the front seats clear of objects to help circulate the air inside of your vehicle more effectively.

## Climate Controls Personalization

If your vehicle is equipped with this feature, up to two drivers are able to store and recall climate control settings for the temperature, the fan speed and the direction of the airflow.

Memory buttons 1 and 2 are located on the driver's door panel and correspond to the numbers 1 or 2 found on the back of each remote keyless entry transmitter.

To store settings, do the following:

1. Select the desired temperature, fan speed and airflow mode. If desired, a separate temperature setting may also be selected for the front seat passenger. For information on how to do this, see *Automatic Climate Control System on page 3-28*.
2. Locate memory buttons 1 and 2 on the driver's door panel.
3. Press the memory button on the door panel that corresponds to the number on the back of the transmitter you are programming, until you hear two beeps. The beeps confirm that your selection has been saved and can now be recalled. For more information on the memory feature, see *Memory Seat and Mirrors on page 2-46*.

Follow these steps each time you want to change the stored settings.

To recall the climate control settings last stored on your transmitter, press the unlock button on your remote keyless entry transmitter and put the ignition in ACC or ON.



## Warning Lights, Gages, and Indicators

This part describes the warning lights and gages that may be on your vehicle. The pictures will help you locate them.

Warning lights and gages can signal that something is wrong before it becomes serious enough to cause an expensive repair or replacement. Paying attention to your warning lights and gages could also save you or others from injury.

Warning lights come on when there may be or is a problem with one of your vehicle's functions. As you will see in the details on the next few pages, some warning lights come on briefly when you start the engine just to let you know they are working. If you are familiar with this section, you should not be alarmed when this happens.

Gages can indicate when there may be or is a problem with one of your vehicle's functions. Often gages and warning lights work together to let you know when there is a problem with your vehicle.

When one of the warning lights comes on and stays on when you are driving, or when one of the gages shows there may be a problem, check the section that tells you what to do about it. Please follow this manual's advice. Waiting to do repairs can be costly — and even dangerous. So please get to know your warning lights and gages. They are a big help.

Your vehicle may also have a DIC that works along with the warning lights and gages. See *Driver Information Center (DIC)* on page 3-59.

The volume of your vehicle's warning chimes can be adjusted. For information see *Chime Level Adjustment* on page 3-103.

## Instrument Panel Cluster

The instrument panel clusters are designed to let you know at a glance how your vehicle is running. You will know how fast you are going, how much fuel you are using, and many other things you will need to drive safely and economically.

Your vehicle is equipped with one of these instrument panel clusters, which includes indicator warning lights and gages that are explained on the following pages.

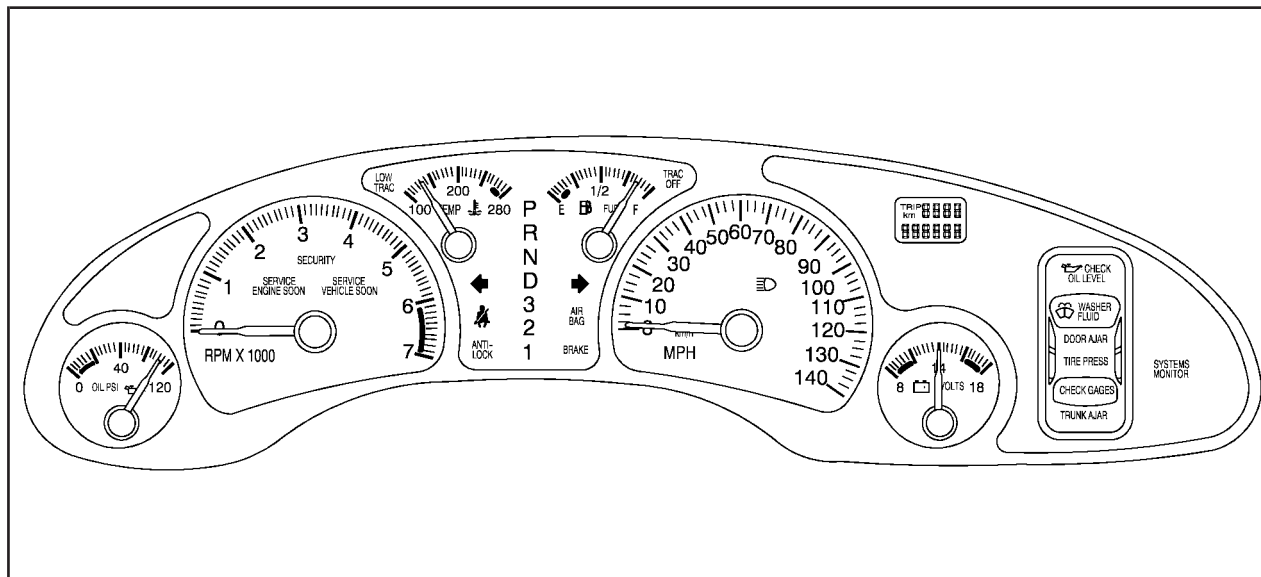

**3.8L V6 Engine Standard Cluster (United States version shown, Canada similar)**

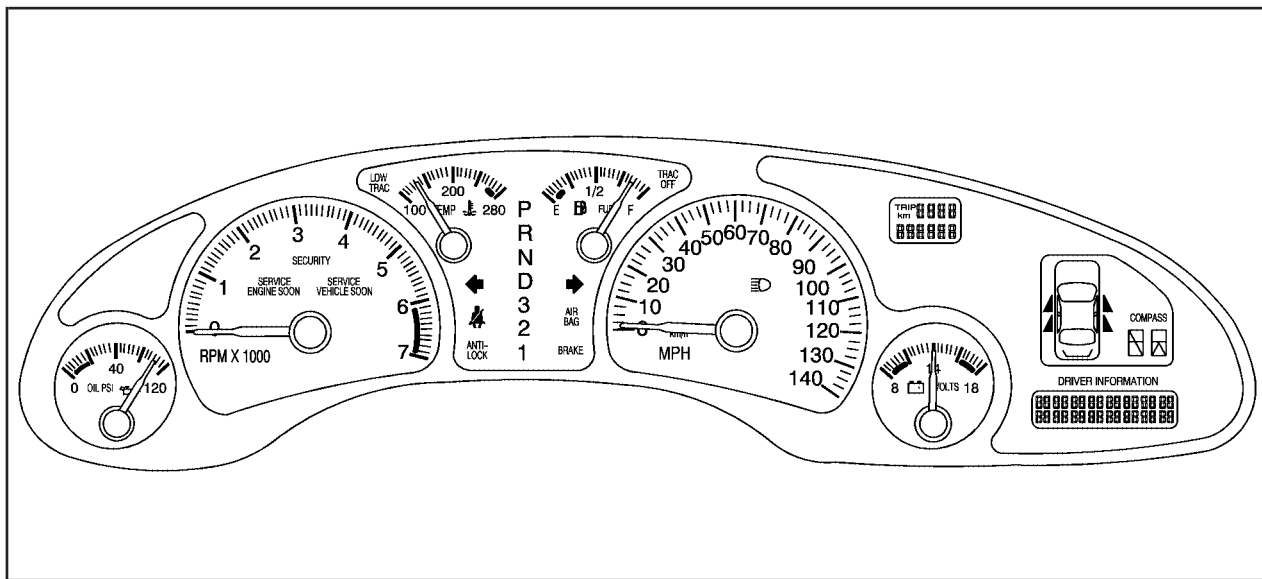

**3.8L V6 Engine Cluster with Driver Information Center (DIC) (United States version shown, Canada similar)**

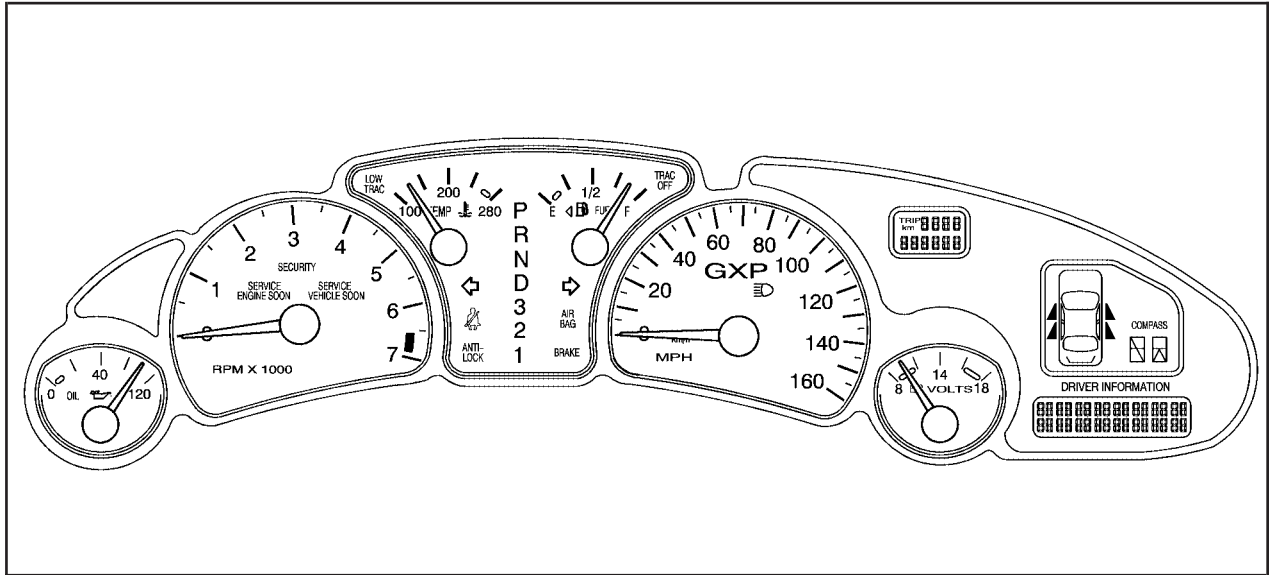

4.6L V8 Engine Cluster with Driver Information Center (DIC) (United States version shown, Canada similar)

## Speedometer and Odometer

Your speedometer lets you see your speed in miles per hour (mph) or kilometers per hour (km/h). Your odometer shows how far your vehicle has been driven, in either miles, used in the United States, or kilometers, used in Canada.

Your vehicle is equipped with a tamper resistant odometer. If you see ERROR displayed, you will know that someone has probably tried to turn it back.

You may wonder what happens if your vehicle needs a new odometer installed. If the new one can be set to the mileage total of the old odometer, then it must be. But if it cannot, then it is set at zero and a label must be put on the driver's door to show the old mileage reading when the new odometer was installed.

## Trip Odometer

The trip odometer can tell you how far you have driven since you last reset it.

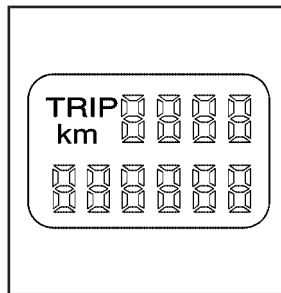

To set it to zero, press the trip reset button next to the instrument panel cluster on the right side.

## Tachometer

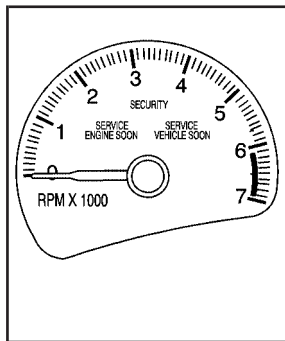

**V6 Engine**

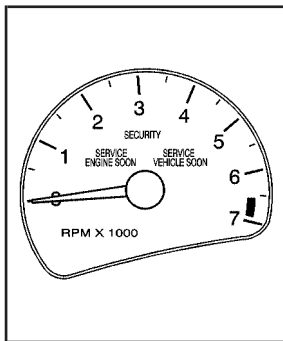

**V8 Engine**

The tachometer shows your engine speed in revolutions per minute (rpm).

## Safety Belt Reminder Light

When the key is turned to ON or START, a chime will come on for several seconds to remind people to fasten their safety belts.



The safety belt light will also come on and stay on for several seconds, then flash for several more.

If the driver's belt is already buckled, the light will come on briefly, but the chime will not sound.

## Airbag Readiness Light

There is an airbag readiness light on the instrument panel, which shows airbag or the airbag symbol. The system checks the airbag's electrical system for malfunctions. The light tells you if there is an electrical problem. The system check includes the airbag sensors, the airbag modules, the wiring and the crash sensing and diagnostic module. For more information on the airbag system, see *Airbag System on page 1-47*.

**AIR  
BAG**

**United States and V6 in  
Canada**

This light will come on when you start your vehicle, and it will flash for a few seconds. Then the light should go out. This means the system is ready.

If the airbag readiness light stays on after you start the vehicle or comes on when you are driving, your airbag system may not work properly. Have your vehicle serviced right away.



**Canada (V8 Only)**

**⚠ CAUTION:**

**If the airbag readiness light stays on after you start your vehicle, it means the airbag system may not be working properly. The airbags in your vehicle may not inflate in a crash, or they could even inflate without a crash. To help avoid injury to yourself or others, have your vehicle serviced right away if the airbag readiness light stays on after you start your vehicle.**

The airbag readiness light should flash for a few seconds when you turn the ignition key to ON. If the light does not come on then, have it fixed so it will be ready to warn you if there is a problem.

On vehicles with the DIC, a SERVICE airbag message will be displayed when there is a problem with the airbag system. See *DIC Warnings and Messages* on page 3-62 for more information.

## Voltmeter Gage

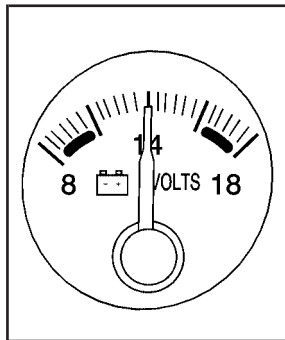

**V6 Engine**

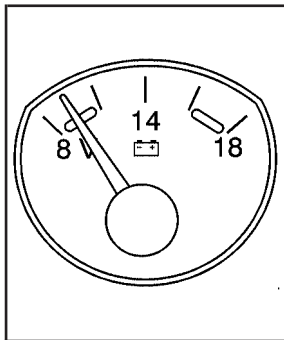

**V8 Engine**

When your engine is not running, but the ignition key is turned to ON, this gage shows the state of the battery charge in DC volts.

When the ignition is running, the gage shows the condition of the charging system. Readings between the shaded warning zones indicate the normal operating range. Readings in the shaded warning zones indicate a possible problem in the electrical system.

On vehicles with the systems monitor, the CHECK GAGES light will also come on, and a warning chime will sound if there is a problem in the electrical system. Have your vehicle serviced immediately.

On vehicles with a DIC, a CHECK CHARGE SYSTEM message will be displayed and a warning chime will sound if there is a problem in the electrical system. Have your vehicle serviced immediately. See *DIC Warnings and Messages* on page 3-62 for more information.



## Brake System Warning Light

Your vehicle's hydraulic brake system is divided into two parts. If one part is not working, the other part can still work and stop you. For good braking, though, you need both parts working well.

If the warning light comes on, there is a brake problem. Have your brake system inspected right away.



United States

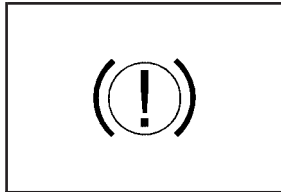

Canada

This light should come on briefly when you turn the ignition key to ON. If it does not come on then, have it fixed so it will be ready to warn you if there is a problem.

When the ignition is on, the brake system warning light will also come on when you set your parking brake. The light will stay on if your parking brake does not release fully. If you try to drive off with the parking brake set, a chime will also come on until you

release the parking brake. If the light stays on after your parking brake is fully released, it means you have a brake problem.

If you have the optional Driver Information Center (DIC), a PARK BRAKE SET message will be displayed while the parking brake is set.

If the light comes on while you are driving, pull off the road and stop carefully. You may notice that the pedal is harder to push. Or, the pedal may go closer to the floor. It may take longer to stop. If the light is still on, have the vehicle towed for service. See *Towing Your Vehicle* on page 4-34.

### CAUTION:

**Your brake system may not be working properly if the brake system warning light is on. Driving with the brake system warning light on can lead to an accident. If the light is still on after you have pulled off the road and stopped carefully, have the vehicle towed for service.**

## Anti-Lock Brake System Warning Light

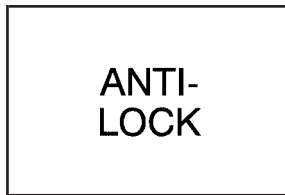

**United States**

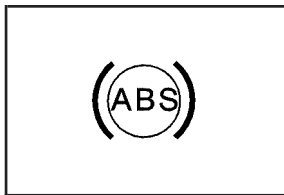

**Canada**

With the anti-lock brake system, the light(s) will come on when your engine is started and may stay on for several seconds. That is normal.

If the light stays on, turn the ignition to OFF. If the light comes on when you are driving, stop as soon as possible and turn the ignition off. Then start the engine again to reset the system. If the light still stays on, or comes on again while you are driving, your vehicle needs service. If the regular brake system warning light is not on, you still have brakes, but you do not have anti-lock brakes. If the regular brake system warning light is also on, you do not have anti-lock brakes and there is a problem with your regular brakes. See *Brake System Warning Light on page 3-41*.

The anti-lock brake system warning light will come on briefly when you turn the ignition key to ON. This is normal. If the light does not come on then, have it fixed so it will be ready to warn you if there is a problem.

## Traction Control System (TCS) Warning Light



**United States and V6 in  
Canada**

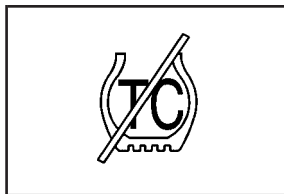

**Canada (V8 Only)**

For vehicles equipped with the traction control system, this warning light should come on briefly when the engine is started.

If the warning light does not come on then, have it fixed so it will be ready to warn you if there is a problem. If it stays on, or comes on when you are driving, there may be a problem with your traction control system and your vehicle may need service. When this warning light is on, the system will not limit wheel spin. Adjust your driving accordingly.

The traction control system warning light may come on for the following reasons:

- If you turn the system off by pressing the TRACTION CONTROL button located on the center console, the warning light will come on and stay on. To turn the system back on, press the button again. The warning light should go off. See *Traction Control System (TCS)* on page 4-8 for more information.
- If there is a brake system problem that is specifically related to traction control, the traction control system will turn off and the warning light will come on. If your brakes begin to overheat, the traction control system will turn off and the warning light will come on until your brakes cool down.
- If the traction control system is affected by an engine-related problem, the system will turn off and the warning light will come on.

If the traction control system warning light comes on and stays on for an extended period of time when the system is turned on, your vehicle needs service.

## Low Traction Active Light

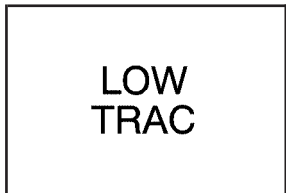

**United States and V6 in  
Canada**



**Canada (V8 Only)**

Your Low Traction Active light may come on for one of the following reasons:

- An advanced computer-controlled system called Stabilitrak<sup>®</sup>, if equipped, has come on to help your vehicle continue to go in the direction in which you are steering. This stability enhancement system activates when the computer senses that your vehicle is just starting to spin, as it might if you

hit a patch of ice or other slippery spot on the road. When the system is on, you may hear a noise or feel a vibration in the brake pedal. This is normal.

In these situations when the LOW TRAC light is on and the system is engaged, you should continue to steer in the direction you want to go. The system is designed to help you in bad weather or other difficult driving situations by making the most of whatever road conditions will permit.

- The optional Traction Control System is active and is limiting wheel spin. You may feel the system working, but this is normal. Slippery road conditions may exist, so adjust your driving accordingly.

If the LOW TRAC light comes on, slippery road conditions may exist, so you should consider slowing down and adjusting your driving accordingly.

## Engine Coolant Temperature Gage (V6 Engine)

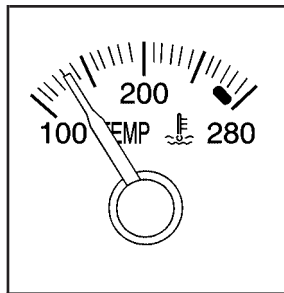

United States

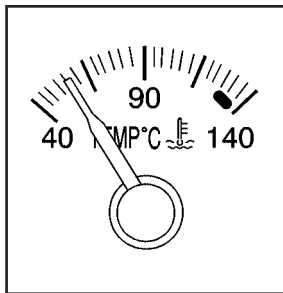

Canada

This gage shows the engine coolant temperature.

To prevent engine overheating, the air conditioning compressor will turn off automatically just prior to the gage pointer entering the shaded area. As the engine cools down, the air conditioning compressor will automatically turn back on. On vehicles equipped with the Driver Information Center (DIC), the message ENGINE HOT... A/C DISABLED will appear on the DIC display and a warning chime will sound.

If the gage pointer moves into the shaded area, your engine is too hot. On vehicles equipped with the systems monitor, the CHECK GAGES light will come on and a warning chime will sound. On vehicles with a DIC, a CHECK GAGES TEMPERATURE message will be displayed and a warning chime will sound. See *DIC Warnings and Messages* on page 3-62 for more information.

See *Engine Overheating (3.8L V6 Engine)* on page 5-36 or *Engine Overheating (4.6L V8 Engine)* on page 5-38, for information on what to do if your engine overheats.

## Engine Coolant Temperature Gage (V8 Engine)

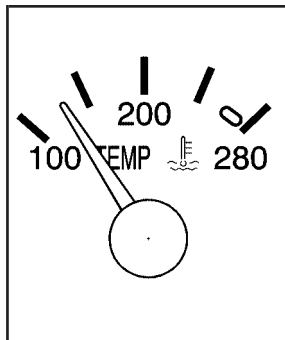

United States

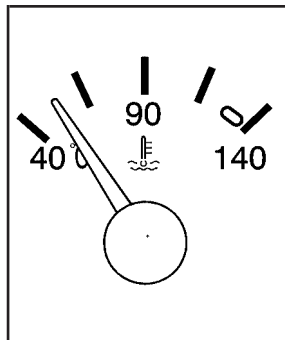

Canada

This gage shows the engine coolant temperature.

To prevent engine overheating, the air conditioning compressor will turn off automatically just prior to the gage pointer entering the shaded area. As the engine cools down, the air conditioning compressor will automatically turn back on. On vehicles equipped with the Driver Information Center (DIC), the message ENGINE HOT... A/C DISABLED will appear on the DIC display and a warning chime will sound.

If the gage pointer moves into the shaded area, your engine is too hot. On vehicles equipped with the systems monitor, the CHECK GAGES light will come on and a warning chime will sound. On vehicles with a DIC, a CHECK GAGES TEMPERATURE message will be displayed and a warning chime will sound. See *DIC Warnings and Messages on page 3-62* for more information.

On vehicles with a V8 engine, if the coolant temperature is above normal operating range, the message ENGINE HOT...IDLE ENGINE will appear. This means that you should reduce the engine load and speed to prevent the engine from overheating.

If an engine overheat condition exists, the message ENGINE HOT...STOP ENGINE will appear. This means that you should pull off the road, stop your vehicle, and turn off the engine as soon as possible.

See *Engine Overheating (3.8L V6 Engine) on page 5-36* or *Engine Overheating (4.6L V8 Engine) on page 5-38*, for information on what to do if your engine overheats.

Your vehicle is equipped with an Overheated Engine Protection Operating Mode, which alternates firing groups of cylinders to help prevent engine damage. See "Overheated Engine Protection Operating Mode" under *Engine Overheating (3.8L V6 Engine) on page 5-36* or *Engine Overheating (4.6L V8 Engine) on page 5-38* for more information.

If your coolant level is low, the message LOW ENGINE COOLANT will appear on the DIC. This means that you should check your coolant level as soon as possible. See *Engine Coolant (3.8L V6 Engine) on page 5-31* or *Engine Coolant (4.6L V8 Engine) on page 5-34* for more information.

## Tire Pressure Light

The check tire pressure system can alert you to a large change in the pressure of one tire.



After the system has been properly calibrated, the TIRE PRESS light will come on if a pressure difference (low pressure) is detected in one tire.

The light will stay on until you turn off the ignition or reset (calibrate) the system. See *Check Tire Pressure System on page 5-83*.

The TIRE PRESS light also comes on briefly when you turn your ignition key to START. If the light doesn't come on then, have it fixed so it will be there to tell you if the pressure in a tire is low.

If the anti-lock brake system warning light comes on, the check tire pressure system may not be working properly. See your dealer for service. Also, see *Anti-Lock Brake System Warning Light on page 3-42*.

On vehicles with the optional Driver Information Center (DIC), a CHECK TIRE PRESSURE message will appear when the system detects a pressure difference (low pressure) in one tire. See *DIC Warnings and Messages on page 3-62* for more information.

## Malfunction Indicator Lamp

### Service Engine Soon Light in the United States or With V6 Engine in Canada or Check Engine Light With V8 Engine in Canada



United States and V6 in Canada

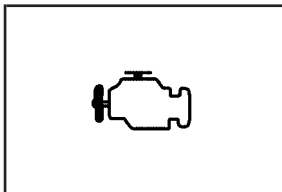

Canada (V8 Only)

Your vehicle is equipped with a computer which monitors operation of the fuel, ignition, and emission control systems.

This system is called OBD II (On-Board Diagnostics-Second Generation) and is intended to assure that emissions are at acceptable levels for the life of the vehicle, helping to produce a cleaner environment. The Service Engine Soon or Check Engine

light comes on to indicate that there is a problem and service is required. Malfunctions often will be indicated by the system before any problem is apparent. This may prevent more serious damage to your vehicle. This system is also designed to assist your service technician in correctly diagnosing any malfunction.

**Notice:** If you keep driving your vehicle with this light on, after awhile, your emission controls may not work as well, your fuel economy may not be as good, and your engine may not run as smoothly. This could lead to costly repairs that may not be covered by your warranty.

**Notice:** Modifications made to the engine, transaxle, exhaust, intake, or fuel system of your vehicle or the replacement of the original tires with other than those of the same Tire Performance Criteria (TPC) can affect your vehicle's emission controls and may cause this light to come on. Modifications to these systems could lead to costly repairs not covered by your warranty. This may also result in a failure to pass a required Emission Inspection/Maintenance test.



This light should come on, as a check to show you it is working, when the ignition is on and the engine is not running. If the light does not come on, have it repaired. This light will also come on during a malfunction in one of two ways:

- **Light Flashing** — A misfire condition has been detected. A misfire increases vehicle emissions and may damage the emission control system on your vehicle. Diagnosis and service may be required.
- **Light On Steady** — An emission control system malfunction has been detected on your vehicle. Diagnosis and service may be required.

## If the Light Is Flashing

The following may prevent more serious damage to your vehicle:

- Reducing vehicle speed
- Avoiding hard accelerations
- Avoiding steep uphill grades
- If you are towing a trailer, reduce the amount of cargo being hauled as soon as it is possible

If the light stops flashing and remains on steady, see “If the Light Is On Steady” following.

If the light continues to flash, when it is safe to do so, stop the vehicle. Find a safe place to park your vehicle. Turn the key off, wait at least 10 seconds and restart the engine. If the light remains on steady, see “If the Light Is On Steady” following. If the light is still flashing, follow the previous steps, and see your dealer for service as soon as possible.

## If the Light Is On Steady

You may be able to correct the emission system malfunction by considering the following:

Did you recently put fuel into your vehicle?

If so, reinstall the fuel cap, making sure to fully install the cap. See *Filling Your Tank on page 5-8*. The diagnostic system can determine if the fuel cap has been left off or improperly installed. A loose or missing fuel cap will allow fuel to evaporate into the atmosphere. A few driving trips with the cap properly installed should turn the light off.

Did you just drive through a deep puddle of water?

If so, your electrical system may be wet. The condition will usually be corrected when the electrical system dries out. A few driving trips should turn the light off.

Have you recently changed brands of fuel?

If so, be sure to fuel your vehicle with quality fuel. See *Gasoline Octane on page 5-5*. Poor fuel quality will cause your engine not to run as efficiently as designed. You may notice this as stalling after start-up, stalling when you put the vehicle into gear, misfiring, hesitation on acceleration, or stumbling on acceleration. (These conditions may go away once the engine is warmed up.) This will be detected by the system and cause the light to turn on.

If you experience one or more of these conditions, change the fuel brand you use. It will require at least one full tank of the proper fuel to turn the light off.

If none of the above steps have made the light turn off, your dealer can check the vehicle. Your dealer has the proper test equipment and diagnostic tools to fix any mechanical or electrical problems that may have developed.

## **Emissions Inspection and Maintenance Programs**

Some state/provincial and local governments have or may begin programs to inspect the emission control equipment on your vehicle. Failure to pass this inspection could prevent you from getting a vehicle registration.

Here are some things you need to know in order to help your vehicle pass an inspection:

Your vehicle will not pass this inspection if the Service Engine Soon or Check Engine light is on or not working properly.

Your vehicle will not pass this inspection if the OBD (on-board diagnostic) system determines that critical emission control systems have not been completely diagnosed by the system. The vehicle would be considered not ready for inspection. This can happen if you have recently replaced your battery or if your battery has run down. The diagnostic system is designed to evaluate critical emission control systems during normal driving. This may take several days of routine driving. If you have done this and your vehicle still does not pass the inspection for lack of OBD system readiness, your GM dealer can prepare the vehicle for inspection.

## Oil Pressure Gage (V6 Engine)

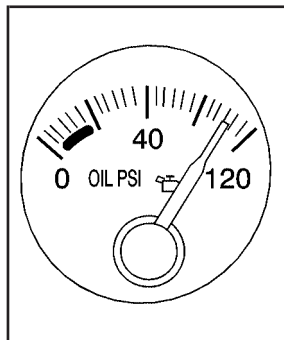

United States

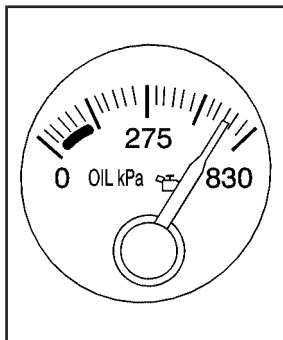

Canada

Readings above the shaded warning zone indicate the normal operating range. Oil pressure may vary with engine speed, outside temperature and oil viscosity.

A reading in the shaded warning zone may be caused by a low oil level or another problem causing low oil pressure. On vehicles with the systems monitor, the CHECK GAGES light will come on and a warning chime will sound.

On vehicles with a DIC, a CHECK GAGES OIL PRESSURE message will be displayed and a warning chime will sound. See *DIC Warnings and Messages* on page 3-62 for more information.

### CAUTION:

**Do not keep driving if the oil pressure is low. If you do, your engine can become so hot that it catches fire. You or others could be burned. Check your oil as soon as possible and have your vehicle serviced.**

**Notice:** Lack of proper engine oil maintenance may damage the engine. The repairs would not be covered by your warranty. Always follow the maintenance schedule in this manual for changing engine oil.

## Oil Pressure Gage (V8 Engine)

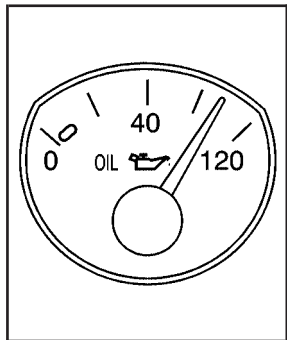

United States

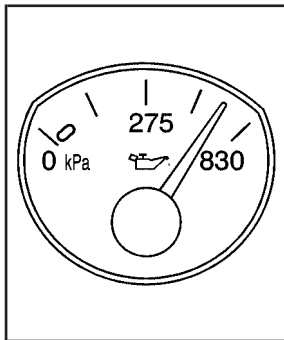

Canada

Readings above the shaded warning zone indicate the normal operating range. Oil pressure may vary with engine speed, outside temperature and oil viscosity.

A reading in the shaded warning zone may be caused by a low oil level or another problem causing low oil pressure. On vehicles with the systems monitor, the CHECK GAGES light will come on and a warning chime will sound.

On vehicles with a DIC, a CHECK GAGES OIL PRESSURE message will be displayed and a warning chime will sound. See *DIC Warnings and Messages* on page 3-62 for more information.

### CAUTION:

**Do not keep driving if the oil pressure is low. If you do, your engine can become so hot that it catches fire. You or others could be burned. Check your oil as soon as possible and have your vehicle serviced.**

**Notice:** Lack of proper engine oil maintenance may damage the engine. The repairs would not be covered by your warranty. Always follow the maintenance schedule in this manual for changing engine oil.

## Check Oil Level Light



If your vehicle has the systems monitor, the CHECK OIL LEVEL light comes on for five seconds as a bulb check each time the ignition key is turned to ON.

If the engine oil is more than 1.0 quart (0.9 L) low and the engine has been shut off for at least eight minutes, the CHECK OIL LEVEL light will come on and a chime will sound the next time you start your vehicle.

If the CHECK OIL LEVEL light comes on, the engine oil level should be checked at the dipstick then brought up to the proper level, if necessary. See *Engine Oil* on page 5-16.

On vehicles with a DIC, the OIL LEVEL LOW message will come on. See *DIC Warnings and Messages* on page 3-62 for more information.

## Security Light



**United States and V6 in  
Canada**



**Canada (V8 Only)**

This light on the instrument panel cluster reminds you to activate the theft-deterrent system when leaving your vehicle.

See *Universal Theft-Deterrent* on page 2-19 for more information.

## Highbeam On Light

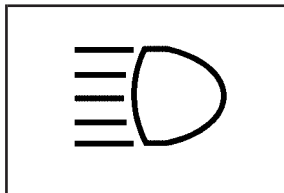

This light will illuminate when the headlamp high beams are in use.

See *Headlamp High/Low-Beam Changer* on page 3-8.

## Low Washer Fluid Warning Light

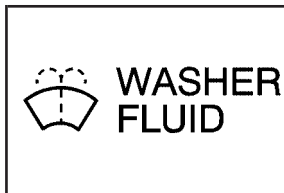

If your vehicle has the systems monitor, this light will come on and a warning chime will sound when the washer fluid container is less than one-third full.

On vehicles with a DIC, the WASHER FLUID LOW message will come on. See *DIC Warnings and Messages* on page 3-62 for more information.

## Check Gages Warning Light



If your vehicle has the systems monitor, this light will come on briefly as a bulb check when your ignition is turned to ON.

If this light comes on and stays on while you are driving, check your gages for fuel, coolant temperature, oil pressure and voltage.

## Door Ajar Light



If your vehicle has the systems monitor, this light will come on and a warning chime will sound when the driver's door or one of the passenger's doors is not completely closed.

On vehicles with a DIC, the door that is ajar will be shown as an icon next to the vehicle outline and a message will appear on the display. See *DIC Warnings and Messages on page 3-62* for more information.

## Trunk Ajar Light



If your vehicle has the systems monitor, this light will come on and a warning chime will sound when the trunk is not completely closed.

On vehicles with a DIC, the TRUNK AJAR message will come on. See *DIC Warnings and Messages on page 3-62* for more information.

## Service Vehicle Soon Light



**United States and V6 in  
Canada**

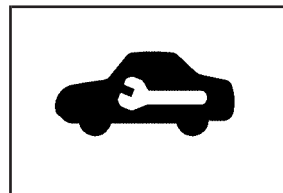

**Canada (V8 Only)**

If your vehicle has this feature, this light will come on briefly as a bulb check when your ignition is turned to ON.

This light will come on and a warning chime will sound if you have certain non-emissions related vehicle problems. These problems may not be so obvious and may not affect vehicle performance or durability. Consult a qualified dealership for necessary repairs to maintain top vehicle performance.

## Fuel Gage (V6 Engine)

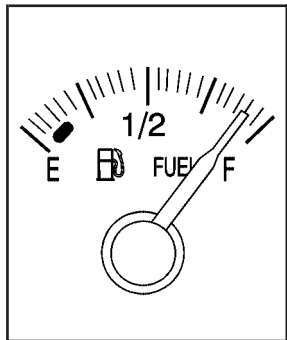

United States

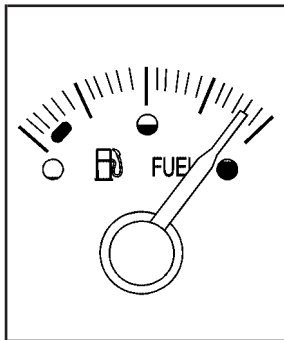

Canada

When the ignition is on, your fuel gage tells you about how much fuel you have in your tank.

When the gage reads in the colored band, a warning chime will sound and the CHECK GAGES warning light will come on. You still have a little fuel left, but you need to get more fuel right away.

On vehicles with a DIC, the CHECK GAGES LOW FUEL message will be displayed when the fuel gage reads in the yellow band. See *DIC Warnings and Messages on page 3-62* for more information.

Here are some things that owners ask about. None of these show a problem with your fuel gage:

- At the service station, the gas pump shuts off before the gage reads full.
- It takes a little more, or less, fuel to fill up than the gage indicated. For example, the gage may have indicated the tank was half full, but it actually took a little more, or less, than half the tank's capacity to fill the tank.



## Fuel Gage (V8 Engine)

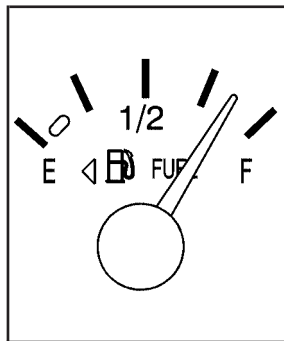

United States

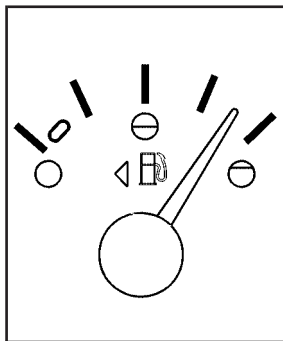

Canada

When the ignition is on, your fuel gage tells you about how much fuel you have in your tank.

When the gage reads in the colored band, a warning chime will sound and the CHECK GAGES warning light will come on. You still have a little fuel left, but you need to get more fuel right away.

On vehicles with a DIC, the CHECK GAGES LOW FUEL message will be displayed when the fuel gage reads in the yellow band. See *DIC Warnings and Messages* on page 3-62 for more information.

Here are some things that owners ask about. None of these show a problem with your fuel gage:

- At the service station, the gas pump shuts off before the gage reads full.
- It takes a little more (or less) fuel to fill up than the gage indicated. For example, the gage may have indicated the tank was half full, but it actually took a little more (or less) than half the tank's capacity to fill the tank.

# Systems Monitor

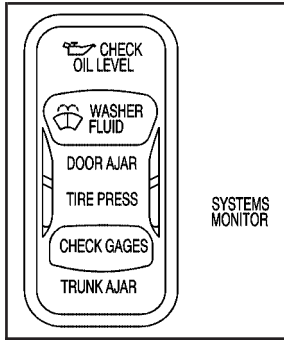

If you have the systems monitor, it gives you important safety and maintenance facts about your vehicle.

When you turn the ignition on, the systems monitor and warning lights will briefly light up. If a problem is detected, the warning lights will turn on and a chime will sound.

The following warning lights are displayed in the systems monitor:

- **CHECK OIL LEVEL:** This message could mean your oil level is low. If it comes on for more than five seconds, see *Check Oil Level Light on page 3-53*.
- **WASHER FLUID:** This message means your washer fluid tank is less than about 30 percent full. If this light comes on, see *Low Washer Fluid Warning Light on page 3-54*.
- **DOOR AJAR:** This message means that either the driver's door or one of the passenger's doors is not completely closed. If this light comes on, see *Door Ajar Light on page 3-54*.
- **TIRE PRESS:** This message means one or more of your tires may be low. See *Check Tire Pressure System on page 5-83*.
- **CHECK GAGES:** This means one or more of your gages may be in their respective warning bands. If this light comes on, see *Check Gages Warning Light on page 3-54*.
- **TRUNK AJAR:** This message means your trunk is not completely closed.



The following buttons are on the systems monitor control panel which is located to the right of the instrument panel cluster:

- **E/M (English/Metric):** Use this button to change the display between English and metric units.

- **TRIP RESET:** This button allows you to reset your trip odometer. To reset the trip odometer, press the TRIP RESET button. The trip odometer will now accumulate miles (kilometers) until the next reset.
- **TIRE PRESS RESET:** This button allows you to reset the check tire pressure system. To reset the system or for more information, see *Check Tire Pressure System on page 5-83*.

## Driver Information Center (DIC)

Your vehicle may have a Driver Information Center (DIC). The DIC will display information about how your vehicle is functioning, as well as warning messages if a system problem is detected.

## DIC Controls and Displays

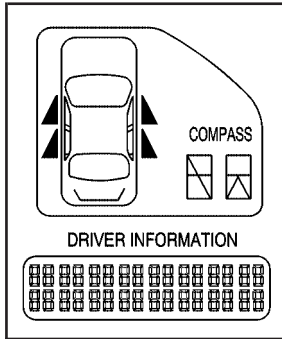

Base model shown,  
GXP model similar

When you turn the ignition on, the DIC will display your DRIVER NUMBER. You can have your dealer program your name to replace the driver identifier. See your GM dealer for more information.

The system will then perform a status check and display any messages if a problem is detected. If there are no problems detected, the display will return to the mode selected by that driver the last time the ignition was turned off.

If a problem is detected, a diagnostic message will appear in the display. The message center is continuously updated with the vehicle's performance status.

The following information will show the messages you may see on the DIC display.



The following buttons are on the DIC control panel which is located to the right of the instrument panel cluster:

**E/M (English/Metric):** This button allows you to change the display between English and metric units.

**TRIP RESET:** This button allows you to reset your trip odometer. To reset the trip odometer, press the TRIP RESET button. The trip odometer will now accumulate miles (kilometers) until the next reset.

**MODE:** This button allows you to toggle through the DIC modes (Vehicle Data, Personalization Programming, Compass Calibration).

**SELECT:** This button allows you to select a DIC mode.

**RESET:** This button, when used along with other buttons, will allow you to reset system functions.

## Vehicle Data

**Average Fuel Economy:** Press the SELECT button until the display shows AVG FUEL ECONOMY. Average fuel economy is viewed as a long term approximation of your overall driving conditions. To learn the average fuel economy from a new starting point, press the RESET button for five seconds while the average fuel economy is displayed on the DIC.

**Instantaneous Fuel Economy:** Press the SELECT button until the display shows INST FUEL ECONOMY. Instantaneous fuel economy varies with your driving conditions, such as acceleration, braking and the grade of the road being traveled. The RESET button does not function in this mode.

**Fuel Range:** Press the SELECT button until the display shows FUEL RANGE. The fuel range will calculate the remaining distance you can drive without refueling. This calculation is based on the average fuel economy for the last 25 miles (40.25 km) driven and the fuel

remaining in the fuel tank. If the fuel range drops below 40 miles (64.4 km), the display will show FUEL RANGE LOW. The RESET button does not function in this mode.

**Fuel Used:** Press the SELECT button until the display shows FUEL USED. The value indicates how much fuel has been used since the last reset. Do not confuse fuel used with the amount of fuel in your tank. To learn how much fuel will be used from a specific starting point, press the RESET button for five seconds while the fuel used is displayed on the DIC.

**Engine Oil Life System:** Press the SELECT button until OIL LIFE appears in the display. The OIL LIFE NORMAL display will show an estimate of the oil's remaining useful life. When the oil life index is less than 10%, an ENGINE OIL CHANGE SOON message will be displayed and the oil life display will show OIL LIFE CHANGE. When the ENGINE OIL CHANGE SOON message is displayed, it means that service is required for your vehicle. See your GM dealer.

In addition to the engine oil life system monitoring the oil life, additional maintenance is recommended in the Maintenance Schedule in this manual. See *Part A: Scheduled Maintenance Services on page 6-4* and *Engine Oil on page 5-16* for more information.

When you have the oil changed according to the maintenance schedule, you will have to reset the engine oil life system. To reset the engine oil life system, see “How to Reset the Engine Oil Life System” under *Engine Oil Life System on page 5-20*.

**Tire Pressure Status:** Press the SELECT button until TIRE PRESSURE appears in the display. TIRE PRESSURE NORMAL is displayed when the Check Tire Pressure System believes your vehicle's tire pressures are normal. If a potential problem is detected, the display will show CHECK TIRE PRESSURE and the tire pressure status will show TIRE PRESSURE LOW. If you see the CHECK TIRE PRESSURE message, you should stop as soon as you can and check all your tires for damage. If a tire is flat, see *If a Tire Goes Flat on page 5-92*. Also check the tire pressure in all four tires as soon as you can. See *Inflation - Tire Pressure on page 5-80* and *Check Tire Pressure System on page 5-83*.

## DIC Warnings and Messages

Other messages or warnings may appear in the DIC display. For Canadian drivers, in addition to the DIC message your DIC will display EXP with a number after it which reflects the following messages:

EXP (Export ID)	Warning Message
6	TRANSMISSION HOT IDLE ENGINE**
9	CHECK GAGES VOLT
11	CHECK GAGES LOW FUEL
15	LOW ENGINE COOLANT**
16	ENGINE HOT A/C DISABLED
20	TURN SIGNAL ON?
24	TRUNK AJAR
25	WASHER FLUID LOW
27	BATTERY SAVER ACTIVE
32	ENGINE HOT IDLE ENGINE**
33	STARTING DISABLED — THEFT*
34	SERVICE THEFT SYSTEM
35	CHECK GAGES OIL PRESSURE*
36	OIL LEVEL LOW
37	BRAKE FLUID LOW*
40	ALARM OCCURRED
44	CHECK GAGES TEMPERATURE*

EXP (Export ID)	Warning Message
54	SERVICE STABILITY SYSTEM
55	STABILITY SYSTEM ACTIVE
61	CHECK GAS CAP
81	ENGINE OIL CHANGE SOON
83	SERVICE AIR BAG
102	CHECK CHARGE SYSTEM
111	ENGINE HOT STOP ENGINE**
140	DRIVER DOOR AJAR
141	FRONT PASSENGER DOOR AJAR
142	LEFT REAR DOOR AJAR
143	RIGHT REAR DOOR AJAR
144	CHECK TIRE PRESSURE
147	PARK BRAKE SET*
The EXP codes are used to make translation from English to other languages easier.	
Pressing any of the DIC control buttons will remove the above messages or warnings from the DIC display, unless noted by an asterisk (*).	
Messages followed by a double asterisk (**) only apply to vehicles with the 4.6L V8 engine.	

**SERVICE STABILITY SYSTEM – 54:** If you ever see the SERVICE STABILITY SYSTEM message, it means there may be a problem with your stability enhancement system. If you see this message, try to reset the system: stop, turn off the engine, then start the engine again. If the SERVICE STABILITY SYSTEM message still comes on, it means there is a problem. You should see your GM dealer for service. Reduce your speed and drive accordingly.

**STABILITY SYSTEM ACTIVE – 55:** You may see the STABILITY SYSTEM ACTIVE message on the Driver Information Center. It means that an advanced, computer-controlled system has come on to help your vehicle continue to go in the direction in which you are steering. This stability enhancement system activates when the computer senses that your vehicle is just starting to spin, as it might if you hit a patch of ice or other slippery spot on the road. When the system is on, you may hear a noise or feel a vibration in the brake pedal. This is normal.

When the STABILITY SYSTEM ACTIVE message is on, you should continue to steer in the direction you want to go. The system is designed to help you in bad weather or other difficult driving situations by making the most of whatever road conditions will permit. If the STABILITY SYSTEM ACTIVE message comes on, you will know that something has caused your vehicle to start to spin, so you should consider slowing down.

**Tire Pressure Status – 144:** If you see the CHECK TIRE PRESSURE message, you should stop as soon as you can and check all your tires for damage. If a tire is flat, see *If a Tire Goes Flat on page 5-92*. Also check the tire pressure in all four tires as soon as you can. See *Inflation - Tire Pressure on page 5-80* and *Check Tire Pressure System on page 5-83*.

## Driver Identifier DIC Display

This feature allows two different drivers to store and recall their own preferred display mode. The personalization settings displayed on the DIC are determined by the remote keyless entry transmitter used to enter the vehicle. After the unlock button on the remote keyless entry transmitter (if equipped) is pressed and the ignition is in ON, the DIC will display the identified driver. The settings can also be changed by briefly pressing one of the memory buttons located on the driver's door.

The DIC is used to program information for DRIVER #1 and DRIVER #2. The DIC will identify a person as UNKNOWN DRIVER if neither DRIVER #1 nor DRIVER #2 is identified by the system.

## DIC Vehicle Personalization

The DIC can be used to program the following personalization features available with your vehicle:

- Automatic Door Locks
- Window Lock Out
- Security Feedback
- Delayed Locking
- Perimeter Lighting
- Memory Seats
- Outside Curb View Assist Mirror
- Driver ID

The DIC is used to program the personal choices of two drivers. The drivers are recognized as DRIVER #1 and DRIVER #2. You will let the DIC know which driver you are by using your remote keyless entry transmitter or by pressing the appropriate memory seat control button located on the driver's door or by choosing the driver with the DIC. Each remote keyless entry transmitter was preprogrammed to belong to DRIVER #1 or DRIVER #2. Each remote keyless entry transmitter may be programmed differently.



When you press the unlock button on your remote keyless entry transmitter, the DIC will change driver numbers and the vehicle will recall the personalization settings that were last made to correspond to your remote keyless entry transmitter, including your radio and climate control settings. See *Climate Controls Personalization on page 3-32*.

If you unlock the vehicle using your door key instead of your remote keyless entry transmitter, the DIC will not change drivers and will recall the information from the last remote keyless entry transmitter used or the last driver change using the memory seat controls. If this happens and you were not the last driver of the vehicle, press your correct driver number on the memory seat controls or press the unlock button on your remote keyless entry transmitter or select the personalization programming mode and choose the correct driver number.

Use the following steps for personalization programming instructions.

1. Turn the ignition on and keep the transaxle in PARK (P).
2. Press the MODE button to reach personalization programming display.
3. Press the SELECT button to enter personalization programming mode.

4. The first choice to be made will be DRIVER ID 1 or 2. Press the RESET button to toggle between your selections within a display and press the SELECT button to choose the current selection and move on to the next personalization feature.

You are now in the selection mode and the DIC is ready to program your personal choices in memory.

Each feature that can be personalized will appear in the display. Once you have made a selection for a feature, the DIC will move on to the next personalization feature.

Scroll through the following messages and feature options:

- AUTO DOOR LOCKS – OFF/ON
- UNLOCK – OFF/ON
- UNLOCK – KEY OFF/PARK
- DOOR TO UNLOCK – DRIVER/ALL
- WINDOW LOCKOUT – R + PASS/REAR
- KEYLESS FEEDBACK – OFF/ON
- LIGHTS FEEDBACK – OFF/ON
- HORN FEEDBACK – OFF/ON
- DELAYED LOCKING – OFF/ON
- PERIMETER LIGHTS – OFF/ON

- PERIMETER LIGHTS – TIMEOUT 15 SEC
- SEAT RECALL – OFF/ON
- RECALL POSITION – MEMORY/EXIT
- TILT MIRROR – OFF/ON
- DRIVER ID – OFF/ON

If you would like to exit the selection mode without moving through each of the personalization features, press a different button on the DIC or turn off the ignition. The personal choices you made will still be retained, even without passing through each of the features. In order for your personal choices to save, you must press SELECT after making your selections.

If you happen to move past a selection you would like to make a personal choice for, press unlock on your remote keyless entry transmitter or press the appropriate driver number on the memory seat control. This will return you to the beginning of the option feature programming mode.

A description of each feature programmable through the DIC follows.

## Automatic Door Locks

The door lock modes when shifting in and out of PARK (P), can be changed through the DIC. You can change these modes using different selections of the following DIC displays:

- AUTO DOOR LOCKS – OFF/ON
- UNLOCK – OFF/ON
- UNLOCK – KEY OFF/PARK
- DOOR TO UNLOCK – DRIVER/ALL

If you choose OFF for AUTO DOOR LOCKS, your door locks will operate normally with no automatic feature.

If you choose ON for AUTO DOOR LOCKS, ON for UNLOCK and KEY OFF, your doors will lock every time you shift out of PARK (P), and the doors will unlock every time you stop and turn the ignition to OFF.

If you choose ON for AUTO DOOR LOCKS, ON for UNLOCK and PARK, your doors will lock every time you shift out of PARK (P), and the doors will unlock every time you stop and shift into PARK (P).

If you choose ON for AUTO DOOR LOCKS, and OFF for UNLOCK, your doors will lock every time you shift out of PARK (P), and there will be no automatic door unlock when shifting back into PARK (P).

If you choose ON for UNLOCK and DRIVER for DOOR TO UNLOCK, only the driver's door will automatically unlock when shifting into PARK (P) or turning the key to OFF.

If you choose ON for UNLOCK and ALL for DOOR TO UNLOCK, all doors will automatically unlock when shifting into PARK (P) or turning the key to OFF.

To change modes, do the following:

1. Move the arrow on the display between the selections by pressing the RESET button.
2. Once you have made your selection, press the SELECT button and your choice will be retained in memory.

See *Programmable Automatic Door Locks on page 2-12* for more information about this feature.

## Window Lock Out

The number of passenger windows locked out by the window LOCK switch can be programmed through the DIC.

If you choose R + PASS, all three passenger window switches will be inactive when the window LOCK switch is enabled.

If you choose REAR, only the two rear passenger window switches will be locked out when the window LOCK switch is enabled.

To change modes, do the following:

1. Move the arrow on the display between R + PASS and REAR by pressing the RESET button.
2. Once you have made your selection, press the SELECT button. Your choice will be retained in memory.

For more information on this feature, see "Window Lock Out" under *Power Windows on page 2-18*.

## Security Feedback

By choosing different combinations of these selections, you can choose the type of remote keyless entry transmitter activated feedback when locking and unlocking your vehicle with your remote keyless entry transmitter. Each time you make a selection by pressing the RESET button, press the SELECT button to record your choice.

- KEYLESS FEEDBACK – OFF/ON
- LIGHTS FEEDBACK – OFF/ON
- HORN FEEDBACK – OFF/ON

If you choose ON for KEYLESS FEEDBACK you will also need to choose LIGHTS and/or HORN FEEDBACK.

You can select the following modes:

- If you choose OFF for KEYLESS FEEDBACK, you will receive no security feedback when locking or unlocking your vehicle.
- If you choose ON for KEYLESS FEEDBACK and ON for LIGHTS FEEDBACK, the exterior lamps will flash twice when unlocking your vehicle and once when locking your vehicle.
- If you choose ON for KEYLESS FEEDBACK and ON for HORN FEEDBACK, your horn will chirp when locking and unlocking your vehicle.
- If you choose ON for KEYLESS, LIGHTS and HORN FEEDBACK, your exterior lamps will flash twice at the first unlock button press, your exterior lamps will flash twice and your horn will chirp once at the second unlock button press, and the exterior lamps will flash once and the horn will chirp once when locking your vehicle.

For more information on this feature, see “Security Feedback” under *Remote Keyless Entry System Operation on page 2-5*.

## Delayed Locking

The delayed locking feature, which delays the actual locking of the vehicle, can be made active or inactive through the DIC. When DELAYED LOCKING – OFF/ON appears on the display, use the RESET button to

toggle the arrow between OFF and ON. When you have made your choice, press the SELECT button to record your selection.

For more information on this feature, see *Delayed Locking on page 2-11*.

## Perimeter Lighting

When the unlock button on the remote keyless entry transmitter is pressed, the Daytime Running Lamps (DRL), parking lamps and back-up lamps will turn on if it is dark enough according to the Twilight Sentinel®.

You can control activation of this feature by choosing OFF or ON when the PERIMETER LIGHTS choice is displayed on the DIC. Make your choice by pressing the RESET button and record your choice by pressing the SELECT button. You will then be prompted to choose a TIMEOUT period.

The PERIMETER LIGHTS TIMEOUT feature can be changed to the desired setting by using the RESET button to toggle from 5 to 30 seconds. Each toggle will increase the time by five seconds. Once the desired timeout is displayed, press the SELECT button to record your choice and move on to the next personalization feature.

For more information on this feature, see *Perimeter Lighting on page 3-18*.

## Memory Seats

If your vehicle has this feature, the memory seat and mirror positions will be recalled for the identified driver when the remote keyless entry transmitter is used to enter the vehicle.

You can program this feature to be active by choosing ON when the SEAT RECALL choice appears, or inactive by choosing OFF when the SEAT RECALL choice appears on the DIC. Make your choices by pressing the RESET button and store them to memory by pressing the SELECT button.

You can also program this feature to recall your memory seat position or the exit seat position.

- **Memory Position:** Choose ON when the SEAT RECALL choice appears and then choose MEMORY when the RECALL POSITION choice appears.
- **Exit Position:** Choose ON when the SEAT RECALL choice appears and then choose EXIT when the RECALL POSITION choice appears. The seat will move when you enter the vehicle after unlocking it with a remote keyless entry transmitter. This will allow for easy entry.

For more information on this feature, see *Memory Seat and Mirrors* on page 2-46.

## Outside Curb View Assist Mirror

If your vehicle has this feature, the outside curb view assist mirror, which tips the passenger mirror while the vehicle is in REVERSE (R), can be made active or inactive through the DIC. When TILT MIRROR – OFF/ON appears on the display, use the RESET button to toggle the arrow between OFF and ON. When you have made your choice, press the SELECT button to record your selection.

For more information on this feature, see *Outside Curb View Assist Mirror* on page 2-38.

## Driver ID

This feature displays the DRIVER ID, as identified by the DIC. If this feature is ON, the DRIVER ID will be displayed every time the ignition is turned on. If the DRIVER ID is OFF, the DRIVER ID can be displayed by pressing either a button on the remote keyless entry transmitter or a memory seat button.

# Secondary Information Center (SIC)

## Electronic Compass

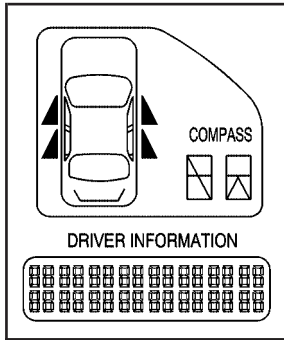

Base model shown,  
GXP model similar

If your vehicle has a Driver Information Center (DIC), it also is equipped with an electronic compass. As with all compasses, this unit senses the earth's magnetic field to show the direction the vehicle is pointing.

The earth's magnetic field is not always the same direction as true north as we know it. So, you must enter a zone number to tell the compass the difference between magnetic and actual north. This tells the compass where in the country you are driving.

The compass remembers your zone, so you only have to change it if you drive to a new zone on the map. The compass adjusts only a small amount for each zone, so you may not notice a difference if you drive from one zone to the next one, until you cross several zones.

## Choosing Your Zone Number

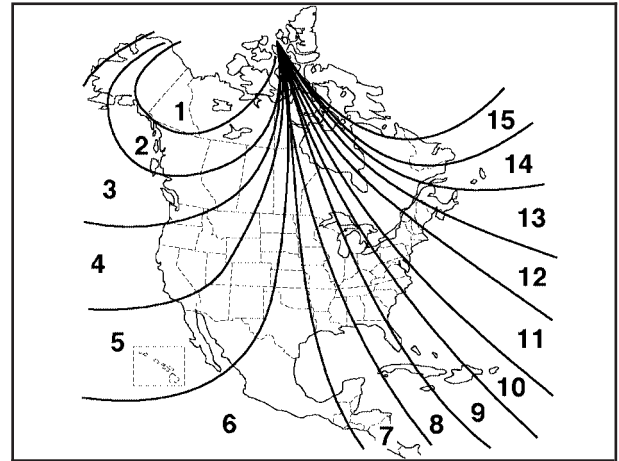

Locate your zone number on the map. If your number is different than the one shown when you turn the key on, follow the steps to change your zone number.

If you live on the line, you can pick the zone area you are most likely to drive in. In Alaska, use Zone 9 or 10. In Hawaii, use Zone 7.

## Changing Your Zone Number

1. Press MODE to display COMPASS CALIBRATION.
2. Press SELECT to display RESET CHANGES ZONE.
3. Press RESET until your number appears.
4. Press MODE to exit the COMPASS CALIBRATION MODE and store the new zone number. When the MODE button is pressed, the DIC will return to the VEHICLE DATA mode.

## Calibrating the Compass

All electronic compasses need to know the magnetic profile of your vehicle. This is called calibration and is done automatically by your compass. However, if you would like to manually calibrate the compass, the following instructions will show you how.

Sometimes, strong magnetic fields can affect the compass. If the compass display does not show a direction, and CALIBRATE COMPASS is displayed on the DIC, try calibrating the compass as follows:

1. Drive the vehicle to an open, flat area.
2. Press MODE to display COMPASS CALIBRATION.

3. Press SELECT to display PRESS RESET TO RECALIBRATE and then press the RESET button.
4. The display will change to SLOWLY DRIVE IN SMALL CIRCLES. Drive the vehicle in small circles. Do not drive faster than 10 mph (16 km/h).
5. Continue to drive in circles until the CALIBRATION COMPLETE message is displayed on the DIC and a direction is shown for the compass.

Your compass should be calibrated. You will know this when a direction is shown and the CALIBRATE COMPASS message is no longer displayed.

## Compass Accuracy

Your compass may show different headings around bridges, power lines, large metal objects and steep hills. This is normal and is true of compasses in general.

If you put large metal objects like golf clubs in the trunk, they could affect accuracy. If the affect is minimal, the compass will adapt to these objects over time.

If you use an antenna with a magnetic base, it is best to mount it away from the center of the trunk near the rear window.

The rear defog system can affect accuracy, and the compass corrects for the rear defog. However, if the rear defog is turned on while making sharp turns, the accuracy may be off. When you turn the rear defog off again, the accuracy returns to normal.

Be aware that metal objects are sometimes buried in the ground. They can affect accuracy and you may not know they are there. As an example, many concrete roads have metal reinforcements inside.

Also, if you drive with the trunk open, this could affect accuracy and could decalibrate the compass.

## Audio System(s)

**Notice:** Before adding any sound equipment to your vehicle, like a tape player, CB radio, mobile telephone, or two-way radio, make sure that it can be added by checking with your dealer. Also, check federal rules covering mobile radio and telephone units. If sound equipment can be added, it is very important to do it properly. Added sound equipment may interfere with the operation of your vehicle's engine, radio, or other systems, and even damage them. Your vehicle's systems may interfere with the operation of sound equipment that has been added improperly.

Figure out which audio system is in your vehicle, find out what your audio system can do, and how to operate all of its controls.

Your vehicle has a feature called Retained Accessory Power (RAP). With RAP, the audio system can be played even after the ignition is turned off. See *Retained Accessory Power (RAP)* on page 2-24 for more information.

## Setting the Time

Press and hold HR or MIN for two seconds. Then press and hold HR until the correct hour appears on the display. AM will appear for morning hours. Press and hold MIN until the correct minute appears on the display. The time can be set with the ignition on or off.

To synchronize the time with an FM station broadcasting Radio Data System (RDS) information, press and hold HR and MIN at the same time until UPDATED and the clock symbol appear on the display. If the time is not available from the station, NO UPDATE will appear on the display.

RDS time is broadcast once a minute. After tuning to an RDS broadcast station, it may take a few minutes for the time to update.



## Radio with CD



## Radio Data System (RDS)

The audio system has a Radio Data System (RDS). RDS features are available for use only on FM stations that broadcast RDS information.

With RDS, the radio can do the following:

- Seek to stations broadcasting the selected type of programming
- Receive announcements concerning local and national emergencies
- Display messages from radio stations
- Seek to stations with traffic announcements

This system relies upon receiving specific information from these stations and will only work when the information is available. In rare cases, a radio station may broadcast incorrect information that will cause the radio features to work improperly. If this happens, contact the radio station.

While the radio is tuned to an RDS station, the station name or call letters will appear on the display instead of the frequency. RDS stations may also provide the time of day, a program type (PTY) for current programming, and the name of the program being broadcast.

## XM™ Satellite Radio Service

XM™ is a satellite radio service that is based in the 48 contiguous United States. XM™ offers 100 coast to coast channels including music, news, sports, talk, and children's programming. XM™ provides digital quality audio and text information that includes song title and artist name. A service fee is required in order to receive the XM™ service. For more information, contact XM™ at [www.xmradio.com](http://www.xmradio.com) or call 1-800-852-XMXX (9696).

## Playing the Radio

**PWR (Power):** Push this knob to turn the system on and off.

**VOL (Volume):** Turn this knob to increase or to decrease the volume.

**RCL (Recall):** Push this knob to switch the display between the radio station frequency and the time. Push this knob to display the time with the ignition off.

For RDS, push the RCL knob to change what appears on the display while using RDS. The display options are station, RDS station frequency, PTY, and the name of the program (if available).

For XM™ (if equipped), push the RCL knob while in XM™ mode to retrieve four different categories of information related to the current song or channel: Artist, Song Title, Category or PTY, Channel Number/Channel Name.

To change the default on the display, push the RCL knob until you see the display you want, then hold the knob until the display flashes. The selected display will now be the default.

**SCV (Speed-Compensated Volume):** With SCV, the audio system adjusts automatically to make up for road and wind noise as you drive.

Set the volume at the desired level. Press this button to select MIN, MED, or MAX. Each higher setting allows for more volume compensation at faster vehicle speeds. Then, as you drive, SCV automatically increases the volume, as necessary, to overcome noise at any speed. The volume level should always sound the same to you as you drive. If you do not want to use SCV, select OFF.

## Finding a Station

**BAND:** Press this button to switch between FM1, FM2, AM, or XM1 or XM2 (if equipped). The display will show the selection.

**TUNE:** Turn this knob to select radio stations.

**△ SEEK ▽:** Press the up or the down arrow to go to the next or to the previous station and stay there.

The radio will only seek stations with a strong signal that are in the selected band.

**△ SCAN ▽:** Press and hold either SCAN arrow for two seconds until SCAN appears on the display and you hear a beep. The radio will go to a station, play for a few seconds, then go on to the next station. Press either SCAN arrow again to stop scanning.

To scan preset stations, press and hold either SCAN arrow for more than four seconds until PSCAN and the preset number appear on the display. You will hear a double beep. The radio will go to the first preset station stored on your pushbuttons, play for a few seconds, then go on to the next preset station. Press either SCAN arrow again to stop scanning presets.

The radio will only scan stations with a strong signal that are in the selected band.

## Setting Preset Stations

Up to 30 stations (six FM1, six FM2, and six AM, six XM1 and six XM2 (if equipped)), can be programmed on the six numbered pushbuttons, by performing the following steps:

1. Turn the radio on.
2. Press BAND to select FM1, FM2, AM, or XM1 or XM2.
3. Tune in the desired station.
4. Press EQ to select the equalization.
5. Press and hold one of the six numbered pushbuttons until you hear a beep. Whenever that numbered pushbutton is pressed, the station that was set will return and the equalization that was selected will be stored for that pushbutton.
6. Repeat the steps for each pushbutton.

## Setting the Tone (Bass/Treble)

**TONE:** Press and release this button until BASS, MID, or TREB appears on the display. The SELECT LED indicator will light to show that the tone control can be adjusted. Turn the SELECT knob to increase or to decrease. If a station is weak or noisy, to decrease the treble.

To return all of the tone controls to the middle position press and hold the TONE button until FLAT appears on the display.

**EQ (Equalizer):** Press this button to select customized equalization settings.

Up to six customized equalization settings, can be programmed, by performing the following steps:

1. Turn the radio on.
2. Use the TONE button and the SELECT knob to create the equalization.
3. Press and hold the EQ button for two seconds. SELECT EQ # will appear on the display and the EQ symbol will flash.
4. Press EQ or turn the SELECT knob to select the EQ number.
5. Press and hold the EQ button or push the SELECT knob to store the equalization setting and the number. EQ SAVED will appear on the display and you will hear a beep.
6. Repeat the steps for the other EQ settings and numbers.

EQ 5 has been programmed at the factory for use with talk radio, but it can be set to a different tone.

## Adjusting the Speakers (Balance/Fade)

**BAL (Balance):** To adjust the balance between the right and the left speakers, press and release this button until BAL appears on the display. The SELECT LED indicator will light to show that the speakers can be adjusted. Turn the SELECT knob to move the sound toward the right or the left speakers.

**FADE:** To adjust the fade between the front and the rear speakers, press and release this button until FADE appears on the display. The SELECT LED indicator will light to show that the speakers can be adjusted. Turn the SELECT knob to move the sound toward the front or the rear speakers.

To return all speaker settings to the middle position, press and hold the BAL FADE button for two seconds.

## Finding a Program Type (PTY) Station (RDS and XM™)

To select and find a desired PTY perform the following:

1. Press PROG TYPE to activate program type select mode. The PTY symbol will appear on the display.
2. Turn the SELECT knob to select a PTY.
3. Once the desired PTY is displayed, press either SEEK arrow to select the PTY and take you to the PTY's first station.

4. To go to another station within that PTY and the PTY is displayed, press either SEEK arrow once. If the PTY is not displayed, press either SEEK arrow twice to display the PTY and then to go to another station.
5. Press PROG TYPE to exit program type select mode.  
If PTY times out and is no longer on the display, go back to Step 1.

If both PTY and TRAF are on, the radio will search for stations with the selected PTY and traffic announcements.

**SCAN:** Scan the stations within a PTY by performing the following:

1. Press PROG TYPE to activate program type select mode. The PTY symbol will appear on the display.
2. Turn the SELECT knob to select a PTY.
3. Once the desired PTY is displayed, press and hold either SCAN arrow, and the radio will begin scanning the stations in the PTY.
4. Press either SCAN arrow to stop at a station.

If both PTY and TRAF are on, the radio will scan for stations with the selected PTY and traffic announcements.

**BAND (Alternate Frequency):** Alternate frequency allows the radio to switch to a stronger station with the same program type. To turn alternate frequency on, press and hold BAND for two seconds. AF ON will appear on the display. The radio may switch to stations with a stronger frequency.

To turn alternate frequency off, press and hold BAND again for two seconds. AF OFF will appear on the display. The radio will not switch to other stations.

This function does not apply for XM™ Satellite Radio Service.

## Setting Preset PTYs (RDS Only)

These pushbuttons have factory PTY presets. Up to 12 PTYs (six FM1 and six FM2), can be programmed on the six numbered pushbuttons, by performing the following steps:

1. Press BAND to select FM1 or FM2.
2. Press PROG TYPE to activate program type select mode. The PTY symbol will appear on the display.
3. Turn the SELECT knob to select a PTY.
4. Press and hold one of the six numbered pushbuttons until you hear a beep. Whenever that numbered pushbutton is pressed, the PTY that was set will return, if program type select mode is on.
5. Repeat the steps for each pushbutton.

## RDS Messages

**ALERT!:** Alert warns of local or national emergencies. When an alert announcement comes on the current radio station, ALERT! will appear on the display. You will hear the announcement, even if the volume is low or a CD is playing. If a CD is playing, play will stop during the announcement. Alert announcements cannot be turned off.

ALERT! will not be affected by tests of the emergency broadcast system. This feature is not supported by all RDS stations.

**INFO (Information):** If the current station has a message, INFO will appear on the display. Press this button to see the message. The message may display the artist, song title, call in phone numbers, etc.

If the entire message is not displayed, parts of the message will appear every three seconds. To scroll through the message, press and release the INFO button. A new group of words will appear on the display after every press of the button. Once the complete message has been displayed, INFO will disappear from the display until another new message is received. The last message can be displayed by pressing the INFO button. You can view the last message until a new message is received or a different station is tuned to.

**TRAF (Traffic):** If TRAF appears on the display, the tuned station broadcasts traffic announcements. Press this button to receive the traffic announcement from the station and brackets will be displayed around TRAF. When a traffic announcement comes on the tuned radio station you will hear it.

If the station does not broadcast traffic announcements, press the TRAF button and the radio will seek to a station that does. When a station that broadcasts traffic announcements is found, the radio will stop seeking and brackets will be displayed around TRAF. If no station is found that broadcasts traffic announcements, NO TRAFFIC will appear on the display.

If the brackets are on the display and TRAF is not, press the TRAF button to remove the brackets or use the TUNE knob or the SEEK arrows to go to a station that broadcasts traffic announcements. If no station is found that broadcasts traffic announcements, NO TRAFFIC will appear on the display.

The radio will play the traffic announcement if the volume is low. The radio will interrupt the play of a CD if the last tuned station broadcasts traffic announcements and the brackets are displayed.

This function does not apply to XM™ Satellite Radio Service.

## Radio Messages

**CALIBRATE:** The audio system has been calibrated for your vehicle from the factory. If CALIBRATE appears on the display, it means that the radio has not been configured properly for the vehicle and must be returned to the dealer for service.

**LOCKED:** This message is displayed when the THEFTLOCK® system has locked up. Take the vehicle to the dealer for service.

If any error occurs repeatedly or if an error cannot be corrected, contact your dealer.

## XM™ Radio Messages

Radio Display Message	Condition	Action Required
XL (Explicit Language Channels)	XL on the radio display, after the channel name, indicates content with explicit language.	These channels, or any others, can be blocked at a customer's request, by calling 1-800-852-XXXM (9696).
Updating	Updating encryption code	The encryption code in the receiver is being updated, and no action is required. This process should take no longer than 30 seconds.
No Signal	Loss of signal	The system is functioning correctly, but the vehicle is in a location that is blocking the XM signal. When you move into an open area, the signal should return.
Loading XM	Acquiring channel audio (after 4 second delay)	The audio system is acquiring and processing audio and text data. No action is needed. This message should disappear shortly.
CH Off Air	Channel not in service	This channel is not currently in service. Tune to another channel.
CH Unavail	Channel no longer available	This previously assigned channel is no longer assigned. Tune to another station. If this station was one of the presets, choose another station for that preset button.
No Info	Artist Name/Feature not available	No artist information is available at this time on this channel. The system is working properly.
No Info	Song/Program Title not available	No song title information is available at this time on this channel. The system is working properly.

## XM™ Radio Messages (cont'd)

Radio Display Message	Condition	Action Required
No Info	Category Name not available	No category information is available at this time on this channel. The system is working properly.
No Info	No Text/Informational message available	No text or informational messages are available at this time on this channel. The system is working properly.
Not Found	No channel available for the chosen category	There are no channels available for the selected category. The system is working properly.
XM Locked	Theft lock active	The XM receiver in the vehicle may have previously been in another vehicle. For security purposes, XM receivers cannot be swapped between vehicles. If this message is received, after having your vehicle serviced, check with your dealer.
Radio ID	Radio ID label (channel 0)	If tuned to channel 0, this message will alternate with the XM Radio 8 digit radio ID label. This label is needed to activate the service.
Unknown	Radio ID not known (should only be if hardware failure)	If this message is received when tuned to channel 0, there may be a receiver fault. Consult with your dealer.
Chk XMRCvr	Hardware failure	If this message does not clear within a short period of time, the receiver may have a fault. Consult with your dealer.



## Playing a CD

Insert a CD partway into the slot, label side up. The player will pull it in and the CD should begin playing. If you want to insert a CD when the ignition is off, first press the eject symbol or push the RCL knob. If you insert a CD with the radio off and the ignition on, it will start to play.

If the ignition or radio is turned off with a CD in the player, it will stay in the player. When the ignition or radio is turned on, the CD will start playing where it stopped, if it was the last selected audio source.

When the CD is inserted, the CD symbol will appear on the display. As each new track starts to play, the track number will appear on the display.

The CD player can play the smaller 3 inch (8 cm) single CDs with an adapter ring. Full-size CDs and the smaller CDs are loaded in the same manner.

If playing a CD-R the sound quality may be reduced due to CD-R quality, the method of recording, the quality of the music that has been recorded, and the way the CD-R has been handled. There may be an increase in skipping, difficulty in finding tracks, and/or difficulty in loading and ejecting. If these problems occur try a known good CD.

Do not add paper labels to CDs, they could get caught in the CD player.

If an error appears on the display, see “CD Messages” later in this section.

**▶▶ 1 (Forward):** Press and hold this pushbutton to advance quickly within a track. You will hear sound at a reduced volume. Release the pushbutton to play the passage. The elapsed time of the track will appear on the display.

**RDM 3 (Random):** Press this pushbutton to hear the tracks in random, rather than sequential, order. RDM and the track number will appear on the display. Press RDM again to turn off random play.

**◀◀ (Reverse):** Press and hold this pushbutton to reverse quickly within a track. You will hear sound at a reduced volume. Release the pushbutton to play the passage. The elapsed time of the track will appear on the display.

**EQ (Equalizer):** Press EQ to select an equalization setting while playing a CD. The equalization will be set whenever a CD is played. See “EQ” listed previously for more information. If you select an EQ setting for your CD, it will be activated each time you play a CD.

**△ SEEK ▽ :** Press the down arrow to go to the start of the current track if more than eight seconds have played. Press the up arrow to go to the next track. If either arrow is held or pressed more than once, the player will continue moving backward or forward through the CD.

**△ SCAN ▽**: Press and hold either arrow for more than two seconds until SCAN and the track number appear on the display and you hear a beep. The CD will go to the next track, play for a few seconds, then go on to the next track. Press either arrow again to stop scanning.

**RCL (Recall)**: Push this knob to see how long the current track has been playing. To change the default on the display, track and elapsed time, push the knob until you see the display you want, then hold the knob until the display flashes. The selected display will now be the default. While elapsed time is showing, CD TIME will appear on the display.

**BAND**: Press this button to listen to the radio when a CD is playing. The inactive CD will remain safely inside the radio for future listening.

**CD AUX (Auxiliary)**: Press this button to play a CD when listening to the radio. The CD symbol will appear on the display when a CD is loaded.

**△ (Eject)**: Press this button to eject a CD. Eject may be activated with either the ignition or radio off. CDs may be loaded with the ignition and radio off if this button is pressed first.

## CD Messages

**CHECK CD**: If this message appears on the display and/or the CD comes out, it could be for one of the following reasons:

- It is very hot. When the temperature returns to normal, the CD should play.
- You are driving on a very rough road. When the road becomes smoother, the CD should play.
- The CD is dirty, scratched, wet, or upside down.
- The air is very humid. If so, wait about an hour and try again.
- There may have been a problem while burning the CD.
- The label may be caught in the CD player.

If the CD is not playing correctly, for any other reason, try a known good CD.

If any error occurs repeatedly or if an error cannot be corrected, contact your dealer. If the radio displays an error message, write it down and provide it to your dealer when reporting the problem.

## Radio with Cassette and CD



### Radio Data System (RDS)

The audio system has a Radio Data System (RDS). RDS features are available for use only on FM stations that broadcast RDS information.

With RDS, the radio can do the following:

- Seek to stations broadcasting the selected type of programming
- Receive announcements concerning local and national emergencies
- Display messages from radio stations
- Seek to stations with traffic announcements.

This system relies upon receiving specific information from these stations and will only work when the information is available. In rare cases, a radio station may broadcast incorrect information that will cause the radio features to work improperly. If this happens, contact the radio station.

While the radio is tuned to an RDS station, the station name or call letters will appear on the display instead of the frequency. RDS stations may also provide the time of day, a program type (PTY) for current programming, and the name of the program being broadcast.

### XM™ Satellite Radio Service

XM™ is a satellite radio service that is based in the 48 contiguous United States. XM™ offers 100 coast to coast channels including music, news, sports, talk, and children's programming. XM™ provides digital quality audio and text information that includes song title and artist name. A service fee is required in order to receive the XM™ service. For more information, contact XM™ at [www.xmradio.com](http://www.xmradio.com) or call 1-800-852-XMXX (9696).

### Playing the Radio

**PWR (Power):** Push this knob to turn the system on and off.

**VOL (Volume):** Turn this knob to increase or to decrease the volume.

**RCL (Recall):** Push this knob to switch the display between the radio station frequency and the time. When the ignition is off, push this knob to display the time.

For XM™ (if equipped), push the RCL knob while in XM™ mode to retrieve four different categories of information related to the current song or channel: Artist, Song Title, Category or PTY, Channel Number/Channel Name.

To change the default on the display, push the RCL knob until you see the display you want, then hold the knob until the display flashes. The selected display will now be the default.

**SCV (Speed-Compensated Volume):** With SCV, the audio system adjusts automatically to make up for road and wind noise as you drive by increasing the volume as vehicle speed increases.

Set the volume at the desired level. Press this button to select MIN, MED or MAX. Each higher setting will provide more volume compensation at faster vehicle speeds. To turn SCV off, press this button until OFF appears on the display.

## Finding a Station

**BAND:** Press this button to switch between FM1, FM2, AM, or XM1 or XM2 (if equipped). The display will show the selection.

**TUNE:** Turn this knob to select radio stations.

**△ SEEK ▽:** Press the up or the down arrow to go to the next or to the previous station and stay there.

The radio will only seek stations with a strong signal that are in the selected band.

**△ SCAN ▽:** Press and hold either arrow for two seconds until SCAN appears on the display and you hear a beep. The radio will go to a station, play for a few seconds, then go on to the next station. Press either arrow again to stop scanning.

To scan preset stations, press and hold either SCAN arrow for more than four seconds until PSCAN and the preset number appears on the display and you will hear two beeps. The radio will go to the first preset station, play for a few seconds, then go on to the next preset station. Press either SCAN arrow again or one of the pushbuttons to stop scanning presets.

The radio will only scan stations with a strong signal that are in the selected band.

## Setting Preset Stations

Up to 30 stations (six FM1, six FM2, and six AM, six XM1 and six XM2 (if equipped)), can be programmed on the six numbered pushbuttons, by performing the following steps:

1. Turn the radio on.
2. Press BAND to select FM1, FM2, AM, or XM1, or XM2.
3. Tune in the desired station.
4. Press EQ to select the equalization.
5. Press and hold one of the six numbered pushbuttons until you hear a beep. Whenever that numbered pushbutton is pressed, the station that was set will return and the equalization that was selected will be stored for that pushbutton.
6. Repeat the steps for each pushbutton.

## Setting the Tone (Bass/Treble)

**TONE:** Press and release this button until BASS, MID or TREB appears on the display. The SELECT LED indicator will light to show that the tone control can be adjusted. Turn the SELECT knob to increase or to decrease. If a station is weak or noisy, decrease the treble.

To adjust all of the tone controls to the middle position, press and hold TONE until FLAT appears on the display.

**EQ (Equalizer):** Press this button to select customized equalization settings.

Up to six customized equalization settings, can be programmed, by performing the following steps:

1. Turn the radio on.
2. Use the TONE button and the SELECT knob to create the desired equalization.
3. Press and hold the EQ button for two seconds. SELECT EQ # will appear on the display and the EQ symbol will flash.
4. Press the EQ button or turn the SELECT knob to select the desired EQ setting number.
5. Press and hold the EQ button or push the SELECT knob to store the equalization setting and the number. EQ SAVED will appear on the display and you will hear a beep.
6. Repeat the steps for the other EQ settings and numbers.

EQ 5 has been programmed at the factory for use with talk radio, but it can be set to a different tone.

## Adjusting the Speakers (Balance/Fade)

**BAL (Balance):** Press and release this button until BAL appears on the display. The SELECT LED indicator will light to show that the balance can be adjusted. Turn the SELECT knob to move the sound toward the left or the right speakers.

**FADE:** Press and release this button until FADE appears on the display. The SELECT LED indicator will light to show that the fade can be adjusted. Turn the SELECT knob to move the sound toward the front or the rear speakers.

To adjust the balance and fade to the middle position, press and hold TONE until FLAT appears on the display.

## Finding a Program Type (PTY) Station (RDS and XM™)

To select and find a desired PTY perform the following:

1. Press the PROG TYPE button to activate program type select mode. The PTY symbol will appear on the display.
2. Turn the SELECT knob to select a PTY.
3. Once the desired PTY is displayed, press and release either SEEK arrow to select and to take you to the PTY's first station.

4. To go to another station within that PTY and the PTY is displayed, press either SEEK arrow once. If the PTY is not displayed, press either SEEK arrow twice to display the PTY and then to go to another station.
5. Press the PROG TYPE button to exit program type select mode.  
If PTY times out and is no longer on the display, go back to Step 1.

**SCAN:** Scan the stations within a PTY by performing the following:

1. Press the PROG TYPE button to activate program type select mode. The PTY symbol will appear on the display.
2. Turn the SELECT knob to select a PTY.
3. Once the desired PTY is displayed, press and hold either SCAN arrow, and the radio will begin scanning the stations in the PTY.
4. Press either SCAN arrow again to stop at a station.

**BAND (Alternate Frequency):** Alternate frequency allows the radio to switch to a stronger station with the same program type. To turn alternate frequency on, press and hold BAND for two seconds. AF ON will appear on the display. The radio may switch to stations with a stronger frequency.

To turn alternate frequency off, press and hold BAND again for two seconds. AF OFF will appear on the display. The radio will not switch to other stations.

This function does not apply for XM™ Satellite Radio Service.

## Setting Preset PTYs (RDS Only)

These buttons have factory PTY presets. Up to 12 PTYs (six FM1 and six FM2), can be programmed on the six numbered pushbuttons, by performing the following steps:

1. Press BAND to select FM1 or FM2.
2. Press the PROG TYPE button to activate program type select mode. The PTY symbol will appear on the display.

3. Turn the SELECT knob to select a PTY.
4. Press and hold one of the six numbered pushbuttons until you hear a beep. Whenever that numbered pushbutton is pressed, the PTY that was set will return.
5. Repeat the steps for each pushbutton.

## RDS Messages

**ALERT!:** Alert warns of local or national emergencies. When an alert announcement comes on the current radio station, ALERT! will appear on the display. You will hear the announcement, even if the volume is low or a cassette tape or a CD is playing. If a cassette tape or CD is playing, play will stop during the announcement. Alert announcements cannot be turned off.

ALERT! will not be affected by tests of the emergency broadcast system. This feature is not supported by all RDS stations.

**INFO (Information):** If the current station has a message, INFO will appear on the display. Press this button to see the message. The message may display the artist, song title, call in phone numbers, etc.

If the entire message is not displayed, parts of the message will appear every three seconds. To scroll through the message, press and release the INFO button. A new group of words will appear on the display after every press of this button. Once the complete message has been displayed, INFO will disappear from the display until another new message is received. The last message can be displayed by pressing the INFO button. You can view the last message until a new message is received or a different station is tuned to.

**TRAF (Traffic):** If TRAF appears on the display, the tuned station broadcasts traffic announcements and when a traffic announcement comes on the tuned radio station you will hear it.

If the station does not broadcast traffic announcements, press the TRAF button and the radio will seek to a station that does. When a station that broadcasts traffic announcements is found, the radio will stop seeking and brackets will be displayed around TRAF. If no station is found that broadcasts traffic announcements, NO TRAFFIC will appear on the display.

If the brackets are on the display and TRAF is not, press the TRAF button to remove the brackets or use the TUNE knob or the SEEK arrows to go to a station that supports traffic announcements. If no station is found that broadcasts traffic announcements, NO TRAFFIC will appear on the display.

The radio will play the traffic announcements even if the volume is low. The radio will interrupt the play of a cassette tape or CD if the last tuned station broadcasts traffic announcements.

This function does not apply to XM™ Satellite Radio Service.

## Radio Messages

**CALIBRATE:** The audio system has been calibrated for your vehicle from the factory. If CALIBRATE appears on the display, it means that the radio has not been configured properly for the vehicle and must be returned to your GM dealer for service.



## XM™ Radio Messages

Radio Display Message	Condition	Action Required
XL (Explicit Language Channels)	XL on the radio display, after the channel name, indicates content with explicit language.	These channels, or any others, can be blocked at a customer's request, by calling 1-800-852-XXXM (9696).
Updating	Updating encryption code	The encryption code in the receiver is being updated, and no action is required. This process should take no longer than 30 seconds.
No Signal	Loss of signal	The system is functioning correctly, but the vehicle is in a location that is blocking the XM signal. When you move into an open area, the signal should return.
Loading XM	Acquiring channel audio (after 4 second delay)	The audio system is acquiring and processing audio and text data. No action is needed. This message should disappear shortly.
CH Off Air	Channel not in service	This channel is not currently in service. Tune to another channel.
CH Unavail	Channel no longer available	This previously assigned channel is no longer assigned. Tune to another station. If this station was one of the presets, choose another station for that preset button.
No Info	Artist Name/Feature not available	No artist information is available at this time on this channel. The system is working properly.
No Info	Song/Program Title not available	No song title information is available at this time on this channel. The system is working properly.

## XM™ Radio Messages (cont'd)

Radio Display Message	Condition	Action Required
No Info	Category Name not available	No category information is available at this time on this channel. The system is working properly.
No Info	No Text/Informational message available	No text or informational messages are available at this time on this channel. The system is working properly.
Not Found	No channel available for the chosen category	There are no channels available for the selected category. The system is working properly.
XM Locked	Theft lock active	The XM receiver in the vehicle may have previously been in another vehicle. For security purposes, XM receivers cannot be swapped between vehicles. If this message is received after having your vehicle serviced, check with your GM dealer.
Radio ID	Radio ID label (channel 0)	If tuned to channel 0, this message will alternate with the XM Radio 8 digit radio ID label. This label is needed to activate the service.
Unknown	Radio ID not known (should only be if hardware failure)	If this message is received when tuned to channel 0, there may be a receiver fault. Consult with your GM dealer.
Chk XMRcvr	Hardware failure	If this message does not clear within a short period of time, the receiver may have a fault. Consult with your GM dealer.

## Playing a Cassette Tape

The tape player is built to work best with tapes that are up to 30 to 45 minutes long on each side. Tapes longer than that are so thin they may not work well in this player. The longer side with the tape visible should face to the right. If you hear nothing or hear a garbled sound, the tape may not be in squarely. Press the eject button to remove the tape and start over.

If the ignition and radio are off, press the eject button or the RCL knob to insert and to begin play of a tape. If the ignition is on and the radio is off, the tape can be inserted and will begin playing.

While the tape is playing, use the VOL, BAL, FADE, TONE, EQ, and SEEK controls just as you do for the radio. The display will show TAPE and an arrow showing which side of the tape is playing. The tape player will play the other side of the tape when it reaches the end.

Cassette tape adapter kits for portable CD players will work in the cassette tape player. See “CD Adapter Kits” later for more information.

The tape bias is set automatically when a metal or chrome tape is inserted.

If an error appears on the display, see “Cassette Tape Messages” later in this section.

 **1 (Forward):** Press this pushbutton to quickly advance the tape. Press this pushbutton again to return to playing speed. The radio will play while the tape advances. Select stations during forward operation by using TUNE.

While in forward mode, **FREQ** and **FWD** and two right arrows will appear on the display. If the radio is playing a RDS station, **FREQ** will appear on the display.

 **2 (Side):** Press this pushbutton to play the other side of the tape.

 **(Reverse):** Press this pushbutton to quickly reverse the tape. Press it again to return to playing speed. The radio will play while the tape reverses. You may select stations during reverse operation by using TUNE.

**EQ (Equalizer):** Press **EQ** to select the desired customized equalization setting while playing a cassette. The equalization will be set whenever a cassette tape is playing. See “EQ” listed previously for more information.

**△ SEEK ▽**: The tape must have at least three seconds of silence between each selection for seek to work. Press the up or the down arrow to search for the next or the previous selection on the tape. You can skip as many as nine selections up or down on the tape. Choose how many selections you want to skip, then press the SEEK arrow that many times. The number of selections to be skipped will appear on the display.

**△ SCAN ▽**: Press and hold one of the arrows for more than two seconds until SCAN appears on the display and you hear a beep. The tape will go to the next selection, play for a few seconds, then go on to the next selection. The tape will scan forward only. Press either arrow again to stop scanning.

**BAND**: Press this button to listen to the radio when a cassette tape or CD is playing. The inactive tape or CD will remain safely inside the radio for future listening.

**CD TAPE**: Press this button to play a cassette tape or CD when listening to the radio. The inactive tape or CD will remain safely inside the radio for future listening.

**△ (Eject)**: Press this button, located next to the cassette tape slot, to eject a tape. Eject may be activated with either the ignition or radio off. Cassette tapes may be loaded with the ignition and radio off if this button is pressed first.

## Cassette Tape Messages

If an error occurs while trying to play a cassette tape, it could be for one of the following reasons:

**TIGHT TAPE**: This message is displayed when the tape is tight and the player cannot turn the tape hubs. Remove the tape. Hold the tape with the open end down and try to turn the right hub counterclockwise with a pencil. Turn the tape over and repeat. If the hubs do not turn easily, the tape may be damaged and should not be used in the player. Try a new tape to make sure the player is working properly.

**BROKEN TAPE**: This message is displayed when the tape is broken. Try a new tape.

**WRAPPED TAPE**: This message is displayed when the tape is wrapped around the tape head. Attempt to get the cassette out. Try a new tape.

**CLEAN PLAYER**: If this message appears on the display, the cassette tape player needs to be cleaned. It will still play tapes, but it should be cleaned as soon as possible to prevent damage to the tapes and player. See *Care of Your Cassette Tape Player on page 3-101*.

If the cassette tape is not playing correctly, for any other reason, try a known good cassette.

If any error occurs repeatedly or if an error cannot be corrected, contact your GM dealer. If the radio displays an error message, write it down and provide it to your GM dealer when reporting the problem.

## CD Adapter Kits

It is possible to use a portable CD player adapter kit with the cassette tape player after disabling the tight/loose tape sensing feature on the tape player.

To disable the feature, use the following steps:

1. Turn the ignition on.
2. Turn the radio off.
3. Press and hold the CD TAPE button. READY will appear on the display and flash the cassette symbol.
4. Insert the adapter into the cassette slot. It will power up the radio and begin playing.

The override feature will remain active until the eject button is pressed.

## Playing a CD

Insert a CD partway into the slot, label side up. The player will pull it in and the CD should begin playing. If you want to insert a CD when the ignition is off, first press the eject button or push the RCL knob.

If the ignition or radio is turned off with the CD in the player, it will stay in the player. When the ignition or radio is turned on, the CD will start playing where it stopped, if it was the last selected audio source.

When a CD is inserted, the CD symbol will appear on the display. As each new track starts to play, the track number will appear on the display.

The CD player can play the smaller 3 inch (8 cm) single CDs with an adapter ring. Full-size CDs and the smaller CDs are loaded in the same manner.

If playing a CD-R the sound quality may be reduced due to CD-R quality, the method of recording, the quality of the music that has been recorded, and the way the CD-R has been handled. There may be an increase in skipping, difficulty in finding tracks, and/or difficulty in loading and ejecting. If these problems occur try a known good CD.

Do not add paper labels to CDs, they could get caught in the CD player.

If an error appears on the display, see “CD Messages” later in this section.

**▶▶ 1 (Forward):** Press and hold this pushbutton to advance quickly within a track. You will hear sound at a reduced volume. Release this pushbutton to play the passage. The elapsed time of the track will appear on the display.

**RDM 3 (Random):** Press this pushbutton to hear the tracks in random, rather than sequential, order. RDM and the track number will appear on the display. Press this pushbutton to turn off random play.

**4◀◀ (Reverse):** Press and hold this pushbutton to reverse quickly within a track. You will hear sound at a reduced volume. Release this pushbutton to play the passage. The elapsed time of the track will appear on the display.

**EQ (Equalizer):** Press EQ to select the desired customized equalization setting while playing a CD. The equalization will be set whenever a CD is played. See “EQ” listed previously for more information.

**△ SEEK ▽:** Press the down arrow to go to the start of the current track if more than eight seconds have played. Press the up arrow to go to the next track. If either arrow is held or pressed more than once, the player will continue moving backward or forward through the CD.

**△ SCAN ▽:** Press and hold either arrow for more than two seconds until SCAN and the track number appear on the display and you hear a beep. The CD will go to the next track, play for a few seconds, then go on to the next track. Press this button again to stop scanning.

**RCL (Recall):** Push this knob to see how long the current track has been playing. CD TIME and the elapsed time will appear on the display. To change the default on the display, track or elapsed time, push this knob until you see the display you want, then hold the knob until the display flashes. The selected display will now be the default.

**BAND:** Press this button to listen to the radio when a cassette tape or CD is playing. The inactive tape or CD will remain safely inside the radio for future listening.

**CD TAPE:** Press this button to play a cassette tape or CD when listening to the radio. The inactive tape or CD will remain safely inside the radio for future listening.

**△ (Eject):** Press this button, located next to the CD slot, to eject a CD. Eject may be activated with either the ignition or radio off. CDs may be loaded with the radio and ignition off if this button is pressed first.

## CD Messages

**CHECK CD:** If this message appears on the radio display and/or the CD comes out, it could be for one of the following reasons:

- You are driving on a very rough road. When the road becomes smoother, the CD should play.
- The CD is dirty, scratched, wet, or upside down.
- The air is very humid. If so, wait about an hour and try again.
- There may have been a problem while burning the CD.
- The label may be caught in the CD player.

If the CD is not playing correctly, for any other reason, try a known good CD.

If any error occurs repeatedly or if an error cannot be corrected, contact your GM dealer. If the radio displays an error message, write it down and provide it to your GM dealer when reporting the problem.

## Trunk-Mounted CD Changer



If your vehicle has the CD changer, you can play up to 12 CDs continuously. Normal size CDs may be played using the trays supplied in the magazine. The small 3 inch (8 cm) CDs can be played only with specially designed trays.

**Notice:** Placing heavy objects, which may shift or slide while driving, in the trunk could damage the CD changer. If your vehicle has the optional CD changer, do not put heavy objects in the trunk.

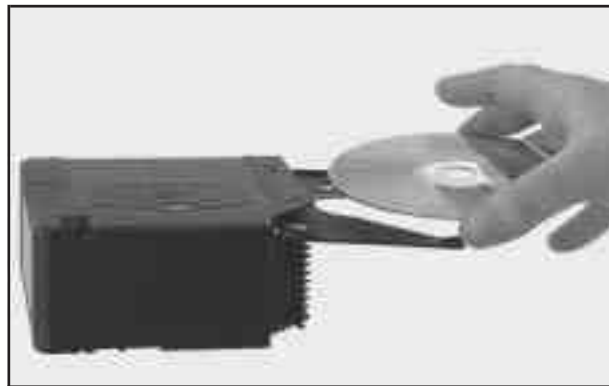

You must first load the magazine with CDs before you can play a CD. Each of the 12 trays holds one CD. Slide the button on the top of the magazine and pull gently on one of the trays. Load the trays from top to bottom, placing a CD on the tray label side up. If you load a CD label side down, the CD will not play and an error will occur. Gently push the tray back into the magazine slot until it locks into place. Repeat this procedure for loading up to 12 CDs in the magazine.



Once you have loaded the CDs in the magazine, slide open the door of the CD changer. Push the magazine into the changer in the direction of the arrow marked on top of the magazine.



Close the door by sliding it all the way to the right. When the door is closed, the changer will begin checking for CDs in the magazine. This will continue for up to one and a half minutes depending on the number of CDs loaded.

To eject the magazine from the player, slide the CD changer door all the way open. The magazine will automatically eject. Remember to keep the door closed whenever possible to keep dirt and dust from getting inside the changer.



Whenever a CD magazine with CDs is loaded in the changer and the door is closed, the CD symbol will appear on the radio display. If the CD changer is checking the magazine for CDs, the CD symbol will flash on the display until the changer is ready to play. If CD changer mode is entered during initialization, **LOADING** will appear on the display. When a CD begins playing, a CD and track number will appear on the radio display. The CD numbers are listed on the front of the magazine.

All of the CD functions are controlled by the radio buttons except for ejecting the magazine.

## Playing a CD

If an error appears on the display, see “CD Messages” later in this section.

The following radio buttons are used for the trunk-mounted CD changer.

 **1 (Forward):** Press and hold this pushbutton to quickly advance within a track. The elapsed time of the track will appear on the display.

 **2 (Next):** Press this pushbutton to select the next CD in the magazine. Each time you press this pushbutton, the CD number on the radio display will go to that of the next available CD.



**RDM 3 (Random):** Press this pushbutton to listen to the tracks on all of the CDs in random, rather than sequential, order. **RANDOM ALL** will appear on the display.

Press and hold this pushbutton to listen to the tracks on the current CD in random, rather than sequential, order. **RANDOM ONE** will appear on the display and a chime will sound. Press this pushbutton again to turn off random play.

 **4 (Reverse):** Press and hold this pushbutton to quickly reverse within a track. The elapsed time of the track will appear on the display.

**5 (Previous):** Press this pushbutton to select the previous CD in the magazine. Each time you press this pushbutton, the CD number on the radio display will go to that of the previous available CD.

**RCL (Recall):** Push this knob to see how long the current track has been playing. To change what is normally shown on the display, track or elapsed time, push this knob until you see the display you want. Then hold the knob until the display flashes.

 **SEEK**  : Press the down arrow while playing a CD to go to the start of the current track if more than eight seconds have played. Press the up arrow to go to the next track on the CD. If either arrow is held or pressed more than once, the player will continue moving backward or forward through the CD.

**△ SCAN ▽**: Press and hold either arrow for more than two seconds until TRACK SCAN appears on the display and you hear a beep. The first few seconds of each track on the current CD will play. The scan symbol will appear on the display and T will blink to indicate track scan mode. Press either arrow again, to stop scanning.

To scan all loaded CDs, press and hold either SCAN arrow for more than four seconds until CD SCAN appears on the display and you hear a double beep. The first few seconds of the first track on each CD will play. The scan symbol will appear on the display and D will blink to indicate CD scan mode. Press either SCAN arrow again, to stop scanning.

**AM FM**: Press this button to listen to the radio when a CD is playing. The inactive CD(s) will remain safely inside the radio for future listening.

**CD AUX or CD TAPE**: Press this button to play a CD, if you have a CD loaded in the changer, when listening to the radio. Press this button to switch between playing a cassette tape or CD, in the CD player, if these sources are loaded.

## CD Messages

**NO CDS**: An empty magazine is inserted in the CD changer. Try the magazine again with a CD loaded on one of the trays.

**CHECK CD**: If this message appears, it could be for one of the following reasons:

- It is very hot. When the temperature returns to normal, the CD should play.
- You are driving on a very rough road. When the road becomes smoother, the CD should play.
- The CD is dirty, scratched, wet, or upside down.
- The air is very humid. If so, wait about an hour and try again.
- There may have been a problem while burning the CD.
- The label may be caught in the CD player.

**CD DOOR OPEN:** The CD changer door is open. Completely close the door to restore normal operation.

If the CD is not playing correctly, for any other reason, try a known good CD.

If any error occurs repeatedly or if an error cannot be corrected, contact your dealer. If the radio displays an error message, write it down and provide it to your dealer when reporting the problem.

## Theft-Deterrent Feature

THEFTLOCK<sup>®</sup> is designed to discourage theft of your vehicle's radio. The feature works automatically by learning a portion of the Vehicle Identification Number (VIN). If the radio is moved to a different vehicle, it will not operate and LOCKED will appear on the display.

With THEFTLOCK<sup>®</sup> activated, the radio will not operate if stolen.

## Audio Steering Wheel Controls

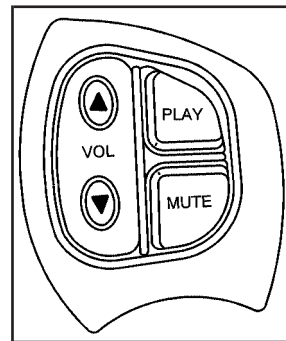
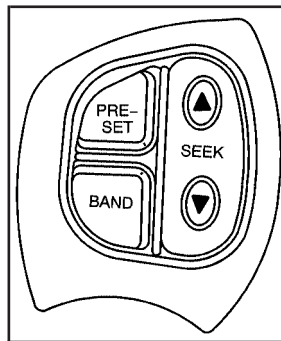

If your vehicle has this feature, some audio controls can be adjusted at the steering wheel. They include the following:

**PRESET:** Press this button to scan the stations that are programmed on the radio preset pushbuttons. The radio will go to a preset station, play for a few seconds, then go to the next station. Press this button again to stop scanning. The radio will only scan preset stations with a strong signal that are in the selected band.

When a cassette tape is playing, press this button to play the other side of the tape.

When a CD is playing in the CD changer, press this button to select the next available CD, if multiple CDs are loaded.

**BAND:** Press this button to switch between FM1, FM2, AM, or XM1 or XM2 (if equipped). The selected band will appear on the display.

When a cassette tape or CD is playing, press this button to listen to the radio. The inactive tape or CD will remain safely inside the radio for future listening.

**▲ SEEK ▼:** Press the up or the down arrow to go to the next or to the previous radio station and stay there. The radio will only seek stations with a strong signal that are in the selected band.

When a cassette tape is playing, press the up or the down arrow to go to next or the previous selection on the tape. The tape must have at least three seconds of silence between each selection for SEEK to work.

When a CD is playing, press the up arrow to go to the start of the next track. Press the down arrow to go to the start of the current track if more than eight seconds have played. If either arrow is held or pressed more than once, the CD will continue moving backward or forward through the CD.

**▲ VOL ▼ (Volume):** Press the up or the down arrow to increase or to decrease the volume.

**PLAY:** When listening to the radio, press this button to play a cassette tape or CD. The cassette tape or CD symbol will appear on the display when a tape or CD is loaded.

**MUTE:** Press this button to silence the system. Press it again, or any other radio button, to turn the sound on.

## Radio Reception

### AM

The range for most AM stations is greater than for FM, especially at night. The longer range can cause station frequencies to interfere with each other. Static can occur on AM stations caused by things like storms and power lines. Try reducing the treble to reduce this noise.

### FM Stereo

FM stereo will give the best sound, but FM signals will reach only about 10 to 40 miles (16 to 65 km). Tall buildings or hills can interfere with FM signals, causing the sound to fade in and out.

## **XM™ Satellite Radio Service**

XM™ Satellite Radio Service gives digital radio reception from coast to coast. Just as with FM, tall buildings or hills can interfere with satellite radio signals, causing the sound to fade in and out. The radio may display NO SIGNAL to indicate interference.

## **Care of Your Cassette Tape Player**

A tape player that is not cleaned regularly can cause reduced sound quality, ruined cassettes, or a damaged mechanism. Cassette tapes should be stored in their cases away from contaminants, direct sunlight, and extreme heat. If they are not, they may not operate properly or may cause failure of the tape player.

The tape player should be cleaned regularly after every 50 hours of use. The radio may display CLEAN PLAYER to indicate that the tape player has been used for 50 hours without resetting the tape clean timer. If this message appears on the display, the cassette tape player needs to be cleaned. It will still play tapes, but it should be cleaned as soon as possible to prevent damage to your tapes and player. If there is a reduction in sound quality, try a known good cassette to see if the tape or the tape player is at fault. If this other cassette has no improvement in sound quality, clean the tape player.

For best results, use a scrubbing action, non-abrasive cleaning cassette with pads which scrub the tape head as the hubs of the cleaner cassette turn. The recommended cleaning cassette is available through your dealer.

A non-scrubbing action, wet-type cleaner which uses a cassette with a fabric belt to clean the tape head can be used. This type of cleaning cassette will not eject on its own. A non-scrubbing action cleaner may not clean as thoroughly as the scrubbing type cleaner. The use of a non-scrubbing action, dry-type cleaning cassette is not recommended.

After the player is cleaned, press and hold the eject button for five seconds to reset the CLEAN PLAYER indicator. The radio will display CLEANED to show the indicator was reset.

Cassettes are subject to wear and the sound quality may degrade over time. Always make sure the cassette tape is in good condition before the tape player is serviced.

## Care of Your CDs

Handle CDs carefully. Store them in their original cases or other protective cases and away from direct sunlight and dust. If the surface of a CD is soiled, dampen a clean, soft cloth in a mild, neutral detergent solution and clean it, wiping from the center to the edge.

Be sure never to touch the side without writing when handling CDs. Pick up CDs by grasping the outer edges or the edge of the hole and the outer edge.

## Care of Your CD Player

The use of CD lens cleaners for CD players is not advised, due to the risk of contaminating the lens of the CD optics with lubricants internal to the CD mechanism.

## Diversity Antenna System

The AM-FM antennas are located in the windshield and rear window. Make sure that the inside surfaces of the windshield and rear window are not scratched and that the grid lines on the glass are not damaged. If the inside surfaces are damaged, they could interfere with radio reception.

**Notice:** Do not apply aftermarket glass tinting with metallic film. The metallic film in some tinting materials will interfere with or distort the incoming radio reception. Any damage caused to your backglass antenna due to metallic tinting materials will not be covered by your warranty.

**Notice:** Using a razor blade or sharp object to clear the inside rear window may damage the rear window antenna and/or the rear window defogger. Repairs would not be covered by your warranty. Do not clear the inside rear window with sharp objects.

If static is heard on the radio, when the rear window defogger is turned on, it could mean that a defogger grid line has been damaged. If this is true, the grid line must be repaired.

If adding an aftermarket cellular telephone to your vehicle, and the antenna needs to be attached to the glass, make sure that the grid lines for the AM-FM antennas are not damaged. Make sure the cellular telephone antenna does not touch a grid line.

## **XM™ Satellite Radio Antenna System**

The XM™ Satellite Radio antenna is located on the roof of your vehicle. Keep this antenna clear of snow and ice build up for clear radio reception.

## **Chime Level Adjustment**

The radio is the vehicle's chime producer. To change the volume level, press and hold pushbutton 6 with the ignition on and the radio power off. The chime volume level will change from the normal level to loud,

and LOUD will appear on the radio display. To change back to the default or normal setting, press and hold pushbutton 6 again. The chime level will change from the loud level to normal, and NORMAL will appear on the radio display. Removing the radio and not replacing it with a factory radio or chime will disable vehicle chimes.





## Section 4 Driving Your Vehicle

---

<b>Your Driving, the Road, and Your Vehicle</b> .....	4-2	Freeway Driving .....	4-20
Defensive Driving .....	4-2	Before Leaving on a Long Trip .....	4-21
Drunken Driving .....	4-2	Highway Hypnosis .....	4-22
Control of a Vehicle .....	4-5	Hill and Mountain Roads .....	4-22
Braking .....	4-5	Winter Driving .....	4-24
Anti-Lock Brake System (ABS) .....	4-6	If You Are Stuck: In Sand, Mud, Ice or Snow .....	4-28
Braking in Emergencies .....	4-8	Rocking Your Vehicle to Get It Out .....	4-29
Traction Control System (TCS) .....	4-8	Loading Your Vehicle .....	4-29
Steering .....	4-10	<b>Towing</b> .....	4-34
Off-Road Recovery .....	4-12	Towing Your Vehicle .....	4-34
Passing .....	4-12	Recreational Vehicle Towing .....	4-35
Loss of Control .....	4-13	Towing a Trailer (V8 Engine) .....	4-36
Driving at Night .....	4-15	Towing a Trailer (V6 Engine) .....	4-36
Driving in Rain and on Wet Roads .....	4-16		
City Driving .....	4-19		

# Your Driving, the Road, and Your Vehicle

## Defensive Driving

The best advice anyone can give about driving is: Drive defensively.

Please start with a very important safety device in your vehicle: Buckle up. See *Safety Belts: They Are for Everyone* on page 1-7.

Defensive driving really means “be ready for anything.” On city streets, rural roads, or freeways, it means “always expect the unexpected.”

Assume that pedestrians or other drivers are going to be careless and make mistakes. Anticipate what they might do. Be ready for their mistakes.

Rear-end collisions are about the most preventable of accidents. Yet they are common. Allow enough following distance. It is the best defensive driving maneuver, in both city and rural driving. You never know when the vehicle in front of you is going to brake or turn suddenly.

Defensive driving requires that a driver concentrate on the driving task. Anything that distracts from the driving task — such as concentrating on a cellular telephone call, reading, or reaching for something on the floor — makes

proper defensive driving more difficult and can even cause a collision, with resulting injury. Ask a passenger to help do things like this, or pull off the road in a safe place to do them yourself. These simple defensive driving techniques could save your life.

## Drunken Driving

Death and injury associated with drinking and driving is a national tragedy. It is the number one contributor to the highway death toll, claiming thousands of victims every year.

Alcohol affects four things that anyone needs to drive a vehicle:

- Judgment
- Muscular Coordination
- Vision
- Attentiveness

Police records show that almost half of all motor vehicle-related deaths involve alcohol. In most cases, these deaths are the result of someone who was drinking and driving. In recent years, more than 16,000 annual motor vehicle-related deaths have been associated with the use of alcohol, with more than 300,000 people injured.

Many adults — by some estimates, nearly half the adult population — choose never to drink alcohol, so they never drive after drinking. For persons under 21, it is against the law in every U.S. state to drink alcohol. There are good medical, psychological and developmental reasons for these laws.

The obvious way to eliminate the leading highway safety problem is for people never to drink alcohol and then drive. But what if people do? How much is “too much” if someone plans to drive? It is a lot less than many might think. Although it depends on each person and situation, here is some general information on the problem.

The Blood Alcohol Concentration (BAC) of someone who is drinking depends upon four things:

- The amount of alcohol consumed
- The drinker's body weight
- The amount of food that is consumed before and during drinking
- The length of time it has taken the drinker to consume the alcohol

According to the American Medical Association, a 180 lb (82 kg) person who drinks three 12 ounce (355 ml) bottles of beer in an hour will end up with a BAC of about 0.06 percent. The person would reach the

same BAC by drinking three 4 ounce (120 ml) glasses of wine or three mixed drinks if each had 1-1/2 ounces (45 ml) of liquors like whiskey, gin, or vodka.



It is the amount of alcohol that counts. For example, if the same person drank three double martinis (3 ounces or 90 ml of liquor each) within an hour, the person's BAC would be close to 0.12 percent. A person who consumes food just before or during drinking will have a somewhat lower BAC level.

There is a gender difference, too. Women generally have a lower relative percentage of body water than men. Since alcohol is carried in body water, this means that a woman generally will reach a higher BAC level than a man of her same body weight will when each has the same number of drinks.

The law in most U.S. states, and throughout Canada, sets the legal limit at 0.08 percent. In some other countries, the limit is even lower. For example, it is 0.05 percent in both France and Germany. The BAC limit for all commercial drivers in the United States is 0.04 percent.

The BAC will be over 0.10 percent after three to six drinks (in one hour). Of course, as we have seen, it depends on how much alcohol is in the drinks, and how quickly the person drinks them.

But the ability to drive is affected well below a BAC of 0.10 percent. Research shows that the driving skills of many people are impaired at a BAC approaching 0.05 percent, and that the effects are worse at night. All drivers are impaired at BAC levels above 0.05 percent. Statistics show that the chance of being in a collision increases sharply for drivers who have a BAC of

0.05 percent or above. A driver with a BAC level of 0.06 percent has doubled his or her chance of having a collision. At a BAC level of 0.10 percent, the chance of this driver having a collision is 12 times greater; at a level of 0.15 percent, the chance is 25 times greater!

The body takes about an hour to rid itself of the alcohol in one drink. No amount of coffee or number of cold showers will speed that up. "I will be careful" is not the right answer. What if there is an emergency, a need to take sudden action, as when a child darts into the street? A person with even a moderate BAC might not be able to react quickly enough to avoid the collision.

There is something else about drinking and driving that many people do not know. Medical research shows that alcohol in a person's system can make crash injuries worse, especially injuries to the brain, spinal cord, or heart. This means that when anyone who has been drinking — driver or passenger — is in a crash, that person's chance of being killed or permanently disabled is higher than if the person had not been drinking.

## CAUTION:

**Drinking and then driving is very dangerous. Your reflexes, perceptions, attentiveness, and judgment can be affected by even a small amount of alcohol. You can have a serious — or even fatal — collision if you drive after drinking. Please do not drink and drive or ride with a driver who has been drinking. Ride home in a cab; or if you are with a group, designate a driver who will not drink.**

## Control of a Vehicle

You have three systems that make your vehicle go where you want it to go. They are the brakes, the steering, and the accelerator. All three systems have to do their work at the places where the tires meet the road.

Sometimes, as when you are driving on snow or ice, it is easy to ask more of those control systems than the tires and road can provide. That means you can lose control of your vehicle. See *Traction Control System (TCS)* on page 4-8.

## Braking

Braking action involves perception time and reaction time.

First, you have to decide to push on the brake pedal. That is perception time. Then you have to bring up your foot and do it. That is reaction time.

Average reaction time is about three-fourths of a second. But that is only an average. It might be less with one driver and as long as two or three seconds or more with another. Age, physical condition, alertness, coordination and eyesight all play a part. So do alcohol, drugs and frustration. But even in three-fourths of a second, a vehicle moving at 60 mph (100 km/h) travels 66 feet (20 m). That could be a lot of distance in an emergency, so keeping enough space between your vehicle and others is important.

And, of course, actual stopping distances vary greatly with the surface of the road (whether it is pavement or gravel); the condition of the road (wet, dry, icy); tire tread; the condition of your brakes; the weight of the vehicle and the amount of brake force applied.

Avoid needless heavy braking. Some people drive in spurts — heavy acceleration followed by heavy braking — rather than keeping pace with traffic. This is a mistake. Your brakes may not have time to cool between hard stops. Your brakes will wear out much faster if you do a lot of heavy braking. If you keep pace with the traffic and allow realistic following distances, you will eliminate a lot of unnecessary braking. That means better braking and longer brake life.

If your engine ever stops while you are driving, brake normally but do not pump your brakes. If you do, the pedal may get harder to push down. If your engine stops, you will still have some power brake assist. But you will use it when you brake. Once the power assist is used up, it may take longer to stop and the brake pedal will be harder to push.

## Anti-Lock Brake System (ABS)

Your vehicle has anti-lock brakes. ABS is an advanced electronic braking system that will help prevent a braking skid.

When you start your engine, or when you begin to drive away, your anti-lock brake system will check itself. You may hear a momentary motor or clicking noise while this test is going on, and you may even notice that your brake pedal moves or pulses a little. This is normal.

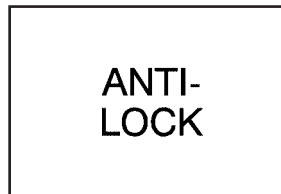

United States

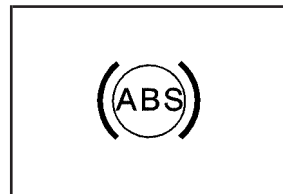

Canada

If there is a problem with the anti-lock brake system, this warning light will stay on. See *Anti-Lock Brake System Warning Light on page 3-42*.



Let us say the road is wet and you are driving safely. Suddenly, an animal jumps out in front of you. You slam on the brakes and continue braking. Here is what happens with ABS:

A computer senses that wheels are slowing down. If one of the wheels is about to stop rolling, the computer will separately work the brakes at each front wheel and at both rear wheels.

The anti-lock system can change the brake pressure faster than any driver could. The computer is programmed to make the most of available tire and road conditions. This can help you steer around the obstacle while braking hard.



As you brake, your computer keeps receiving updates on wheel speed and controls braking pressure accordingly.

Remember: Anti-lock does not change the time you need to get your foot up to the brake pedal or always decrease stopping distance. If you get too close to the vehicle in front of you, you will not have time to apply your brakes if that vehicle suddenly slows or stops. Always leave enough room up ahead to stop, even though you have anti-lock brakes.

## Using Anti-Lock

Do not pump the brakes. Just hold the brake pedal down firmly and let anti-lock work for you. You may feel a slight brake pedal pulsation or notice some noise, but this is normal.

## Braking in Emergencies

With anti-lock, you can steer and brake at the same time. In many emergencies, steering can help you more than even the very best braking.

## Traction Control System (TCS)

Your vehicle may have a traction control system that limits wheel spin. This is especially useful in slippery road conditions. The system operates only if it senses that one or both of the front wheels are spinning or beginning to lose traction. When this happens, the system works the front brakes and reduces engine power to limit wheel spin.

You may feel or hear the system working, but this is normal.

If your vehicle is in cruise control when the traction control system begins to limit wheel spin, the cruise control will automatically disengage. When road conditions allow you to safely use it again, you may reengage the cruise control. See *Cruise Control on page 3-11*.



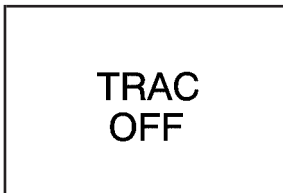

**United States and V6 in  
Canada**

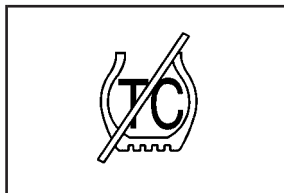

**Canada (V8 Only)**

This light should come on briefly when you start the engine. If it stays on or comes on while you are driving, there is a problem with your traction control system.

See *Traction Control System (TCS) Warning Light* on page 3-43. When this warning light is on, the system will not limit wheel spin. Adjust your driving accordingly.

The traction control system automatically comes on whenever you start your vehicle. To limit wheel spin, especially in slippery road conditions, you should always leave the system on. But you can turn the traction control system off if you ever need to. You should turn the system off if your vehicle ever gets stuck in sand, mud or snow and rocking the vehicle is required. See *Rocking Your Vehicle to Get It Out* on page 4-29.



To turn the system off, press the TRACTION CONTROL button located on the instrument panel under the comfort controls.

The traction control system warning light in the instrument cluster will come on and stay on. If the system is limiting wheel spin when you press the button, the warning light will come on — but the system will not turn off right away. It will wait until there is no longer a current need to limit wheel spin.

You can turn the system back on at any time by pressing the button again. The traction control system warning light should go off.

The switch indicator light should go back on.

## Steering

### Power Steering

If you lose power steering assist because the engine stops or the system is not functioning, you can steer but it will take much more effort.

### Magnetic Speed Variable Assist Steering

Your vehicle may have this optional steering system that continuously adjusts the effort you feel when steering at all vehicle speeds. It provides ease when parking, yet a firm, solid feel at highway speeds.

### Steering Tips Driving on Curves

It is important to take curves at a reasonable speed.

A lot of the “driver lost control” accidents mentioned on the news happen on curves. Here is why:

Experienced driver or beginner, each of us is subject to the same laws of physics when driving on curves. The traction of the tires against the road surface makes it possible for the vehicle to change its path when you turn the front wheels. If there is no traction, inertia

will keep the vehicle going in the same direction. If you have ever tried to steer a vehicle on wet ice, you will understand this.

The traction you can get in a curve depends on the condition of your tires and the road surface, the angle at which the curve is banked, and your speed. While you are in a curve, speed is the one factor you can control.

Suppose you are steering through a sharp curve. Then you suddenly accelerate. Both control systems — steering and acceleration — have to do their work where the tires meet the road. Adding the sudden acceleration can demand too much of those places. You can lose control. See *Traction Control System (TCS) on page 4-8*.

What should you do if this ever happens? Ease up on the accelerator pedal, steer the vehicle the way you want it to go, and slow down.

If you have Stabilitrak<sup>®</sup>, you may see the STABILITY SYSTEM ACTIVE message on the Driver Information Center. See “Stability System Active Message” under *DIC Warnings and Messages on page 3-62*.

Speed limit signs near curves warn that you should adjust your speed. Of course, the posted speeds are based on good weather and road conditions. Under less favorable conditions you will want to go slower.

If you need to reduce your speed as you approach a curve, do it before you enter the curve, while your front wheels are straight ahead.

Try to adjust your speed so you can “drive” through the curve. Maintain a reasonable, steady speed. Wait to accelerate until you are out of the curve, and then accelerate gently into the straightaway.

## Steering in Emergencies

There are times when steering can be more effective than braking. For example, you come over a hill and find a truck stopped in your lane, or a car suddenly pulls out from nowhere, or a child darts out from between parked cars and stops right in front of you. You can avoid these problems by braking — if you can stop in time. But sometimes you cannot; there is not room. That is the time for evasive action — steering around the problem.

Your vehicle can perform very well in emergencies like these. First apply your brakes.

See *Braking on page 4-5*. It is better to remove as much speed as you can from a possible collision. Then steer around the problem, to the left or right depending on the space available.

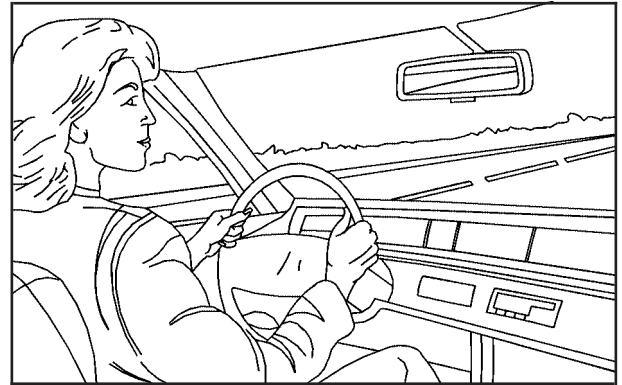

An emergency like this requires close attention and a quick decision. If you are holding the steering wheel at the recommended 9 and 3 o'clock positions, you can turn it a full 180 degrees very quickly without removing either hand. But you have to act fast, steer quickly, and just as quickly straighten the wheel once you have avoided the object.

The fact that such emergency situations are always possible is a good reason to practice defensive driving at all times and wear safety belts properly.

## Off-Road Recovery

You may find that your right wheels have dropped off the edge of a road onto the shoulder while you're driving.

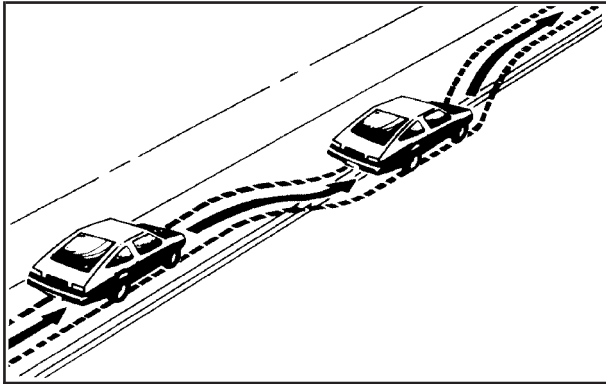

If the level of the shoulder is only slightly below the pavement, recovery should be fairly easy. Ease off the accelerator and then, if there is nothing in the way, steer so that your vehicle straddles the edge of the pavement. You can turn the steering wheel up to one-quarter turn until the right front tire contacts the pavement edge. Then turn your steering wheel to go straight down the roadway.

## Passing

The driver of a vehicle about to pass another on a two-lane highway waits for just the right moment, accelerates, moves around the vehicle ahead, then goes back into the right lane again. A simple maneuver?

Not necessarily! Passing another vehicle on a two-lane highway is a potentially dangerous move, since the passing vehicle occupies the same lane as oncoming traffic for several seconds. A miscalculation, an error in judgment, or a brief surrender to frustration or anger can suddenly put the passing driver face to face with the worst of all traffic accidents — the head-on collision.

So here are some tips for passing:

- Drive ahead. Look down the road, to the sides and to crossroads for situations that might affect your passing patterns. If you have any doubt whatsoever about making a successful pass, wait for a better time.
- Watch for traffic signs, pavement markings and lines. If you can see a sign up ahead that might indicate a turn or an intersection, delay your pass. A broken center line usually indicates it is all right to pass, providing the road ahead is clear. Never cross a solid line on your side of the lane or a double solid line, even if the road seems empty of approaching traffic.

- Do not get too close to the vehicle you want to pass while you are awaiting an opportunity. For one thing, following too closely reduces your area of vision, especially if you are following a larger vehicle. Also, you will not have adequate space if the vehicle ahead suddenly slows or stops. Keep back a reasonable distance.
- When it looks like a chance to pass is coming up, start to accelerate but stay in the right lane and do not get too close. Time your move so you will be increasing speed as the time comes to move into the other lane. If the way is clear to pass, you will have a running start that more than makes up for the distance you would lose by dropping back. And if something happens to cause you to cancel your pass, you need only slow down and drop back again and wait for another opportunity.
- If other vehicles are lined up to pass a slow vehicle, wait your turn. But take care that someone is not trying to pass you as you pull out to pass the slow vehicle. Remember to glance over your shoulder and check the blind spot.
- Check your mirrors, glance over your shoulder, and start your left lane change signal before moving out of the right lane to pass. When you are far enough ahead of the passed vehicle to see its front in your inside mirror, activate your right lane

change signal and move back into the right lane. Remember that your right outside mirror is convex. The vehicle you just passed may seem to be farther away from you than it really is.

- Try not to pass more than one vehicle at a time on two-lane roads. Reconsider before passing the next vehicle.
- Do not overtake a slowly moving vehicle too rapidly. Even though the brake lamps are not flashing, it may be slowing down or starting to turn.
- If you are being passed, make it easy for the following driver to get ahead of you. Perhaps you can ease a little to the right.

## Loss of Control

Let us review what driving experts say about what happens when the three control systems — brakes, steering, and acceleration — do not have enough friction where the tires meet the road to do what the driver has asked.

In any emergency, do not give up. Keep trying to steer and constantly seek an escape route or area of less danger.

## Skidding

In a skid, a driver can lose control of the vehicle. Defensive drivers avoid most skids by taking reasonable care suited to existing conditions, and by not overdriving those conditions. But skids are always possible.

The three types of skids correspond to your vehicle's three control systems. In the braking skid, your wheels are not rolling. In the steering or cornering skid, too much speed or steering in a curve causes tires to slip and lose cornering force. And in the acceleration skid, too much throttle causes the driving wheels to spin.

A cornering skid is best handled by easing your foot off the accelerator pedal.

If you have the traction control system, remember: It helps avoid only the acceleration skid. If you do not have traction control, or if the system is off, then an acceleration skid is also best handled by easing your foot off the accelerator pedal.

If your vehicle starts to slide, ease your foot off the accelerator pedal and quickly steer the way you want the vehicle to go. If you start steering quickly enough, your vehicle may straighten out. Always be ready for a second skid if it occurs.

If you have Stabilitrak<sup>®</sup>, you may see the STABILITY SYSTEM ACTIVE message on the Driver Information Center. See “Stability System Active Message” under *DIC Warnings and Messages on page 3-62*.

Of course, traction is reduced when water, snow, ice, gravel, or other material is on the road. For safety, you will want to slow down and adjust your driving to these conditions. It is important to slow down on slippery surfaces because stopping distance will be longer and vehicle control more limited.

While driving on a surface with reduced traction, try your best to avoid sudden steering, acceleration, or braking, including engine braking by shifting to a lower gear. Any sudden changes could cause the tires to slide. You may not realize the surface is slippery until your vehicle is skidding. Learn to recognize warning clues — such as enough water, ice, or packed snow on the road to make a mirrored surface — and slow down when you have any doubt.

Remember: Any anti-lock brake system (ABS) helps avoid only the braking skid.

## Driving at Night

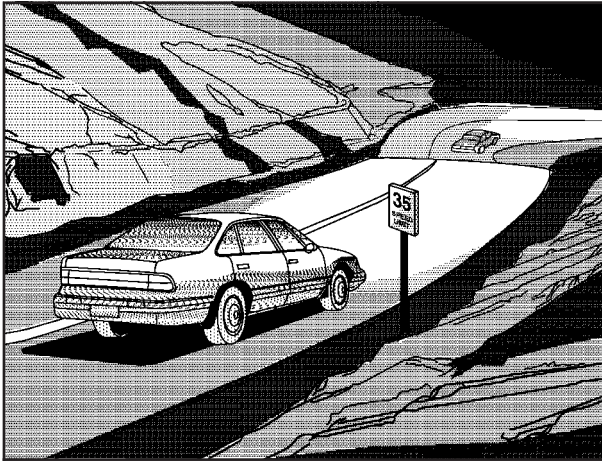

Night driving is more dangerous than day driving. One reason is that some drivers are likely to be impaired — by alcohol or drugs, with night vision problems, or by fatigue.

Here are some tips on night driving.

- Drive defensively.
- Do not drink and drive.
- Adjust your inside rearview mirror to reduce the glare from headlamps behind you.
- Since you cannot see as well, you may need to slow down and keep more space between you and other vehicles.
- Slow down, especially on higher speed roads. Your headlamps can light up only so much road ahead.
- In remote areas, watch for animals.
- If you are tired, pull off the road in a safe place and rest.

No one can see as well at night as in the daytime. But as we get older these differences increase. A 50-year-old driver may require at least twice as much light to see the same thing at night as a 20-year-old.

What you do in the daytime can also affect your night vision. For example, if you spend the day in bright sunshine you are wise to wear sunglasses. Your eyes will have less trouble adjusting to night. But if you are driving, do not wear sunglasses at night. They may cut down on glare from headlamps, but they also make a lot of things invisible.

You can be temporarily blinded by approaching headlamps. It can take a second or two, or even several seconds, for your eyes to re-adjust to the dark. When you are faced with severe glare, as from a driver who does not lower the high beams, or a vehicle with misaimed headlamps, slow down a little. Avoid staring directly into the approaching headlamps.

Keep your windshield and all the glass on your vehicle clean — inside and out. Glare at night is made much worse by dirt on the glass. Even the inside of the glass can build up a film caused by dust. Dirty glass makes lights dazzle and flash more than clean glass would, making the pupils of your eyes contract repeatedly.

Remember that your headlamps light up far less of a roadway when you are in a turn or curve. Keep your eyes moving; that way, it is easier to pick out dimly lighted objects. Just as your headlamps should be checked regularly for proper aim, so should your eyes be examined regularly. Some drivers suffer from night blindness — the inability to see in dim light — and are not even aware of it.

## Driving in Rain and on Wet Roads

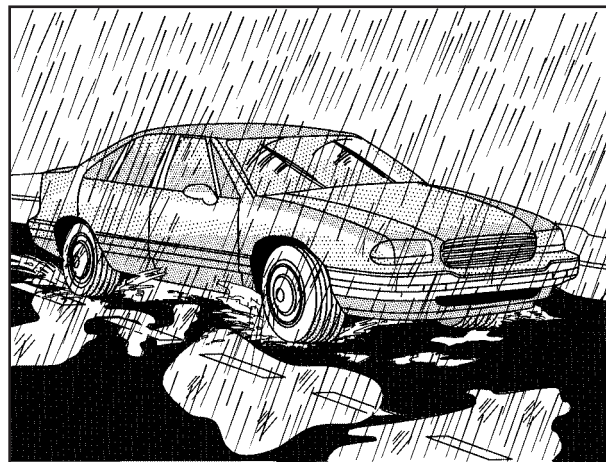

Rain and wet roads can mean driving trouble. On a wet road, you cannot stop, accelerate, or turn as well because your tire-to-road traction is not as good as on dry roads. And, if your tires do not have much tread left, you will get even less traction. It is always wise to go slower and be cautious if rain starts to fall while you are driving. The surface may get wet suddenly when your reflexes are tuned for driving on dry pavement.



The heavier the rain, the harder it is to see. Even if your windshield wiper blades are in good shape, a heavy rain can make it harder to see road signs and traffic signals, pavement markings, the edge of the road, and even people walking.

It is wise to keep your windshield wiping equipment in good shape and keep your windshield washer tank filled with washer fluid. Replace your windshield wiper inserts when they show signs of streaking or missing areas on the windshield, or when strips of rubber start to separate from the inserts.

Driving too fast through large water puddles or even going through some car washes can cause problems, too. The water may affect your brakes. Try to avoid puddles. But if you cannot, try to slow down before you hit them.

 **CAUTION:**

**Wet brakes can cause accidents. They will not work as well in a quick stop and may cause pulling to one side. You could lose control of the vehicle.**

**After driving through a large puddle of water or a car wash, apply your brake pedal lightly until your brakes work normally.**

## Hydroplaning

Hydroplaning is dangerous. So much water can build up under your tires that they can actually ride on the water. This can happen if the road is wet enough and you are going fast enough. When your vehicle is hydroplaning, it has little or no contact with the road.

Hydroplaning does not happen often. But it can if your tires do not have much tread or if the pressure in one or more is low. It can happen if a lot of water is standing on the road. If you can see reflections from trees, telephone poles, or other vehicles, and raindrops dimple the water's surface, there could be hydroplaning.

Hydroplaning usually happens at higher speeds. There just is not a hard and fast rule about hydroplaning. The best advice is to slow down when it is raining.

## Driving Through Deep Standing Water

**Notice:** If you drive too quickly through deep puddles or standing water, water can come in through your engine's air intake and badly damage your engine. Never drive through water that is slightly lower than the underbody of your vehicle. If you cannot avoid deep puddles or standing water, drive through them very slowly.

## Driving Through Flowing Water

### CAUTION:

**Flowing or rushing water creates strong forces. If you try to drive through flowing water, as you might at a low water crossing, your vehicle can be carried away. As little as six inches of flowing water can carry away a smaller vehicle. If this happens, you and other vehicle occupants could drown. Do not ignore police warning signs, and otherwise be very cautious about trying to drive through flowing water.**

## Some Other Rainy Weather Tips

- Besides slowing down, allow some extra following distance. And be especially careful when you pass another vehicle. Allow yourself more clear room ahead, and be prepared to have your view restricted by road spray.
- Have good tires with proper tread depth. See *Tires on page 5-74*.

## City Driving



One of the biggest problems with city streets is the amount of traffic on them. You will want to watch out for what the other drivers are doing and pay attention to traffic signals.

Here are ways to increase your safety in city driving:

- Know the best way to get to where you are going. Get a city map and plan your trip into an unknown part of the city just as you would for a cross-country trip.
- Try to use the freeways that rim and crisscross most large cities. You will save time and energy. See *Freeway Driving on page 4-20*.
- Treat a green light as a warning signal. A traffic light is there because the corner is busy enough to need it. When a light turns green, and just before you start to move, check both ways for vehicles that have not cleared the intersection or may be running the red light.

## Freeway Driving

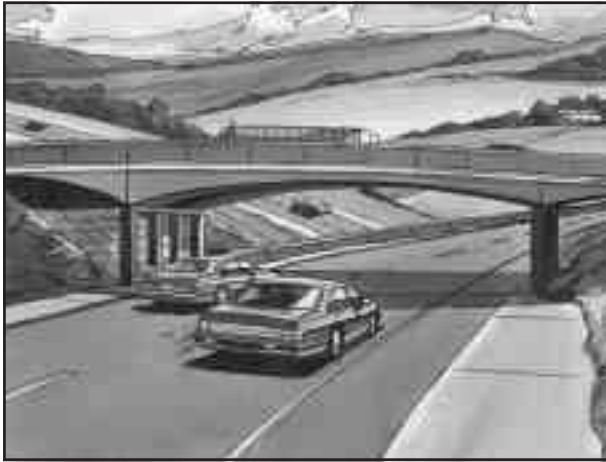

Mile for mile, freeways — also called thruways, parkways, expressways, turnpikes, or superhighways — are the safest of all roads. But they have their own special rules.

The most important advice on freeway driving is: Keep up with traffic and keep to the right. Drive at the same speed most of the other drivers are driving. Too-fast or too-slow driving breaks a smooth traffic flow. Treat the left lane on a freeway as a passing lane.

At the entrance, there is usually a ramp that leads to the freeway. If you have a clear view of the freeway as you drive along the entrance ramp, you should begin to check traffic. Try to determine where you expect to blend with the flow. Try to merge into the gap at close to the prevailing speed. Switch on your turn signal, check your mirrors, and glance over your shoulder as often as necessary. Try to blend smoothly with the traffic flow.

Once you are on the freeway, adjust your speed to the posted limit or to the prevailing rate if it is slower. Stay in the right lane unless you want to pass.

Before changing lanes, check your mirrors. Then use your turn signal.

Just before you leave the lane, glance quickly over your shoulder to make sure there is not another vehicle in your blind spot.

Once you are moving on the freeway, make certain you allow a reasonable following distance.

Expect to move slightly slower at night.

When you want to leave the freeway, move to the proper lane well in advance. If you miss your exit, do not, under any circumstances, stop and back up. Drive on to the next exit.

The exit ramp can be curved, sometimes quite sharply. The exit speed is usually posted. Reduce your speed according to your speedometer, not to your sense of motion. After driving for any distance at higher speeds, you may tend to think you are going slower than you actually are.

## Before Leaving on a Long Trip

Make sure you are ready. Try to be well rested. If you must start when you are not fresh — such as after a day's work — do not plan to make too many miles that first part of the journey. Wear comfortable clothing and shoes you can easily drive in.

Is your vehicle ready for a long trip? If you keep it serviced and maintained, it is ready to go. If it needs service, have it done before starting out. Of course, you will find experienced and able service experts in GM dealerships all across North America. They will be ready and willing to help if you need it.

Here are some things you can check before a trip:

- *Windshield Washer Fluid:* Is the reservoir full? Are all windows clean inside and outside?
- *Wiper Blades:* Are they in good shape?
- *Fuel, Engine Oil, Other Fluids:* Have you checked all levels?
- *Lamps:* Are they all working? Are the lenses clean?
- *Tires:* They are vitally important to a safe, trouble-free trip. Is the tread good enough for long-distance driving? Are the tires all inflated to the recommended pressure?
- *Weather Forecasts:* What is the weather outlook along your route? Should you delay your trip a short time to avoid a major storm system?
- *Maps:* Do you have up-to-date maps?

## Highway Hypnosis

Is there actually such a condition as highway hypnosis? Or is it just plain falling asleep at the wheel? Call it highway hypnosis, lack of awareness, or whatever.

There is something about an easy stretch of road with the same scenery, along with the hum of the tires on the road, the drone of the engine, and the rush of the wind against the vehicle that can make you sleepy. Do not let it happen to you! If it does, your vehicle can leave the road in less than a second, and you could crash and be injured.

What can you do about highway hypnosis? First, be aware that it can happen.

Then here are some tips:

- Make sure your vehicle is well ventilated, with a comfortably cool interior.
- Keep your eyes moving. Scan the road ahead and to the sides. Check your rearview mirrors and your instruments frequently.
- If you get sleepy, pull off the road into a rest, service, or parking area and take a nap, get some exercise, or both. For safety, treat drowsiness on the highway as an emergency.

## Hill and Mountain Roads



Driving on steep hills or mountains is different from driving in flat or rolling terrain.

If you drive regularly in steep country, or if you are planning to visit there, here are some tips that can make your trips safer and more enjoyable.

- Keep your vehicle in good shape. Check all fluid levels and also the brakes, tires, cooling system, and transaxle. These parts can work hard on mountain roads.
- Know how to go down hills. The most important thing to know is this: let your engine do some of the slowing down. Shift to a lower gear when you go down a steep or long hill.

 **CAUTION:**

**If you do not shift down, your brakes could get so hot that they would not work well. You would then have poor braking or even none going down a hill. You could crash. Shift down to let your engine assist your brakes on a steep downhill slope.**

 **CAUTION:**

**Coasting downhill in NEUTRAL (N) or with the ignition off is dangerous. Your brakes will have to do all the work of slowing down. They could get so hot that they would not work well. You would then have poor braking or even none going down a hill. You could crash. Always have your engine running and your vehicle in gear when you go downhill.**

- Know how to go uphill. Drive in the highest gear possible.
- Stay in your own lane when driving on two-lane roads in hills or mountains. Do not swing wide or cut across the center of the road. Drive at speeds that let you stay in your own lane.
- As you go over the top of a hill, be alert. There could be something in your lane, like a stalled car or an accident.
- You may see highway signs on mountains that warn of special problems. Examples are long grades, passing or no-passing zones, a falling rocks area, or winding roads. Be alert to these and take appropriate action.

## Winter Driving



Here are some tips for winter driving:

- Have your vehicle in good shape for winter.
- You may want to put winter emergency supplies in your trunk.

Also see *Tires* on page 5-74.



Include an ice scraper, a small brush or broom, a supply of windshield washer fluid, a rag, some winter outer clothing, a small shovel, a flashlight, a red cloth, and a couple of reflective warning triangles. And, if you will be driving under severe conditions, include a small bag of sand, a piece of old carpet, or a couple of burlap bags to help provide traction. Be sure you properly secure these items in your vehicle.



## Driving on Snow or Ice

Most of the time, those places where your tires meet the road probably have good traction.

However, if there is snow or ice between your tires and the road, you can have a very slippery situation. You will have a lot less traction, or grip, and will need to be very careful.



What is the worst time for this? Wet ice. Very cold snow or ice can be slick and hard to drive on. But wet ice can be even more trouble because it may offer the least traction of all. You can get wet ice when it is about freezing (32°F; 0°C) and freezing rain begins to fall. Try to avoid driving on wet ice until salt and sand crews can get there.

Whatever the condition — smooth ice, packed, blowing, or loose snow — drive with caution.

If you have traction control, it will improve your ability to accelerate when driving on a slippery road. Even though your vehicle has a traction control system you will want to slow down and adjust your driving to the road conditions. Under certain conditions, you may want to turn the traction control system off, such as when driving through deep snow and loose gravel, to help maintain vehicle motion at lower speeds. See *Traction Control System (TCS)* on page 4-8.

If you do not have a traction control system, accelerate gently. Try not to break the fragile traction. If you accelerate too fast, the drive wheels will spin and polish the surface under the tires even more.

Your anti-lock brakes improve your vehicle's stability when you make a hard stop on a slippery road. Even though you have the anti-lock braking system, you will want to begin stopping sooner than you would on dry pavement. See *Anti-Lock Brake System (ABS)* on page 4-6.

- Allow greater following distance on any slippery road.
- Watch for slippery spots. The road might be fine until you hit a spot that is covered with ice. On an otherwise clear road, ice patches may appear in shaded areas where the sun cannot reach: around clumps of trees, behind buildings, or under bridges. Sometimes the surface of a curve or an overpass may remain icy when the surrounding roads are clear. If you see a patch of ice ahead of you, brake before you are on it. Try not to brake while you are actually on the ice, and avoid sudden steering maneuvers.

## If You Are Caught in a Blizzard

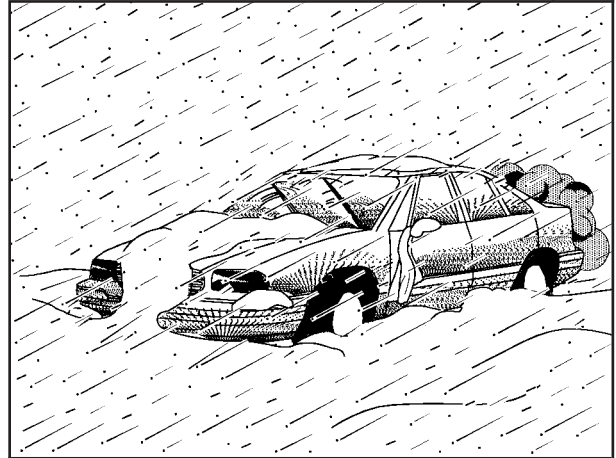

If you are stopped by heavy snow, you could be in a serious situation. You should probably stay with your vehicle unless you know for sure that you are near help and you can hike through the snow. Here are some things to do to summon help and keep yourself and your passengers safe:

- Turn on your hazard flashers.
- Tie a red cloth to your vehicle to alert police that you have been stopped by the snow.

- Put on extra clothing or wrap a blanket around you. If you have no blankets or extra clothing, make body insulators from newspapers, burlap bags, rags, floor mats — anything you can wrap around yourself or tuck under your clothing to keep warm.

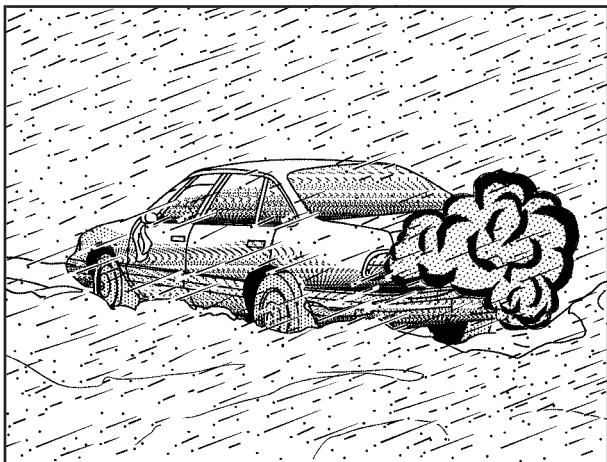

You can run the engine to keep warm, but be careful.

### **⚠ CAUTION:**

**Snow can trap exhaust gases under your vehicle. This can cause deadly CO (carbon monoxide) gas to get inside. CO could overcome you and kill you. You cannot see it or smell it, so you might not know it is in your vehicle. Clear away snow from around the base of your vehicle, especially any that is blocking your exhaust pipe. And check around again from time to time to be sure snow does not collect there.**

**Open a window just a little on the side of the vehicle that is away from the wind. This will help keep CO out.**

Run your engine only as long as you must. This saves fuel. When you run the engine, make it go a little faster than just idle. That is, push the accelerator slightly. This uses less fuel for the heat that you get and it keeps the battery charged. You will need a well-charged battery to restart the vehicle, and possibly for signaling later on with your headlamps. Let the heater run for a while.

Then, shut the engine off and close the window almost all the way to preserve the heat. Start the engine again and repeat this only when you feel really uncomfortable from the cold. But do it as little as possible. Preserve the fuel as long as you can. To help keep warm, you can get out of the vehicle and do some fairly vigorous exercises every half hour or so until help comes.

## If You Are Stuck: In Sand, Mud, Ice or Snow

In order to free your vehicle when it is stuck, you will need to spin the wheels, but you do not want to spin your wheels too fast. The method known as rocking can help you get out when you are stuck, but you must use caution.

### CAUTION:

**If you let your tires spin at high speed, they can explode, and you or others could be injured. And, the transaxle or other parts of the vehicle can overheat. That could cause an engine compartment fire or other damage. When you are stuck, spin the wheels as little as possible. Do not spin the wheels above 35 mph (55 km/h) as shown on the speedometer.**

***Notice:*** Spinning your wheels can destroy parts of your vehicle as well as the tires. If you spin the wheels too fast while shifting your transaxle back and forth, you can destroy your transaxle. See ***Rocking Your Vehicle to Get It Out*** on page 4-29.

For information about using tire chains on your vehicle, see ***Tire Chains*** on page 5-90.

## Rocking Your Vehicle to Get It Out

First, turn your steering wheel left and right. That will clear the area around your front wheels. If your vehicle has traction control, you should turn your traction control system off. See *Traction Control System (TCS)* on page 4-8. Then shift back and forth between REVERSE (R) and a forward gear, spinning the wheels as little as possible. Release the accelerator pedal while you shift, and press lightly on the accelerator pedal when the transaxle is in gear. By slowly spinning your wheels in the forward and reverse directions, you will cause a rocking motion that may free your vehicle. If that does not get you out after a few tries, you may need to be towed out. If you do need to be towed out, see *Towing Your Vehicle* on page 4-34.

## Loading Your Vehicle

It is very important to know how much weight your vehicle can carry. This weight is called the vehicle capacity weight and includes the weight of all occupants, cargo and all nonfactory-installed options. Two labels on your vehicle show how much weight it may properly carry, the Tire and Loading Information label and the Certification label.

### **CAUTION:**

**Do not load your vehicle any heavier than the Gross Vehicle Weight Rating (GVWR), or either the maximum front or rear Gross Axle Weight Rating (GAWR). If you do, parts on your vehicle can break, and it can change the way your vehicle handles. These could cause you to lose control and crash. Also, overloading can shorten the life of your vehicle.**

## Tire and Loading Information Label

The diagram shows a rectangular label with a black header containing the text "TIRE AND LOADING INFORMATION". To the left of the header is a tire icon with callout 'A' pointing to it. Below the header is a row of five boxes labeled "SEATING CAPACITY", "TOTAL", "FRONT", "CENT.R", and "REAR", with callout 'B' pointing to the "TOTAL" box. Below this row is a warning sentence: "The combined weight of occupants and cargo should never exceed XXX kg or XXX lbs." Below the warning is a table with three columns: "ORIGINAL TIRE SIZE", "COLD TIRE INFLATION PRESSURE", and "SEE OWNER'S MANUAL FOR ADDITIONAL INFORMATION". The table has three rows: "FRONT", "REAR", and "SPARE". Callout 'C' points to the "ORIGINAL TIRE SIZE" column, and callout 'D' points to the "COLD TIRE INFLATION PRESSURE" column.

ORIGINAL TIRE SIZE	COLD TIRE INFLATION PRESSURE	SEE OWNER'S MANUAL FOR ADDITIONAL INFORMATION
	FRONT	
	REAR	
	SPARE	

**Label Example**

A vehicle specific Tire and Loading Information label is attached to the vehicle's center pillar (B-pillar). With the driver's door open, you will find the label attached below the door lock post (striker). The tire and loading information label shows the number of occupant seating positions (A), and the maximum vehicle capacity weight (B) in kilograms and pounds.

The Tire and Loading Information label also shows the tire size of the original equipment tires (C) and the recommended cold tire inflation pressures (D). For more information on tires and inflation see *Tires on page 5-74* and *Inflation - Tire Pressure on page 5-80*.

There is also important loading information on the Certification label. It tells you the Gross Vehicle Weight Rating (GVWR) and the Gross Axle Weight Rating (GAWR) for the front and rear axle; see "Certification Label" later in this section.

### Steps for Determining Correct Load Limit

1. Locate the statement "The combined weight of occupants and cargo should never exceed XXX kg or XXX pounds" on your vehicle's placard.
2. Determine the combined weight of the driver and passengers that will be riding in your vehicle.
3. Subtract the combined weight of the driver and passengers from XXX kilograms or XXX pounds.
4. The resulting figure equals the available amount of cargo and luggage load capacity. For example, if the "XXX" amount equals 1400 lbs and there will be five 150 lb passengers in your vehicle, the amount of available cargo and luggage load capacity is 650 lbs (1400 – 750 (5 x 150) = 650 lbs).

5. Determine the combined weight of luggage and cargo being loaded on the vehicle. That weight may not safely exceed the available cargo and luggage load capacity calculated in Step 4.
6. If your vehicle will be towing a trailer, the load from your trailer will be transferred to your vehicle. Consult this manual to determine how this reduces the available cargo and luggage load capacity of your vehicle.

If your vehicle can tow a trailer, see *Towing a Trailer (V8 Engine)* on page 4-36 or *Towing a Trailer (V6 Engine)* on page 4-36 for important information on towing a trailer, towing safety rules, and trailering tips.

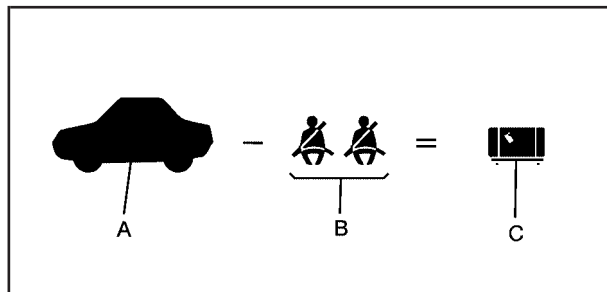

**Example 1**

Item	Description	Total
A	Vehicle Capacity Weight for Example 1 =	1,000 lbs (453 kg)
B	Subtract Occupant Weight 150 lbs (68 kg) × 2 =	300 lbs (136 kg)
C	Available Occupant and Cargo Weight =	700 lbs (317 kg)

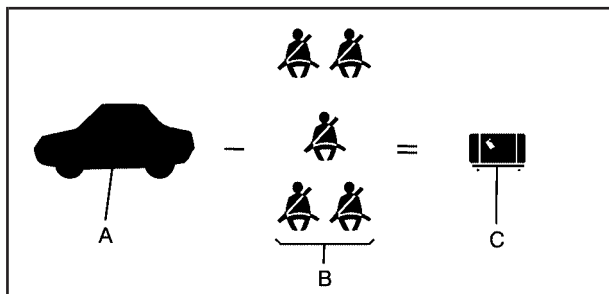

**Example 2**

Item	Description	Total
A	Vehicle Capacity Weight for Example 2 =	1,000 lbs (453 kg)
B	Subtract Occupant Weight 150 lbs (68 kg) × 5 =	750 lbs (340 kg)
C	Available Cargo Weight =	250 lbs (113 kg)

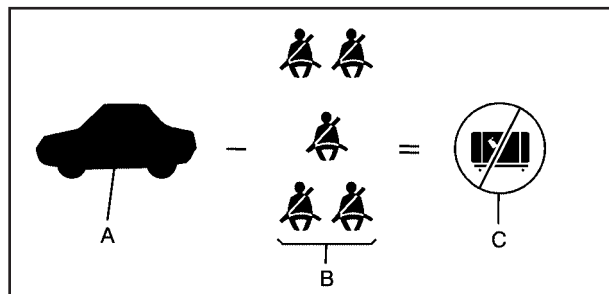

**Example 3**

Item	Description	Total
A	Vehicle Capacity Weight for Example 3 =	1,000 lbs (453 kg)
B	Subtract Occupant Weight 200 lbs (91 kg) × 5 =	1,000 lbs (453 kg)
C	Available Cargo Weight =	0 lbs (0 kg)

Refer to your vehicle's Tire and Loading Information label for specific information about your vehicle's capacity weight and seating positions. The combined weight of the driver, passengers, and cargo should never exceed your vehicle's capacity weight.



## Certification Label

The image shows a GM Certification Label with a large diagonal watermark that reads "EXAMPLE". The label includes the GM logo, the text "MFD BY GENERAL MOTORS CORP", and four fields for "DATE", "GVWR", "GAWR FRT", and "GAWR RR". Below these fields is a paragraph of text: "THIS VEHICLE CONFORMS TO ALL APPLICABLE U.S. FEDERAL MOTOR VEHICLE SAFETY, BUMPER, AND TRAFFIC PREVENTION STANDARDS IN EFFECT ON THE DATE OF MANUFACTURE SHOWN ABOVE." At the bottom, there is a section for "200" and "TYPE PASS CAR".

A vehicle specific Certification label is attached to the rear edge of the driver's door. It tells you the gross weight capacity of your vehicle, called the Gross Vehicle Weight Rating (GVWR). The GVWR includes the weight of the vehicle, all occupants, fuel and cargo. Never exceed the GVWR for your vehicle, or the Gross Axle Weight Rating (GAWR) for either the front or rear axle.

And, if you do have a heavy load, you should spread it out. Do not carry more than 176 lbs (80 kg) in your trunk.

## CAUTION:

Do not load your vehicle any heavier than the Gross Vehicle Weight Rating (GVWR), or either the maximum front or rear Gross Axle Weight Rating (GAWR). If you do, parts on your vehicle can break, and it can change the way your vehicle handles. These could cause you to lose control and crash. Also, overloading can shorten the life of your vehicle.

**Notice:** Overloading your vehicle may cause damage. Repairs would not be covered by your warranty. Do not overload your vehicle.

If you put things inside your vehicle, like suitcases, tools, packages, or anything else, they will go as fast as the vehicle goes. If you have to stop or turn quickly, or if there is a crash, they will keep going.

## CAUTION:

Things you put inside your vehicle can strike and injure people in a sudden stop or turn, or in a crash.

- **Put things in the trunk of your vehicle. In a trunk, put them as far forward as you can. Try to spread the weight evenly.**
- **Never stack heavier things, like suitcases, inside the vehicle so that some of them are above the tops of the seats.**
- **Do not leave an unsecured child restraint in your vehicle.**
- **When you carry something inside the vehicle, secure it whenever you can.**

## Automatic Level Control

This feature keeps the rear of your vehicle level as the load changes. It is automatic, you do not need to adjust anything.

## Towing

### Towing Your Vehicle

Consult your dealer or a professional towing service if you need to have your disabled vehicle towed. See *Roadside Assistance Program on page 7-5*.

If you want to tow your vehicle behind another vehicle for recreational purposes (such as behind a motorhome), see “Recreational Vehicle Towing” following.

## Recreational Vehicle Towing

Recreational vehicle towing means towing your vehicle behind another vehicle — such as behind a motorhome. The two most common types of recreational vehicle towing are known as “dinghy towing” (towing your vehicle with all four wheels on the ground) and “dolly towing” (towing your vehicle with two wheels on the ground and two wheels up on a device known as a “dolly”).

With the proper preparation and equipment, many vehicles can be towed in these ways. See “Dinghy Towing” and “Dolly Towing,” following.

Here are some important things to consider before you do recreational vehicle towing:

- What is the towing capacity of the towing vehicle? Be sure you read the tow vehicle manufacturer’s recommendations.
- How far will you tow? Some vehicles have restrictions on how far and how long they can tow.

- Do you have the proper towing equipment? See your dealer or trailering professional for additional advice and equipment recommendations.
- Is your vehicle ready to be towed? Just as you would prepare your vehicle for a long trip, you will want to make sure your vehicle is prepared to be towed. See *Before Leaving on a Long Trip* on page 4-21.

## Dinghy Towing

**Notice:** If you tow your vehicle with all four wheels on the ground, the drivetrain components could be damaged. The repairs would not be covered by your warranty. Do not tow your vehicle with all four wheels on the ground.

Your vehicle was not designed to be towed with all four wheels on the ground. If your vehicle must be towed, you should use a dolly. See “Dolly Towing” that follows for more information.

## Dolly Towing

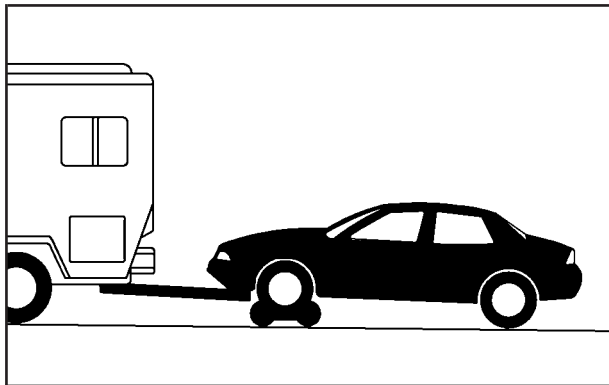

Your vehicle can be towed using a dolly. To tow your vehicle using a dolly, follow these steps:

1. Put the front wheels on the dolly.
2. Put the vehicle in PARK (P).
3. Set the parking brake and then remove the key.
4. Clamp the steering wheel in a straight-ahead position.
5. Release the parking brake.

## Towing a Trailer (V8 Engine)

Do not tow a trailer if your vehicle is equipped with the 4.6L V8 engine.

## Towing a Trailer (V6 Engine)

### CAUTION:

If you do not use the correct equipment and drive properly, you can lose control when you pull a trailer. For example, if the trailer is too heavy, the brakes may not work well — or even at all. You and your passengers could be seriously injured. You may also damage your vehicle; the resulting repairs would not be covered by your warranty. Pull a trailer only if you have followed all the steps in this section. Ask your dealer for advice and information about towing a trailer with your vehicle.

Your vehicle can tow a trailer if it is equipped with the 3.8L V6 engine and the proper trailer towing equipment. To identify what the vehicle trailering capacity is for your vehicle, you should read the information in “Weight of the Trailer” that appears later in this section. But trailering is different than just driving your vehicle by itself. Trailering means changes in handling, acceleration, braking, durability and fuel economy. Successful, safe trailering takes correct equipment, and it has to be used properly.

That is the reason for this part. In it are many time-tested, important trailering tips and safety rules. Many of these are important for your safety and that of your passengers. So please read this section carefully before you pull a trailer.

Load-pulling components such as the engine, transaxle, wheel assemblies and tires are forced to work harder against the drag of the added weight. The engine is required to operate at relatively higher speeds and under greater loads, generating extra heat. Also, the trailer adds considerably to wind resistance, increasing the pulling requirements.

## If You Do Decide To Pull A Trailer

If you do, here are some important points:

- There are many different laws, including speed limit restrictions, having to do with trailering. Make sure your rig will be legal, not only where you live but also where you will be driving. A good source for this information can be state or provincial police.
- Consider using a sway control. You can ask a hitch dealer about sway controls.
- Do not tow a trailer at all during the first 1,000 miles (1 600 km) your new vehicle is driven. Your engine, axle or other parts could be damaged.
- Then, during the first 500 miles (800 km) that you tow a trailer, do not drive over 50 mph (80 km/h) and do not make starts at full throttle. This helps your engine and other parts of your vehicle wear in at the heavier loads.
- Obey speed limit restrictions when towing a trailer. Do not drive faster than the maximum posted speed for trailers, or no more than 55 mph (90 km/h), to save wear on your vehicle's parts.

Three important considerations have to do with weight:

- The weight of the trailer
- The weight of the trailer tongue
- The total weight on your vehicle's tires

## Weight of the Trailer

How heavy can a trailer safely be?

It should never weigh more than 1,000 lbs (450 kg). But even that can be too heavy.

It depends on how you plan to use your rig. For example, speed, altitude, road grades, outside temperature and how much your vehicle is used to pull a trailer are all important. And, it can also depend on any special equipment that you have on your vehicle.

You can ask your dealer for our trailering information or advice, or you can write us at:

Pontiac-GMC Customer Assistance Center  
P.O. Box 33172  
Detroit, MI 48232-5172

In Canada, write to:

General Motors of Canada Limited  
Customer Communication Centre, 163-005  
1908 Colonel Sam Drive  
Oshawa, Ontario L1H 8P7

## Weight of the Trailer Tongue

The tongue load (A) of any trailer is an important weight to measure because it affects the total or gross weight of your vehicle. The Gross Vehicle Weight (GVW) includes the curb weight of the vehicle, any cargo you may carry in it, and the people who will be riding in the vehicle. If you have a lot of options, equipment, passengers, or cargo in your vehicle, it will reduce the tongue weight your vehicle can carry, which will also reduce the trailer weight your vehicle can tow. And if you tow a trailer, you must add the tongue load to the GVW because your vehicle will be carrying that weight, too. See *Loading Your Vehicle on page 4-29* for more information about your vehicle's maximum load capacity.

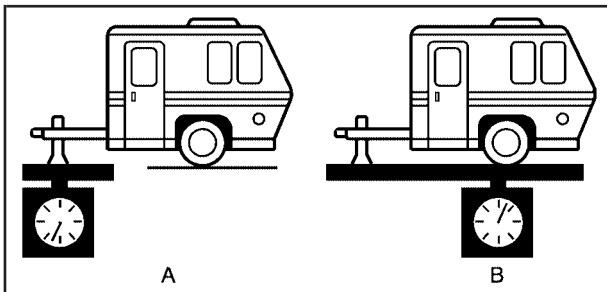

If you are using a weight-carrying hitch, the trailer tongue (A) should weigh 10 to 15 percent of the total loaded trailer weight (B).

After you have loaded your trailer, weigh the trailer and then the tongue, separately, to see if the weights are proper. If they are not, you may be able to get them right simply by moving some items around in the trailer.

## Total Weight on Your Vehicle's Tires

Be sure your vehicle's tires are inflated to the upper limit for cold tires. You will find these numbers on the Tire-Loading Information label. See *Loading Your Vehicle* on page 4-29. Then be sure you do not go over the GVW limit for your vehicle, including the weight of the trailer tongue.

## Hitches

It is important to have the correct hitch equipment. Crosswinds, large trucks going by and rough roads are a few reasons why you will need the right hitch. Here are some rules to follow:

- The rear bumper on your vehicle is not intended for hitches. Do not attach rental hitches or other bumper-type hitches to it. Use only a frame-mounted hitch that does not attach to the bumper.
- Will you have to make any holes in the body of your vehicle when you install a trailer hitch? If you do, then be sure to seal the holes later when you remove the hitch. If you do not seal them, deadly carbon monoxide (CO) from your exhaust can get into your vehicle. See *Engine Exhaust* on page 2-34. Dirt and water can also enter the vehicle.

## Safety Chains

You should always attach chains between your vehicle and your trailer. Cross the safety chains under the tongue of the trailer so that the tongue will not drop to the road if it becomes separated from the hitch. Instructions about safety chains may be provided by the hitch manufacturer or by the trailer manufacturer. Follow the manufacturer's recommendation for attaching safety chains and do not attach them to the bumper. Always leave just enough slack so you can turn with your rig. And, never allow safety chains to drag on the ground.

## Trailer Brakes

Does your trailer have its own brakes? Be sure to read and follow the instructions for the trailer brakes so you will be able to install, adjust and maintain them properly.

Because you have anti-lock brakes, do not try to tap into your vehicles brake system. If you do, both brake systems will not work well, or at all.

## Trailer Wiring Harness

All of the electrical circuits required for your trailer lighting system can be accessed at the driver's side rear lamp connector. This connector is located under the carpet in the rear corner of your trunk compartment.

## Driving with a Trailer

Towing a trailer requires a certain amount of experience. Before setting out for the open road, you will want to get to know your rig. Acquaint yourself with the feel of handling and braking with the added weight of the trailer. And always keep in mind that the vehicle you are driving is now a good deal longer and not nearly as responsive as your vehicle is by itself.

Before you start, check all trailer hitch parts and attachments, safety chains, electrical connector, lamps, tires and mirror adjustment. If the trailer has electric brakes, start your vehicle and trailer moving and then apply the trailer brake controller by hand to be sure the brakes are working. This lets you check your electrical connection at the same time.

During your trip, check occasionally to be sure that the load is secure, and that the lamps and any trailer brakes are still working.



## Following Distance

Stay at least twice as far behind the vehicle ahead as you would when driving your vehicle without a trailer. This can help you avoid situations that require heavy braking and sudden turns.

## Passing

You will need more passing distance up ahead when you are towing a trailer. And, because the vehicle is a good deal longer, you will need to go much farther beyond the passed vehicle before you can return to your lane.

## Backing Up

Hold the bottom of the steering wheel with one hand. Then, to move the trailer to the left, just move that hand to the left. To move the trailer to the right, move your hand to the right. Always back up slowly and, if possible, have someone guide you.

## Making Turns

**Notice:** Making very sharp turns while trailering could cause the trailer to come in contact with the vehicle. Your vehicle could be damaged. Avoid making very sharp turns while trailering.

When you are turning with a trailer, make wider turns than normal. Do this so your trailer will not strike soft shoulders, curbs, road signs, trees or other objects. Avoid jerky or sudden maneuvers. Signal well in advance.

## Turn Signals When Towing a Trailer

When you tow a trailer, your vehicle may need a different turn signal flasher and/or extra wiring. Check with your dealer. All of the electrical circuits required for your trailer lighting system can be accessed at the left rear lamp connector. This connector is located under the carpet on the driver's side in the rear corner of your trunk compartment. The arrows on your instrument panel will flash whenever you signal a turn or lane change. Properly hooked up, the trailer lamps will also flash, telling other drivers you are about to turn, change lanes or stop.

When towing a trailer, the arrows on your instrument panel will flash for turns even if the bulbs on the trailer are burned out. Thus, you may think drivers behind you are seeing your signal when they are not. It is important to check occasionally to be sure the trailer bulbs are still working.

Your vehicle has bulb warning lights. When you plug a trailer lighting system into your vehicle's lighting system, its bulb warning lights may not let you know if one of your lamps goes out. So, when you have a trailer lighting system plugged in, be sure to check your vehicle and trailer lamps from time to time to be sure they are all working. Once you disconnect the trailer lamps, the bulb warning lights again can tell you if one of your vehicle lamps is out.

## Driving On Grades

Reduce speed and shift to a lower gear *before* you start down a long or steep downgrade. If you do not shift down, you might have to use your brakes so much that they would get hot and no longer work well.

On a long uphill grade, shift down to THIRD (3) and reduce your speed to around 45 mph (70 km/h) to reduce the possibility of the engine and transaxle overheating.

## Parking on Hills

### CAUTION:

**You really should not park your vehicle, with a trailer attached, on a hill. If something goes wrong, your rig could start to move. People can be injured, and both your vehicle and the trailer can be damaged.**

But if you ever have to park your rig on a hill, here is how to do it:

1. Apply your regular brakes, but do not shift into PARK (P) yet.
2. Have someone place chocks under the trailer wheels.
3. When the wheel chocks are in place, release the regular brakes until the chocks absorb the load.
4. Reapply the regular brakes. Then apply your parking brake, and then shift to PARK (P).
5. Release the regular brakes.

## When You Are Ready to Leave After Parking on a Hill

1. Apply your regular brakes and hold the pedal down while you:
  - Start your engine.
  - Shift into a gear.
  - Release the parking brake.
2. Let up on the brake pedal.
3. Drive slowly until the trailer is clear of the chocks.
4. Stop and have someone pick up and store the chocks.

## Maintenance When Trailer Towing

Your vehicle will need service more often when you are pulling a trailer. See the Maintenance Schedule for more on this. Things that are especially important in trailer operation are automatic transaxle fluid (do not overfill), engine oil, drive belt, cooling system and brake system. Each of these is covered in this manual, and the Index will help you find them quickly. If you are trailering, it is a good idea to review this information before you start your trip.

Check periodically to see that all hitch nuts and bolts are tight.

## Engine Cooling When Trailer Towing

Your cooling system may temporarily overheat during severe operating conditions. See *Engine Overheating (3.8L V6 Engine)* on page 5-36 or *Engine Overheating (4.6L V8 Engine)* on page 5-38.



## Section 5 Service and Appearance Care

---

<b>Service</b> .....	5-3	Engine Overheating (3.8L V6 Engine) .....	5-36
Doing Your Own Service Work .....	5-4	Engine Overheating (4.6L V8 Engine) .....	5-38
Adding Equipment to the Outside of Your Vehicle .....	5-5	Overheated Engine Protection Operating Mode (4.6L V8 Engine) .....	5-40
<b>Fuel</b> .....	5-5	Cooling System (3.8L V6 Engine) .....	5-40
Gasoline Octane .....	5-5	Cooling System (4.6L V8 Engine) .....	5-47
Gasoline Specifications .....	5-6	Power Steering Fluid .....	5-52
California Fuel .....	5-6	Windshield Washer Fluid .....	5-53
Additives .....	5-6	Brakes .....	5-54
Fuels in Foreign Countries .....	5-7	Battery .....	5-57
Filling Your Tank .....	5-8	Jump Starting (3.8L V6 Engine) .....	5-59
Filling a Portable Fuel Container .....	5-10	Jump Starting (4.6L V8 Engine) .....	5-63
<b>Checking Things Under the Hood</b> .....	5-10	<b>Bulb Replacement</b> .....	5-67
Hood Release .....	5-11	Halogen Bulbs .....	5-67
Engine Compartment Overview .....	5-12	Headlamps .....	5-68
Engine Oil .....	5-16	Front Turn Signal and Parking Lamps .....	5-69
Engine Oil Life System .....	5-20	Taillamps, Turn Signal, Stoplamps and Back-up Lamps .....	5-71
Engine Air Cleaner/Filter (3.8L V6 Engine) .....	5-22	Replacement Bulbs .....	5-72
Engine Air Cleaner/Filter (4.6L V8 Engine) .....	5-23	<b>Windshield Wiper Blade Replacement</b> .....	5-73
Automatic Transaxle Fluid (3.8L V6 Engine) .....	5-25	<b>Tires</b> .....	5-74
Automatic Transaxle Fluid (4.6L V8 Engine) .....	5-28	Tire Sidewall Labelling .....	5-75
Engine Coolant (3.8L V6 Engine) .....	5-31	Tire Terminology and Definitions .....	5-77
Engine Coolant (4.6L V8 Engine) .....	5-34	Inflation - Tire Pressure .....	5-80
Radiator Pressure Cap (3.8L V6 Engine) .....	5-36	Check Tire Pressure System .....	5-83
Coolant Surge Tank Pressure Cap (4.6L V8 Engine) .....	5-36	Tire Inspection and Rotation .....	5-85

## Section 5 Service and Appearance Care

---

When It Is Time for New Tires .....	5-86	Windshield and Wiper Blades .....	5-106
Buying New Tires .....	5-86	Aluminum or Chrome-Plated Wheels .....	5-107
Uniform Tire Quality Grading .....	5-87	Tires .....	5-107
Wheel Alignment and Tire Balance .....	5-89	Sheet Metal Damage .....	5-108
Wheel Replacement .....	5-89	Finish Damage .....	5-108
Tire Chains .....	5-90	Underbody Maintenance .....	5-108
Accessory Inflator .....	5-91	Chemical Paint Spotting .....	5-108
If a Tire Goes Flat .....	5-92	Vehicle Care/Appearance Materials .....	5-109
Changing a Flat Tire .....	5-93	<b>Vehicle Identification</b> .....	5-110
Removing the Spare Tire and Tools .....	5-94	Vehicle Identification Number (VIN) .....	5-110
Removing the Flat Tire and Installing the Spare Tire .....	5-95	Service Parts Identification Label .....	5-110
Storing a Flat or Spare Tire and Tools .....	5-100	<b>Electrical System</b> .....	5-111
Compact Spare Tire .....	5-100	Add-On Electrical Equipment .....	5-111
<b>Appearance Care</b> .....	5-101	Headlamp Wiring .....	5-111
Fabric/Carpet .....	5-102	Windshield Wiper Fuses .....	5-111
Vinyl .....	5-103	Power Windows and Other Power Options .....	5-111
Leather .....	5-104	Fuses and Circuit Breakers .....	5-111
Instrument Panel .....	5-104	Engine Compartment Fuse Block (3.8L V6 Engine) .....	5-112
Interior Plastic Components .....	5-104	Engine Compartment Fuse Block (4.6L V8 Engine) .....	5-114
Glass Surfaces .....	5-104	Rear Underseat Fuse Block .....	5-116
Care of Safety Belts .....	5-104	<b>Capacities and Specifications</b> .....	5-121
Weatherstrips .....	5-105	<b>Normal Maintenance Replacement Parts</b> .....	5-122
Washing Your Vehicle .....	5-105		
Cleaning Exterior Lamps/Lenses .....	5-105		
Finish Care .....	5-106		

## Service

Your dealer knows your vehicle best and wants you to be happy with it. We hope you will go to your dealer for all your service needs. You will get genuine GM parts and GM-trained and supported service people.

We hope you will want to keep your GM vehicle all GM. Genuine GM parts have one of these marks:

***ACDelco***

---

**GM Parts**

---

**GM  
Goodwrench**

---

**GM Accessories**

## California Proposition 65 Warning

Most motor vehicles, including this one, contain and/or emit chemicals known to the State of California to cause cancer and birth defects or other reproductive harm. Engine exhaust, many parts and systems (including some inside the vehicle), many fluids, and some component wear by-products contain and/or emit these chemicals.

## Doing Your Own Service Work

If you want to do some of your own service work, you will want to use the proper service manual. It tells you much more about how to service your vehicle than this manual can. To order the proper service manual, see *Service Publications Ordering Information* on page 7-11.

Your vehicle has an airbag system. Before attempting to do your own service work, see *Servicing Your Airbag-Equipped Vehicle* on page 1-56.

You should keep a record with all parts receipts and list the mileage and the date of any service work you perform. See *Part E: Maintenance Record* on page 6-26.



### **CAUTION:**

**You can be injured and your vehicle could be damaged if you try to do service work on a vehicle without knowing enough about it.**

- **Be sure you have sufficient knowledge, experience, the proper replacement parts and tools before you attempt any vehicle maintenance task.**
- **Be sure to use the proper nuts, bolts and other fasteners. English and metric fasteners can be easily confused. If you use the wrong fasteners, parts can later break or fall off. You could be hurt.**



## Adding Equipment to the Outside of Your Vehicle

Things you might add to the outside of your vehicle can affect the airflow around it. This may cause wind noise and affect windshield washer performance. Check with your dealer before adding equipment to the outside of your vehicle.

## Fuel

The 8th digit of your vehicle identification number (VIN) shows the code letter or number that identifies your engine. You will find the VIN at the top left of the instrument panel. See *Vehicle Identification Number (VIN)* on page 5-110.

## Gasoline Octane

If your vehicle has the 3.8L V6 engine, use regular unleaded gasoline with a posted octane of 87 or higher. If the octane is less than 87, you may get a heavy knocking noise when you drive. If this occurs, use a gasoline rated at 87 octane or higher as soon as possible. Otherwise, you might damage your engine. A little pinging noise when you accelerate or drive uphill is considered normal. This does not indicate a problem exists or that a higher-octane fuel is necessary. If you are using 87 octane or higher-octane fuel and hear heavy knocking, your engine needs service.

If your vehicle has the 4.6L V8 engine, use regular unleaded gasoline with a posted octane of 87 or higher. However, for best performance, you may wish to use middle grade or premium unleaded gasoline. If the octane is less than 87, you may get a heavy knocking noise when you drive. If this occurs, use a gasoline rated at 87 octane or higher as soon as possible. Otherwise, you might damage your engine.

## Gasoline Specifications

It is recommended that gasoline meet specifications which were developed by automobile manufacturers around the world and contained in the World-Wide Fuel Charter which is available from the Alliance of Automobile Manufacturers at [www.autoalliance.org/fuel\\_charter.htm](http://www.autoalliance.org/fuel_charter.htm). Gasoline meeting these specifications could provide improved driveability and emission control system performance compared to other gasoline.

## California Fuel

If your vehicle is certified to meet California Emission Standards (see the underhood emission control label), it is designed to operate on fuels that meet California specifications. If this fuel is not available in states adopting California emissions standards, your vehicle will operate satisfactorily on fuels meeting federal specifications, but emission control system performance may be affected. The malfunction indicator lamp may turn on and your vehicle may fail a smog-check test. See *Malfunction Indicator Lamp on page 3-48*. If this occurs, return to your authorized GM dealer for diagnosis. If it is determined that the condition is caused by the type of fuel used, repairs may not be covered by your warranty.

## Additives

To provide cleaner air, all gasolines in the United States are now required to contain additives that will help prevent engine and fuel system deposits from forming, allowing your emission control system to work properly. In most cases, you should not have to add anything to your fuel. However, some gasolines contain only the minimum amount of additive required to meet U.S. Environmental Protection Agency regulations. General Motors recommends that you buy gasolines that are advertised to help keep fuel injectors and intake valves clean. If your vehicle experiences problems due to dirty injectors or valves, try a different brand of gasoline. Also, your GM dealer has additives that will help correct and prevent most deposit-related problems.

Gasolines containing oxygenates, such as ethers and ethanol, and reformulated gasolines may be available in your area to contribute to clean air. General Motors recommends that you use these gasolines, particularly if they comply with the specifications described earlier.

**Notice:** Your vehicle was not designed for fuel that contains methanol. Do not use fuel containing methanol. It can corrode metal parts in your fuel system and also damage the plastic and rubber parts. That damage would not be covered under your warranty.

Some gasolines that are not reformulated for low emissions may contain an octane-enhancing additive called methylcyclopentadienyl manganese tricarbonyl (MMT); ask the attendant where you buy gasoline whether the fuel contains MMT. General Motors does not recommend the use of such gasolines. Fuels containing MMT can reduce the life of spark plugs and the performance of the emission control system may be affected. The malfunction indicator lamp may turn on. If this occurs, return to your authorized GM dealer for service.

## Fuels in Foreign Countries

If you plan on driving in another country outside the United States or Canada, the proper fuel may be hard to find. Never use leaded gasoline or any other fuel not recommended in the previous text on fuel. Costly repairs caused by use of improper fuel would not be covered by your warranty.

To check the fuel availability, ask an auto club, or contact a major oil company that does business in the country where you will be driving.

## Filling Your Tank

### CAUTION:

Fuel vapor burns violently and a fuel fire can cause bad injuries. To help avoid injuries to you and others, read and follow all the instructions on the pump island. Turn off your engine when you are refueling. Do not smoke if you are near fuel or refueling your vehicle. Keep sparks, flames and smoking materials away from fuel. Do not leave the fuel pump unattended when refueling your vehicle — this is against the law in some places. Keep children away from the fuel pump; never let children pump fuel.

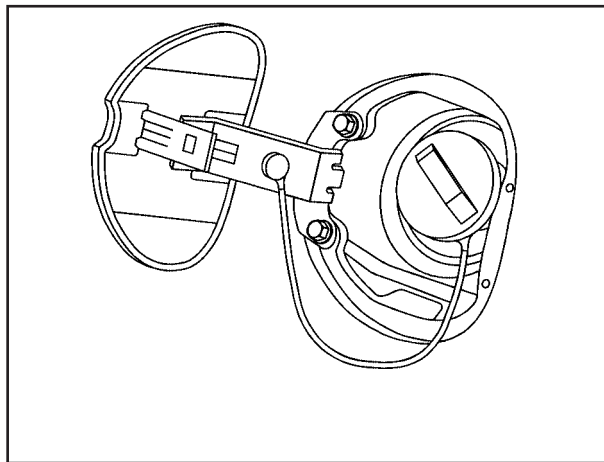

The tethered fuel cap is located behind a hinged fuel door on the driver's side of the vehicle.

To remove the fuel cap, turn it slowly to the left (counterclockwise). The fuel cap has a spring in it; if the cap is released too soon, it will spring back to the right.

While refueling, hang the tethered fuel cap on the hook on the inside of the fuel door.

 **CAUTION:**

If you spill fuel and then something ignites it, you could be badly burned. Fuel can spray out on you if you open the fuel cap too quickly. This spray can happen if your tank is nearly full, and is more likely in hot weather. Open the fuel cap slowly and wait for any hiss noise to stop. Then unscrew the cap all the way.

Be careful not to spill fuel. Do not top off or overfill the tank and wait a few seconds after you have finished pumping before removing the nozzle. Clean fuel from painted surfaces as soon as possible. See *Washing Your Vehicle on page 5-105*.

When replacing the fuel cap, turn it to the right (clockwise) until it clicks. Make sure the cap is fully installed. The diagnostic system can determine if the fuel cap has been left off or improperly installed. This would allow fuel to evaporate into the atmosphere. See *Malfunction Indicator Lamp on page 3-48*.

If your vehicle has the optional Driver Information Center (DIC), the CHECK GAS CAP message will be displayed if the fuel cap is not properly reinstalled.

 **CAUTION:**

If a fire starts while you are refueling, do not remove the nozzle. Shut off the flow of fuel by shutting off the pump or by notifying the station attendant. Leave the area immediately.

**Notice:** If you need a new fuel cap, be sure to get the right type. Your dealer can get one for you. If you get the wrong type, it may not fit properly. This may cause your malfunction indicator lamp to light and may damage your fuel tank and emissions system. See *Malfunction Indicator Lamp on page 3-48*.

## Filling a Portable Fuel Container

### CAUTION:

Never fill a portable fuel container while it is in your vehicle. Static electricity discharge from the container can ignite the gasoline vapor. You can be badly burned and your vehicle damaged if this occurs. To help avoid injury to you and others:

- Dispense gasoline only into approved containers.
- Do not fill a container while it is inside a vehicle, in a vehicle's trunk, pickup bed or on any surface other than the ground.
- Bring the fill nozzle in contact with the inside of the fill opening before operating the nozzle. Contact should be maintained until the filling is complete.
- Do not smoke while pumping gasoline.

## Checking Things Under the Hood

### CAUTION:

An electric fan under the hood can start up and injure you even when the engine is not running. Keep hands, clothing and tools away from any underhood electric fan.

### CAUTION:

Things that burn can get on hot engine parts and start a fire. These include liquids like fuel, oil, coolant, brake fluid, windshield washer and other fluids, and plastic or rubber. You or others could be burned. Be careful not to drop or spill things that will burn onto a hot engine.

## Hood Release

To open the hood, do the following:



1. Pull the hood release handle inside the vehicle. It is located next to the parking brake pedal near the floor.



2. Then go to the front of the vehicle and push up on the secondary hood release.
3. Lift the hood.

Before closing the hood, be sure all the filler caps are on properly. Then pull the hood down and close it firmly.

## Engine Compartment Overview

When you open the hood on the 3.8L V6 engine, here is what you will see:





- A. Engine Compartment Fuse Block. See *Engine Compartment Fuse Block (3.8L V6 Engine)* on page 5-112 or *Engine Compartment Fuse Block (4.6L V8 Engine)* on page 5-114.
- B. Windshield Washer Fluid Reservoir. See “Adding Washer Fluid” under *Windshield Washer Fluid* on page 5-53.
- C. Engine Coolant Recovery Tank. See “Checking Coolant” under *Engine Coolant (3.8L V6 Engine)* on page 5-31 or *Engine Coolant (4.6L V8 Engine)* on page 5-34.
- D. Radiator Pressure Cap. See *Radiator Pressure Cap (3.8L V6 Engine)* on page 5-36.
- E. Power Steering Fluid Reservoir. See *Power Steering Fluid* on page 5-52.
- F. Engine Oil Dipstick. See “Checking Engine Oil” under *Engine Oil* on page 5-16.
- G. Engine Oil Fill Cap. See “When to Add Engine Oil” under *Engine Oil* on page 5-16.
- H. Automatic Transaxle Fluid Dipstick. See “Checking the Fluid Level” under *Automatic Transaxle Fluid (3.8L V6 Engine)* on page 5-25 or *Automatic Transaxle Fluid (4.6L V8 Engine)* on page 5-28.
- I. Brake Master Cylinder. See “Brake Fluid” under *Brakes* on page 5-54.
- J. Engine Air Cleaner/Filter. See *Engine Air Cleaner/Filter (3.8L V6 Engine)* on page 5-22 or *Engine Air Cleaner/Filter (4.6L V8 Engine)* on page 5-23.

When you open the hood on the 4.6L V8 engine, here is what you will see:

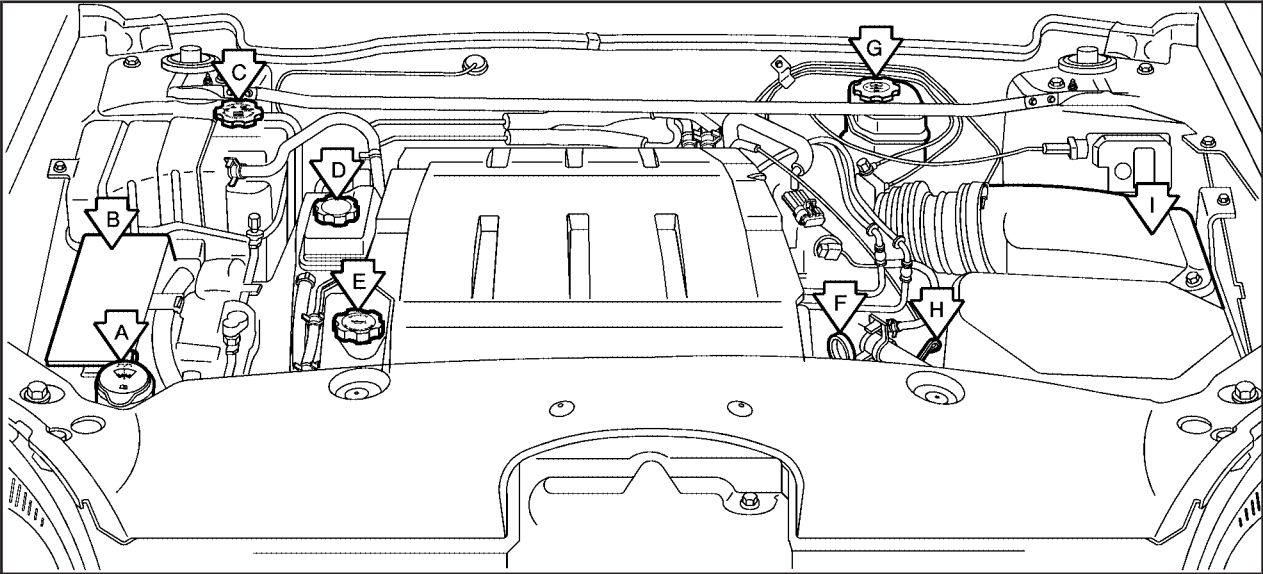

- A. Windshield Washer Fluid Reservoir. See “Adding Washer Fluid” under *Windshield Washer Fluid* on page 5-53.
- B. Engine Compartment Fuse Block. See *Engine Compartment Fuse Block (3.8L V6 Engine)* on page 5-112 or *Engine Compartment Fuse Block (4.6L V8 Engine)* on page 5-114.
- C. Engine Coolant Surge Tank and Pressure Cap. See *Coolant Surge Tank Pressure Cap (4.6L V8 Engine)* on page 5-36 and *Cooling System (3.8L V6 Engine)* on page 5-40 or *Cooling System (4.6L V8 Engine)* on page 5-47.
- D. Power Steering Fluid Reservoir. See *Power Steering Fluid* on page 5-52.
- E. Engine Oil Fill Cap. See “When to Add Engine Oil” under *Engine Oil* on page 5-16.
- F. Engine Oil Dipstick. See “Checking Engine Oil” under *Engine Oil* on page 5-16.
- G. Brake Master Cylinder. See “Brake Fluid” under *Brakes* on page 5-54.
- H. Automatic Transaxle Fluid Cap and Dipstick. See “Checking the Fluid Level” under *Automatic Transaxle Fluid (3.8L V6 Engine)* on page 5-25 or *Automatic Transaxle Fluid (4.6L V8 Engine)* on page 5-28.
- I. Engine Air Cleaner/Filter. See *Engine Air Cleaner/Filter (3.8L V6 Engine)* on page 5-22 or *Engine Air Cleaner/Filter (4.6L V8 Engine)* on page 5-23.

## Engine Oil



If the CHECK OIL LEVEL light appears on the instrument cluster, or the OIL LEVEL LOW message appears on the DIC, it means you need to check your engine oil level right away.

For more information, see *Check Oil Level Light* on page 3-53 or *DIC Warnings and Messages* on page 3-62.

You should check your engine oil level regularly; this is an added reminder.

## Checking Engine Oil

It is a good idea to check your engine oil every time you get fuel. In order to get an accurate reading, the oil must be warm and the vehicle must be on level ground.

The engine oil dipstick handle is a yellow loop. See *Engine Compartment Overview* on page 5-12 for the location of the engine oil dipstick.

1. Turn off the engine and give the oil several minutes to drain back into the oil pan. If you do not do this, the oil dipstick might not show the actual level.
2. Pull out the dipstick and clean it with a paper towel or cloth, then push it back in all the way. Remove it again, keeping the tip down, and check the level.

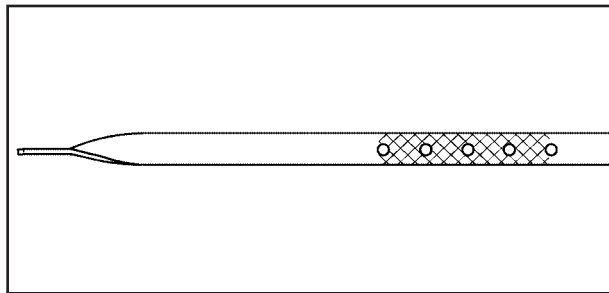

3.8L V6 Engine

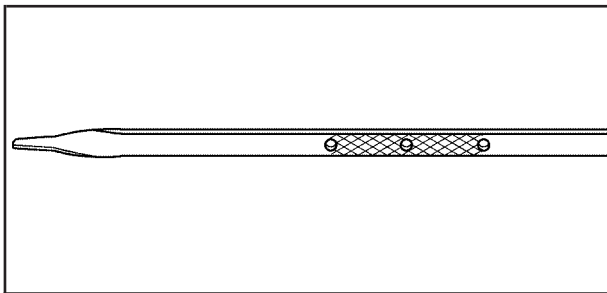

4.6L V8 Engine

## When to Add Engine Oil

If the oil is at or below the cross-hatched area at the tip of the dipstick, then you will need to add at least one quart of oil. But you must use the right kind. This section explains what kind of oil to use. For engine oil crankcase capacity, see *Capacities and Specifications* on page 5-121.

**Notice:** Do not add too much oil. If your engine has so much oil that the oil level gets above the cross-hatched area that shows the proper operating range, your engine could be damaged.



See *Engine Compartment Overview* on page 5-12 for the location of the engine oil fill cap.

Be sure to add enough oil to put the level somewhere in the proper operating range in the cross-hatched area. Push the dipstick all the way back in when you are through.

## What Kind of Engine Oil to Use

Look for two things:

- GM6094M

Your vehicle's engine requires oil meeting GM Standard GM6094M. You should look for and use only an oil that meets GM Standard GM6094M.

RECOMMENDED SAE VISCOSITY GRADE ENGINE OILS

HOT WEATHER

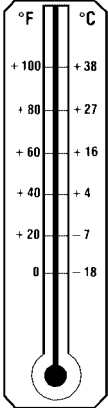

COLD WEATHER

LOOK FOR THIS SYMBOL AND GM STANDARD GM 6094M



SAE 5W-30

DO NOT USE SAE 10W-40, SAE 20W-50 OR ANY OTHER VISCOSITY GRADE OIL NOT RECOMMENDED

- SAE 5W-30

As shown in the viscosity chart, SAE 5W-30 is best for your vehicle.

These numbers on an oil container show its viscosity, or thickness. Do not use other viscosity oils such as SAE 20W-50.



Oils meeting these requirements should also have the starburst symbol on the container. This symbol indicates that the oil has been certified by the American Petroleum Institute (API).

You should look for this information on the oil container, and use *only* those oils that are identified as meeting GM Standard GM6094M and have the starburst symbol on the front of the oil container.

**Notice:** Use only engine oil identified as meeting GM Standard GM6094M and showing the American Petroleum Institute Certified For Gasoline Engines starburst symbol. Failure to use the recommended oil can result in engine damage not covered by your warranty.

GM Goodwrench® oil meets all the requirements for your vehicle.

If you are in an area of extreme cold, where the temperature falls below  $-20^{\circ}\text{F}$  ( $-29^{\circ}\text{C}$ ) it is recommended that you use either an SAE 5W-30 synthetic oil or an SAE 0W-30 oil. Both will provide easier cold starting and better protection for your engine at extremely low temperatures.

## Engine Oil Additives

Do not add anything to your oil. The recommended oils with the starburst symbol that meet GM Standard GM6094M are all you will need for good performance and engine protection.

## When to Change Engine Oil (Vehicles Without the Engine Oil Life System)

If any one of these is true for you, use the short trip/city maintenance schedule:

- Most trips are less than 5 miles (8 km). This is particularly important when outside temperatures are below freezing.
- Most trips include extensive idling, such as frequent driving in stop-and-go traffic.
- You frequently tow a trailer or use a carrier on top of your vehicle.
- The vehicle is used for delivery service, police, taxi, or other commercial application.

Driving under these conditions causes engine oil to break down sooner. If any one of these is true for your vehicle, then you need to change your oil and filter every 3,000 miles (5 000 km) or 3 months — whichever occurs first.

If none of them is true, use the long trip/highway maintenance schedule. Change the oil and filter every 7,500 miles (12 500 km) or 12 months — whichever occurs first. Driving a vehicle with a fully warmed engine under highway conditions will cause engine oil to break down slower.

If your vehicle has the Engine Oil Life System, see *Engine Oil Life System on page 5-20* for information on when to change your engine oil.

## Engine Oil Life System

### When to Change Engine Oil

If your vehicle has the Engine Oil Life System, it has a computer system that lets you know when to change the engine oil and filter. This is based on engine revolutions and engine temperature and not on mileage. Based on driving conditions, the mileage at which an oil change will be indicated can vary considerably. For the oil life system to work properly, you must reset the system every time the oil is changed.

When the system has calculated that oil life has been diminished, it will indicate that an oil change is necessary. An **ENGINE OIL CHANGE SOON DIC** message will come on. See *DIC Warnings and Messages on page 3-62*. Change your oil as soon as possible within the next 600 miles (1 000 km). It is possible that, if you are driving under the best conditions, the oil life system may not indicate that an oil change is necessary for over a year. However, your engine oil and filter must be changed at least once a year and at this time the system must be reset. Your dealer has GM-trained service people who will perform this work using genuine GM parts and reset the system. It is also important to check your oil regularly and keep it at the proper level.



If the system is ever reset accidentally, you must change your oil at 3,000 miles (5 000 km) since your last oil change. Remember to reset the oil life system whenever the oil is changed.

## **How to Reset the Engine Oil Life System**

The Engine Oil Life System calculates when to change your engine oil and filter based on vehicle use. Anytime your oil is changed, reset the system so it can calculate when the next oil change is required. If a situation occurs where you change your oil prior to an ENGINE OIL CHANGE SOON DIC message being turned on, reset the system.

Always reset the engine oil life to 100% after every oil change. It will not reset itself. To reset the Engine Oil Life System, do the following:

1. Display OIL LIFE on the DIC.
2. Press and hold the RESET button for more than five seconds. The oil life will change to 100%.
3. Turn the key to OFF.

If the ENGINE OIL CHANGE SOON DIC message comes back on when you start your vehicle, the Engine Oil Life System has not reset. Repeat the procedure.

## **What to Do with Used Oil**

Used engine oil contains certain elements that may be unhealthy for your skin and could even cause cancer. Do not let used oil stay on your skin for very long. Clean your skin and nails with soap and water, or a good hand cleaner. Wash or properly dispose of clothing or rags containing used engine oil. See the manufacturer's warnings about the use and disposal of oil products.

Used oil can be a threat to the environment. If you change your own oil, be sure to drain all the oil from the filter before disposal. Never dispose of oil by putting it in the trash, pouring it on the ground, into sewers, or into streams or bodies of water. Instead, recycle it by taking it to a place that collects used oil. If you have a problem properly disposing of your used oil, ask your dealer, a service station or a local recycling center for help.

## Engine Air Cleaner/Filter (3.8L V6 Engine)



See *Engine Compartment Overview* on page 5-12 for the location of the engine air cleaner/filter.

## When to Inspect the Engine Air Cleaner/Filter

Inspect the air cleaner/filter every 15,000 miles (25 000 km) and replace every 45,000 miles (75 000 km). If you are driving in dusty/dirty conditions, inspect the filter at each engine oil change.

## How to Inspect the Engine Air Cleaner/Filter

To inspect the air cleaner/filter remove the filter from the vehicle and lightly shake the filter to release loose dust and dirt. If the filter remains caked with dirt, a new filter is required.

To inspect or replace the engine air cleaner/filter do the following:

1. Loosen the two clips on top of the engine air cleaner/filter housing and lift the filter cover tabs out of the housing.
2. Push the housing cover toward the engine, compressing the hose.
3. Pull out the filter. Inspect or replace the engine air cleaner/filter.

4. To reinstall the housing cover, make sure the filter cover tabs position through the slots in the housing. A notch on the sides of the filter cover will indicate the correct engagement.
5. Fasten the two clips on the top of the housing when you are finished.

 **CAUTION:**

**Operating the engine with the air cleaner/filter off can cause you or others to be burned. The air cleaner not only cleans the air; it helps to stop flame if the engine backfires. If it is not there and the engine backfires, you could be burned. Do not drive with it off, and be careful working on the engine with the air cleaner/filter off.**

**Notice:** If the air cleaner/filter is off, a backfire can cause a damaging engine fire. And, dirt can easily get into your engine, which will damage it. Always have the air cleaner/filter in place when you are driving.

## **Engine Air Cleaner/Filter (4.6L V8 Engine)**

See *Engine Compartment Overview* on page 5-12 for the location of the engine air cleaner/filter.

### **When to Inspect the Engine Air Cleaner/Filter**

Inspect the air cleaner/filter every 15,000 miles (25 000 km) and replace every 45,000 miles (75 000 km). If you are driving in dusty/dirty conditions, inspect the filter at each engine oil change.

### **How to Inspect the Engine Air Cleaner/Filter**

To inspect the air cleaner/filter remove the filter from the vehicle and lightly shake the filter to release loose dust and dirt. If the filter remains caked with dirt, a new filter is required.

To inspect or replace the engine air cleaner/filter, do the following:

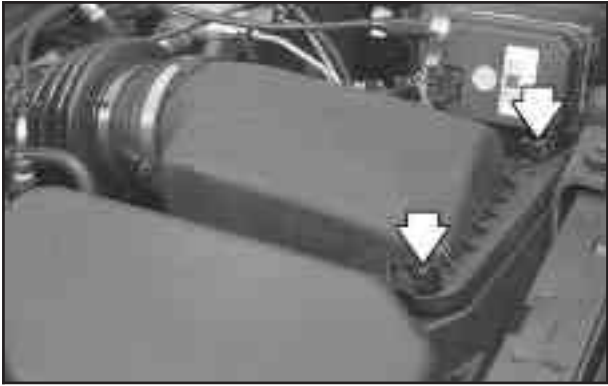

1. Loosen and remove both wing screws on the top of the engine air cleaner/filter cover.
2. Lift up the outboard side of the cover at an angle while pulling toward you. This is necessary due to the three tabs located on the rear of the cover.

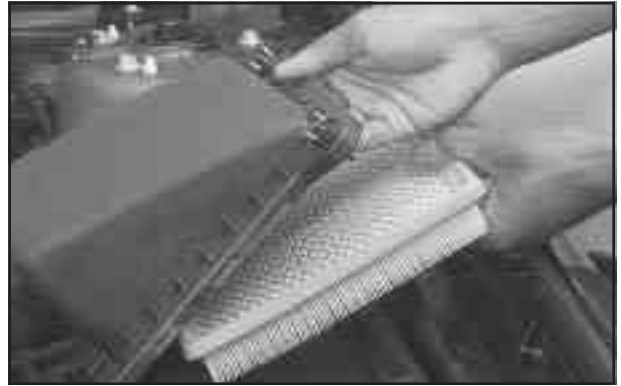

3. Remove the engine air cleaner/filter element and any loose debris that may be found in the air cleaner base.
4. Inspect or replace the air filter element.

Follow these steps to reinstall the cover to the engine air cleaner/filter housing:

1. Align the three tabs located on the back of the cover with the three slots on the back of the housing.
2. Push the cover slightly down and towards the engine to engage the tabs in the slots and align the two wing screws.
3. Engage and tighten the two wing screws on the top of the engine air cleaner/filter housing cover.

### **CAUTION:**

**Operating the engine with the air cleaner/filter off can cause you or others to be burned. The air cleaner not only cleans the air; it helps to stop flame if the engine backfires. If it is not there and the engine backfires, you could be burned. Do not drive with it off, and be careful working on the engine with the air cleaner/filter off.**

**Notice:** If the air cleaner/filter is off, a backfire can cause a damaging engine fire. And, dirt can easily get into your engine, which will damage it. Always have the air cleaner/filter in place when you are driving.

## **Automatic Transaxle Fluid (3.8L V6 Engine)**

### **When to Check and Change**

A good time to check your automatic transaxle fluid level is when the engine oil is changed.

Change both the fluid and filter every 50,000 miles (83 000 km) if the vehicle is mainly driven under one or more of these conditions:

- In heavy city traffic where the outside temperature regularly reaches 90°F (32°C) or higher.
- In hilly or mountainous terrain.
- When doing frequent trailer towing.
- Uses such as found in taxi, police or delivery service.

If you do not use your vehicle under any of these conditions, change the fluid and filter at 100,000 miles (166 000 km).

See *Part A: Scheduled Maintenance Services on page 6-4.*

## How to Check

Because this operation can be a little difficult, you may choose to have this done at the dealership service department.

If you do it yourself, be sure to follow all the instructions here, or you could get a false reading on the dipstick.

**Notice:** Too much or too little fluid can damage the transaxle. Too much can mean that some of the fluid could come out and fall on hot engine or exhaust system parts, starting a fire. Too little fluid could cause the transaxle to overheat. Be sure to get an accurate reading if you check the transaxle fluid.

Wait at least 30 minutes before checking the transaxle fluid level if you have been driving:

- When outside temperatures are above 90°F (32°C).
- At high speed for quite a while.
- In heavy traffic — especially in hot weather.
- While pulling a trailer.

To get the right reading, the fluid should be at normal operating temperature, which is 180°F to 200°F (82°C to 93°C).

Get the vehicle warmed up by driving about 15 miles (24 km) when outside temperatures are above 50°F (10°C). If it is colder than 50°F (10°C), you may have to drive longer.

## Checking the Fluid Level

Prepare your vehicle as follows:

- Park your vehicle on a level place. Keep the engine running.
- With the parking brake applied, place the shift lever in PARK (P).
- With your foot on the brake pedal, move the shift lever through each gear range, pausing for about three seconds in each range. Then, position the shift lever in PARK (P).
- Let the engine run at idle for three to five minutes.

Then, without shutting off the engine, follow these steps:



The transaxle fluid dipstick top is a round, red loop and is located next to the brake master cylinder behind the engine block. See *Engine Compartment Overview* on page 5-12 for more information on location.

1. Pull out the dipstick and wipe it with a clean rag or paper towel.
2. Push it back in all the way, wait three seconds and then pull it back out again.



3. Check both sides of the dipstick, and read the lower level. The fluid level must be in the cross-hatched area.
4. If the fluid level is in the acceptable range, push the dipstick back in all the way.

## How to Add Fluid

Refer to the Maintenance Schedule to determine what kind of transaxle fluid to use. See *Part D: Recommended Fluids and Lubricants on page 6-24*.

If the fluid level is low, add only enough of the proper fluid to bring the level into the cross-hatched area on the dipstick.

1. Pull out the dipstick.
2. Using a long-neck funnel, add enough fluid at the dipstick hole to bring it to the proper level.

It does not take much fluid, generally less than one pint (0.5 L). *Do not overfill.*

**Notice:** Use of automatic transaxle fluid labeled other than DEXRON®-III, Approved for the H-Specification, may damage your vehicle, and the damages may not be covered by your warranty. Always use automatic transaxle fluid labeled DEXRON®-III, Approved for the H-Specification.

3. After adding fluid, recheck the fluid level as described under “How to Check,” earlier in this section.
4. When the correct fluid level is obtained, push the dipstick back in all the way.

## Automatic Transaxle Fluid (4.6L V8 Engine)

### When to Check and Change

A good time to check your automatic transaxle fluid level is when the engine oil is changed.

Change both the fluid and filter every 50,000 miles (83 000 km) if the vehicle is mainly driven under one or more of these conditions:

- In heavy city traffic where the outside temperature regularly reaches 90°F (32°C) or higher.
- In hilly or mountainous terrain.
- When doing frequent trailer towing.
- Uses such as found in taxi, police or delivery service.
- Use such as limousine service.

If you do not use your vehicle under any of these conditions, change the fluid and filter at 100,000 miles (166 000 km).

See *Part A: Scheduled Maintenance Services on page 6-4*.



## How to Check

Because this operation can be a little difficult, you may choose to have this done at the dealership service department.

If you do it yourself, be sure to follow all the instructions here, or you could get a false reading on the dipstick.

**Notice:** Too much or too little fluid can damage the transaxle. Too much can mean that some of the fluid could come out and fall on hot engine or exhaust system parts, starting a fire. Too little fluid could cause the transaxle to overheat. Be sure to get an accurate reading if you check the transaxle fluid.

Wait at least 30 minutes before checking the transaxle fluid level if you have been driving:

- When outside temperatures are above 90°F (32°C).
- At high speed for quite a while.
- In heavy traffic — especially in hot weather.
- While pulling a trailer.

To get the right reading, the fluid should be at normal operating temperature, which is 180°F to 200°F (82°C to 93°C).

Get the vehicle warmed up by driving about 15 miles (24 km) when outside temperatures are above 50°F (10°C). If it is colder than 50° F (10°C), you may have to drive longer.

## Checking the Fluid Level

Prepare your vehicle as follows:

- Park your vehicle on a level place. Keep the engine running.
- With the parking brake applied, place the shift lever in PARK (P).
- With your foot on the brake pedal, move the shift lever through each gear range, pausing for about three seconds in each range. Then, position the shift lever in PARK (P).
- Let the engine run at idle for three to five minutes.

Then, without shutting off the engine, follow these steps:



The transaxle fluid cap is located next to the radiator hose and below the engine air cleaner/filter assembly on the driver's side of the vehicle.

See *Engine Compartment Overview* on page 5-12 for more information on location.



1. After removing the engine air cleaner/filter assembly to reach the transaxle fluid cap, turn the cap counterclockwise to remove. Pull out the dipstick and wipe it with a clean rag or paper towel.
2. Push it back in all the way, wait three seconds, and then pull it back out again.

3. Check both sides of the dipstick, and read the lower level. The fluid level must be in the cross-hatched area.
4. If the fluid level is in the acceptable range, push the dipstick back in all the way and turn the handle clockwise. Reinstall the engine air cleaner/filter assembly.

## How to Add Fluid

Refer to the Maintenance Schedule to determine what kind of transaxle fluid to use. See *Part D: Recommended Fluids and Lubricants* on page 6-24.

If the fluid level is low, add only enough of the proper fluid to bring the level into the cross-hatched area on the dipstick.

1. Pull out the dipstick.
2. Using a long-neck funnel, add enough fluid at the dipstick hole to bring it to the proper level.

It does not take much fluid, generally less than one pint (0.5 L). *Do not overfill.*

**Notice:** Use of automatic transaxle fluid labeled other than DEXRON®-III, Approved for the H-Specification, may damage your vehicle, and the damages may not be covered by your warranty. Always use automatic transaxle fluid labeled DEXRON®-III, Approved for the H-Specification.

3. After adding fluid, recheck the fluid level as described under “How to Check,” earlier in this section.
4. When the correct fluid level is obtained, push the dipstick back in all the way and turn the handle clockwise.

## Engine Coolant (3.8L V6 Engine)

The cooling system in your vehicle is filled with DEX-COOL® engine coolant. This coolant is designed to remain in your vehicle for 5 years or 150,000 miles (240 000 km), whichever occurs first, if you add only extended life coolant.

The following explains your cooling system and how to add coolant when it is low. If you have a problem with engine overheating, see *Engine Overheating (3.8L V6 Engine)* on page 5-36 or *Engine Overheating (4.6L V8 Engine)* on page 5-38.

A 50/50 mixture of clean, drinkable water and DEX-COOL® coolant will:

- Give freezing protection down to -34°F (-37°C).
- Give boiling protection up to 265°F (129°C).
- Protect against rust and corrosion.
- Help keep the proper engine temperature.
- Let the warning lights and gages work as they should.

**Notice:** Using coolant other than DEX-COOL® may cause premature engine, heater core or radiator corrosion. In addition, the engine coolant may require changing sooner, at 30,000 miles (50 000 km) or 24 months, whichever occurs first. Any repairs would not be covered by your warranty. Always use DEX-COOL® (silicate-free) coolant in your vehicle.

## What to Use

Use a mixture of one-half *clean, drinkable water* and one-half DEX-COOL<sup>®</sup> coolant which will not damage aluminum parts. If you use this coolant mixture, you do not need to add anything else.

### CAUTION:

Adding only plain water to your cooling system can be dangerous. Plain water, or some other liquid such as alcohol, can boil before the proper coolant mixture will. Your vehicle's coolant warning system is set for the proper coolant mixture. With plain water or the wrong mixture, your engine could get too hot but you would not get the overheat warning. Your engine could catch fire and you or others could be burned. Use a 50/50 mixture of clean, drinkable water and DEX-COOL<sup>®</sup> coolant.

**Notice:** If you use an improper coolant mixture, your engine could overheat and be badly damaged. The repair cost would not be covered by your warranty. Too much water in the mixture can freeze and crack the engine, radiator, heater core and other parts.

If you have to add coolant more than four times a year, have your dealer check your cooling system.

**Notice:** If you use the proper coolant, you do not have to add extra inhibitors or additives which claim to improve the system. These can be harmful.

## Checking Coolant



The engine coolant recovery tank is located in the engine compartment on the passenger's side of the vehicle, near the windshield. See *Engine Compartment Overview* on page 5-12 for more information on location.

The vehicle must be on a level surface. When your engine is cold, the coolant level should be at the FULL COLD mark or a little higher. When your engine is warm, the level should be up to the FULL HOT mark or a little higher.

## Adding Coolant

If you need more coolant, add the proper DEX-COOL® coolant mixture *at the coolant recovery tank*, but be careful not to spill it.

### CAUTION:

Turning the radiator pressure cap when the engine and radiator are hot can allow steam and scalding liquids to blow out and burn you badly. With the coolant recovery tank, you will almost never have to add coolant at the radiator. Never turn the radiator pressure cap — even a little — when the engine and radiator are hot.

### CAUTION:

You can be burned if you spill coolant on hot engine parts. Coolant contains ethylene glycol, and it will burn if the engine parts are hot enough. Do not spill coolant on a hot engine.

Occasionally check the coolant level in the radiator. For information on how to add coolant to the radiator, see *Cooling System (3.8L V6 Engine)* on page 5-40 or *Cooling System (4.6L V8 Engine)* on page 5-47.

## Engine Coolant (4.6L V8 Engine)

The cooling system in your vehicle is filled with DEX-COOL<sup>®</sup> engine coolant. This coolant is designed to remain in your vehicle for 5 years or 150,000 miles (240 000 km), whichever occurs first, if you add only DEX-COOL<sup>®</sup> extended life coolant.

The following explains your cooling system and how to add coolant when it is low. If you have a problem with engine overheating, see *Engine Overheating (3.8L V6 Engine)* on page 5-36 or *Engine Overheating (4.6L V8 Engine)* on page 5-38.

A 50/50 mixture of clean, drinkable water and DEX-COOL<sup>®</sup> coolant will:

- Giving freezing protection down to -34°F (-37°C).
- Give boiling protection up to 265°F (129°C).
- Protect against rust and corrosion.
- Help keep the proper engine temperature.
- Let the warning lights and gages work as they should.

**Notice:** Using coolant other than DEX-COOL<sup>®</sup> may cause premature engine, heater core or radiator corrosion. In addition, the engine coolant may require changing sooner, at 30,000 miles (50 000 km) or 24 months, whichever occurs first. Any repairs would not be covered by your warranty. Always use DEX-COOL<sup>®</sup> (silicate-free) coolant in your vehicle.

## What to Use

Use a mixture of one-half *clean, drinkable water* and one-half DEX-COOL<sup>®</sup> coolant which will not damage aluminum parts. If you use this coolant mixture, you do not need to add anything else.

### CAUTION:

Adding only plain water to your cooling system can be dangerous. Plain water, or some other liquid such as alcohol, can boil before the proper coolant mixture will. Your vehicle's coolant warning system is set for the proper coolant mixture. With plain water or the wrong mixture, your engine could get too hot but you would not get the overheat warning. Your engine could catch fire and you or others could be burned. Use a 50/50 mixture of clean, drinkable water and DEX-COOL<sup>®</sup> coolant.

**Notice:** If you use an improper coolant mixture, your engine could overheat and be badly damaged. The repair cost would not be covered by your warranty. Too much water in the mixture can freeze and crack the engine, radiator, heater core and other parts.

If you have to add coolant more than four times a year, have your dealer check your cooling system.

**Notice:** If you use the proper coolant, you do not have to add extra inhibitors or additives which claim to improve the system. These can be harmful.

## Checking Coolant



The engine coolant surge tank is located toward the rear of the engine compartment on the passenger's side of the vehicle. See *Engine Compartment Overview* on page 5-12 for more information on location.

The vehicle must be on a level surface. When your engine is cold, the coolant level should be at the FULL COLD mark which is located on the side of the surge tank that faces the engine.

If the LOW ENGINE COOLANT message comes on and stays on, it means you are low on engine coolant.

See *DIC Warnings and Messages* on page 3-62 for more information.

## Adding Coolant

If you need more coolant, add the proper DEX-COOL<sup>®</sup> coolant mixture *at the surge tank*, but only when the engine is cool.

### CAUTION:

Turning the surge tank pressure cap when the engine and radiator are hot can allow steam and scalding liquids to blow out and burn you badly. Never turn the surge tank pressure cap — even a little — when the engine and radiator are hot.

 **CAUTION:**

You can be burned if you spill coolant on hot engine parts. Coolant contains ethylene glycol, and it will burn if the engine parts are hot enough. Do not spill coolant on a hot engine.

When replacing the pressure cap, make sure the arrow lines up with the tube.

## Radiator Pressure Cap (3.8L V6 Engine)

**Notice:** The radiator cap on your vehicle is a pressure-type cap and must be tightly installed to prevent coolant loss and possible engine damage from overheating. Be sure the arrows on the cap line up with the overflow tube on the radiator filler neck.

See *Engine Compartment Overview* on page 5-12 for more information on location.

## Coolant Surge Tank Pressure Cap (4.6L V8 Engine)

**Notice:** If the pressure cap is not tightly installed, coolant loss and possible engine damage may occur. Be sure the cap is properly and tightly secured.

See *Engine Compartment Overview* on page 5-12 for more information on location.

## Engine Overheating (3.8L V6 Engine)

You will find a coolant temperature gage or a DIC warning message about a hot engine on your vehicle's instrument panel. See *Engine Coolant Temperature Gage (V6 Engine)* on page 3-45 or *Engine Coolant Temperature Gage (V8 Engine)* on page 3-46 and *DIC Warnings and Messages* on page 3-62.



## If Steam Is Coming From Your Engine

### CAUTION:

Steam from an overheated engine can burn you badly, even if you just open the hood. Stay away from the engine if you see or hear steam coming from it. Just turn it off and get everyone away from the vehicle until it cools down. Wait until there is no sign of steam or coolant before you open the hood.

If you keep driving when your engine is overheated, the liquids in it can catch fire. You or others could be badly burned. Stop your engine if it overheats, and get out of the vehicle until the engine is cool.

**Notice:** If your engine catches fire because you keep driving with no coolant, your vehicle can be badly damaged. The costly repairs would not be covered by your warranty.

## If No Steam Is Coming From Your Engine

If you get an engine overheat warning but see or hear no steam, the problem may not be too serious. Sometimes the engine can get a little too hot when you:

- Climb a long hill on a hot day.
- Stop after high-speed driving.
- Idle for long periods in traffic.
- Tow a trailer.

If you get the overheat warning with no sign of steam, try this for a minute or so:

1. In heavy traffic, let the engine idle in NEUTRAL (N) while stopped. If it is safe to do so, pull off the road, shift to PARK (P) or NEUTRAL (N) and let the engine idle.
2. Turn on your heater to full hot at the highest fan speed and open the windows as necessary.

If you no longer have the overheat warning, you can drive. Just to be safe, drive slower for about 10 minutes. If the warning does not come back on, you can drive normally.

If the warning continues and you have not stopped, pull over, stop, and park your vehicle right away.

If there is still no sign of steam, you can idle the engine for three minutes while you are parked. If you still have the warning, *turn off the engine and get everyone out of the vehicle* until it cools down.

You may decide not to lift the hood but to get service help right away.

## Engine Overheating (4.6L V8 Engine)

You will find an ENGINE HOT, IDLE ENGINE message or an ENGINE HOT, STOP ENGINE message displayed in the Driver Information Center (DIC). There is also an engine coolant temperature gage on the instrument panel cluster. See *DIC Warnings and Messages on page 3-62* and *Engine Coolant Temperature Gage (V6 Engine) on page 3-45* or *Engine Coolant Temperature Gage (V8 Engine) on page 3-46*.

## If Steam Is Coming From Your Engine

### CAUTION:

**Steam from an overheated engine can burn you badly, even if you just open the hood. Stay away from the engine if you see or hear steam coming from it. Just turn it off and get everyone away from the vehicle until it cools down. Wait until there is no sign of steam or coolant before you open the hood.**

**If you keep driving when your engine is overheated, the liquids in it can catch fire. You or others could be badly burned. Stop your engine if it overheats, and get out of the vehicle until the engine is cool.**

**See *Overheated Engine Protection Operating Mode (4.6L V8 Engine) on page 5-40* for information on driving to a safe place in an emergency.**

**Notice:** If your engine catches fire because you keep driving with no coolant, your vehicle can be badly damaged. The costly repairs would not be covered by your warranty. See *Overheated Engine Protection Operating Mode (4.6L V8 Engine)* on page 5-40 for information on driving to a safe place in an emergency.

## If No Steam Is Coming From Your Engine

An overheat warning, along with a low coolant message, can indicate a serious problem. See *DIC Warnings and Messages* on page 3-62.

If you get an engine overheat warning with no low coolant message, but see or hear no steam, the problem may not be too serious. Sometimes the engine can get a little too hot when you:

- Climb a long hill on a hot day.
- Stop after high-speed driving.
- Idle for long periods in traffic.

If you get the overheat warning with no sign of steam, try this for a minute or so:

1. In heavy traffic, let the engine idle in NEUTRAL (N) while stopped. If it safe to do so, pull off the road, shift to PARK (P) or NEUTRAL (N) and let the engine idle.
2. Set the climate controls to the highest heat setting and fan speed and open the windows as necessary.

If you no longer have the overheat warning, you can drive. Just to be safe, drive slower for about 10 minutes. If the warning does not come back on, you can drive normally.

If the warning continues, pull over, stop, and park your vehicle right away.

If there is still no sign of steam, idle the engine for three minutes while you are parked. If you still have the warning, *turn off the engine and get everyone out of the vehicle* until it cools down. Also, see “Overheated Engine Protection Operating Mode” later in this section.

You may decide not to lift the hood but to get service help right away.

## Overheated Engine Protection Operating Mode (4.6L V8 Engine)

If an overheated engine condition exists and the message ENGINE HOT, STOP ENGINE is displayed, an overheat protection mode which alternates firing groups of cylinders helps prevent engine damage. In this mode, you will notice a loss in power and engine performance. This operating mode allows your vehicle to be driven to a safe place in an emergency. Driving extended miles (km) in the overheat protection mode should be avoided.

**Notice:** After driving in the overheated engine protection operating mode, to avoid engine damage, allow the engine to cool before attempting any repair. The engine oil will be severely degraded. Repair the cause of coolant loss, change the oil and reset the oil life system. See *Engine Oil* on page 5-16.

## Cooling System (3.8L V6 Engine)

When you decide it is safe to lift the hood, here is what you will see:

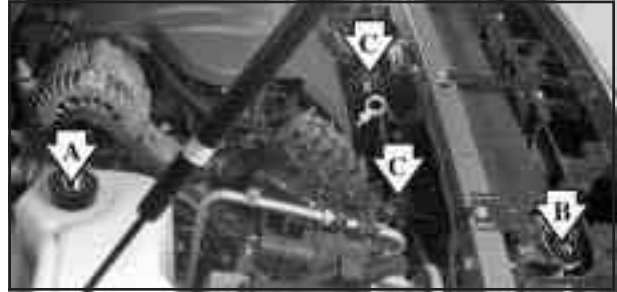

- A. Coolant Recovery Tank
- B. Radiator Pressure Cap
- C. Electric Engine Cooling Fans

 **CAUTION:**

An electric engine cooling fan under the hood can start up even when the engine is not running and can injure you. Keep hands, clothing and tools away from any underhood electric fan.

If the coolant inside the coolant recovery tank is boiling, do not do anything else until it cools down. The vehicle should be parked on a level surface.

See *Engine Compartment Overview* on page 5-12 for more information on location.

The coolant level should be at or above the FULL COLD mark when the engine is cold. The coolant level should be at the FULL HOT mark under normal operating conditions. If it is not, you may have a leak at the pressure cap or in the radiator hoses, heater hoses, radiator, water pump or somewhere else in the cooling system.

 **CAUTION:**

Heater and radiator hoses, and other engine parts, can be very hot. Do not touch them. If you do, you can be burned.

Do not run the engine if there is a leak. If you run the engine, it could lose all coolant. That could cause an engine fire, and you could be burned. Get any leak fixed before you drive the vehicle.

If there seems to be no leak, with the engine on, check to see if the electric engine cooling fans are running. If the engine is overheating, both fans should be running. If they are not, your vehicle needs service.

**Notice:** Engine damage from running your engine without coolant is not covered by your warranty.

**Notice:** Using coolant other than DEX-COOL® may cause premature engine, heater core or radiator corrosion. In addition, the engine coolant may require changing sooner, at 30,000 miles (50 000 km) or 24 months, whichever occurs first. Any repairs would not be covered by your warranty. Always use DEX-COOL® (silicate-free) coolant in your vehicle.

## How to Add Coolant to the Coolant Recovery Tank

If you have not found a problem yet, but the coolant level is not at the FULL COLD mark, add a 50/50 mixture of *clean, drinkable water* and DEX-COOL® engine coolant at the coolant recovery tank. See *Engine Coolant (3.8L V6 Engine)* on page 5-31 or *Engine Coolant (4.6L V8 Engine)* on page 5-34 for more information.

### CAUTION:

**Adding only plain water to your cooling system can be dangerous. Plain water, or some other liquid such as alcohol, can boil before the proper coolant mixture will. Your vehicle's coolant warning system is set for the proper coolant mixture. With plain water or the wrong mixture, your engine could get too hot but you would not get the overheat warning. Your engine could catch fire and you or others could be burned. Use a 50/50 mixture of clean, drinkable water and DEX-COOL® coolant.**

**Notice:** In cold weather, water can freeze and crack the engine, radiator, heater core and other parts. Use the recommended coolant and the proper coolant mixture.

### CAUTION:

**You can be burned if you spill coolant on hot engine parts. Coolant contains ethylene glycol, and it will burn if the engine parts are hot enough. Do not spill coolant on a hot engine.**

When the coolant in the coolant recovery tank is at the FULL COLD mark, start your vehicle.

If the overheat warning continues, there is one more thing you can try. You can add the proper coolant mixture directly to the radiator, but be sure the cooling system is cool before you do it.

**⚠ CAUTION:**

**Steam and scalding liquids from a hot cooling system can blow out and burn you badly. They are under pressure, and if you turn the radiator pressure cap — even a little — they can come out at high speed. Never turn the cap when the cooling system, including the radiator pressure cap, is hot. Wait for the cooling system and radiator pressure cap to cool if you ever have to turn the pressure cap.**

## How to Add Coolant to the Radiator



1. You can remove the radiator pressure cap when the cooling system, including the radiator pressure cap and upper radiator hose, is no longer hot. Turn the pressure cap slowly counterclockwise until it first stops. Do not press down while turning the pressure cap.  
If you hear a hiss, wait for that to stop. A hiss means there is still some pressure left.
2. Then keep turning the pressure cap, but now push down as you turn it. Remove the pressure cap.

3. Remove the 3800 Series II V6 engine cover shield to access the bleed valve.

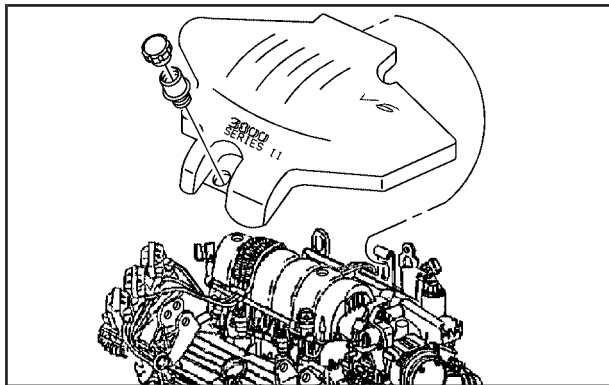

- 3.1. Clean the area around the engine oil fill tube and cap before removing. Twist the oil fill tube, with cap attached, counterclockwise and remove it.

- 3.2. Lift the engine cover shield at the front, slide the catch tab out of the engine bracket and remove the cover shield.
- 3.3. Put the oil fill tube, with cap attached, in the valve cover oil fill hole until you are ready to replace the cover shield.



4. After the engine cools, open the coolant air bleed valve. There is one bleed valve. It is located on the thermostat housing.





5. Fill the radiator with the proper DEX-COOL<sup>®</sup> coolant mixture, up to the base of the filler neck. See *Engine Coolant (3.8L V6 Engine)* on page 5-31 or *Engine Coolant (4.6L V8 Engine)* on page 5-34 for more information about the proper coolant mixture.

If you see a stream of coolant coming from an air bleed valve, close the valve. Otherwise, close the valve after the radiator is filled.

6. Rinse or wipe any spilled coolant from the engine and the compartment.
7. Replace the 3800 Series II V6 engine cover shield.
  - 7.1. Remove the oil fill tube, with cap attached, from the valve cover.
  - 7.2. Insert the catch tab on the cover shield under the bracket on the engine.
  - 7.3. Place the hole in the cover shield over the hole in the valve cover. Install oil fill tube and cap by twisting clockwise.



8. Then fill the coolant recovery tank to the FULL COLD mark.
9. Put the cap back on the coolant recovery tank, but leave the radiator pressure cap off.

10. Start the engine and let it run until you can feel the upper radiator hose getting hot. Watch out for the engine cooling fans.
11. By this time, the coolant level inside the radiator filler neck may be lower. If the level is lower, add more of the proper DEX-COOL<sup>®</sup> coolant mixture through the filler neck until the level reaches the base of the filler neck.
12. Then replace the pressure cap. At any time during this procedure if coolant begins to flow out of the filler neck, reinstall the pressure cap.  
Be sure the arrow on the pressure cap lines up properly.

## Cooling System (4.6L V8 Engine)

When you decide it is safe to lift the hood, here is what you will see:

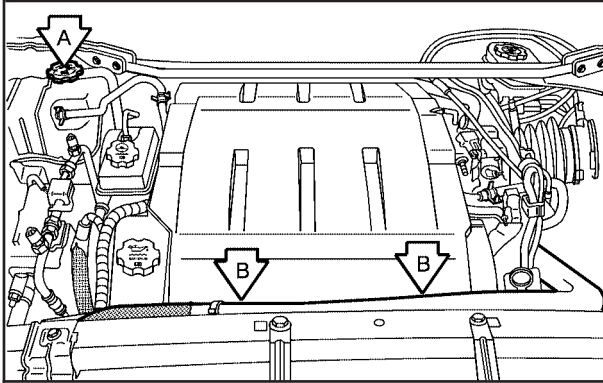

- A. Coolant Surge Tank with Pressure Cap
- B. Electric Engine Cooling Fans

### CAUTION:

An electric engine cooling fan under the hood can start up even when the engine is not running and can injure you. Keep hands, clothing and tools away from any underhood electric fan.

If the coolant inside the coolant surge tank is boiling, do not do anything else until it cools down. The vehicle should be parked on a level surface.

A low coolant level should be indicated by a LOW ENGINE COOLANT message on the Driver Information Center (DIC). If it is, you may have a leak at the pressure cap or in the radiator hoses, heater hoses, radiator, water pump or somewhere else in the cooling system.

## CAUTION:

Heater and radiator hoses, and other engine parts, can be very hot. Do not touch them. If you do, you can be burned.

Do not run the engine if there is a leak. If you run the engine, it could lose all coolant. That could cause an engine fire, and you could be burned. Get any leak fixed before you drive the vehicle.

If there seems to be no leak, with the engine on, check to see if the electric engine cooling fans are running. If the engine is overheating, both fans should be running. If they are not, your vehicle needs service.

**Notice:** Engine damage from running your engine without coolant is not covered by your warranty. See *Overheated Engine Protection Operating Mode (4.6L V8 Engine)* on page 5-40 for information on driving to a safe place in an emergency.

**Notice:** Using coolant other than DEX-COOL<sup>®</sup> may cause premature engine, heater core or radiator corrosion. In addition, the engine coolant may require changing sooner, at 30,000 miles (50 000 km) or 24 months, whichever occurs first. Any repairs would not be covered by your warranty. Always use DEX-COOL<sup>®</sup> (silicate-free) coolant in your vehicle.

## How to Add Coolant to the Coolant Surge Tank

If you have not found a problem yet, check to see if coolant is visible in the surge tank. If coolant is visible but the coolant level is not at the proper level (4.5 inches (11.4 cm) below the top of the filler neck), add a 50/50 mixture of *clean, drinkable water* and DEX-COOL<sup>®</sup> coolant at the coolant surge tank, but be sure the cooling system, including the coolant surge tank pressure cap, is cool before you do it. See *Engine Coolant (3.8L V6 Engine)* on page 5-31 or *Engine Coolant (4.6L V8 Engine)* on page 5-34 for more information.

If no coolant is visible in the surge tank, add coolant as follows:

 **CAUTION:**

Steam and scalding liquids from a hot cooling system can blow out and burn you badly. They are under pressure, and if you turn the coolant surge tank pressure cap — even a little — they can come out at high speed. Never turn the cap when the cooling system, including the coolant surge tank pressure cap, is hot. Wait for the cooling system and coolant surge tank pressure cap to cool if you ever have to turn the pressure cap.

 **CAUTION:**

Adding only plain water to your cooling system can be dangerous. Plain water, or some other liquid such as alcohol, can boil before the proper coolant mixture will. Your vehicle's coolant warning system is set for the proper coolant mixture. With plain water or the wrong mixture, your engine could get too hot but you would not get the overheat warning. Your engine could catch fire and you or others could be burned. Use a 50/50 mixture of clean, drinkable water and DEX-COOL<sup>®</sup> coolant.

**Notice:** In cold weather, water can freeze and crack the engine, radiator, heater core and other parts. Use the recommended coolant and the proper coolant mixture.

**⚠ CAUTION:**

You can be burned if you spill coolant on hot engine parts. Coolant contains ethylene glycol and it will burn if the engine parts are hot enough. Do not spill coolant on a hot engine.



1. You can remove the coolant surge tank pressure cap when the cooling system, including the coolant surge tank pressure cap and upper radiator hose, is no longer hot. Turn the pressure cap slowly counterclockwise (left) until it first stops. Do not press down while turning the pressure cap. If you hear a hiss, wait for that to stop. A hiss means there is still some pressure left.
2. Then keep turning the cap, but now push down as you turn it. Remove the pressure cap.



3. Fill the coolant surge tank with the proper mixture to the full cold fill mark on the side of the coolant surge tank.



4. With the coolant surge tank pressure cap off, start the engine and let it run until you can feel the upper radiator hose getting hot. Watch out for the engine cooling fans.  
By this time, the coolant level inside the coolant surge tank may be lower. If the level is lower, add more of the proper mixture to the coolant surge tank until the level reaches about 4.5 inches (11.4 cm) from the top of the filler neck.
5. Then replace the pressure cap. Be sure the arrow on the pressure cap lines up with the tube.

Start the engine and allow it to warm up. If the LOW ENGINE COOLANT message does not appear on the Driver Information Center (DIC), the coolant is at the proper fill level. If a LOW ENGINE COOLANT message does appear, repeat Steps 1 to 3 then reinstall the pressure cap, or see your dealer.

## Power Steering Fluid

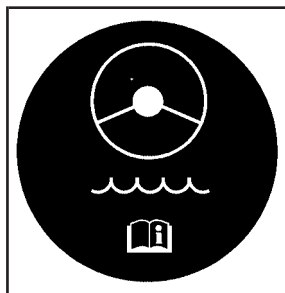

The power steering fluid reservoir is located in the rear of the engine compartment on the passenger's side of the vehicle. See *Engine Compartment Overview* on page 5-12 for reservoir location.

## When to Check Power Steering Fluid

It is not necessary to regularly check power steering fluid unless you suspect there is a leak in the system or you hear an unusual noise. A fluid loss in this system could indicate a problem. Have the system inspected and repaired.

## How to Check Power Steering Fluid

1. Turn the key off and let the engine compartment cool down.
2. Wipe the cap and the top of the reservoir clean.
3. Unscrew the cap and wipe the dipstick with a clean rag.
4. Replace the cap and completely tighten it.
5. Then remove the cap again and look at the fluid level on the dipstick.

The level should be at the FULL COLD mark. If necessary, add only enough fluid to bring the level up to the mark.

## What to Use

To determine what kind of fluid to use, see *Part D: Recommended Fluids and Lubricants* on page 6-24. Always use the proper fluid. Failure to use the proper fluid can cause leaks and damage hoses and seals.



# Windshield Washer Fluid

## What to Use

When you need windshield washer fluid, be sure to read the manufacturer's instructions before use. If you will be operating your vehicle in an area where the temperature may fall below freezing, use a fluid that has sufficient protection against freezing.

## Adding Washer Fluid

The washer fluid warning light will come on when the ignition switch is on and the fluid container is less than one-third full. On vehicles with the optional Driver Information Center (DIC), a WASHER FLUID LOW message will be displayed and a chime will sound letting you know to add windshield washer fluid to your vehicle.

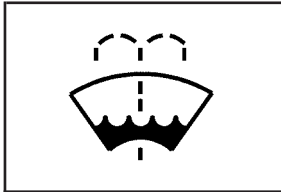

Open the cap with the washer symbol on it. Add washer fluid until the tank is full. See *Engine Compartment Overview* on page 5-12 for reservoir location.

### Notice:

- When using concentrated washer fluid, follow the manufacturer's instructions for adding water.
- Do not mix water with ready-to-use washer fluid. Water can cause the solution to freeze and damage your washer fluid tank and other parts of the washer system. Also, water does not clean as well as washer fluid.
- Fill your washer fluid tank only three-quarters full when it is very cold. This allows for expansion if freezing occurs, which could damage the tank if it is completely full.
- Do not use engine coolant (antifreeze) in your windshield washer. It can damage your washer system and paint.

## Brakes

### Brake Fluid

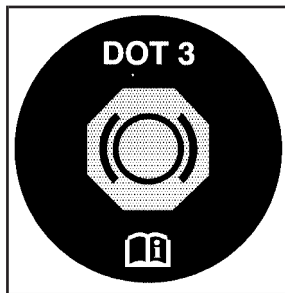

Your master cylinder reservoir is filled with DOT-3 brake fluid. See *Engine Compartment Overview* on page 5-12 for the location of the reservoir.

There are only two reasons why the brake fluid level in the reservoir might go down. The first is that the brake fluid goes down to an acceptable level during normal brake lining wear. When new linings are put in, the fluid level goes back up. The other reason is that fluid is leaking out of the brake system. If it is, you should have your brake system fixed, since a leak means that sooner or later your brakes will not work well, or will not work at all.

So, it is not a good idea to top off your brake fluid. Adding brake fluid will not correct a leak. If you add fluid when your linings are worn, then you will have too much fluid when you get new brake linings. You should add or remove brake fluid, as necessary, only when work is done on the brake hydraulic system

#### **CAUTION:**

**If you have too much brake fluid, it can spill on the engine. The fluid will burn if the engine is hot enough. You or others could be burned, and your vehicle could be damaged. Add brake fluid only when work is done on the brake hydraulic system.**

When your brake fluid falls to a low level, your brake warning light will come on. If your vehicle has the Driver Information Center, the BRAKE FLUID LOW message will also be displayed. A chime will sound if you try to drive with this warning light on. See *Brake System Warning Light* on page 3-41.

## What to Add

When you do need brake fluid, use only DOT-3 brake fluid. Use new brake fluid from a sealed container only. See *Part D: Recommended Fluids and Lubricants* on page 6-24.

Always clean the brake fluid reservoir cap and the area around the cap before removing it. This will help keep dirt from entering the reservoir.

### CAUTION:

With the wrong kind of fluid in your brake system, your brakes may not work well, or they may not even work at all. This could cause a crash. Always use the proper brake fluid.

### Notice:

- Using the wrong fluid can badly damage brake system parts. For example, just a few drops of mineral-based oil, such as engine oil, in your brake system can damage brake system parts so badly that they will have to be replaced. Do not let someone put in the wrong kind of fluid.
- If you spill brake fluid on your vehicle's painted surfaces, the paint finish can be damaged. Be careful not to spill brake fluid on your vehicle. If you do, wash it off immediately. See *Appearance Care* on page 5-101.

## Brake Wear

Your vehicle has four-wheel disc brakes.

Disc brake pads have built-in wear indicators that make a high-pitched warning sound when the brake pads are worn and new pads are needed. The sound may come and go or be heard all the time your vehicle is moving, except when you are pushing on the brake pedal firmly.

### CAUTION:

**The brake wear warning sound means that soon your brakes will not work well. That could lead to an accident. When you hear the brake wear warning sound, have your vehicle serviced.**

**Notice:** Continuing to drive with worn-out brake pads could result in costly brake repair.

Some driving conditions or climates may cause a brake squeal when the brakes are first applied or lightly applied. This does not mean something is wrong with your brakes.

Properly torqued wheel nuts are necessary to help prevent brake pulsation. When tires are rotated, inspect brake pads for wear and evenly tighten wheel nuts in the proper sequence to GM torque specifications.

Brake linings should always be replaced as complete axle sets.

See *Brake System Inspection* on page 6-24.

## Brake Pedal Travel

See your dealer if the brake pedal does not return to normal height, or if there is a rapid increase in pedal travel. This could be a sign of brake trouble.

## Brake Adjustment

Every time you apply the brakes, with or without the vehicle moving, your brakes adjust for wear.

## Replacing Brake System Parts

The braking system on a vehicle is complex. Its many parts have to be of top quality and work well together if the vehicle is to have really good braking. Your vehicle was designed and tested with top-quality GM brake parts. When you replace parts of your braking system — for example, when your brake linings wear down and you need new ones put in — be sure you get new approved GM replacement parts. If you do not, your brakes may no longer work properly. For example, if someone puts in brake linings that are wrong for your vehicle, the balance between your front and rear brakes can change — for the worse. The braking performance you have come to expect can change in many other ways if someone puts in the wrong replacement brake parts.

## Battery

Your vehicle has a maintenance free battery. When it is time for a new battery, get one that has the replacement number shown on the original battery's label. We recommend an ACDelco® replacement battery.

**Warning:** Battery posts, terminals and related accessories contain lead and lead compounds, chemicals known to the State of California to cause cancer and reproductive harm. Wash hands after handling.

The battery is located under the rear seat cushion. To access the battery, see “Removing the Rear Seat Cushion” under *Rear Underseat Fuse Block* on page 5-116. You do not need to access the battery to jump start your vehicle. See *Jump Starting (3.8L V6 Engine)* on page 5-59 or *Jump Starting (4.6L V8 Engine)* on page 5-63.

### CAUTION:

**A battery that is not properly vented can let sulfuric acid fumes into the area under the rear seat cushion. These fumes can damage your rear seat safety belt systems. You may not be able to see this damage, and the safety belts might not provide the protection needed in a crash. If a replacement battery is ever needed, it must be vented in the same manner as the original battery. Always make sure that the vent hose is properly reattached before reinstalling the seat cushion.**

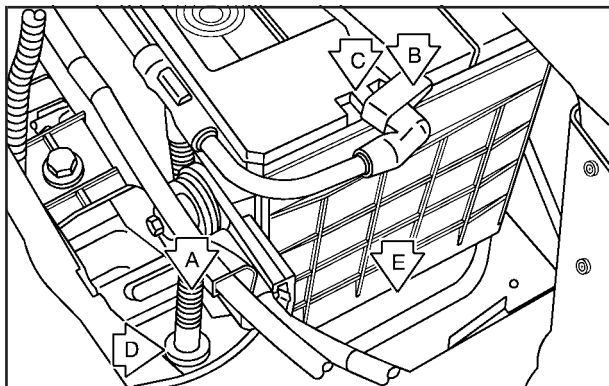

To be sure the vent hose (A) is properly attached, the vent hose connectors (B) must be securely reattached to the vent outlets (C) on each side of the battery, and the vent assembly grommet (D) must be secured to the floor pan (E).

## Vehicle Storage

If you are not going to drive your vehicle for 25 days or more, remove the black, negative (-) cable from the battery. This will help keep your battery from running down.

### CAUTION:

Batteries have acid that can burn you and gas that can explode. You can be badly hurt if you are not careful. See *Jump Starting (3.8L V6 Engine)* on page 5-59 or *Jump Starting (4.6L V8 Engine)* on page 5-63 for tips on working around a battery without getting hurt.

Also, for your audio system, see *Theft-Deterrent Feature* on page 3-99.

## Jump Starting (3.8L V6 Engine)

If your battery has run down, you may want to use another vehicle and some jumper cables to start your vehicle. Be sure to use the following steps to do it safely.

### CAUTION:

**Batteries can hurt you. They can be dangerous because:**

- They contain acid that can burn you.
- They contain gas that can explode or ignite.
- They contain enough electricity to burn you.

**If you do not follow these steps exactly, some or all of these things can hurt you.**

**Notice:** Ignoring these steps could result in costly damage to your vehicle that would not be covered by your warranty.

**Trying to start your vehicle by pushing or pulling it will not work, and it could damage your vehicle.**

1. Check the other vehicle. It must have a 12-volt battery with a negative ground system.

**Notice:** If the other vehicle's system is not a 12-volt system with a negative ground, both vehicles can be damaged. Only use vehicles with 12-volt systems with negative grounds to jump start your vehicle.

2. Get the vehicles close enough so the jumper cables can reach, but be sure the vehicles are not touching each other. If they are, it could cause a ground connection you do not want. You would not be able to start your vehicle, and the bad grounding could damage the electrical systems.

To avoid the possibility of the vehicles rolling, set the parking brake firmly on both vehicles involved in the jump start procedure. Put an automatic transaxle in PARK (P) or a manual transaxle in NEUTRAL before setting the parking brake.

**Notice:** If you leave your radio or other accessories on during the jump starting procedure, they could be damaged. The repairs would not be covered by your warranty. Always turn off your radio and other accessories when jump starting your vehicle.

3. Turn off the ignition on both vehicles. Unplug unnecessary accessories plugged into the cigarette lighter or the accessory power outlet. Turn off the radio and all lamps that are not needed. This will avoid sparks and help save both batteries. And it could save the radio!

4. Open the hood on the other vehicle and locate the positive (+) and negative (-) terminal locations on that vehicle.

You will not see the battery of your vehicle under the hood. It is located under the rear passenger's seat. You will not need to access the battery for jump starting. The remote positive (+) terminal is for that purpose.

Open the hood on your vehicle and find the remote positive (+) terminal located in the engine compartment on the passenger's side of the vehicle.



Access the remote positive (+) terminal by removing the cover.

### **CAUTION:**

**An electric fan can start up even when the engine is not running and can injure you. Keep hands, clothing and tools away from any underhood electric fan.**

### **CAUTION:**

**Using a match near a battery can cause battery gas to explode. People have been hurt doing this, and some have been blinded. Use a flashlight if you need more light.**

**Be sure the battery has enough water. You do not need to add water to the battery installed in your new vehicle. But if a battery has filler caps, be sure the right amount of fluid is there. If it is low, add water to take care of that first. If you do not, explosive gas could be present.**

**Battery fluid contains acid that can burn you. Do not get it on you. If you accidentally get it in your eyes or on your skin, flush the place with water and get medical help immediately.**



 **CAUTION:**

**Fans or other moving engine parts can injure you badly. Keep your hands away from moving parts once the engine is running.**

5. Check that the jumper cables do not have loose or missing insulation. If they do, you could get a shock. The vehicles could be damaged too.  
Before you connect the cables, here are some basic things you should know. Positive (+) will go to positive (+) or to a remote positive (+) terminal if the vehicle has one. Negative (-) will go to a heavy, unpainted metal engine part or to a remote negative (-) terminal if the vehicle has one.  
Do not connect positive (+) to negative (-) or you will get a short that would damage the battery and maybe other parts too. And do not connect the negative (-) cable to the negative (-) terminal on the dead battery because this can cause sparks.
6. Connect the red positive (+) cable to the positive (+) terminal of the dead battery. Use a remote positive (+) terminal if the vehicle has one.
7. Do not let the other end touch metal. Connect it to the positive (+) terminal of the good battery. Use a remote positive (+) terminal if the vehicle has one.
8. Now connect the black negative (-) cable to the negative (-) terminal of the good battery. Use a remote negative (-) terminal if the vehicle has one.  
Do not let the other end touch anything until the next step. The other end of the negative (-) cable *does not* go to the dead battery. It goes to a heavy, unpainted metal engine part or to a remote negative (-) terminal on the vehicle with the dead battery.
9. Connect the other end of the negative (-) cable at least 18 inches (45 cm) away from the dead battery, but not near engine parts that move.  
The electrical connection is just as good there, and the chance of sparks getting back to the battery is much less.
10. Now start the vehicle with the good battery and run the engine for a while.
11. Try to start the vehicle that had the dead battery. If it will not start after a few tries, it probably needs service.

**Notice:** If the jumper cables are removed in the wrong order, electrical shorting may occur and damage the vehicle. The repairs would not be covered by your warranty. Remove the jumper cables in the correct order, making sure that the cables do not touch each other or other metal.

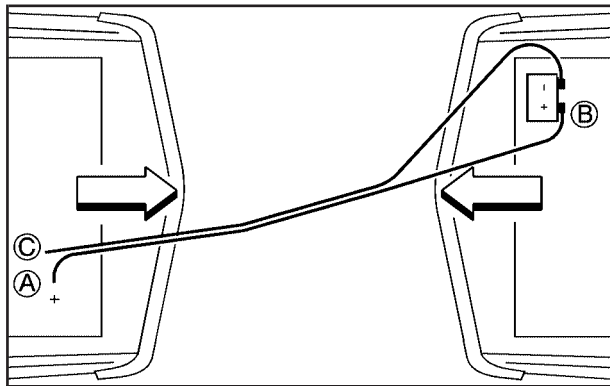

### Jumper Cable Removal

- A. Dead Battery or Remote Positive (+) Terminal
- B. Good Battery or Remote Positive (+) or Remote Negative (-) Terminals
- C. Heavy, Unpainted Metal Engine Part or Remote Negative (-) Terminal

To disconnect the jumper cables from both vehicles, do the following:

1. Disconnect the black negative (-) cable from the vehicle that had the dead battery.
2. Disconnect the black negative (-) cable from the vehicle with the good battery.
3. Disconnect the red positive (+) cable from the vehicle with the good battery.
4. Disconnect the red positive (+) cable from the other vehicle.
5. Return the positive (+) remote terminal cover to its original position.

## Jump Starting (4.6L V8 Engine)

If your battery has run down, you may want to use another vehicle and some jumper cables to start your vehicle. Be sure to use the following steps to do it safely.

### CAUTION:

**Batteries can hurt you. They can be dangerous because:**

- They contain acid that can burn you.
- They contain gas that can explode or ignite.
- They contain enough electricity to burn you.

**If you do not follow these steps exactly, some or all of these things can hurt you.**

**Notice:** Ignoring these steps could result in costly damage to your vehicle that would not be covered by your warranty.

**Trying to start your vehicle by pushing or pulling it will not work, and it could damage your vehicle.**

1. Check the other vehicle. It must have a 12-volt battery with a negative ground system.

**Notice:** If the other vehicle's system is not a 12-volt system with a negative ground, both vehicles can be damaged. Only use vehicles with 12-volt systems with negative grounds to jump start your vehicle.

2. Get the vehicles close enough so the jumper cables can reach, but be sure the vehicles are not touching each other. If they are, it could cause a ground connection you do not want. You would not be able to start your vehicle and the bad grounding could damage the electrical systems.

To avoid the possibility of the vehicles rolling, set the parking brake firmly on both vehicles involved in the jump start procedure. Put an automatic transaxle in PARK (P) or a manual transaxle in NEUTRAL before setting the parking brake.

**Notice:** If you leave your radio or other accessories on during the jump starting procedure, they could be damaged. The repairs would not be covered by your warranty. Always turn off your radio and other accessories when jump starting your vehicle.

3. Turn off the ignition on both vehicles. Unplug unnecessary accessories plugged into the cigarette lighter or the accessory power outlets. Turn off the radio and all lamps that are not needed. This will avoid sparks and help save both batteries. And it could save the radio!

4. Open the hoods and locate the positive (+) and negative (-) terminal locations on the other vehicle.

You will not see the battery of your vehicle under the hood. It is located under the rear passenger's seat. You will not need to access the battery for jump starting. Your vehicle has a remote positive (+) jump starting terminal and a remote negative (-) jump starting terminal.



The remote positive (+) terminal is located in the engine compartment on the passenger's side of the vehicle. Lift the red plastic cap to access the terminal.

The remote negative (-) terminal is located near the power steering fluid reservoir. It is marked "GND (-)."

**⚠ CAUTION:**

**An electric fan can start up even when the engine is not running and can injure you. Keep hands, clothing and tools away from any underhood electric fan.**

**⚠ CAUTION:**

**Using a match near a battery can cause battery gas to explode. People have been hurt doing this, and some have been blinded. Use a flashlight if you need more light.**

**Be sure the battery has enough water. You do not need to add water to the battery installed in your new vehicle. But if a battery has filler caps, be sure the right amount of fluid is there. If it is low, add water to take care of that first. If you do not, explosive gas could be present.**

**Battery fluid contains acid that can burn you. Do not get it on you. If you accidentally get it in your eyes or on your skin, flush the place with water and get medical help immediately.**

 **CAUTION:**

**Fans or other moving engine parts can injure you badly. Keep your hands away from moving parts once the engine is running.**

5. Check that the jumper cables do not have loose or missing insulation. If they do, you could get a shock. The vehicles could be damaged too.  
Before you connect the cables, here are some basic things you should know. Positive (+) will go to positive (+) or to a remote positive (+) terminal if the vehicle has one. Negative (-) will go to a heavy, unpainted metal engine part or to a remote negative (-) terminal if the vehicle has one.  
Do not connect positive (+) to negative (-) or you will get a short that would damage the battery and maybe other parts too. And do not connect the negative (-) cable to the negative (-) terminal on the dead battery because this can cause sparks.
6. Connect the red positive (+) cable to the positive (+) terminal of the dead battery. Use a remote positive (+) terminal if the vehicle has one.
7. Do not let the other end touch metal. Connect it to the positive (+) terminal of the good battery. Use a remote positive (+) terminal if the vehicle has one.
8. Now connect the black negative (-) cable to the negative (-) terminal of the good battery. Use a remote negative (-) terminal if the vehicle has one.  
Do not let the other end of the cable touch anything until the next step. The other end of the negative (-) cable *does not* go to the dead battery. It goes to a heavy, unpainted metal engine part or to a remote negative (-) terminal on the vehicle with the dead battery.
9. Connect the other end of the negative (-) cable at least 18 inches (45 cm) away from the dead battery, but not near engine parts that move. The electrical connection is just as good there, and the chance of sparks getting back to the battery is much less.



Your vehicle has a remote negative (-) terminal marked GND (-).

10. Now start the vehicle with the good battery and run the engine for a while.
11. Try to start the vehicle that had the dead battery. If it will not start after a few tries, it probably needs service.

**Notice:** If the jumper cables are removed in the wrong order, electrical shorting may occur and damage the vehicle. The repairs would not be covered by your warranty. Remove the jumper cables in the correct order, making sure that the cables do not touch each other or other metal.

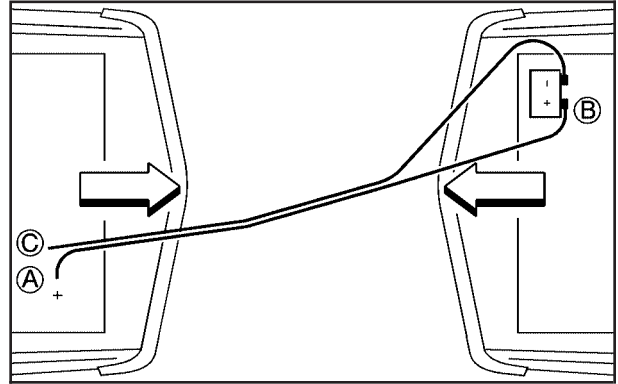

### Jumper Cable Removal

- A. Dead Battery or Remote Positive (+) Terminal
- B. Good Battery or Remote Positive (+) and Remote Negative (-) Terminals
- C. Heavy, Unpainted Metal Engine Part or Remote Negative (-) Terminal (GND)

To disconnect the jumper cables from both vehicles, do the following:

1. Disconnect the black negative (–) cable from the vehicle that had the dead battery.
2. Disconnect the black negative (–) cable from the vehicle with the good battery.
3. Disconnect the red positive (+) cable from the vehicle with the good battery.
4. Disconnect the red positive (+) cable from the other vehicle.
5. Return the remote positive (+) terminal cover to its original position.

## Bulb Replacement

For the type of bulb to use, see *Replacement Bulbs* on page 5-72.

For any bulb changing procedure not listed in this section, contact your dealer.

## Halogen Bulbs

### CAUTION:

**Halogen bulbs have pressurized gas inside and can burst if you drop or scratch the bulb. You or others could be injured. Be sure to read and follow the instructions on the bulb package.**

## Headlamps

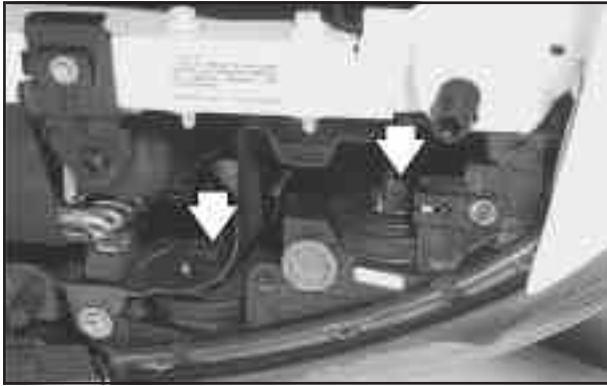

1. Reach behind the headlamp assembly, push in and turn the bulb assembly counterclockwise to remove the bulb assembly from the headlamp assembly.



2. Lift the tabs to remove the bulb from the assembly.
3. Replace the bulb.
4. Push the bulb assembly in and turn it clockwise to install the bulb assembly into the headlamp assembly.



## Front Turn Signal and Parking Lamps



1. Remove the two bolts.
2. Use a flat tool by the outside mount to separate the lamp assembly from the outboard snap mounting pin.
3. Slide the headlamp assembly outward and lift it out.



4. Disconnect the wiring harness from the headlamp assembly.



5. Tip the headlamp assembly and while pressing the release, turn the bulb and socket counterclockwise to remove them.
6. Replace the bulb and reinstall the socket. Then reconnect the wiring harness to the lamp assembly.



7. Slide the lamp assembly back into place by lining up the track on the bottom of the assembly with the guide on the vehicle. Then connect the outboard snap and secure the lamp assembly with the two bolts.

## Taillamps, Turn Signal, Stoplamps and Back-up Lamps

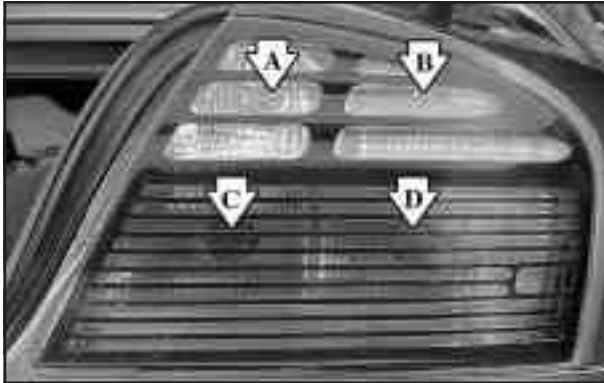

A. Back-Up Lamp

B. Turn Signal

C. Taillamp

D. Taillamp/Brake Lamp

1. Open the trunk. See *Trunk* on page 2-15 for more information.
2. Turn the screws located inside of the trunk counterclockwise and remove them.
3. Remove the plastic trim piece from the trunk.
4. Pull the carpeting away from the rear corner of the trunk.

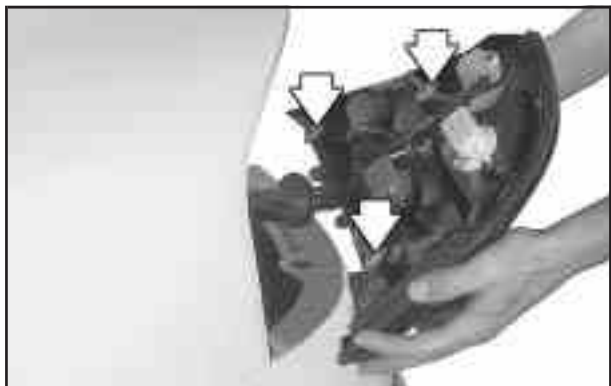

5. Remove the three nuts holding the lamp in place and remove the lamp assembly.
6. Turn the bulb socket assembly counterclockwise while pressing the release, to remove it from the lamp assembly.
7. Pull the bulb straight out of the socket.
8. Replace the bulb and reverse Steps 1 through 6 to reinstall the lamp assembly.

## Replacement Bulbs

Exterior Lamp	Bulb Number
Back-Up Lamps	3057/3155*
Headlamps	
High-Beam	9005 / HIR1*
Low-Beam	9006
Parking/Turn Lamps	3157
Rear Turn Lamps	5701KA*
Sidemarkers	168*
Stoplamps	3057
Taillamps	3057
Turn Signal	3157
Bulb numbers denoted by an asterisk (*) only apply to the 4.6L V8 engine.	

For replacement bulbs not listed here, contact your dealer.

## Windshield Wiper Blade Replacement

Windshield wiper blades should be inspected at least twice a year for wear or cracking. See *Part B: Owner Checks and Services on page 6-19* for more information.

For the proper windshield wiper blade replacement length and type, see *Normal Maintenance Replacement Parts on page 5-122*.

To replace the wiper blade assembly:

1. Lift the wiper up from the windshield and set into the vertically-locked position.



2. Press the tab that holds the wiper blade to the arm.
3. Slide the blade down and off the arm.
4. Slide in the new blade and snap into place.

## Tires

Your new vehicle comes with high-quality tires made by a leading tire manufacturer. If you ever have questions about your tire warranty and where to obtain service, see your GM Warranty booklet for details. For additional information refer to the tire manufacturer's booklet included with your vehicle's owner's manual.

### CAUTION:

- Poorly maintained and improperly used tires are dangerous.
- Overloading your tires can cause overheating as a result of too much friction. You could have an air-out and a serious accident. See *Loading Your Vehicle* on page 4-29.

CAUTION: (Continued)

### CAUTION: (Continued)

- Underinflated tires pose the same danger as overloaded tires. The resulting accident could cause serious injury. Check all tires frequently to maintain the recommended pressure. Tire pressure should be checked when your tires are cold.
- Overinflated tires are more likely to be cut, punctured or broken by a sudden impact— such as when you hit a pothole. Keep tires at the recommended pressure.
- Worn, old tires can cause accidents. If your tread is badly worn, or if your tires have been damaged, replace them.

See *Inflation - Tire Pressure* on page 5-80, for inflation pressure adjustment for high speed driving.

## Tire Sidewall Labelling

Useful information about a tire is molded into its sidewall. The examples below show a typical passenger vehicle tire and a compact spare tire sidewall.

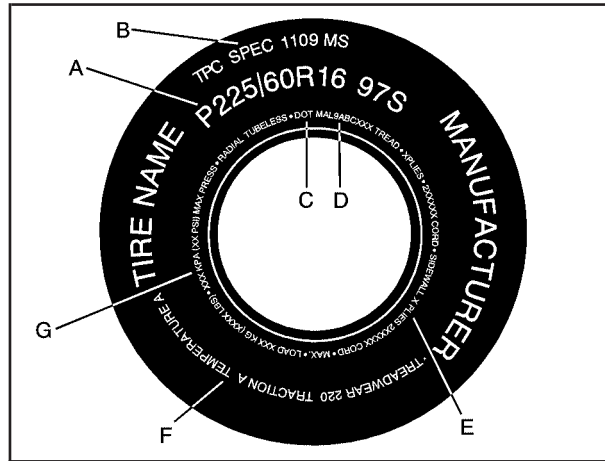

**Passenger (P-Metric) Tire Example**

**(A) Tire Size:** The tire size is a combination of letters and numbers used to define a particular tire's width, height, aspect ratio, construction type and service description. See the "Tire Size" illustration later in this section for more detail.

**(B) TPC Spec (Tire Performance Criteria Specification):** Original equipment tires designed to GM's specific tire performance criteria have a TPC specification code molded onto the sidewall. GM's TPC specifications meet or exceed all federal safety guidelines.

**(C) DOT (Department of Transportation):** The Department of Transportation (DOT) code indicates that the tire is in compliance with the U.S. Department of Transportation Motor Vehicle Safety Standards.

**(D) Tire Identification Number (TIN):** The letters and numbers following DOT (Department of Transportation) code is the Tire Identification Number (TIN). The TIN shows the manufacturer and plant code, tire size, and date the tire was manufactured. The TIN is molded onto both sides of the tire, although only one side may have the date of manufacture.

**(E) Tire Ply Material:** The type of cord and number of plies in the sidewall and under the tread.

**(F) Uniform Tire Quality Grading (UTQG):** Tire manufacturers are required to grade tires based on three performance factors: treadwear, traction and temperature resistance. For more information see *Uniform Tire Quality Grading* on page 5-87.

**(G) Maximum Cold Inflation Load Limit:** Maximum load that can be carried and the maximum pressure needed to support that load.

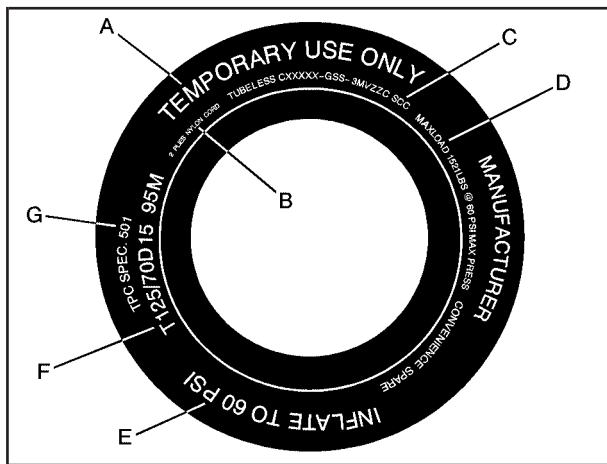

**Compact Spare Tire Example**

**(A) Temporary Use Only:** The compact spare tire or temporary use tire has a tread life of approximately 3,000 miles (5 000 km) and should not be driven at speeds over 65 mph (105 km/h). The compact spare tire is for emergency use when a regular road tire has lost air and gone flat. If your vehicle has a compact spare tire, see *Compact Spare Tire on page 5-100* and *If a Tire Goes Flat on page 5-92*.

**(B) Tire Ply Material:** The type of cord and number of plies in the sidewall and under the tread.

**(C) Tire Identification Number (TIN):** The letters and numbers following the DOT (Department of Transportation) code is the Tire Identification Number (TIN). The TIN shows the manufacturer and plant code, tire size, and date the tire was manufactured. The TIN is molded onto both sides of the tire, although only one side may have the date of manufacture.

**(D) Maximum Cold Inflation Load Limit:** Maximum load that can be carried and the maximum pressure needed to support that load.

**(E) Tire Inflation:** The temporary use tire or compact spare tire should be inflated to 60 psi (420 kPa). For more information on tire pressure and inflation see *Inflation - Tire Pressure on page 5-80*.

**(F) Tire Size:** A combination of letters and numbers define a tire's width, height, aspect ratio, construction type and service description. The letter T as the first character in the tire size means the tire is for temporary use only.

**(G) TPC Spec (Tire Performance Criteria Specification):** Original equipment tires designed to GM's specific tire performance criteria have a TPC specification code molded onto the sidewall. GM's TPC specifications meet or exceed all federal safety guidelines.



## Tire Size

The following illustration shows an example of a typical passenger vehicle tire size.

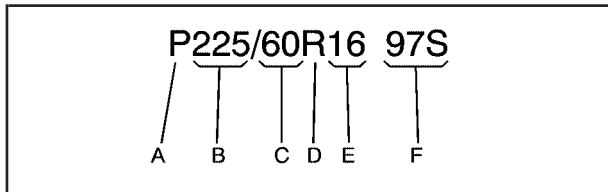

**(A) Passenger (P-Metric) Tire:** The United States version of a metric tire sizing system. The letter P as the first character in the tire size means a passenger vehicle tire engineered to standards set by the U.S. Tire and Rim Association.

**(B) Tire Width:** The three-digit number indicates the tire section width in millimeters from sidewall to sidewall.

**(C) Aspect Ratio:** A two-digit number that indicates the tire height-to-width measurements. For example, if the tire size aspect ratio is 60, as shown in item C of the illustration, it would mean that the tire's sidewall is 60 percent as high as it is wide.

**(D) Construction Code:** A letter code is used to indicate the type of ply construction in the tire. The letter R means radial ply construction; the letter D means diagonal or bias ply construction; and the letter B means belted-bias ply construction.

**(E) Rim Diameter:** Diameter of the wheel in inches.

**(F) Service Description:** These characters represent the load range and speed rating of the tire. The load index represents the load carry capacity a tire is certified to carry. The load index can range from 1 to 279. The speed rating is the maximum speed a tire is certified to carry a load. Speed ratings range from A to Z.

## Tire Terminology and Definitions

**Air Pressure:** The amount of air inside the tire pressing outward on each square inch of the tire. Air pressure is expressed in pounds per square inch (psi) or kiloPascal (kPa).

**Accessory Weight:** This means the combined weight of optional accessories. Some examples of optional accessories are, automatic transmission, power steering, power brakes, power windows, power seats, and air conditioning.

**Aspect Ratio:** The relationship of a tire's height to its width.

**Belt:** A rubber coated layer of cords that is located between the plies and the tread. Cords may be made from steel or other reinforcing materials.

**Bead:** The tire bead contains steel wires wrapped by steel cords that hold the tire onto the rim.

**Bias Ply Tire:** A pneumatic tire in which the plies are laid at alternate angles less than 90 degrees to the centerline of the tread.

**Cold Inflation Pressure:** The amount of air pressure in a tire, measured in pounds per square inch (psi) or kilopascals (kPa) before a tire has built up heat from driving. See *Inflation - Tire Pressure on page 5-80*.

**Curb Weight:** This means the weight of a motor vehicle with standard and optional equipment including the maximum capacity of fuel, oil and coolant, but without passengers and cargo.

**DOT Markings:** A code molded into the sidewall of a tire signifying that the tire is in compliance with the U.S. Department of Transportation (DOT) motor vehicle safety standards. The DOT code includes the Tire Identification Number (TIN), an alphanumeric designator which can also identify the tire manufacturer, production plant, brand and date of production.

**GVWR:** Gross Vehicle Weight Rating, see *Loading Your Vehicle on page 4-29*.

**GAWR FRT:** Gross Axle Weight Rating for the front axle, see *Loading Your Vehicle on page 4-29*.

**GAWR RR:** Gross Axle Weight Rating for the rear axle, see *Loading Your Vehicle on page 4-29*.

**Intended Outboard Sidewall:** The side of an asymmetrical tire, that must always face outward when mounted on a vehicle.

**KiloPascal (kPa):** The metric unit for air pressure.

**Light Truck (LT-Metric) Tire:** A tire used on light duty trucks and some multipurpose passenger vehicles.

**Load Index:** An assigned number ranging from 1 to 279 that corresponds to the load carrying capacity of a tire.

**Maximum Inflation Pressure:** The maximum air pressure to which a cold tire may be inflated. The maximum air pressure is molded onto the sidewall.

**Maximum Load Rating:** The load rating for a tire at the maximum permissible inflation pressure for that tire.

**Maximum Loaded Vehicle Weight:** The sum of curb weight; accessory weight; vehicle capacity weight; and production options weight.

**Normal Occupant Weight:** The number of occupants a vehicle is designed to seat multiplied by 150 lbs (68 kg). See *Loading Your Vehicle on page 4-29*.

**Occupant Distribution:** Designated seating positions.

**Outward Facing Sidewall:** The side of an asymmetrical tire that has a particular side that faces outward when mounted on a vehicle. The side of the tire that contains a whitewall, bears white lettering or bears manufacturer, brand, and/or model name molding that is higher or deeper than the same moldings on the other sidewall of the tire.

**Passenger (P-Metric) Tire:** A tire used on passenger cars and some light duty trucks and multipurpose vehicles.

**Recommended Inflation Pressure:** Vehicle manufacturer's recommended tire inflation pressure and shown on the tire placard. See *Inflation - Tire Pressure on page 5-80* and *Loading Your Vehicle on page 4-29*.

**Radial Ply Tire:** A pneumatic tire in which the ply cords that extend to the beads are laid at 90 degrees to the centerline of the tread.

**Rim:** A metal support for a tire and upon which the tire beads are seated.

**Sidewall:** The portion of a tire between the tread and the bead.

**Speed Rating:** An alphanumeric code assigned to a tire indicating the maximum speed at which a tire can operate.

**Traction:** The friction between the tire and the road surface. The amount of grip provided.

**Tread:** The portion of a tire that comes into contact with the road.

**Treadwear Indicators:** Narrow bands, sometimes called “wear bars,” that show across the tread of a tire when only 1/16 inch (1.6 mm) of tread remains. See *When It Is Time for New Tires on page 5-86*.

**UTQGS (Uniform Tire Quality Grading Standards):** A tire information system that provides consumers with ratings for a tire’s traction, temperature, and treadwear. Ratings are determined by tire manufacturers using government testing procedures. The ratings are molded into the sidewall of the tire. See *Uniform Tire Quality Grading on page 5-87*.

**Vehicle Capacity Weight:** The number of designated seating positions multiplied by 150 lbs (68 kg) plus the rated cargo load. See *Loading Your Vehicle on page 4-29*.

**Vehicle Maximum Load on the Tire:** Load on an individual tire due to curb weight, accessory weight, occupant weight, and cargo weight.

**Vehicle Placard:** A label permanently attached to a vehicle showing the vehicle’s capacity weight and the original equipment tire size and recommended inflation pressure. See “Tire and Loading Information Label” under *Loading Your Vehicle on page 4-29*.

## Inflation - Tire Pressure

Tires need the correct amount of air pressure to operate effectively.

**Notice:** Do not let anyone tell you that under-inflation or over-inflation is all right. It is not. If your tires do not have enough air (under-inflation), you can get the following:

- Too much flexing
- Too much heat
- Tire overloading
- Premature or irregular wear
- Poor handling
- Reduced fuel economy

If your tires have too much air (over-inflation), you can get the following:

- Unusual wear
- Poor handling
- Rough ride
- Needless damage from road hazards

A Tire and Loading Information label is attached to the vehicle's center pillar, below the driver's door latch. This label lists your vehicle's original equipment tires and shows the correct inflation pressures for your tires when they are cold. The recommended cold tire inflation pressure, shown on the label, is the minimum amount of air pressure needed to support your vehicle's maximum load carrying capacity.

For additional information regarding how much weight your vehicle can carry, and an example of the tire and loading information label, see *Loading Your Vehicle on page 4-29*. How you load your vehicle affects vehicle handling and ride comfort, never load your vehicle with more weight than it was designed to carry.

## How to Check

Use a good quality pocket-type gage to check tire pressure. You cannot tell if your tires are properly inflated simply by looking at them. Radial tires may look properly inflated even when they're under-inflated. Check the tire's inflation pressure when the tires are cold. Cold means your vehicle has been sitting for at least three hours or driven no more than 1 mile (1.6 km).

Remove the valve cap from the tire valve stem. Press the tire gage firmly onto the valve to get a pressure measurement. If the cold tire inflation pressure matches the recommended pressure on the Tire and Loading Information label, no further adjustment is necessary. If the inflation pressure is low, add air until you reach the recommended amount.

If you overfill the tire, release air by pushing on the metal stem in the center of the tire valve. Re-check the tire pressure with the tire gage.

Be sure to put the valve caps back on the valve stems. They help prevent leaks by keeping out dirt and moisture.

## High Speed Operation

### CAUTION:

**Driving at high speeds, 100 mph (160 km/h) or higher, puts an additional strain on tires. Sustained high-speed driving, causes excessive heat build up and can cause sudden tire failure. You could have a crash and you or others could be killed. Some high-speed rated tires require inflation pressure adjustment for high speed operation. When speed limits and road conditions are such, that a vehicle can be driven at high speeds, make sure the tires are rated for high speed operation, in excellent condition and set to the correct cold tire inflation pressure for the vehicle load.**

If you'll be driving at high speeds, speeds of 100 mph (160 km/h) or higher, where it is legal, set the cold inflation pressure to the maximum inflation pressure shown on the tire sidewall, or to 35 psi (244 kPa), whichever is lower. See the example below. When you end this high-speed driving, return to the cold inflation pressure shown on the Tire and Loading Information label. See *Loading Your Vehicle on page 4-29*.

#### **Example:**

You'll find maximum load and inflation pressure molded on the tire's sidewall, in small letters near the rim flange. It will read something like this: Maximum load 690 kg (1521 lbs) 300 kPa (44 psi) Max. Press.

For this example, you would set the inflation pressure for high-speed driving at 35 psi (244 kPa).

## Check Tire Pressure System

The check tire pressure system can alert you to a large change in the pressure of one tire. The system will not alert you before you drive that a tire is low or flat. You must begin driving before the system will work properly.

The CHECK TIRE PRESSURE message will appear on the Driver Information Center (DIC) or the system monitor TIRE PRESS light will come on if pressure difference (low pressure) is detected in one tire. The check tire pressure system may not alert you if:

- More than one tire is low.
- The vehicle is moving faster than 65 mph (105 km/h).
- The system is not yet calibrated.
- The compact spare tire is installed.
- The tire treadwear is uneven.
- Tire chains are being used.
- The vehicle is being driven on a rough or frozen road.

If the anti-lock brake system warning light comes on, the check tire pressure system may not be working properly. See your dealer for service. Also, see *Anti-Lock Brake System Warning Light on page 3-42*.

The check tire pressure system detects differences in tire rotation speeds that are caused by changes in tire pressure. The system can alert you about a low tire — but it does not replace normal tire maintenance. See *Tires on page 5-74*.

When the CHECK TIRE PRESSURE message appears on the Driver Information Center (DIC) or the systems monitor TIRE PRESS light comes on, you should stop as soon as you can and check all your tires for damage. If a tire is flat, see *If a Tire Goes Flat on page 5-92*. Also check the tire pressure in all four tires as soon as you can. See *Inflation - Tire Pressure on page 5-80*.

Any time you adjust a tire's pressure or have one or more tires repaired or replaced, you will need to reset (calibrate) the check tire pressure system. You will also need to reset the system whenever you rotate the tires, buy new tires and install or remove the compact spare.

Do not reset the check tire pressure system without first correcting the cause of the problem and checking and adjusting the pressure in all four tires. If you reset the system when the tire pressures are incorrect, the check tire pressure system will not work properly and may not alert you when a tire is low or high.

To reset (calibrate) the system with a Driver Information Center (DIC):

1. Turn the ignition switch to ON.
2. Using the MODE and SELECT buttons, change the DIC to display TIRE PRESSURE.
3. Press and hold the RESET button for about five seconds.
4. The display should change to read TIRE PRESSURE RESET. If TIRE PRESSURE RESET does not appear on the display after about five seconds, see your dealer for service.
5. When you release the button after seeing the TIRE PRESSURE RESET message, the display will change to read TIRE PRESSURE NORMAL.

To reset (calibrate) the system with a systems monitor:

1. Turn the ignition switch to ON.
2. Press and hold the TIRE PRESS RESET button for about five seconds.
3. The TIRE PRESS light on the systems monitor should begin to flash. If the TIRE PRESS light does not begin to flash after about five seconds, see your dealer for service.
4. Release the TIRE PRESS RESET button and the system should reset. The TIRE PRESS light will go out.

The system completes the calibration process during driving. Calibration time can take 45 to 90 minutes, depending on your driving habits. After the system has been calibrated, the system will alert the driver that a tire is low, up to a maximum speed of 65 mph (105 km/h).



## Tire Inspection and Rotation

Tires should be rotated every 5,000 to 8,000 miles (8 000 to 13 000 km).

Any time you notice unusual wear rotate your tires as soon as possible and check wheel alignment. Also check for damaged tires or wheels. See *When It Is Time for New Tires on page 5-86* and *Wheel Replacement on page 5-89* for more information.

The purpose of regular rotation is to achieve more uniform wear for all tires on the vehicle. The first rotation is the most important. See *Part A: Scheduled Maintenance Services on page 6-4*, for scheduled rotation intervals.

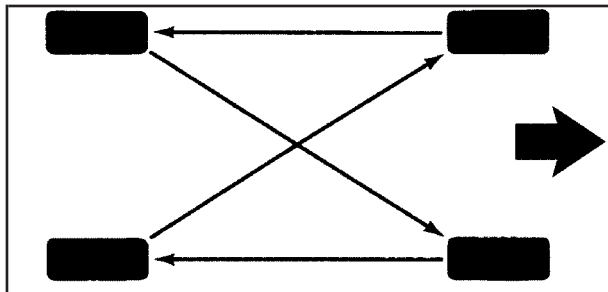

When rotating your tires, always use the correct rotation pattern shown here.

Don't include the compact spare tire in your tire rotation.

After the tires have been rotated, adjust the front and rear inflation pressures as shown on the Tire and Loading Information label.

Reset the check tire pressure system, if equipped. See *Check Tire Pressure System on page 5-83*.

Make certain that all wheel nuts are properly tightened. See "Wheel Nut Torque" under *Capacities and Specifications on page 5-121*.

### CAUTION:

Rust or dirt on a wheel, or on the parts to which it is fastened, can make wheel nuts become loose after a time. The wheel could come off and cause an accident. When you change a wheel, remove any rust or dirt from places where the wheel attaches to the vehicle. In an emergency, you can use a cloth or a paper towel to do this; but be sure to use a scraper or wire brush later, if you need to, to get all the rust or dirt off. See *Changing a Flat Tire on page 5-93*.

## When It Is Time for New Tires

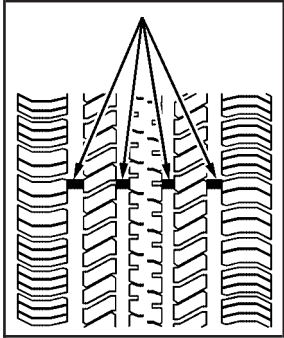

One way to tell when it's time for new tires is to check the treadwear indicators, which will appear when your tires have only 1/16 inch (1.6 mm) or less of tread remaining.

You need a new tire if any of the following statements are true:

- You can see the indicators at three or more places around the tire.
- You can see cord or fabric showing through the tire's rubber.
- The tread or sidewall is cracked, cut or snagged deep enough to show cord or fabric.
- The tire has a bump, bulge or split.
- The tire has a puncture, cut or other damage that can't be repaired well because of the size or location of the damage.

## Buying New Tires

To find out what kind and size of tires your vehicle needs, look at the tire and loading information label. For more information about this label and its location on your vehicle, see *Loading Your Vehicle on page 4-29*.

The tires installed on your vehicle when it was new had a Tire Performance Criteria Specification (TPC Spec) number on each tire's sidewall. When you get new tires, GM recommends that you get tires with that same TPC Spec number. That way your vehicle will continue to have tires that are designed to give proper endurance, handling, speed rating, load range, traction, ride and other things during normal service on your vehicle. If your tires have an all-season tread design, the TPC number will be followed by an "MS" (for mud and snow).

If you ever replace your tires with those not having a TPC Spec number, make sure they are the same size, load range, speed rating and construction type (bias, bias-belted or radial) as your original tires.

 **CAUTION:**

Mixing tires could cause you to lose control while driving. If you mix tires of different sizes or types (radial and bias-belted tires), the vehicle may not handle properly, and you could have a crash. Using tires of different sizes may also cause damage to your vehicle. Be sure to use the same size and type tires on all wheels. It's all right to drive with your compact spare temporarily, it was developed for use on your vehicle. See *Compact Spare Tire* on page 5-100.

 **CAUTION:**

If you use bias-ply tires on your vehicle, the wheel rim flanges could develop cracks after many miles of driving. A tire and/or wheel could fail suddenly, causing a crash. Use only radial-ply tires with the wheels on your vehicle.

## Uniform Tire Quality Grading

Quality grades can be found where applicable on the tire sidewall between tread shoulder and maximum section width. For example:

### Treadwear 200 Traction AA Temperature A

The following information relates to the system developed by the United States National Highway Traffic Safety Administration, which grades tires by treadwear, traction and temperature performance. (This applies only to vehicles sold in the United States.) The grades are molded on the sidewalls of most passenger car tires. The Uniform Tire Quality Grading system does not apply to deep tread, winter-type snow tires, space-saver or temporary use spare tires, tires with nominal rim diameters of 10 to 12 inches (25 to 30 cm), or to some limited-production tires.

While the tires available on General Motors passenger cars and light trucks may vary with respect to these grades, they must also conform to federal safety requirements and additional General Motors Tire Performance Criteria (TPC) standards.

## **Treadwear**

The treadwear grade is a comparative rating based on the wear rate of the tire when tested under controlled conditions on a specified government test course. For example, a tire graded 150 would wear one and a half (1.5) times as well on the government course as a tire graded 100. The relative performance of tires depends upon the actual conditions of their use, however, and may depart significantly from the norm due to variations in driving habits, service practices and differences in road characteristics and climate.

## **Traction – AA, A, B, C**

The traction grades, from highest to lowest, are AA, A, B, and C. Those grades represent the tire's ability to stop on wet pavement as measured under controlled conditions on specified government test surfaces of asphalt and concrete. A tire marked C may have poor traction performance. Warning: The traction grade assigned to this tire is based on straight-ahead braking traction tests, and does not include acceleration, cornering, hydroplaning, or peak traction characteristics.

## **Temperature – A, B, C**

The temperature grades are A (the highest), B, and C, representing the tire's resistance to the generation of heat and its ability to dissipate heat when tested under controlled conditions on a specified indoor laboratory test wheel. Sustained high temperature can cause the material of the tire to degenerate and reduce tire life, and excessive temperature can lead to sudden tire failure. The grade C corresponds to a level of performance which all passenger car tires must meet under the Federal Motor Vehicle Safety Standard No. 109. Grades B and A represent higher levels of performance on the laboratory test wheel than the minimum required by law.

Warning: The temperature grade for this tire is established for a tire that is properly inflated and not overloaded. Excessive speed, underinflation, or excessive loading, either separately or in combination, can cause heat buildup and possible tire failure.

## Wheel Alignment and Tire Balance

The wheels on your vehicle were aligned and balanced carefully at the factory to give you the longest tire life and best overall performance.

If you notice unusual tire wear or your vehicle pulling one way or the other, the alignment may need to be reset. If you notice your vehicle vibrating when driving on a smooth road, your wheels may need to be rebalanced.

## Wheel Replacement

Replace any wheel that is bent, cracked or badly rusted or corroded. If wheel nuts keep coming loose, the wheel, wheel bolts and wheel nuts should be replaced. If the wheel leaks air, replace it (except some aluminum wheels, which can sometimes be repaired). See your dealer if any of these conditions exist.

Your dealer will know the kind of wheel you need.

Each new wheel should have the same load-carrying capacity, diameter, width, offset and be mounted the same way as the one it replaces.

If you need to replace any of your wheels, wheel bolts or wheel nuts, replace them only with new GM original equipment parts. This way, you will be sure to have the right wheel, wheel bolts and wheel nuts for your vehicle.

### **CAUTION:**

**Using the wrong replacement wheels, wheel bolts or wheel nuts on your vehicle can be dangerous. It could affect the braking and handling of your vehicle, make your tires lose air and make you lose control. You could have a collision in which you or others could be injured. Always use the correct wheel, wheel bolts and wheel nuts for replacement.**

**Notice:** The wrong wheel can also cause problems with bearing life, brake cooling, speedometer or odometer calibration, headlamp aim, bumper height, vehicle ground clearance and tire or tire chain clearance to the body and chassis.

See *Changing a Flat Tire* on page 5-93 for more information.

## Used Replacement Wheels

### CAUTION:

Putting a used wheel on your vehicle is dangerous. You can't know how it's been used or how far it's been driven. It could fail suddenly and cause a crash. If you have to replace a wheel, use a new GM original equipment wheel.

## Tire Chains

### CAUTION:

If your vehicle has P235/55R17 or P235/50R18 size tires, do not use tire chains, there is not enough clearance.

Tire chains used on a vehicle without the proper amount of clearance can cause damage to the brakes, suspension or other vehicle parts. The area damaged by the tire chains could cause you to lose control of your vehicle and you or others may be injured in a crash.

Use another type of traction device only if its manufacturer recommends it for use on your vehicle and tire size combination and road conditions. Follow that manufacturer's instructions. To help avoid damage to your vehicle, drive slowly, readjust or remove the device if it is contacting your vehicle, and do not spin your wheels.

If you do find traction devices that will fit, install them on the front tires.

**Notice:** If your vehicle has a tire size other than P235/55R17 or P235/50R18 size tires, use tire chains only where legal and only when you must. Use only SAE Class “S” type chains that are the proper size for your tires. Install them on the front tires and tighten them as tightly as possible with the ends securely fastened. Drive slowly and follow the chain manufacturer’s instructions. If you can hear the chains contacting your vehicle, stop and retighten them. If the contact continues, slow down until it stops. Driving too fast or spinning the wheels with chains on will damage your vehicle.

## Accessory Inflator



If your vehicle has an accessory inflator, it is located in the trunk. The accessory inflator will work only with the ignition on.

### CAUTION:

Inflating something too much can make it explode, and you or others could be injured. Be sure to read the inflator instructions, and inflate any object only to its recommended pressure.

Pressing the AIR button will activate the inflator for 10 minutes.

**Notice:** If you run the accessory inflator longer than 30 minutes at a time, you could damage the inflator. The repairs would not be covered by your warranty. Run the inflator for short periods of time only.

The accessory inflator comes with a kit that includes a 20-foot (6.1 m) hose and an air pressure gage, as well as instructions and special adapters for inflating things like an air mattress or a basketball.

## If a Tire Goes Flat

It's unusual for a tire to "blowout" while you're driving, especially if you maintain your tires properly. If air goes out of a tire, it's much more likely to leak out slowly. But if you should ever have a "blowout," here are a few tips about what to expect and what to do:

If a front tire fails, the flat tire will create a drag that pulls the vehicle toward that side. Take your foot off the accelerator pedal and grip the steering wheel firmly. Steer to maintain lane position, and then gently brake to a stop well out of the traffic lane.

A rear blowout, particularly on a curve, acts much like a skid and may require the same correction you'd use in a skid. In any rear blowout, remove your foot from the accelerator pedal. Get the vehicle under control by steering the way you want the vehicle to go. It may be very bumpy and noisy, but you can still steer. Gently brake to a stop, well off the road if possible.



### **CAUTION:**

**Lifting a vehicle and getting under it to do maintenance or repairs is dangerous without the appropriate safety equipment and training. The jack provided with your vehicle is designed only for changing a flat tire. If it is used for anything else, you or others could be badly injured or killed if the vehicle slips off the jack. Use the jack provided with your vehicle only for changing a flat tire.**

If a tire goes flat, the next part shows how to use your jacking equipment to change a flat tire safely.



## Changing a Flat Tire

If a tire goes flat, avoid further tire and wheel damage by driving slowly to a level place. Turn on your hazard warning flashers.

### CAUTION:

Changing a tire can be dangerous. The vehicle can slip off the jack and roll over or fall on you or other people. You and they could be badly injured or even killed. Find a level place to change your tire. To help prevent the vehicle from moving:

1. Set the parking brake firmly.
2. Put the shift lever in PARK (P).
3. Turn off the engine and do not restart while the vehicle is raised.
4. Do not allow passengers to remain in the vehicle.

To be even more certain the vehicle will not move, you should put blocks at the front and rear of the tire farthest away from the one being changed. That would be the tire, on the other side, at the opposite end of the vehicle.

When you have a flat tire, use the following example as a guide to assist you in the placement of wheel blocks.

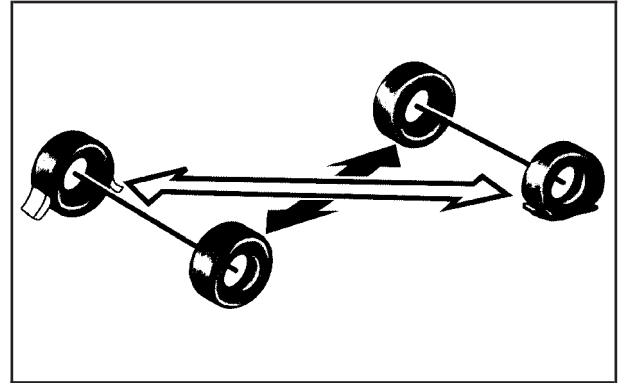

The following information will tell you next how to use the jack and change a tire.

## Removing the Spare Tire and Tools

The equipment you will need is in the trunk.

1. Pull the carpeting from the floor of the trunk.
2. Remove the retainer, then lift and remove the cover.



The tools you will be using include the jack (A) and wheel wrench (B).

3. Unscrew the wing nut and washer to remove the container that holds the wrench and jack.
4. Remove the compact spare tire. See *Compact Spare Tire on page 5-100* for more information.
5. Remove the wheel wrench, jack and the spare tire from the trunk.

## Removing the Flat Tire and Installing the Spare Tire

1. If your vehicle has aluminum wheels and a center cover hides the wheel nuts, remove the center cover by using the flat end of the wrench to pry it off. Do not drop the cover or lay it face down, as it could become scratched or damaged. Do not use a hammer or mallet on this type of cover.

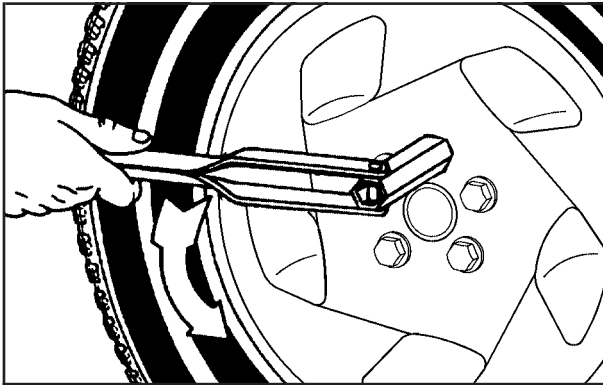

2. Use the wheel wrench to loosen the wheel nuts, but do not remove them.
3. Attach the wheel wrench to the bolt to create a jack handle.



4. Turn the wheel wrench counterclockwise to lower the jack lift head until it fits under the vehicle.

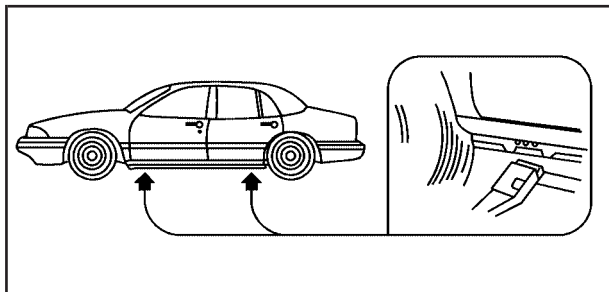

5. Put the jack head into a notch in the frame which is located near each wheel well. The front notch is 11 inches (28 cm) back from the front wheel well. The rear notch is 3.5 inches (9 cm) forward from the rear wheel well.

**⚠ CAUTION:**

Getting under a vehicle when it is jacked up is dangerous. If the vehicle slips off the jack you could be badly injured or killed. Never get under a vehicle when it is supported only by a jack.

**⚠ CAUTION:**

Raising your vehicle with the jack improperly positioned can damage the vehicle and even make the vehicle fall. To help avoid personal injury and vehicle damage, be sure to fit the jack lift head into the proper location before raising the vehicle.



6. Raise the vehicle by turning the wheel wrench clockwise. Raise the vehicle far enough off the ground so there is enough room for the compact spare tire to fit under the wheel well.
7. Remove all the wheel nuts and take off the flat tire.

## CAUTION:

Rust or dirt on the wheel, or on the parts to which it is fastened, can make the wheel nuts become loose after a time. The wheel could come off and cause an accident. When you change a wheel, remove any rust or dirt from the places where the wheel attaches to the vehicle. In an emergency, you can use a cloth or a paper towel to do this; but be sure to use a scraper or wire brush later, if you need to, to get all the rust or dirt off.

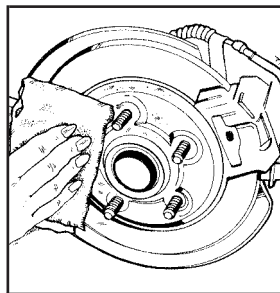

8. Remove any rust or dirt from the wheel bolts, mounting surfaces and spare wheel.

- Place the compact spare tire on the wheel-mounting surface.

**⚠ CAUTION:**

**Never use oil or grease on studs or nuts. If you do, the nuts might come loose. Your wheel could fall off, causing a serious accident.**



- Reinstall the wheel nuts with the rounded end of the nuts toward the wheel.



- Lower the vehicle by turning the wheel wrench counterclockwise. Lower the jack completely.

- Make sure each wheel bolt is centered in each wheel hole while tightening the nuts. Tighten each nut by hand until the wheel is held against the hub.

**⚠ CAUTION:**

Incorrect wheel nuts or improperly tightened wheel nuts can cause the wheel to come loose and even come off. This could lead to an accident. Be sure to use the correct wheel nuts. If you have to replace them, be sure to get new GM original equipment wheel nuts. Stop somewhere as soon as you can and have the nuts tightened with a torque wrench to the proper torque specification. See *Capacities and Specifications on page 5-121* for wheel nut torque specification.

**Notice:** Improperly tightened wheel nuts can lead to brake pulsation and rotor damage. To avoid expensive brake repairs, evenly tighten the wheel nuts in the proper sequence and to the proper torque specification. See *Capacities and Specifications on page 5-121* for the wheel nut torque specification.

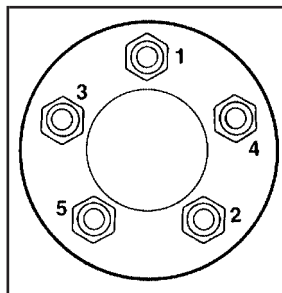

13. Tighten the wheel nuts firmly in a crisscross sequence.

**Notice:** Wheel covers will not fit on your compact spare. If you try to put a wheel cover on the compact spare, you could damage the cover or the spare.

14. Do not try to put the wheel cover on the compact spare tire. It will not fit. Store the wheel cover in the trunk until you have replaced the compact spare tire with a regular tire.

When you reinstall the full size wheel and tire, you install the wheel cover or nut caps at this point.

When reinstalling the nut caps on aluminum wheels, tighten the caps snug with the wheel wrench. Then continue tightening one-quarter turn for plastic caps, or one-eighth turn for steel caps. Do not overtighten.

## Storing a Flat or Spare Tire and Tools

### CAUTION:

Storing a jack, a tire, or other equipment in the passenger compartment of the vehicle could cause injury. In a sudden stop or collision, loose equipment could strike someone. Store all these in the proper place.

After you have put the compact spare tire on your vehicle, you will need to store the flat tire in your trunk.

Store the flat tire as far forward in the trunk as possible. Store the jack and wheel wrench in their compartment in the trunk. For storage, the jack must be raised until the screw end is flush with the edge of the jack.

The compact spare tire is for temporary use only. Replace the compact spare tire with a full-size tire as soon as you can. See *Compact Spare Tire on page 5-100* for more information. See the storing instructions label to return your compact spare tire to your trunk properly.

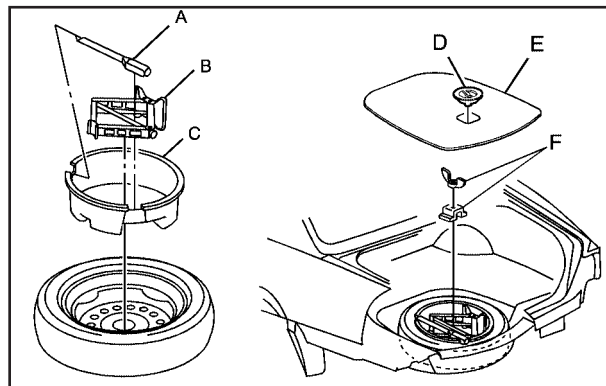

- A. Wrench
- B. Jack
- C. Jack Container
- D. Retainer
- E. Compact Spare Tire Cover
- F. Washer and Wingnut

## Compact Spare Tire

Although the compact spare tire was fully inflated when your vehicle was new, it can lose air after a time. Check the inflation pressure regularly. It should be 60 psi (420 kPa).



After installing the compact spare on your vehicle, you should stop as soon as possible and make sure your spare tire is correctly inflated. The compact spare is made to perform well at speeds up to 65 mph (105 km/h) for distances up to 3,000 miles (5 000 km), so you can finish your trip and have your full-size tire repaired or replaced where you want. You must calibrate the Check Tire Pressure System after installing or removing the compact spare. See *Check Tire Pressure System* on page 5-83. Of course, it's best to replace your spare with a full-size tire as soon as you can. Your spare will last longer and be in good shape in case you need it again.

**Notice:** When the compact spare is installed, do not take your vehicle through an automatic car wash with guide rails. The compact spare can get caught on the rails. That can damage the tire and wheel, and maybe other parts of your vehicle.

Don't use your compact spare on other vehicles.

And don't mix your compact spare tire or wheel with other wheels or tires. They won't fit. Keep your compact spare tire and its wheel together.

**Notice:** Tire chains will not fit your compact spare. Using them can damage your vehicle and can damage the chains too. Do not use tire chains on your compact spare.

## Appearance Care

Cleaning products can be hazardous. Some are toxic. Other cleaning products can burst into flames if a match is struck near them or if they get on a hot part of the vehicle. Some are dangerous if their fumes are inhaled in a closed space. When anything from a container is used to clean the vehicle, be sure to follow the manufacturer's warnings and instructions. Always open the doors or windows of the vehicle when cleaning the inside.

Never use these to clean the vehicle:

- Gasoline
- Benzene
- Naphtha
- Carbon Tetrachloride
- Acetone
- Paint Thinner
- Turpentine
- Lacquer Thinner
- Nail Polish Remover

They can all be hazardous — some more than others — and they can all damage the vehicle, too.

Do not use any of these products unless this manual says you can. In many uses, these will damage the vehicle:

- Alcohol
- Laundry Soap
- Bleach
- Reducing Agents

## Fabric/Carpet

Use a vacuum cleaner often to get rid of dust and loose dirt. Wipe vinyl, leather, plastic, and painted surfaces with a clean, damp cloth.

GM-approved cleaning products can be obtained from your dealer.

Here are some cleaning tips:

- Always read the instructions on the cleaner label.
- Clean up stains as soon as you can before they set.
- Carefully scrape off any excess stain.

- Use a clean cloth or sponge, and change to a clean area often. A soft brush may be used if stains are stubborn.
- To avoid forming a ring on fabric after spot cleaning, clean the entire area immediately or it will set.

Most stains can be removed with club soda water. To clean, use the following instructions:

1. For liquids: blot with a clean, soft, white cloth. For solids: remove as much as possible and then vacuum or brush.
2. Apply club soda water to a clean, soft, white cloth. Do not over-saturate; the cloth should not drip water.
3. Clean the entire area. Avoid getting the fabric too wet.
4. Start cleaning from the seams into the stain to avoid a ring effect.
5. Continue cleaning, using a clean area of the cloth each time it becomes soiled.
6. When the stain is removed, blot the cleaned area with another dry, clean, soft, white cloth.

## Using Cleaner on Fabric

1. First, try the cleaner on an area of the fabric that is not easily seen to make sure the cleaner does not affect the color of the fabric.
2. For liquids: blot with a clean, soft, white cloth.  
For solids: remove as much as possible and then vacuum or brush.
3. Spray a small amount of the cleaner onto a clean soft, white, cloth. Do not apply spray directly to the fabric.
4. Start cleaning from the seams into the stain to avoid a ring effect.
5. Continue cleaning, using a clean area of the cloth each time it becomes soiled.
6. When the stain is removed, blot the cleaned area with another dry, clean, soft, white cloth.
7. If the cleaner leaves a ring effect, follow up with the club soda water instructions given earlier in this section.

## Special Fabric Cleaning Problems

Stains caused by such things as catsup, black coffee, egg, fruit, fruit juice, milk, soft drinks, vomit, urine, and blood can be removed using the club soda water instructions given earlier in this section. If an odor lingers after cleaning vomit or urine, treat the area with a water and baking soda solution: 1 teaspoon (5 ml) of baking soda to 1 cup (250 ml) of lukewarm water. Let dry.

Stains caused by oil and grease can be cleaned with an approved GM cleaner and a clean, white cloth.

1. Carefully scrape off excess stain.
2. Clean with cool water and allow to dry completely.
3. If a stain remains, follow the “Using Cleaner on Fabric” instructions described earlier.

## Vinyl

Use warm water and a clean cloth.

- Rub with a clean, damp cloth to remove dirt. This may have to be done more than once.
- Things like tar, asphalt, and shoe polish will stain if they are not removed quickly. Use a clean cloth and vinyl cleaner. See your dealer for this product.

## Leather

Use a soft cloth with lukewarm water and a mild soap or saddle soap and wipe dry with a soft cloth. Then, let the leather dry naturally. Do not use heat to dry.

- For stubborn stains, use a leather cleaner.
- Never use oils, varnishes, solvent-based or abrasive cleaners, furniture polish, or shoe polish on leather.
- Soiled or stained leather should be cleaned immediately. If dirt is allowed to work into the finish, it can harm the leather.

## Instrument Panel

Use only mild soap and water to clean the top surfaces of the instrument panel. Sprays containing silicones or waxes may cause annoying reflections in the windshield and even make it difficult to see through the windshield under certain conditions.

## Interior Plastic Components

Use only a mild soap and water solution on a soft cloth or sponge. Commercial cleaners may affect the surface finish.

## Glass Surfaces

Glass should be cleaned often. GM Glass Cleaner or a liquid household glass cleaner will remove normal tobacco smoke and dust films on interior glass. See *Vehicle Care/Appearance Materials on page 5-109*.

**Notice:** If you use abrasive cleaners when cleaning glass surfaces on your vehicle, you could scratch the glass and/or cause damage to the rear window defogger and the integrated radio antenna. When cleaning the glass on your vehicle, use only a soft cloth and glass cleaner.

## Care of Safety Belts

Keep belts clean and dry.

### CAUTION:

Do not bleach or dye safety belts. If you do, it may severely weaken them. In a crash, they might not be able to provide adequate protection. Clean safety belts only with mild soap and lukewarm water.

## Weatherstrips

Silicone grease on weatherstrips will make them last longer, seal better, and not stick or squeak. Apply silicone grease with a clean cloth. During very cold, damp weather frequent application may be required.

## Washing Your Vehicle

The paint finish on the vehicle provides beauty, depth of color, gloss retention, and durability.

The best way to preserve the vehicle's finish is to keep it clean by washing it often with lukewarm or cold water.

Do not wash the vehicle in the direct rays of the sun. Use a car washing soap. Do not use strong soaps or chemical detergents. Be sure to rinse the vehicle well, removing all soap residue completely. GM-approved cleaning products can be obtained from your dealer. See *Vehicle Care/Appearance Materials* on page 5-109.

Do not use cleaning agents that are petroleum based, or that contain acid or abrasives. All cleaning agents should be flushed promptly and not allowed to dry on the surface, or they could stain. Dry the finish with a soft, clean chamois or an all-cotton towel to avoid surface scratches and water spotting.

**Notice:** If you drive your vehicle through an automatic car wash that does not have enough clearance for the wide rear tires and wheels, you could damage your vehicle. Verify with the manager of the car wash that your vehicle will fit before entering the car wash or use a touchless car wash.

High pressure car washes may cause water to enter the vehicle.

## Cleaning Exterior Lamps/Lenses

Use only lukewarm or cold water, a soft cloth and a car washing soap to clean exterior lamps and lenses. Follow instructions under *Washing Your Vehicle* on page 5-105.

## Finish Care

Occasional waxing or mild polishing of the vehicle by hand may be necessary to remove residue from the paint finish. GM-approved cleaning products can be obtained from your dealer. See *Vehicle Care/Appearance Materials on page 5-109*.

The vehicle has a “basecoat/clearcoat” paint finish. The clearcoat gives more depth and gloss to the colored basecoat. Always use waxes and polishes that are non-abrasive and made for a basecoat/clearcoat paint finish.

**Notice: Machine compounding or aggressive polishing on a basecoat/clearcoat paint finish may damage it. Use only non-abrasive waxes and polishes that are made for a basecoat/clearcoat paint finish on your vehicle.**

Foreign materials such as calcium chloride and other salts, ice melting agents, road oil and tar, tree sap, bird droppings, chemicals from industrial chimneys, etc., can damage the vehicle’s finish if they remain on painted surfaces. Wash the vehicle as soon as possible. If necessary, use non-abrasive cleaners that are marked safe for painted surfaces to remove foreign matter.

Exterior painted surfaces are subject to aging, weather, and chemical fallout that can take their toll over a period of years. To help keep the paint finish looking new, keep the vehicle in a garage or covered whenever possible.

## Windshield and Wiper Blades

If the windshield is not clear after using the windshield washer, or if the wiper blade chatters when running, wax, sap, or other material may be on the blade or windshield.

Clean the outside of the windshield with a glass cleaning liquid or powder and water solution. The windshield is clean if beads do not form when it is rinsed with water.

Grime from the windshield will stick to the wiper blades and affect their performance. Clean the blade by wiping vigorously with a cloth soaked in full-strength windshield washer solvent. Then rinse the blade with water.

Check the wiper blades and clean them as necessary; replace blades that look worn.

## Aluminum or Chrome-Plated Wheels

The vehicle may be equipped with either aluminum or chrome-plated wheels.

Keep the wheels clean using a soft clean cloth with mild soap and water. Rinse with clean water. After rinsing thoroughly, dry with a soft clean towel. A wax may then be applied.

**Notice:** If you use strong soaps, chemicals, abrasive polishes, cleaners, brushes, or cleaners that contain acid on aluminum or chrome-plated wheels, you could damage the surface of the wheel(s). The repairs would not be covered by your warranty. Use only GM-approved cleaners on aluminum or chrome-plated wheels.

The surface of these wheels is similar to the painted surface of your vehicle. Do not use strong soaps, chemicals, abrasive polishes, abrasive cleaners, cleaners with acid, or abrasive cleaning brushes on them because you could damage the surface. Do not use chrome polish on aluminum wheels.

**Notice:** Using chrome polish on aluminum wheels could damage the wheels. The repairs would not be covered by your warranty. Use chrome polish on chrome wheels only.

Use chrome polish only on chrome-plated wheels, but avoid any painted surface of the wheel, and buff off immediately after application.

**Notice:** If you drive your vehicle through an automatic car wash that has silicone carbide tire cleaning brushes, you could damage the aluminum or chrome-plated wheels. The repairs would not be covered by your warranty. Never drive a vehicle equipped with aluminum or chrome-plated wheels through an automatic car wash that uses silicone carbide tire cleaning brushes.

Do not take your vehicle through an automatic car wash that has silicone carbide tire cleaning brushes. These brushes can also damage the surface of these wheels.

## Tires

To clean the tires, use a stiff brush with tire cleaner.

**Notice:** Using petroleum-based tire dressing products on your vehicle may damage the paint finish and/or tires. When applying a tire dressing, always wipe off any overspray from all painted surfaces on your vehicle.

## Sheet Metal Damage

If the vehicle is damaged and requires sheet metal repair or replacement, make sure the body repair shop applies anti-corrosion material to parts repaired or replaced to restore corrosion protection.

Original manufacturer replacement parts will provide the corrosion protection while maintaining the warranty.

## Finish Damage

Any stone chips, fractures or deep scratches in the finish should be repaired right away. Bare metal will corrode quickly and may develop into major repair expense.

Minor chips and scratches can be repaired with touch-up materials available from your GM dealer. Larger areas of finish damage can be corrected in your GM dealer's body and paint shop.

## Underbody Maintenance

Chemicals used for ice and snow removal and dust control can collect on the underbody. If these are not removed, corrosion and rust can develop on the underbody parts such as fuel lines, frame, floor pan, and exhaust system even though they have corrosion protection.

At least every spring, flush these materials from the underbody with plain water. Clean any areas where mud and debris can collect. Dirt packed in close areas of the frame should be loosened before being flushed. Your GM dealer or an underbody car washing system can do this for you.

## Chemical Paint Spotting

Some weather and atmospheric conditions can create a chemical fallout. Airborne pollutants can fall upon and attack painted surfaces on the vehicle. This damage can take two forms: blotchy, ring-shaped discolorations, and small, irregular dark spots etched into the paint surface.

Although no defect in the paint job causes this, GM will repair, at no charge to the owner, the surfaces of new vehicles damaged by this fallout condition within 12 months or 12,000 miles (20 000 km) of purchase, whichever occurs first.



## Vehicle Care/Appearance Materials

See your GM dealer for more information on purchasing the following products.

Description	Usage
Polishing Cloth Wax-Treated	Interior and exterior polishing cloth.
Tar and Road Oil Remover	Removes tar, road oil and asphalt.
Chrome Cleaner and Polish	Use on chrome or stainless steel.
White Sidewall Tire Cleaner	Removes soil and black marks from whitewalls.
Vinyl Cleaner	Cleans vinyl tops, upholstery and convertible tops.
Glass Cleaner	Removes dirt, grime, smoke and fingerprints.
Chrome and Wire Wheel Cleaner	Removes dirt and grime from chrome wheels and wire wheel covers.
Finish Enhancer	Removes dust, fingerprints, and surface contaminants. Spray on wipe off.

Description	Usage
Swirl Remover Polish	Removes swirl marks, fine scratches and other light surface contamination.
Cleaner Wax	Removes light scratches and protects finish.
Foaming Tire Shine Low Gloss	Cleans, shines and protects in one easy step, no wiping necessary.
Wash Wax Concentrate	Medium foaming shampoo. Cleans and lightly waxes. Biodegradable and phosphate free.
Spot Lifter	Quickly and easily removes spots and stains from carpets, vinyl and cloth upholstery.
Odor Eliminator	Odorless spray odor eliminator used on fabrics, vinyl, leather and carpet.
See your General Motors parts department for these products.	

# Vehicle Identification

## Vehicle Identification Number (VIN)



This is the legal identifier for your vehicle. It appears on a plate in the front corner of the instrument panel, on the driver's side. You can see it if you look through the windshield from outside your vehicle. The VIN also appears on the Vehicle Certification and Service Parts labels and the certificates of title and registration.

## Engine Identification

The 8th character in your VIN is the engine code. This code will help you identify your engine, specifications and replacement parts.

## Service Parts Identification Label

You will find this label on your spare tire cover. It is very helpful if you ever need to order parts. On this label, you will find the following:

- VIN
- Model designation
- Paint information
- Production options and special equipment

Be sure that this label is not removed from the vehicle.

# Electrical System

## Add-On Electrical Equipment

**Notice:** Don't add anything electrical to your vehicle unless you check with your dealer first. Some electrical equipment can damage your vehicle and the damage wouldn't be covered by your warranty. Some add-on electrical equipment can keep other components from working as they should.

Your vehicle has an air bag system. Before attempting to add anything electrical to your vehicle, see *Servicing Your Airbag-Equipped Vehicle* on page 1-56.

## Headlamp Wiring

The headlamp wiring is protected by an internal circuit breaker. An electrical overload will cause the lamps to go on and off, or in some cases to remain off. If this happens, have your headlamp system checked right away.

## Windshield Wiper Fuses

The windshield wiper motor is protected by an internal circuit breaker and a fuse. If the motor overheats due to heavy snow, etc., the wiper will stop until the motor cools. If the overload is caused by some electrical problem, have it fixed.

## Power Windows and Other Power Options

Circuit breakers in the rear fuse block protect the power windows and other power accessories. When the current load is too heavy, the circuit breaker opens and closes, protecting the circuit until the problem is fixed or goes away.

## Fuses and Circuit Breakers

The wiring circuits in your vehicle are protected from short circuits by a combination of fuses and circuit breakers. This greatly reduces the chance of damage caused by electrical problems.

Look at the silver-colored band inside the fuse. If the band is broken or melted, replace the fuse. Be sure you replace a bad fuse with a new one of the identical size and rating.

The MaxiFuses are located in two fuse blocks, one in the engine compartment and the other under the rear seat. If a MaxiFuse should blow, have your vehicle serviced by your dealer immediately.

## Removing Fuses

You will find a fuse puller attached in both of the fuse blocks. Snap the wide end of the fuse puller on to the fuse at the side indentations, then hold the puller and pull the fuse out.

## Engine Compartment Fuse Block (3.8L V6 Engine)



The engine compartment fuse block is located in the front of the engine compartment on the passenger's side of the vehicle. See *Engine Compartment Overview* on page 5-12 for more information on location. Lift the cover to gain access.

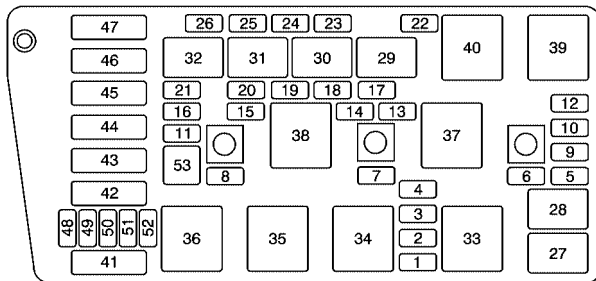

Fuses	Usage
1	Not Used
2	Accessory
3	Windshield Wipers
4	Not Used
5	Headlamp Low-Beam Left
6	Headlamp Low-Beam Right
7	Spare
8	Powertrain Control Module Battery
9	Headlamp High-Beam Right
10	Headlamp High-Beam Left
11	Ignition 1
12	Not Used
13	Transaxle

<b>Fuses</b>	<b>Usage</b>
14	Cruise Control
15	Direct Ignition System
16	Injector Bank #2
17	Not Used
18	Not Used
19	Powertrain Control Module Ignition
20	Oxygen Sensor
21	Injector Bank #1
22	Auxiliary Power
23	Cigar Lighter
24	Fog Lamps/Daytime Running Lamps
25	Horn
26	Air Conditioning Clutch

<b>Relays</b>	<b>Usage</b>
27	Headlamp High Beam
28	Headlamp Low Beam
29	Fog Lamps
30	Daytime Running Lamps
31	Horn
32	Air Conditioning Clutch
33	HVAC Solenoid
34	Accessory

<b>Relays</b>	<b>Usage</b>
35	Not Used
36	Starter 1
37	Cooling Fan 1
38	Ignition 1
39	Cooling Fan Series/Parallel
40	Cooling Fan 2

<b>Circuit Breakers</b>	<b>Usage</b>
41	Starter

<b>Fuses</b>	<b>Usage</b>
42	Not Used
43	Not Used
44	Antilock Brake System
45	Not Used
46	Cooling Fan 1
47	Cooling Fan 2
48	Spare
49	Spare
50	Spare
51	Spare
52	Spare
53	Fuse Puller

## Engine Compartment Fuse Block (4.6L V8 Engine)



The engine compartment fuse block is located next to the engine on the passenger's side of the vehicle. For more information on location, see *Engine Compartment Overview* on page 5-12.

To access the fuses, push in the two tabs located at each end of the fuse block cover. Then lift the cover off.

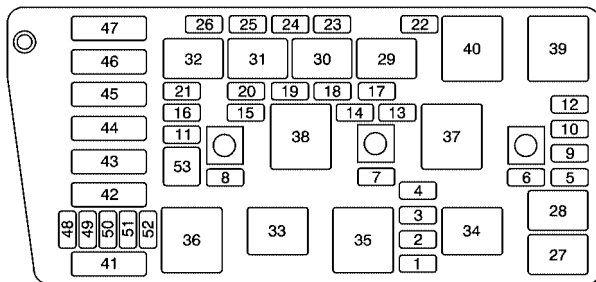

Fuses	Usage
1	Assembly Line Diagnostic Link
2	Accessory
3	Windshield Wipers
4	Not Used
5	Headlamp Low-Beam Left
6	Headlamp Low-Beam Right
7	Instrument Panel
8	Powertrain Control Module Battery
9	Headlamp High-Beam Right
10	Headlamp High-Beam Left
11	Ignition 1

<b>Fuses</b>	<b>Usage</b>
12	Fog Lamps
13	Transaxle
14	Cruise Control
15	Coil Module
16	Injector Bank #2
17	Not Used
18	Not Used
19	Powertrain Control Module Ignition
20	Oxygen Sensor
21	Injector Bank #1
22	Cigar Lighter #2
23	Cigar Lighter #1
24	Daytime Running Lamps
25	Horn
26	Air Conditioner Clutch
42	Not Used
43	Not Used
44	Anti-Lock Brake System
45	Air Pump
46	Cooling Fan 1
47	Cooling Fan 2
54	Spare

<b>Relays</b>	<b>Usage</b>
27	Headlamp High Beam
28	Headlamp Low Beam
29	Fog Lamps
30	Daytime Running Lamps
31	Horn
32	Air Conditioner Clutch
33	Air Control Valve
34	Spare
35	Accessory
36	Starter 1
37	Cooling Fan 1
38	Ignition 1
39	Cooling Fan Series/Parallel
40	Cooling Fan 2

<b>Circuit Breakers</b>	<b>Usage</b>
41	Starter

The spare fuses are located in numbers 48 through 52. The fuse puller is located in number 53.

## Rear Underseat Fuse Block



The rear fuse block is located below the rear seat on the driver's side of the vehicle. The rear seat cushion must be removed to access the fuse block. See "Removing the Rear Seat Cushion" following for more information.

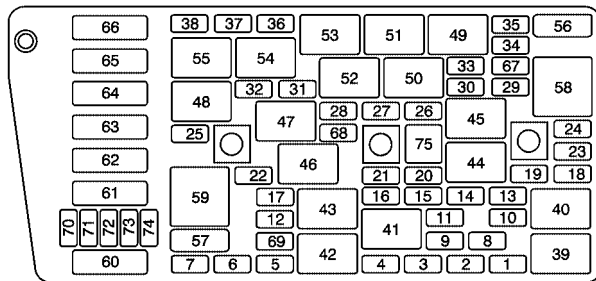

Fuses	Usage
1	Fuel Pump
2	Heater, Ventilation, Air Conditioning Blower
3	Memory Seat
4	Assembly Line Diagnostic Link
5	Not Used
6	Compact Disc (CD)
7	Driver Door Module
8	Supplemental Inflatable Restraint
9	Not Used
10	Lamps Park Right
11	Ventilation Solenoid
12	Ignition 1



<b>Fuses</b>	<b>Usage</b>
13	Lamps Park Left
14	Interior Lamp Dimmer Module
15	Satellite Digital Radio
16	Heated Seat Left Front
17	Not Used
18	Rear Door Modules
19	Stoplamps
20	PARK (P) / REVERSE (R)
21	Audio
22	Retained Accessory Power
23	Not Used
24	Not Used
25	Passenger Door Module
26	Body
27	Interior Lamps
28	Not Used
29	Ignition Switch
30	Instrument Panel
31	Heated Seat Right Front
32	Not Used
33	Heating, Ventilation, Air Conditioning
34	Ignition 3 Rear
35	Antilock Brake System

<b>Fuses</b>	<b>Usage</b>
36	Turn Signal/Hazard
37	HVAC Battery
38	Dash Integration Module

<b>Relays</b>	<b>Usage</b>
39	Fuel Pump
40	Parking Lamps
41	Ignition 1
42	Rear Fog Lamps
43	Not Used
44	Park Brake
45	Reverse Lamps
46	Retained Accessory Power
48	Not Used
49	Ignition 3
51	Interior Lamps
52	Trunk Release
53	Front Courtesy Lamps
54	Not Used
55	Electronic Level Control Compressor

<b>Circuit Breakers</b>	<b>Usage</b>
56	Power Seats
57	Power Windows

<b>Relays</b>	<b>Usage</b>
58	Not Used
59	Rear Defog

<b>Fuses</b>	<b>Usage</b>
60	Not Used
61	Rear Defog
62	Not Used
63	Audio Amplifier

<b>Fuses</b>	<b>Usage</b>
64	Electronic Level Control Compressor/Exhaust
65	Not Used
66	Not Used
67	Not Used
68	Not Used
69	Spare
70	Spare
71	Spare
72	Spare
73	Spare
74	Spare
75	Fuse Puller

## Removing the Rear Seat Cushion

**Notice:** If you touch the exposed wires with the metal on the seat cushion, you could cause a short that could damage the battery and or wires. Avoid contact between the rear seat and the fuse center whenever you remove or reinstall the rear seat. Do not remove covers from any of the covered parts, and do not store anything under the seats.

To remove the rear seat cushion, do the following:

1. Pull up on the front of the cushion to release the front hooks.
2. Pull the cushion up and out toward the front of the vehicle.

To reinstall the rear seat cushion, do the following:

### CAUTION:

A safety belt that is not properly routed through the seat cushion or is twisted will not provide the protection needed in a crash. If the safety belt has not been routed through the seat cushion at all, it will not be there to work for the next passenger. The person sitting in that position could be badly injured. After reinstalling the seat cushion, always check to be sure that the safety belts are properly routed and are not twisted.

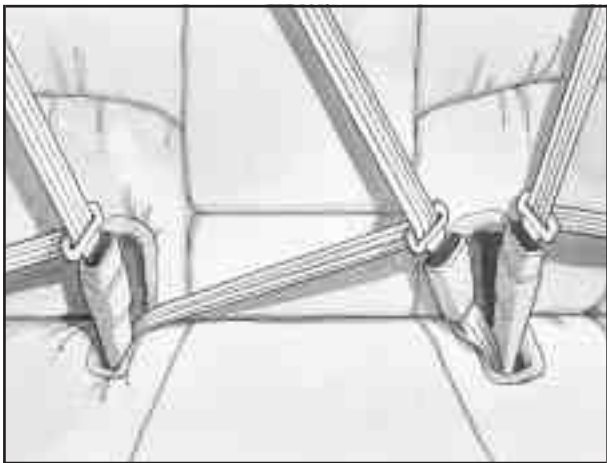

1. Buckle the center passenger position safety belt, then route the safety belts through the proper slots in the seat cushion. Do not let the safety belts get twisted.

2. Slide the rear of the cushion up and under the seatback so the rear locating guides hook into the wire loops on the back frame.
3. With the seat cushion lowered, push rearward and then press down on the seat cushion until the spring locks on both ends engage.
4. Check to make sure the safety belts are properly routed and that no portion of any safety belt is trapped under the seat. Also make sure the seat cushion is secured.

## Capacities and Specifications

The following approximate capacities are given in English and metric conversions. See *Part D: Recommended Fluids and Lubricants* on page 6-24 for more information.

Application	Capacities	
	English	Metric
Air Conditioning Refrigerant R134a	2.2 lbs	1.0 kg
<b>Automatic Transaxle</b> 3.8 L V6 4.6 L V8	7.4 quarts 15.0 quarts	7.0 L 14.2 L
<b>Engine Cooling System</b> 3.8 L V6 4.6 L V8	10.0 quarts 13.0 quarts	9.5 L 12.3 L
<b>Engine Oil with Filter</b> 3.8 L V6 4.6 L V8	4.5 quarts 7.5 quarts	4.3 L 7.1 L
Fuel Tank	18.5 gallons	70.0 L
Wheel Nut Torque	100 ft lb	140 N•m
All capacities are approximate. When adding, be sure to fill to the appropriate level, as recommended in this manual. Recheck fluid level after filling.		

### Engine Specifications

Engine	VIN Code	Transaxle	Spark Plug Gap
3.8 L 3800 V6 (L36)	K	Automatic	0.060 inches (1.52 mm)
4.6 L DOHC V8	Y	Automatic	0.050 inches (1.3 mm)

## Normal Maintenance Replacement Parts

Replacement parts identified below by name, part number, or specification can be obtained from your GM dealer.

Part	GM Part Number	ACDelco® Part Number
<b>Engine Air Cleaner/Filter</b> 3.8 L V6 4.6 L V8	25096932 25099149	A1096C A1208C
<b>Engine Oil Filter</b> 3.8 L V6 4.6 L V8	25010792 89017342	PF47 PF61
Fuel Filter (3.8L V6)	25121293	GF627
<b>Passenger Compartment Air Filter</b> 3.8 L V6 4.6 L V8	25654414 25689297	— —
<b>Spark Plugs</b> 3.8 L V6 4.6 L V8	12568387 12571535	41-101 41-987
Transaxle Filter (4.6 L V8)	24206433	—
Windshield Wiper Blades (Hook Type) 22 inches (56.0 cm)	12463075	—

# Section 6 Maintenance Schedule

---

<b>Maintenance Schedule</b> .....	6-2	At Least Twice a Year .....	6-20
Introduction .....	6-2	At Least Once a Year .....	6-20
Maintenance Requirements .....	6-2	Part C: Periodic Maintenance Inspections .....	6-23
Your Vehicle and the Environment .....	6-2	Steering, Suspension and Front Drive Axle	
How This Section is Organized .....	6-3	Boot and Seal Inspection .....	6-23
Part A: Scheduled Maintenance Services .....	6-4	Exhaust System Inspection .....	6-23
Using Your Maintenance Schedule .....	6-4	Fuel System Inspection .....	6-23
Selecting the Right Schedule .....	6-5	Engine Cooling System Inspection .....	6-23
Short Trip/City Scheduled Maintenance .....	6-6	Throttle System Inspection .....	6-24
Long Trip/Highway Scheduled Maintenance .....	6-13	Brake System Inspection .....	6-24
Part B: Owner Checks and Services .....	6-19	Part D: Recommended Fluids and Lubricants .....	6-25
At Each Fuel Fill .....	6-19	Part E: Maintenance Record .....	6-27
At Least Once a Month .....	6-19		

# Maintenance Schedule

## Introduction

**Important: Keep engine oil at the proper level and change as recommended.**



*Have you purchased the GM Protection Plan? The Plan supplements your new vehicle warranties. See your Warranty and Owner Assistance booklet or your dealer for details.*

# Maintenance Requirements

Maintenance intervals, checks, inspections and recommended fluids and lubricants as prescribed in this manual are necessary to keep your vehicle in good working condition. Any damage caused by failure to follow scheduled maintenance may not be covered by warranty.

## Your Vehicle and the Environment

Proper vehicle maintenance not only helps to keep your vehicle in good working condition, but also helps the environment. Improper vehicle maintenance can even affect the quality of the air we breathe. Improper fluid levels or the wrong tire inflation can increase the level of emissions from your vehicle. To help protect our environment, and to keep your vehicle in good condition, be sure to maintain your vehicle properly.



## How This Section is Organized

This maintenance schedule is divided into five parts:

**“Part A: Scheduled Maintenance Services”** explains what to have done and how often. Some of these services can be complex, so unless you are technically qualified and have the necessary equipment, you should let your GM dealer’s service department do these jobs.

Your GM dealer has GM-trained and supported service people that will perform the work using genuine GM parts.

### **CAUTION:**

**Performing maintenance work on a vehicle can be dangerous. In trying to do some jobs, you can be seriously injured. Do your own maintenance work only if you have the required know-how and the proper tools and equipment for the job. If you have any doubt, have a qualified technician do the work.**

If you want to purchase service information, see *Service Publications Ordering Information* on page 7-11.

**“Part B: Owner Checks and Services”** tells you what should be checked and when. It also explains what you can easily do to help keep your vehicle in good condition.

**“Part C: Periodic Maintenance Inspections”** explains important inspections that your dealer’s service department can perform for you.

**“Part D: Recommended Fluids and Lubricants”** lists some recommended products necessary to help keep your vehicle properly maintained. These products, or their equivalents, should be used whether you do the work yourself or have it done.

**“Part E: Maintenance Record”** is a place for you to record and keep track of the maintenance performed on your vehicle. Keep your maintenance receipts. They may be needed to qualify your vehicle for warranty repairs.

## Part A: Scheduled Maintenance Services

In this part are scheduled maintenance services which are to be performed at the mileage intervals specified.

### Using Your Maintenance Schedule

We at General Motors want to keep your vehicle in good working condition. But we do not know exactly how you will drive it. You may drive short distances only a few times a week. Or you may drive long distances all the time in very hot, dusty weather. You may use your vehicle in making deliveries. Or you may drive it to work, to do errands or in many other ways.

Because of the different ways people use their vehicles, maintenance needs may vary. You may need more frequent checks and replacements. So please read the following and note how you drive. If you have questions on how to keep your vehicle in good condition, see your dealer.

This part tells you the maintenance services you should have done and when to schedule them.

When you go to your dealer for your service needs, you will know that GM-trained and supported service people will perform the work using genuine GM parts.

The proper fluids and lubricants to use are listed in Part D. Make sure whoever services your vehicle uses these. All parts should be replaced and all necessary repairs done before you or anyone else drives the vehicle.

These schedules are for vehicles that:

- carry passengers and cargo within recommended limits. You will find these on the tire and loading information label. See *Loading Your Vehicle on page 4-29*.
- are driven on reasonable road surfaces within legal driving limits.
- use the recommended fuel. See *Gasoline Octane on page 5-5*.

## Selecting the Right Schedule

First you will need to decide which of the two schedules is right for your vehicle. Here is how to decide which schedule to follow:

### Short Trip/City Definition

Follow the Short Trip/City Scheduled Maintenance if any one of these conditions is true for your vehicle:

- Most trips are less than 5 miles (8 km). This is particularly important when outside temperatures are below freezing.
- Most trips include extensive idling (such as frequent driving in stop-and-go traffic).
- You frequently tow a trailer or use a carrier on top of your vehicle.
- If the vehicle is used for delivery service, police, taxi or other commercial application.

*One of the reasons you should follow this schedule if you operate your vehicle under any of these conditions is that these conditions cause engine oil to break down sooner.*

## Short Trip/City Intervals

**Every 3,000 Miles (5 000 km):** Engine Oil and Filter Change (or 3 months, whichever occurs first).

**Every 6,000 Miles (10 000 km):** Tire Rotation.

**Every 15,000 Miles (25 000 km):** Engine Air Cleaner Filter Inspection.

**Every 30,000 Miles (50 000 km):** Throttle Body Bore and Valve Plates Inspection (V8 engine only).

**Every 45,000 Miles (75 000 km):** Engine Air Cleaner Filter Replacement.

**Every 50,000 Miles (83 000 km):** Automatic Transaxle Service (severe conditions only).

**Every 100,000 Miles (166 000 km):** Spark Plug Wire Inspection (V6 engine only). Spark Plug Replacement. Automatic Transaxle Service (normal conditions).

**Every 150 000 Miles (240 000 km):** Cooling System Service (or every 60 months, whichever occurs first). Engine Accessory Drive Belt Inspection.

*These intervals only summarize maintenance services. Be sure to follow the complete scheduled maintenance on the following pages.*

## Long Trip/Highway Definition

Follow this scheduled maintenance *only* if none of the conditions from the Short Trip/City Scheduled Maintenance are true. Do not use this schedule if the vehicle is used for trailer towing, driven in a dusty area or used off paved roads. Use the Short Trip/City schedule for these conditions

*Driving a vehicle with a fully warmed engine under highway conditions will cause engine oil to break down slower.*

## Long Trip/Highway Intervals

**Every 7,500 Miles (12 500 km):** Engine Oil and Filter Change (or every 12 months, whichever occurs first). Tire Rotation.

**Every 15,000 Miles (25 000 km):** Engine Air Cleaner Filter Inspection.

**Every 30,000 Miles (50 000 km):** Throttle Body Bore and Valve Plates Inspection (V8 engine only).

**Every 45,000 Miles (75 000 km):** Engine Air Cleaner Filter Replacement.

**Every 50,000 Miles (83 000 km):** Automatic Transaxle Service (severe conditions only).

**Every 100,000 Miles (166 000 km):** Spark Plug Wire Inspection (V6 engine only). Spark Plug Replacement. Automatic Transaxle Service (normal conditions).

**Every 150,000 Miles (240 000 km):** Cooling System Service (or every 60 months, whichever occurs first). Engine Accessory Drive Belt Inspection.

*These intervals only summarize maintenance services. Be sure to follow the complete scheduled maintenance on the following pages.*

## Short Trip/City Scheduled Maintenance

The services shown in this schedule up to 100,000 miles (166 000 km) should be repeated after 100,000 miles (166 000 km) at the same intervals for the life of this vehicle. The services shown at 150,000 miles (240 000 km) should be repeated at the same interval after 150,000 miles (240 000 km) for the life of this vehicle.

See *Part B: Owner Checks and Services on page 6-19* and *Part C: Periodic Maintenance Inspections on page 6-23*.

## Footnotes

† The U.S. Environmental Protection Agency or the California Air Resources Board has determined that the failure to perform this maintenance item will not nullify the emission warranty or limit recall liability prior to the completion of the vehicle's useful life. We, however, urge that all recommended maintenance services be performed at the indicated intervals and the maintenance be recorded.

\* If your vehicle has the GM Oil Life System, a computer system lets you know when to change the oil and filter. This is based on engine revolutions and engine temperature and not on mileage. Based on driving conditions, the mileage at which an oil change will be indicated can vary considerably. For the oil life system to work properly, you must reset the system every time the oil is changed.

When the system has calculated that oil life has been diminished, it will indicate that an oil change is necessary. An ENGINE OIL CHANGE SOON message will come on. Change your oil as soon as possible within the next two times you stop for fuel. See Engine Oil on page 5-16. It is possible that, if you are driving under the best conditions, the oil life system may not indicate that an oil change is necessary for over a year. However, your engine oil and filter must be

changed at least once a year and at this time the system must be reset. It is also important to check your oil regularly and keep it at the proper level.

If the system is ever reset accidentally, you must change your oil at 3,000 miles (5 000 km) since your last oil change. Remember to reset the oil life system whenever the oil is changed. See Engine Oil Life System on page 5-20 for information on resetting the system.

@ Whenever the tires are rotated, the Check Tire Pressure System must be reset.

+ A good time to check your brakes is during tire rotation. See Brake System Inspection on page 6-24.

### 3,000 Miles (5 000 km)

- ❑ Change engine oil and filter (or every 3 months, whichever occurs first). An Emission Control Service. (See footnote \*.)

### 6,000 Miles (10 000 km)

- ❑ Change engine oil and filter (or every 3 months, whichever occurs first). An Emission Control Service. (See footnote \*.)
- ❑ Rotate tires. See *Tire Inspection and Rotation* on page 5-85 for proper rotation pattern and additional information. (See footnote @.) (See footnote +.)

## 9,000 Miles (15 000 km)

- ❑ Change engine oil and filter (or every 3 months, whichever occurs first). *An Emission Control Service.* (See footnote \*.)

## 12,000 Miles (20 000 km)

- ❑ Change engine oil and filter (or every 3 months, whichever occurs first). *An Emission Control Service.* (See footnote \*.)
- ❑ Rotate tires. See *Tire Inspection and Rotation* on page 5-85 for proper rotation pattern and additional information. (See footnote @.) (See footnote +.)

## 15,000 Miles (25 000 km)

- ❑ Change engine oil and filter (or every 3 months, whichever occurs first). *An Emission Control Service.* (See footnote \*.)
- ❑ Inspect engine air cleaner filter. If necessary, replace the filter. If vehicle is driven in dusty/dirty conditions, inspect filter at every engine oil change. See *Engine Air Cleaner/Filter (3.8L V6 Engine)* on page 5-22 or *Engine Air Cleaner/Filter (4.6L V8 Engine)* on page 5-23 for more information. *An Emission Control Service.* (See footnote †.)

## 18,000 Miles (30 000 km)

- ❑ Change engine oil and filter (or every 3 months, whichever occurs first). *An Emission Control Service.* (See footnote \*.)
- ❑ Rotate tires. See *Tire Inspection and Rotation* on page 5-85 for proper rotation pattern and additional information. (See footnote @.) (See footnote +.)

## 21,000 Miles (35 000 km)

- ❑ Change engine oil and filter (or every 3 months, whichever occurs first). *An Emission Control Service.* (See footnote \*.)

## 24,000 Miles (40 000 km)

- ❑ Change engine oil and filter (or every 3 months, whichever occurs first). *An Emission Control Service.* (See footnote \*.)
- ❑ Rotate tires. See *Tire Inspection and Rotation* on page 5-85 for proper rotation pattern and additional information. (See footnote @.) (See footnote +.)

## 27,000 Miles (45 000 km)

- ❑ Change engine oil and filter (or every 3 months, whichever occurs first). *An Emission Control Service.* (See footnote \*.)

### **30,000 Miles (50 000 km)**

- ❑ Change engine oil and filter (or every 3 months, whichever occurs first). *An Emission Control Service.* (See footnote \*.)
- ❑ Inspect engine air cleaner filter. If necessary, replace the filter. If vehicle is driven in dusty/dirty conditions, inspect filter at every engine oil change. See *Engine Air Cleaner/Filter (3.8L V6 Engine)* on page 5-22 or *Engine Air Cleaner/Filter (4.6L V8 Engine)* on page 5-23 for more information. *An Emission Control Service.* (See footnote †.)
- ❑ V8 engine only: Inspect throttle body bore and valve plates for deposits, open the throttle valve and inspect all surfaces. Clean as required. *An Emission Control Service.* (See footnote †.)
- ❑ Rotate tires. See *Tire Inspection and Rotation* on page 5-85 for proper rotation pattern and additional information. (See footnote @.) (See footnote +.)

### **33,000 Miles (55 000 km)**

- ❑ Change engine oil and filter (or every 3 months, whichever occurs first). *An Emission Control Service.* (See footnote \*.)

### **36,000 Miles (60 000 km)**

- ❑ Change engine oil and filter (or every 3 months, whichever occurs first). *An Emission Control Service.* (See footnote \*.)
- ❑ Rotate tires. See *Tire Inspection and Rotation* on page 5-85 for proper rotation pattern and additional information. (See footnote @.) (See footnote +.)

### **39,000 Miles (65 000 km)**

- ❑ Change engine oil and filter (or every 3 months, whichever occurs first). *An Emission Control Service.* (See footnote \*.)

### **42,000 Miles (70 000 km)**

- ❑ Change engine oil and filter (or every 3 months, whichever occurs first). *An Emission Control Service.* (See footnote \*.)
- ❑ Rotate tires. See *Tire Inspection and Rotation* on page 5-85 for proper rotation pattern and additional information. (See footnote @.) (See footnote +.)

## 45,000 Miles (75 000 km)

- ❑ Change engine oil and filter (or every 3 months, whichever occurs first). *An Emission Control Service.* (See footnote \*.)
- ❑ Replace engine air cleaner filter. See *Engine Air Cleaner/Filter (3.8L V6 Engine)* on page 5-22 or *Engine Air Cleaner/Filter (4.6L V8 Engine)* on page 5-23 for more information. *An Emission Control Service.*

## 48,000 Miles (80 000 km)

- ❑ Change engine oil and filter (or every 3 months, whichever occurs first). *An Emission Control Service.* (See footnote \*.)
- ❑ Rotate tires. See *Tire Inspection and Rotation* on page 5-85 for proper rotation pattern and additional information. (See footnote @.) (See footnote +.)

## 50,000 Miles (83 000 km)

- ❑ Change automatic transaxle fluid and filter if the vehicle is mainly driven under one or more of these conditions:
  - In heavy city traffic where the outside temperature regularly reaches 90°F (32°C) or higher.
  - In hilly or mountainous terrain.

- When doing frequent trailer towing.
- Uses such as found in taxi, police or delivery service.

*If you do not use your vehicle under any of these conditions, change the fluid and filter at 100,000 miles (166 000 km).*

## 51,000 Miles (85 000 km)

- ❑ Change engine oil and filter (or every 3 months, whichever occurs first). *An Emission Control Service.* (See footnote \*.)

## 54,000 Miles (90 000 km)

- ❑ Change engine oil and filter (or every 3 months, whichever occurs first). *An Emission Control Service.* (See footnote \*.)
- ❑ Rotate tires. See *Tire Inspection and Rotation* on page 5-85 for proper rotation pattern and additional information. (See footnote @.) (See footnote +.)

## 57,000 Miles (95 000 km)

- ❑ Change engine oil and filter (or every 3 months, whichever occurs first). *An Emission Control Service.* (See footnote \*.)



## 60,000 Miles (100 000 km)

- ❑ Change engine oil and filter (or every 3 months, whichever occurs first). *An Emission Control Service.* (See footnote \*.)
- ❑ Inspect engine air cleaner filter. If necessary, replace the filter. If vehicle is driven in dusty/dirty conditions, inspect filter at every engine oil change. See *Engine Air Cleaner/Filter (3.8L V6 Engine)* on page 5-22 or *Engine Air Cleaner/Filter (4.6L V8 Engine)* on page 5-23 for more information. *An Emission Control Service.* (See footnote †.)
- ❑ V8 engine only: Inspect throttle body bore and valve plates for deposits, open the throttle valve and inspect all surfaces. Clean as required. *An Emission Control Service.* (See footnote †.)
- ❑ Rotate tires. See *Tire Inspection and Rotation* on page 5-85 for proper rotation pattern and additional information. (See footnote @.) (See footnote +.)

## 63,000 Miles (105 000 km)

- ❑ Change engine oil and filter (or every 3 months, whichever occurs first). *An Emission Control Service.* (See footnote \*.)

## 66,000 Miles (110 000 km)

- ❑ Change engine oil and filter (or every 3 months, whichever occurs first). *An Emission Control Service.* (See footnote \*.)

- ❑ Rotate tires. See *Tire Inspection and Rotation* on page 5-85 for proper rotation pattern and additional information. (See footnote @.) (See footnote +.)

## 69,000 Miles (115 000 km)

- ❑ Change engine oil and filter (or every 3 months, whichever occurs first). *An Emission Control Service.* (See footnote \*.)

## 72,000 Miles (120 000 km)

- ❑ Change engine oil and filter (or every 3 months, whichever occurs first). *An Emission Control Service.* (See footnote \*.)
- ❑ Rotate tires. See *Tire Inspection and Rotation* on page 5-85 for proper rotation pattern and additional information. (See footnote @.) (See footnote +.)

## 75,000 Miles (125 000 km)

- ❑ Change engine oil and filter (or every 3 months, whichever occurs first). *An Emission Control Service.* (See footnote \*.)
- ❑ Inspect engine air cleaner filter. If necessary, replace the filter. If vehicle is driven in dusty/dirty conditions, inspect filter at every engine oil change. See *Engine Air Cleaner/Filter (3.8L V6 Engine)* on page 5-22 or *Engine Air Cleaner/Filter (4.6L V8 Engine)* on page 5-23 for more information. *An Emission Control Service.* (See footnote †.)

## 78,000 Miles (130 000 km)

- ❑ Change engine oil and filter (or every 3 months, whichever occurs first). *An Emission Control Service* (See footnote \*.)
- ❑ Rotate tires. See *Tire Inspection and Rotation* on page 5-85 for proper rotation pattern and additional information. (See footnote @.) (See footnote +.)

## 81,000 Miles (135 000 km)

- ❑ Change engine oil and filter (or every 3 months, whichever occurs first). *An Emission Control Service*. (See footnote \*.)

## 84,000 Miles (140 000 km)

- ❑ Change engine oil and filter (or every 3 months, whichever occurs first). *An Emission Control Service*. (See footnote \*.)
- ❑ Rotate tires. See *Tire Inspection and Rotation* on page 5-85 for proper rotation pattern and additional information. (See footnote @.) (See footnote +.)

## 87,000 Miles (145 000 km)

- ❑ Change engine oil and filter (or every 3 months, whichever occurs first). *An Emission Control Service*. (See footnote \*.)

## 90,000 Miles (150 000 km)

- ❑ Change engine oil and filter (or every 3 months, whichever occurs first). *An Emission Control Service*. (See footnote \*.)
- ❑ Replace engine air cleaner filter. See *Engine Air Cleaner/Filter (3.8L V6 Engine)* on page 5-22 or *Engine Air Cleaner/Filter (4.6L V8 Engine)* on page 5-23 for more information. *An Emission Control Service*.
- ❑ V8 engine only: Inspect throttle body bore and valve plates for deposits, open the throttle valve and inspect all surfaces. Clean as required. *An Emission Control Service*. (See footnote †.)
- ❑ Rotate tires. See *Tire Inspection and Rotation* on page 5-85 for proper rotation pattern and additional information. (See footnote @.) (See footnote +.)

## 93,000 Miles (155 000 km)

- ❑ Change engine oil and filter (or every 3 months, whichever occurs first). *An Emission Control Service*. (See footnote \*.)

## 96,000 Miles (160 000 km)

- ❑ Change engine oil and filter (or every 3 months, whichever occurs first). *An Emission Control Service*. (See footnote \*.)

- ❑ Rotate tires. See *Tire Inspection and Rotation* on page 5-85 for proper rotation pattern and additional information. (See footnote @.) (See footnote +.)

### **99,000 Miles (165 000 km)**

- ❑ Change engine oil and filter (or every 3 months, whichever occurs first). *An Emission Control Service.* (See footnote \*.)

### **100,000 Miles (166 000 km)**

- ❑ V6 engine only: Inspect spark plug wires. *An Emission Control Service.*
- ❑ Replace spark plugs. *An Emission Control Service.*
- ❑ Change automatic transaxle fluid and filter if the vehicle is mainly driven under one or more of these conditions:
  - In heavy city traffic where the outside temperature regularly reaches 90°F (32°C) or higher.
  - In hilly or mountainous terrain.
  - When doing frequent trailer towing.
  - Uses such as found in taxi, police or delivery service.

*If you have not used your vehicle under severe service conditions listed previously and, therefore, have not changed your automatic transaxle fluid, change both the fluid and filter.*

### **150,000 Miles (240 000 km)**

- ❑ Drain, flush and refill cooling system (or every 60 months since last service, whichever occurs first). See *Engine Coolant (3.8L V6 Engine)* on page 5-31 or *Engine Coolant (4.6L V8 Engine)* on page 5-34 for what to use. Inspect hoses. Clean radiator, condenser, pressure cap and neck. Pressure test the cooling system and pressure cap. *An Emission Control Service.*
- ❑ Inspect engine accessory drive belt. *An Emission Control Service.*

## **Long Trip/Highway Scheduled Maintenance**

The services shown in this schedule up to 100,000 miles (166 000 km) should be repeated after 100,000 miles (166 000 km) at the same intervals for the life of this vehicle. The services shown at 150,000 miles (240 000 km) should be repeated at the same interval after 150,000 miles (240 000 km) for the life of this vehicle.

*See Part B: Owner Checks and Services on page 6-19 and Part C: Periodic Maintenance Inspections on page 6-23.*

## Footnotes

† The U.S. Environmental Protection Agency or the California Air Resources Board has determined that the failure to perform this maintenance item will not nullify the emission warranty or limit recall liability prior to the completion of the vehicle's useful life. We, however, urge that all recommended maintenance services be performed at the indicated intervals and the maintenance be recorded.

\* If your vehicle has the GM Oil Life System, a computer system lets you know when to change the engine oil and filter. This is based on engine revolutions and engine temperature, and not on mileage. Based on driving conditions, the mileage at which an oil change will be indicated can vary considerably. For the oil life system to work properly, you must reset the system every time the oil is changed.

When the system has calculated that oil life has been diminished, it will indicate that an oil change is necessary. An ENGINE OIL CHANGE SOON message will come on. Change your oil as soon as possible within the next two times you stop for fuel. See Engine Oil on page 5-16. It is possible that, if you are driving under the best conditions, the oil life system may not indicate that an oil change is necessary for over a year. However, your engine oil and filter must be

changed at least once a year and at this time the system must be reset. It is also important to check your oil regularly and keep it at the proper level.

If the system is ever reset accidentally, you must change your oil at 3,000 miles (5 000 km) since your last oil change. Remember to reset the oil life system whenever the oil is changed. See Engine Oil Life System on page 5-20 for information on resetting the system.

@ Whenever the tires are rotated, the Check Tire Pressure System must be reset.

+ A good time to check your brakes is during tire rotation. See Brake System Inspection on page 6-24.

## 7,500 Miles (12 500 km)

- Change engine oil and filter (or every 12 months, whichever occurs first). An Emission Control Service. (See footnote \*.)
- Rotate tires. See *Tire Inspection and Rotation* on page 5-85 for proper rotation pattern and additional information. (See footnote @.) (See footnote +.)

## 15,000 Miles (25 000 km)

- ❑ Change engine oil and filter (or every 12 months, whichever occurs first). *An Emission Control Service.* (See footnote \*.)
- ❑ Inspect engine air cleaner filter. If necessary, replace the filter. If vehicle is driven in dusty/dirty conditions, inspect filter at every engine oil change. See *Engine Air Cleaner/Filter (3.8L V6 Engine)* on page 5-22 or *Engine Air Cleaner/Filter (4.6L V8 Engine)* on page 5-23 for more information. *An Emission Control Service.* (See footnote †.)
- ❑ Rotate tires. See *Tire Inspection and Rotation* on page 5-85 for proper rotation pattern and additional information. (See footnote @.) (See footnote +.)

## 22,500 Miles (37 500 km)

- ❑ Change engine oil and filter (or every 12 months, whichever occurs first). *An Emission Control Service.* (See footnote \*.)
- ❑ Rotate tires. See *Tire Inspection and Rotation* on page 5-85 for proper rotation pattern and additional information. (See footnote @.) (See footnote +.)

## 30,000 Miles (50 000 km)

- ❑ Change engine oil and filter (or every 12 months, whichever occurs first). *An Emission Control Service.* (See footnote \*.)
- ❑ Inspect engine air cleaner filter. If necessary, replace the filter. If vehicle is driven in dusty/dirty conditions, inspect filter at every engine oil change. See *Engine Air Cleaner/Filter (3.8L V6 Engine)* on page 5-22 or *Engine Air Cleaner/Filter (4.6L V8 Engine)* on page 5-23 for more information. *An Emission Control Service.* (See footnote †.)
- ❑ V8 engine only: Inspect throttle body bore and valve plates for deposits, open the throttle valve and inspect all surfaces. Clean as required. *An Emission Control Service.* (See footnote †.)
- ❑ Rotate tires. See *Tire Inspection and Rotation* on page 5-85 for proper rotation pattern and additional information. (See footnote @.) (See footnote +.)

## 37,500 Miles (62 500 km)

- ❑ Change engine oil and filter (or every 12 months, whichever occurs first). *An Emission Control Service.* (See footnote \*.)
- ❑ Rotate tires. See *Tire Inspection and Rotation* on page 5-85 for proper rotation pattern and additional information. (See footnote @.) (See footnote +.)

## 45,000 Miles (75 000 km)

- ❑ Change engine oil and filter (or every 12 months, whichever occurs first). *An Emission Control Service.* (See footnote \*.)
- ❑ Replace engine air cleaner filter. See *Engine Air Cleaner/Filter (3.8L V6 Engine)* on page 5-22 or *Engine Air Cleaner/Filter (4.6L V8 Engine)* on page 5-23 for more information. *An Emission Control Service.*
- ❑ Rotate tires. See *Tire Inspection and Rotation* on page 5-85 for proper rotation pattern and additional information. (See footnote @.) (See footnote +.)

## 50,000 Miles (83 000 km)

- ❑ Change automatic transaxle fluid and filter if the vehicle is mainly driven under one or more of these conditions:
  - In heavy city traffic where the outside temperature regularly reaches 90°F (32°C) or higher.
  - In hilly or mountainous terrain.
  - When doing frequent trailer towing.
  - Uses such as found in taxi, police or delivery service.

If you do not use your vehicle under any of these conditions, change the fluid and filter at 100,000 miles (166 000 km).

## 52,500 Miles (87 500 km)

- ❑ Change engine oil and filter (or every 12 months, whichever occurs first). *An Emission Control Service.* (See footnote \*.)
- ❑ Rotate tires. See *Tire Inspection and Rotation* on page 5-85 for proper rotation pattern and additional information. (See footnote @.) (See footnote +.)

## 60,000 Miles (100 000 km)

- ❑ Change engine oil and filter (or every 12 months, whichever occurs first). *An Emission Control Service.* (See footnote \*.)
- ❑ Inspect engine air cleaner filter. If necessary, replace the filter. If vehicle is driven in dusty/dirty conditions, inspect filter at every engine oil change. See *Engine Air Cleaner/Filter (3.8L V6 Engine)* on page 5-22 or *Engine Air Cleaner/Filter (4.6L V8 Engine)* on page 5-23 for more information. *An Emission Control Service.* (See footnote †.)
- ❑ V8 engine only: Inspect throttle body bore and valve plates for deposits, open the throttle valve and inspect all surfaces. Clean as required. *An Emission Control Service.* (See footnote †.)
- ❑ Rotate tires. See *Tire Inspection and Rotation* on page 5-85 for proper rotation pattern and additional information. (See footnote @.) (See footnote +.)

## 67,500 Miles (112 500 km)

- ❑ Change engine oil and filter (or every 12 months, whichever occurs first). *An Emission Control Service.* (See footnote \*.)
- ❑ Rotate tires. See *Tire Inspection and Rotation* on page 5-85 for proper rotation pattern and additional information. (See footnote @.) (See footnote +.)

## 75,000 Miles (125 000 km)

- ❑ Change engine oil and filter (or every 12 months, whichever occurs first). *An Emission Control Service.* (See footnote \*.)
- ❑ Inspect engine air cleaner filter. If necessary, replace the filter. If vehicle is driven in dusty/dirty conditions, inspect filter at every engine oil change. See *Engine Air Cleaner/Filter (3.8L V6 Engine)* on page 5-22 or *Engine Air Cleaner/Filter (4.6L V8 Engine)* on page 5-23 for more information. *An Emission Control Service.* (See footnote †.)
- ❑ Rotate tires. See *Tire Inspection and Rotation* on page 5-85 for proper rotation pattern and additional information. (See footnote @.) (See footnote +.)

## 82,500 Miles (137 500 km)

- ❑ Change engine oil and filter (or every 12 months, whichever occurs first). *An Emission Control Service.* (See footnote \*.)
- ❑ Rotate tires. See *Tire Inspection and Rotation* on page 5-85 for proper rotation pattern and additional information. (See footnote @.) (See footnote +.)

## 90,000 Miles (150 000 km)

- ❑ Change engine oil and filter (or every 12 months, whichever occurs first). *An Emission Control Service.* (See footnote \*.)
- ❑ Replace engine air cleaner filter. See *Engine Air Cleaner/Filter (3.8L V6 Engine)* on page 5-22 or *Engine Air Cleaner/Filter (4.6L V8 Engine)* on page 5-23 for more information. *An Emission Control Service.*
- ❑ V8 engine only: Inspect throttle body bore and valve plates for deposits, open the throttle valve and inspect all surfaces. Clean as required. *An Emission Control Service.* (See footnote †.)
- ❑ Rotate tires. See *Tire Inspection and Rotation* on page 5-85 for proper rotation pattern and additional information. (See footnote @.) (See footnote +.)

## 97,500 Miles (162 500 km)

- ❑ Change engine oil and filter (or every 12 months, whichever occurs first). *An Emission Control Service.* (See footnote \*.)
- ❑ Rotate tires. See *Tire Inspection and Rotation* on page 5-85 for proper rotation pattern and additional information. (See footnote @.) (See footnote +.)

## 100,000 Miles (166 000 km)

- ❑ V6 engine only: Inspect spark plug wires. *An Emission Control Service.*
- ❑ Replace spark plugs. *An Emission Control Service.*
- ❑ Change automatic transaxle fluid and filter if the vehicle is mainly driven under one or more of these conditions:
  - In heavy city traffic where the outside temperature regularly reaches 90°F (32°C) or higher.
  - In hilly or mountainous terrain.

- When doing frequent trailer towing.
- Uses such as found in taxi, police or delivery service.

- ❑ If you have not used your vehicle under severe service conditions listed previously and, therefore, have not changed your automatic transaxle fluid, change both the fluid and filter.

## 150,000 Miles (240 000 km)

- ❑ Drain, flush and refill cooling system (or every 60 months since last service, whichever occurs first). See *Engine Coolant (3.8L V6 Engine)* on page 5-31 or *Engine Coolant (4.6L V8 Engine)* on page 5-34 for what to use. Inspect hoses. Clean radiator, condenser, pressure cap and neck. Pressure test the cooling system and pressure cap. *An Emission Control Service.*
- ❑ Inspect engine accessory drive belt. *An Emission Control Service.*



## Part B: Owner Checks and Services

Listed in this part are owner checks and services which should be performed at the intervals specified to help ensure the safety, dependability and emission control performance of your vehicle.

Be sure any necessary repairs are completed at once. Whenever any fluids or lubricants are added to your vehicle, make sure they are the proper ones, as shown in Part D.

### At Each Fuel Fill

*It is important for you or a service station attendant to perform these underhood checks at each fuel fill.*

### Engine Oil Level Check

Check the engine oil level and add the proper oil if necessary. See *Engine Oil* on page 5-16 for further details.

### Engine Coolant Level Check

Check the engine coolant level and add DEX-COOL<sup>®</sup> coolant mixture if necessary. See *Engine Coolant (3.8L V6 Engine)* on page 5-31 or *Engine Coolant (4.6L V8 Engine)* on page 5-34 for further details.

### Windshield Washer Fluid Level Check

Check the windshield washer fluid level in the windshield washer tank and add the proper fluid if necessary. See *Windshield Washer Fluid* on page 5-53 for further details.

### At Least Once a Month

#### Tire Inflation Check

Visually inspect your tires and make sure tires are inflated to the correct pressures. Do not forget to check your spare tire. See *Tires* on page 5-74 for further details.

#### Cassette Tape Player Service

Clean cassette tape player. Cleaning should be done every 50 hours of tape play. See *Audio System(s)* on page 3-72 for further details.

## At Least Twice a Year

### Restraint System Check

Make sure the safety belt reminder light and all your belts, buckles, latch plates, retractors and anchorages are working properly. Look for any other loose or damaged safety belt system parts. If you see anything that might keep a safety belt system from doing its job, have it repaired. Have any torn or frayed safety belts replaced.

Also look for any opened or broken airbag coverings, and have them repaired or replaced. (The airbag system does not need regular maintenance.)

### Wiper Blade Check

Inspect wiper blades for wear or cracking. Replace blade inserts that appear worn or damaged or that streak or miss areas of the windshield. Also see *Windshield and Wiper Blades on page 5-106*.

### Weatherstrip Lubrication

Silicone grease on weatherstrips will make them last longer, seal better, and not stick or squeak. Apply silicone grease with a clean cloth. During very cold, damp weather more frequent application may be required. See *Part D: Recommended Fluids and Lubricants on page 6-25*.

## Automatic Transaxle Check

Check the transaxle fluid level; add if needed. See *Automatic Transaxle Fluid (3.8L V6 Engine) on page 5-25* or *Automatic Transaxle Fluid (4.6L V8 Engine) on page 5-28*. A fluid loss may indicate a problem. Check the system and repair if needed.

## At Least Once a Year

### Key Lock Cylinders Service

Lubricate the key lock cylinders with the lubricant specified in Part D.

### Body Lubrication Service

Lubricate all hinges and latches, including those for the hood, rear compartment, glove box door, console door and any folding seat hardware. Part D tells you what to use. More frequent lubrication may be required when exposed to a corrosive environment.

## Starter Switch Check

### CAUTION:

When you are doing this inspection, the vehicle could move suddenly. If the vehicle moves, you or others could be injured.

1. Before you start, be sure you have enough room around the vehicle.
2. Firmly apply both the parking brake and the regular brake. See *Parking Brake* on page 2-30 if necessary.  
Do not use the accelerator pedal, and be ready to turn off the engine immediately if it starts.
3. Try to start the engine in each gear. The starter should work only in PARK (P) or NEUTRAL (N). If the starter works in any other position, your vehicle needs service.

## Automatic Transaxle Shift Lock Control System Check

### CAUTION:

When you are doing this inspection, the vehicle could move suddenly. If the vehicle moves, you or others could be injured.

1. Before you start, be sure you have enough room around the vehicle. It should be parked on a level surface.
2. Firmly apply the parking brake. See *Parking Brake* on page 2-30 if necessary.  
Be ready to apply the regular brake immediately if the vehicle begins to move.
3. With the engine off, turn the ignition to ON, but do not start the engine. Without applying the regular brake, try to move the shift lever out of PARK (P) with normal effort. If the shift lever moves out of PARK (P), your vehicle needs service.

## Ignition Transaxle Lock Check

While parked, and with the parking brake set, try to turn the ignition to OFF in each shift lever position.

- The ignition should turn to OFF only when the shift lever is in PARK (P).
- The key should come out only in OFF.

## Parking Brake and Automatic Transaxle Park (P) Mechanism Check

### CAUTION:

**When you are doing this check, your vehicle could begin to move. You or others could be injured and property could be damaged. Make sure there is room in front of your vehicle in case it begins to roll. Be ready to apply the regular brake at once should the vehicle begin to move.**

Park on a fairly steep hill, with the vehicle facing downhill. Keeping your foot on the regular brake, set the parking brake.

- To check the parking brake's holding ability: With the engine running and transaxle in NEUTRAL (N), slowly remove foot pressure from the regular brake pedal. Do this until the vehicle is held by the parking brake only.
- To check the PARK (P) mechanism's holding ability: With the engine running, shift to PARK (P). Then release the parking brake followed by the regular brake.

## Underbody Flushing Service

At least every spring, use plain water to flush any corrosive materials from the underbody. Take care to clean thoroughly any areas where mud and other debris can collect.

## **Part C: Periodic Maintenance Inspections**

Listed in this part are inspections and services which should be performed at least twice a year (for instance, each spring and fall). *You should let your dealer's service department do these jobs. Make sure any necessary repairs are completed at once.*

Proper procedures to perform these services may be found in a service manual. See *Service Publications Ordering Information on page 7-11.*

### **Steering, Suspension and Front Drive Axle Boot and Seal Inspection**

Inspect the front and rear suspension and steering system for damaged, loose or missing parts, signs of wear or lack of lubrication. Inspect the power steering lines and hoses for proper hook-up, binding, leaks, cracks, chafing, etc. Clean and then inspect the drive axle boot seals for damage, tears or leakage. Replace seals if necessary.

### **Exhaust System Inspection**

Inspect the complete exhaust system. Inspect the body near the exhaust system. Look for broken, damaged, missing or out-of-position parts as well as open seams, holes, loose connections or other conditions which could cause a heat build-up in the floor pan or could let exhaust fumes into the vehicle. See *Engine Exhaust on page 2-34.*

### **Fuel System Inspection**

Inspect the complete fuel system for damage or leaks.

### **Engine Cooling System Inspection**

Inspect the hoses and have them replaced if they are cracked, swollen or deteriorated. Inspect all pipes, fittings and clamps; replace as needed. Clean the outside of the radiator and air conditioning condenser. To help ensure proper operation, a pressure test of the cooling system and pressure cap is recommended at least once a year.

## Throttle System Inspection

Inspect the throttle system for interference or binding, and for damaged or missing parts. Replace parts as needed. Replace any components that have high effort or excessive wear. Do not lubricate accelerator and cruise control cables.

## Brake System Inspection

Inspect the complete system. Inspect brake lines and hoses for proper hook-up, binding, leaks, cracks, chafing, etc. Inspect disc brake pads for wear and rotors for surface condition. Inspect other brake parts, including calipers, parking brake, etc. You may need to have your brakes inspected more often if your driving habits or conditions result in frequent braking.

## Part D: Recommended Fluids and Lubricants

Fluids and lubricants identified below by name, part number or specification may be obtained from your dealer.

Usage	Fluid/Lubricant
Engine Oil	Engine oil which meets GM Standard GM6094M and displays the American Petroleum Institute Certified for Gasoline Engines starburst symbol. GM Goodwrench oil meets all the requirements for your vehicle. To determine the proper viscosity for your vehicle's engine, see <i>Engine Oil on page 5-16</i> .
Engine Coolant	50/50 mixture of clean, drinkable water and use only DEX-COOL <sup>®</sup> Coolant. See <i>Engine Coolant (3.8L V6 Engine) on page 5-31</i> or <i>Engine Coolant (4.6L V8 Engine) on page 5-34</i> .
Hydraulic Brake System	Delco Supreme 11 Brake Fluid or equivalent DOT-3 brake fluid.

Usage	Fluid/Lubricant
Windshield Washer Solvent	GM Optikleen <sup>®</sup> Washer Solvent.
Parking Brake Cable Guides	Chassis Lubricant (GM Part No. U.S. 12377985, in Canada 88901242) or lubricant meeting requirements of NLGI #2, Category LB or GC-LB.
Power Steering System	GM Power Steering Fluid (GM Part No. U.S. 89021184, in Canada 89021186).
Automatic Transaxle	DEXRON <sup>®</sup> -III Automatic Transmission Fluid. Look for "Approved for the H-Specification" on the label.
Key Lock Cylinders	Multi-Purpose Lubricant, Superlube (GM Part No. U.S. 12346241, in Canada 10953474).
Floor Shift Linkage	Lubriplate Lubricant Aerosol (GM Part No. U.S. 12346293, in Canada 992723) or lubricant meeting requirements of NLGI #2, Category LB or GC-LB.

Usage	Fluid/Lubricant
Hood Latch Assembly, Secondary Latch, Pivots, Spring Anchor and Release Pawl	Lubriplate Lubricant Aerosol (GM Part No. U.S. 12346293, in Canada 992723) or lubricant meeting requirements of NLGI #2, Category LB or GC-LB.
Hood and Door Hinges	Multi-Purpose Lubricant, Superlube (GM Part No. U.S. 12346241, in Canada 10953474).

Usage	Fluid/Lubricant
Fuel Door, Glove Box Door, Console Door and Rear Compartment Lid Hinges	Multi-Purpose Lubricant, Superlube (GM Part No. U.S. 12346241, in Canada 10953474).
Weatherstrip Conditioning	Dielectric Silicone Grease (GM Part No. U.S. 12345579, in Canada 992887).



# Part E: Maintenance Record

After the scheduled services are performed, record the date, odometer reading and who performed the service and any additional information from "Owner Checks and Services" or "Periodic Maintenance" on the following record pages. Also, you should retain all maintenance receipts.

## Maintenance Record

Date	Odometer Reading	Serviced By	Maintenance Record

**Maintenance Record (cont'd)**

<b>Date</b>	<b>Odometer Reading</b>	<b>Serviced By</b>	<b>Maintenance Record</b>

### Maintenance Record (cont'd)

Date	Odometer Reading	Serviced By	Maintenance Record



# Section 7 Customer Assistance and Information

---

<b>Customer Assistance and Information</b> .....	7-2	<b>Reporting Safety Defects</b> .....	7-10
Customer Satisfaction Procedure .....	7-2	Reporting Safety Defects to the United States	
Online Owner Center .....	7-3	Government .....	7-10
Customer Assistance for Text		Reporting Safety Defects to the Canadian	
Telephone (TTY) Users .....	7-4	Government .....	7-10
Customer Assistance Offices .....	7-4	Reporting Safety Defects to General Motors .....	7-11
GM Mobility Reimbursement Program .....	7-5	Service Publications Ordering Information .....	7-11
Roadside Assistance Program .....	7-5		
Courtesy Transportation .....	7-7		
Vehicle Data Collection and Event Data			
Recorders .....	7-9		

# Customer Assistance and Information

## Customer Satisfaction Procedure

Your satisfaction and goodwill are important to your dealer and to Pontiac. Normally, any concerns with the sales transaction or the operation of your vehicle will be resolved by your dealer's sales or service departments. Sometimes, however, despite the best intentions of all concerned, misunderstandings can occur. If your concern has not been resolved to your satisfaction, the following steps should be taken:

**STEP ONE:** Discuss your concern with a member of dealership management. Normally, concerns can be quickly resolved at that level. If the matter has already been reviewed with the sales, service or parts manager, contact the owner of the dealership or the general manager.

**STEP TWO:** If after contacting a member of dealership management, it appears your concern cannot be resolved by the dealership without further help, contact the Pontiac Customer Assistance Center by calling 1-800-762-2737. In Canada, contact GM of Canada Customer Communication Centre in Oshawa by calling 1-800-263-3777 (English) or 1-800-263-7854 (French).

We encourage you to call the toll-free number in order to give your inquiry prompt attention. Please have the following information available to give the Customer Assistance Representative:

- Vehicle Identification Number (VIN). This is available from the vehicle registration or title, or the plate at the top left of the instrument panel and visible through the windshield.
- Dealership name and location.
- Vehicle delivery date and present mileage.

When contacting Pontiac, please remember that your concern will likely be resolved at a dealer's facility. That is why we suggest you follow Step One first if you have a concern.

**STEP THREE:** Both General Motors and your dealer are committed to making sure you are completely satisfied with your new vehicle. However, if you continue to remain unsatisfied after following the procedure outlined in Steps One and Two, you should file with the BBB Auto Line Program to enforce any additional rights you may have. Canadian owners refer to your Warranty and Owner Assistance Information booklet for information on the Canadian Motor Vehicle Arbitration Plan (CAMVAP).

The BBB Auto Line Program is an out of court program administered by the Council of Better Business Bureaus to settle automotive disputes regarding vehicle repairs or the interpretation of the New Vehicle Limited Warranty. Although you may be required to resort to this informal dispute resolution program prior to filing a court action, use of the program is free of charge and your case will generally be heard within 40 days. If you do not agree with the decision given in your case, you may reject it and proceed with any other venue for relief available to you.

You may contact the BBB Auto Line Program using the toll-free telephone number or write them at the following address:

BBB Auto Line Program  
Council of Better Business Bureaus, Inc.  
4200 Wilson Boulevard  
Suite 800  
Arlington, VA 22203-1838  
Telephone: 1-800-955-5100

This program is available in all 50 states and the District of Columbia. Eligibility is limited by vehicle age, mileage and other factors. General Motors reserves the right to change eligibility limitations and/or discontinue its participation in this program.

## Online Owner Center

The Owner Center is a resource for your GM ownership needs. Specific vehicle information can be found in one place.

### The Online Owner Center allows you to:

- Get e-mail service reminders.
- Access information about your specific vehicle, including tips and videos and an electronic version of this owner's manual (United States only).
- Keep track of your vehicle's service history and maintenance schedule.
- Find GM dealers for service nationwide.
- Receive special promotions and privileges only available to members (United States only).

Refer to the web for updated information.

To register your vehicle, visit [www.MyGMLink.com](http://www.MyGMLink.com) (United States) or My GM Canada within [www.gmcanada.com](http://www.gmcanada.com) (Canada).

## **Customer Assistance for Text Telephone (TTY) Users**

To assist customers who are deaf, hard of hearing, or speech-impaired and who use Text Telephones (TTYs), Pontiac has TTY equipment available at its Customer Assistance Center. Any TTY user can communicate with Pontiac by dialing: 1-800-833-PONT (7668). (TTY users in Canada can dial 1-800-263-3830.)

## **Customer Assistance Offices**

Pontiac encourages customers to call the toll-free number for assistance. If a U.S. customer wishes to write to Pontiac, the letter should be addressed to Pontiac's Customer Assistance Center.

## **United States — Customer Assistance**

Pontiac Customer Assistance Center  
P.O. Box 33172  
Detroit, MI 48232-5172

1-800-762-2737 or  
1-800-833-7668 (For Text Telephone devices (TTYs))  
Roadside Assistance: 1-800-ROADSIDE (762-3743)  
Fax Number: 313-381-0022

From Puerto Rico:  
1-800-496-9992 (English)  
1-800-496-9993 (Spanish)  
Fax Number: 313-381-0022

From U.S. Virgin Islands:  
1-800-496-9994  
Fax Number: 313-381-0022

## **Canada — Customer Assistance**

General Motors of Canada Limited  
Customer Communication Centre, 163-005  
1908 Colonel Sam Drive  
Oshawa, Ontario L1H 8P7

1-800-263-3777 (English)  
1-800-263-7854 (French)  
1-800-263-3830 (For Text Telephone devices (TTYs))  
Roadside Assistance: 1-800-268-6800

## **Overseas — Customer Assistance**

Please contact the local General Motors Business Unit.



## Mexico, Central America and Caribbean Islands/Countries (Except Puerto Rico and U.S. Virgin Islands) — Customer Assistance

General Motors de Mexico, S. de R.L. de C.V.  
Customer Assistance Center  
Paseo de la Reforma # 2740  
Col. Lomas de Bezares  
C.P. 11910, Mexico, D.F.  
01-800-508-0000  
Long Distance: 011-52-53 29 0 800

## GM Mobility Reimbursement Program

This program, available to qualified applicants, can reimburse you up to \$1,000 toward eligible aftermarket driver's or passenger's adaptive equipment you may require for your vehicle, such as hand controls and wheelchair/scooter lifts.

The offer is available for a limited period of time from the date of vehicle purchase/lease. For more details, or to determine your vehicle's eligibility, visit [gmmobility.com](http://gmmobility.com) or call the GM Mobility Assistance Center at 1-800-323-9935. Text telephone (TTY) users, call 1-800-833-9935.

GM of Canada also has a Mobility Program. Call 1-800-GM-DRIVE (463-7483) for details. TTY users call 1-800-263-3830.

## Roadside Assistance Program

As the owner of a new Pontiac vehicle, you are automatically enrolled in the Pontiac Roadside Assistance program. This value-added service is intended to provide you with peace of mind as you drive in the city or travel the open road. Contact Pontiac's Roadside Assistance toll-free at 1-800-ROADSIDE (762-3743). Roadside Assistance Representatives are available 24 hours a day, 365 days a year.

We will provide the following services during the Bumper-to-Bumper warranty period, at no expense to you:

- **Fuel Delivery:** Delivery of enough fuel (\$5 maximum) for the customer to get to the nearest service station.
- **Lock-out Service (identification required):** Replacement keys or locksmith service will be covered at no charge if you are unable to gain entry into your vehicle. Delivery of the replacement key will be covered within 10 miles (16 km).

- **Emergency Tow:** Tow to the nearest dealership for warranty service or in the event of a vehicle-disabling accident. Assistance provided when the vehicle is mired in sand, mud, or snow.
- **Flat Tire Change:** Installation of a spare tire will be covered at no charge. The customer is responsible for the repair or replacement of the tire if not covered by a warrantable failure.
- **Jump Start:** No-start occurrences which require a battery jump start will be covered at no charge.
- **Dealer Locator Service**

In many instances, mechanical failures are covered under Pontiac's Bumper-to-Bumper warranty. However, when other services are utilized, our Roadside Assistance Representatives will explain any payment obligations you might incur.

For prompt and efficient assistance when calling, please provide the following to the Roadside Assistance Representative:

- Your name, home address, and home telephone number
- Telephone number of your location.
- Location of the vehicle.
- Model, year, color, and license plate number of the vehicle.

- Mileage, Vehicle Identification Number (VIN), and delivery date of the vehicle.
- Description of the problem.

While we hope you never have the occasion to use our service, it is added security while traveling for you and your family. Remember, we are only a phone call away. Pontiac Roadside Assistance: 1-800-ROADSIDE (762-3743), text telephone (TTY) users, call 1-888-889-2438.

Pontiac reserves the right to limit services or reimbursement to an owner or driver when, in Pontiac's judgement, the claims become excessive in frequency or type of occurrence.

Roadside Assistance is not part of or included in the coverage provided by the New Vehicle Limited Warranty. Pontiac reserves the right to make any changes or discontinue the Roadside Assistance program at any time without notification.

## Canadian Roadside Assistance

Vehicles purchased in Canada have an extensive roadside assistance program accessible from anywhere in Canada or the United States. Please refer to the Warranty and Owner Assistance Information book.

## Courtesy Transportation

Pontiac has always exemplified quality and value in its offering of motor vehicles. To enhance your ownership experience, we and our participating dealers are proud to offer Courtesy Transportation, a customer support program for new vehicles.

The Courtesy Transportation program is offered to retail purchase/lease customers in conjunction with the Bumper-to-Bumper coverage provided by the New Vehicle Limited Warranty. Several transportation options are available when warranty repairs are required. This will reduce your inconvenience during warranty repairs.

## Scheduling Service Appointments

When your vehicle requires warranty service, you should contact your dealer and request an appointment. By scheduling a service appointment and advising your service consultant of your transportation needs, your dealer can help minimize your inconvenience.

If your vehicle cannot be scheduled into the service department immediately, keep driving it until it can be scheduled for service, unless, of course, the problem is safety-related. If it is, please call your dealership, let them know this, and ask for instructions.

If the dealer requests that you simply drop the vehicle off for service, you are urged to do so as early in the work day as possible to allow for same day repair.

## Transportation Options

Warranty service can generally be completed while you wait. However, if you are unable to wait Pontiac helps minimize your inconvenience by providing several transportation options. Depending on the circumstances, your dealer can offer you one of the following:

### Shuttle Service

Participating dealers can provide you with shuttle service to get you to your destination with minimal interruption of your daily schedule. This includes a one way or round trip shuttle ride to a destination up to 10 miles (16 km) from the dealership.

### Public Transportation or Fuel Reimbursement

If your vehicle requires overnight warranty repairs, reimbursement of up to a five day maximum may be available for the use of public transportation such as a taxi or bus. In addition, should you arrange transportation through a friend or relative, reimbursement for reasonable fuel expenses of up to a five day maximum may be available. Claim amounts should reflect actual costs and be supported by original receipts.

## Courtesy Rental Vehicle

Your dealer may arrange to provide you with a courtesy rental vehicle or reimburse you for a rental vehicle that you obtain if your vehicle is kept for a warranty repair. Reimbursement will be limited to a maximum of \$30 a day and must be supported by receipts. This requires that you sign and complete a rental agreement and meet state, local and rental vehicle provider requirements. Requirements vary and may include minimum age requirements, insurance coverage, credit card, etc. You are responsible for fuel usage charges and may also be responsible for taxes, levies, usage fees, excessive mileage or rental usage beyond the completion of the repair.

Generally it is not possible to provide a like-vehicle as a courtesy rental.

## Additional Program Information

Courtesy Transportation is available during the Bumper-to-Bumper warranty coverage period, but it is not part of the New Vehicle Limited Warranty. A separate booklet entitled *Warranty and Owner Assistance Information* furnished with each new vehicle provides detailed warranty coverage information.

Courtesy Transportation is available only at participating dealers and all program options, such as shuttle service, may not be available at every dealer. Please contact your dealer for specific information about availability. All Courtesy Transportation arrangements will be administered by appropriate dealer personnel.

**Canadian Vehicles:** For warranty repairs during the Complete Vehicle Coverage period of the General Motors of Canada New Vehicle Limited warranty, alternative transportation may be available under the Courtesy Transportation Program. Please consult your dealer for details.

General Motors reserves the right to unilaterally modify, change or discontinue Courtesy Transportation at any time and to resolve all questions of claim eligibility pursuant to terms and conditions described herein at its sole discretion.

## Vehicle Data Collection and Event Data Recorders

Your vehicle, like other modern motor vehicles, has a number of sophisticated computer systems that monitor and control several aspects of the vehicle's performance. Your vehicle uses on-board vehicle computers to monitor emission control components to optimize fuel economy, to monitor conditions for airbag deployment and, if so equipped, to provide anti-lock braking and to help the driver control the vehicle in difficult driving situations. Some information may be stored during regular operations to facilitate repair of detected malfunctions; other information is stored only in a crash event by computer systems, such as those commonly called event data recorders (EDR).

In a crash event, computer systems, such as the Airbag Sensing and Diagnostic Module (SDM) in your vehicle may record information about the condition of the vehicle and how it was operated, such as data related to engine speed, brake application, throttle position, vehicle speed, safety belt usage, airbag readiness, airbag performance, and the severity of a collision. This information has been used to improve vehicle crash performance and may be used to improve crash performance of future vehicles and driving safety. Unlike the data recorders on many airplanes, these on-board systems do not record sounds, such as conversation of vehicle occupants.

To read this information, special equipment is needed and access to the vehicle or the device that stores the data is required. GM will not access information about a crash event or share it with others other than:

- with the consent of the vehicle owner or, if the vehicle is leased, with the consent of the lessee,
- in response to an official request of police or similar government office,
- as part of GM's defense of litigation through the discovery process, or
- as required by law.

In addition, once GM collects or receives data, GM may:

- use the data for GM research needs,
- make it available for research where appropriate confidentiality is to be maintained and need is shown, or
- share summary data which is not tied to a specific vehicle with non-GM organizations for research purposes.

Others, such as law enforcement, may have access to the special equipment that can read the information if they have access to the vehicle or the device that stores the data.

If your vehicle is equipped with OnStar<sup>®</sup>, please check the OnStar<sup>®</sup> subscription service agreement or manual for information on its operations and data collection.

# Reporting Safety Defects

## Reporting Safety Defects to the United States Government

If you believe that your vehicle has a defect which could cause a crash or could cause injury or death, you should immediately inform the National Highway Traffic Safety Administration (NHTSA), in addition to notifying General Motors.

If NHTSA receives similar complaints, it may open an investigation, and if it finds that a safety defect exists in a group of vehicles, it may order a recall and remedy campaign. However, NHTSA cannot become involved in individual problems between you, your dealer, or General Motors.

To contact NHTSA, you may either call the Auto Safety Hotline toll-free at 1-800-424-9393 (or 366-0123 in the Washington, D.C. area) or write to:

NHTSA, U.S. Department of Transportation  
Washington, D.C. 20590

You can also obtain other information about motor vehicle safety from the hotline.

## Reporting Safety Defects to the Canadian Government

If you live in Canada, and you believe that your vehicle has a safety defect, you should immediately notify Transport Canada, in addition to notifying General Motors of Canada Limited. You may write to:

Transport Canada  
330 Sparks Street  
Tower C  
Ottawa, Ontario K1A 0N5

## Reporting Safety Defects to General Motors

In addition to notifying NHTSA (or Transport Canada) in a situation like this, we certainly hope you'll notify us. Please call us at 1-800-762-2737, or write:

Pontiac Customer Assistance Center  
P.O. Box 33172  
Detroit, MI 48232-5172

In Canada, please call us at 1-800-263-3777 (English) or 1-800-263-7854 (French). Or, write:

General Motors of Canada Limited  
Customer Communication Centre, 163-005  
1908 Colonel Sam Drive  
Oshawa, Ontario L1H 8P7

## Service Publications Ordering Information

### Service Manuals

Service Manuals have the diagnosis and repair information on engines, transmission, axle suspension, brakes, electrical, steering, body, etc.

## Transmission, Transaxle, Transfer Case Unit Repair Manual

This manual provides information on unit repair service procedures, adjustments, and specifications for GM transmissions, transaxles, and transfer cases.

### Service Bulletins

Service Bulletins give technical service information needed to knowledgeably service General Motors cars and trucks. Each bulletin contains instructions to assist in the diagnosis and service of your vehicle.

In Canada, information pertaining to Product Service Bulletins can be obtained by contacting your General Motors dealer or by calling 1-800-GM-DRIVE (1-800-463-7483).

## Owner's Information

Owner publications are written specifically for owners and intended to provide basic operational information about the vehicle. The owner's manual will include the Maintenance Schedule for all models.

In-Portfolio: Includes a Portfolio, Owner's Manual, and Warranty Booklet.

RETAIL SELL PRICE: \$35.00

Without Portfolio: Owner's Manual only.

RETAIL SELL PRICE: \$25.00

## Current and Past Model Order Forms

Service Publications are available for current and past model GM vehicles. To request an order form, please specify year and model name of the vehicle.

## ORDER TOLL FREE: 1-800-551-4123 Monday-Friday 8:00 AM - 6:00 PM Eastern Time

For Credit Card Orders Only  
(VISA-MasterCard-Discover), visit Helm, Inc. on the  
World Wide Web at: [www.helminc.com](http://www.helminc.com)

Or you can write to:

Helm, Incorporated  
P. O. Box 07130  
Detroit, MI 48207

Prices are subject to change without notice and without incurring obligation. Allow ample time for delivery.

Note to Canadian Customers: All listed prices are quoted in U.S. funds. Canadian residents are to make checks payable in U.S. funds.



# A

Accessory Inflator .....	5-91
Accessory Power Outlets .....	3-24
Additives, Fuel .....	5-6
Add-On Electrical Equipment .....	5-111
Air Cleaner/Filter, Engine .....	5-22, 5-23
Air Conditioning .....	3-25, 3-28
Airbag	
Readiness Light .....	3-38
Airbag Sensing and Diagnostic Module (SDM) .....	7-9
Airbag System .....	1-47
How Does an Airbag Restrain? .....	1-53
Servicing Your Airbag-Equipped Vehicle .....	1-56
What Makes an Airbag Inflate? .....	1-53
What Will You See After an Airbag Inflates? ....	1-54
When Should an Airbag Inflate? .....	1-52
Where Are the Airbags? .....	1-50
Antenna, Diversity Antenna System .....	3-102
Antenna, XM™ Satellite Radio Antenna System ...	3-103
Anti-Lock Brake System (ABS) .....	4-6
Anti-Lock Brake, System Warning Light .....	3-42
Appearance Care .....	5-101
Aluminum or Chrome-Plated Wheels .....	5-107
Care of Safety Belts .....	5-104
Chemical Paint Spotting .....	5-108
Cleaning Exterior Lamps/Lenses .....	5-105
Fabric/Carpet .....	5-102
Finish Care .....	5-106
Appearance Care (cont.)	
Finish Damage .....	5-108
Glass Surfaces .....	5-104
Instrument Panel .....	5-104
Interior Plastic Components .....	5-104
Leather .....	5-104
Sheet Metal Damage .....	5-108
Tires .....	5-107
Underbody Maintenance .....	5-108
Vehicle Care/Appearance Materials .....	5-109
Vinyl .....	5-103
Washing Your Vehicle .....	5-105
Weatherstrips .....	5-105
Windshield and Wiper Blades .....	5-106
Ashtrays .....	3-24
Audio System(s) .....	3-72
Audio Steering Wheel Controls .....	3-99
Care of Your Cassette Tape Player .....	3-101
Care of Your CD Player .....	3-102
Care of Your CDs .....	3-102
Chime Level Adjustment .....	3-103
Diversity Antenna System .....	3-102
Radio with Cassette and CD .....	3-83
Radio with CD .....	3-73
Setting the Time .....	3-72
Theft-Deterrent Feature .....	3-99
Trunk-Mounted CD Changer .....	3-95
Understanding Radio Reception .....	3-100
XM™ Satellite Radio Antenna System .....	3-103

Automatic Climate Control System .....	3-28
Automatic Transaxle	
Fluid .....	5-25, 5-28
Operation .....	2-27

## B

Battery .....	5-57
Exterior Lighting Battery Saver .....	3-17
Inadvertent Power Saver .....	3-21
Load Management .....	3-20
Before Leaving on a Long Trip .....	4-21
Brake	
Anti-Lock Brake System (ABS) .....	4-6
Emergencies .....	4-8
Parking .....	2-30
System Inspection .....	6-24
System Warning Light .....	3-41
Brakes .....	5-54
Braking .....	4-5
Braking in Emergencies .....	4-8
Break-In, New Vehicle .....	2-23
Bulb Replacement .....	5-67
Front Turn Signal and Parking Lamps .....	5-69
Halogen Bulbs .....	5-67
Headlamps .....	5-68

Bulb Replacement (cont.)	
Replacement Bulbs .....	5-72
Taillamps, Turn Signal, Stoplamps and	
Back-up Lamps .....	5-71
Buying New Tires .....	5-86

## C

California Fuel .....	5-6
Canadian Owners .....	ii
Capacities and Specifications .....	5-121
Carbon Monoxide .....	2-15, 2-34, 4-24, 4-36
Care of	
Safety Belts .....	5-104
Your Cassette Tape Player .....	3-101
Your CD Player .....	3-102
Your CDs .....	3-102
CD Changer, Trunk-Mounted .....	3-95
Center Console Storage Area .....	2-45
Center Front Passenger Position, Safety Belts ....	1-20
Chains, Tire .....	5-90
Check	
Engine Light .....	3-48
Gages Warning Light .....	3-54
Tire Pressure System .....	5-83
Checking Things Under the Hood .....	5-10
Chemical Paint Spotting .....	5-108

Child Restraints		Cleaning (cont.)	
Child Restraint Systems .....	1-34	Vinyl .....	5-103
Infants and Young Children .....	1-30	Washing Your Vehicle .....	5-105
Lower Anchorages and Top Tethers for		Weatherstrips .....	5-105
Children (LATCH System) .....	1-40	Windshield and Wiper Blades .....	5-106
Older Children .....	1-28	Climate Control System .....	3-25
Securing a Child Restraint Designed for the		Automatic .....	3-28
LATCH System .....	1-42	Climate Controls Personalization .....	3-32
Securing a Child Restraint in a Rear Seat		Outlet Adjustment .....	3-32
Position .....	1-42	Comfort Guides, Rear Safety Belt .....	1-25
Securing a Child Restraint in the Center Front		Compact Spare Tire .....	5-100
Seat Position .....	1-44	Compass, Electronic .....	3-70
Securing a Child Restraint in the Right Front		Content Theft-Deterrent .....	2-21
Seat Position .....	1-45	Control of a Vehicle .....	4-5
Top Strap .....	1-38	Convenience Net .....	2-45
Top Strap Anchor Location .....	1-39	Coolant	
Where to Put the Restraint .....	1-37	Engine Temperature Gage .....	3-45, 3-46
Chime Level Adjustment .....	3-103	Heater, Engine .....	2-26
Cigarette Lighter .....	3-24	Surge Tank Pressure Cap .....	5-36
Cleaning		Cooling System .....	5-40, 5-47
Aluminum or Chrome-Plated Wheels .....	5-107	Courtesy Lamps .....	3-17
Exterior Lamps/Lenses .....	5-105	Cruise Control Lever .....	3-11
Fabric/Carpet .....	5-102	Customer Assistance Information	
Finish Care .....	5-106	Courtesy Transportation .....	7-7
Glass Surfaces .....	5-104	Customer Assistance for Text	
Instrument Panel .....	5-104	Telephone (TTY) Users .....	7-4
Interior Plastic Components .....	5-104	Customer Assistance Offices .....	7-4
Leather .....	5-104	Customer Satisfaction Procedure .....	7-2
Tires .....	5-107	GM Mobility Reimbursement Program .....	7-5
Underbody Maintenance .....	5-108	Reporting Safety Defects to General Motors ....	7-11

Customer Assistance Information (cont.)	
Reporting Safety Defects to the Canadian Government .....	7-10
Reporting Safety Defects to the United States Government .....	7-10
Roadside Assistance Program .....	7-5
Service Publications Ordering Information .....	7-11

## D

Daytime Running Lamps .....	3-15
Defensive Driving .....	4-2
Delayed Entry Lighting .....	3-18
Delayed Exit Lighting .....	3-18
Delayed Locking .....	2-11
Diversity Antenna System .....	3-102
Doing Your Own Service Work .....	5-4
Door	
Ajar Light .....	3-54
Central Door Unlocking System .....	2-10
Delayed Locking .....	2-11
Locks .....	2-9
Power Door Locks .....	2-10
Programmable Automatic Door Locks .....	2-12
Rear Door Security Locks .....	2-14
Driver	
Position, Safety Belt .....	1-13

Driver Information Center (DIC) .....	3-59
DIC Controls and Displays .....	3-60
DIC Vehicle Personalization .....	3-64
DIC Warnings and Messages .....	3-62
Driver Identifier DIC Display .....	3-64
Driving	
At Night .....	4-15
City .....	4-19
Defensive .....	4-2
Drunken .....	4-2
Freeway .....	4-20
Hill and Mountain Roads .....	4-22
In Rain and on Wet Roads .....	4-16
Rocking Your Vehicle to Get it Out .....	4-29
Winter .....	4-24

## E

Electrical System	
Add-On Equipment .....	5-111
Engine Compartment Fuse Block .....	5-112, 5-114
Fuses and Circuit Breakers .....	5-111
Headlamp Wiring .....	5-111
Power Windows and Other Power Options .....	5-111
Rear Underseat Fuse Block .....	5-116
Windshield Wiper Fuses .....	5-111
Electronic Compass .....	3-70

Engine	
Air Cleaner/Filter .....	5-22, 5-23
Battery .....	5-57
Check and Service Engine Soon Light .....	3-48
Coolant .....	5-31, 5-34
Coolant Heater .....	2-26
Coolant Temperature Gage .....	3-45, 3-46
Cooling System Inspection .....	6-23
Engine Compartment Overview .....	5-12
Exhaust .....	2-34
Oil .....	5-16
Overheated Protection Operating Mode .....	5-40
Overheating .....	5-36, 5-38
Starting .....	2-25
Entry Lighting .....	3-18
Event Data Recorders (EDR) .....	7-9
Extender, Safety Belt .....	1-27
Exterior Lamps .....	3-14
Exterior Lighting Battery Saver .....	3-17

## F

Filter	
Engine Air Cleaner .....	5-22, 5-23
Finish Damage .....	5-108
Flash-to-Pass .....	3-9

Flat Tire .....	5-92
Flat Tire, Changing .....	5-93
Flat Tire, Storing .....	5-100
Fluid	
Automatic Transaxle .....	5-25, 5-28
Power Steering .....	5-52
Windshield Washer .....	5-53
Fog Lamps .....	3-16
Front Reading Lamps .....	3-20
Front Storage Area .....	2-45
Fuel	
Additives .....	5-6
California Fuel .....	5-6
Filling a Portable Fuel Container .....	5-10
Filling Your Tank .....	5-8
Fuels in Foreign Countries .....	5-7
Gage .....	3-56, 3-57
Gasoline Octane .....	5-5
Gasoline Specifications .....	5-6
System Inspection .....	6-23
Fuses	
Engine Compartment Fuse Block .....	5-112, 5-114
Fuses and Circuit Breakers .....	5-111
Rear Underseat Fuse Block .....	5-116
Windshield Wiper .....	5-111

## G

Gage	
Check Gages Warning Light .....	3-54
Engine Coolant Temperature .....	3-45, 3-46
Fuel .....	3-56, 3-57
Oil Pressure .....	3-51, 3-52
Speedometer .....	3-37
Tachometer .....	3-38
Voltmeter Gage .....	3-40
Garage Door Opener .....	2-40
Gasoline	
Octane .....	5-5
Specifications .....	5-6
Glove Box .....	2-44
GM Mobility Reimbursement Program .....	7-5

## H

Hazard Warning Flashers .....	3-6
Head Restraints .....	1-7
Headlamp Wiring .....	5-111
Headlamps .....	5-68
Bulb Replacement .....	5-67
Daytime Running Lamps .....	3-15
Flash-to-Pass .....	3-9
Front Turn Signal and Parking Lamps .....	5-69
Halogen Bulbs .....	5-67
High/Low Beam Changer .....	3-8

Headlamps (cont.)	
On Reminder .....	3-15
Wiper Activated .....	3-14
Head-Up Display (HUD) .....	3-21
Heated Seats .....	1-4
Heater .....	3-25, 3-28
Highbeam On Light .....	3-54
Highway Hypnosis .....	4-22
Hill and Mountain Roads .....	4-22
HomeLink <sup>®</sup> Transmitter .....	2-40
HomeLink <sup>®</sup> Transmitter, Programming .....	2-41
Hood	
Checking Things Under .....	5-10
Release .....	5-11
Horn .....	3-6
How to Use This Manual .....	ii
How to Wear Safety Belts Properly .....	1-12

## I

Ignition Positions .....	2-24
Inadvertent Power Battery Saver .....	3-21
Infants and Young Children, Restraints .....	1-30
Inflation -- Tire Pressure .....	5-80
Inspection	
Brake System .....	6-24
Engine Cooling System .....	6-23
Exhaust System .....	6-23

Inspection (cont.)	
Fuel System .....	6-23
Part C - Periodic Maintenance .....	6-23
Steering, Suspension and Front Drive Axle	
Boot and Seal .....	6-23
Throttle System .....	6-24
Instrument Panel	
Brightness .....	3-17
Cluster .....	3-33
Overview .....	3-4

## J

Jump Starting .....	5-59, 5-63
---------------------	------------

## K

Keyless Entry System .....	2-4
Keys .....	2-2

## L

Labelling, Tire Sidewall .....	5-75
Lamps	
Battery Load Management .....	3-20
Courtesy .....	3-17

Lamps (cont.)	
Exterior .....	3-14
Exterior Lighting Battery Saver .....	3-17
Fog .....	3-16
Front Reading .....	3-20
Inadvertent Power Battery Saver .....	3-21
Rear Reading .....	3-20
Twilight Sentinel® .....	3-16

LATCH System	
Child Restraints .....	1-40
Securing a Child Restraint Designed for the	
LATCH System .....	1-42

Light	
Airbag Readiness .....	3-38
Anti-Lock Brake System Warning .....	3-42
Brake System Warning .....	3-41
Check Gages Warning .....	3-54
Check Oil Level .....	3-53
Door Ajar .....	3-54
Highbeam On .....	3-54
Low Traction Active .....	3-44
Low Washer Fluid Warning .....	3-54
Malfunction Indicator .....	3-48
Safety Belt Reminder .....	3-38
Security .....	3-53
Service Vehicle Soon .....	3-55
TCS Warning Light .....	3-43

Light (cont.)	
Tire Pressure .....	3-47
Traction Control System (TCS) Warning .....	3-43
Trunk Ajar .....	3-55
Lighting	
Delayed Entry .....	3-18
Delayed Exit .....	3-18
Entry .....	3-18
Parade Dimming .....	3-19
Perimeter .....	3-18
Theater Dimming .....	3-18
Lockout Protection .....	2-14
Locks	
Central Door Unlocking System .....	2-10
Delayed Locking .....	2-11
Door .....	2-9
Lockout Protection .....	2-14
Power Door .....	2-10
Programmable Automatic Door Locks .....	2-12
Rear Door Security Locks .....	2-14
Long Trip/Highway Scheduled Maintenance .....	6-13
Loss of Control .....	4-13
Low Traction Active Light .....	3-44
Low Washer Fluid Warning Light .....	3-54
Lumbar	
Manual Controls .....	1-3
Power Controls .....	1-3

## M

Maintenance, Normal Replacement Parts .....	5-122
Maintenance Schedule	
At Each Fuel Fill .....	6-19
At Least Once a Month .....	6-19
At Least Once a Year .....	6-20
At Least Twice a Year .....	6-20
Brake System Inspection .....	6-24
Engine Cooling System Inspection .....	6-23
Exhaust System Inspection .....	6-23
Fuel System Inspection .....	6-23
How This Section is Organized .....	6-3
Introduction .....	6-2
Long Trip/Highway Scheduled Maintenance .....	6-13
Maintenance Requirements .....	6-2
Part A - Scheduled Maintenance Services .....	6-4
Part B - Owner Checks and Services .....	6-19
Part C - Periodic Maintenance Inspections .....	6-23
Part D - Recommended Fluids and Lubricants .....	6-25
Part E - Maintenance Record .....	6-27
Selecting the Right Schedule .....	6-5
Short Trip/City Scheduled Maintenance .....	6-6
Steering, Suspension and Front Drive Axle	
Boot and Seal Inspection .....	6-23
Throttle System Inspection .....	6-24
Using Your .....	6-4
Your Vehicle and the Environment .....	6-2



Malfunction Indicator Light .....	3-48
Manual Lumbar Controls .....	1-3
Manual Seats .....	1-2
Memory Mirrors .....	2-46
Memory Seat .....	2-46
Message	
DIC Warnings and Messages .....	3-62
Mirrors	
Automatic Dimming Rearview .....	2-36
Manual Rearview Mirror .....	2-36
Memory .....	2-46
Outside Convex Mirror .....	2-38
Outside Curb View Assist Mirror .....	2-38
Outside Heated Mirrors .....	2-38
Outside Power Mirrors .....	2-37
Monitor, Systems .....	3-58
MyGMLink.com .....	7-3

## N

New Vehicle Break-In .....	2-23
Normal Maintenance Replacement Parts .....	5-122

## O

Odometer .....	3-37
Odometer, Trip .....	3-37

Off-Road Recovery .....	4-12
Oil	
Check Oil Level Light .....	3-53
Engine .....	5-16
Pressure Gage .....	3-51, 3-52
Older Children, Restraints .....	1-28
Online Owner Center .....	7-3
OnStar® System .....	2-39
Other Warning Devices .....	3-6
Outlet Adjustment .....	3-32
Outside	
Convex Mirror .....	2-38
Curb View Assist Mirror .....	2-38
Heated Mirrors .....	2-38
Power Mirrors .....	2-37
Overheated Engine Protection Operating Mode ...	5-40
Owners, Canadian .....	ii

## P

Parade Dimming .....	3-19
Park (P)	
Shifting Into .....	2-31
Shifting Out of .....	2-33
Parking	
Brake .....	2-30
Over Things That Burn .....	2-34

Part A - Scheduled Maintenance Services .....	6-4
Part B - Owner Checks and Services .....	6-19
Part C - Periodic Maintenance Inspections .....	6-23
Part D - Recommended Fluids and Lubricants ....	6-25
Part E - Maintenance Record .....	6-27
Passing .....	4-12
PASS-Key® III .....	2-21
PASS-Key® III Operation .....	2-22
Perimeter Lighting .....	3-18
Personalization, Climate Controls .....	3-32
Power	
Accessory Outlets .....	3-24
Door Locks .....	2-10
Electrical System .....	5-111
Inadvertent Battery Saver .....	3-21
Lumbar Controls .....	1-3
Reclining Seatback .....	1-5
Retained Accessory (RAP) .....	2-24
Seat .....	1-2
Steering Fluid .....	5-52
Windows .....	2-18
Programmable Automatic Door Locks .....	2-12
Programming the HomeLink® Transmitter .....	2-41

## Q

Questions and Answers About Safety Belts .....	1-12
--	------

## R

Radiator Pressure Cap .....	5-36
Radios .....	3-72
Care of Your Cassette Tape Player .....	3-101
Care of Your CD Player .....	3-102
Care of Your CDs .....	3-102
Radio with Cassette and CD .....	3-83
Radio with CD .....	3-73
Setting the Time .....	3-72
Theft-Deterrent .....	3-99
Trunk-Mounted CD Changer .....	3-95
Understanding Reception .....	3-100
Rear Door Security Locks .....	2-14
Rear Reading Lamps .....	3-20
Rear Safety Belt Comfort Guides .....	1-25
Rear Seat Pass Through .....	2-45
Rear Seat Passengers, Safety Belts .....	1-21
Rearview Mirror, Automatic Dimming .....	2-36
Rearview Mirrors .....	2-36
Reclining Seatback, Power .....	1-5
Reclining Seatbacks .....	1-4
Recreational Vehicle Towing .....	4-35
Remote Keyless Entry System .....	2-4
Remote Keyless Entry System, Operation .....	2-5
Removing the Flat Tire and Installing the Spare Tire .....	5-95

Removing the Spare Tire and Tools .....	5-94
Replacement Bulbs .....	5-72
Reporting Safety Defects	
Canadian Government .....	7-10
General Motors .....	7-11
United States Government .....	7-10
Restraint System Check	
Checking Your Restraint Systems .....	1-56
Replacing Restraint System Parts After a Crash .....	1-57
Restraint Systems	
Checking .....	1-56
Replacing Parts .....	1-57
Retained Accessory Power (RAP) .....	2-24
Right Front Passenger Position, Safety Belts .....	1-20
Roadside	
Assistance Program .....	7-5
Rocking Your Vehicle to Get it Out .....	4-29
Running Your Engine While You Are Parked .....	2-35

## S

Safety Belt	
Reminder Light .....	3-38
Safety Belts	
Care of .....	5-104
Center Front Passenger Position .....	1-20
Driver Position .....	1-13

Safety Belts (cont.)	
How to Wear Safety Belts Properly .....	1-12
Questions and Answers About Safety Belts .....	1-12
Rear Safety Belt Comfort Guides for Children and Small Adults .....	1-25
Rear Seat Passengers .....	1-21
Right Front Passenger Position .....	1-20
Safety Belt Extender .....	1-27
Safety Belt Use During Pregnancy .....	1-19
Safety Belts Are for Everyone .....	1-7
Safety Warnings and Symbols .....	iii
Seats	
Head Restraints .....	1-7
Heated Seats .....	1-4
Manual .....	1-2
Manual Lumbar .....	1-3
Memory .....	2-46
Power Lumbar .....	1-3
Power Reclining Seatback .....	1-5
Power Seats .....	1-2
Reclining Seatbacks .....	1-4
Securing a Child Restraint	
Center Front Seat Position .....	1-44
Designed for the LATCH System .....	1-42
Rear Seat Position .....	1-42
Right Front Seat Position .....	1-45
Security Light .....	3-53
Selecting the Right Schedule, Maintenance .....	6-5

Service .....	5-3
Adding Equipment to the Outside of Your Vehicle .....	5-5
Doing Your Own Work .....	5-4
Engine Soon Light .....	3-48
Publications Ordering Information .....	7-11
Vehicle Soon Light .....	3-55
Servicing Your Airbag-Equipped Vehicle .....	1-56
Setting the Time .....	3-72
Sheet Metal Damage .....	5-108
Shifting Into Park (P) .....	2-31
Shifting Out of Park (P) .....	2-33
Short Trip/City Scheduled Maintenance .....	6-6
Signals, Turn and Lane-Change .....	3-8
Spare Tire	
Installing .....	5-95
Removing .....	5-94
Storing .....	5-100
Specifications, Capacities .....	5-121
Speedometer .....	3-37
Starting Your Engine .....	2-25
Steering .....	4-10
Steering, Suspension and Front Drive Axle Boot and Seal Inspection .....	6-23
Steering Wheel Controls, Audio .....	3-99
Steering Wheel, Tilt Wheel .....	3-6
Storage Areas	
Center Console Storage Area .....	2-45
Convenience Net .....	2-45

Storage Areas (cont.)	
Front Storage Area .....	2-45
Glove Box .....	2-44
Stuck in Sand, Mud, Ice or Snow .....	4-28
Sun Visors .....	2-19
Sunroof .....	2-45
Systems Monitor .....	3-58

## T

Tachometer .....	3-38
Taillamps	
Turn Signal, Stoplamps and Back-up Lamps ....	5-71
TCS Warning Light .....	3-43
Theater Dimming .....	3-18
Theft-Deterrent, Radio .....	3-99
Theft-Deterrent Systems .....	2-19
Content Theft-Deterrent .....	2-21
PASS-Key <sup>®</sup> III .....	2-21
PASS-Key <sup>®</sup> III Operation .....	2-22
Universal Theft-Deterrent .....	2-19
Throttle System Inspection .....	6-24
Tilt Wheel .....	3-6
Tire	
Pressure Light .....	3-47
Tires .....	5-74
Aluminum or Chrome-Plated Wheels, Cleaning .....	5-107
Buying New Tires .....	5-86



Vehicle Personalization	
DIC .....	3-64
Memory Seat and Mirrors .....	2-46
Ventilation Adjustment .....	3-32
Visors .....	2-19
Voltmeter Gage .....	3-40

## W

Warning Lights, Gages and Indicators .....	3-33
Warnings	
DIC Warnings and Messages .....	3-62
Hazard Warning Flashers .....	3-6
Other Warning Devices .....	3-6
Safety and Symbols .....	iii
Vehicle Damage .....	iv
Washer Fluid, Low Warning Light .....	3-54
Wheels	
Alignment and Tire Balance .....	5-89
Replacement .....	5-89
Where to Put the Restraint .....	1-37

Windows .....	2-17
Power .....	2-18
Windshield	
Wiper Blades, Cleaning .....	5-106
Windshield Washer	
Fluid .....	5-53
Windshield Wiper	
Blade Replacement .....	5-73
Fuses .....	5-111
Windshield Wiper Lever .....	3-9
Winter Driving .....	4-24
Wiper Activated Headlamps .....	3-14

## X

XM™ Satellite Radio Antenna System .....	3-103
--	-------

## Y

Your Vehicle and the Environment .....	6-2
--	-----