

2004 Pontiac Grand Prix Owner Manual

Seats and Restraint Systems	1-1	Driving Your Vehicle	4-1
Front Seats	1-2	Your Driving, the Road, and Your Vehicle	4-2
Rear Seats	1-8	Towing	4-33
Safety Belts	1-10	Service and Appearance Care	5-1
Child Restraints	1-29	Service	5-3
Air Bag Systems	1-48	Fuel	5-4
Restraint System Check	1-56	Checking Things Under the Hood	5-10
Features and Controls	2-1	Headlamp Aiming	5-56
Keys	2-2	Bulb Replacement	5-59
Doors and Locks	2-7	Windshield Wiper Blade Replacement	5-67
Windows	2-12	Tires	5-68
Theft-Deterrent Systems	2-14	Appearance Care	5-90
Starting and Operating Your Vehicle	2-18	Vehicle Identification	5-98
Mirrors	2-33	Electrical System	5-99
OnStar® System	2-35	Capacities and Specifications	5-104
Storage Areas	2-36	Normal Maintenance Replacement Parts	5-105
Sunroof	2-39	Maintenance Schedule	6-1
Instrument Panel	3-1	Maintenance Schedule	6-2
Instrument Panel Overview	3-2	Customer Assistance Information	7-1
Climate Controls	3-25	Customer Assistance Information	7-2
Warning Lights, Gages and Indicators	3-31	Reporting Safety Defects	7-9
Driver Information Center (DIC)	3-45	Index	1
Audio System(s)	3-88		



GENERAL MOTORS, GM, the GM Emblem, PONTIAC, the PONTIAC Emblem and the name GRAND PRIX are registered trademarks of General Motors Corporation.

This manual includes the latest information at the time it was printed. We reserve the right to make changes after that time without further notice. For vehicles first sold in Canada, substitute the name "General Motors of Canada Limited" for Pontiac Division whenever it appears in this manual.

Please keep this manual in your vehicle, so it will be there if you ever need it when you're on the road. If you sell the vehicle, please leave this manual in it so the new owner can use it.

Canadian Owners

You can obtain a French copy of this manual from your dealer or from:

Helm, Incorporated
P.O. Box 07130
Detroit, MI 48207

How to Use This Manual

Many people read their owner's manual from beginning to end when they first receive their new vehicle. If you do this, it will help you learn about the features and controls for your vehicle. In this manual, you'll find that pictures and words work together to explain things.

Index

A good place to look for what you need is the Index in back of the manual. It's an alphabetical list of what's in the manual, and the page number where you'll find it.

Safety Warnings and Symbols

You will find a number of safety cautions in this book. We use a box and the word CAUTION to tell you about things that could hurt you if you were to ignore the warning.

 **CAUTION:**

These mean there is something that could hurt you or other people.

In the caution area, we tell you what the hazard is. Then we tell you what to do to help avoid or reduce the hazard. Please read these cautions. If you don't, you or others could be hurt.

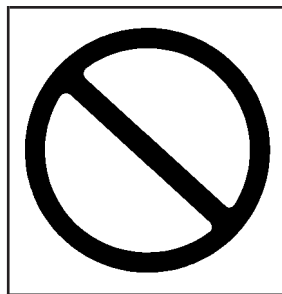

You will also find a circle with a slash through it in this book. This safety symbol means “Don’t,” “Don’t do this” or “Don’t let this happen.”

Vehicle Damage Warnings

Also, in this book you will find these notices:

Notice: These mean there is something that could damage your vehicle.

A notice will tell you about something that can damage your vehicle. Many times, this damage would not be covered by your warranty, and it could be costly. But the notice will tell you what to do to help avoid the damage.

When you read other manuals, you might see CAUTION and NOTICE warnings in different colors or in different words.

You'll also see warning labels on your vehicle. They use the same words, CAUTION or NOTICE.

































Vehicle Symbols

Your vehicle has components and labels that use symbols instead of text. Symbols, used on your vehicle, are shown along with the text describing the operation or information relating to a specific component, control, message, gage or indicator.

If you need help figuring out a specific name of a component, gage or indicator, reference the following topics:

- Seats and Restraint Systems in Section 1
- Features and Controls in Section 2
- Instrument Panel Overview in Section 3
- Climate Controls in Section 3
- Warning Lights, Gages and Indicators in Section 3
- Audio System(s) in Section 3
- Engine Compartment Overview in Section 5

These are some examples of vehicle symbols you may find on your vehicle:

<p>CAUTION POSSIBLE INJURY</p> 	<p>LATCH BOTH LAP AND SHOULDER BELTS TO PROTECT OCCUPANT DO NOT TWIST SAFETY BELT WHEN ATTACHING</p>  	<p>MASTER LIGHTING SWITCH</p> 	<p>ENGINE COOLANT TEMP</p> 	<p>FUSE BOX ACCESS</p> 	
<p>PROTECT EYES BY SHIELDING</p> 	<p>FASTEN SEAT BELTS</p> 	<p>AIR BAG</p> 	<p>TURN SIGNALS</p> 	<p>BATTERY CHARGING SYSTEM</p> 	<p>ENGINE COOLANT FAN</p> 
<p>CAUSTIC BATTERY ACID COULD CAUSE BURNS</p> 	<p>MOVE SEAT FULLY REARWARD SECURE CHILD SEAT</p> 	<p>DO NOT INSTALL A REAR-FACING CHILD RESTRAINT IN THIS SEATING POSITION</p> 	<p>PARKING LAMPS</p> 	<p>HAZARD WARNING FLASHER</p> 	<p>FUEL</p> 
<p>AVOID SPARKS OR FLAMES</p> 	<p>PULL BELT OUT COMPLETELY THEN SECURE CHILD SEAT</p> 	<p>DO NOT INSTALL A FORWARD-FACING CHILD RESTRAINT IN THIS SEATING POSITION</p> 	<p>HAZARD WARNING FLASHER</p> 	<p>COOLANT</p> 	<p>OWNER'S MANUAL</p> 
<p>SPARK OR FLAME COULD EXPLODE BATTERY</p> 	<p>POWER WINDOW</p> 	<p>DOOR LOCK UNLOCK</p> 	<p>DAYTIME RUNNING LAMPS</p> 	<p>ENGINE OIL PRESSURE</p> 	<p>SERVICE</p> 
			<p>FOG LAMPS</p> 	<p>ANTI-LOCK BRAKES</p> 	<p>SERVICE MANUAL</p> 

 **NOTES**

Section 1 Seats and Restraint Systems

Front Seats	1-2	Child Restraint Systems	1-35
Manual Seats	1-2	Where to Put the Restraint	1-38
Power Seat	1-4	Top Strap	1-39
Power Lumbar	1-5	Top Strap Anchor Location	1-40
Heated Seats	1-5	Lower Anchorages and Top Tethers for Children (LATCH System)	1-41
Reclining Seatbacks	1-6	Securing a Child Restraint Designed for the LATCH System	1-43
Head Restraints	1-7	Securing a Child Restraint in a Rear Seat Position	1-43
Rear Seats	1-8	Securing a Child Restraint in the Right Front Seat Position	1-45
Split Folding Rear Seat	1-8	Air Bag Systems	1-48
Safety Belts	1-10	Where Are the Air Bags?	1-50
Safety Belts: They Are for Everyone	1-10	When Should an Air Bag Inflate?	1-53
Questions and Answers About Safety Belts	1-14	What Makes an Air Bag Inflate?	1-53
How to Wear Safety Belts Properly	1-15	How Does an Air Bag Restrain?	1-54
Driver Position	1-15	What Will You See After an Air Bag Inflates?	1-54
Safety Belt Use During Pregnancy	1-22	Servicing Your Air Bag-Equipped Vehicle	1-56
Right Front Passenger Position	1-23	Restraint System Check	1-56
Rear Seat Passengers	1-23	Checking Your Restraint Systems	1-56
Rear Safety Belt Comfort Guides for Children and Small Adults	1-26	Replacing Restraint System Parts After a Crash	1-57
Safety Belt Pretensioners	1-28		
Safety Belt Extender	1-28		
Child Restraints	1-29		
Older Children	1-29		
Infants and Young Children	1-32		

Front Seats

Manual Seats

CAUTION:

You can lose control of the vehicle if you try to adjust a manual driver's seat while the vehicle is moving. The sudden movement could startle and confuse you, or make you push a pedal when you don't want to. Adjust the driver's seat only when the vehicle is not moving.



Lift the bar located under the front seat cushion to unlock the seat. Slide the seat to where you want it and release the bar. Try to move the seat back and forth to make sure it is locked in place.

Fold-Flat Front Passenger Seat

CAUTION:

If you fold the seatback forward to carry longer objects, such as skis, be sure any such cargo is not near an air bag. In a crash, an inflating air bag might force that object toward a person. This could cause severe injury or even death. Secure objects away from the area in which an air bag would inflate. For more information, see “Where Are the Air Bags?” and “Loading Your Vehicle,” in the Index.

If the vehicle has this feature, the front passenger seat can be folded flat for more cargo space. Used with the split folding rear seat, optimum cargo space is gained for long, flat items. See *Split Folding Rear Seat on page 1-8* later in this section for more information.



Pull up on the lever located in the middle of the seatback, lift up on the seatback, and push it forward.

To return the seat to normal use, raise the seatback to the upright position. Push and pull on the seatback to make sure it is locked.

Power Seat

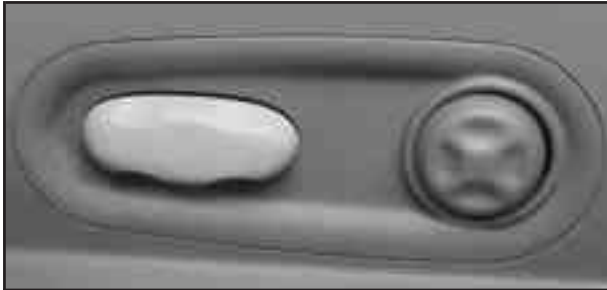

If your vehicle has this feature, the control is located on the outboard side of the driver's seat.

To adjust the seat do the following:

- Move the seat forward or rearward by sliding the control toward the front or rear of the vehicle.
- Raise or lower the seat cushion by sliding the control up or down.
- Raise or lower the front portion of the seat by sliding the front part of the control up or down.
- Raise or lower the rear portion of the seat by sliding the rear part of the control up or down.

Power Lumbar

If your vehicle has this feature, the power lumbar control lets you adjust the amount of support in the lower seatback.



The four-way control is located on the outboard side of the driver's seat cushion.

To increase or decrease lumbar support, press and hold the front or rear of the control. Release the control when the lower seatback reaches the desired level of support.

You can also raise and lower the lumbar support on the lower seatback by pressing and holding the top or bottom of the control.

Heated Seats



If your vehicle is equipped with this feature, the buttons to activate the heat on each front seat cushion are located on the climate control panel.

The button for the driver's seat is located on the bottom left side of the climate control panel. The button for the passenger's seat is on the bottom right of the climate control panel.

Push the button once to activate a high heat setting. Both indicator lights next to the button will come on. Push the button again to select a lower temperature setting. Only the bottom indicator light will come on. Press the button a third time to turn the heat off.

This feature only works when the ignition is turned on.

Reclining Seatbacks

The recliner levers for the driver's and passenger's front seatbacks are located on the outboard side of each front seat cushion.



Lift the lever to release the seatback, then move the seatback to where you want it. Release the lever to lock the seatback in place. Pull up on the lever without pushing on the seatback, and the seatback will return to an upright position.



But don't have a seatback reclined if your vehicle is moving.

⚠ CAUTION:

Sitting in a reclined position when your vehicle is in motion can be dangerous. Even if you buckle up, your safety belts can't do their job when you're reclined like this.

The shoulder belt can't do its job because it won't be against your body. Instead, it will be in front of you. In a crash you could go into it, receiving neck or other injuries.

The lap belt can't do its job either. In a crash the belt could go up over your abdomen. The belt forces would be there, not at your pelvic bones. This could cause serious internal injuries.

For proper protection when the vehicle is in motion, have the seatback upright. Then sit well back in the seat and wear your safety belt properly.

Head Restraints



Slide the head restraint up or down so that the top of the restraint is closest to the top of your head. This position reduces the chance of a neck injury in a crash.

Rear Seats

Split Folding Rear Seat

You can fold either side or both sides of the seatback down in your vehicle for more cargo space. Make sure the front seat isn't reclined. If it is, the rear seatback may not fold down all the way.

To lower the rear seatback, follow these steps:



1. Remove the rear center lap-shoulder belt latch by using a pointed object to press the release button.



1. Pull forward on the seatback tab located on the outboard side of the rear seat cushion to fold the seatback down.

This will allow you direct access to the trunk.

⚠ CAUTION:

If the seatback isn't locked, it could move forward in a sudden stop or crash. That could cause injury to the person sitting there. Always press rearward on the seatback to be sure it is locked.

⚠ CAUTION:

A safety belt that is improperly routed, not properly attached, or twisted won't provide the protection needed in a crash. The person wearing the belt could be seriously injured. After raising the rear seatback, always check to be sure that the safety belts are properly routed and attached, and are not twisted.

To raise the rear seatback, follow these steps:

1. Raise the seatback up and make sure it latches. Push and pull on the seatback to be sure it is locked in position.
2. Reconnect the center safety belt latch plate to the buckle.



Make sure the safety belt label is pointing to the release button, and that both are facing the front of the vehicle. Make sure the belt is not twisted. Push and pull on the latch plate to be sure it is secure.

When the seat is not in use, the seatback should be kept in the upright, locked position.

Safety Belts

Safety Belts: They Are for Everyone

This part of the manual tells you how to use safety belts properly. It also tells you some things you should not do with safety belts.

CAUTION:

Don't let anyone ride where he or she can't wear a safety belt properly. If you are in a crash and you're not wearing a safety belt, your injuries can be much worse. You can hit things inside the vehicle or be ejected from it. You can be seriously injured or killed. In the same crash, you might not be, if you are buckled up. Always fasten your safety belt, and check that your passengers' belts are fastened properly too.

CAUTION:

It is extremely dangerous to ride in a cargo area, inside or outside of a vehicle. In a collision, people riding in these areas are more likely to be seriously injured or killed. Do not allow people to ride in any area of your vehicle that is not equipped with seats and safety belts. Be sure everyone in your vehicle is in a seat and using a safety belt properly.



Your vehicle has a light that comes on as a reminder to buckle up. See *Safety Belt Reminder Light* on page 3-34.

In most states and in all Canadian provinces, the law says to wear safety belts. Here's why: *They work.*

You never know if you'll be in a crash. If you do have a crash, you don't know if it will be a bad one.

A few crashes are mild, and some crashes can be so serious that even buckled up, a person wouldn't survive. But most crashes are in between. In many of them, people who buckle up can survive and sometimes walk away. Without belts they could have been badly hurt or killed.

After more than 30 years of safety belts in vehicles, the facts are clear. In most crashes buckling up does matter... a lot!

Why Safety Belts Work

When you ride in or on anything, you go as fast as it goes.

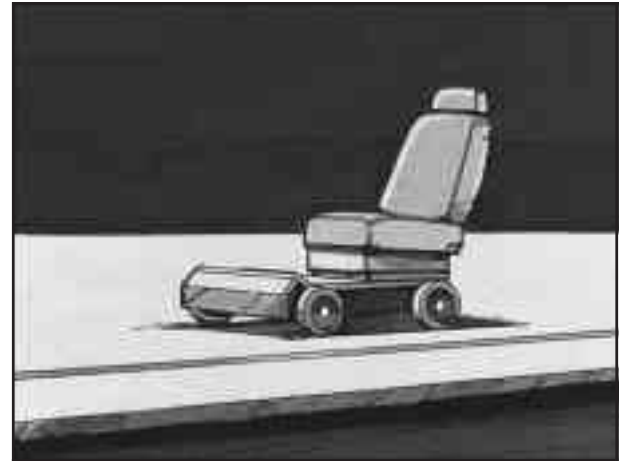

Take the simplest vehicle. Suppose it's just a seat on wheels.

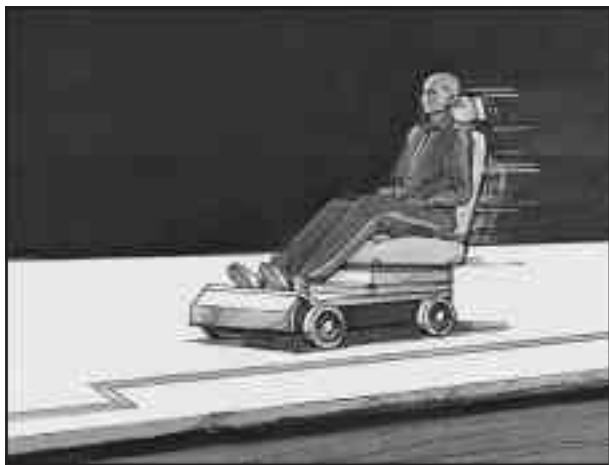

Put someone on it.

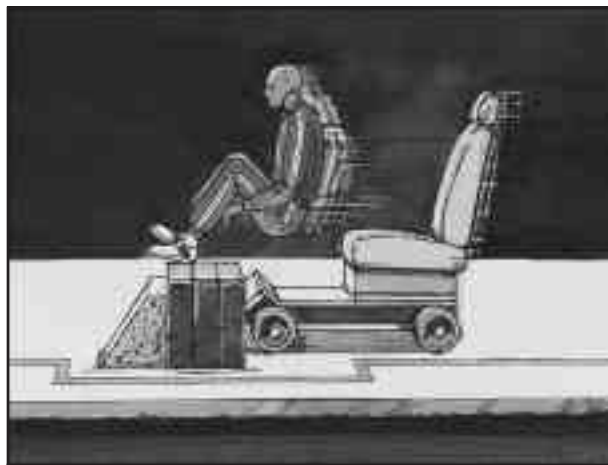

Get it up to speed. Then stop the vehicle. The rider doesn't stop.



The person keeps going until stopped by something.
In a real vehicle, it could be the windshield...



or the instrument panel...



or the safety belts!

With safety belts, you slow down as the vehicle does. You get more time to stop. You stop over more distance, and your strongest bones take the forces. That's why safety belts make such good sense.

Questions and Answers About Safety Belts

Q: Won't I be trapped in the vehicle after an accident if I'm wearing a safety belt?

A: You *could* be – whether you're wearing a safety belt or not. But you can unbuckle a safety belt, even if you're upside down. And your chance of being conscious during and after an accident, so you *can* unbuckle and get out, is *much* greater if you are belted.

Q: If my vehicle has air bags, why should I have to wear safety belts?

A: Air bags are in many vehicles today and will be in most of them in the future. But they are supplemental systems only; so they work *with* safety belts – not instead of them. Every air bag system ever offered for sale has required the use of safety belts. Even if you're in a vehicle that has air bags, you still have to buckle up to get the most protection. That's true not only in frontal collisions, but especially in side and other collisions.

Q: If I'm a good driver, and I never drive far from home, why should I wear safety belts?

A: You may be an excellent driver, but if you're in an accident – even one that isn't your fault – you and your passengers can be hurt. Being a good driver doesn't protect you from things beyond your control, such as bad drivers.

Most accidents occur within 25 miles (40 km) of home. And the greatest number of serious injuries and deaths occur at speeds of less than 40 mph (65 km/h).

Safety belts are for everyone.

How to Wear Safety Belts Properly

This part is only for people of adult size.

Be aware that there are special things to know about safety belts and children. And there are different rules for smaller children and babies. If a child will be riding in your vehicle, see *Older Children on page 1-29* or *Infants and Young Children on page 1-32*. Follow those rules for everyone's protection.

First, you'll want to know which restraint systems your vehicle has.

We'll start with the driver position.

Driver Position

This part describes the driver's restraint system.

Lap-Shoulder Belt

The driver has a lap-shoulder belt. Here's how to wear it properly.

1. Close and lock the door.
2. Adjust the seat so you can sit up straight. To see how, see "Seats" in the Index.



Make sure the release button on the buckle is positioned so you would be able to unbuckle the safety belt quickly if you ever had to.



3. Pick up the latch plate and pull the belt across you. Don't let it get twisted.

The shoulder belt may lock if you pull the belt across you very quickly. If this happens, let the belt go back slightly to unlock it. Then pull the belt across you more slowly.

4. Push the latch plate into the buckle until it clicks. Pull up on the latch plate to make sure it is secure. If the belt isn't long enough, see *Safety Belt Extender on page 1-28*.

5. To make the lap part tight, pull down on the buckle end of the belt as you pull up on the shoulder belt.

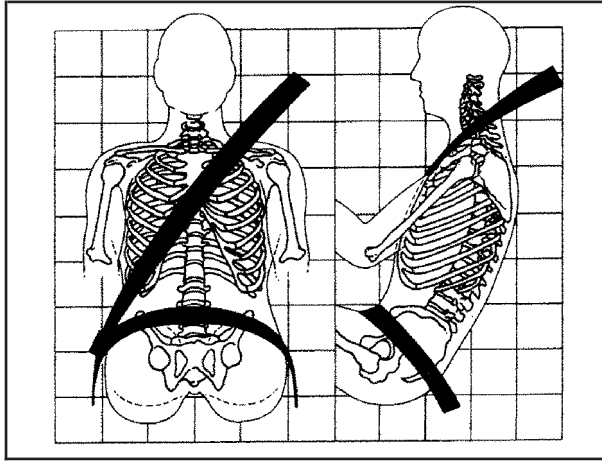

The lap part of the belt should be worn low and snug on the hips, just touching the thighs. In a crash, this applies force to the strong pelvic bones. And you'd be less likely to slide under the lap belt. If you slid under it, the belt would apply force at your abdomen. This could cause serious or even fatal injuries. The shoulder belt should go over the shoulder and across the chest. These parts of the body are best able to take belt restraining forces.

The safety belt locks if there's a sudden stop or crash, or if you pull the belt very quickly out of the retractor.

Shoulder Belt Height Adjuster

Before you begin to drive, move the shoulder belt adjuster to the height that is right for you.



To move it down, pull the release button out as shown and move the height adjuster to the desired position.

You can move the adjuster up just by pushing up on the shoulder belt guide. After you move the adjuster to where you want it, try to move it down without pulling the release button to make sure it has locked into position.

Adjust the height so that the shoulder portion of the belt is centered on your shoulder. The belt should be away from your face and neck, but not falling off your shoulder.

Q: What's wrong with this?

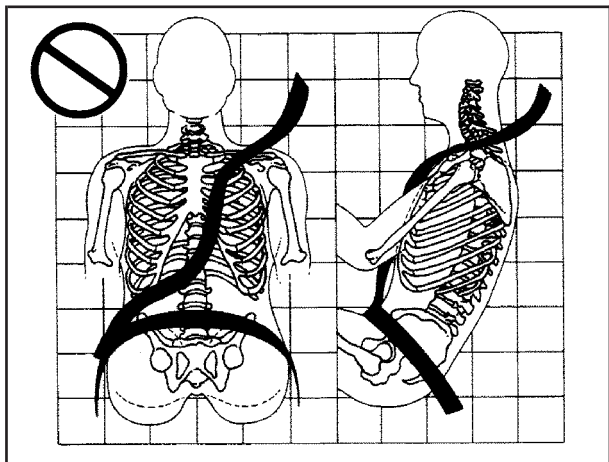

A: The shoulder belt is too loose. It won't give nearly as much protection this way.

⚠ CAUTION:

You can be seriously hurt if your shoulder belt is too loose. In a crash, you would move forward too much, which could increase injury. The shoulder belt should fit against your body.

Q: What's wrong with this?

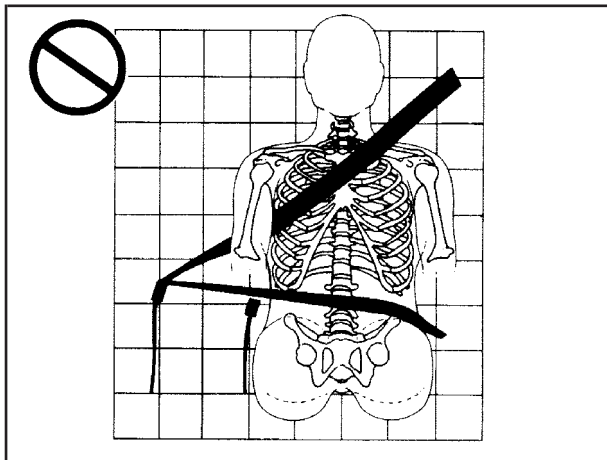

A: The belt is buckled in the wrong place.

⚠ CAUTION:

You can be seriously injured if your belt is buckled in the wrong place like this. In a crash, the belt would go up over your abdomen. The belt forces would be there, not at the pelvic bones. This could cause serious internal injuries. Always buckle your belt into the buckle nearest you.

Q: What's wrong with this?

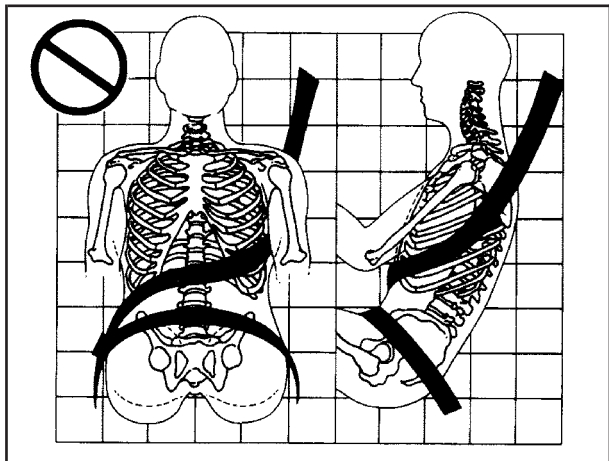

A: The shoulder belt is worn under the arm. It should be worn over the shoulder at all times.

⚠ CAUTION:

You can be seriously injured if you wear the shoulder belt under your arm. In a crash, your body would move too far forward, which would increase the chance of head and neck injury. Also, the belt would apply too much force to the ribs, which aren't as strong as shoulder bones. You could also severely injure internal organs like your liver or spleen.

Q: What's wrong with this?

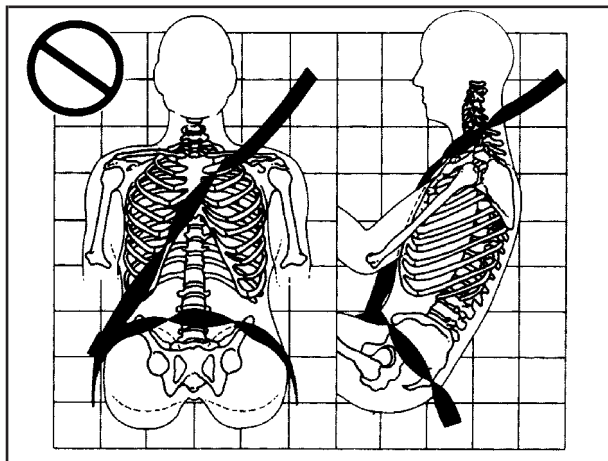

A: The belt is twisted across the body.

⚠ CAUTION:

You can be seriously injured by a twisted belt. In a crash, you wouldn't have the full width of the belt to spread impact forces. If a belt is twisted, make it straight so it can work properly, or ask your dealer to fix it.



To unlatch the belt, just push the button on the buckle. The belt should go back out of the way.

Before you close the door, be sure the belt is out of the way. If you slam the door on it, you can damage both the belt and your vehicle.

Safety Belt Use During Pregnancy

Safety belts work for everyone, including pregnant women. Like all occupants, they are more likely to be seriously injured if they don't wear safety belts.

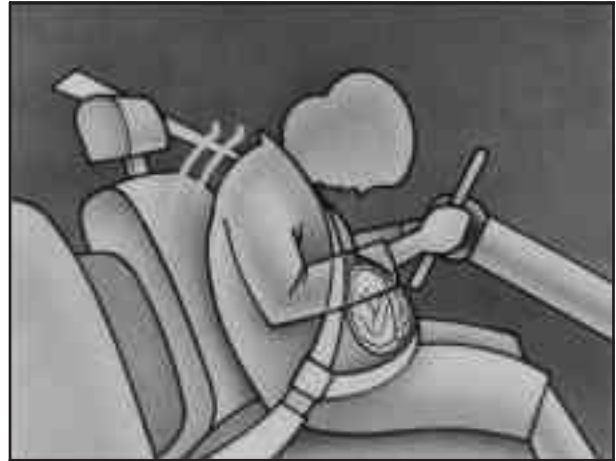

A pregnant woman should wear a lap-shoulder belt, and the lap portion should be worn as low as possible, below the rounding, throughout the pregnancy.

The best way to protect the fetus is to protect the mother. When a safety belt is worn properly, it's more likely that the fetus won't be hurt in a crash. For pregnant women, as for anyone, the key to making safety belts effective is wearing them properly.

Right Front Passenger Position

To learn how to wear the right front passenger's safety belt properly, see *Driver Position on page 1-15*.

The right front passenger's safety belt works the same way as the driver's safety belt — except for one thing. If you ever pull the shoulder portion of the belt out all the way, you will engage the child restraint locking feature. If this happens, just let the belt go back all the way and start again.

Rear Seat Passengers

It's very important for rear seat passengers to buckle up! Accident statistics show that unbelted people in the rear seat are hurt more often in crashes than those who are wearing safety belts.

Rear passengers who aren't safety belted can be thrown out of the vehicle in a crash. And they can strike others in the vehicle who are wearing safety belts.

Rear Seat Passenger Positions

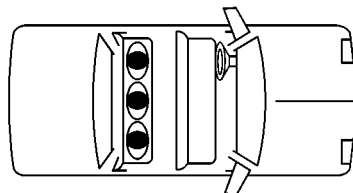

Lap-Shoulder Belt

All rear seat positions have lap-shoulder belts. Here's how to wear one properly.



1. Pick up the latch plate and pull the belt across you. Don't let it get twisted.

The shoulder belt may lock if you pull the belt across you very quickly. If this happens, let the belt go back slightly to unlock it. Then pull the belt across you more slowly.

2. Push the latch plate into the buckle until it clicks. Pull up on the latch plate to make sure it is secure. When the shoulder belt is pulled out all the way, it will lock. If it does, let it go back all the way and start again. If the belt is not long enough, see *Safety Belt Extender on page 1-28*. Make sure the release button on the buckle is positioned so you would be able to unbuckle the safety belt quickly if you ever had to.



3. To make the lap part tight, pull down on the buckle end of the belt as you pull up on the shoulder part.

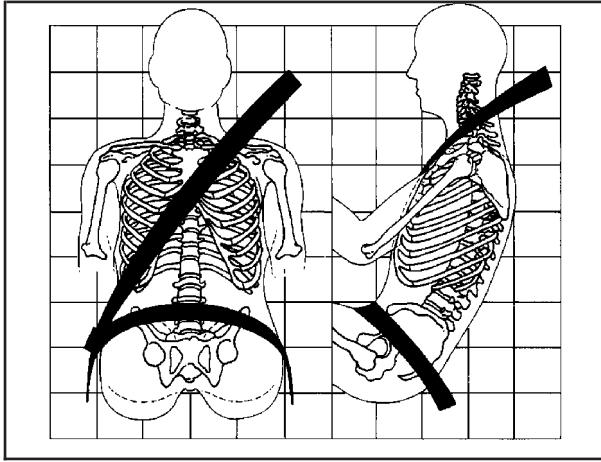

The lap part of the belt should be worn low and snug on the hips, just touching the thighs. In a crash this applies force to the strong pelvic bones. And you'd be less likely to slide under the lap belt. If you slid under it, the belt would apply force at your abdomen. This could cause serious or even fatal injuries. The shoulder belt should go over the shoulder and across the chest. These parts of the body are best able to take belt restraining forces.

The safety belt locks if there's a sudden stop or a crash, or if you pull the belt very quickly out of the retractor.

CAUTION:

You can be seriously hurt if your shoulder belt is too loose. In a crash, you would move forward too much, which could increase injury. The shoulder belt should fit against your body.



To unlatch the belt, just push the button on the buckle.

Rear Safety Belt Comfort Guides for Children and Small Adults

Rear shoulder belt comfort guides will provide added safety belt comfort for older children who have outgrown booster seats and for small adults. When installed on a shoulder belt, the comfort guide better positions the belt away from the neck and head.

There is one guide for each outside passenger position in the rear seat. To provide added safety belt comfort for children who have outgrown child restraints and booster seats and for smaller adults, the comfort guides may be installed on the shoulder belts. Here's how to install a comfort guide and use the safety belt:



1. Pull the elastic cord out from between the edge of the seatback and the interior body to remove the guide from its storage clip.



2. Slide the guide under and past the belt. The elastic cord must be under the belt. Then, place the guide over the belt, and insert the two edges of the belt into the slots of the guide.

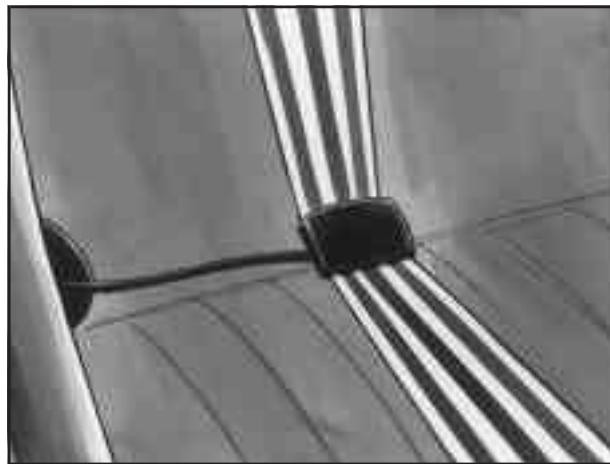

3. Be sure that the belt is not twisted and it lies flat. The elastic cord must be under the belt and the guide on top.



Safety Belt Pretensioners

Your vehicle has safety belt pretensioners. You'll find them on the buckle end of the safety belts for the driver and right front passenger. They help the safety belts reduce a person's forward movement in a moderate to severe crash in which the front of the vehicle hits something.

Pretensioners work only once. If they activate in a crash, you'll need to get new ones, and probably other new parts for your safety belt system. See *Replacing Restraint System Parts After a Crash* on page 1-57.

Safety Belt Extender

If the vehicle's safety belt will fasten around you, you should use it.

But if a safety belt isn't long enough to fasten, your dealer will order you an extender. It's free. When you go in to order it, take the heaviest coat you will wear, so the extender will be long enough for you. The extender will be just for you, and just for the seat in your vehicle that you choose. Don't let someone else use it, and use it only for the seat it is made to fit. To wear it, just attach it to the regular safety belt.

4. Buckle, position and release the safety belt as described in *Rear Seat Passengers* on page 1-23. Make sure that the shoulder belt crosses the shoulder.

To remove and store the comfort guides, squeeze the belt edges together so that you can take them out of the guides. Pull the guide upward to expose its storage clip, and then slide the guide onto the clip. Turn the guide and clip inward and in between the seatback and the interior body, leaving only the loop of the elastic cord exposed.

Child Restraints

Older Children



Older children who have outgrown booster seats should wear the vehicle's safety belts.

Q: What is the proper way to wear safety belts?

A: If possible, an older child should wear a lap-shoulder belt and get the additional restraint a shoulder belt can provide. The shoulder belt should not cross the face or neck. The lap belt should fit snugly below the hips, just touching the top of the thighs. It should never be worn over the abdomen, which could cause severe or even fatal internal injuries in a crash.

Accident statistics show that children are safer if they are restrained in the rear seat.

In a crash, children who are not buckled up can strike other people who are buckled up, or can be thrown out of the vehicle. Older children need to use safety belts properly.



⚠ CAUTION:

Never do this.

Here two children are wearing the same belt. The belt can't properly spread the impact forces. In a crash, the two children can be crushed together and seriously injured. A belt must be used by only one person at a time.

Q: What if a child is wearing a lap-shoulder belt, but the child is so small that the shoulder belt is very close to the child's face or neck?

A: Move the child toward the center of the vehicle, but be sure that the shoulder belt still is on the child's shoulder, so that in a crash the child's upper body would have the restraint that belts provide. If the child is sitting in a rear seat outside position, see *Rear Safety Belt Comfort Guides for Children and Small Adults* on page 1-26.



⚠ CAUTION:

Never do this.

Here a child is sitting in a seat that has a lap-shoulder belt, but the shoulder part is behind the child. If the child wears the belt in this way, in a crash the child might slide under the belt. The belt's force would then be applied right on the child's abdomen. That could cause serious or fatal injuries.

The lap portion of the belt should be worn low and snug on the hips, just touching the child's thighs. This applies belt force to the child's pelvic bones in a crash.

Infants and Young Children

Everyone in a vehicle needs protection! This includes infants and all other children. Neither the distance traveled nor the age and size of the traveler changes the need, for everyone, to use safety restraints. In fact, the law in every state in the United States and in every Canadian province says children up to some age must be restrained while in a vehicle.

Every time infants and young children ride in vehicles, they should have the protection provided by appropriate restraints. Young children should not use the vehicle's adult safety belts alone, unless there is no other choice. Instead, they need to use a child restraint.



CAUTION:

People should never hold a baby in their arms while riding in a vehicle. A baby doesn't weigh much -- until a crash. During a crash a baby will become so heavy it is not possible to hold

CAUTION: (Continued)

CAUTION: (Continued)

it. For example, in a crash at only 25 mph (40 km/h), a 12-lb. (5.5 kg) baby will suddenly become a 240-lb. (110 kg) force on a person's arms. A baby should be secured in an appropriate restraint.



⚠ CAUTION:

Children who are up against, or very close to, any air bag when it inflates can be seriously injured or killed. Air bags plus lap-shoulder belts offer outstanding protection for adults and older children, but not for young children and infants. Neither the vehicle's safety belt system nor its air bag system is designed for them. Young children and infants need the protection that a child restraint system can provide.

Q: What are the different types of add-on child restraints?

A: Add-on child restraints, which are purchased by the vehicle's owner, are available in four basic types. Selection of a particular restraint should take into consideration not only the child's weight, height, and age but also whether or not the restraint will be compatible with the motor vehicle in which it will be used.

For most basic types of child restraints, there are many different models available. When purchasing a child restraint, be sure it is designed to be used in a motor vehicle. If it is, the restraint will have a label saying that it meets federal motor vehicle safety standards.

The restraint manufacturer's instructions that come with the restraint state the weight and height limitations for a particular child restraint. In addition, there are many kinds of restraints available for children with special needs.

 **CAUTION:**

Newborn infants need complete support, including support for the head and neck. This is necessary because a newborn infant's neck is weak and its head weighs so much compared with the rest of its body. In a crash, an infant in a rear-facing seat settles into the restraint, so the crash forces can be distributed across the strongest part of an infant's body, the back and shoulders. Infants always should be secured in appropriate infant restraints.

⚠ CAUTION:

The body structure of a young child is quite unlike that of an adult or older child, for whom the safety belts are designed. A young child's hip bones are still so small that the vehicle's regular safety belt may not remain low on the hip bones, as it should. Instead, it may settle up around the child's abdomen. In a crash, the belt would apply force on a body area that's unprotected by any bony structure. This alone could cause serious or fatal injuries. Young children always should be secured in appropriate child restraints.

Child Restraint Systems

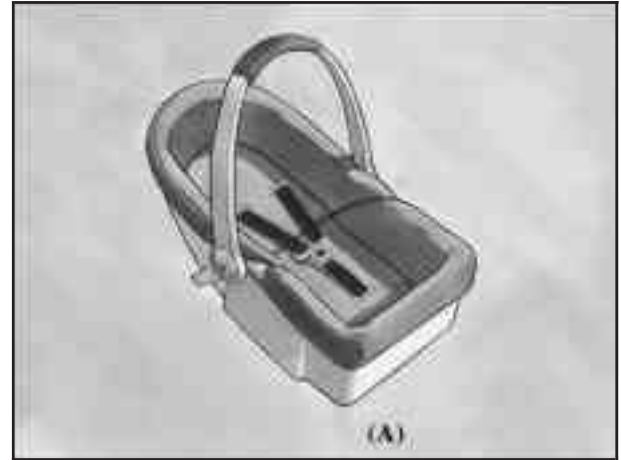

An infant car bed (A), a special bed made for use in a motor vehicle, is an infant restraint system designed to restrain or position a child on a continuous flat surface. Make sure that the infant's head rests toward the center of the vehicle.

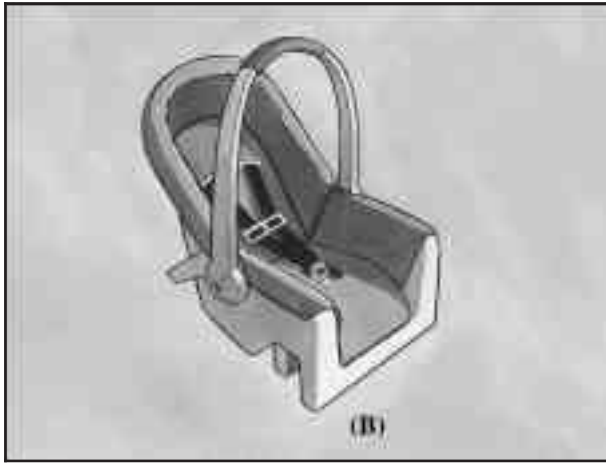

A rear-facing infant seat (B) provides restraint with the seating surface against the back of the infant. The harness system holds the infant in place and, in a crash, acts to keep the infant positioned in the restraint.

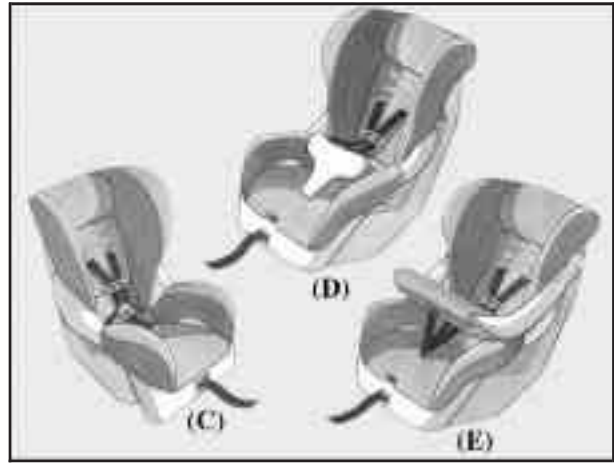

A forward-facing child seat (C-E) provides restraint for the child's body with the harness and also sometimes with surfaces such as T-shaped or shelf-like shields.

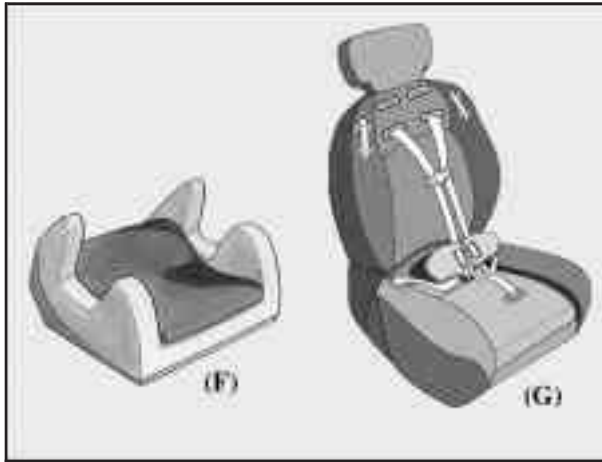

A booster seat (F-G) is a child restraint designed to improve the fit of the vehicle's safety belt system. Some booster seats have a shoulder belt positioner, and some high-back booster seats have a five-point harness. A booster seat can also help a child to see out the window.

Q: How do child restraints work?

A: A child restraint system is any device designed for use in a motor vehicle to restrain, seat, or position children. A built-in child restraint system is a permanent part of the motor vehicle. An add-on child restraint system is a portable one, which is purchased by the vehicle's owner.

For many years, add-on child restraints have used the adult belt system in the vehicle. To help reduce the chance of injury, the child also has to be secured within the restraint. The vehicle's belt system secures the add-on child restraint in the vehicle, and the add-on child restraint's harness system holds the child in place within the restraint.

One system, the three-point harness, has straps that come down over each of the infant's shoulders and buckle together at the crotch. The five-point harness system has two shoulder straps, two hip straps and a crotch strap. A shield may take the place of hip straps. A T-shaped shield has shoulder straps that are attached to a flat pad which rests low against the child's body. A shelf- or armrest-type shield has straps that are attached to a wide, shelf-like shield that swings up or to the side.

When choosing a child restraint, be sure the child restraint is designed to be used in a vehicle. If it is, it will have a label saying that it meets federal motor vehicle safety standards.

Then follow the instructions for the restraint. You may find these instructions on the restraint itself or in a booklet, or both. These restraints use the belt system in your vehicle, but the child also has to be secured within the restraint to help reduce the chance of personal injury. When securing an add-on child restraint, refer to the instructions that come with the restraint which may be on the restraint itself or in a booklet, or both, and to this manual. The child restraint instructions are important, so if they are not available, obtain a replacement copy from the manufacturer.

Where to Put the Restraint

Accident statistics show that children are safer if they are restrained in the rear rather than the front seat. We, therefore, recommend that child restraints be secured in a rear seat, including an infant riding in a rear-facing infant seat, a child riding in a forward-facing child seat and an older child riding in a booster seat. *Never* put a rear-facing child restraint in the front passenger seat. Here's why:

CAUTION:

A child in a rear-facing child restraint can be seriously injured or killed if the right front passenger's air bag inflates. This is because the back of the rear-facing child restraint would be very close to the inflating air bag. Always secure a rear-facing child restraint in a rear seat.

You may secure a forward-facing child restraint in the right front seat, but before you do, always move the front passenger seat as far back as it will go. It's better to secure the child restraint in a rear seat.

Wherever you install it, be sure to secure the child restraint properly.

Keep in mind that an unsecured child restraint can move around in a collision or sudden stop and injure people in the vehicle. Be sure to properly secure any child restraint in your vehicle – even when no child is in it.

Top Strap

Some child restraints have a top strap, or “top tether”. It can help restrain the child restraint during a collision. For it to work, a top strap must be properly anchored to the vehicle. Some top strap-equipped child restraints are designed for use with or without the top strap being anchored. Others require the top strap always to be anchored. Be sure to read and follow the instructions for your child restraint. If yours requires that the top strap be anchored, don’t use the restraint unless it is anchored properly.

If the child restraint does not have a top strap, one can be obtained, in kit form, for many child restraints. Ask the child restraint manufacturer whether or not a kit is available.

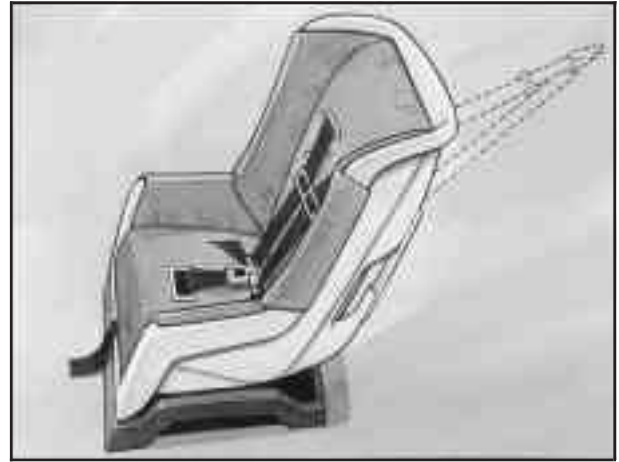

In Canada, the law requires that forward-facing child restraints have a top strap, and that the strap be anchored. In the United States, some child restraints also have a top strap. If your child restraint has a top strap, it should be anchored.

Anchor the top strap to an anchor point specified in *Top Strap Anchor Location* on page 1-40. Be sure to use an anchor point located on the same side of the vehicle as the seating position where the child restraint will be placed.

Once you have the top strap anchored, you'll be ready to secure the child restraint itself. Tighten the top strap when and as the child restraint manufacturer's instructions say.

Top Strap Anchor Location

Your vehicle has top strap anchors already installed for the rear seating positions.

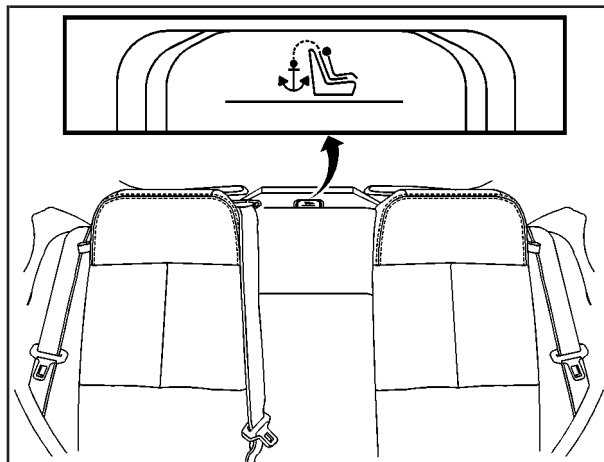

You'll find them behind the rear seat on the filler panel. You'll need to open the covers to access the anchors.

Lower Anchorages and Top Tethers for Children (LATCH System)

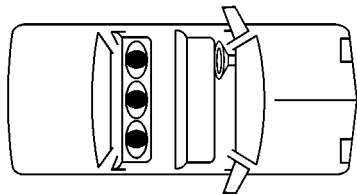

Your vehicle has the LATCH system. You'll find anchors (A) in all three rear seating positions.



Each seating position with the LATCH system will have the LATCH symbol on the seatbacks above the anchors.

In order to use the system, you need either a forward-facing child restraint that has attaching points (B) at its base and a top tether anchor (C), or a rear-facing child restraint that has attaching points (B), as shown here.

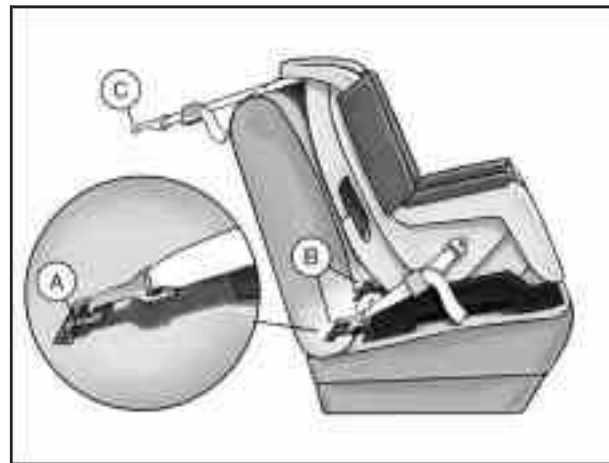

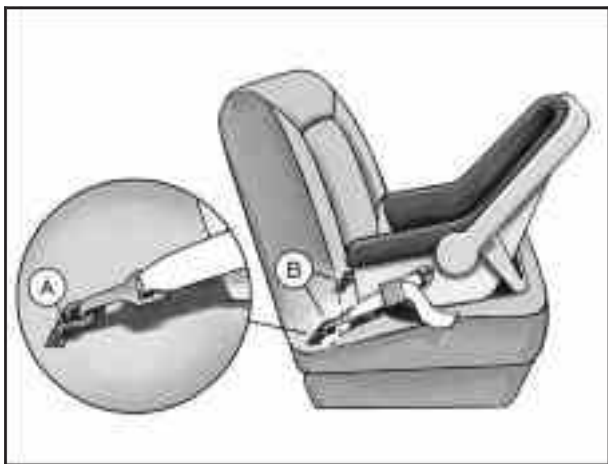

With this system, use the LATCH system instead of the vehicle's safety belts to secure a child restraint.

⚠ CAUTION:

If a LATCH-type child restraint isn't attached to its anchorage points, the restraint won't be able to protect the child correctly. In a crash, the child could be seriously injured or killed. Make sure that a LATCH-type child restraint is properly installed using the anchorage points, or use the vehicle's safety belts to secure the restraint. See "Securing a Child Restraint Designed for the LATCH System" or "Securing a Child Restraint in a Rear Seat Position" in the Index for information on how to secure a child restraint in your vehicle.

Securing a Child Restraint Designed for the LATCH System

1. Find the anchors for the seating position you want to use, where the bottom of the seatback meets the back of the seat cushion.
2. Put the child restraint on the seat.
3. Attach the anchor points on the child restraint to the anchors in the vehicle. The child restraint instructions will show you how.
4. If the child restraint is forward-facing, attach the top strap to the top strap anchor. See *Top Strap on page 1-39*. Tighten the top strap according to the child restraint instructions.
5. Push and pull the child restraint in different directions to be sure it is secure.

To remove the child restraint, simply unhook the top strap from the top tether anchor and then disconnect the anchor points.

Securing a Child Restraint in a Rear Seat Position

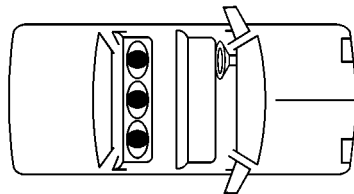

If your child restraint is equipped with the LATCH system, see *Lower Anchorages and Top Tethers for Children (LATCH System) on page 1-41*. See *Top Strap on page 1-39* if the child restraint has one.

If your child restraint does not have the LATCH system, you'll be using the lap-shoulder belt to secure the child restraint in this position. Be sure to follow the instructions that came with the child restraint. Secure the child in the child restraint when and as the instructions say.

1. Put the restraint on the seat.
2. Pick up the latch plate, and run the lap and shoulder portions of the vehicle's safety belt through or around the restraint. The child restraint instructions will show you how.



3. Buckle the belt. Make sure the release button is positioned so you would be able to unbuckle the safety belt quickly if you ever had to.



4. Pull the rest of the shoulder belt all the way out of the retractor to set the lock.



5. To tighten the belt, feed the shoulder belt back into the retractor while you push down on the child restraint. If you're using a forward-facing child restraint, you may find it helpful to use your knee to push down on the child restraint as you tighten the belt.
6. Push and pull the child restraint in different directions to be sure it is secure.

To remove the child restraint, just unbuckle the vehicle's safety belt and let it go back all the way. The safety belt will move freely again and be ready to work for an adult or larger child passenger.

Securing a Child Restraint in the Right Front Seat Position

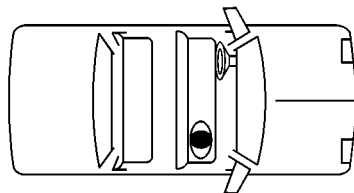

If your child restraint is equipped with the LATCH system, see *Lower Anchorages and Top Tethers for Children (LATCH System)* on page 1-41. See *Top Strap* on page 1-39 if your child restraint has one.

Your vehicle has a right front passenger air bag. *Never* put a rear-facing child restraint in this seat. Here's why:

⚠ CAUTION:

A child in a rear-facing child restraint can be seriously injured or killed if the right front passenger's air bag inflates. This is because the back of the rear-facing child restraint would be very close to the inflating air bag. Always secure a rear-facing child restraint in a rear seat.

Although a rear seat is a safer place, you can secure a forward-facing child restraint in the right front seat.

If your child restraint does not have the LATCH system, you'll be using the lap-shoulder belt to secure the child restraint in this position. Be sure to follow the instructions that came with the child restraint. Secure the child in the child restraint when and as the instructions say.

1. Because your vehicle has a right front passenger's air bag, always move the seat as far back as it will go before securing a forward-facing child restraint. See *Manual Seats* on page 1-2.

2. Put the restraint on the seat.
3. Pick up the latch plate and run the lap and shoulder portions of the vehicle's safety belt through or around the restraint. The child restraint instructions will show you how.



4. Buckle the belt. Make sure the release button is positioned so you would be able to unbuckle the safety belt quickly if you ever had to.



5. Pull the rest of the shoulder belt all the way out of the retractor to set the lock.



6. To tighten the belt, feed the shoulder belt back into the retractor while you push down on the child restraint. You may find it helpful to use your knee to push down on the child restraint as you tighten the belt.
7. Push and pull the child restraint in different directions to be sure it is secure.

To remove the child restraint, just unbuckle the vehicle's safety belt and let it go back all the way. The safety belt will move freely again and be ready to work for an adult or larger child passenger.

Air Bag Systems

This part explains the air bag systems.

Your vehicle has air bags – one air bag for the driver and another air bag for the right front passenger. Your vehicle may also have roof-mounted side impact air bags; one for the driver and the passenger directly behind the driver and one for the right front passenger and the person seated directly behind that passenger.

Air bags are designed to help reduce the risk of injury from the force of an inflating air bag. But these air bags must inflate very quickly to do their job and comply with federal regulations.

Here are the most important things to know about the air bag system:

CAUTION:

You can be severely injured or killed in a crash if you aren't wearing your safety belt – even if you have air bags. Wearing your safety belt during a crash helps reduce your chance of

CAUTION: (Continued)

CAUTION: (Continued)

hitting things inside the vehicle or being ejected from it. Air bags are “supplemental restraints” to the safety belts. All air bags are designed to work with safety belts but don't replace them.

Frontal air bags for the driver and right front passenger are designed to work only in moderate to severe crashes where the front of your vehicle hits something. They aren't designed to inflate at all in rollover, rear or low-speed frontal crashes, or in many side crashes. And, for some unrestrained occupants, frontal air bags may provide less protection in frontal crashes than more forceful air bags have provided in the past. The roof-mounted side impact air bags are designed to inflate only in moderate to severe crashes where something hits the side of your vehicle. They aren't designed to inflate in frontal, in rollover or in rear crashes. Everyone in your vehicle should wear a safety belt properly — whether or not there's an air bag for that person.

 **CAUTION:**

Both frontal and side impact air bags inflate with great force, faster than the blink of an eye. If you're too close to an inflating air bag, as you would be if you were leaning forward, it could seriously injure you. Safety belts help keep you in position for air bag inflation before and during a crash. Always wear your safety belt even with frontal air bags. The driver should sit as far back as possible while still maintaining control of the vehicle. Occupants should not lean on or sleep against the door.

 **CAUTION:**

Anyone who is up against, or very close to, any air bag when it inflates can be seriously injured or killed. Air bags plus lap-shoulder belts offer the best protection for adults, but not for young children and infants. Neither the vehicle's safety belt system nor its air bag system is designed for them. Young children and infants need the protection that a child restraint system can provide. Always secure children properly in your vehicle. To read how, see the part of this manual called "Older Children" or "Infants and Young Children."



There is a air bag readiness light on the instrument panel which shows the air bag symbol.

The system checks the air bag electrical system for malfunctions. The light tells you if there is an electrical problem. See *Air Bag Readiness Light* on page 3-34 for more information.

Where Are the Air Bags?



The driver's air bag is in the middle of the steering wheel.



The right front passenger's air bag is in the instrument panel on the passenger's side.



The side impact air bag for the driver and the person seated directly behind the driver is in the ceiling above the side windows.



The side impact air bag for the right front passenger and the person seated directly behind that passenger is in the ceiling above the side windows.

⚠ CAUTION:

If something is between an occupant and an air bag, the bag might not inflate properly or it might force the object into that person causing severe injury or even death. The path of an inflating air bag must be kept clear. Don't put anything between an occupant and an air bag, and don't attach or put anything on the steering wheel hub or on or near any other air bag covering. And, because your vehicle has side impact air bags, never secure anything to the roof of your vehicle by routing the rope or tiedown through any door or window opening. If you do, the path of an inflating side impact air bag will be blocked. The path of an inflating air bag must be kept clear.

When Should an Air Bag Inflate?

The driver's and right front passengers frontal air bags are designed to deploy only in moderate to severe frontal, or near-frontal crashes. But they are designed to inflate only if the impact speed is above the system's designed "threshold level."

In addition, your vehicle has "dual stage" frontal air bags, which adjust the amount of restraint according to crash severity. For moderate frontal impacts, these air bags inflate at a level less than full deployment. For more severe frontal impacts, full deployment occurs. If the front of your vehicle goes straight into a wall that doesn't move or deform, the threshold level for the reduced deployment is about 12 to 16 mph (19 to 26 km/h), and the threshold level for a full deployment is about 18 to 24 mph (29 to 38.5 km/h). The threshold level can vary, however, with specific vehicle design, so that it can be somewhat above or below this range.

If your vehicle strikes something that will move or deform, such as a parked car, the threshold level will be higher. The driver's and right front passenger's frontal air bags are not designed to inflate in rollovers, rear impacts, or in many side impacts because inflation would not help the occupant.

The side impact air bags are designed to inflate in moderate to severe side crashes. A side impact air bag will inflate if the crash severity is above the system's designed "threshold level". The threshold level can vary with specific vehicle design. Side impact air bags are not designed to inflate in frontal or near-frontal impacts, rollovers or rear impacts, because inflation would not help the occupant. A side impact air bag will only deploy on the side of the vehicle that is struck.

In any particular crash, no one can say whether an air bag should have inflated simply because of the damage to a vehicle or because of what the repair costs were. For frontal air bags, inflation is determined by the angle of the impact and how quickly the vehicle slows down in frontal or near-frontal impacts. For side impact air bags, inflation is determined by the location and severity of the impact.

What Makes an Air Bag Inflate?

In an impact of sufficient severity, the air bag sensing system detects that the vehicle is in a crash. For both frontal and side impact air bags, the sensing system triggers a release of gas from the inflator, which inflates the air bag. The inflator, air bag, and related hardware are all part of the air bag modules inside the steering wheel and in the instrument panel in front of the right front passenger and in the ceiling of the vehicle, near the side windows.

How Does an Air Bag Restrain?

In moderate to severe frontal or near frontal collisions, even belted occupants can contact the steering wheel or the instrument panel. In moderate to severe side collisions, even belted occupants can contact the inside of the vehicle. The air bag supplements the protection provided by safety belts. Air bags distribute the force of the impact more evenly over the occupant's upper body, stopping the occupant more gradually. But the frontal air bags would not help you in many types of collisions, including rollovers, rear impacts, and many side impacts, primarily because an occupant's motion is not toward the air bag. Side impact air bags would not help you in many types of collisions, including frontal or near frontal collisions, rollovers, and rear impacts, primarily because an occupant's motion is not toward those air bags. Air bags should never be regarded as anything more than a supplement to safety belts, and then only in moderate to severe frontal or near-frontal collisions for the driver's and right front passenger's frontal air bags, and only in moderate to severe side collisions for the side impact air bags.

What Will You See After an Air Bag Inflates?

After an air bag inflates, it quickly deflates, so quickly that some people may not even realize the air bag inflated. Some components of the air bag module — the steering wheel hub for the driver's air bag, the instrument panel for the right front passenger's bag or the ceiling of your vehicle near the side windows — will be hot for a short time. The parts of the bag that come into contact with you may be warm, but not too hot to touch. There will be some smoke and dust coming from the vents in the deflated air bags. Air bag inflation doesn't prevent the driver from seeing or being able to steer the vehicle, nor does it stop people from leaving the vehicle.

 **CAUTION:**

When an air bag inflates, there is dust in the air. This dust could cause breathing problems for people with a history of asthma or other breathing trouble. To avoid this, everyone in the vehicle should get out as soon as it is safe to do so. If you have breathing problems but can't get out of the vehicle after an air bag inflates, then get fresh air by opening a window or a door. If you experience breathing problems following an air bag deployment, you should seek medical attention.

In many crashes severe enough to inflate an air bag, windshields are broken by vehicle deformation. Additional windshield breakage may also occur from the right front passenger air bag.

- Air bags are designed to inflate only once. After an air bag inflates, you'll need some new parts for your air bag system. If you don't get them, the air bag system won't be there to help protect you in another crash. A new system will include air bag

modules and possibly other parts. The service manual for your vehicle covers the need to replace other parts.

- Your vehicle is equipped with a crash sensing and diagnostic module, which records information about the air bag system. The module records information about the readiness of the system, when the system commands air bag inflation and driver's safety belt usage at deployment.
- Let only qualified technicians work on your air bag system. Improper service can mean that your air bag system won't work properly. See your dealer for service.

Notice: If you damage the covering for the driver's or the right front passenger's air bag, or the side impact air bag covering on the ceiling near the side windows, the bag may not work properly. You may have to replace the air bag module in the steering wheel, both the air bag module and the instrument panel for the right front passenger's air bag, or side impact air bag module and ceiling covering for the roof-mounted side impact air bag. Do not open or break the air bag coverings.

Servicing Your Air Bag-Equipped Vehicle

Air bags affect how your vehicle should be serviced. There are parts of the air bag system in several places around your vehicle. You don't want the system to inflate while someone is working on your vehicle. Your dealer and the service manual have information about servicing your vehicle and the air bag system. To purchase a service manual, see *Service Publications Ordering Information on page 7-10*.

CAUTION:

For up to 10 seconds after the ignition key is turned off and the battery is disconnected, an air bag can still inflate during improper service. You can be injured if you are close to an air bag when it inflates. Avoid yellow connectors. They are probably part of the air bag system. Be sure to follow proper service procedures, and make sure the person performing work for you is qualified to do so.

The air bag system does not need regular maintenance.

Restraint System Check

Checking Your Restraint Systems

Now and then, make sure the safety belt reminder light and all your belts, buckles, latch plates, retractors and anchorages are working properly. Look for any other loose or damaged safety belt system parts. If you see anything that might keep a safety belt system from doing its job, have it repaired.

Torn or frayed safety belts may not protect you in a crash. They can rip apart under impact forces. If a belt is torn or frayed, get a new one right away.

Also look for any opened or broken air bag covers, and have them repaired or replaced. (The air bag system does not need regular maintenance.)

Replacing Restraint System Parts After a Crash

CAUTION:

A crash can damage the restraint systems in your vehicle. A damaged restraint system may not properly protect the person using it, resulting in serious injury or even death in a crash. To help make sure your restraint systems are working properly after a crash, have them inspected and any necessary replacements made as soon as possible.

If you've had a crash, do you need new belts or LATCH system parts?

After a very minor collision, nothing may be necessary. But if the belts were stretched, as they would be if worn during a more severe crash, then you need new parts.

If the LATCH system was being used during a more severe crash, you may need new LATCH system parts.

If belts are cut or damaged, replace them. Collision damage also may mean you will need to have LATCH system, safety belt or seat parts repaired or replaced. New parts and repairs may be necessary even if the belt or LATCH system wasn't being used at the time of the collision.

If an air bag inflates, you'll need to replace air bag system parts. See the part on the air bag system earlier in this section.

If the frontal air bags inflate, you'll also need to replace the driver's and right front passenger's safety belt buckle assembly. Be sure to do so. Then the new buckle assembly will be there to help protect you in a collision.

 **NOTES**

Section 2 Features and Controls

Keys	2-2	Engine Coolant Heater	2-20
Remote Keyless Entry System	2-4	Automatic Transaxle Operation	2-22
Remote Keyless Entry System Operation	2-5	Parking Brake	2-27
Doors and Locks	2-7	Shifting Into Park (P)	2-28
Door Locks	2-7	Shifting Out of Park (P)	2-30
Power Door Locks	2-8	Parking Over Things That Burn	2-30
Last Door Closed Locking	2-8	Engine Exhaust	2-31
Programmable Automatic		Running Your Engine While	
Door Locks	2-9	You Are Parked	2-32
Lockout Protection	2-9	Mirrors	2-33
Leaving Your Vehicle	2-9	Manual Rearview Mirror	2-33
Trunk	2-10	Manual Rearview Mirror with OnStar®	2-33
Windows	2-12	Outside Power Mirrors	2-34
Power Windows	2-13	Outside Convex Mirror	2-34
Sun Visors	2-13	OnStar® System	2-35
Theft-Deterrent Systems	2-14	Storage Areas	2-36
Content Theft-Deterrent	2-14	Glove Box	2-36
PASS-Key® III	2-15	Overhead Console	2-36
PASS-Key® III Operation	2-16	Front Seat Storage Net	2-37
Starting and Operating Your Vehicle	2-18	Center Console Storage Area	2-37
New Vehicle Break-In	2-18	Assist Handles	2-38
Ignition Positions	2-18	Convenience Net	2-38
Starting Your Engine	2-19	Sunroof	2-39

Keys

CAUTION:

Leaving children in a vehicle with the ignition key is dangerous for many reasons. A child or others could be badly injured or even killed.

They could operate the power windows or other controls or even make the vehicle move.

Don't leave the keys in a vehicle with children.





The key can be used for the ignition, as well as the driver's door lock and storage compartments.

When a new key is delivered, it will come with a bar coded tag attached to the key ring. Keep the bar coded tag that came with the original keys. Give this tag to your dealer if you need a new key made.

Your vehicle has the PASS-Key[®] III vehicle theft system. The key has a transponder in the key head that matches a decoder in the vehicle's instrument panel. If a replacement key or an additional key is needed, it must be purchased from your dealer. The key will have PK3 stamped on it.

Any new PASS-Key[®] III key must be programmed before it will start your vehicle. See *PASS-Key[®] III* on page 2-15 for more information on programming your new key.

In an emergency, contact Pontiac Roadside Assistance. See *Roadside Assistance Program* on page 7-6 for more information.

Notice: Your vehicle has a number of features that can help prevent theft. You can have a lot of trouble getting into your vehicle if you ever lock your keys inside. You may even have to damage your vehicle to get in. So be sure you have spare keys.

If your vehicle is equipped with the OnStar[®] system with an active subscription and you lock your keys inside the vehicle, OnStar[®] may be able to send a command to unlock your vehicle. See *OnStar[®] System* on page 2-35 for more information.

Remote Keyless Entry System

Your keyless entry system operates on a radio frequency subject to Federal Communications Commission (FCC) Rules and with Industry Canada.

This device complies with Part 15 of the FCC Rules. Operation is subject to the following two conditions:

1. This device may not cause interference, and
2. This device must accept any interference received, including interference that may cause undesired operation of the device.

This device complies with RSS-210 of Industry Canada. Operation is subject to the following two conditions:

1. This device may not cause interference, and
2. This device must accept any interference received, including interference that may cause undesired operation of the device.

Changes or modifications to this system by other than an authorized service facility could void authorization to use this equipment.

At times you may notice a decrease in range. This is normal for any remote keyless entry system. If the transmitter does not work or if you have to stand closer to your vehicle for the transmitter to work, try this:

- Check the distance. You may be too far from your vehicle. You may need to stand closer during rainy or snowy weather.
- Check the location. Other vehicles or objects may be blocking the signal. Take a few steps to the left or right, hold the transmitter higher, and try again.
- Check to determine if battery replacement is necessary. See “Battery Replacement” under *Remote Keyless Entry System Operation on page 2-5*.
- If you are still having trouble, see your dealer or a qualified technician for service.

Remote Keyless Entry System Operation



You can lock and unlock the doors or unlock the trunk of the vehicle from about 3 feet (1 m) up to 30 feet (9 m) away with the remote keyless entry transmitter.

LOCK: Press the LOCK button to lock all the doors. Pressing the LOCK button may arm the content theft-deterrent system. See *Content Theft-Deterrent* on page 2-14 for more information.

UNLOCK: Press the UNLOCK button once to unlock the driver's door. Press the UNLOCK button again within five seconds to unlock the other doors. Pressing the UNLOCK button on the remote keyless entry transmitter will disarm the content theft deterrent system. See *Content Theft-Deterrent* on page 2-14 for more details.

 **(Remote Alarm):** Press the button with the horn symbol to make the headlamps flash and the horn sound. This lets you attract attention, if needed.

 **(Open Trunk):** Press this button to release the trunk lid. The transaxle must be in PARK (P) for this feature to operate.

Your vehicle may have Remote Lock/Unlock Confirmation. This feature provides feedback that a command has been received by the vehicle. The headlamps will flash and the horn may sound briefly. See *DIC Controls and Displays* on page 3-45 for programming information.

Matching Transmitter(s) to Your Vehicle

Each remote keyless entry transmitter is coded to prevent another transmitter from unlocking your vehicle. If a transmitter is lost or stolen, a replacement can be purchased through your dealer. Remember to bring any remaining transmitters with you when you go to your dealer. When the dealer matches the replacement transmitter to your vehicle, any remaining transmitters must also be matched. Once your dealer has coded the new transmitter, the lost transmitter will not unlock your vehicle. Each vehicle can have a maximum of four transmitters matched to it.

Battery Replacement

Under normal use, the battery in your remote keyless entry transmitter should last about three years.

You can tell the battery is weak if the transmitter won't work at the normal range. If you have to get close to your vehicle before the transmitter works, it's probably time to change the battery.

Notice: When replacing the battery, use care not to touch any of the circuitry. Static from your body transferred to these surfaces may damage the transmitter.



To replace the battery do the following:

1. Insert a flat object like a thin coin into the notch located on the front of the transmitter, below the open trunk button, and pry it apart.
2. Gently slide the battery out of the transmitter. Do not use a metal object to remove the battery.
3. Slide the new battery into the transmitter. Use a type CR2032 battery, or equivalent type.
4. Snap the transmitter back together, making sure the halves are secured tightly, so water will not get in.
5. Test the operation of the transmitter with the vehicle. If the transmitter does not work, resynchronize the transmitter.

Resynchronization

If the functions on the remote keyless entry transmitter do not work, or, if only the remote alarm works, after the battery is replaced, then the transmitter needs to be resynchronized to the receiver. Do this by pressing and holding the LOCK and UNLOCK buttons on the transmitter at the same time for about eight seconds. You must be within range of the vehicle.

Once the transmitter has been resynchronized, the horn will sound and the exterior lamps will flash once. The system should now operate properly.

Doors and Locks

Door Locks

CAUTION:

Unlocked doors can be dangerous.

- Passengers — especially children — can easily open the doors and fall out of a moving vehicle. When a door is locked, the handle won't open it. You increase the chance of being thrown out of the vehicle in a crash if the doors aren't locked. So, wear safety belts properly and lock the doors whenever you drive.
- Young children who get into unlocked vehicles may be unable to get out. A child can be overcome by extreme heat and can suffer permanent injuries or even death from heat stroke. Always lock your vehicle whenever you leave it.
- Outsiders can easily enter through an unlocked door when you slow down or stop your vehicle. Locking your doors can help prevent this from happening.

There are several ways to lock and unlock your vehicle.

To lock or unlock your vehicle from the outside, use your key or remote keyless entry transmitter.



To manually lock or unlock your doors from inside the vehicle, push down or pull up on the door lock pin located on the top of each door panel.

Power Door Locks



To lock or unlock all doors from inside the vehicle, use the power door lock switch located on either front door.

Move the switch on the driver's door to the right to lock or to the left to unlock the doors. Move the switch on the passenger's door to the left to lock or to the right to unlock the doors.

If your vehicle has the content theft-deterrent system, your vehicle may be programmed to arm the system with the power door lock switch. The power door lock switch will not unlock the doors until the system is disarmed. See *DIC Controls and Displays on page 3-45* for more information on disarming the system.

Last Door Closed Locking

The last door closed locking feature delays the locking of your vehicle's doors. When a door is open, three chimes will sound the first time you lock the doors using the power door lock switch or the keyless entry transmitter. The chimes indicate that the last door closed locking feature is on. All doors can be opened for five seconds after the last door has been closed. When the last door is closed, all doors will lock after five seconds.

The doors can be locked immediately by using the power door lock switch or the remote keyless entry transmitter.

The last door closed locking feature will not activate when the ignition is in RUN or ACCESSORY.

To turn the last door closed locking feature on or off see *DIC Controls and Displays on page 3-45* for more information on personal programming.

Programmable Automatic Door Locks

All of the doors will lock automatically when the shift lever is moved out of PARK (P). All doors will unlock automatically when the ignition is turned off while the shift lever is in PARK (P). If you prefer to have your doors unlocked automatically at any time, see *DIC Controls and Displays on page 3-45* for more information.

If someone needs to get in or out of the vehicle after the doors have been automatically locked, place the shift lever into PARK (P). Unlock all doors using the power door lock switch or unlock the door you want using the inside manual door lock pin. If you have programmed the automatic door locks to unlock the doors when the shift lever is shifted into PARK (P), then the doors will automatically unlock for you. See *DIC Controls and Displays on page 3-45* for more information on personal programming.

If you don't want the doors to unlock automatically when you turn the ignition off see *DIC Controls and Displays on page 3-45* for more information on personal programming.

Lockout Protection

The lockout protection feature makes it more difficult to lock the key in the vehicle. If the driver's door is open while the key is in the ignition, you will not be able to use the power door lock switch to lock the door.

This feature cannot guarantee that you'll never be locked out of the vehicle. If you don't leave the key in the ignition, or if you use the manual door lock pin, you could still lock the key inside the vehicle. Always remember to take the key with you.

To turn this feature on or off see *DIC Controls and Displays on page 3-45*.

Leaving Your Vehicle

If you are leaving your vehicle, make sure that you lock it and take the key with you.

Trunk

CAUTION:

It can be dangerous to drive with the trunk lid open because carbon monoxide (CO) gas can come into your vehicle. You can't see or smell CO. It can cause unconsciousness and even death. If you must drive with the trunk lid open or if electrical wiring or other cable connections must pass through the seal between the body and the trunk lid:

- Make sure all other windows are shut.
- Turn the fan on your heating or cooling system to its highest speed and select the control setting that will force outside air into your vehicle. See "Climate Control System" in the Index.
- If you have air outlets on or under the instrument panel, open them all the way.

See "Engine Exhaust" in the Index.

Trunk Lock

To unlock the trunk from the outside, insert the key into the lock on the trunk and turn it clockwise. You can also press the open trunk symbol on the remote keyless entry transmitter. See *Remote Keyless Entry System Operation on page 2-5* for more information.

The ignition must be off, or, the transaxle must be in PARK (P), in order for the trunk to open.

Remote Trunk Release

This feature is used to unlock the trunk from inside the vehicle using the power door lock switch.



Press and hold the power door lock switch to the left for one and one-half seconds to unlock the trunk.

The transaxle must be in PARK (P) to activate the trunk release.

Trunk Assist Handle



The trunk assist handle is located inside the trunk lid toward the driver's side of the vehicle.

Notice: The trunk assist handle is not designed to be used to tie down the trunk lid or as an anchor point when securing items in the trunk. Improper use of the trunk assist handle could damage it.

Pull down on the handle to lower the trunk lid. Then close the trunk with your other hand. If the trunk is not properly closed, the AJAR message, along with a trunk ajar graphic will appear on the DIC. See *DIC Warnings and Messages on page 3-65* for more information.

Emergency Trunk Release Handle

Notice: The emergency trunk release handle is not designed to be used to tie down the trunk lid or as an anchor point when securing items in the trunk. Improper use of the emergency trunk release handle could damage it.

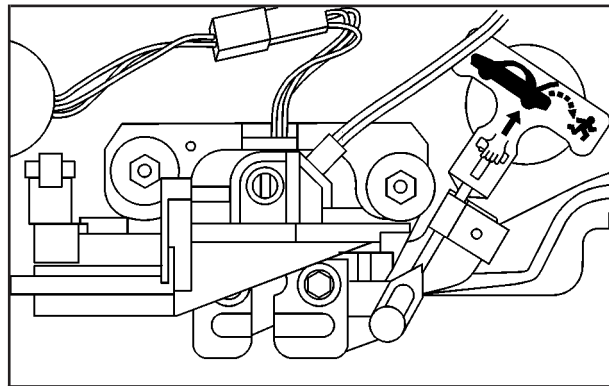

There is a glow-in-the-dark emergency trunk release handle located on the latch inside the trunk lid. This handle will glow following exposure to light. Pull the release handle to open the trunk from the inside.

Windows

CAUTION:

Leaving children in a vehicle with the windows closed is dangerous. A child can be overcome by the extreme heat and can suffer permanent injuries or even death from heat stroke. Never leave a child alone in a vehicle, especially with the windows closed in warm or hot weather.



Power Windows



Use the switches on the driver's door armrest to operate each of the windows.

Push the switch rearward to open or forward to close the window. The top switches operate the front windows, and the bottom switches operate the rear windows. Each passenger door also has a switch that operates that window.

The power window switches only work if the ignition is on or while Retained Accessory Power (RAP) is active. See "Retained Accessory Power (RAP)" under *Ignition Positions on page 2-18* for more information.

Express-Down Window

The driver's window switch has an express-down feature. Tap the switch rearward, and the driver's window will open a small amount. If the switch is fully depressed rearward and released, the window will go all the way down.

To stop the window while it is lowering, press the front of the switch. To raise the window, press and hold the front of the switch.

Window Lock-Out

The driver's window switch includes a lock-out feature located above the power window switches on the driver's door armrest. Move the switch to the right to prevent the passengers sitting in the rear from using their window switches. The driver can still control all the windows with the lock on. Move the switch to the left to disengage the lock-out feature.

Sun Visors

To help block out glare, pull the sun visors down. Pull on the inside edges of the sun visors to swing them from the front windshield to the side window.

Visor Vanity Mirror

Raise the cover on the top of the sun visor to expose the vanity mirror. If the vehicle has lighted vanity mirrors, the lamps come on when the cover is opened.

Theft-Deterrent Systems

Vehicle theft is big business, especially in some cities. Although your vehicle has a number of theft-deterrent features, we know that nothing we put on it can make it impossible to steal.

Content Theft-Deterrent

Your vehicle has a theft-deterrent alarm system.



A red light located on top of the instrument panel, toward the center of the vehicle and near the windshield, will flash slowly when the system is armed.

While armed, the doors will not unlock with the power door lock switch. The remote alarm will sound if someone tampers with the trunk lock, enters the vehicle

without using the remote keyless entry transmitter or key to unlock the doors, or turns the ignition on without the proper key. The horn will sound and the headlamps will flash for up to two minutes. The system will also cut off the fuel supply, preventing the vehicle from being driven.

Arming with the Power Lock Switch

The vehicle's content theft-deterrent alarm system can be activated when the key is removed from the ignition and either power door lock switch is used to lock the doors, when any door is open. This system can be activated through the Driver's Information Center (DIC). See personal programming under *DIC Controls and Displays* on page 3-45.

When programmed, the red light will flash rapidly on top of the instrument panel indicating the system is ready to activate. When the doors are locked using the power door lock switch, the red light will stop flashing indicating that the system is arming. After all the doors are closed and locked, the red light will begin flashing at a very slow rate, indicating the system is armed.

Arming with the Remote Keyless Entry Transmitter

The alarm system will arm when you use the remote keyless entry transmitter to lock the doors after the key is removed from the ignition. The red light will turn on to let you know the system is arming. After all doors are closed and locked, the red light will begin flashing at a very slow rate to let you know the system is armed.

Arming Confirmation

If the remote unlock confirmation is on, the headlamps will flash briefly to let you know when the alarm system has armed. See *DIC Controls and Displays on page 3-45* for more information on personal programming.

Disarming with the Remote Keyless Entry Transmitter

The alarm system will disarm when you use your remote keyless entry transmitter to unlock the doors. The red light will go off to let you know the system is disarmed.

Disarming with Your Key

The alarm system will disarm when you use the key to unlock the doors. The red light will stop flashing when the system is disarmed. If you would like the key to disarm the alarm system, see *DIC Controls and Displays on page 3-45* for more information on personal programming.

PASS-Key® III

Your PASS-Key® III system operates on a radio frequency subject to Federal Communications Commission (FCC) Rules and with Industry Canada.

This device complies with Part 15 of the FCC Rules. Operation is subject to the following two conditions:

1. This device may not cause harmful interference, and
2. This device must accept any interference received, including interference that may cause undesired operation.

This device complies with RSS-210 of Industry Canada. Operation is subject to the following two conditions:

1. This device may not cause interference, and
2. This device must accept any interference received, including interference that may cause undesired operation of the device.

Changes or modifications to this system by other than an authorized service facility could void authorization to use this equipment.

PASS-Key® III uses a radio frequency transponder in the key that matches a decoder in your vehicle.

PASS-Key® III Operation



Your vehicle is equipped with PASS-Key® III (Personalized Automotive Security System) theft-deterrent system. PASS-Key® III is a passive theft-deterrent system. This means you don't have to do anything special to arm or disarm the system. It works when you insert or remove the key from the ignition.

When the PASS-Key® III system senses that someone is using the wrong key, it shuts down the vehicle's starter and fuel systems. The starter will not work and fuel will stop flowing to the engine. Anyone using a trial-and-error method to start the vehicle will be discouraged because of the high number of electrical key codes.

When trying to start the vehicle, if the engine does not start and the STARTING DISABLED DUE TO THEFT SYSTEM warning message on the Driver's Information Center (DIC) comes on, the key may have a damaged transponder. Turn the ignition off and try again.

If the engine still does not start, and the key appears to be undamaged, try another ignition key. At this time, you may also want to check the fuse. See *Fuses and Circuit Breakers on page 5-99*. If the engine still does not start with the other key, your vehicle needs service. If your vehicle does start, the first key may be faulty. See your dealer who can service the PASS-Key® III to have a new key made. In an emergency, contact Pontiac Roadside Assistance. See *Roadside Assistance Program on page 7-6* for more information.

It is possible for the PASS-Key® III decoder to "learn" the transponder value of a new or replacement key. Up to 10 additional keys may be programmed for the vehicle. The following procedure is for programming additional keys only. If all the currently programmed keys are lost or do not operate, you must see your dealer or a locksmith who can service PASS-Key® III to have keys made and programmed to the system.

Canadian Owners: If you lose or damage your keys, only a GM dealer can service PASS-Key® III to have new keys made. To program additional keys, you will need two current driver's keys. You must add a step to the following procedure. After Step 2, repeat Steps 1 and 2 with the second current driver's key. Then continue with Step 3.

To program the new key do the following:

1. Verify that the new key has PK3 stamped on it.
2. Insert the master key in the ignition and start the engine. If the engine will not start, see your dealer for service.
3. After the engine has started, turn the key to OFF, and remove the key.
4. Insert the key to be programmed and turn it to RUN within five seconds of removing the original key.

5. The SECURITY DISABLED DUE TO THEFT SYSTEM warning message on the DIC will turn off, once the key has been programmed. It may not be apparent that the SECURITY DISABLED DUE TO THEFT SYSTEM warning message went on due to how quickly the key is programmed.
6. Repeat Steps 1 through 5 if additional keys are to be programmed.

If you are ever driving and the SECURITY DISABLED DUE TO THEFT SYSTEM warning message on the DIC comes on and stays on, you will be able to restart your engine if you turn it off. Your PASS-Key® III system, however, is not working properly and must be serviced by your dealer. Your vehicle is not protected by the PASS-Key® III system at this time.

If you lose or damage your PASS-Key® III key, see your dealer or a locksmith who can service PASS-Key® III to have a new key made.

Starting and Operating Your Vehicle

New Vehicle Break-In

Notice: Your vehicle doesn't need an elaborate "break-in." But it will perform better in the long run if you follow these guidelines:

- Don't drive at any one speed — fast or slow — for the first 500 miles (805 km). Don't make full-throttle starts.
- Avoid making hard stops for the first 200 miles (322 km) or so. During this time your new brake linings aren't yet broken in. Hard stops with new linings can mean premature wear and earlier replacement. Follow this breaking-in guideline every time you get new brake linings.
- Don't tow a trailer during break-in. See "Towing a Trailer" in the Index for more information.

Ignition Positions

There are four different positions in the ignition switch which is located on the instrument panel, to the right of the steering column. Insert the key in the ignition and turn it to the right for each position.



Insert the key in the ignition and turn it to the right for each position.

○ (OFF): This position locks the ignition, steering wheel and transaxle. It's a theft-deterrent feature. It's also the only position from which the key can be removed.

Notice: If your key seems stuck in OFF and you can't turn it, be sure you are using the correct key; if so, is it all the way in? If it is, then turn the steering wheel left and right while you turn the key hard. Turn the key only with your hand. Using a tool to force it could break the key or the ignition switch. If none of these works, then your vehicle needs service.

ACC (ACCESSORY): This position lets you use things like the radio and windshield wipers while the engine is off.

| **(RUN):** This position is where the key returns to after you start the vehicle. With the engine off, you can use RUN to display some of the warning and indicator lights.

Ⓚ **(START):** This position starts the engine. Let go of the key when the engine starts. The key will return to the RUN position.

A continuous warning chime will sound and a KEY IN IGNITION warning message will display on the DIC if the key is in the ignition in the OFF or ACCESSORY positions and the driver's door is opened.

Retained Accessory Power (RAP)

With Retained Accessory Power (RAP), the power windows, audio system and sunroof will continue to work up to 10 minutes after the ignition key is turned to OFF and none of the doors are opened.

Starting Your Engine

1. Move your shift lever to PARK (P) or NEUTRAL (N). Your engine won't start in any other position – that's a safety feature. To restart while you're already moving, use NEUTRAL (N) only.

Notice: Don't try to shift to PARK (P) if your vehicle is moving. If you do, you could damage the transaxle. Shift to PARK (P) only when your vehicle is stopped.

2. With your foot off the accelerator pedal, turn your ignition key to START. When the engine starts, let go of the key. The idle speed will go down as your engine gets warm.

Notice: Holding your key in START for longer than 15 seconds at a time will cause your battery to be drained much sooner. And the excessive heat can damage your starter motor. Wait about 15 seconds between each try to help avoid draining your battery or damaging your starter.

3. If it doesn't start within 10 seconds, hold your key in START for about 10 seconds at a time until your engine starts. Wait about 15 seconds between each try.
4. If your engine still won't start (or starts but then stops), it could be flooded with too much gasoline. Try pushing your accelerator pedal all the way to the floor and holding it there as you hold the key in START for about three seconds. If the vehicle starts briefly but then stops again, do the same thing. This time keep the pedal down for five or six seconds to clear the extra gasoline from the engine. After waiting about 15 seconds, repeat the normal starting procedure.

Notice: Your engine is designed to work with the electronics in your vehicle. If you add electrical parts or accessories, you could change the way the engine operates. Before adding electrical equipment, check with your dealer. If you don't, your engine might not perform properly.

Engine Coolant Heater



Your vehicle may be equipped with an engine coolant heater. In very cold weather, 0°F (-18°C) or colder, the engine coolant heater can help. You'll get easier starting and better fuel economy during engine warm-up. Usually, the coolant heater should be plugged in a minimum of four hours prior to starting your vehicle. At temperatures above 32°F (0°C), use of the coolant heater is not required.

To Use the Engine Coolant Heater

1. Turn off the engine.
2. Open the hood and unwrap the electrical cord. The cord is located above the engine air cleaner/filter. See *Engine Compartment Overview on page 5-12* for more information on location.
3. Plug it into a normal, grounded 110-volt AC outlet.

CAUTION:

Plugging the cord into an ungrounded outlet could cause an electrical shock. Also, the wrong kind of extension cord could overheat and cause a fire. You could be seriously injured. Plug the cord into a properly grounded three-prong 110-volt AC outlet. If the cord won't reach, use a heavy-duty three-prong extension cord rated for at least 15 amps.

4. Before starting the engine, be sure to unplug and store the cord as it was before to keep it away from moving engine parts. If you don't, it could be damaged.

How long should you keep the coolant heater plugged in? The answer depends on the outside temperature, the kind of oil you have, and some other things. Instead of trying to list everything here, we ask that you contact your dealer in the area where you'll be parking your vehicle. The dealer can give you the best advice for that particular area.

Automatic Transaxle Operation



The automatic transaxle has a shift lever on the console between the seats.

Maximum engine speed is limited when your vehicle is in PARK (P) or NEUTRAL (N) to protect driveline components from improper operation.

There are several different positions for the shift lever.

PARK (P): This position locks the front wheels. It's the best position to use when you start the engine because the vehicle can't move easily.

CAUTION:

It is dangerous to get out of your vehicle if the shift lever is not fully in PARK (P) with the parking brake firmly set. Your vehicle can roll.

Don't leave your vehicle when the engine is running unless you have to. If you have left the engine running, the vehicle can move suddenly. You or others could be injured. To be sure your vehicle won't move, even when you're on fairly level ground, always set your parking brake and move the shift lever to PARK (P). See "Shifting Into Park (P)" in the Index. If you're pulling a trailer, see "Towing a Trailer" in the Index.

Make sure the shift lever is fully in PARK (P) before starting the engine. The vehicle has an automatic transaxle shift lock control system. You must fully apply the regular brakes and press the shift control button located on the front of the shift lever, before you can shift from PARK (P) when the ignition is in RUN. If you cannot shift out of PARK (P), ease pressure on the shift lever by pushing it all the way into PARK (P) while keeping the brake pedal pushed down. Release the shift lever button. Then move the shift lever out of PARK (P), being sure to press the shift lever button. See *Shifting Out of Park (P)* on page 2-30.

REVERSE (R): Use this gear to back up.

Notice: Shifting to REVERSE (R) while your vehicle is moving forward could damage your transaxle. Shift to REVERSE (R) only after your vehicle is stopped.

To rock the vehicle back and forth to get out of snow, ice or sand without damaging the transaxle, see *If You Are Stuck: In Sand, Mud, Ice or Snow* on page 4-32.

NEUTRAL (N): In this position, the engine doesn't connect with the wheels. To restart when you're already moving, use NEUTRAL (N) only. Also, use NEUTRAL (N) when the vehicle is being towed.

 **CAUTION:**

Shifting into a drive gear while your engine is “racing” (running at high speed) is dangerous. Unless your foot is firmly on the brake pedal, your vehicle could move very rapidly. You could lose control and hit people or objects. Don't shift into a drive gear while your engine is racing.

Notice: Damage to your transaxle caused by shifting into a drive gear with the engine racing isn't covered by your warranty.

AUTOMATIC OVERDRIVE (D): This position is for normal driving. If you need more power for passing, and you're:

- Going less than 35 mph (55 km/h), push your accelerator pedal about halfway down.
- Going about 35 mph (55 km/h) or more, push the accelerator pedal all the way down.

You'll shift down to the next gear and have more power.

Notice: If your vehicle seems to start up rather slowly, or if it seems not to shift gears as you go faster, something may be wrong with a transaxle system sensor. If you drive very far that way, your vehicle can be damaged. So, if this happens, have your vehicle serviced right away. Until then, you can use **SECOND (2)** when you are driving less than 35 mph (55 km/h) and **AUTOMATIC OVERDRIVE (D)** for higher speeds.

THIRD (3): This position is also used for normal driving, but it offers more power and lower fuel economy than **AUTOMATIC OVERDRIVE (D)**.

Here are some times you might choose **THIRD (3)** instead of **AUTOMATIC OVERDRIVE (D)**:

- When driving on hilly, winding roads.
- When towing a trailer, so there is less shifting between gears.
- When going down a steep hill.
- When driving in non-highway scenarios (i.e. city streets, etc.).

SECOND (2): This position gives you more power but lower fuel economy than **THIRD (3)**. You can use **SECOND (2)** on hills. It can help control your speed as you go down steep mountain roads, but then you would also want to use your brakes off and on.

Notice: Don't drive in **SECOND (2)** for more than 25 miles (40 km), or at speeds over 55 mph (90 km/h), or you can damage your transaxle. Use **THIRD (3)** or **AUTOMATIC OVERDRIVE (D)** as much as possible. Don't shift into **SECOND (2)** unless you are going slower than 65 mph (105 km/h) or you can damage your engine.

FIRST (1): This position gives you even more power but lower fuel economy than SECOND (2). You can use it on very steep hills, or in deep snow or mud. If the shift lever is moved to FIRST (1), the transaxle won't shift into first gear until the vehicle is going slowly enough.

Notice: If your front wheels won't turn, don't try to drive. This might happen if you were stuck in very deep sand or mud or were up against a solid object. You could damage your transaxle. Also, if you stop when going uphill, don't hold your vehicle there with only the accelerator pedal. This could overheat and damage the transaxle. Use your brakes to hold your vehicle in position on a hill.

Performance Shifting with TAP-Shift™



If your vehicle is equipped with the 3800 V6 Supercharged engine, it may have a console gearshift with a MANUAL (M) position.

The other gearshift positions available are PARK (P), REVERSE (R), NEUTRAL (N) and AUTOMATIC OVERDRIVE (D), and operate as explained earlier in this section.

While in the MANUAL (M) position, you may up-shift or down-shift the transaxle using the paddles located on the steering wheel, under certain circumstances.



While in the MANUAL (M) mode, push either paddle once to up-shift to the next gear. Pull either paddle once to down-shift to the next gear.

To fully use the system, select MANUAL (M) while stopped, with the engine running. The vehicle will begin moving in first gear upon acceleration. (In icy or slippery conditions, you may start out in second gear, rather than first gear, for better vehicle control.)

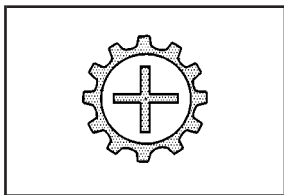

Then you will be prompted to up-shift by the indicator light on the instrument panel or by the up-shift symbol on Head-Up Display (HUD), if equipped, using a TAP-Shift™ paddle.

Throughout acceleration you will be prompted in this way to up-shift as needed. If you do not up-shift when prompted, vehicle speed will be limited to protect the engine.

Press the accelerator quickly while driving in the highest gear to make the transaxle automatically down-shift. The transaxle will also automatically down-shift as the vehicle decelerates and comes to a stop.

A chime will sound if you push or pull a paddle requesting a transaxle gear change when the vehicle cannot respond. The system will not allow either an up-shift or a down-shift if the vehicle speed is too fast or too slow, nor will it allow a start from third or higher gear.

You may also select MANUAL (M) while the vehicle is already moving. The current transaxle position will continue to be displayed on the DIC and HUD, if equipped. The transaxle up-shifts and down-shifts can be done using the TAP-Shift™ paddles as described previously.

Parking Brake



The parking brake is located to the left of the brake pedal near the driver's door. To set the parking brake, hold the regular brake pedal down with your right foot. Push down on the parking brake pedal, with your left foot.

To release the parking brake, hold the regular brake pedal down with your right foot and push the parking brake pedal with your left foot. When you lift your left foot, the parking brake pedal will follow it to the released position.

A warning chime will sound if the parking brake is set, the ignition is on and the shift lever is not in PARK (P) or NEUTRAL (N).

The brake light will also come on the instrument panel when the parking brake is set. It will stay on if your parking brake doesn't release fully.

The BRAKE ON message will also appear in the Driver Information Center (DIC) when the parking brake is set.

Notice: Driving with the parking brake on can cause your rear brakes to overheat. You may have to replace them, and you could also damage other parts of your vehicle.

If you are towing a trailer and parking on a hill, see *Towing a Trailer on page 4-37*. That section shows what to do first to keep the trailer from moving.

Shifting Into Park (P)

CAUTION:

It can be dangerous to get out of your vehicle if the shift lever is not fully in PARK (P) with the parking brake firmly set. Your vehicle can roll. If you have left the engine running, the vehicle can move suddenly. You or others could be injured. To be sure your vehicle won't move, even when you're on fairly level ground, use the steps that follow. If you're pulling a trailer, see "Towing a Trailer" in the Index.

1. Hold the brake pedal down with your right foot and set the parking brake.
2. Move the shift lever into PARK (P) like this:



- Press in and hold the shift lever button, located on the front of the shift lever.

-
-
-
3. Push the lever all the way toward the front of the vehicle.
4. Turn the ignition key to OFF.
5. Remove the key and take it with you. If you can leave your vehicle with the ignition key in your hand, your vehicle is in PARK (P).

Leaving Your Vehicle With the Engine Running

CAUTION:

It can be dangerous to leave your vehicle with the engine running. Your vehicle could move suddenly if the shift lever is not fully in PARK (P) with the parking brake firmly set. And, if you leave the vehicle with the engine running, it could overheat and even catch fire. You or others could be injured. Don't leave your vehicle with the engine running.

If you have to leave your vehicle with the engine running, be sure the vehicle is in PARK (P) and the parking brake is firmly set before you leave it. After you've moved the shift lever into PARK (P), hold the regular brake pedal down. Then, see if you can move the shift lever away from PARK (P) (without first pushing the shift lever button). If you can, it means that the shift lever wasn't fully locked into PARK (P).

Torque Lock

If you are parking on a hill and you don't shift your transaxle into PARK (P) properly, the weight of the vehicle may put too much force on the parking pawl in the transaxle. You may find it difficult to move the shift lever out of PARK (P). This is called "torque lock." To prevent torque lock, set the parking brake and then shift into PARK (P) properly before you leave the driver's seat. To find out how, see *Shifting Into Park (P)* on page 2-28.

When you are ready to drive, move the shift lever out of PARK (P) before you release the parking brake.

If torque lock does occur, you may need to have another vehicle push your vehicle uphill. This should take some of the pressure from the parking pawl in the transaxle, so you can move the shift lever out of PARK (P).

Shifting Out of Park (P)

Your vehicle has an automatic transaxle shift lock control system which locks the shift lever in PARK (P) when the ignition is in the OFF position. In addition, you have to fully apply your regular brakes before you can shift from PARK (P) when the ignition is in RUN. See *Automatic Transaxle Operation on page 2-22*.

If you cannot shift out of PARK (P), ease pressure on the shift lever and push the shift lever all the way up into PARK (P) as you maintain brake application. Then move the shift lever into the gear you want.

If you ever hold the brake pedal down but still can't shift out of PARK (P), try this:

1. Turn the key to ACCESSORY. (There is no shift interlock in this key position.)
2. Apply and hold the brake until the end of Step 4.
3. Shift the transaxle to NEUTRAL (N).
4. Start the vehicle and then shift to the transaxle gear you want.
5. Have the system fixed as soon as you can.

Parking Over Things That Burn

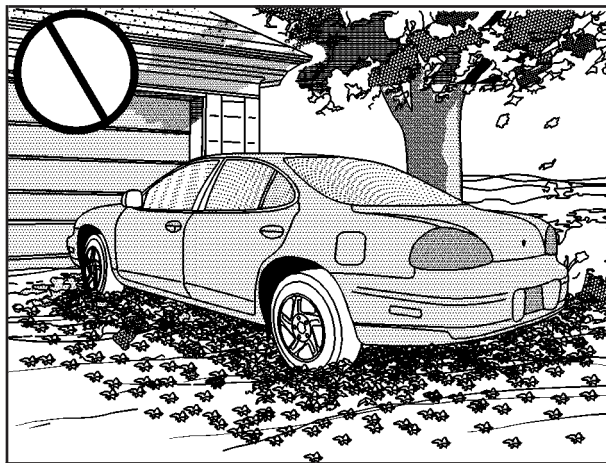

CAUTION:

Things that can burn could touch hot exhaust parts under your vehicle and ignite. Don't park over papers, leaves, dry grass or other things that can burn.

Engine Exhaust

CAUTION:

Engine exhaust can kill. It contains the gas carbon monoxide (CO), which you can't see or smell. It can cause unconsciousness and death.

You might have exhaust coming in if:

- Your exhaust system sounds strange or different.
- Your vehicle gets rusty underneath.
- Your vehicle was damaged in a collision.
- Your vehicle was damaged when driving over high points on the road or over road debris.

CAUTION: (Continued)

CAUTION: (Continued)

- Repairs weren't done correctly.
- Your vehicle or exhaust system had been modified improperly.

If you ever suspect exhaust is coming into your vehicle:

- Drive it only with all the windows down to blow out any CO; and
- Have your vehicle fixed immediately.

Running Your Engine While You Are Parked

It's better not to park with the engine running. But if you ever have to, here are some things to know.

CAUTION:

Idling the engine with the climate control system off could allow dangerous exhaust into your vehicle. See the earlier Caution under “Engine Exhaust.”

Also, idling in a closed-in place can let deadly carbon monoxide (CO) into your vehicle even if the climate control fan is at the highest setting. One place this can happen is a garage. Exhaust — with CO — can come in easily. **NEVER** park in a garage with the engine running.

Another closed-in place can be a blizzard. See “Winter Driving” in the Index.

CAUTION:

It can be dangerous to get out of your vehicle if the shift lever is not fully in PARK (P) with the parking brake firmly set. Your vehicle can roll. Don't leave your vehicle when the engine is running unless you have to. If you've left the engine running, the vehicle can move suddenly. You or others could be injured. To be sure your vehicle won't move, even when you're on fairly level ground, always set your parking brake and move the shift lever to PARK (P).

Follow the proper steps to be sure your vehicle won't move. See *Shifting Into Park (P)* on page 2-28.

If you are parking on a hill and if you're pulling a trailer, also see *Towing a Trailer* on page 4-37.

Mirrors

Manual Rearview Mirror

Use the control, located at the bottom, to change the mirror from the day to the night position. To reduce glare from headlamps behind you while driving at night, turn the control to the right. To return the mirror back to the day position, turn the control to the left.

Manual Rearview Mirror with OnStar[®]

If your vehicle has this feature, use the control, located at the bottom of the mirror, to change the mirror from the day to the night position. To reduce glare from headlamps behind you while driving at night, turn the control to the right. To return the mirror to the day position, turn the control to the left.

There are two map lamps located on the bottom of the mirror. Each lamp is turned on and off by pressing the button next to the lamp.



There are also three OnStar[®] buttons located at the bottom of the mirror face. See your dealer for more information on the system and how to subscribe to OnStar[®]. See *OnStar[®] System on page 2-35* for more information about the services OnStar[®] provides.

Outside Power Mirrors



The power mirror controls are located near the driver's window, on the driver's door armrest.

Move the top control to the left to adjust the driver's side outside mirror. Move the control to the right to adjust the passenger's side mirror. The center position turns the power control off and will not allow the mirrors to move if the control pad is touched.

The round control pad adjusts the angle of the selected outside mirror. Press the arrows on the control pad in the direction that you want the mirror to go. Adjust each mirror so that you can see a small portion of the side of your vehicle and the area behind your vehicle.

Outside Convex Mirror

Your passenger's outside rearview mirror is convex. A convex mirror's surface is curved so you can see more from the driver's seat.

CAUTION:

A convex mirror can make things (like other vehicles) look farther away than they really are. If you cut too sharply into the right lane, you could hit a vehicle on your right. Check your inside mirror or glance over your shoulder before changing lanes.

OnStar® System



OnStar® uses global positioning system (GPS) satellite technology, wireless communications, and call centers to provide you with a wide range of safety, security, information and convenience services. An OnStar® subscription plan is included in the price of your vehicle. You can upgrade or extend your OnStar® services to meet your needs.

A complete OnStar® user's guide and the terms and conditions of the OnStar® Subscription Service Agreement are included in your vehicle's glove box literature. For more information, visit www.onstar.com, contact OnStar® at 1-888-4-ONSTAR (1-888-466-7827), or press the blue OnStar® button to speak to an OnStar® advisor 24 hours a day, 7 days a week.

OnStar® Services

OnStar® provides a number of service plans. Some of the services currently provided by OnStar® are:

- Automatic Notification of Air Bag Deployment
- Emergency Services
- Roadside Assistance Stolen Vehicle Tracking
- AccidentAssist
- Remote Door Unlock
- Remote Diagnostics
- Online and Personal Concierge Services
- Route Support
- RideAssist
- Information and Convenience Services

OnStar® Personal Calling

With OnStar® Personal Calling, you have a safer way to stay connected while driving. It's a hands-free wireless phone that's integrated into your vehicle. You can place calls nationwide using voice-activated dialing with no contracts, no roaming charges and no access fees. To find out more about OnStar® Personal Calling, refer to the OnStar® user's guide in your vehicle's glove box, or call OnStar® at 1-888-4-ONSTAR (1-888-466-7827).

OnStar® Virtual Advisor

With OnStar® Virtual Advisor you can listen to the news, entertainment and informative topics, such as traffic and weather reports. You are able to listen and reply to your e-mail through your vehicle's speakers.

A completed Subscription Service Agreement is required prior to delivery of OnStar® services and prepaid calling minutes are also required for OnStar® Personal Calling and OnStar® Virtual Advisor use. Terms and conditions of the Subscription Service Agreement can be found at www.onstar.com.

Storage Areas

Glove Box

Use your key to lock and unlock the glove box. To open the glove box lift the latch.

Overhead Console



The overhead console has two reading lamps. Press the sides of each lens to turn the reading lamps on or off.

If the vehicle does not have an overhead console, it will have a dome light located in the front of the headliner.

Sunglasses Storage Compartment

If the vehicle does not have a sunroof, it may have a storage compartment located to the rear on the overhead console. To open the sunglasses storage compartment, press the release latch forward and pull the compartment down to the full open position.

Front Seat Storage Net



If the vehicle is equipped with a fold-flat front passenger seat, a storage net that can be used for storing small items, is located on the seatback.

The net does not detach from the seat.

Center Console Storage Area



Console Without HUD Shown

To open the armrest storage area, pull up on the front edge of the latch. The console has cassette and CD storage.

The center console also has an insert that contains two cupholders. The insert can be removed to hold a larger container. To remove the insert, push back on it and pull up.

In front of the ashtray is an open storage compartment. Behind the ashtray, there may be a smaller compartment.

Assist Handles



The vehicle has lighted assist handles located above the rear doors. They can be used to help passengers enter and exit the vehicle.

The lamps on the handles will come on automatically when a door is opened and turn off when the door is closed. The lamps can be manually turned on or off if there are grooves on the lens of the lamp. Press the grooved side of the lens to turn the lamp on or off.

Convenience Net

The vehicle is equipped with a convenience net in the trunk that covers the passenger's side wheel well.

There may also be a convenience net attached to the backside walls of the trunk. This net can be used as an "envelope" to hold items inside it, or, it can be pulled over items to secure them. If used as an envelope, put small loads like grocery bags inside the net. This can help items from falling over during sharp turns or quick starts and stops. To use this net to cover items in the trunk, attach two corners of the net to the two loops located at the bottom of the rear seatback. When not using the net, hook the net to the tabs securing it to the trunk wall.

Other Storage Areas

The vehicle also has a trunk storage compartment. It is located on the passenger's side of the trunk, above the wheel well. It may lock. To access the storage area, lift up on the handle of the compartment cover and pull.

Sunroof

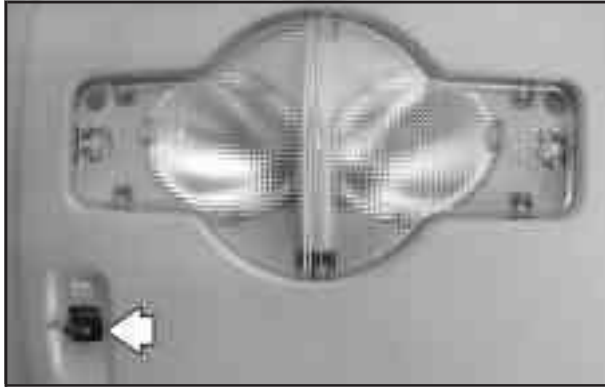

Uplevel Version Shown

Your vehicle may be equipped with a sunroof. The sunroof includes a sliding glass panel and a sunshade. The switch to control the sunroof is located in the headliner. The switch works only while the ignition is on or RAP is active. See *Ignition Positions on page 2-18*.

Vent: Open the sunshade by hand. Push the rear of the switch once and the sunroof will open to the vent position.

Open/Express-Open: Push the rear of the switch a second time and the sunroof will open the remainder of the way.

Close: Push and hold the front of the switch until the sunroof motor stops. The sunshade must be closed by hand.

 **NOTES**

Section 3 Instrument Panel

Instrument Panel Overview	3-2	Enhanced Traction System Warning Light	3-38
Hazard Warning Flashers	3-4	Engine Coolant Temperature Warning Light	3-39
Other Warning Devices	3-5	Engine Coolant Temperature Gage	3-39
Horn	3-5	Malfunction Indicator Lamp	3-40
Tilt Wheel	3-5	Oil Pressure Light	3-43
Windshield Washer Lever	3-6	Fog Lamp Light	3-44
Cruise Control Lever	3-8	High-Beam On Light	3-44
Exterior Lamps	3-12	Fuel Gage	3-44
Interior Lamps	3-16	Driver Information Center (DIC)	3-45
Head-Up Display (HUD)	3-19	DIC Controls and Displays	3-45
Accessory Power Outlets	3-23	DIC Warnings and Messages	3-65
Ashtrays and Cigarette Lighter	3-24	Audio System(s)	3-88
Climate Controls	3-25	Setting the Time	3-88
Climate Control System	3-25	Radio with CD	3-89
Outlet Adjustment	3-29	Radio with Cassette and CD	3-100
Warning Lights, Gages and Indicators	3-31	Radio with Six-Disc CD	3-114
Instrument Panel Cluster	3-32	Theft-Deterrent Feature	3-128
Speedometer and Odometer	3-33	Audio Steering Wheel Controls	3-129
Tachometer	3-33	Understanding Radio Reception	3-130
Safety Belt Reminder Light	3-34	Care of Your Cassette Tape Player	3-130
Air Bag Readiness Light	3-34	Care of Your CDs	3-131
Up-Shift Light	3-35	Care of Your CD Player	3-131
Brake System Warning Light	3-36	Backglass Antenna	3-132
Anti-Lock Brake System Warning Light	3-37	XM™ Satellite Radio Antenna System (United States Only)	3-132
Traction Control System (TCS) Warning Light	3-38		

Instrument Panel Overview

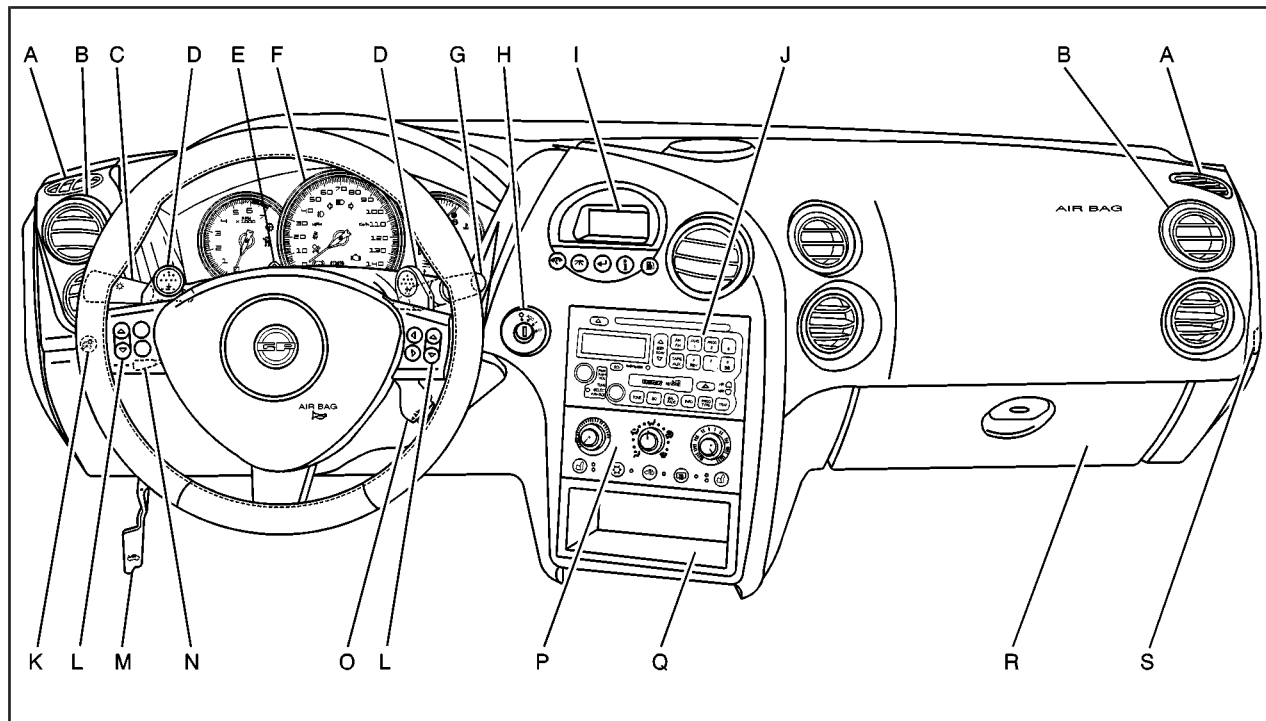

The main components of the instrument panel are the following:

- A. Side Window Defogger Outlets. (See *Outlet Adjustment on page 3-29.*)
- B. Instrument Panel Outlets. (See *Outlet Adjustment on page 3-29.*)
- C. Exterior Lamps Control. (See *Exterior Lamps on page 3-12.*)
- D. TAP-Shift™ Control. (See *Automatic Transaxle Operation on page 2-22.*)
- E. Hazard Warning Flashers Button. (See *Hazard Warning Flashers on page 3-4.*)
- F. Instrument Panel Cluster. (See *Instrument Panel Cluster on page 3-32.*)
- G. Windshield Wiper Lever. (See *Windshield Washer Lever on page 3-6.*)
- H. Ignition. (See *Ignition Positions on page 2-18.*)
- I. DIC (Driver Information Center). (See *Driver Information Center (DIC) on page 3-45.*)
- J. Audio System. (See *Audio System(s) on page 3-88.*)
- K. Interior Lamps Brightness Control (Behind Steering Wheel). (See *Interior Lamps on page 3-16.*)
- L. Audio Controls. (See *Audio System(s) on page 3-88.*)
- M. Hood Release. (See *Hood Release on page 5-11.*)
- N. Tilt Steering Wheel Lever (on Steering Column). (See *Tilt Wheel on page 3-5.*)
- O. Cruise Control. (See *Cruise Control Lever on page 3-8.*)
- P. Climate Controls. (See *Climate Control System on page 3-25.*)
- Q. Storage Area.
- R. Glove Box. (See *Glove Box on page 2-36.*)
- S. Instrument Panel Fuse Block. (See *Fuses and Circuit Breakers on page 5-99.*)

Hazard Warning Flashers

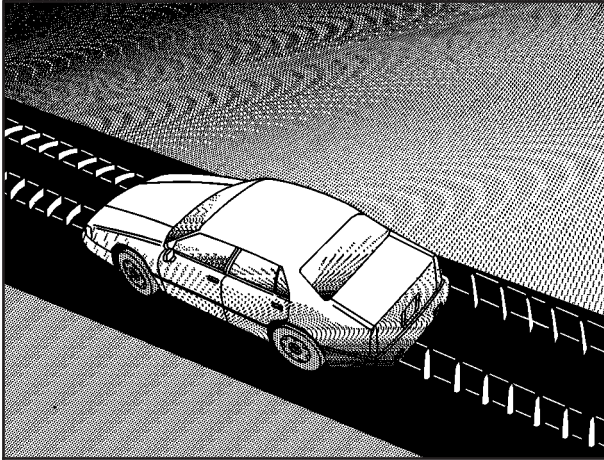

Your hazard warning flashers let you warn others. They also let police know you have a problem. Your front and rear turn signal lamps will flash on and off.



The hazard warning flasher button is located on top of the steering column.

The hazard warning flashers work no matter what position your key is in, and even if the key isn't in.

Press the button to make your front and rear turn signal lamps flash on and off. Press the button again to turn the flashers off.

When the hazard warning flashers are on, your turn signals and brake lamps won't work.

Other Warning Devices

If you carry reflective triangles, you can set one up at the side of the road about 300 feet (100 m) behind your vehicle.

Horn

Press the vehicle's steering wheel pad to sound the horn.

Tilt Wheel

A tilt steering wheel allows you to adjust the steering wheel before you drive. You can raise it to the highest level to give your legs more room when you exit and enter the vehicle, or you can lower it so that you're more comfortable while driving.

The lever to adjust it is located on the left side of the steering column.





To tilt the wheel, hold the steering wheel and pull the lever. Move the steering wheel to a comfortable level, then release the lever to lock the wheel in place.

Windshield Washer Lever

Windshield Wipers





 **(Windshield Wipers):** The lever with this symbol, located on the right side of the steering column, operates the windshield wipers.

 **(Off):** Lower the lever to its original position to turn the wipers off.

 **(Delay):** Push the lever up once to this position to set a delay between wipes. Turn the delay adjustment band to set the length of the delay.

 **(Delay Adjustment):** Turn the band, located on the left of the windshield wiper lever, to set the length of the delay between wiper cycles when using the delay feature. There are five delay adjustment settings. Turn the band up to make the delays shorter in between wiper cycles. Turn the band down to make the delays longer between wiper cycles. The windshield wiper lever must be in delay for this feature to work.

 **(Low Speed):** Push the lever up to the second position for steady wiping cycles at a slow speed.

 **(High Speed):** Push the lever up to the third position for steady wiping cycles at a high speed.

▼  **(Mist):** For a single wiping cycle, push the lever down once and let go. The wipers will stop after one cycle. For additional cycles, hold the lever down.

Be sure to clear ice and snow from the wiper blades before using them. If they're frozen to the windshield, gently loosen or thaw them. Damaged wiper blades may prevent you from seeing well enough to drive safely. If the blades do become damaged, install new blades or blade inserts. For more information, see *Windshield Wiper Blade Replacement on page 5-67*.

Heavy snow or ice can overload the wiper motor. A circuit breaker will stop the motor until it cools down. Clear away snow or ice to prevent an overload.

Windshield Washer

CAUTION:

In freezing weather, don't use your washer until the windshield is warmed. Otherwise the washer fluid can form ice on the windshield, blocking your vision.

The windshield washer button is located at the end of the windshield wiper lever.

 **(Washer Fluid):** Press this button to activate the washer fluid to spray onto the windshield. The wipers will run for a few cycles to clear the windshield. For more wash cycles, press and hold the button.

If your vehicle is low on washer fluid, the LOW WASHER FLUID message will appear on the Driver Information Center (DIC) display. See *DIC Warnings and Messages on page 3-65* for more information.

Cruise Control Lever

Cruise Control

CAUTION:

- Cruise control can be dangerous where you can't drive safely at a steady speed. So, don't use your cruise control on winding roads or in heavy traffic.
- Cruise control can be dangerous on slippery roads. On such roads, fast changes in tire traction can cause needless wheel spinning, and you could lose control. Don't use cruise control on slippery roads.



The cruise control lever is located below the windshield wiper control on the right side of the steering wheel.

CANCEL: Pull the lever toward you to cancel the cruise control.

 **(On/Off):** Push the button on the end of the lever to turn the cruise control on or off.

RES + (Resume/Accelerate): Push the lever up to resume the cruise control or to accelerate when passing another vehicle.

SET - (Set/Coast/Decelerate): Push the lever down to set the cruise. If the cruise is already set this position can be used to coast or decelerate from a higher speed.

With cruise control, you can maintain a speed of approximately 25 mph (40 km/h) or more without keeping your foot on the accelerator. This is helpful on long trips. Cruise control does not work at speeds below about 25 mph (40 km/h).

When you apply your brakes, the cruise control shuts off.

If your vehicle is in cruise control and either the Traction Control System (TCS) or the Enhanced Traction System (ETS) begins to limit wheel spin, the cruise control will automatically disengage. See *Traction Control System (TCS) on page 4-10* and *Enhanced Traction System (ETS) on page 4-11*. When road conditions allow you to safely use it again, you may turn the cruise control back on.

Setting Cruise Control

CAUTION:

If you leave your cruise control on when you're not using cruise, you might hit a button and go into cruise when you don't want to. You could be startled and even lose control. Keep the cruise control switch off until you want to use cruise control.

1. Push the button at the end of the cruise control lever to turn the cruise control on.
2. Accelerate to the speed you want.
3. Push down on the cruise control lever and release it. This will set the cruise control.
4. Remove your foot from the accelerator pedal.

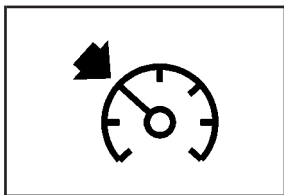

This symbol, along with the mph (km/h) and the CRUISE SET message, will appear in the DIC when cruise is set.

This message will disappear when you brake or cancel the cruise control. It will reappear when set speed is resumed. The message will go out when the cruise control is turned off.

The CRUISE SET message will also appear temporarily on the HUD, if equipped, when you push the lever to the set/coast/decelerate or the resume/accelerate positions.

Resuming a Set Speed

Suppose you set your cruise control at a desired speed and then you apply the brake. This shuts off the cruise control. But you don't need to reset it.

Once the vehicle is traveling approximately 25 mph (40 km/h) or more, you can push the lever upward toward the plus (resume/accelerate) position to return to your desired preset speed.

The vehicle will return to and stay at the preset speed. If you push up and hold the lever toward the plus (resume/accelerate) position, the vehicle speed will increase until you release the button or apply the brake. Unless you want to go faster, do not continue to hold the lever in the plus (resume/accelerate) position.

Increasing Speed While Using Cruise Control

There are two ways to go to a higher speed:

- Use the accelerator pedal to get to the higher speed. Push up on the lever toward the plus (resume/accelerate) position, then release the lever and take your foot off the accelerator pedal. You will now cruise at the higher speed.
- Push up and hold the lever toward the plus (resume/accelerate) position until you get up to the speed that you want, and then release the lever. To increase your speed in very small amounts, push up briefly on the lever and release it. Each time you do this, your vehicle will speed up approximately 1 mph (1.6 km/h).

The acceleration feature will only work after you have set the cruise control speed by pushing the lever down to the set position.

Reducing Speed While Using Cruise Control

There are two ways to reduce your speed while using cruise control:

- Push the lever downward toward the minus (set/coast/decelerate) position until you reach the lower speed you want, then release it.
- To slow down in very small amounts, push the lever downward toward the minus (set/coast/decelerate) position briefly. Each time you do this, the vehicle will slow down approximately 1 mph (1.6 km/h).

Passing Another Vehicle While Using Cruise Control

Use the accelerator pedal to increase your speed. When you take your foot off the pedal, your vehicle will slow down to the cruise control speed you set earlier.

Using Cruise Control on Hills

How well your cruise control will work on hills depends upon your speed, load and the steepness of the hills. When going up steep hills, you may have to step on the accelerator pedal to maintain your speed.

When going downhill, you may have to brake or shift to a lower gear to keep your speed down. Applying the brake or shifting into a lower gear will take you out of cruise control. If you need to apply the brake or shift to a lower gear due to the grade of the downhill slope, you may not want to attempt to use your cruise control feature.

Cancelling Cruise Control

To cancel a cruise control session, pull the cruise control lever forward, or, step lightly on the brake pedal.

Doing either of these two things will only end the current cruise control session, but the set speed will be retained in memory.

You must push the button at the end of the cruise control lever to turn the system off.

Erasing Speed Memory

When you turn off the cruise control or the ignition, your cruise control set speed memory is erased.

Exterior Lamps

Exterior Lamp Control Lever

The lever on the left side of the steering column operates the exterior lamps.



☀: Turn the outside band on the lever with this symbol to operate the exterior lamps, except for the fog lamps.

☰: Turn the outside band to turn the headlamps off.

AUTO (Automatic): Turn the outside band to this position to set the headlamps so that they will come on when it is dark outside.

☷: **(Parking Lamps):** Turn the outside band to this position to turn on the parking lamps together with the following:

- Sidemarker Lamps
- Taillamps
- License Plate Lamps
- Instrument Panel Lamps

☷: **(Headlamps):** Turn the outside band to this position to turn on the headlamps, together with the previously listed lamps.

Fog Lamps

Fog lamps provide brighter roadway lighting for better vision in foggy or misty conditions.

☞ (Fog Lamps): Turn the second band on the exterior lamps lever to this position to turn the fog lamps on. The band will return to its original position.

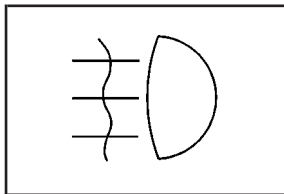

This symbol will appear on the instrument panel cluster when the fog lamps are on.

To turn the fog lamps off, turn the band up to the fog lamp symbol and release it. The band will return to its original position. If the high-beam headlamps are on the fog lamps will turn off. They will turn back on again when you switch back to the low-beam headlamps.

The parking lamps must be on for the fog lamps to work.

Headlamp High/Low-Beam Changer

Push forward on the exterior lamps control lever to change the headlamps from low to high-beam. Pull the lever back and then release it to change from high to low-beam.

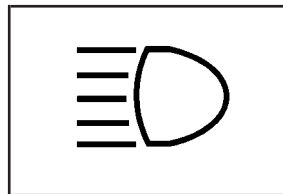

This symbol on the instrument panel cluster will display when the high-beam lamps are on.

When the high-beam headlamps are on, the fog lamps will not be on. If your vehicle is equipped with the Head-Up-Display (HUD) an arrow will appear in the HUD area to indicate that the high-beams are on. See *Head-Up Display (HUD)* on page 3-19 for more information.

Headlamps On Reminder

A warning chime will sound if the exterior lamp control is left on in either the headlamp or parking lamp position and the driver's door is opened with the ignition off.

Flash-To-Pass Feature

This feature allows you to use the high-beam headlamps to signal the driver in front of you that you want to pass.

Pull and hold the exterior lamps control lever toward you to use this feature. When you do, the following will occur:

- If the headlamps are either off, in low-beam or in Daytime Running Lamps (DRL) mode, the high-beam headlamps will turn on. They'll stay on as long as you hold the lever there. Release the lever to turn them off.
- If the headlamps are in high-beam mode, they will switch to low beam. To return to high-beam, push the lever away from you.

If your vehicle is equipped with Head-Up Display (HUD), an arrow will appear on the display to indicate that the high beams are on.

Turn and Lane-Change Signals

To signal a turn, move the lever all the way up or down. The lever returns automatically when the turn is complete.

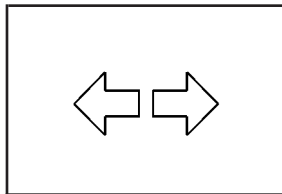

An arrow on the instrument panel cluster will flash in the direction of the turn or lane change.

If your vehicle is equipped with the Head-Up-Display (HUD), the turn signals will appear in the HUD area when making turns or lane changes. See *Head-Up Display (HUD)* on page 3-19 for more information.

Raise or lower the lever until the arrow starts to flash to signal a lane change. Hold it there until the lane change is complete. The lever returns to its original position when it is released.

Arrows that flash rapidly when signaling for a turn or lane change may be caused by a burned-out signal bulb. Other driver's won't see the signal.

Replace burned-out bulbs to help avoid possible accidents. Check the fuse and for burned-out bulbs if the arrow fails to work when signaling a turn. See *Fuses and Circuit Breakers* on page 5-99 for more information.

Turn Signal On Chime

If the turn signal is left on for approximately 1 mile (1.61 km), a warning chime will sound and the TURN SIGNAL ON warning message will appear on the Driver Information Center (DIC) display. See “Turn Signal On” under *DIC Warnings and Messages on page 3-65* for more information.

Daytime Running Lamps

Daytime Running Lamps (DRL) can make it easier for others to see the front of your vehicle during the day. DRL can be helpful in many different driving conditions, but they can be especially helpful in the short periods after dawn and before sunset. Fully functional daytime running lamps are required on all vehicles first sold in Canada.

The DRL system will make the turn signal lamps come on when the following conditions are met:

- It is still daylight and the ignition is in RUN or START,
- the exterior lamp control is in off or AUTO with the headlamps off, and
- an automatic transaxle is not in PARK (P) and the parking brake is released.

When DRL are on, only the front turn signal/parking lamps will be on. No other exterior lamps will be on when the DRL are being used. Your instrument panel won't be lit up either.

When the exterior lamp control is in AUTO and it's dark enough outside, the DRL will turn off and the low-beam headlamps at full brightness will turn on. When it's bright enough outside, the front turn signal lamps will go off, and the DRL will turn back on. If you start your vehicle in a dark garage, the automatic headlamp system will come on immediately. Once you leave the garage, it will take approximately one minute for the automatic headlamp system to change to DRL if it is light outside. During that delay, your instrument panel cluster may not be as bright as usual. Make sure your instrument panel brightness knob is in the full bright position. See “Instrument Panel Brightness” under *Interior Lamps on page 3-16*.

Vehicle's sold in the U.S. can turn the DRL off. To do this, turn the band on the exterior lamp control to off. Turn the band to this position again to turn the DRL on.

As with any vehicle, you should turn on the regular headlamp system when you need it.

Light Sensor

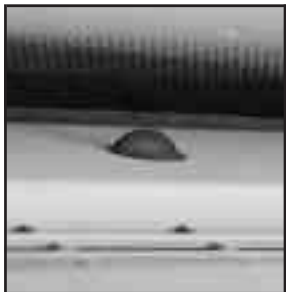

The light sensor for the DRL and AUTO headlamps feature is located on top of the instrument panel.

If you cover the sensor, it will read “dark,” and the headlamps will turn on to full brightness.

Exterior Lighting Battery Saver

If the parking lamps or headlamps have been left on, the exterior lamps will turn off approximately 10 minutes after the ignition is turned to OFF. This protects against draining the battery in case you have accidentally left the headlamps or parking lamps on. The battery saver does not work if the headlamps are turned on after the ignition is turned to OFF.

If you need to leave the lamps on for more than 10 minutes, use the exterior lamp control to turn the lamps back on.

Interior Lamps

Instrument Panel Brightness

This feature controls the brightness of the instrument panel lights.



The interior lamps control is located on the instrument panel, to the left of the steering wheel.

To adjust the brightness of the instrument panel lights, turn the control.

Courtesy Lamps

When a door is opened, the courtesy lamps will automatically come on. You can also turn these lamps on by manually turning the interior lamps control all the way to the right.

Entry Lighting

The entry lighting feature lights the interior of the vehicle before you enter. The interior lamps will come on for 40 seconds when you unlock the doors using the remote keyless entry transmitter and the ignition is in LOCK or OFF. After 40 seconds have elapsed, the interior lamps will slowly fade out. The lamps will fade out before 40 seconds have elapsed if you do the following:

- Lock all doors using the remote keyless entry transmitter.
- Lock the doors using the power door lock switch.

When any door is opened, entry lighting is canceled. The interior lamps will stay on while any door is opened and slowly fade out when all doors are closed. The interior lamps may stay on for up to 25 seconds after all doors have been closed if they have not been locked.

Delayed Entry Lighting

The delayed lighting feature will continue to light the interior of the vehicle for 25 seconds after all the doors have been closed. Delayed lighting will not occur while the ignition is in RUN or ACCESSORY. After 25 seconds have elapsed, the interior lamps will slowly fade out. The lamps will fade out before the 25 seconds have elapsed if you do any of the following:

- Turn the ignition to RUN or ACCESSORY.
- Lock the doors using the remote keyless entry transmitter.
- Lock the doors using the power door lock switch.

To turn the delayed lighting feature off or on, see personal programming under *DIC Controls and Displays on page 3-45*.

Delayed Exit Lighting

For exiting the vehicle at night, the vehicle is equipped with the delayed exit lighting feature. The interior lamps will light for up to 25 seconds when you remove the key from the ignition. After 25 seconds have elapsed, the interior lamps will slowly fade out. The lamps will fade out before the 25 seconds have elapsed if you do any of the following:

- Turn the ignition to RUN or ACCESSORY.
- Lock the doors using the remote keyless entry transmitter.
- Lock the doors using the power door lock switch.

When any door is opened, delayed exit lighting is canceled. The interior lamps will stay on while any door is opened and will slowly fade out when all the doors are closed. The interior lamps may stay on for up to 25 seconds after all the doors have been closed if they have not been locked.

To turn the delayed exit lighting feature off or on, see personal programming under *DIC Controls and Displays on page 3-45*.

Overhead Console Reading Lamps

Your vehicle may have reading lamps on the overhead console. These lamps will turn on when you open the doors. When the doors are closed, press the side of each lamp to turn them on and off.

Front Reading Lamps

If the vehicle has the optional sunroof, you will have reading lamps in front of the sunroof switch located on the headliner. These lamps will come on when you open the doors. The lamps can be turned on and off manually by pressing the side of each reading lamp when the doors are closed.

Rear Assist Handle Reading Lamps

Your vehicle may have reading lamps on each rear assist handle. Press the side of the reading lamp to turn it on or off.

Battery Run-Down Protection

Your vehicle has a feature to help prevent you from draining the battery in case you accidentally leave the interior, trunk or underhood lamps on. If you leave any of these lamps on while the ignition is in LOCK or OFF, they will automatically turn off after 10 minutes. The lamps won't come back on again until you do one of the following:

- Turn the ignition to RUN or ACCESSORY.
- Turn the interior lamps control completely to the right, then back slightly to the left.
- Open (or close and reopen) a door that is closed.

If the vehicle has less than 15 miles (25 km) on the odometer, the battery saver will turn off the lamps after only three minutes.

Head-Up Display (HUD)

CAUTION:

If the HUD image is too bright or too high in your field of view, it may take you more time to see things you need to see when it's dark outside. Be sure to keep the HUD image dim and placed low in your field of view.

If your vehicle is equipped with the Head-Up Display (HUD), you can see the speedometer reading (in English or metric units), transaxle positions, compass direction, outside air temperature, and a brief display of the current radio station or CD track, displayed "through" the windshield.

English or metric units selection is done through the trip computer in the Driver Information Center (DIC). See *DIC Controls and Displays* on page 3-45 for more information.

The HUD information can be displayed in three languages, English, French and Spanish.

Language selection is done through the trip computer in the Driver Information Center (DIC). See *DIC Controls and Displays* on page 3-45.



When you sit up in your seat, the HUD image will appear straight ahead on the windshield, near the front bumper.

When the ignition key is turned to run, the HUD will display the phrase, WIDETRACK GP, for a short time, until the HUD is warmed up.

The following indicator lights come on the instrument panel when activated and will also appear on the HUD:

- Turn Signal Indicators
- High-Beam Indicator Symbol

The HUD will temporarily display CHECK TRIP COMPUTER when there are messages on the DIC trip computer.

The HUD will also temporarily display the following messages when these systems, if equipped, are active:

- TRACTION CONTROL ACTIVE
- STABILITY CONTROL ACTIVE

The HUD will temporarily display the TRACTION CONTROL OFF message when the traction control system is turned off.

The HUD will temporarily display the CRUISE SET message when cruise control is activated or cruise speed is increased.

Notice: Although the HUD image appears to be near the front of the vehicle, do not use it as a parking aid. The HUD was not designed for that purpose. If you try to use it as such, you may misjudge the distance and damage your vehicle.

When the HUD is on, the speedometer reading will be displayed continually. The current radio station or CD track number will only be displayed for three seconds after the radio or CD track status changes. This will happen whenever one of the radio controls is pressed.



The HUD control is located on the console.

To adjust the HUD so you can see the display properly do the following:

1. Adjust your seat, if necessary, to a comfortable position. Start the engine and adjust the HUD controls.
2. **○ (OFF):** Rotate the outer ring on the HUD control to this position to turn the HUD off.

3. **I II III IIII (BRIGHTNESS):** Rotate the outer ring on the HUD control to select the brightness of the display. The group of four slash marks is the selection which will make the display the brightest.
4. **△ (Up):** Press this switch on the HUD control to move the image up.
5. **▽ (Down):** Press this switch on the HUD control to move the image down. Move the image as low as possible on the windshield, but so that it is still in full view.
6. **☰ (Page):** Press this button to select the display formats. Release the page button when the format number with the displays you want on the HUD is shown.
 - **Format One:** This display gives the speedometer reading (in English or metric units), transaxle positions, compass direction and the outside air temperature.
 - **Format Two:** This display includes the information in Format One without the compass direction and the outside air temperature.
 - **Format Three:** This display includes all the information in Format One, but turns the instrument cluster lighting off. The warning indicators still appear on the instrument panel when required.
Format Three is only available at night.

The HUD will “remember” the last display format selected. When the vehicle is started if the last format displayed was Format One or Format Three, then Format One will be displayed.

If the last format was Format Two, then Format Two will be displayed.

The HUD will automatically dim and brighten to compensate for outside lighting.

The HUD display can temporarily light up depending on the angle and position of the sunlight on the display. This is normal and will change when the angle of the sunlight on the HUD display changes.

Polarized sunglasses could also make the HUD image harder to see.

Care of the HUD

Clean the inside of the windshield as needed to remove any dirt or film that reduces the sharpness or clarity of the HUD image.

To clean the HUD, spray household glass cleaner on a soft, clean cloth. Wipe the HUD lens gently, then dry it. Do not spray cleaner directly on the lens because the cleaner could leak into the unit.

If You Can't See the HUD Image When the Ignition Is On

- Is anything covering the HUD unit?
- Is the HUD dimmer setting bright enough?
- Is the HUD image adjusted to the proper height?
- Are you wearing polarized sunglasses?
- Still no HUD image? Check the fuse in the instrument panel fuse block. See *Fuses and Circuit Breakers on page 5-99*.

If the HUD Image Is Not Clear

- Is the HUD image too bright?
- Are the windshield and HUD lens clean?

The windshield is part of the HUD system. If you ever need a new windshield, be sure to get one designed for HUD. If you don't, the HUD image may look blurred and out of focus.

Accessory Power Outlets



The vehicle has two 12-volt outlets which can be used to plug in electrical equipment such as a cellular telephone, a compact disc player, etc.

One accessory power outlet is located on the center console, below the front edge of the storage console. The other is located inside the console.

Remove the tethered cap to use the outlet. When not using the outlet, be sure to cover it with the protective cap.

Notice: When using an accessory power outlet, maximum electrical load must not exceed amperage rating. Always turn off any electrical equipment when not in use. Leaving electrical equipment on for extended periods will drain your battery.

Certain electrical accessories may not be compatible with the accessory power outlet and could result in blown vehicle or adapter fuses. If you experience a problem see your dealer for additional information on accessory power outlets.

Notice: Adding some electrical equipment to your vehicle can damage it or keep other things from working as they should. This wouldn't be covered by your warranty. Check with your dealer before adding electrical equipment, and never use anything that exceeds the amperage rating.

When adding electrical equipment, be sure to follow the proper installation instructions included with the electrical equipment you install.

Notice: Power outlets are designed for accessory plugs only. Do not hang any type of accessory or accessory bracket from the plug. Improper use of the power outlet can cause damage not covered by your warranty.

Ashtrays and Cigarette Lighter

Notice: Don't put papers or other flammable items into your ashtrays. Hot cigarettes or other smoking materials could ignite them, causing a damaging fire.

Ashtray

The ashtray is located to the right of the transaxle shift lever on the center console. To open, push and release the rear of the cover.

To empty the ashtray, lift the tab on the side and pull up to remove the ashtray from the center console. To reinstall, push the tray back into place.

Cigarette Lighter

Notice: Don't hold a cigarette lighter in with your hand while it is heating. If you do, it won't be able to back away from the heating element when it's ready. That can make it overheat, damaging the lighter and the heating element.



The cigarette lighter, if equipped, is located on the center console.

Press the lighter all the way in and release it. It will pop back out once the element is ready for use.

Climate Controls

Climate Control System

Manual Climate Control System

The climate control system allows you to manually control the heating, cooling and ventilation for the vehicle.



Fan

 **(Fan):** Turn the knob by this symbol, located on the left side of the climate control panel, clockwise or counterclockwise to increase or decrease the fan speed.

During the highest fan speed selections, the fan speed will be temporarily reduced between the transition to a new mode. The fan will resume the original speed when the transition to the new mode is complete.

 **(Off):** Turn the knob to this position to turn the fan off.

Mode

Turn the middle knob to select the following modes:

 **(Vent) Outside Air:** This mode directs outside air to the instrument panel outlets. If you are in city traffic, and the vehicle is stopped and idling, or the weather is hot, you may switch from this mode to the recirculation mode. To prevent the air inside the vehicle from becoming stale, be sure to return to the vent mode periodically.

 **(Bi-Level):** This mode directs half of the air to the instrument panel outlets, and then directs the remaining air to the floor outlets. Some air may be directed toward the windshield. Slightly cooler air is directed to the instrument panel outlets and warmer air is directed to the floor outlets.

 **(Floor):** This mode directs most of the air to the floor outlets with some air directed toward the side window outlets and a little air directed to the windshield.

In this mode, the system will automatically use outside air. The air conditioning compressor will be engaged unless the outside temperature is 40° F (4°C) or below.

Recirculation cannot be selected when in this mode.

The middle knob on the climate control panel can also be used to select the defog or defrost mode.

Defogging and Defrosting

Fog on the inside of the vehicle is a result of high humidity (moisture) condensing on the cool window glass. This can be minimized if the climate control system is used properly. There are two modes to clear frost or fog from the windshield. Use the defog mode to clear the windows of condensation and to warm the vehicle's occupants. Use the defrost mode to remove frost or condensation from the windshield quickly.

See "Rear Window Defogger" later in this section for information on clearing the rear window of fog or ice.

There are two modes to clear fog from your windshield.

Recirculation cannot be selected when in these modes.

 **(Floor/Defog):** Use the floor/defog mode to clear the windows of fog or moisture and warm the passengers. This mode directs the air equally between the windshield and the floor outlets, along with some directed to the side window outlets.

This mode will automatically use outside air. The air conditioning compressor will be engaged unless the outside temperature is 40° F (4°C) or below.

 **FRONT (Defrost):** Use the front/defrost mode to remove fog or frost from the windshield more quickly. This mode directs most of the air to the windshield and the side window outlets, with some air directed to the floor outlets. This mode has a timer and will shut off after five minutes.

This mode will automatically use outside air. The air conditioning compressor will be engaged unless the outside temperature is 40° F (4°C) or below.

Temperature

The knob on the right of the climate control panel is the temperature adjustment that can be used with any of the climate control modes.

Turn the knob clockwise for warmer settings and counterclockwise for colder settings.

Air Conditioning

 **(Air Conditioner):** Press this button on the climate control panel to turn the air-conditioning system on or off. When A/C is pressed, an indicator light to the right of the button will come on to let you know that A/C is active. The instrument brightness control may have to be adjusted to the highest setting during the daytime in order to see the indicator lamp.

On hot days during initial start-up, open the windows to let hot inside air escape; then close them. This helps to reduce the time it takes for your vehicle to cool down. It also helps the system to operate more efficiently.

For quicker cool down on hot days, do the following:

1. Select the vent/outside air mode.
2. Select the recirculation mode.
3. Select the air conditioner.
4. Select the coolest temperature.
5. Select the highest fan speed.

Using these settings together for long periods of time may cause the air inside your vehicle to become too dry. To prevent this from happening, select the vent mode once the interior of the vehicle is cooled.

The air-conditioning system removes moisture from the air, so you may sometimes notice a small amount of water dripping underneath your vehicle while idling or after turning off the engine. This is normal.

Recirculation

 **(Recirculation):** Press this button on the climate control panel to activate the recirculation mode. With this selection inside air is recirculated into the vehicle along with some outside air. This mode reduces outside air and odors from entering your vehicle. It may also help to heat or cool the air inside your vehicle more quickly.

When this button is pressed an indicator lamp to the right of the button will come on to indicate that the recirculation mode is on. An adjustment to the instrument panel brightness control to the highest setting may be required to see the indicator lamp.

The recirculation mode has a timer. After five minutes, the system's air inlet door will move slightly to allow for ten percent fresh outside air to maintain interior air quality. The only way to reset the system to full recirculation is to restart the five minute timer by selecting vent/outside air and recirculation again.

Rear Window Defogger

The rear window defogger uses a warming grid to remove fog or frost from the rear window. Be sure to clear as much snow from the rear window as possible.

Notice: Don't use a razor blade or something else sharp on the inside of the rear window. If you do, you could cut or damage the defogger and the repairs would not be covered by your warranty. Do not attach a temporary vehicle license, tape, a decal or anything similar to the defogger grid.

 **(REAR):** Press this button to turn the rear window defogger on or off.

When this button is pressed an indicator light to the right of the button will come on to show that the rear window defogger is active. The instrument brightness control may have to be adjusted to the highest setting during the daytime in order to see the indicator light.

The rear window defogger will turn off approximately 20 minutes after the button is pressed. If reselected, it will run another 20 minutes. The defogger can be turned off by pressing the button again or by turning off the engine.

Do not drive the vehicle until all windows are clear.

Outlet Adjustment



Rotate and turn the air outlets, located in the middle and at each outboard side of the instrument panel, to adjust the direction of the airflow.

See *Instrument Panel Overview* on page 3-2 for additional information on location.

Operation Tips

- Clear away any ice, snow or leaves from the air inlets at the base of the windshield that may block the flow of air into your vehicle.
- Use of non-GM approved hood deflectors may adversely affect the performance of the system.
- Keep the path under the front seats clear of objects to help circulate the air inside of your vehicle more effectively.
- If the airflow seems low when the fan is at the highest setting, the passenger compartment air filter may need to be replaced. See “Passenger Compartment Air Filter” following, for more information on this filter.

Passenger Compartment Air Filter

The passenger compartment air filter is located underneath the inlet grille, which is located under the passenger side windshield wiper arm.

The filter traps most of the pollen from entering the climate control system. Similar to the engine's air filter, it may need to be changed periodically to insure system performance. See *Part A: Scheduled Maintenance Services* on page 6-4 for information on scheduled changes for this filter.

To change the passenger compartment air filter, do the following:

1. Put the ignition in ACCESSORY and turn the windshield wipers on.
2. Turn the ignition to off when the windshield wipers are in the upright position.
3. Raise the hood.
4. Disconnect the windshield washer pump hose from the fender rail and the air inlet grille.
5. Remove the hood weather-strip from the passenger's side of the vehicle, peeling it back halfway to the center.



6. Remove the air inlet grille retainers.
7. Remove the air inlet grille.

8. Remove the passenger compartment air filter by pulling up on the tab.



9. Install a new passenger compartment air filter. Make sure it slides under the compartment retainers.
10. Reverse steps 1 through 7.

Warning Lights, Gages and Indicators

This part describes the warning lights and gages that may be on your vehicle. The pictures will help you locate them.

Warning lights and gages can signal that something is wrong before it becomes serious enough to cause an expensive repair or replacement. Paying attention to your warning lights and gages could also save you or others from injury.

Warning lights come on when there may be or is a problem with one of your vehicle's functions. As you will see in the details on the next few pages, some warning lights come on briefly when you start the engine just to let you know they're working. If you are familiar with this section, you should not be alarmed when this happens.

Gages can indicate when there may be or is a problem with one of your vehicle's functions. Often gages and warning lights work together to let you know when there's a problem with your vehicle.

When one of the warning lights comes on and stays on when you are driving, or when one of the gages shows there may be a problem, check the section that tells you what to do about it. Follow this manual's advice. Waiting to do repairs can be costly – and even dangerous. So please get to know your warning lights and gages. They're a big help.

Your vehicle also has a Driver Information Center (DIC) that works along with the warning lights and gages. See *Driver Information Center (DIC) on page 3-45* for more information.

Instrument Panel Cluster

Your instrument panel cluster is designed to let you know at a glance how your vehicle is running. You'll know how fast you're going, about how much fuel is in your tank and many other things you need to drive safely and economically.

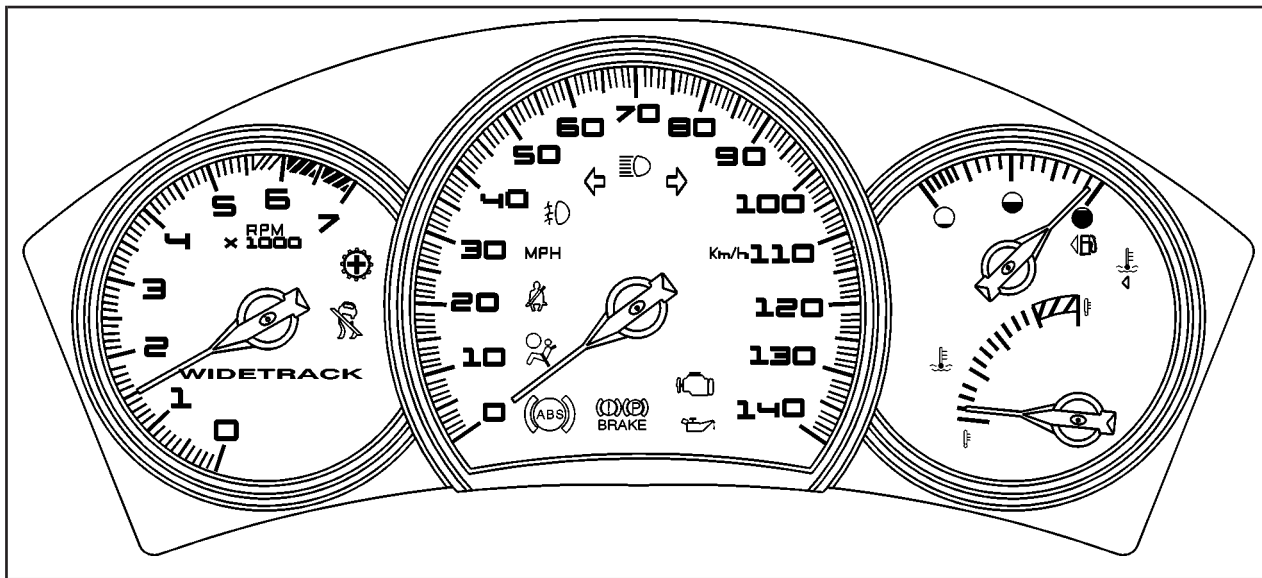

United States version shown, Canada similar

Your vehicle is equipped with this cluster or one very similar to it. It has indicator warning lights that are explained on the following pages. Be sure to read about them.

Speedometer and Odometer

The speedometer lets you see your speed in both miles per hour (mph) and kilometers per hour (km/h). The odometer, located on the Driver Information Center (DIC) display, shows how far your vehicle has been driven, in either miles or kilometers. See *DIC Controls and Displays on page 3-45* for more information.

If the vehicle has the Head-Up Display (HUD), the speed will also be displayed on the HUD screen.

You may wonder what happens if a vehicle has to have a new odometer installed. If the new one can be set to the mileage total of the old odometer, that will be done. If it can't, then it will be set at zero and a label must be put on the driver's door to show the old mileage reading when the new odometer was installed.

Trip Odometer

The trip odometer, located in the Driver Information Center (DIC), tells you how far you have driven since you last reset it. You are able to see the miles (kilometers) for two different trips. See *DIC Controls and Displays on page 3-45* for more information on setting the trip odometer.

Tachometer

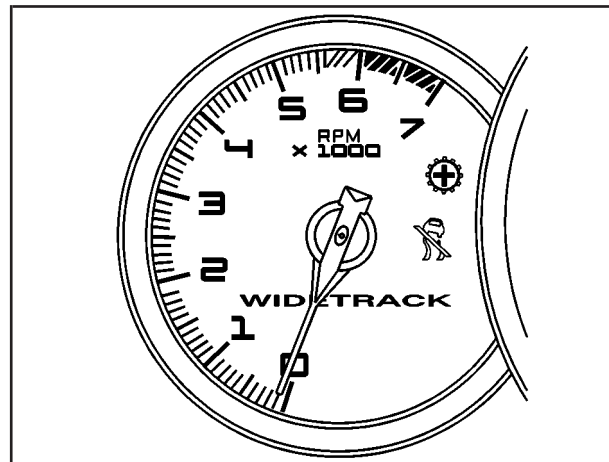

The tachometer displays the engine speed in revolutions per minute (rpm).

Notice: Do not operate the engine with the tachometer in the shaded warning area, or engine damage may occur.

Safety Belt Reminder Light

When the key is turned to RUN or START, a chime will come on for several seconds to remind people to fasten their safety belts, unless the driver's safety belt is already buckled.



The safety belt light will also come on and stay on for several seconds, then it will flash for several more.

If the driver's belt is already buckled, neither the chime nor the light will come on.

Air Bag Readiness Light

There is an air bag readiness light on the instrument panel, which shows the air bag symbol. The system checks the air bag's electrical system for malfunctions. The light tells you if there is an electrical problem.

The system check includes the air bag sensors, the air bag modules, the wiring and the diagnostic module. For more information on the air bag system, see *Air Bag Systems* on page 1-48.



This light will come on when you start your vehicle, and it will flash for a few seconds. Then the light should go out. This means the system is ready.

If the air bag readiness light stays on after you start the vehicle or comes on when you are driving, your air bag system may not work properly. Have your vehicle serviced right away.

⚠ CAUTION:

If the air bag readiness light stays on after you start your vehicle, it means the air bag system may not be working properly. The air bags in your vehicle may not inflate in a crash, or they could even inflate without a crash. To help avoid injury to yourself or others, have your vehicle serviced right away if the air bag readiness light stays on after you start your vehicle.

The air bag readiness light should flash for a few seconds when you turn the ignition key to RUN. If the light doesn't come on then, have it fixed so it will be ready to warn you if there is a problem.

Up-Shift Light

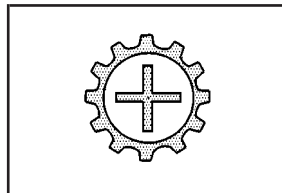

This symbol can appear on the instrument panel if the vehicle has a supercharged engine and the shift lever is in the MANUAL (M) transaxle position.

It will appear as a prompt to up-shift to the next gear using one of the TAP-Shift™ paddles located on the steering wheel.

This symbol will also appear on the Head Up Display (HUD).

See *Automatic Transaxle Operation* on page 2-22 for more information.

Brake System Warning Light

Your vehicle's hydraulic brake system is divided into two parts. If one part isn't working, the other part can still work and stop you. For good braking, though, you need both parts working well.

If the warning light comes on, there is a brake problem. Have your brake system inspected right away.



United States

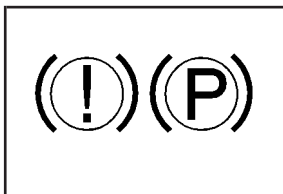

Canada

This light should come on briefly when you turn the ignition key to RUN. If it doesn't come on then, have it fixed so it will be ready to warn you if there's a problem.

When the ignition is on, the brake system warning light will also come on when you set your parking brake. The light will stay on if your parking brake doesn't release fully. If it stays on after your parking brake is fully released, it means you have a brake problem.

The PARKING BRAKE ON message will also appear in the Driver Information Center (DIC) when the parking brake is set.

The brake warning light may also come on when the brake fluid is low. If this occurs, the LOW BRAKE FLUID message will also appear in the Driver Information Center (DIC).

If the brake warning light comes on while you are driving, pull off the road and stop carefully. You may notice that the pedal is harder to push. Or, the pedal may go closer to the floor. It may take longer to stop. If the light is still on, have the vehicle towed for service. See *Towing Your Vehicle on page 4-33*.

CAUTION:

Your brake system may not be working properly if the brake system warning light is on. Driving with the brake system warning light on can lead to an accident. If the light is still on after you've pulled off the road and stopped carefully, have the vehicle towed for service.

Anti-Lock Brake System Warning Light

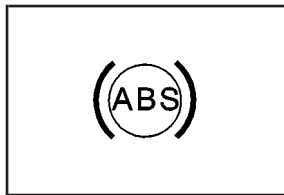

If your vehicle has the Anti-lock Brake System (ABS), this light will come on when your engine is started and may stay on for several seconds. That's normal.

If the ABS warning light comes on and stays on, there may be a problem with the anti-lock portion of the brake system. If the brake system warning light is not on, you still have brakes, but you don't have anti-lock brakes. See *Brake System Warning Light on page 3-36*.

If the light stays on, turn the ignition to OFF. If the light comes on when you're driving, stop as soon as possible and turn the ignition off. Then start the engine again to reset the system. If the light still stays on, or comes on again while you're driving, your vehicle needs service. If the regular brake system warning light isn't on, you still have brakes, but you don't have anti-lock brakes. If the brake system warning light is also on, you don't have anti-lock brakes and there's a problem with your regular brakes. See *Brake System Warning Light on page 3-36*.

The anti-lock brake system warning light will come on briefly when you turn the ignition key to RUN. This is normal. If the light doesn't come then, have it fixed so it will be ready to warn you if there is a problem.

Traction Control System (TCS) Warning Light

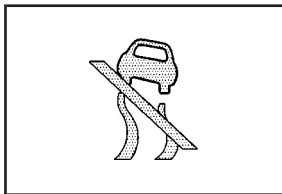

If your vehicle has a 3800 V6 supercharged engine, it may have the Traction Control System (TCS).

This light may come on for the following reasons:

- If you turn the system off by pressing the TC (traction control) button located on the center console, the light will come on and stay on. To turn the system back on, press the button again and the warning light should go out. See *Traction Control System (TCS) on page 4-10* for more information.
- If there's a brake system problem that is specifically related to traction control, the TCS will turn off and the warning light will come on. If your brakes begin to overheat, the TCS will turn off and the warning light will come on until the brakes cool down.

If the traction control system warning light comes on and stays on for an extended period of time when the system is turned on, your vehicle needs service.

Enhanced Traction System Warning Light

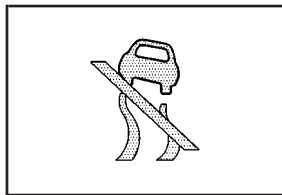

If your vehicle has the 3800 V6 engine and the Enhanced Traction System (ETS), this light may come on for the following reason.

- If you turn the system off by pressing the TC (traction control) button located on the center console, this light will come on and stay on. To turn the system back on, press the button again and the warning light should turn off. See *Enhanced Traction System (ETS) on page 4-11*.
- If the system is affected by an engine-related problem, the system will turn off and the warning light will come on.

If the light comes on and stays on for an extended period of time when the system is turned on, your vehicle needs service. Adjust your driving accordingly.

Engine Coolant Temperature Warning Light

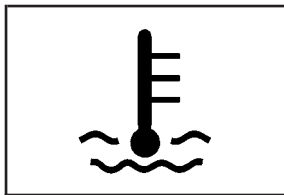

This light tells you that the engine coolant has overheated or the radiator cooling fan is not working.

If you have been operating the vehicle under normal driving conditions, you should pull off the road, stop the vehicle, and turn off the engine as soon as possible.

See *Cooling System* on page 5-32 for more information.

Engine Coolant Temperature Gage

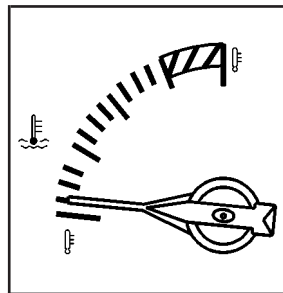

Your vehicle has a gage that shows the engine coolant temperature.

If the gage pointer moves into the shaded area, the engine is too hot. That reading means the engine coolant has overheated. If you have been operating the vehicle under normal driving conditions, you should pull off the road, stop the vehicle, and turn off the engine as soon as possible.

See *Cooling System* on page 5-32 for more information.

Malfunction Indicator Lamp

Check Engine Light

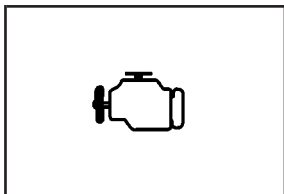

Your vehicle is equipped with a computer which monitors operation of the fuel, ignition and emission control systems.

This system is called OBD II (On-Board Diagnostics-Second Generation) and is intended to assure that emissions are at acceptable levels for the life of the vehicle, helping to produce a cleaner environment. The Check Engine light comes on to indicate that there is a problem and service is required. Malfunctions often will be indicated by the system before any problem is apparent. This may prevent more serious damage to your vehicle. This system is also designed to assist your service technician in correctly diagnosing any malfunction.

Notice: If you keep driving your vehicle with this light on, after a while, your emission controls may not work as well, your fuel economy may not be as good and your engine may not run as smoothly. This could lead to costly repairs that may not be covered by your warranty.

Notice: Modifications made to the engine, transaxle, exhaust, intake or fuel system of your vehicle or the replacement of the original tires with other than those of the same Tire Performance Criteria (TPC) can affect your vehicle's emission controls and may cause this light to come on. Modifications to these systems could lead to costly repairs not covered by your warranty. This may also result in a failure to pass a required Emission Inspection/Maintenance test.

This light should come on, as a check to show you it is working, when the ignition is on and the engine is not running. If the light doesn't come on, have it repaired. This light will also come on during a malfunction in one of two ways:

- **Light Flashing** — A misfire condition has been detected. A misfire increases vehicle emissions and may damage the emission control system on your vehicle. Diagnosis and service may be required.
- **Light On Steady** — An emission control system malfunction has been detected on your vehicle. Diagnosis and service may be required.

If the Light is Flashing

The following may prevent more serious damage to your vehicle:

- Reducing vehicle speed.
- Avoiding hard accelerations.
- Avoiding steep uphill grades.
- If you are towing a trailer, reduce the amount of cargo being hauled as soon as it is possible.

If the light stops flashing and remains on steady, see “If the Light Is On Steady” following.

If the light continues to flash, when it is safe to do so, *stop the vehicle*. Find a safe place to park your vehicle. Turn the key off, wait at least 10 seconds and restart the engine. If the light remains on steady, see “If the Light Is On Steady” following. If the light is still flashing, follow the previous steps, and see your dealer for service as soon as possible.

If the Light Is On Steady

You may be able to correct the emission system malfunction by considering the following:

Did you recently put fuel into your vehicle?

If so, reinstall the fuel cap, making sure to fully install the cap. See *Filling Your Tank on page 5-7*. The diagnostic system can determine if the fuel cap has been left off or improperly installed. A loose or missing fuel cap will allow fuel to evaporate into the atmosphere. A few driving trips with the cap properly installed should turn the light off.

Did you just drive through a deep puddle of water?

If so, your electrical system may be wet. The condition will usually be corrected when the electrical system dries out. A few driving trips should turn the light off.

Have you recently changed brands of fuel?

If so, be sure to fuel your vehicle with quality fuel. See *Gasoline Octane on page 5-4*. Poor fuel quality will cause your engine not to run as efficiently as designed. You may notice this as stalling after start-up, stalling when you put the vehicle into gear, misfiring, hesitation on acceleration or stumbling on acceleration. (These conditions may go away once the engine is warmed up.) This will be detected by the system and cause the light to turn on.

If you experience one or more of these conditions, change the fuel brand you use. It will require at least one full tank of the proper fuel to turn the light off.

If none of the above steps have made the light turn off, your dealer can check the vehicle. Your dealer has the proper test equipment and diagnostic tools to fix any mechanical or electrical problems that may have developed.

Emissions Inspection and Maintenance Programs

Some state/provincial and local governments have or may begin programs to inspect the emission control equipment on your vehicle. Failure to pass this inspection could prevent you from getting a vehicle registration.

Here are some things you need to know to help your vehicle pass an inspection:

Your vehicle will not pass this inspection if the Check Engine light is on or not working properly.

Your vehicle will not pass this inspection if the OBD (on-board diagnostic) system determines that critical emission control systems have not been completely diagnosed by the system. The vehicle would be considered not ready for inspection. This can happen if you have recently replaced your battery or if your battery has run down. The diagnostic system is designed to evaluate critical emission control systems during normal driving. This may take several days of routine driving. If you have done this and your vehicle still does not pass the inspection for lack of OBD system readiness, your GM dealer can prepare the vehicle for inspection.

Oil Pressure Light

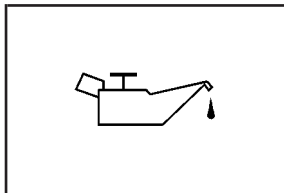

If you have a problem with your oil pressure, this light may stay on after you start the engine, or it may come on while you are driving.

This indicates that oil is not going through your engine quickly enough to keep it lubricated. The engine could be low on oil or could have some other oil problem. Have it fixed right away.

The oil light could also come on in two other situations:

- When the ignition is on but the engine is not running, the light will come on as a test to show you it's working. The light will go out when you turn the ignition to RUN. If it doesn't come on with the ignition on, you may have a problem with the fuse or bulb. See *Fuses and Circuit Breakers* on page 5-99.
- If you make a hard stop, the light may come on for a moment. This is normal.

CAUTION:

Don't keep driving if the oil pressure is low. If you do, your engine can become so hot that it catches fire. You or others could be burned. Check your oil as soon as possible and have your vehicle serviced.

Notice: Damage to your engine from neglected oil problems can be costly and is not covered by your warranty.

Fog Lamp Light

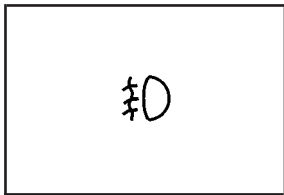

This light will come on when the fog lamps are in use.

The light will go out when the fog lamps are turned off. See “Fog Lamps” under *Exterior Lamps* on page 3-12 for more information.

High-Beam On Light

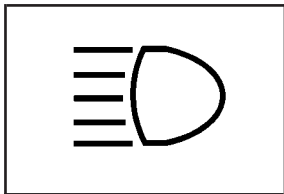

This light comes on whenever the high-beam headlamps are on.

See “Headlamp High/Low-Beam Changer” under *Exterior Lamps* on page 3-12 for additional information.

Fuel Gage

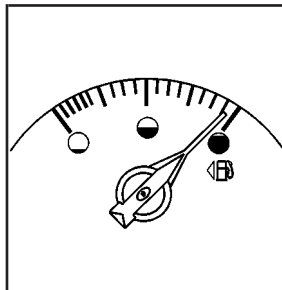

The fuel gage tells you about how much fuel you have left when the ignition is on.

When the indicator nears empty, you still have a little fuel left, but you should get more soon.

Here are four things owners usually ask about the fuel gage. All these situations are normal and do not indicate a problem with the fuel gage:

- At the gas station the pump shuts off before the gage reads full.
- It takes more or less fuel to fill up than the gage indicates. For example, the gage reads half full, but it took more or less than half the tank’s capacity to fill it.
- The gage pointer may move while cornering, braking or speeding up.
- The gage may not indicate full when the ignition is turned off.

Driver Information Center (DIC)

The Driver Information Center (DIC) gives you important safety and maintenance facts. When you turn the ignition on, all of the DIC lights illuminate for a few seconds and the phrase WIDETRACK GP will appear. After this, the DIC will begin working.

DIC Controls and Displays

Base Level DIC

The Driver Information Center (DIC) control buttons and the message display screen are located above the radio. The DIC gives you important safety and maintenance facts concerning the vehicle. The status of many of the vehicle's systems along with driver personalization menus and warning messages about your vehicle's systems may display on the DIC screen.

The vehicle's transaxle position will also appear.



The buttons on the base level are:

Trip Odometer

 (**Trip Odometer**): Press this button to access the odometer and trip distance modes.

When this button is pressed, the first menu on the DIC screen will be the odometer reading, or cumulative mileage of the vehicle. The odometer cannot be reset.

Press the trip odometer button to advance to the next menu.

Trip Distances: This menu shows the distances that the vehicle has driven between specific points. The trip odometer will record the number of miles up to 9,999.9 miles or 9 999.9 km travelled for up to two trips. When 9,999.9 miles or 9 999.9 km is reached for either trip, the odometer for that trip will go back to zero.

Press the trip odometer button again to access TRIP A.
Press the trip odometer button again to access TRIP B.
To reset the trip odometer(s) back to zero miles or kilometers, access the trip you want to reset and press the set/reset button.

The trip odometer has a feature called the retro-active reset. This can be used to set the trip odometer to the number of miles or kilometers driven since the ignition was last turned on. This can be used if you forget to reset your trip odometer at the beginning of the trip.

To use the retro-active reset feature, press and hold the set/reset button for at least three seconds. The trip odometer will display the number of miles or kilometers driven since the ignition was last turned on and you began driving. Once you begin driving, the trip odometer will accumulate mileage. For example, if you have driven 5.0 miles (8.0 km) since you started the vehicle, and then activate the retro-active reset feature, the display will show 5.0 miles (8.0 km) since you started your vehicle. As you drive, the display will then increase to 5.1 miles (8.2 km), 5.2 miles (8.4 km), etc.

If the retro-active reset feature is activated after the vehicle is started, but before it begins moving, the display will show the number of miles or kilometers that were driven during the last ignition cycle.

Press the trip odometer button again to access the odometer.

Set/Reset

 **(Set/Reset):** Press this button to set or reset a menu item when using the trip odometer or options buttons.

Options

i (Options): Press this button to access the Date, Language, Display Units, Daytime Display Enhancements, Engine Oil Monitor System, Tire Inflation Monitor System and Personal Programming modes.

Date: This menu lets you select the date. The time is set through the radio. See *Setting the Time on page 3-88* for more information. To set the date use the following procedure:

1. Press the options button until the date is displayed on the DIC.
2. Press the set/reset button to scroll to the second position in the year, releasing the button when the correct digit appears.
3. Press the set/reset button to advance to the first position in the year, releasing the button when the correct digit appears.

4. Press the options button to advance to the months of the year.
5. Press the set/reset button to scroll through the months of the year, releasing the button when the correct month appears.
6. Press the options button to advance to the days of the month.
7. Press the set/reset button to scroll through the days of the month, releasing the button when the correct day appears.
8. Press the options button again to advance to the next screen.

Language: This menu lets you select the language in which you want the DIC messages to appear. The DIC can be programmed to one of three languages: English, French or Spanish. The message on the HUD, if equipped, will also appear in the language selected.

To change the language use the following procedure:

1. Press the options button until the language in which you want the messages to appear on the screen is displayed.
2. Press the set/reset button to set the language choice.
3. Press the options button again to advance to the next screen.

Display Units: This menu allows you to choose whether measurements are displayed in English or metric units. The messages on the HUD, if equipped, and the instrument panel cluster will also appear in the type of measurement selected.

To set the measurement, when this message is displayed use the following procedure:

1. Press the set/reset button to select ENGLISH or METRIC.
2. Press the options button again to advance to the next screen.

DAYTIME DISPLAY ENHANCEMENTS: This menu allows you to select the color of the display message. When ON is selected for the daytime enhancement, the messages will appear black on a red screen. This combination makes it easier to see the DIC messages during the daytime. When OFF is selected, or when the headlamps are on, the messages will appear red on a black background.

To set the daytime display enhancements use the following procedure:

1. Press the set/reset button to select OFF or ON.
2. Press the options button again to advance to the next screen.

ENGINE OIL MONITOR SYSTEM: This menu lets you reset the engine oil monitor system for the vehicle. See “When to Change Engine Oil (GM Oil Life System)” under *Engine Oil on page 5-16*.

To reset the engine oil monitor system use the following procedure:

1. Press the set/reset button after an oil change to reset the engine oil monitor system. The confirmation, **ENGINE OIL MONITOR HAS BEEN RESET**, will appear on the next screen.
2. Press the options button again to advance to the next screen.

Tire Inflation Monitor System: If the vehicle has ABS, this menu lets you set the tire inflation monitor system. See “Tire Inflation Monitor System” under *Inflation – Tire Pressure on page 5-69* for more information.

To set or reset the tire inflation monitor system, use the following procedure:

1. Press the set/reset button to reset the tire inflation monitor system. **TIRE INFLATION HAS BEEN SET** will appear on the next screen to confirm this system has been set.
2. Press the options button again to advance to the next screen.

Select the set/reset button to return to the main (date) screen.

PERSONAL PROGRAMMING MODE: This menu lets you customize the time the exterior and interior lamps are left on, and, when the automatic door locks are activated after the vehicle is turned off and the doors are closed. These adjustments can only be made while the vehicle is in PARK (P). Press the set/reset button to display the first screen.

Personal Programming Mode Screens

Press the options button to access these modes:

EXTERIOR LIGHTING DELAY: This screen lets you turn this feature off, or lets you select the number of seconds the headlamps, sidelamps and taillamps, fog lamps and back-up lamps are turned on after the key is removed from the ignition or the vehicle is unlocked using the remote keyless entry transmitter.

If OFF is selected, the exterior lamps will not turn on.

If a time delay is selected, the lamps will turn on (for the time selected), when the key is removed from the ignition, or when the vehicle is unlocked using the remote keyless entry transmitter.

To program this mode use the following procedure:

1. Press and release the set/reset button to scroll to the selection you want to program. Choose from OFF or 15, 30, 60 or 90 seconds.
2. Press the options button again to advance to the next screen.

INTERIOR LIGHTS WHEN DOOR CLOSED: This screen lets you select this feature to be turned OFF or ON.

If OFF is selected, the interior lamps will turn off immediately when the ignition is OFF and the last door is closed.

If ON is selected, the interior lamps will stay on for about 25 seconds after the vehicle's ignition is off and the last door is closed.

To program this mode use the following procedure:

1. Press and release the set/reset button to scroll to either OFF or ON.
2. Press the options button again to advance to the next screen.

INTERIOR LIGHTS WHEN KEY REMOVED: This screen lets you select this feature to be turned OFF or ON. This feature enables the interior lamps in the vehicle to turn on for about 25 seconds after the key is removed from the ignition.

If OFF is selected, removing the key from the ignition will not cause the interior lamps to turn on.

If ON is selected, removing the key from the ignition will cause the interior lamps to be turned on for about 25 seconds.

To program this mode use the following procedure:

1. Press and release the set/reset button to scroll to either OFF or ON.
2. Press the options button again to advance to the next screen.

AUTO DOOR LOCK: This screen lets you select this feature to be turned OFF or ON.

If OFF is selected, all automatic door locking is disabled. The doors will always need to be locked manually before driving, to increase occupant safety.

If ON is selected, the vehicle's doors automatically lock when the doors are closed and the vehicle is shifted into DRIVE (D).

To program this mode use the following procedure:

1. Press and release the set/reset button to scroll to either OFF or ON.
2. Press the options button again to advance to the next screen.

AUTO DOOR UNLOCK: This screen can be used if ON was selected for the AUTO DOOR LOCK feature. This screen lets you select this feature to be turned off, used for the driver's door only, or for all the doors.

If OFF is selected, none of the doors will unlock when the vehicle's transaxle is shifted into PARK (P).

If DRIVER is selected, only the driver's door will unlock when the vehicle's transaxle is shifted into PARK (P).

If ALL is selected, all the doors will unlock when the vehicle's transaxle is shifted into PARK (P).

To program this mode use the following procedure:

1. Press and release the set/reset button to scroll to either OFF, DRIVER or ALL.
2. Press the options button again to advance to the next screen.

AUTO DOOR LOCK ON: If DRIVER or ALL was selected on the AUTO DOOR UNLOCK screen, this screen lets you select when the vehicle's doors will unlock. The choices are when the key is removed from the ignition or when the vehicle is shifted into PARK (P).

If KEY-OUT is selected, the auto door unlock will function when the key is taken out of the ignition.

If PARK is selected, the auto door unlock will function when the transaxle is shifted into PARK (P).

To program this mode use the following procedure:

1. Press and release the set/reset button to scroll to either KEY-OUT or PARK.
2. Press the options button again to advance to the next screen

DELAYED LOCKING: This screen lets you select whether this feature will be turned OFF or ON. The key must be out of the ignition for this feature to work.

If OFF is selected, there will be no delayed locking of the vehicle's doors.

If ON is selected, the locking of the vehicle's doors will be delayed by 25 seconds after a power door lock switch is pressed after a door is open, or the LOCK button on the remote keyless entry transmitter is pressed while any door is open.

To program this mode use the following procedure:

1. Press and release the set/reset button to scroll to either OFF or ON.
2. Press the options button again to advance to the next screen.

REMOTE LOCKS FEEDBACK: This screen lets you select this option to be turned OFF, or lets you choose from two methods of verification, LIGHTS or LIGHTS and HORN, that indicate the vehicle's doors are locked when the LOCK button on the remote keyless entry transmitter is pressed.

If OFF is selected, this feature will not be programmed.

If LIGHTS is selected, the exterior lamps will flash when the LOCK button on the remote keyless entry transmitter is pressed.

If LIGHTS and HORN are selected, the exterior lamps will flash when the lock button on the remote keyless entry transmitter is pressed and the horn will sound when the LOCK button on the remote keyless entry transmitter is pressed again within five seconds of the previous command.

To program this mode use the following procedure:

1. Press the set/reset button to scroll to OFF, LIGHTS, or LIGHTS and HORN.
2. Press the options button again to advance to the next screen.

If the vehicle does not have a content theft-deterrent system, the next screens with PROGRAMMED FINISHED and DISPLAY OFF will appear.

If the vehicle does have a content theft-deterrent system, the next screen will appear.

THEFT DETERRENT: Your vehicle may have a content theft-deterrent system. Once it is turned on, the system will activate if someone tries to enter the vehicle without using the remote keyless entry transmitter or the correct key. It will also activate when an incorrect key is used in the ignition. This screen lets you select this feature to be turned OFF or ON.

If OFF is selected, the theft-deterrent system will not function.

If ON is selected, the theft-deterrent system will be activated.

To program this mode use the following procedure:

1. Press the set/reset button to scroll to OFF or ON.
2. Press the options button again to advance to the next screen.

KEY CYLINDER DISARM: If the vehicle has a content theft-deterrent system this screen lets you select this feature to be turned OFF or ON.

If OFF is selected, the content theft-deterrent system will not disarm when the vehicle is unlocked using the door lock – or when someone tampers with the door lock.

If ON is selected, the content theft-deterrent system will disarm when the vehicle is unlocked using the door lock. This makes the vehicle more resistant to key lock tampering.

To program this mode use the following procedure:

1. Press the set/reset button to scroll to OFF or ON.
2. Press the options button again to advance to the next screen.

LOCK SWITCH ARM: If the vehicle has a content theft-deterrent system and ON was selected on the THEFT DETERRENT screen, this screen lets you select this feature to be turned OFF or ON. If ON is selected, the content theft-deterrent system starts the arming process when a lock switch is pressed while the door is open.

If OFF is selected, the theft-deterrent system will not activate this feature.

If ON is selected, the content theft-deterrent system will arm when the doors are locked with the door lock switch. The key must be removed from the ignition when the doors are locked or the content theft-deterrent system will not arm.

To program this mode use the following procedure:

1. Press the set/reset button to scroll to OFF or ON.
2. Press the options button again to advance to the next screen.

PROGRAMMING FINISHED: This confirms that the personal options programming is complete.

DISPLAY OFF: The screen will “count down” and then go blank. Press the options button to advance to a new screen.

Uplevel DIC with Trip Computer

The Driver Information Center (DIC) control buttons and the message display screen are located above the radio. The DIC gives you important safety and maintenance facts concerning the vehicle. The status of many of the vehicle's systems along with driver personalization menus and warning messages about your vehicle's systems may display on the DIC screen.

The outside temperature automatically appears on the bottom right corner of the DIC display screens. If the outside temperature is below 38°F (3°C), the temperature reading will toggle between displaying the outside temperature and the word ICE for two minutes. If there is a problem with the system that controls the temperature display, the letters OC (Open Circuit) or SC (Short Circuit) will appear on the display. If this occurs, have the vehicle serviced by your dealer.

The vehicle's transaxle position, and the direction the vehicle is traveling will also appear on the DIC screen.

The compass is self-calibrating, which eliminates the need to manually set the compass. However, under certain circumstances, such as during a long distance cross-country trip, it will be necessary to compensate for compass variance and reset the zone through the DIC. See "Setting the Compass" later in this section for more information.



The buttons on the DIC trip computer are:

Gages

 **(Gages):** Press this button to access the OIL LIFE REMAINING, TRANSMISSION FLUID TEMPERATURE, BATTERY, ENGINE HOURS AND ENGINE BOOST modes.

OIL LIFE REMAINING: Press the gage button until OIL LIFE REMAINING is displayed. This screen indicates the percentage of oil life in the vehicle's engine that has not degraded. If the screen indicates 99% OIL LIFE REMAINING, this means that 99 percent of the current oil life remains. When the oil life drops below five percent, the CHANGE OIL SOON message will appear on the display. The engine oil should be changed within 200 miles. Be sure to keep a record of the mileage and date of the oil change so you will have it for future reference.

Never drive the vehicle more than 10,000 miles (16 000 km) or 12 months (whichever comes first) without an oil change.

After the oil has been changed in the vehicle, reset the ENGINE OIL MONITOR screen in the options menu.

Press the gages button again to advance to the next screen.

TRANSMISSION FLUID TEMP: This screen displays this message along with the temperature (F° or C°) of the transmission fluid.

Press the gages button again to advance to the next screen.

BATTERY: This screen displays the amount of volts the battery is generating.

Press the gages button again to advance to the next screen.

ENGINE HOURS: This screen shows the number of cumulative hours the engine has operated while the key was in the RUN position. This screen cannot be reset.

Press the gages button to scroll to the next screen.

ENGINE BOOST: If the vehicle has the supercharged engine, this screen will appear. It shows a graphic that indicates the amount of boost the engine is receiving.

Press the gages button again to scroll to the next screen.

Trip Odometer

 **(Trip Odometer):** Press this button to access the Odometer, Trip Distances, AVERAGE SPEED and TIME ELAPSED modes.

Odometer: When the trip odometer button is pressed, the first menu displayed on the DIC screen is the odometer reading, or cumulative mileage of the vehicle. The odometer cannot be reset.

Press the trip odometer button again to advance to the next menu.

Trip Distances: This menu shows the distances that the vehicle has driven between specific points. The trip odometer will record the number of miles up to 9,999.9 miles or 9 999.9 km travelled for up to two trips. When 9,999.9 miles or 9 999.9 km is reached for either trip, the odometer for that trip will go back to zero.

To reset the trip distances use the following procedures:

1. Press the trip odometer button again to access TRIP A. Press the trip odometer button again to access TRIP B. To reset the trip odometer(s) back to zero miles or to zero kilometers, access the trip you want to reset and press the set/reset button.
2. Press the trip odometer button again to access the odometer.

The trip odometer has a feature called the retro-active reset. This can be used to set the trip odometer to the number of miles (kilometers) driven since the ignition was last turned on. This can be used if you forget to reset your trip odometer at the beginning of the trip.

To use the retro-active reset feature, press and hold the set/reset button for at least three seconds. The trip odometer will display the number of miles or kilometers driven since the ignition was last turned on and you began driving. Once you begin driving, the trip odometer will accumulate mileage. For example, if you have driven 5.0 miles (8.0 km) since you started the vehicle, and then activate the retro-active reset feature, the display will show 5.0 miles (8.0 km) since you started your vehicle. As you drive, the display will then increase to 5.1 miles (8.2 km), 5.2 miles (8.4 km), etc.

If the retro-active reset feature is activated after the vehicle is started, but before it begins moving, the display will show the number of miles or kilometers that were driven during the last ignition cycle.

Average Speed: The average speed is displayed in miles per hour (mph) or kilometers per hour (km/h). The average speed is calculated from the various vehicle speeds recorded since the last reset of this menu item. To reset the average speed, press the set/reset button. The display will return to zero.

Press the trip odometer button again to advance to the next screen.

Time Elapsed: This screen can be used as a stopwatch. The display can show the hours, minutes, seconds and hundredths of a second. The elapsed time indicator will record up to 99 hours, 59 minutes and 59 seconds, then it will reset to zero and continue counting.

To set the time elapsed function use the following procedures:

1. Press the trip odometer button for less than two seconds to start or stop the timer.
2. Press and hold the trip odometer button for more than two seconds to reset the timer back to zero.

Set/Reset

 **(Set/Reset):** Press this button to set or reset a mode item when using the trip odometer or option buttons.

Options

i (Options): Press this button to access the Date, Language, Display Units, Daytime Display Enhancements, Engine Oil Monitor System, Tire Inflation Monitor System, Compass Calibration and the Personal Programming modes.

Date: This menu lets you select the date.

The time is set through the radio. See *Setting the Time on page 3-88* for more information.

To set the date use the following procedure:

1. Press the options button until the date is displayed on the DIC.
2. Press the set/reset button to scroll to the second position in the year, releasing the button when the correct digit appears.
3. Press the set/reset button to advance to the first position in the year, releasing the button when the correct digit appears.
4. Press the options button to advance to the months of the year.

5. Press the set/reset button to scroll through the months of the year, releasing the button when the correct month appears.
6. Press the options button to advance to the days of the month.
7. Press the set/reset button to scroll through the days of the month, releasing the button when the correct day appears.
8. Press the options button again to advance to the next screen.

Language: This menu lets you select the language in which you want the DIC messages to appear. The DIC can be programmed in one of three languages: English, French or Spanish. The message on the HUD, if equipped, will also appear in the language selected.

To change the language use the following procedure:

1. Press the options button until the language you want the messages to appear on the screen is displayed.
2. Press the set/reset button to set the language choice.
3. Press the options button again to advance to the next screen.

Display Units: This menu allows you to choose whether measurements are displayed in English or metric units. The messages on the HUD, if equipped, and the instrument panel cluster will also appear in the type of measurement selected.

To set the display units function use the following procedure:

1. Press the set/reset button to select ENGLISH or METRIC.
2. Press the options button to advance to the next screen.

DAYTIME DISPLAY ENHANCEMENTS: This menu allows you to select the color of the display message. When ON is selected for the daytime enhancement, the messages will appear black on a red screen. This combination makes it easier to see the DIC messages during the daytime. When OFF is selected, or when the headlamps are on, the messages will appear red on a black background.

To set the daytime display enhancements function use the following procedure:

1. Press the set/reset button to select Off or ON.
2. Press the options button to advance to the next screen.

ENGINE OIL MONITOR SYSTEM: This menu lets you reset the engine oil monitor system for the vehicle. See “When to Change Engine Oil (GM Oil Life System)” under *Engine Oil on page 5-16*.

To reset the engine oil monitor system use the following procedure:

1. Press the set/reset button to reset the engine oil monitor system. The confirmation, ENGINE OIL MONITOR HAS BEEN RESET, will appear on the next screen.
2. Press the options button again to advance to the next screen.

Tire Inflation Monitor System: If the vehicle has ABS, this menu lets you set the tire inflation monitor system. See “Tire Inflation Monitor System” under *Inflation – Tire Pressure on page 5-69* for more information.

To set or reset the tire inflation monitor system use the following procedures:

1. Press the set/reset button to reset the tire inflation monitor system. TIRE INFLATION HAS BEEN SET will appear on the next screen to confirm this system has been set.
2. Press the options button again to advance to the next screen.
Select the set/reset button to return to the main (date) screen.

COMPASS CALIBRATION MODE:

Setting the Compass

The compass is self-calibrating, which eliminates the need to manually set the compass.

However, under certain circumstances, such as during a long distance cross-country trip, it will be necessary to compensate for compass variance and reset the zone through the DIC.

Compass variance is the difference between earth’s magnetic north and true geographic north. If not adjusted to account for compass variance, the compass in your vehicle could give you false readings.

In order to do this, you will have to set or calibrate the compass to the variance zone in which you are located.

To adjust for compass variance use the following procedure:

1. Find your current location and variance zone number on the map.

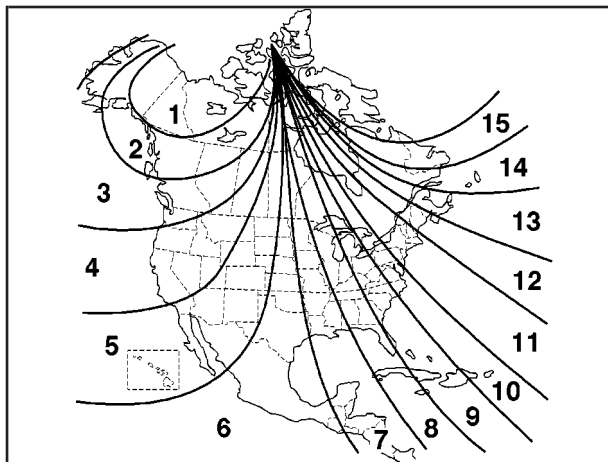

2. Press the set/reset button to scroll through the variance zones and select the one in which you are located.

3. Press the options button to advance to the calibration screen.
4. Drive the vehicle in a circle two times to activate the compass.

The direction the vehicle is moving will be displayed in the bottom left corner of the screen, and will appear in the gauges, fuel, trip and some of the options modes.

Press the options button again to advance to the next screen.

PERSONAL PROGRAMMING MODE: This menu lets you customize the time the exterior and interior lamps remain on, and when the automatic door locks are activated, after the doors of the vehicle are closed. These adjustments can only be made while the vehicle is in PARK (P). Press the set/reset button to display the first screen.

Press the options button to access these modes:

EXTERIOR LIGHTING DELAY: This screen lets you turn this feature off, or lets you select the number of seconds the headlamps, sidelamps, taillamp, fog lamps and back-up lamps are turned on after the key is removed from the ignition or the vehicle is unlocked using the remote keyless entry transmitter.

If OFF is selected, the exterior lamps will not turn on.

If a time delay is selected, the lamps will turn on (for the time selected), when the key is removed from the ignition, or the key is removed from the ignition or when the vehicle is unlocked using the remote keyless entry transmitter.

To program this mode use the following procedure:

1. Press and release the set/reset button to scroll to the selection you want to program. Choose from OFF, or 15, 30, 60, or 90 seconds.
2. Press the options button again to advance to the next screen.

INTERIOR LIGHTS WHEN DOOR CLOSED: This screen lets you select this feature to be turned OFF or ON.

If OFF is selected, the interior lamps will turn off immediately when the ignition is OFF and the last open door is closed.

If ON is selected, the interior lamps will stay on for about 25 seconds after the vehicle's ignition is off and the last open door is closed.

To program this mode use the following procedure:

1. Press and release the set/reset button to scroll to either OFF or ON.
2. Press the options button again to advance to the next screen.

INTERIOR LIGHTS WHEN KEY REMOVED: This screen lets you select this feature to be turned OFF or ON. This feature enables the interior lamps in the vehicle to turn on for about 25 seconds after the key is removed from the ignition.

If OFF is selected, removing the key from the ignition will not cause the interior lamps to turn on.

If ON is selected, removing the key from the ignition will cause the interior lamps to be turned on for about 25 seconds.

To program this mode use the following procedure:

1. Press and release the set/reset button to scroll to either OFF or ON.
2. Press the options button again to advance to the next screen.

AUTO DOOR LOCK: This screen lets you select this feature to be turned OFF or ON.

If OFF is selected, all automatic door locking is disabled. The doors will always need to be locked manually before driving, to increase occupant safety.

If ON is selected, the vehicle's doors automatically lock when the doors are closed and the vehicle is shifted into DRIVE (D).

To program this mode use the following procedure:

1. Press and release the set/reset button to scroll to either OFF or ON.
2. Press the options button again to advance to the next screen.

AUTO DOOR UNLOCK: This screen can be used if ON was selected for the AUTO DOOR LOCK feature. This screen lets you select this feature to be turned off, used for the driver's door only, or for all the doors.

If OFF is selected, none of the doors will unlock when the vehicle's transaxle is shifted into PARK (P).

If DRIVER is selected, only the driver's door will unlock when the vehicle's transaxle is shifted into PARK (P).

If ALL is selected, all the doors will unlock when the vehicle's transaxle is shifted into PARK (P).

To program this mode use the following procedure:

1. Press and release the set/reset button to scroll to either OFF, DRIVER or ALL.
2. Press the options button again to advance to the next screen.

AUTO DOOR LOCK ON: If DRIVER or ALL was selected on the AUTO DOOR UNLOCK screen, this screen lets you select when the vehicle's doors will unlock. The choices are when the key is removed from the ignition or when the vehicle is shifted into PARK (P).

If KEY-OUT is selected, the auto door unlock will function when the key is taken out of the ignition.

If PARK is selected, the auto door unlock will function when the transaxle is shifted into PARK (P).

To program this mode use the following procedure:

1. Press and release the set/reset button to scroll to either KEY-OUT or PARK.
2. Press the options button again to advance to the next screen.

DELAYED LOCKING: This screen lets you select whether this feature will be turned OFF or ON. The key must be out of the ignition for this feature to work.

If OFF is selected, there will be no delayed locking of the vehicle's doors.

If ON is selected, the locking of the vehicle's doors will be delayed by 25 seconds after a power door lock switch is pressed while the door is open, or the LOCK button on the remote keyless entry transmitter is pressed while any door is open.

To program this mode use the following procedure:

1. Press and release the set/reset button to scroll to either OFF or ON.
2. Press the options button again to advance to the next screen.

REMOTE LOCKS FEEDBACK: This screen lets you select this option to be turned OFF, or lets you choose from two methods of verification, LIGHTS or LIGHTS and HORN, that indicate the vehicle's doors are locked when the LOCK button on the remote keyless entry transmitter is pressed.

If OFF is selected, this feature will not be programmed.

If LIGHTS is selected, the exterior lamps will flash when the lock button on the remote keyless entry transmitter is pressed.

If LIGHTS and HORN is selected, the exterior lamps will flash when the lock button on the remote keyless entry transmitter is pressed, and the horn will sound when the LOCK button on the remote keyless entry transmitter is pressed again within five seconds of the previous command.

To program this mode use the following procedure:

1. Press the set/reset button to scroll to OFF, LIGHTS or LIGHTS and HORN.
2. Press the options button again to advance to the next screen.

If the vehicle does not have a content theft-deterrent system, the next screens with PROGRAMMED FINISHED and DISPLAY OFF will appear.

If the vehicle does have a content theft-deterrent system, the next screen will appear.

THEFT DETERRENT: Your vehicle may be equipped with a content theft-deterrent system. Once it is turned on, the system will activate if someone tries to enter the vehicle without using the remote keyless entry transmitter or the correct key. It will also activate when an incorrect key is used in the ignition. This screen lets you select this feature to be turned OFF or ON.

If OFF is selected, the theft-deterrent system will not function.

If ON is selected, the theft-deterrent system will be activated.

To program this mode use the following procedure:

1. Press the set/reset button to scroll to OFF or ON.
2. Press the options button again to advance to the next screen.

KEY CYLINDER DISARM: This screen lets you select this feature to be turned OFF or ON. This mode arms the vehicle's ignition so that if a key other than the one that came with the vehicle is used to try to start it, the horn will sound.

If OFF is selected, the content theft-deterrent system will not disarm when the vehicle is unlocked using the door lock, or if someone tampers with the door lock.

If ON is selected, the content theft-deterrent system will disarm when the vehicle unlocked using the door key cylinder. This alerts the content theft-deterrent system to start the arming process when a lock switch is pressed while the door is open.

To program this mode do use the following procedure:

1. Press the set/reset button to scroll to OFF or ON.
2. Press the options button again to advance to the next screen.

LOCK SWITCH ARM: If the vehicle is equipped with the content theft-deterrent system and ON was selected on the THEFT DETERRENT screen, this screen lets you select this feature to be turned OFF or ON.

If OFF is selected, the theft-deterrent system will not activate this feature.

If ON is selected, the content theft-deterrent system will arm when the doors are locked with the door lock switch. The key must be removed from the ignition when the doors are locked or the content theft-deterrent system will not arm.

To program this mode use the following procedure:

1. Press the set/reset button to scroll to OFF or ON.
2. Press the options button again to advance to the next screen.

PROGRAMMING FINISHED will appear on the next screen. This confirms that the personal options programming is complete.

DISPLAY OFF will appear on the next screen. This screen will "count down" and then go blank.

Fuel

 **(Fuel):** Press this button to access the Average Fuel Economy, Instantaneous Fuel Economy and Fuel Range modes.

AVG ECONOMY (Average Fuel Economy): This screen will display the approximate average miles per gallon (mpg) or liters per 100 kilometers (L/100 km). This number is calculated based on the number of mpg (L/100 km) recorded since the last time this menu item was reset.

To view the average fuel economy for the vehicle follow this procedure:

1. Press the set/reset button to reset to zero.
2. Press the fuel button again to advance to the next screen.

INST ECONOMY (Instantaneous Fuel Economy): This screen displays the current fuel economy at a particular moment and will change frequently as driving conditions change. Unlike average fuel economy, this screen cannot be reset.

Press the fuel button again to advance to the next screen.

RANGE: This screen displays the approximate number of remaining miles or kilometers you can drive without refueling. This estimate is based on the average fuel economy for the amount of fuel remaining in the fuel tank and the current driving conditions. This estimate will change if driving conditions change. For example, if you are driving in traffic and making frequent stops, the display may read one number, but if you enter the freeway, the number may change even though the same amount of fuel is in the fuel tank. This is because different driving conditions produce different fuel economies. Generally, freeway driving produces better fuel economy than city driving.

If the fuel tank contains less than 2 gallons (7.6 L), the LOW FUEL message will appear on the DIC screen. Fill the fuel tank as soon as possible to avoid running out of fuel.

See "Low Fuel" under *DIC Warnings and Messages on page 3-65*.

DIC Warnings and Messages

These messages will appear if there is a problem in one of the vehicle's systems. They will override any other mode or screen the DIC may be in.

Some messages allow you to erase them from the DIC screen. To do this you must acknowledge the message. To acknowledge or clear the message from the screen, press the set/reset button on the DIC. See *DIC Controls and Displays on page 3-45* for DIC button descriptions.

Other warning messages are not allowed to be erased until the problem indicated by the warning message is taken care of. When the problem indicated by the message is resolved, it can be acknowledged and the screen can be reset.

Be sure to take any message that appears on the DIC screen seriously and remember that clearing the messages that are able to be acknowledged, will only make the message disappear, not the problem.

A/C OFF FOR ENGINE PROTECTION

This warning message appears when the engine coolant becomes hotter than the normal operating temperature. To avoid added strain on a hot engine, the air conditioning compressor is automatically turned off. When the coolant temperature returns to normal, the air conditioning compressor will turn back on. You can continue to drive your vehicle.

This warning message will display while the ignition is in RUN. A chime will sound for two seconds when this message is displayed. Press the set/reset button to acknowledge this warning message and to clear it from the screen.

This message will continue to display if it has not been acknowledged when the engine is turned off. It will also re-display for three seconds if the message has been acknowledged, but the condition still exists when the engine is turned off.

The message will re-appear when the engine is turned on and the condition still exists.

AJAR

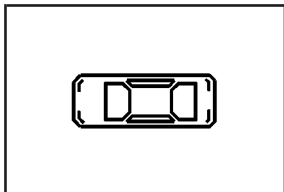

This symbol appears with the AJAR warning message.

This warning message appears when a door, the trunk or the hood of the vehicle is not properly closed. The graphic will highlight the hood or trunk if either one is not closed properly. The graphic will indicate a highlighted, open door to show which door or doors are not properly closed.

This warning message will display while the ignition is in RUN. A chime will sound for two seconds when the ignition is shifted out of PARK (P). Press the set/reset button to acknowledge this warning message and to clear it from the screen.

This message will continue to display if it has not been acknowledged when the engine is turned off. It will also re-display for three seconds if the message has been acknowledged, but the condition still exists when the engine is turned off.

The message will re-appear when the engine is turned on and the condition still exists.

CHANGE OIL SOON



This symbol appears with the CHANGE OIL SOON warning message.

This warning message indicates that the life of the engine oil has expired and it should be changed within 200 miles. See *Engine Oil on page 5-16* for more information.

When you reset the CHANGE OIL SOON message by acknowledging the message, you must also reset the ENGINE OIL MONITOR SYSTEM screen under the options menu on the DIC. See “Engine Oil Monitor System” in options under *DIC Controls and Displays on page 3-45* for more information.

This warning message will display while the ignition is in RUN. Press the set/reset button to acknowledge this warning message and to clear it from the screen.

This message will continue to display if it has not been acknowledged when the engine is turned off. It will also re-display for three seconds if the message has been acknowledged, but the condition still exists when the engine is turned off.

The message will re-appear when the engine is turned on and the condition still exists.

CHARGING SYSTEM FAILURE

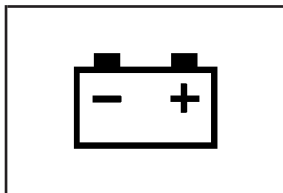

This symbol appears with the CHARGING SYSTEM FAILURE warning message.

This warning message indicates that there is a problem with the generator and battery charging systems. Have the electrical system checked by your dealer as soon as possible.

This warning message will display when the ignition is in RUN. A chime will sound for two seconds when this message is displayed. Press the set/reset button to acknowledge this warning message and to clear it from the screen.

This message will continue to display if it has not been acknowledged when the engine is turned off. It will also re-display for three seconds if the message has been acknowledged, but the condition still exists when the engine is turned off.

The message will re-appear when the engine is turned on and the condition still exists.

CHECK GAS CAP

This warning message appears when the gas cap is not on, or is not fully tightened. Check the gas cap to ensure it is on and properly tightened.

This warning message will display while the ignition is in RUN. A chime will sound for two seconds when this message is displayed and then the screen will clear after three seconds. Press the set/reset button to acknowledge this warning message and to clear it from the screen.

This message will continue to display if it has not been acknowledged when the engine is turned off. It will also re-display for three seconds if the message has been acknowledged, but the condition still exists when the engine is turned off.

The message will re-appear when the engine is turned on and the condition still exists.

CHECK TIRE PRESSURE

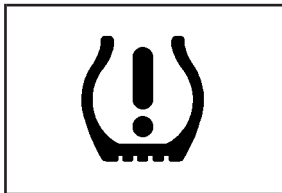

This symbol appears with the CHECK TIRE PRESSURE warning message.

If the vehicle has ABS brakes, this warning message will appear when the air pressure in one of the tires is too low or too high. Check the vehicle's tire pressure as soon as possible, and fill the affected tire to the appropriate level. The correct tire inflation pressure should be set to those shown on the tire-loading information label on the vehicle. See *Loading Your Vehicle* on page 4-35 for more information.

When you reset the CHECK TIRE PRESSURE screen by acknowledging it, you must also reset the TIRE INFLATION MONITOR SYSTEM screen located under the option menu in the DIC. See "Tire Inflation Monitor System" in the options section under *DIC Controls and Displays* on page 3-45 for more information.

This warning message will display while the ignition is in RUN. A chime will sound for two seconds when this message is displayed and then the screen will clear after three seconds. Press the set/reset button to acknowledge this warning message and to clear it from the screen.

This message will continue to display if it has not been acknowledged when the engine is turned off. It will also re-display for three seconds if the message has been acknowledged, but the condition still exists when the engine is turned off.

The message will re-appear when the engine is turned on and the condition still exists.

CRUISE SET

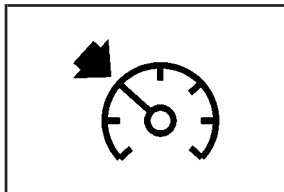

This symbol appears with the CRUISE SET message.

This message will appear whenever the cruise control is set. See *Cruise Control Lever on page 3-8* and the “DISPLAY UNITS” screen in the options menu under *DIC Controls and Displays on page 3-45* for more information.

The cruise symbol will disappear when the cruise control is cancelled, the brakes are applied, or when the cruise control is turned off.

The cruise set speed and the speed indicated by the speedometer may not always be exactly the same.

This message will display when the ignition is in RUN. The screen clears after three seconds, and the message does not re-display for three seconds after the ignition is turned off or started.

This message does not need to be acknowledged.

DELAYED LOCKING

This message will appear when the doors of the vehicle are closed and the delayed locking feature has been programmed through the DIC. See “Delayed Locking” in the options menu under *DIC Controls and Displays on page 3-45* for more information.

This message will appear when the ignition is in OFF. A chime will sound for two seconds when this message is displayed.

This message cannot be acknowledged.

HEADLAMPS SUGGESTED

This message appears when the amount of available light outside the vehicle is low and the exterior lamps control is off. This message informs the driver that turning on the exterior lamps is recommended even though the Daytime Running Lamps (DRL) are still illuminated and it has become dark enough outside to require the headlamps and/or other exterior lamps.

This message will display while the ignition is in RUN. A chime will sound for two seconds when this message is displayed. Press the set/reset button to acknowledge this warning message and to clear it from the screen.

This message will continue to display if it has not been acknowledged when the engine is turned off. It will also re-display for three seconds if the message has been acknowledged, but the condition still exists when the engine is turned off.

The message will re-appear when the engine is turned on and the condition still exists.

HOT COOLANT

Notice: If the HOT COOLANT warning message appears on the DIC display, stop the vehicle as soon as possible. Do not increase the engine speed above normal idling speed. Severe engine damage can result from driving a vehicle with an overheated engine. See “Engine Overheating” in the Service and Appearance Care section for more information.

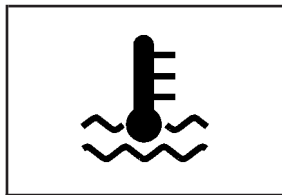

This symbol will appear with the HOT COOLANT warning message.

This warning message will appear while the engine coolant temperature is too hot. The hot coolant temperature warning light will also appear on the instrument panel cluster. Also, the engine coolant temperature gage will read in the red or “hot” area. See *Engine Coolant Temperature Warning Light on page 3-39* and *Engine Coolant Temperature Gage on page 3-39* for more information.

To avoid added strain, turn off the air conditioner if it is on. When the coolant temperature returns to normal, the air conditioning compressor can be turned back on.

This warning message will display only while the ignition is in RUN. A chime will sound continuously when this message is displayed. Press the set/reset button to acknowledge this warning message and to clear it from the screen.

This message will continue to display if it has not been acknowledged when the engine is turned off. It will also re-display for three seconds if the message has been acknowledged, but the condition still exists when the engine is turned off.

The message will re-appear when the engine is turned on and the condition still exists.

HOT ENGINE OIL. REDUCE SPEED

This warning message will display when the vehicle's engine oil is above the proper engine operating temperature. Reduce the speed of the vehicle. If the warning message continues to display, have the vehicle serviced as soon as possible. A chime will sound continuously when this message is displayed. Press the set/reset button to acknowledge this warning message. This clears it from the screen.

This message will continue to display if it has not been acknowledged when the engine is turned off. It will also re-display for three seconds if the message has been acknowledged, but the condition still exists when the engine is turned off.

The message will re-appear when the engine is turned on and the condition still exists.

HOT TRANS FLUID



This symbol appears with the HOT TRANS FLUID warning message.

This warning message will appear when the transaxle fluid in the vehicle is too hot. Stop the vehicle and allow it to idle until it cools down. If the warning message continues to display, have the vehicle serviced as soon as possible.

If the vehicle has the Uplevel Trip Computer DIC, you can determine the actual temperature of the transaxle fluid using the vehicle's gages button. See "Uplevel DIC with Trip Computer" under *DIC Controls and Displays on page 3-45* for more information.

This warning message will display while the ignition is in RUN. A chime will sound for two seconds when this message is displayed. Press the set/reset button to acknowledge this warning message and to clear it from the screen.

This message will continue to display if it has not been acknowledged when the engine is turned off. It will also re-display for three seconds if the message has been acknowledged, but the condition still exists when the engine is turned off.

The message will re-appear when the engine is turned on and the condition still exists.

KEY FOB BATTERY LOW

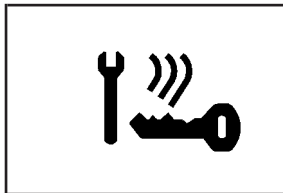

This symbol appears with the KEY FOB BATTERY LOW warning message.

This warning message will appear when the battery in the remote keyless entry transmitter needs to be replaced. See *Remote Keyless Entry System Operation on page 2-5* for more information.

This warning message will display when the ignition is in RUN. A chime will sound for two seconds when this message is displayed. Press the set/reset button to acknowledge this warning message and to clear it from the screen.

This message will continue to display if it has not been acknowledged when the engine is turned off. It will also re-display for three seconds if the message has been acknowledged, but the condition still exists when the engine is turned off.

The message will re-appear when the engine is turned on and the condition still exists.

KEY IN IGNITION

This warning message will display and a chime will sound continuously when the driver exits the vehicle while the key is in the ignition after the engine is turned off.

This warning message cannot be acknowledged.

This message will disappear and the chiming will stop when the key is removed from the ignition.

LEFT FRONT TURN LAMP OUT

This warning message will appear when the left front turn signal lamp needs to be replaced. See *Taillamps, Turn Signal, and Stoplamps on page 5-64* for replacement procedures.

This warning message will display when the ignition is in RUN. A chime will sound for two seconds when this message is displayed. Press the set/reset button to acknowledge this warning message and to clear it from the screen.

This message will continue to display if it has not been acknowledged when the engine is turned off. It will also re-display for three seconds if the message has been acknowledged, but the condition still exists when the engine is turned off.

The message will re-appear when the engine is turned on and the condition still exists.

LEFT REAR TURN LAMP OUT

This warning message will appear when the left rear turn signal lamp needs to be replaced. See *Taillamps, Turn Signal, and Stoplamps on page 5-64* for replacement procedures.

This warning message will display while the ignition is in RUN. A chime will sound for two seconds when this message is displayed. Press the set/reset button to acknowledge this warning message and to clear it from the screen.

This message will continue to display if it has not been acknowledged when the engine is turned off. It will also re-display for three seconds if the message has been acknowledged, but the condition still exists when the engine is turned off.

The message will re-appear when the engine is turned on and the condition still exists.

LOW BRAKE FLUID

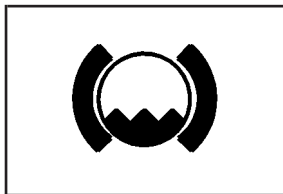

This symbol appears with the LOW BRAKE FLUID warning message.

This warning message will appear when the brake fluid level is low. Fill the brake master cylinder to the proper level. See *Engine Compartment Overview on page 5-12* for the location of the brake master cylinder reservoir. Also, see *Brakes on page 5-45* for proper fluid level.

The brake light will also appear on the instrument panel cluster when this message appears on the DIC.

This warning message will display only when the ignition is in RUN. A chime will sound continuously while this message is displayed. Press the set/reset button to acknowledge this warning message and to clear it from the screen.

This message will continue to display if it has not been acknowledged when the engine is turned off. It will also re-display for three seconds if the message has been acknowledged, but the condition still exists when the engine is turned off.

The message will re-appear when the engine is turned on and the condition still exists.

LOW FUEL

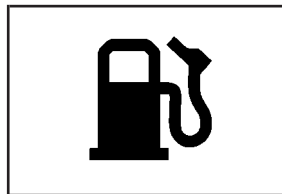

This symbol appears with the LOW FUEL warning message.

This warning message will appear when the vehicle is low on fuel. Refill the fuel tank as soon as possible.

This warning message will display while the ignition is in RUN. A chime will sound for two seconds when this message is displayed. Press the set/reset button to acknowledge this warning message and to clear it from the screen.

This message will continue to display if it has not been acknowledged when the engine is turned off. It will also re-display for three seconds if the message has been acknowledged, but the condition still exists when the engine is turned off.

The message will re-appear when the engine is turned on and the condition still exists.

LOW OIL LEVEL



This symbol appears with the LOW OIL LEVEL warning message.

This warning message appears when the vehicle's engine oil is low. Fill the oil to the proper level as soon as possible. See *Engine Compartment Overview* on page 5-12 for engine oil fill location. Also, see *Engine Oil* on page 5-16 for information on the kind of oil to use and proper oil level. See *Supercharger Oil* on page 5-21 if the vehicle has a supercharged engine for information on the kind of oil to use and proper oil level.

This warning message will display while the ignition is in RUN. A chime will sound for 60 seconds when this message is displayed. Press the set/reset button to acknowledge this warning message and to clear it from the screen.

This message will continue to display if it has not been acknowledged when the engine is turned off. It will also re-display for three seconds if the message has been acknowledged, but the condition still exists when the engine is turned off.

The message will re-appear when the engine is turned on and the condition still exists.

LOW OIL PRESSURE

Notice: If the LOW OIL PRESSURE warning message appears on the DIC display, stop the vehicle immediately. Do not drive the vehicle until the cause of the low oil pressure is corrected. Severe engine damage can result from driving a vehicle with low oil pressure. See "Engine Oil" in the Service and Appearance Care section for more information.

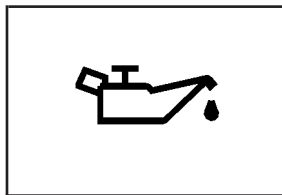

This symbol appears with the LOW OIL PRESSURE warning message.

This warning message will appear when the vehicle's engine oil pressure is low. The low oil pressure warning light will also appear on the instrument panel.

Stop the vehicle immediately, as engine damage can result from driving a vehicle with low oil pressure. Have the vehicle serviced as soon as possible when this warning message is displayed.

This warning message will display only while the ignition is in RUN. A chime will sound continuously when this message is displayed. Press the set/reset button to acknowledge this warning message and to clear it from the screen.

This message will continue to display if it has not been acknowledged when the engine is turned off. It will also re-display for three seconds if the message has been acknowledged, but the condition still exists when the engine is turned off.

The message will re-appear when the engine is turned on and the condition still exists.

LOW WASHER FLUID

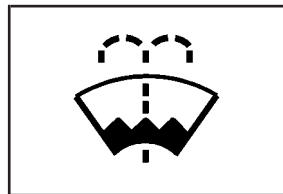

This symbol will appear with the LOW WASHER FLUID warning message.

This warning message appears when the windshield washer fluid is low. Fill the windshield washer reservoir as soon as possible. See *Engine Compartment Overview on page 5-12* for location of the windshield washer reservoir. Also, see *Windshield Washer Fluid on page 5-43* for more information.

This warning message will display only while the ignition is in RUN. A chime will sound continuously when this message is displayed. Press the set/reset button to acknowledge this warning message and to clear it from the screen.

This message will continue to display if it has not been acknowledged when the engine is turned off. It will also re-display for three seconds if the message has been acknowledged, but the condition still exists when the engine is turned off.

The message will re-appear when the engine is turned on and the condition still exists.

PARKING BRAKE ON

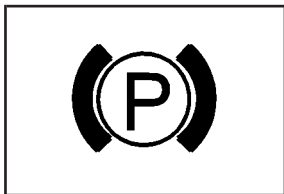

This symbol appears with the PARKING BRAKE ON warning message.

This warning message appears to alert the driver when the vehicle's parking brake is on and the ignition is in RUN. See *Parking Brake on page 2-27* for more information.

The brake light will also appear on the instrument panel cluster when this message appears on the DIC.

A chime will sound continuously while this message is displayed. Press the set/reset button to acknowledge this warning message and to clear it from the screen.

This message will continue to display if it has not been acknowledged when the engine is turned off. It will also re-display for three seconds if the message has been acknowledged, but the condition still exists when the engine is turned off.

The message will re-appear when the engine is turned on and the condition still exists.

PARK LAMPS ON

This warning message will appear to alert the driver when the parking lamps are on and the ignition is in OFF. A chime will sound continuously while this message is displayed. This warning message does not re-display after the ignition is turned off. It cannot be acknowledged.

READING LAMP ON

This warning message will appear to alert the driver that the reading lamps are on and the ignition is in OFF. A chime will sound continuously while this message is displayed. This warning message does not re-display after the ignition is turned off. It cannot be acknowledged.

REDUCED ENGINE POWER

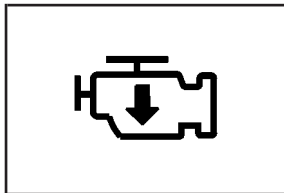

This symbol appears with the REDUCED ENGINE POWER warning message.

This warning message appears when the vehicle's engine power is reduced. This happens when driving conditions, such as climbing a steep hill, make the transaxle overwork in a gear that may cause damage to the vehicle's engine or transaxle. Reduced engine power can affect the vehicle's ability to accelerate.

This warning message will display only when the ignition is in RUN. Press the set/reset button to acknowledge this warning message and to clear it from the screen.

This message will continue to display if it has not been acknowledged when the engine is turned off. It will also re-display for three seconds if the message has been acknowledged, but the condition still exists when the engine is turned off.

The message will re-appear when the engine is turned on and the condition still exists.

RIGHT FRONT TURN LAMP OUT

This warning message will appear when the vehicle's right front turn signal needs to be replaced. See *Front Turn Signal, Parking and Fog Lamps on page 5-62* for bulb replacement procedures.

This warning message will display only while the ignition is in RUN. Press the set/reset button to acknowledge this warning message. and to clear it from the screen.

This message will continue to display if it has not been acknowledged when the engine is turned off. It will also re-display for three seconds if the message has been acknowledged, but the condition still exists when the engine is turned off.

The message will re-appear when the engine is turned on and the condition still exists.

RIGHT REAR TURN LAMP OUT

This warning message will appear when the vehicle's right rear turn signal needs to be replaced. See *Taillamps, Turn Signal, and Stoplamps on page 5-64* for bulb replacement procedures.

This warning message will display only while the ignition is in RUN. Press the set/reset button to acknowledge this warning message and to clear it from the screen.

This message will continue to display if it has not been acknowledged when the engine is turned off. It will also re-display for three seconds if the message has been acknowledged, but the condition still exists when the engine is turned off.

The message will re-appear when the engine is turned on and the condition still exists.

SERVICE ABS SYSTEM

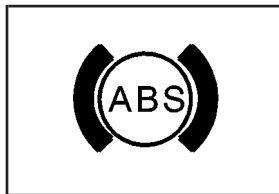

This symbol appears with the SERVICE ABS SYSTEM warning message.

If the vehicle has the Anti-Lock Brake System (ABS), this warning message will appear when the vehicle's brakes are not functioning properly. Have the brake system serviced by your dealer as soon as possible.

This warning message will display only while the ignition is in RUN. Press the set/reset button to acknowledge this warning message and to clear it from the screen.

This message will continue to display if it has not been acknowledged when the engine is turned off. It will also re-display for three seconds if the message has been acknowledged, but the condition still exists when the engine is turned off.

The message will re-appear when the engine is turned on and the condition still exists.

SERVICE BRAKE SYSTEM

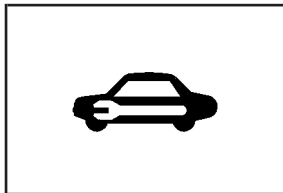

This symbol appears with the SERVICE BRAKE SYSTEM warning message.

This warning message will appear when the vehicle's brakes are not functioning properly. Have the brake system serviced by your dealer as soon as possible.

This warning message will display only while the ignition is in RUN. Press the set/reset button to acknowledge this warning message and to clear it from the screen.

This message will continue to display if it has not been acknowledged when the engine is turned off. It will also re-display for three seconds if the message has been acknowledged, but the condition still exists when the engine is turned off.

The message will re-appear when the engine is turned on and the condition still exists.

SERVICE BRAKE APPLY SENSOR

This message will display when the brake apply sensor is not functioning properly. The vehicle still has brakes when this warning message displays, but you should have the vehicle serviced by your dealer as soon as possible.

This warning message will display only while the ignition is in RUN. Press the set/reset button to acknowledge this warning message and to clear it from the screen.

This message will continue to display if it has not been acknowledged when the engine is turned off. It will also re-display for three seconds if the message has been acknowledged, but the condition still exists when the engine is turned off.

The message will re-appear when the engine is turned on and the condition still exists.

SERVICE PARK LAMPS

This warning message will display if one of the vehicle's parking lamps needs to be replaced. See *Front Turn Signal, Parking and Fog Lamps* on page 5-62 for bulb replacement procedures.

This warning message will display only while the ignition is in RUN. Press the set/reset button to acknowledge this warning message and to clear it from the screen.

This message will continue to display if it has not been acknowledged when the engine is turned off. It will also re-display for three seconds if the message has been acknowledged, but the condition still exists when the engine is turned off.

The message will re-appear when the engine is turned on and the condition still exists.

SERVICE TRACTION SYSTEM

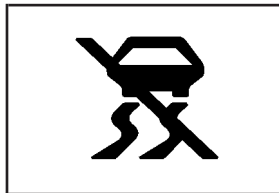

This symbol will appear with the SERVICE TRACTION SYSTEM warning message.

If the vehicle has the traction control system, this warning message appears when the system is not functioning properly. See *Traction Control System (TCS)* on page 4-10 for more information. Have the traction control system serviced by your dealer as soon as possible.

This warning message will display only while the ignition is in RUN. Press the set/reset button to acknowledge this warning message and to clear it from the screen.

This message will continue to display if it has not been acknowledged when the engine is turned off. It will also re-display for three seconds if the message has been acknowledged, but the condition still exists when the engine is turned off.

The message will re-appear when the engine is turned on and the condition still exists.

SERVICE STABILITY SYSTEM

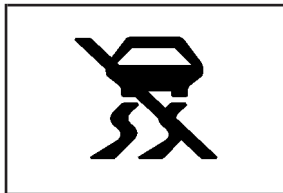

This symbol will appear with the SERVICE STABILITY SYSTEM warning message.

If the vehicle has the Stabilitrak[®] Plus system, this warning message will appear when it is not functioning properly. See *Stabilitrak[®] Plus System on page 4-13* for more information. Have the Stabilitrak[®] Plus system serviced by your dealer as soon as possible.

This warning message will display only while the ignition is in RUN. Press the set/reset button to acknowledge this warning message and to clear it from the screen.

This message will continue to display if it has not been acknowledged when the engine is turned off. It will also re-display for three seconds if the message has been acknowledged, but the condition still exists when the engine is turned off.

The message will re-appear when the engine is turned on and the condition still exists.

SERVICE THEFT SYSTEM

This warning message will appear if there is a problem with the theft-deterrent system programmed in the key. A fault has been detected in the system which means that the system is disabled and it is not protecting the vehicle. The vehicle usually restarts, however, you may want to take the vehicle to your dealer before turning off the engine. See *Keys on page 2-2* for information on the PASS-Key[®] III system.

This warning message will display only while the ignition is in RUN. Press the set/reset button to acknowledge this warning message. and to clear it from the screen.

This message will continue to display if it has not been acknowledged when the engine is turned off. It will also re-display for three seconds if the message has been acknowledged, but the condition still exists when the engine is turned off.

The message will re-appear when the engine is turned on and the condition still exists.

SERVICE VARIABLE EFFORT STEERING

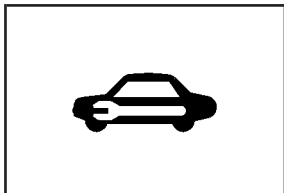

This symbol appears with the SERVICE VARIABLE EFFORT STEERING warning message.

If the vehicle has Anti-Lock Brakes (ABS), it has the variable steering effort system. This warning message will display if this system is not functioning properly. See *Steering on page 4-14* for more information. Have your system serviced by your dealer as soon as possible.

This warning message will display only while the ignition is in RUN. Press the set/reset button to acknowledge this warning message and to clear it from the screen.

This message will continue to display if it has not been acknowledged when the engine is turned off. It will also re-display for three seconds if the message has been acknowledged, but the condition still exists when the engine is turned off.

The message will re-appear when the engine is turned on and the condition still exists.

SERVICE VEHICLE SOON

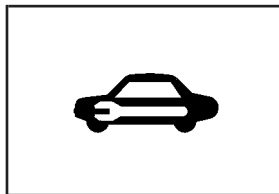

This symbol appears with the SERVICE VEHICLE SOON warning message.

This warning message displays when a non-emissions related malfunction occurs. Have the vehicle serviced by your dealer as soon as possible.

This warning message will display only while the ignition is in RUN. Press the set/reset button to acknowledge this warning message and to clear it from the screen.

This message will continue to display if it has not been acknowledged when the engine is turned off. It will also re-display for three seconds if the message has been acknowledged, but the condition still exists when the engine is turned off.

The message will re-appear when the engine is turned on and the condition still exists.

STABILITY CONTROL ACTIVE

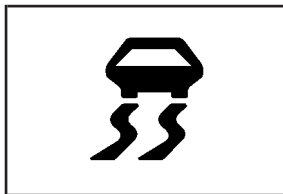

This symbol appears with the STABILITY CONTROL ACTIVE warning message.

If the vehicle has the Stabilitrak[®] Plus system, this warning message appears when the system is engaged and actively assisting the driver with directional control of the vehicle. A warning light will also appear on the instrument panel when this system is active. Slippery road conditions may exist when this warning message is displayed, so driving should be adjusted accordingly.

This warning message will display only while the ignition is in RUN. This message stays on until road conditions change and Stabilitrak[®] Plus is not active.

You cannot acknowledge this warning message and clear it from the screen.

STABILITY CONTROL OFF

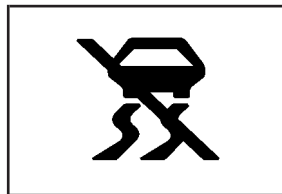

This symbol appears with the STABILITY CONTROL OFF warning message.

If the vehicle has the Stabilitrak[®] Plus system, this warning message appears when the system is not engaged and is not actively assisting the driver with directional control of the vehicle.

This warning message will display only while the ignition is in RUN. This warning message will appear only if the STABILITY CONTROL ACTIVE warning message preceded it. It will appear when the road conditions have changed, indicating that Stabilitrak[®] Plus is no longer needed. A warning light, indicating that this system is not active will also appear on the instrument panel. A chime will sound once and the message will stay on for three seconds and then disappear.

STARTING DISABLED DUE TO ELECTRONIC THROTTLE CONTROL

This warning message will appear when there is a malfunction with the electronic throttle control which prevents the vehicle from starting. Have the vehicle serviced by your dealer.

This warning message will only appear while the ignition is in RUN, and will not disappear until the problem is resolved. A chime will sound for two seconds. This warning message cannot be acknowledged.

STARTING DISABLED DUE TO THEFT SYSTEM

This warning message will appear when the system detects a malfunction in the content theft-deterrent system and prevents the vehicle from starting.

This warning message will only appear while the ignition is in RUN, and will not disappear until the problem is resolved. A chime will sound for two seconds. This warning message cannot be acknowledged.

THEFT SYSTEM NOT PROGRAMMED

This warning message will appear if the theft deterrent system has not been programmed through the DIC. See “Personal Programming” under the options mode in *DIC Controls and Displays on page 3-45* for information on how to set the theft-deterrent system.

This warning message will display only while the ignition is in RUN. Press the set/reset button to acknowledge this warning message and to clear it from the screen.

This message will continue to display if it has not been acknowledged when the engine is turned off. It will also re-display for three seconds if the message has been acknowledged, but the condition still exists when the engine is turned off.

The message will re-appear when the engine is turned on and the condition still exists.

TRACTION CONTROL ACTIVE

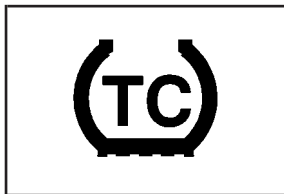

This symbol appears with the TRACTION CONTROL ACTIVE message.

If the vehicle has the traction control system, this message will appear when the system is on. TRACTION CONTROL ACTIVE will also appear in the Head-Up Display (HUD), if equipped.

This warning message only displays while the ignition is in RUN and will not disappear until driving conditions change and the traction control is no longer active.

You cannot acknowledge this warning message and clear it from the screen.

TRACTION CONTROL OFF

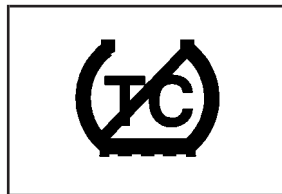

This symbol appears with the TRACTION CONTROL OFF message.

If the vehicle has the traction control system, this message will appear when the traction control system is no longer active due to a change in driving conditions. TRACTION CONTROL OFF will also appear in the Head-Up Display (HUD), if equipped.

This warning message only displays while the ignition is in RUN and will disappear after three seconds. This message will appear only if the TRACTION CONTROL ACTIVE warning message preceded it.

TURN SIGNAL ON

This message will appear if you drive the vehicle for more than 1 mile (1.6 km) with one of the turn signals on. It appears as a reminder to turn off the turn signal.

This message only displays when the ignition is in RUN. A chime will sound continuously and the message will not disappear until the turn signal is manually turned off, or a turn is completed.

Audio System(s)

Notice: Before you add any sound equipment to your vehicle – like a tape player, CB radio, mobile telephone or two-way radio – be sure you can add what you want. If you can, it's very important to do it properly. Added sound equipment may interfere with the operation of your vehicle's engine, radio or other systems, and even damage them. Your vehicle's systems may interfere with the operation of sound equipment that has been added improperly.

So, before adding sound equipment, check with your dealer and be sure to check federal rules covering mobile radio and telephone units.

Your audio system has been designed to operate easily and to give years of listening pleasure. You will get the most enjoyment out of it if you acquaint yourself with it first. Figure out which radio you have in your vehicle, find out what your audio system can do and how to operate all of its controls to be sure you're getting the most out of the advanced engineering that went into it.

Your vehicle has a feature called Retained Accessory Power (RAP). With RAP, you can play your audio system even after the ignition is turned off. See "Retained Accessory Power (RAP)" under *Ignition Positions* on page 2-18.

Setting the Time

Your radio may have a button marked with an H or HR to represent hours and an M or MIN to represent minutes.

Press and hold the hour button until the correct hour appears on the display. AM will also appear for morning hours. Press and hold the minute button until the correct minute appears on the display. The time may be set with the ignition on or off.

To synchronize the time with an FM station broadcasting Radio Data System (RDS) information, press and hold the hour and minute buttons at the same time until UPDATED appears on the display. If the time is not available from the station, NO UPDATE will appear on the display.

Radio with CD



If your vehicle is equipped with the Monsoon audio system, included are eight speakers and an eight channel amplifier. The radio will display MONSOON when the radio or the ignition is turned on. See your dealer for details.

Radio Data System (RDS)

Your audio system is equipped with a Radio Data System (RDS). RDS features are available for use only on FM stations that broadcast RDS information.

With RDS, your radio can do the following:

- Seek to stations broadcasting the selected type of programming
- Receive announcements concerning local and national emergencies
- Display messages from radio stations
- Seek to stations with traffic announcements

This system relies upon receiving specific information from these stations and will only work when the information is available. In rare cases, a radio station may broadcast incorrect information that will cause the radio features to work improperly. If this happens, contact the radio station.

While you are tuned to an RDS station, the station name or the call letters will appear on the display instead of the frequency. RDS stations may also provide the time of day, a program type (PTY) for current programming, and the name of the program being broadcast.

XM™ Radio Satellite Service (USA Only)

XM™ is a continental U.S. based satellite radio service that offers 100 coast to coast channels including music, news, sports, talk, and children's programming. XM™ provides digital quality audio and text information, including song title and artist name. A service fee is required in order to receive the XM™ service. For more information, contact XM™ at www.xmradio.com or call 1-800-852-XXXM (9696).

Playing the Radio

PWR (Power): Press this knob to turn the system on and off.

VOL (Volume): Turn this knob to increase or to decrease volume.

SCV (Speed-Compensated Volume): With SCV, your audio system adjusts automatically to make up for road and wind noise as you drive.

Set the volume at the desired level. Press this button to select MIN, MED or MAX. Each higher choice allows for more volume compensation at faster vehicle speeds. Then, as you drive, SCV automatically increases the volume, as necessary, to overcome noise at any speed. The volume level should always sound the same to you as you drive. If you don't want to use SCV, select OFF.

RCL (Recall): Push this knob to switch the display between the radio station frequency and the time. Pushing this knob with the ignition off will display the time.

For XM™ (USA only, if equipped), push this knob while in XM™ mode to retrieve four different categories of information related to the current song or channel: Artist, Song Title, Category or PTY, Channel Number/Channel Name.

To change the default on the display, push the knob until you see the display you want, then hold the knob until the display flashes. The selected display will now be the default.

Finding a Station

BAND: Press this button to switch between FM1, FM2, AM, or XM1 or XM2 (USA only, if equipped). The display will show your selection.

TUNE: Turn this knob to choose radio stations.

△ **SEEK** ▽: Press the up or the down arrow to go to the next or to the previous station and stay there.

The radio will seek only to stations that are in the selected band and only to those with a strong signal.

△ **SCAN** ▽: Press and hold one of the SCAN arrows for two seconds until SCAN appears on the display and you hear a beep. The radio will go to a station, play for a few seconds, then go on to the next station. Press one of the SCAN arrows again to stop scanning.

To scan preset stations, press and hold one of the SCAN arrows for more than four seconds until PSCAN and the preset number appear on the display. You will hear a double beep. The radio will go to the first preset station stored on your pushbuttons, play for a few seconds, then go on to the next preset station. Press one of the SCAN arrows again to stop scanning presets.

The radio will scan only to stations that are in the selected band and only to those with a strong signal.

Setting Preset Stations

The six numbered pushbuttons let you return to your favorite stations. You can set up to 30 stations (six FM1, six FM2, and six AM, six XM1 and six XM2 (USA only, if equipped)), by performing the following steps:

1. Turn the radio on.
2. Press BAND to select FM1, FM2, AM, or XM1 or XM2.
3. Tune in the desired station.
4. Press EQ to select the equalization.
5. Press and hold one of the six numbered pushbuttons until you hear a beep. Whenever you press that numbered pushbutton, the station you set will return and the equalization that you selected will also be automatically selected for that pushbutton.
6. Repeat the steps for each pushbutton.

Setting the Tone (Bass/Treble)

TONE: Press and release this button until BASS, MID, or TREB appears on the display. The SELECT LED indicator will light to show that the tone control can be adjusted. Turn the SELECT knob to increase or to decrease. If a station is weak or noisy, you may want to decrease the treble.

Pressing and holding the TONE button for two seconds will return all speaker settings to the middle position.

EQ (Equalizer): Press this button to select customized bass, mid and treble equalization settings.

You can set up to six customized equalization settings by performing the following steps:

1. Turn the radio on.
2. Use the TONE button and the SELECT knob to create the desired equalization.
3. Press and hold the EQ button for two seconds. SELECT EQ # will appear on the display and the EQ symbol will flash.
4. Press EQ or turn the SELECT knob to select the desired EQ number.

5. Press and hold the EQ button or push the SELECT knob to store the equalization setting and the number. You will hear a beep and EQ SAVED will appear on the display.
6. Repeat the steps for the other EQ settings and numbers.

EQ 5 has been programmed at the factory for use with talk radio, but it can be preset to a different tone.

Adjusting the Speakers (Balance/Fade)

BAL (Balance): Press and release this button until BAL appears on the display. The SELECT LED indicator will light to show that the speakers can be adjusted. Turn the SELECT knob to move the sound toward the left or the right speakers.

FADE: Press and release this button until FADE appears on the display. The SELECT LED indicator will light to show that the speakers can be adjusted. Turn the SELECT knob to move the sound toward the front or the rear speakers.

Pressing and holding the BAL FADE button for two seconds will return all speaker settings to the middle position.

Finding a PTY Station (RDS and XM™)

To select and find a desired PTY perform the following:

1. Press PROG TYPE. PTY will be displayed on the screen.
2. Select a category by turning the SELECT knob.
3. Once the desired category is displayed, press either SEEK arrow to select the category and take you to the category's first station.
4. If you want to go to another station within that category and the category is displayed, press either SEEK arrow once. If the category is not displayed, press either SEEK arrow twice to display the category and then to go to another station.

SCAN: You can also scan through the channels within a category by performing the following:

1. Press PROG TYPE. PTY will be displayed on the screen.
2. Select a category by turning the SELECT knob.

3. Once the desired category is displayed, press and hold either SCAN arrow, and the radio will begin scanning within your chosen category.
4. Press either SCAN arrow again to stop at a particular station.

BAND (Alternate Frequency): Alternate frequency allows the radio to switch to a stronger station with the same programming. Press and hold BAND for two seconds to turn alternate frequency on. AF ON will appear on the display. The radio may switch to stronger stations. Press and hold BAND again for two seconds to turn alternate frequency off. AF OFF will appear on the display. The radio will not switch to other stations.

This function does not apply for XM™ Satellite Radio Service.

Setting Preset PTYs (RDS Only)

The six numbered pushbuttons let you return to your favorite program types (PTYs). These pushbuttons have factory PTY presets. You can set up to 12 PTYs (six FM1 and six FM2) by performing the following steps:

1. Press BAND to select FM1 or FM2.
2. Press PROG TYPE to activate program type select mode.
3. Turn the SELECT knob to select a PTY.
4. Press and hold one of the six numbered pushbuttons until you hear a beep. Whenever you press that numbered pushbutton, the PTY you set will return, if program type select mode is activated.
5. Repeat the steps for each pushbutton.

RDS Messages

ALERT!: Alert warns of national or local emergencies. When an alert announcement comes on the current radio station, ALERT! will appear on the display. You will hear the announcement, even if the volume is muted or a compact disc is playing. If the compact disc player is playing, play will stop during the announcement. You will not be able to turn off alert announcements.

ALERT! will not be affected by tests of the emergency broadcast system. This feature is not supported by all RDS stations.

INFO (Information): If the current station has a message, INFO will appear on the display. Press this button to see the message. The message may display the artist and song title, call in phone numbers, etc.

If the whole message is not displayed, parts of it will appear every three seconds. To scroll through the message at your own speed, press the INFO button repeatedly. A new group of words will appear on the display with each press. Once the complete message has been displayed, INFO will disappear from the display until another new message is received. The old message can be displayed by pressing the INFO button until a new message is received or a different station is tuned to.

TRAF (Traffic): If TRAF appears on the display, the tuned station broadcasts traffic announcements. To receive the traffic announcement from the tuned station, press this button. Brackets will be displayed around TRAF and when a traffic announcement comes on the tuned radio station you will hear it.

If the current tuned station does not broadcast traffic announcements, press this button and the radio will seek to a station that does. When the radio finds a station that broadcasts traffic announcements, it will stop and brackets will be displayed around TRAF. When a traffic announcement comes on the tuned radio station you will hear it. If no station is found, NO TRAFFIC will appear on the display.

If the brackets are on the display and TRAF is not, you can then press the TRAF button to remove the brackets or use the TUNE knob or the SEEK arrows to go to a station that supports traffic announcements. If no station is found, NO TRAFFIC will appear on the display.

Your radio will play the traffic announcements even if the volume is muted or interrupt the play of a CD if the last tuned station broadcasts traffic announcements.

This function does not apply to XM™ Satellite Radio Service.

Radio Messages

CALIBRATE: Your audio system has been calibrated for your vehicle from the factory. If CALIBRATE appears on the display, it means that your radio has not been configured properly for your vehicle and must be returned to the dealership for service.

XM™ Radio Messages

Radio Display Message	Condition	Action Required
XL (Explicit Language Channels)	XL on the radio display, after the channel name, indicates content with explicit language.	These channels, or any others, can be blocked at a customer's request, by calling 1-800-852-XXMX (9696).
Updating	Updating encryption code	The encryption code in your receiver is being updated, and no action is required. This process should take no longer than 30 seconds.
No Signal	Loss of signal	Your system is functioning correctly, but you are in a location that is blocking the XM signal. When you move into an open area, the signal should return.
Loading XM	Acquiring channel audio (after 4 second delay)	Your radio system is acquiring and processing audio and text data. No action is needed. This message should disappear shortly.
CH Off Air	Channel not in service	This channel is not currently in service. Tune to another channel.
CH Unavail	Channel no longer available	This previously assigned channel is no longer assigned. Tune to another station. If this station was one of your presets, you may need to choose another station for that preset button.
No Info	Artist Name/Feature not available	No artist information is available at this time on this channel. Your system is working properly.
No Info	Song/Program Title not available	No song title information is available at this time on this channel. Your system is working properly.

XM™ Radio Messages (cont'd)

Radio Display Message	Condition	Action Required
No Info	Category Name not available	No category information is available at this time on this channel. Your system is working properly.
No Info	No Text/Informational message available	No text or informational messages are available at this time on this channel. Your system is working properly.
Not Found	No channel available for the chosen category	There are no channels available for the category you selected. Your system is working properly.
XM Locked	Theft lock active	The XM receiver in your vehicle may have previously been in another vehicle. For security purposes, XM receivers cannot be swapped between vehicles. If you receive this message after having your vehicle serviced, check with the servicing facility.
Radio ID	Radio ID label (channel 0)	If you tune to channel 0, you will see this message alternating with your XM Radio 8 digit radio ID label. This label is needed to activate your service.
Unknown	Radio ID not known (should only be if hardware failure)	If you receive this message when you tune to channel 0, you may have a receiver fault. Consult with your dealer.
Chk XM Rcvr	Hardware failure	If this message does not clear within a short period of time, your receiver may have a fault. Consult with your retail location.

Playing a Compact Disc

With the ignition on, insert a disc partway into the slot, label side up. The player will pull it in and the disc should begin playing. If you want to insert a CD when the ignition is off, first press the eject symbol or push the RCL knob. If you insert a CD with the radio off and the ignition on, it will start to play.

When the disc is inserted, the CD symbol will be displayed. If you select an EQ setting for your CD, it will be activated each time you play a CD.

As each new track starts to play, the track number will appear on the display.

The integral CD player can play the smaller 8 cm single discs with an adapter ring. Full-size compact discs and the smaller discs are loaded in the same manner.

If playing a CD-R the sound quality may be reduced due to CD-R quality, the method of recording, the quality of the music that has been recorded, and the way the CD-R has been handled. You may experience an increase in skipping, difficulty in finding tracks, and/or difficulty in loading and ejecting. If these problems occur try a known good CD.

Do not add paper labels to discs, they could get caught in the CD player.

Do not play 3 inch discs without a standard adapter disc.

If an error appears on the display, see “Compact Disc Messages” later in this section.

▶▶ 1 (Forward): Press and hold this pushbutton to advance quickly within a track. You will hear sound at a reduced volume. Release it to play the passage. The display will show elapsed time.

RDM 3 (Random): Press this pushbutton to hear the tracks in random, rather than sequential, order. RDM and the track number will appear on the display.

4 ◀◀ (Reverse): Press and hold this pushbutton to reverse quickly within a track. You will hear sound at a reduced volume. Release it to play the passage. The display will show elapsed time.

EQ (Equalizer): Press EQ to select the desired customized equalization setting while playing a compact disc. The equalization will be automatically set whenever you play a compact disc. See “EQ” listed previously for more information.

△ SEEK ▽ : Press the down arrow while playing a CD to go to the start of the current track if more than eight seconds have played. Press the up arrow to go to the next track. If you press either arrow more than once, the player will continue moving backward or forward through the disc.

△ SCAN ▽: Press and hold one of the arrows for more than two seconds until SCAN and the track number appear on the display and you hear a beep. The disc will go to the next track, play for a few seconds, then go on to the next track. Press this button again to stop scanning.

RCL (Recall): Press this knob to see how long the current track has been playing. To change the default on the display (track and elapsed time), press the knob until you see the display you want, then hold the knob until the display flashes. The selected display will now be the default. While elapsed time is showing, CD TIME will appear on the display.

BAND: Press this button to listen to the radio when a CD is playing. The inactive CD will remain safely inside the radio for future listening.

CD AUX (Auxiliary): Press this button to play a compact disc when listening to the radio. CD will appear on the display when a compact disc is loaded.

⏏ (Eject): Press this button to eject a CD. Eject may be activated with either the ignition or radio off. CDs may be loaded with the radio and ignition off if this button is pressed first.

Compact Disc Messages

CHECK CD: If this message appears on the radio display and the disc comes out, it could be for one of the following reasons:

- You're driving on a very rough road. When the road becomes smoother, the disc should play.
- The disc is dirty, scratched, wet, or upside down.
- The air is very humid. If so, wait about an hour and try again.
- There may have been a problem while burning the CD.
- The label may be caught in the CD player.

If the CD is not playing correctly, for any other reason, try a known good CD.

If any error occurs repeatedly or if an error can not be corrected, contact your dealer. If your radio displays an error message, write it down and provide it to your dealer when reporting the problem.

Radio with Cassette and CD



If your vehicle is equipped with this Monsoon audio system, included are eight speakers and an eight channel amplifier. The radio will display MONSOON when the radio or the ignition is turned on. See your dealer for details.

Radio Data System (RDS)

Your audio system is equipped with a Radio Data System (RDS). RDS features are available for use only on FM stations that broadcast RDS information.

With RDS, your radio can do the following:

- Seek to stations broadcasting the selected type of programming
- Receive announcements concerning local and national emergencies
- Display messages from radio stations,
- Seek to stations with traffic announcements

This system relies upon receiving specific information from these stations and will only work when the information is available. In rare cases, a radio station may broadcast incorrect information that will cause the radio features to work improperly. If this happens, contact the radio station.

While you are tuned to an RDS station, the station name or the call letters will appear on the display instead of the frequency. RDS stations may also provide the time of day, a program type (PTY) for current programming, and the name of the program being broadcast.

XM™ Radio Satellite Service (USA Only)

XM™ is a continental U.S. based satellite radio service that offers 100 coast to coast channels including music, news, sports, talk, and children's programming. XM™ provides digital quality audio and text information, including song title and artist name. A service fee is required in order to receive the XM™ service. For more information, contact XM™ at www.xmradio.com or call 1-800-852-XXMM (9696).

Playing the Radio

PWR (Power): Press this knob to turn the system on and off.

VOL (Volume): Turn this knob to increase or to decrease volume.

SCV (Speed-Compensated Volume): With SCV, your audio system adjusts automatically to make up for road and wind noise as you drive.

Set the volume at the desired level. Press this button to select MIN, MED or MAX. Each higher choice allows for more volume compensation at faster vehicle speeds. Then, as you drive, SCV automatically increases the volume, as necessary, to overcome noise at any speed. The volume level should always sound the same to you as you drive. If you don't want to use SCV, select OFF.

RCL (Recall): Push this knob to switch the display between the radio station frequency and the time. Pushing this knob with the ignition off will display the time.

For XM™ (USA only, if equipped), push this knob while in XM™ mode to retrieve four different categories of information related to the current song or channel: Artist, Song Title, Category or PTY, Channel Number/Channel Name.

To change the default on the display, push the knob until you see the display you want, then hold the knob until the display flashes. The selected display will now be the default.

Finding a Station

BAND: Press this button to switch between FM1, FM2, AM, or XM1 or XM2 (USA only, if equipped). The display will show your selection.

TUNE: Turn this knob to choose radio stations.

△ **SEEK** ▽: Press the up or the down arrow to go to the next or to the previous station and stay there.

The radio will seek only to stations that are in the selected band and only to those with a strong signal.

△ **SCAN** ▽: Press and hold one of the SCAN arrows for two seconds until SCAN appears on the display and you hear a beep. The radio will go to a station, play for a few seconds, then go on to the next station. Press one of the SCAN arrows again to stop scanning.

To scan preset stations, press and hold one of the SCAN arrows for more than four seconds until PSCAN and the preset number appear on the display. You will hear a double beep. The radio will go to the first preset station stored on your pushbuttons, play for a few seconds, then go on to the next preset station. Press one of the SCAN arrows again to stop scanning presets.

The radio will scan only to stations that are in the selected band and only to those with a strong signal.

Setting Preset Stations

The six numbered pushbuttons let you return to your favorite stations. You can set up to 30 stations (six FM1, six FM2, and six AM, six XM1 and six XM2 (USA only, if equipped)), by performing the following steps:

1. Turn the radio on.
2. Press BAND to select FM1, FM2, AM, or XM1 or XM2.
3. Tune in the desired station.
4. Press EQ to select the equalization.
5. Press and hold one of the six numbered pushbuttons until you hear a beep. Whenever you press that numbered pushbutton, the station you set will return and the equalization that you selected will also be automatically selected for that pushbutton.
6. Repeat the steps for each pushbutton.

Setting the Tone (Bass/Treble)

TONE: Press and release this button until BASS, MID, or TREB appears on the display. The SELECT LED indicator will light to show that the tone control can be adjusted. Turn the SELECT knob to increase or to decrease. If a station is weak or noisy, you may want to decrease the treble.

Pressing and holding the TONE button for two seconds will return all speaker settings to the middle position.

EQ (Equalizer): Press this button to select customized bass, mid, and treble equalization settings.

You can set up to six customized equalization settings by performing the following steps:

1. Turn the radio on.
2. Use the TONE button and the SELECT knob to create the desired equalization.
3. Press and hold the EQ button for two seconds. SELECT EQ # will appear on the display and the EQ symbol will flash.
4. Press EQ or turn the SELECT knob to select the desired EQ number.

5. Press and hold the EQ button or push the SELECT knob to store the equalization setting and the number. You will hear a beep and EQ SAVED will appear on the display.
6. Repeat the steps for the other EQ settings and numbers.

EQ 5 has been programmed at the factory for use with talk radio, but it can be set to a different tone.

Adjusting the Speakers (Balance/Fade)

BAL (Balance): Press and release this button until BAL appears on the display. The SELECT LED indicator will light to show that the speakers can be adjusted. Turn the SELECT knob to move the sound toward the left or the right speakers.

FADE: Press and release this button until FADE appears on the display. The SELECT LED indicator will light to show that the speakers can be adjusted. Turn the SELECT knob to move the sound toward the front or the rear speakers.

Pressing and holding the BAL FADE button for two seconds will return all speaker settings to the middle position.

Finding a PTY Station (RDS and XM™)

To select and find a desired PTY perform the following:

1. Press PROG TYPE. PTY will be displayed on the screen.
2. Select a category by turning the SELECT knob.
3. Once the desired category is displayed, press either SEEK arrow to select the category and take you to the category's first station.
4. If you want to go to another station within that category and the category is displayed, press either SEEK arrow once. If the category is not displayed, press either SEEK arrow twice to display the category and then to go to another station.

SCAN: You can also scan through the channels within a category by performing the following:

1. Press PROG TYPE. PTY will be displayed on the screen.
2. Select a category by turning the SELECT knob.

3. Once the desired category is displayed, press and hold either SCAN arrow, and the radio will begin scanning within your chosen category.
4. Press either SCAN arrow again to stop at a particular station.

BAND (Alternate Frequency): Alternate frequency allows the radio to switch to a stronger station with the same programming. Press and hold BAND for two seconds to turn alternate frequency on. AF ON will appear on the display. The radio may switch to stronger stations. Press and hold BAND again for two seconds to turn alternate frequency off. AF OFF will appear on the display. The radio will not switch to other stations.

This function does not apply for XM™ Satellite Radio Service.

Setting Preset PTYs (RDS Only)

The six numbered pushbuttons let you return to your favorite program types (PTYs). These pushbuttons have factory PTY presets. You can set up to 12 PTYs (six FM1 and six FM2) by performing the following steps:

1. Press BAND to select FM1 or FM2.
2. Press PROG TYPE to activate program type select mode.
3. Turn the SELECT knob to select a PTY.
4. Press and hold one of the six numbered pushbuttons until you hear a beep. Whenever you press that numbered pushbutton, the PTY you set will return, if program type select mode is activated.
5. Repeat the steps for each pushbutton.

RDS Messages

ALERT!: Alert warns of local or national emergencies. When an alert announcement comes on the current radio station, ALERT! will appear on the display. You will hear the announcement, even if the volume is muted or a cassette tape or a compact disc is playing. If the cassette tape or compact disc player is playing, play will stop during the announcement. You will not be able to turn off alert announcements.

ALERT! will not be affected by tests of the emergency broadcast system. This feature is not supported by all RDS stations.

INFO (Information): If the current station has a message, INFO will appear on the display. Press this button to see the message. The message may display the artist and song title, call in phone numbers, etc.

If the whole message is not displayed, parts of it will appear every three seconds. To scroll through the message at your own speed, press the INFO button repeatedly. A new group of words will appear on the display with each press. Once the complete message has been displayed, INFO will disappear from the display until another new message is received. The old message can be displayed by pressing the INFO button until a new message is received or a different station is tuned to.

TRAF (Traffic): If TRAF appears on the display, the tuned station broadcasts traffic announcements. To receive the traffic announcement from the tuned station, press this button. Brackets will be displayed around TRAF and when a traffic announcement comes on the tuned radio station you will hear it.

If the current tuned station does not broadcast traffic announcements, press this button and the radio will seek to a station that does. When the radio finds a station that broadcasts traffic announcements, it will stop and brackets will be displayed around TRAF. When a traffic announcement comes on the tuned radio station you will hear it. If no station is found, NO TRAFFIC will appear on the display.

If the brackets are on the display and TRAF is not, you can then press the TRAF button to remove the brackets or use the TUNE knob or the SEEK arrows to go to a station that supports traffic announcements. If no station is found, NO TRAFFIC will appear on the display.

Your radio will play the traffic announcements even if the volume is muted or interrupt the play of a cassette tape or CD if the last tuned station broadcasts traffic announcements.

This function does not apply to XM™ Satellite Radio Service.

Radio Messages

CALIBRATE: Your audio system has been calibrated for your vehicle from the factory. If CALIBRATE appears on the display, it means that your radio has not been configured properly for your vehicle and must be returned to the dealership for service.

XM™ Radio Messages

Radio Display Message	Condition	Action Required
XL (Explicit Language Channels)	XL on the radio display, after the channel name, indicates content with explicit language.	These channels, or any others, can be blocked at a customer's request, by calling 1-800-852-XXMX (9696).
Updating	Updating encryption code	The encryption code in your receiver is being updated, and no action is required. This process should take no longer than 30 seconds.
No Signal	Loss of signal	Your system is functioning correctly, but you are in a location that is blocking the XM signal. When you move into an open area, the signal should return.
Loading XM	Acquiring channel audio (after 4 second delay)	Your radio system is acquiring and processing audio and text data. No action is needed. This message should disappear shortly.
CH Off Air	Channel not in service	This channel is not currently in service. Tune to another channel.
CH Unavail	Channel no longer available	This previously assigned channel is no longer assigned. Tune to another station. If this station was one of your presets, you may need to choose another station for that preset button.
No Info	Artist Name/Feature not available	No artist information is available at this time on this channel. Your system is working properly.
No Info	Song/Program Title not available	No song title information is available at this time on this channel. Your system is working properly.

XM™ Radio Messages (cont'd)

Radio Display Message	Condition	Action Required
No Info	Category Name not available	No category information is available at this time on this channel. Your system is working properly.
No Info	No Text/Informational message available	No text or informational messages are available at this time on this channel. Your system is working properly.
Not Found	No channel available for the chosen category	There are no channels available for the category you selected. Your system is working properly.
XM Locked	Theft lock active	The XM receiver in your vehicle may have previously been in another vehicle. For security purposes, XM receivers cannot be swapped between vehicles. If you receive this message after having your vehicle serviced, check with the servicing facility.
Radio ID	Radio ID label (channel 0)	If you tune to channel 0, you will see this message alternating with your XM Radio 8 digit radio ID label. This label is needed to activate your service.
Unknown	Radio ID not known (should only be if hardware failure)	If you receive this message when you tune to channel 0, you may have a receiver fault. Consult with your dealer.
Chk XMRCvr	Hardware failure	If this message does not clear within a short period of time, your receiver may have a fault. Consult with your retail location.

Playing a Cassette Tape

Your tape player is built to work best with tapes that are up to 30 to 45 minutes long on each side. Tapes longer than that are so thin they may not work well in this player. The longer side with the tape visible should face to the right. If the ignition is on, but the radio is off, the tape can be inserted and will begin playing. If you hear nothing but a garbled sound, the tape may not be in squarely. Press the eject button to remove the tape and start over.

While the tape is playing, use the VOL, BAL, FADE, TONE, EQ, and SEEK controls just as you do for the radio. The display will show TAPE and an arrow showing which side of the tape is playing. The tape player automatically begins playing the other side when it reaches the end of the tape.

Your tape bias is set automatically when a metal or chrome tape is inserted. If you want to insert a tape while the ignition is off, first press the eject button or push the RCL knob.

If an error appears on the display, see “Cassette Tape Messages” later in this section.

▶▶ 1 (Forward): Press this pushbutton to advance quickly to another part of the tape. Press this pushbutton again to return to playing speed. The radio will play while the tape advances. You may select stations during forward operation by using TUNE, SEEK, and SCAN.

While in forward mode, the display will show **FREQ** and **FWD** and two right arrows. If the radio is playing a RDS station, the display will only show **FREQ**.

▽△ 2 (Side): Press this pushbutton to play the other side of the tape.

4 ◀◀ (Reverse): Press this pushbutton to reverse the tape rapidly. Press it again to return to playing speed. The radio will play the tape reverses. You may select stations during reverse operation by using TUNE, SEEK, and SCAN.

EQ (Equalizer): Press EQ to select the desired customized equalization setting while playing a cassette. The equalization will be automatically set whenever you play a cassette tape. See “EQ” listed previously for more information.

△ SEEK ▽: Your tape must have at least three seconds of silence between each selection for seek to work. Press the up or the down arrow to search for the next or the previous selection on the tape. You can skip as many as nine selections up or down on the tape. Choose how many selections you want to skip, then press the SEEK arrow that many times. The number of selections to be skipped will appear on the display.

△ SCAN ▽: Press and hold one of the arrows for more than two seconds until SCAN appears on the display and you hear a beep. The tape will go to the next selection, play for a few seconds, then go on to the next selection. The tape will scan in forward only. Press this button again to stop scanning.

BAND: Press this button to listen to the radio when a tape is playing. The inactive tape or CD will remain safely inside the radio for future listening.

CD TAPE: Press this button to switch between playing a cassette tape and a compact disc, if both are loaded, when listening to the radio. The display will show tape and CD symbols.

△ (Eject): Press this button, located next to the cassette tape slot, to eject a tape. Eject may be activated with either the ignition or radio off. Cassettes may be loaded with the radio and ignition off if this button is pressed first.

Cassette Tape Messages

If an error occurs while trying to play a cassette tape, it could be for one of the following reasons:

TIGHT TAPE: This message is displayed when the tape is tight and the player can't turn the tape hubs. Remove the tape. Hold the tape with the open end down and try to turn the right hub counterclockwise with a pencil. Turn the tape over and repeat. If the hubs do not turn easily, your tape may be damaged and should not be used in the player. Try a new tape to make sure your player is working properly.

BROKEN TAPE: This message is displayed when the tape is broken. Try a new tape.

WRAPPED TAPE: This message is displayed when the tape is wrapped around the tape head. Attempt to get the cassette out. Try a new tape.

CLEAN PLAYER: If this message appears on the display, the cassette tape player needs to be cleaned. It will still play tapes, but you should clean it as soon as possible to prevent damage to the tapes and player. See *Care of Your Cassette Tape Player on page 3-130*.

If any error occurs repeatedly or if an error can't be corrected, contact your dealer. If your radio displays an error message, write it down and provide it to your dealer when reporting the problem.

CD Adapter Kits

It is possible to use a portable CD player adapter kit with your cassette tape player after disabling the tight/loose tape sensing feature on your tape player.

To disable the feature, use the following steps:

1. Turn the ignition on.
2. Turn the radio off.
3. Press and hold the CD TAPE button. The radio will display READY and flash the cassette symbol.
4. Insert the adapter into the cassette slot. It will power up the radio and begin playing.

The override feature will remain active until the eject button is pressed.

Playing a Compact Disc

With the ignition on, insert a disc partway into the slot, label side up. The player will pull it in and the disc should begin playing. If you want to insert a CD when the ignition is off, first press the eject symbol or push the RCL knob. If you insert a CD with the radio off and the ignition on, it will start to play.

When the disc is inserted, the CD symbol will be displayed. If you select an EQ setting for your CD, it will be activated each time you play a CD.

As each new track starts to play, the track number will appear on the display.

The integral CD player can play the smaller 8 cm single discs with an adapter ring. Full-size compact discs and the smaller discs are loaded in the same manner.

If playing a CD-R the sound quality may be reduced due to CD-R quality, the method of recording, the quality of the music that has been recorded, and the way the CD-R has been handled. You may experience an increase in skipping, difficulty in finding tracks, and/or difficulty in loading and ejecting. If these problems occur try a known good CD.

Do not add paper labels to discs, they could get caught in the CD player.

Do not play 3 inch discs without a standard adapter disc.

If an error appears on the display, see "Compact Disc Messages" later in this section.

▶▶ 1 (Forward): Press and hold this pushbutton to advance quickly within a track. You will hear sound at a reduced volume. Release it to play the passage. The display will show elapsed time.

RDM 3 (Random): Press this pushbutton to hear the tracks in random, rather than sequential, order. RDM and the track number will appear on the display.

4 ◀◀ (Reverse): Press and hold this pushbutton to reverse quickly within a track. You will hear sound at a reduced volume. Release it to play the passage. The display will show elapsed time.

EQ (Equalizer): Press EQ to select the desired customized equalization setting while playing a compact disc. The equalization will be automatically set whenever you play a compact disc. See "EQ" listed previously for more information.

△ SEEK ▽: Press the down arrow while playing a CD to go to the start of the current track if more than eight seconds have played. Press the up arrow to go to the next track. If you press either arrow more than once, the player will continue moving backward or forward through the disc.

△ SCAN ▽: Press and hold one of the arrows for more than two seconds until SCAN and the track number appear on the display and you hear a beep. The disc will go to the next track, play for a few seconds, then go on to the next track. Press this button again to stop scanning.

RCL (Recall): Press this knob to see how long the current track has been playing. To change the default on the display (track or elapsed time), press the knob until you see the display you want, then hold the knob until the display flashes. The selected display will now be the default. While elapsed time is showing, CD TIME will appear on the display.

BAND: Press this button to listen to the radio when a CD is playing. The inactive CD will remain safely inside the radio for future listening.

CD TAPE: Press this button to switch between playing a cassette tape and a compact disc if both are loaded, when listening to the radio. The inactive tape or CD will remain safely inside the radio for future listening. The display will show tape and CD symbols.

 **(Eject):** Press this button, located next to the CD slot, to eject a CD. Eject may be activated with either the ignition or radio off. CDs may be loaded with the radio and ignition off if this button is pressed first.

Compact Disc Messages

CHECK CD: If this message appears on the radio display and the disc comes out, it could be for one of the following reasons:

- You're driving on a very rough road. When the road becomes smoother, the disc should play.
- The disc is dirty, scratched, wet, or upside down.
- The air is very humid. If so, wait about an hour and try again.
- There may have been a problem while burning the CD.
- The label may be caught in the CD player.

If the CD is not playing correctly, for any other reason, try a known good CD.

If any error occurs repeatedly or if an error can not be corrected, contact your dealer. If your radio displays an error message, write it down and provide it to your dealer when reporting the problem.

Radio with Six-Disc CD



Radio Data System (RDS)

Your audio system is equipped with a Radio Data System (RDS). RDS features are available for use only on FM stations that broadcast RDS information.

With RDS, your radio can do the following:

- Seek to stations broadcasting the selected type of programming
- Receive announcements concerning local and national emergencies
- Display messages from radio stations
- Seek to stations with traffic announcements

This system relies upon receiving specific information from these stations and will only work when the information is available. In rare cases, a radio station may broadcast incorrect information that will cause the radio features to work improperly. If this happens, contact the radio station.

While you are tuned to an RDS station, the station name or the call letters will appear on the display instead of the frequency. RDS stations may also provide the time of day, a program type (PTY) for current programming, and the name of the program being broadcast.

XM™ Radio Satellite Service (USA Only)

XM™ is a continental U.S. based satellite radio service that offers 100 coast to coast channels including music, news, sports, talk, and children's programming. XM™ provides digital quality audio and text information, including song title and artist name. A service fee is required in order to receive the XM™ service. For more information, contact XM™ at www.xmradio.com or call 1-800-852-XXM (9696).

Playing the Radio

PWR (Power): Press this button to turn the system on and off.

VOL (Volume): Turn this knob to increase or to decrease volume.

AUTO VOL (Automatic Volume): With automatic volume, your audio system adjusts automatically to make up for road and wind noise as you drive by increasing the volume as vehicle speed increases.

Set the volume at the desired level. Press this button to select MIN, MED, or MAX. Each higher setting will provide more volume compensation as vehicle speed increases. The volume level should always sound the same to you as you drive. If you don't want to use automatic volume, select OFF.

RCL (Recall): Push this button to switch the display between the radio station frequency and the time. Pressing this button with the ignition off will display the time.

For XM™ (USA only, if equipped), press this button while in XM™ mode to retrieve four different categories of information related to the current song or channel: Artist, Song Title, Category or PTY, Channel Number/Channel Name.

To change the default on the display, press the button until you see the display you want, then hold the button until the display flashes. The selected display will now be the default.

Finding a Station

BAND: Press this button to switch between FM1, FM2, AM, or XM1 or XM2 (USA only, if equipped). The display will show your selection.

TUNE: Turn this knob to select radio stations.

◀ SEEK ▶ : Press the right or the left arrow to go to the next or to the previous station and stay there.

The radio will seek only to stations that are in the selected band and only to those with a strong signal.

◀ SCAN ▶ : Press and hold either SCAN arrow for two seconds until SC appears on the display and you hear a beep. The radio will go to a station, play for a few seconds, then go on to the next station. Press either SCAN arrow again to stop scanning.

To scan preset stations, press and hold either SCAN arrow for more than four seconds. PRESET SCAN will appear on the display. You will hear a double beep. The radio will go to a preset station stored on your pushbuttons, play for a few seconds, then go on to the next preset station. Press either SCAN arrow again to stop scanning presets.

The radio will scan only to stations that are in the selected band and only to those with a strong signal.

Setting Preset Stations

The six numbered pushbuttons let you return to your favorite stations. You can set up to 30 stations (six FM1, six FM2, and six AM, six XM1 and six XM2 (USA only, if equipped)), by performing the following steps:

1. Turn the radio on.
2. Press BAND to select FM1, FM2, AM, or XM1 or XM2.
3. Tune in the desired station.
4. Press AUTO EQ to select the equalization.
5. Press and hold one of the six numbered pushbuttons until you hear a beep. Whenever you press that numbered pushbutton, the station you set will return and the equalization that you selected will also be automatically selected for that pushbutton.
6. Repeat the steps for each pushbutton.

Setting the Tone (Bass/Treble)

AUDIO: Push the AUDIO knob until BASS, MID, or TREB appears on the display. Turn the knob to increase or to decrease. If a station is weak or noisy, you may want to decrease the treble.

To adjust bass, midrange, or treble to the middle position, select BASS, MID, or TREB and push and hold the AUDIO knob. The radio will produce one beep and adjust the display level to zero.

To adjust all tone and speaker controls to the middle position, push and hold the AUDIO knob when no tone or speaker control is displayed. The radio will produce one beep and CENTERED will appear on the display.

AUTO EQ (Automatic Equalization): Press this button to choose between bass, midrange, and treble equalization settings designed for country, jazz, talk, pop, rock, and classical program types.

To return to the manual mode (CUSTOM), press the AUTO EQ button until CUSTOM appears on the display. Then you will be able to manually adjust the bass, midrange, and treble using the AUDIO knob.

Adjusting the Speakers (Balance/Fade)

AUDIO: To adjust the balance between the right and the left speakers, push the AUDIO knob until BAL appears on the display. Turn the knob to move the sound toward the left or the right speakers.

To adjust the fade between the front and rear speakers, push and hold the AUDIO knob until FAD appears on the display. Turn the knob to move the sound toward the front or the rear speakers.

To adjust the balance and the fade to the middle position, select balance or fade and push and hold the AUDIO knob. The radio will beep once and will adjust the display level to the middle position.

To adjust all tone and speaker controls to the middle position, push and hold the AUDIO knob when no tone or speaker controls are displayed. The radio will produce one beep and CENTERED will appear on the display.

Finding a PTY Station (RDS and XM™)

To select and find a desired PTY perform the following:

1. Press the P-TYPE button. P-TYPE and the last selected PTY will be displayed on the screen.
2. Select a category by turning the P-TYPE knob.
3. Once the desired category is displayed, press either SEEK arrow to select the category and take you to the category's first station.
4. If you want to go to another station within that category and the category is displayed, press either SEEK arrow once. If the category is not displayed, press either SEEK arrow twice to display the category and then to go to another station.
5. If PTY times out and is no longer on the display, go back to Step 1.

If both P-TYPE and TRAF are on, the radio will search for stations with the selected PTY and traffic announcements.

To use the PTY interrupt feature, press and hold the P-TYPE button until you hear a beep on the PTY you want to interrupt with. When selected, an asterisk will appear beside that PTY on the display. You may select multiple interrupts if desired. When you are listening to a compact disc, the last selected RDS station will interrupt play if that selected program type format is broadcast.

SCAN: You can also scan through the channels within a category by performing the following:

1. Press the P-TYPE button. P-TYPE and the last selected PTY will be displayed on the screen.
2. Select a category by turning the P-TYPE knob.
3. Once the desired category is displayed, press and hold either SCAN arrow, and the radio will begin scanning within your chosen category.
4. Press either SCAN arrow again to stop at a particular station.

BAND (Alternate Frequency): Alternate frequency allows the radio to switch to a stronger station with the same program type. Press and hold BAND for two seconds to turn alternate frequency on. AF ON will appear on the display. The radio may switch to stronger stations. Press and hold BAND again for two seconds to turn alternate frequency off. AF OFF will appear on the display. The radio will not switch to other stations. When you turn the ignition off and then on again, the alternate frequency feature will automatically be turned on.

This function does not apply for XM™ Satellite Radio Service.

Setting Preset PTYs (RDS Only)

The six numbered pushbuttons let you return to your favorite program types (PTYs). These pushbuttons have factory PTY presets. You can set up to 12 PTYs (six FM1 and six FM2) by performing the following steps:

1. Press BAND to select FM1 or FM2.
2. Press the P-TYPE button to activate program type select mode.
3. Turn the P-TYPE knob to select a PTY.
4. Press and hold one of the six numbered pushbuttons until you hear a beep. Whenever you press that numbered pushbutton, the PTY you set will return.
5. Repeat the steps for each pushbutton.

RDS Messages

ALERT!: Alert warns of local or national emergencies. When an alert announcement comes on the current radio station, ALERT! will appear on the display. You will hear the announcement, even if the volume is muted or a compact disc is playing. If the compact disc player is playing, play will stop during the announcement. You will not be able to turn off alert announcements.

ALERT! will not be affected by tests of the emergency broadcast system. This feature is not supported by all RDS stations.

INFO (Information): If the current station has a message, INFO will appear on the display. Press this button to see the message. The message may display the artist and song title, call in phone numbers, etc.

If the whole message is not displayed, parts of it will appear every three seconds. To scroll through the message at your own speed, press the INFO button repeatedly. A new group of words will appear on the display with each press. Once the complete message has been displayed, INFO will disappear from the display until another new message is received. The old message can be displayed by pressing the INFO button until a new message is received or a different station is tuned to.

TRAF (Traffic): If TRAF appears on the display, the tuned station broadcasts traffic announcements. To receive the traffic announcement from the tuned station, press this button. Brackets will be displayed around TRAF and when a traffic announcement comes on the tuned radio station you will hear it.

If the current tuned station does not broadcast traffic announcements, press this button and the radio will seek to a station that does. When the radio finds a station that broadcasts traffic announcements, it will stop and brackets will be displayed around TRAF. When a traffic announcement comes on the tuned radio station you will hear it. If no station is found, NO TRAFFIC will appear on the display.

If the brackets are on the display and TRAF is not, you can then press the TRAF button to remove the brackets or use the TUNE knob or the SEEK arrows to go to a station that supports traffic announcements. If no station is found, NO TRAFFIC will appear on the display.

Your radio will play the traffic announcements even if the volume is muted or interrupt the play of a CD if the last tuned station broadcasts traffic announcements.

This function does not apply to XM™ Satellite Radio Service.

XM™ Radio Messages

Radio Display Message	Condition	Action Required
XL (Explicit Language Channels)	XL on the radio display, after the channel name, indicates content with explicit language.	These channels, or any others, can be blocked at a customer's request, by calling 1-800-852-XXMX (9696).
Updating	Updating encryption code	The encryption code in your receiver is being updated, and no action is required. This process should take no longer than 30 seconds.
No Signal	Loss of signal	Your system is functioning correctly, but you are in a location that is blocking the XM signal. When you move into an open area, the signal should return.
Loading XM	Acquiring channel audio (after 4 second delay)	Your radio system is acquiring and processing audio and text data. No action is needed. This message should disappear shortly.
CH Off Air	Channel not in service	This channel is not currently in service. Tune to another channel.
CH Unavail	Channel no longer available	This previously assigned channel is no longer assigned. Tune to another station. If this station was one of your presets, you may need to choose another station for that preset button.
No Info	Artist Name/Feature not available	No artist information is available at this time on this channel. Your system is working properly.
No Info	Song/Program Title not available	No song title information is available at this time on this channel. Your system is working properly.

XM™ Radio Messages (cont'd)

Radio Display Message	Condition	Action Required
No Info	Category Name not available	No category information is available at this time on this channel. Your system is working properly.
No Info	No Text/Informational message available	No text or informational messages are available at this time on this channel. Your system is working properly.
Not Found	No channel available for the chosen category	There are no channels available for the category you selected. Your system is working properly.
XM Locked	Theft lock active	The XM receiver in your vehicle may have previously been in another vehicle. For security purposes, XM receivers cannot be swapped between vehicles. If you receive this message after having your vehicle serviced, check with the servicing facility.
Radio ID	Radio ID label (channel 0)	If you tune to channel 0, you will see this message alternating with your XM Radio 8 digit radio ID label. This label is needed to activate your service.
Unknown	Radio ID not known (should only be if hardware failure)	If you receive this message when you tune to channel 0, you may have a receiver fault. Consult with your dealer.
Chk XMRCvr	Hardware failure	If this message does not clear within a short period of time, your receiver may have a fault. Consult with your retail location.

Playing a Compact Disc

The integral CD player can play the smaller 8 cm single discs with an adapter ring. Full-size compact discs and the smaller discs are loaded in the same manner.

If playing a CD-R the sound quality may be reduced due to CD-R quality, the method of recording, the quality of the music that has been recorded, and the way the CD-R has been handled. You may experience an increase in skipping, difficulty in finding tracks, and/or difficulty in loading and ejecting. If these problems occur try a know good CD.

Do not add paper labels to discs, they could get caught in the CD player.

Do not play 3 inch discs without a standard adapter disc.

If an error appears on the display, see “Compact Disc Messages” later in this section.

LOAD CD  : Press the LOAD side of this button to load CDs into the compact disc player. This compact disc player will hold up to six discs.

To insert one disc, do the following:

1. Turn the ignition on.
2. Press and release the LOAD side of the LOAD CD button.
3. Wait for the light, located to the right of the slot, to turn green.
4. Load a disc. Insert the disc partway into the slot, label side up. The player will pull the disc in.

When a disc is inserted, the CD symbol will be displayed. If you select an equalization setting for your disc, it will be activated each time you play a disc.

If the radio is on or off, the disc will begin to play automatically.

To insert multiple discs, do the following:

1. Turn the ignition on.
2. Press and hold the LOAD side of the LOAD CD button for two seconds.

You will hear a beep and the light, located to the right of the slot, will begin to flash.

3. Once the light stops flashing and turns green, load a disc. Insert the disc partway into the slot, label side up. The player will pull the disc in.

Once the disc is loaded, the light will begin flashing again. Once the light stops flashing and turns green you can load another disc. The disc player takes up to six discs. Do not try to load more than six.

To load more than one disc but less than six, complete Steps 1 through 3. When you have finished loading discs, with the radio on or off, press the LOAD side of the LOAD CD button to cancel the loading function. The radio will begin to play the last CD loaded.

When a disc is inserted, the CD symbol will be displayed. If more than one disc has been loaded, a number for each disc will be displayed. If you select an equalization setting for your disc, it will be activated each time you play a disc.

If the radio is on or off, the last disc loaded will begin to play automatically.

As each new track starts to play, the track number will appear on the display.

Playing a Specific Loaded Compact Disc

For every CD loaded, a number will appear on the radio display. To play a specific CD, first press the CD AUX button to start playing a CD. Then press the numbered pushbutton that corresponds to the CD you want to play. A small bar will appear under the CD number that is playing, and the track number will appear.

If an error appears on the radio display, see “Compact Disc Messages” later in this section.

LOAD CD  (Eject): Pressing the CD eject side of this button will eject a single disc or multiple discs. To eject the disc that is currently playing, press and release this button. To eject multiple discs, press and hold this button for two seconds. You will hear a beep and the light will flash to let you know when a disc is being ejected.

REMOVE CD will be displayed. You can now remove the disc. If the disc is not removed, after 25 seconds, the disc will be automatically pulled back into the receiver. If you try to push the disc back into the receiver, before the 25 second time period is complete, the receiver will sense an error and will try to eject the disc several times before stopping.

Do not repeatedly press the CD eject side of the LOAD CD eject button to eject a disc after you have tried to push it in manually. The receiver's 25-second eject timer will reset at each press of eject, which will cause the receiver to not eject the disc until the 25-second time period has elapsed.

Once the player stops and the disc is ejected, remove the disc. After removing the disc, press the PWR knob off and then on again. This will clear the disc-sensing feature and enable discs to be loaded into the player again.

◀ **REV (Reverse):** Press and hold this button to reverse quickly within a track. You will hear sound at a reduced volume. Release it to play the passage. The display will show elapsed time.

FWD ▶▶ **(Forward):** Press and hold this button to advance quickly within a track. You will hear sound at a reduced volume. Release it to play the passage. The display will show elapsed time.

RPT (Repeat): With repeat, you can repeat one track or an entire disc. To use repeat, do the following:

- To repeat the track you are listening to, press and release the RPT button. RPT will appear on the display. Press RPT again to turn it off.
- To repeat the disc you are listening to, press and hold the RPT button for two seconds. RPT will appear on the display. Press RPT again to turn it off.

RDM (Random): With random, you can listen to the tracks in random, rather than sequential, order, on one disc or on all of the discs. To use random, do one of the following:

- To play the tracks on the disc you are listening to in random order, press and release the RDM button. You will hear a beep and RANDOM ONE will appear on the display. Press RDM again to turn it off.
- To play the tracks on all of the discs that are loaded in random order, press and hold RDM for more than two seconds. RANDOM ALL will appear on the display. Press RDM again to turn it off.

AUTO EQ (Automatic Equalization): Press AUTO EQ to select the desired equalization setting while playing a compact disc. The equalization will be automatically set whenever you play a compact disc. For more information on AUTO EQ, see "AUTO EQ" listed previously in this section.

◀ **SEEK** ▶ : Press the left arrow to go to the start of the current track, if more than ten seconds have passed. Press the right arrow to go to the next track. If you press the button more than once, the player will continue moving backward or forward through the disc.

< SCAN > : To scan one disc, press and hold either SCAN arrow for more than two seconds until SCAN appears on the display and you hear a beep. Use this feature to listen to 10 seconds of each track of the currently selected disc. SCAN will appear on the display. Press either SCAN arrow again, to stop scanning.

To scan all loaded discs, press and hold either SCAN arrow for more than four seconds until DISC SCAN appears on the display and you hear a beep. Use this feature to listen to 10 seconds of the first tracks of each disc loaded. Press either SCAN arrow again, to stop scanning.

RCL (Recall): Press this button to see how long the current track has been playing. To change the default on the display (track and elapsed time), press the button until you see the display you want, then hold the button until the display flashes. The selected display will now be the default.

BAND: Press this button to play the radio when a disc(s) is in the player.

Using Song List Mode

The integrated six-disc CD changer has a feature called song list. This feature is capable of saving 20 track selections.

To save tracks into the song list feature, perform the following steps:

1. Turn the CD player on and load it with at least one disc. See "LOAD CD" listed previously in this section for more information.
2. Check to see that the disc changer is not in song list mode. S-LIST should not appear in the display. If S-LIST is present, press the SONG LIST button to turn it off.
3. Select the desired disc by pressing the numbered pushbutton and then use the SEEK SCAN right arrow button to locate the track that you want to save. The track will begin to play.
4. Press and hold the SONG LIST button for two or more seconds to save the track into memory. When SONG LIST is pressed a beep will be heard immediately. After two seconds of pressing SONG LIST continuously, two beeps will sound to confirm that the track has been saved.
5. Repeat Steps 3 and 4 for saving other selections.

If you attempt to save more than 20 selections, S-LIST FULL will appear on the display.

To play the song list, press the SONG LIST button. One beep will be heard and S-LIST will appear on the display. The recorded tracks will begin to play in the order that they were saved.

You may seek through the song list by using the SEEK SCAN arrows. Seeking past the last saved track will return you to the first saved track.

To delete tracks from the song list, perform the following steps:

1. Turn the CD player on.
2. Press the SONG LIST button to turn song list on. S-LIST will appear on the display.
3. Press the SEEK SCAN arrows to select the desired track to be deleted.
4. Press and hold the SONG LIST button for two seconds. When pressing SONG LIST, one beep will be heard immediately. After two seconds of pressing the SONG LIST button continuously, two beeps will be heard to confirm that the track has been deleted.

After a track has been deleted, the remaining tracks are moved up the list. When another track is added to the song list, the track will be added to the end of the list.

To delete the entire song list, perform the following steps:

1. Turn the disc player on.
2. Press the SONG LIST button to turn song list on. S-LIST will appear on the display.
3. Press and hold the SONG LIST button for more than four seconds. A beep will be heard, followed by two beeps after two seconds and a final beep will be heard after four seconds. S-LIST EMPTY will appear on the display indicating that the song list has been deleted.

If a disc is ejected, and the song list contains saved tracks from that disc, those tracks are automatically deleted from the song list. Any tracks saved to the song list again are added to the bottom of the list.

To end song list mode, press the SONG LIST button. One beep will be heard and S-LIST will be removed from the display.

Compact Disc Messages

CHECK CD: If this message appears on the radio display, it could be due to one of the following reasons:

- You're driving on a very rough road. When the road becomes smoother, the disc should play.
- The disc is dirty, scratched, wet, or upside down.
- The air is very humid. If so, wait about an hour and try again.
- There may have been a problem while burning the CD.
- The label may be caught in the CD player.

If the CD is not playing correctly, for any other reason, try a known good CD.

If any error occurs repeatedly or if an error can not be corrected, contact your dealer. If your radio displays an error message, write it down and provide it to your dealer when reporting the problem.

Theft-Deterrent Feature

THEFTLOCK[®] is designed to discourage theft of your radio. The feature works automatically by learning a portion of the Vehicle Identification Number (VIN). If the radio is moved to a different vehicle, it will not operate and LOCKED will be displayed.

When the radio and vehicle are turned off, the blinking red light indicates that THEFTLOCK[®] is armed.

With THEFTLOCK[®] activated, your radio will not operate if stolen.

Audio Steering Wheel Controls

If your vehicle has this feature, you can control certain radio functions using the buttons on your steering wheel.



△ ◀ ▶ ▽ (**Seek**): Press the up arrow to seek to the next station and the down arrow to seek to the previous station. The sound will mute while seeking.

When playing a cassette tape press either arrow to go to the previous or next selection on the cassette tape. Your tape must have at least three seconds of silence between each selection for previous to work.

When playing a compact disc press either arrow to go to the previous or next selection on the CD if more than eight seconds have passed. If you press either arrow more than once, the player will continue moving backward or forward through the disc.

BAND: Press this button to choose FM1, FM2, AM, or XM1 or XM2 (USA only, if equipped).

1 - 6: Press this button to scan your radio preset stations. The radio will scan to the first preset station stored on your pushbuttons, play for a few seconds, then go on to the next preset station. The radio will scan only to stations that are in the selected band and only to those with a strong signal. Press this button again to stop scanning.

🔇 (**Mute**): Press this button to silence the system. Press it again to turn on the sound.

▶ (**Play**): Press this button to play a cassette tape or compact disc when listening to the radio.

△ ◀ ▽ (**Volume**): Press the up or down arrow to increase or decrease volume.

Understanding Radio Reception

AM

The range for most AM stations is greater than for FM, especially at night. The longer range, however, can cause stations to interfere with each other. AM can pick up noise from things like storms and power lines. Try reducing the treble to reduce this noise if you ever get it.

FM Stereo

FM stereo will give you the best sound, but FM signals will reach only about 10 to 40 miles (16 to 65 km). Tall buildings or hills can interfere with FM signals, causing the sound to come and go.

XM™ Satellite Radio Service (USA Only)

XM™ Satellite Radio gives you digital radio reception from coast to coast. Just as with FM, tall buildings or hills can interfere with satellite radio signals, causing the sound to come and go. Your radio may display “NO SIGNAL” to indicate interference.

Care of Your Cassette Tape Player

A tape player that is not cleaned regularly can cause reduced sound quality, ruined cassettes, or a damaged mechanism. Cassette tapes should be stored in their cases away from contaminants, direct sunlight, and extreme heat. If they are not, they may not operate properly or may cause failure of the tape player.

Your tape player should be cleaned regularly after every 50 hours of use. Your radio will display CLEAN PLAYER to indicate that you have used your tape player for 50 hours without resetting the tape clean timer. If this message appears on the display, your cassette tape player needs to be cleaned. It will still play tapes, but you should clean it as soon as possible to prevent damage to your tapes and player. If you notice a reduction in sound quality, try a known good cassette to see if the tape or the tape player is at fault. If this other cassette has no improvement in sound quality, clean the tape player.

For best results, use a scrubbing action, non-abrasive cleaning cassette with pads which scrub the tape head as the hubs of the cleaner cassette turn. The recommended cleaning cassette is available through your dealership.

The broken tape detection feature of your cassette tape player may identify the cleaning cassette as a damaged tape, in error. To prevent the cleaning cassette from being ejected, use the following steps:

1. Turn the ignition on.
2. Turn the radio off.
3. Press and hold the CD TAPE button for five seconds. READY will appear on the display for five seconds.
4. Insert the scrubbing action cleaning cassette.
5. Eject the cleaning cassette after the manufacturer's recommended cleaning time.

After the cleaning cassette is ejected, the broken tape detection feature will be active again.

You may also choose a non-scrubbing action, wet-type cleaner which uses a cassette with a fabric belt to clean the tape head. This type of cleaning cassette will not eject on its own. A non-scrubbing action cleaner may not clean as thoroughly as the scrubbing type cleaner. The use of a non-scrubbing action, dry-type cleaning cassette is not recommended.

After you clean the player, press and hold the eject button for five seconds to reset the CLEAN PLAYER indicator. The radio will display CLEANED to show the indicator was reset.

Cassettes are subject to wear and the sound quality may degrade over time. Always make sure the cassette tape is in good condition before you have your tape player serviced.

Care of Your CDs

Handle discs carefully. Store them in their original cases or other protective cases and away from direct sunlight and dust. If the surface of a disc is soiled, dampen a clean, soft cloth in a mild, neutral detergent solution and clean it, wiping from the center to the edge.

Be sure never to touch the side without writing when handling discs. Pick up discs by grasping the outer edges or the edge of the hole and the outer edge.

Care of Your CD Player

The use of CD lens cleaner discs is not advised, due to the risk of contaminating the lens of the CD optics with lubricants internal to the CD mechanism.

Backglass Antenna

The AM-FM antenna is integrated with the rear window defogger, located in the rear window. Be sure that the inside surface of the rear window is not scratched and that the lines on the glass are not damaged. If the inside surface is damaged, it could interfere with radio reception. Also, for proper radio reception, the antenna connector at the top-center of the rear window needs to be properly attached to the post on the glass.

Notice: Do not try to clear frost or other material from the inside of the rear window with a razor blade or anything else that is sharp. This may damage the rear defogger grid and affect your radio's ability to pick up stations clearly. The repairs wouldn't be covered by your warranty.

Notice: Do not apply aftermarket glass tinting with metallic film. The metallic film in some tinting materials will interfere with or distort the incoming radio reception. Any damage caused to your backglass antenna due to metallic tinting materials will not be covered by your warranty.

Because this antenna is built into your rear window, there is a reduced risk of damage caused by car washes and vandals.

If you choose to add a cellular telephone to your vehicle, and the antenna needs to be attached to the glass, be sure that you do not damage the grid lines for the AM-FM antenna. There is enough space between the lines to attach a cellular telephone antenna without interfering with radio reception.

Do not apply aftermarket glass tinting to the back glass. The metallic film in some tinting materials will interfere with or distort the incoming radio reception. Care must be taken when cleaning the rear window because it breaks in the resistive material heating element and will adversely affect radio and defogger performance. See your dealer for details.

XM™ Satellite Radio Antenna System (United States Only)

Your XM™ Satellite Radio antenna is located on the roof of your vehicle. Keep this antenna clear of snow and ice build up for clear radio reception.

The performance of your XM system may be affected if your sunroof is open.

Section 4 Driving Your Vehicle

Your Driving, the Road, and Your Vehicle	4-2	City Driving	4-23
Defensive Driving	4-2	Freeway Driving	4-24
Drunken Driving	4-3	Before Leaving on a Long Trip	4-25
Control of a Vehicle	4-6	Highway Hypnosis	4-26
Braking	4-6	Hill and Mountain Roads	4-26
Traction Control System (TCS)	4-10	Winter Driving	4-28
Enhanced Traction System (ETS)	4-11	If You Are Stuck: In Sand, Mud, Ice or Snow	4-32
StabiliTrak® Plus System	4-13	Towing	4-33
Steering	4-14	Towing Your Vehicle	4-33
Off-Road Recovery	4-16	Recreational Vehicle Towing	4-33
Passing	4-16	Loading Your Vehicle	4-35
Loss of Control	4-18	Towing a Trailer	4-37
Driving at Night	4-19		
Driving in Rain and on Wet Roads	4-20		

Your Driving, the Road, and Your Vehicle

Defensive Driving

The best advice anyone can give about driving is: Drive defensively.

Please start with a very important safety device in your vehicle: Buckle up. See *Safety Belts: They Are for Everyone* on page 1-10.

Defensive driving really means “be ready for anything.” On city streets, rural roads or freeways, it means “always expect the unexpected.”

Assume that pedestrians or other drivers are going to be careless and make mistakes. Anticipate what they might do. Be ready for their mistakes.

Rear-end collisions are about the most preventable of accidents. Yet they are common. Allow enough following distance. It's the best defensive driving maneuver, in both city and rural driving. You never know when the vehicle in front of you is going to brake or turn suddenly.

Defensive driving requires that a driver concentrate on the driving task. Anything that distracts from the driving task — such as concentrating on a cellular telephone call, reading, or reaching for something on the floor — makes proper defensive driving more difficult and can even cause a collision, with resulting injury. Ask a passenger to help do things like this, or pull off the road in a safe place to do them yourself. These simple defensive driving techniques could save your life.

Drunken Driving

Death and injury associated with drinking and driving is a national tragedy. It's the number one contributor to the highway death toll, claiming thousands of victims every year.

Alcohol affects four things that anyone needs to drive a vehicle:

- Judgment
- Muscular Coordination
- Vision
- Attentiveness.

Police records show that almost half of all motor vehicle-related deaths involve alcohol. In most cases, these deaths are the result of someone who was drinking and driving. In recent years, more than 16,000 annual motor vehicle-related deaths have been associated with the use of alcohol, with more than 300,000 people injured.

Many adults — by some estimates, nearly half the adult population — choose never to drink alcohol, so they never drive after drinking. For persons under 21, it's against the law in every U.S. state to drink alcohol. There are good medical, psychological and developmental reasons for these laws.

The obvious way to eliminate the leading highway safety problem is for people never to drink alcohol and then drive. But what if people do? How much is “too much” if someone plans to drive? It's a lot less than many might think. Although it depends on each person and situation, here is some general information on the problem.

The Blood Alcohol Concentration (BAC) of someone who is drinking depends upon four things:

- The amount of alcohol consumed
- The drinker's body weight
- The amount of food that is consumed before and during drinking
- The length of time it has taken the drinker to consume the alcohol.

According to the American Medical Association, a 180 lb (82 kg) person who drinks three 12 ounce (355 ml) bottles of beer in an hour will end up with a BAC of about 0.06 percent. The person would reach the same BAC by drinking three 4 ounce (120 ml) glasses of wine or three mixed drinks if each had 1-1/2 ounces (45 ml) of liquors like whiskey, gin or vodka.



It's the amount of alcohol that counts. For example, if the same person drank three double martinis (3 ounces or 90 ml of liquor each) within an hour, the person's BAC would be close to 0.12 percent. A person who consumes food just before or during drinking will have a somewhat lower BAC level.

There is a gender difference, too. Women generally have a lower relative percentage of body water than men. Since alcohol is carried in body water, this means that a woman generally will reach a higher BAC level than a man of her same body weight will when each has the same number of drinks.

The law in an increasing number of U.S. states, and throughout Canada, sets the legal limit at 0.08 percent. In some other countries, the limit is even lower. For example, it is 0.05 percent in both France and Germany. The BAC limit for all commercial drivers in the United States is 0.04 percent.

The BAC will be over 0.10 percent after three to six drinks (in one hour). Of course, as we've seen, it depends on how much alcohol is in the drinks, and how quickly the person drinks them.

But the ability to drive is affected well below a BAC of 0.10 percent. Research shows that the driving skills of many people are impaired at a BAC approaching 0.05 percent, and that the effects are worse at night. All drivers are impaired at BAC levels above 0.05 percent. Statistics show that the chance of being in a collision increases sharply for drivers who have a BAC of 0.05 percent or above. A driver with a BAC level of 0.06 percent has doubled his or her chance of having a collision. At a BAC level of 0.10 percent, the chance of this driver having a collision is 12 times greater; at a level of 0.15 percent, the chance is 25 times greater!

The body takes about an hour to rid itself of the alcohol in one drink. No amount of coffee or number of cold showers will speed that up. “I’ll be careful” isn’t the right answer. What if there’s an emergency, a need to take sudden action, as when a child darts into the street? A person with even a moderate BAC might not be able to react quickly enough to avoid the collision.

There’s something else about drinking and driving that many people don’t know. Medical research shows that alcohol in a person’s system can make crash injuries worse, especially injuries to the brain, spinal cord or heart. This means that when anyone who has been drinking — driver or passenger — is in a crash, that person’s chance of being killed or permanently disabled is higher than if the person had not been drinking.

 **CAUTION:**

Drinking and then driving is very dangerous. Your reflexes, perceptions, attentiveness and judgment can be affected by even a small amount of alcohol. You can have a serious—or even fatal—collision if you drive after drinking. Please don’t drink and drive or ride with a driver who has been drinking. Ride home in a cab; or if you’re with a group, designate a driver who will not drink.

Control of a Vehicle

You have three systems that make your vehicle go where you want it to go. They are the brakes, the steering and the accelerator. All three systems have to do their work at the places where the tires meet the road.

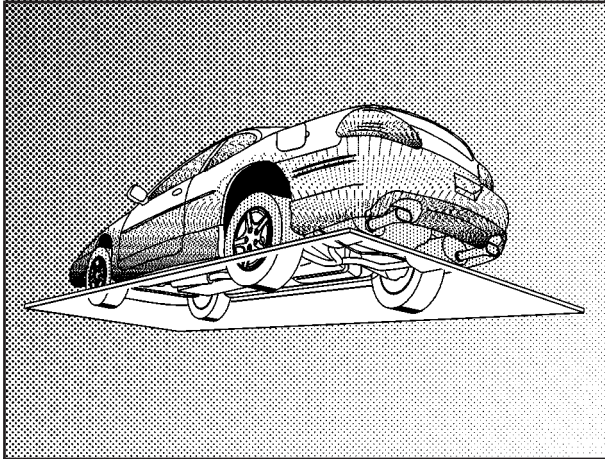

Sometimes, as when you're driving on snow or ice, it's easy to ask more of those control systems than the tires and road can provide. That means you can lose control of your vehicle. Also see *Traction Control System (TCS)* on page 4-10 and *Enhanced Traction System (ETS)* on page 4-11.

Braking

Braking action involves *perception time* and *reaction time*.

First, you have to decide to push on the brake pedal. That's *perception time*. Then you have to bring up your foot and do it. That's *reaction time*.

Average *reaction time* is about 3/4 of a second.

But that's only an average. It might be less with one driver and as long as two or three seconds or more with another. Age, physical condition, alertness, coordination and eyesight all play a part. So do alcohol, drugs and frustration. But even in 3/4 of a second, a vehicle moving at 60 mph (100 km/h) travels 66 feet (20 m). That could be a lot of distance in an emergency, so keeping enough space between your vehicle and others is important.

And, of course, actual stopping distances vary greatly with the surface of the road (whether it's pavement or gravel); the condition of the road (wet, dry, icy); tire tread; the condition of your brakes; the weight of the vehicle and the amount of brake force applied.

Avoid needless heavy braking. Some people drive in spurts — heavy acceleration followed by heavy braking — rather than keeping pace with traffic. This is a mistake. Your brakes may not have time to cool between hard stops. Your brakes will wear out much faster if you do a lot of heavy braking. If you keep pace with the traffic and allow realistic following distances, you will eliminate a lot of unnecessary braking. That means better braking and longer brake life.

If your engine ever stops while you're driving, brake normally but don't pump your brakes. If you do, the pedal may get harder to push down. If your engine stops, you will still have some power brake assist. But you will use it when you brake. Once the power assist is used up, it may take longer to stop and the brake pedal will be harder to push.

Anti-lock Brake System (ABS)

Your vehicle may have anti-lock brakes. ABS is an advanced electronic braking system that will help prevent a braking skid.

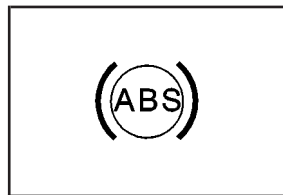

If your vehicle has anti-lock brakes, this warning light on the instrument panel will come on briefly when you start your vehicle.

When you start your engine, or when you begin to drive away, your anti-lock brake system will check itself. You may hear a momentary motor or clicking noise while this test is going on, and you may even notice that your brake pedal moves or pulses a little. This is normal.



Let's say the road is wet and you're driving safely. Suddenly, an animal jumps out in front of you. You slam on the brakes and continue braking. Here's what happens with ABS:

A computer senses that wheels are slowing down. If one of the wheels is about to stop rolling, the computer will separately work the brakes at each wheel.

The anti-lock system can change the brake pressure faster than any driver could. The computer is programmed to make the most of available tire and road conditions. This can help you steer around the obstacle while braking hard.



As you brake, your computer keeps receiving updates on wheel speed and controls braking pressure accordingly.

Remember: Anti-lock doesn't change the time you need to get your foot up to the brake pedal or always decrease stopping distance. If you get too close to the vehicle in front of you, you won't have time to apply your brakes if that vehicle suddenly slows or stops. Always leave enough room up ahead to stop, even though you have anti-lock brakes.

Using Anti-Lock

Don't pump the brakes. Just hold the brake pedal down firmly and let anti-lock work for you. You may feel a slight brake pedal pulsation or notice some noise, but this is normal.

Braking in Emergencies

At some time, nearly every driver gets into a situation that requires hard braking.

If you have anti-lock, you can steer and brake at the same time. However, if you don't have anti-lock, your first reaction — to hit the brake pedal hard and

hold it down — may be the wrong thing to do. Your wheels can stop rolling. Once they do, the vehicle can't respond to your steering. Momentum will carry it in whatever direction it was headed when the wheels stopped rolling. That could be off the road, into the very thing you were trying to avoid, or into traffic.

If you don't have anti-lock, use a "squeeze" braking technique. This will give you maximum braking while maintaining steering control. You can do this by pushing on the brake pedal with steadily increasing pressure.

In an emergency, you will probably want to squeeze the brakes hard without locking the wheels. If you hear or feel the wheels sliding, ease off the brake pedal. This will help you retain steering control. If you *do* have anti-lock, it's different. See "Anti-Lock Brake System" in this section.

In many emergencies, steering can help you more than even the very best braking.

Traction Control System (TCS)

If your vehicle has the 3800 supercharged V6 engine it has a traction control system that limits wheel spin. This is especially useful in slippery road conditions. The system operates only if it senses that one or both of the front wheels are spinning or beginning to lose traction. When this happens, the system works the front brakes and reduces engine power to limit wheel spin.

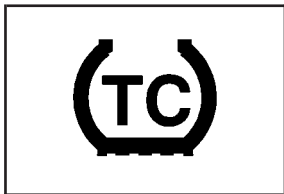

This symbol will appear on the DIC screen when the system is active, along with the TRACTION CONTROL ACTIVE message.

You may feel or hear the system working, but this is normal.

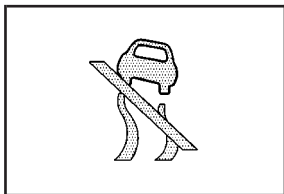

When the traction control system is not working, this symbol will appear on the instrument panel cluster.

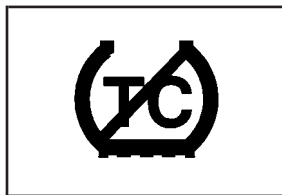

This symbol, along with the message TRACTION CONTROL OFF will also display in the DIC for three seconds when the traction control system is not active.

When these symbols and messages appear on the instrument panel and the Driver's Information Center (DIC), the system will not limit wheel spin. Adjust your driving accordingly.

The traction control system automatically comes on whenever you start your vehicle. To limit wheel spin, especially in slippery road conditions, you should always leave the system on. But you can turn the traction control system off if you ever need to. You should turn the system off if your vehicle ever gets stuck in sand, mud or snow and rocking the vehicle is required. See "Rocking Your Vehicle to Get It Out" under *If You Are Stuck: In Sand, Mud, Ice or Snow* on page 4-32.



To turn the system off, press the traction control button located on the console.

If the system is limiting wheel spin when you press the button the system will turn off instantly. You can turn the system back on at any time by pressing the button again.

If your vehicle is in cruise control when the traction control system begins to limit wheel spin, the cruise control will automatically disengage. When road conditions allow you to safely use it again, you may reengage the cruise control. See *Cruise Control Lever on page 3-8*.

Enhanced Traction System (ETS)

If your vehicle has the 3800 V6 engine and anti-lock brakes, your vehicle may have an Enhanced Traction System (ETS) that limits wheel spin. This is especially useful in slippery road conditions. The system operates only if it senses that one or both of the front wheels are spinning or beginning to lose traction. When this happens, the system reduces engine power and may also upshift the transaxle to limit wheel spin.

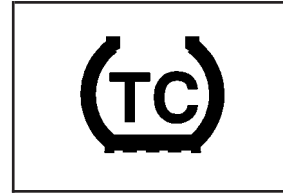

This symbol will appear on the Driver Information Center (DIC) when your Enhanced Traction System is limiting wheel spin.

If your vehicle is in cruise control when the enhanced traction system begins to limit wheel spin, the cruise control will automatically disengage. When road conditions allow you to safely use it again, you may re-engage the cruise control. See *Cruise Control Lever on page 3-8*.

The Enhanced Traction System operates in all transaxle shift lever positions. But the system can upshift the transaxle only as high as the shift lever position you've chosen, so you should use the lower gears only when necessary. See *Automatic Transaxle Operation on page 2-22*.

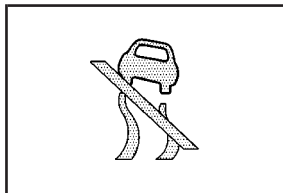

This warning light appears on the instrument panel to indicate that the ETS is not on.

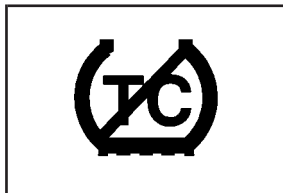

This symbol, along with the message TRACTION CONTROL OFF will also display on the DIC for three seconds when the ETS is not active.

See *Enhanced Traction System Warning Light on page 3-38*. When this warning light is on, the system will not limit wheel spin. Adjust your driving accordingly.

To limit wheel spin, especially in slippery road conditions, you should always leave the ETS on. But you can turn the system off if you ever need to. You should turn the system off if your vehicle ever gets stuck in sand, mud or snow and rocking the vehicle is required. See "Rocking Your Vehicle To Get It Out" under *If You Are Stuck: In Sand, Mud, Ice or Snow on page 4-32*.



To turn the system off, press the traction control button located on the console.

If the system is limiting wheel spin when you press the button the system will turn off instantly. You can turn the system back on at any time by pressing the button again.

Stabilitrak[®] Plus System

Your vehicle may be equipped with a vehicle stability enhancement system called Stabilitrak[®] Plus. It is an advanced computer controlled system that assists you with directional control of the vehicle in difficult driving conditions.

Stabilitrak[®] Plus comes on whenever the vehicle is started. It activates when the computer senses a discrepancy between your intended path and the direction the vehicle is actually traveling. Stabilitrak[®] Plus selectively applies braking pressure at any one of the vehicle's brakes to help steer the vehicle in the direction which you are steering.

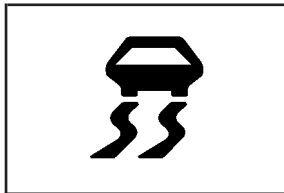

This symbol, along with the STABILITY CONTROL ACTIVE message will appear on the Driver Information Center (DIC).

See *DIC Warnings and Messages* on page 3-65. You may also hear a noise or feel vibration in the brake pedal. This is normal. Continue to steer the vehicle in the direction you want it to go.

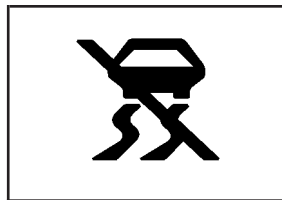

If there is a problem detected with Stabilitrak[®] Plus, this symbol along with the SERVICE STABILITY SYSTEM warning message will be displayed on the Driver Information Center (DIC).

See *DIC Warnings and Messages* on page 3-65. When this message is displayed, the system is not operational. Driving should be adjusted accordingly.

If your vehicle is in cruise control when Stabilitrak[®] Plus activates, the cruise control will automatically disengage. When road conditions allow you to safely use it again, you may reengage the cruise control. See *Cruise Control Lever* on page 3-8 for more information.

Steering

Power Steering

If you lose power steering assist because the engine stops or the system is not functioning, you can steer but it will take much more effort.

Variable Effort Steering

If your vehicle has this steering system, the system provides less steering effort for parking and when driving at speeds below 20 mph (32 km/h). Steering effort will increase at higher speeds for improved road feel.

Steering Tips

Driving on Curves

It's important to take curves at a reasonable speed.

A lot of the “driver lost control” accidents mentioned on the news happen on curves. Here's why:

Experienced driver or beginner, each of us is subject to the same laws of physics when driving on curves.

The traction of the tires against the road surface makes it possible for the vehicle to change its path when you turn the front wheels. If there's no traction, inertia will keep the vehicle going in the same direction. If you've ever tried to steer a vehicle on wet ice, you'll understand this.

The traction you can get in a curve depends on the condition of your tires and the road surface, the angle at which the curve is banked, and your speed. While you're in a curve, speed is the one factor you can control.

Suppose you're steering through a sharp curve. Then you suddenly apply the brakes. Both control systems — steering and braking — have to do their work where the tires meet the road. Unless you have four-wheel anti-lock brakes, adding the hard braking can demand too much of those places. You can lose control.

The same thing can happen if you're steering through a sharp curve and you suddenly accelerate. Those two control systems — steering and acceleration — can overwhelm those places where the tires meet the road and make you lose control. See *Traction Control System (TCS) on page 4-10* or *Enhanced Traction System (ETS) on page 4-11*.

What should you do if this ever happens? Ease up on the brake or accelerator pedal, steer the vehicle the way you want it to go, and slow down.

Speed limit signs near curves warn that you should adjust your speed. Of course, the posted speeds are based on good weather and road conditions. Under less favorable conditions you'll want to go slower.

If you need to reduce your speed as you approach a curve, do it before you enter the curve, while your front wheels are straight ahead.

Try to adjust your speed so you can “drive” through the curve. Maintain a reasonable, steady speed. Wait to accelerate until you are out of the curve, and then accelerate gently into the straightaway.

Steering in Emergencies

There are times when steering can be more effective than braking. For example, you come over a hill and find a truck stopped in your lane, or a car suddenly pulls out from nowhere, or a child darts out from between parked cars and stops right in front of you. You can avoid these problems by braking — if you can stop in time. But sometimes you can't; there isn't room. That's the time for evasive action — steering around the problem.

Your vehicle can perform very well in emergencies like these. First apply your brakes.

See *Braking on page 4-6*. It is better to remove as much speed as you can from a possible collision. Then steer around the problem, to the left or right depending on the space available.

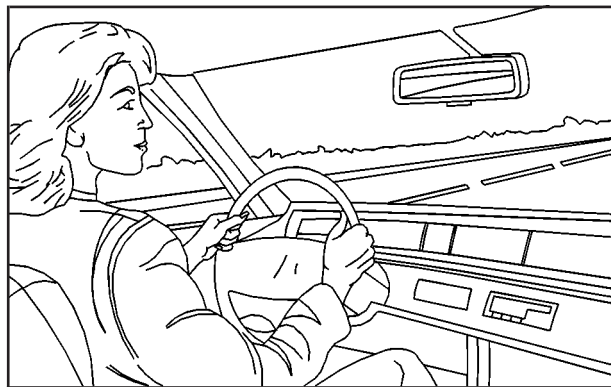

An emergency like this requires close attention and a quick decision. If you are holding the steering wheel at the recommended 9 and 3 o'clock positions, you can turn it a full 180 degrees very quickly without removing either hand. But you have to act fast, steer quickly, and just as quickly straighten the wheel once you have avoided the object.

The fact that such emergency situations are always possible is a good reason to practice defensive driving at all times and wear safety belts properly.

Off-Road Recovery

You may find that your right wheels have dropped off the edge of a road onto the shoulder while you're driving.

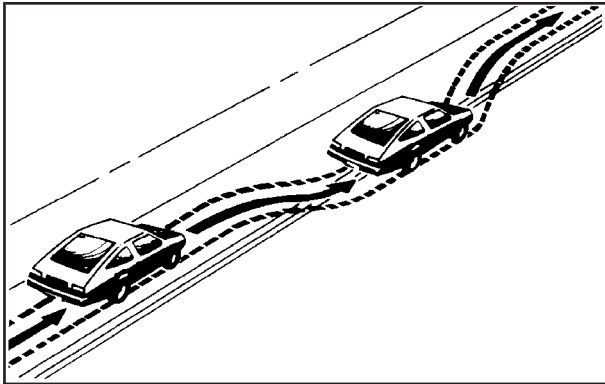

If the level of the shoulder is only slightly below the pavement, recovery should be fairly easy. Ease off the accelerator and then, if there is nothing in the way, steer so that your vehicle straddles the edge of the pavement. You can turn the steering wheel up to one-quarter turn until the right front tire contacts the pavement edge. Then turn your steering wheel to go straight down the roadway.

Passing

The driver of a vehicle about to pass another on a two-lane highway waits for just the right moment, accelerates, moves around the vehicle ahead, then goes back into the right lane again. A simple maneuver?

Not necessarily! Passing another vehicle on a two-lane highway is a potentially dangerous move, since the passing vehicle occupies the same lane as oncoming traffic for several seconds. A miscalculation, an error in judgment, or a brief surrender to frustration or anger can suddenly put the passing driver face to face with the worst of all traffic accidents — the head-on collision.

So here are some tips for passing:

- “Drive ahead.” Look down the road, to the sides and to crossroads for situations that might affect your passing patterns. If you have any doubt whatsoever about making a successful pass, wait for a better time.
- Watch for traffic signs, pavement markings and lines. If you can see a sign up ahead that might indicate a turn or an intersection, delay your pass. A broken center line usually indicates it's all right to pass (providing the road ahead is clear). Never cross a solid line on your side of the lane or a double solid line, even if the road seems empty of approaching traffic.

- Do not get too close to the vehicle you want to pass while you're awaiting an opportunity. For one thing, following too closely reduces your area of vision, especially if you're following a larger vehicle. Also, you won't have adequate space if the vehicle ahead suddenly slows or stops. Keep back a reasonable distance.
- When it looks like a chance to pass is coming up, start to accelerate but stay in the right lane and don't get too close. Time your move so you will be increasing speed as the time comes to move into the other lane. If the way is clear to pass, you will have a "running start" that more than makes up for the distance you would lose by dropping back. And if something happens to cause you to cancel your pass, you need only slow down and drop back again and wait for another opportunity.
- If other vehicles are lined up to pass a slow vehicle, wait your turn. But take care that someone isn't trying to pass you as you pull out to pass the slow vehicle. Remember to glance over your shoulder and check the blind spot.
- Check your mirrors, glance over your shoulder, and start your left lane change signal before moving out of the right lane to pass. When you are far enough ahead of the passed vehicle to see its front in your inside mirror, activate your right lane change signal and move back into the right lane. (Remember that your right outside mirror is convex. The vehicle you just passed may seem to be farther away from you than it really is.)
- Try not to pass more than one vehicle at a time on two-lane roads. Reconsider before passing the next vehicle.
- Don't overtake a slowly moving vehicle too rapidly. Even though the brake lamps are not flashing, it may be slowing down or starting to turn.
- If you're being passed, make it easy for the following driver to get ahead of you. Perhaps you can ease a little to the right.

Loss of Control

Let's review what driving experts say about what happens when the three control systems (brakes, steering and acceleration) don't have enough friction where the tires meet the road to do what the driver has asked.

In any emergency, don't give up. Keep trying to steer and constantly seek an escape route or area of less danger.

Skidding

In a skid, a driver can lose control of the vehicle. Defensive drivers avoid most skids by taking reasonable care suited to existing conditions, and by not "overdriving" those conditions. But skids are always possible.

The three types of skids correspond to your vehicle's three control systems. In the braking skid, your wheels aren't rolling. In the steering or cornering skid, too much speed or steering in a curve causes tires to slip and lose cornering force. And in the acceleration skid, too much throttle causes the driving wheels to spin.

A cornering skid is best handled by easing your foot off the accelerator pedal.

If you do not have the Enhanced Traction System or the Traction Control System, or if the system is off, then an acceleration skid is also best handled by easing your foot off the accelerator pedal.

If your vehicle starts to slide, ease your foot off the accelerator pedal and quickly steer the way you want the vehicle to go. If you start steering quickly enough, your vehicle may straighten out. Always be ready for a second skid if it occurs.

Of course, traction is reduced when water, snow, ice, gravel or other material is on the road. For safety, you'll want to slow down and adjust your driving to these conditions. It is important to slow down on slippery surfaces because stopping distance will be longer and vehicle control more limited.

While driving on a surface with reduced traction, try your best to avoid sudden steering, acceleration or braking (including engine braking by shifting to a lower gear). Any sudden changes could cause the tires to slide. You may not realize the surface is slippery until your vehicle is skidding. Learn to recognize warning clues — such as enough water, ice or packed snow on the road to make a "mirrored surface" — and slow down when you have any doubt.

If you have the anti-lock braking system, remember: It helps avoid only the braking skid. If you do not have anti-lock, then in a braking skid (where the wheels are no longer rolling), release enough pressure on the brakes to get the wheels rolling again. This restores steering control. Push the brake pedal down steadily when you have to stop suddenly. As long as the wheels are rolling, you will have steering control.

Driving at Night

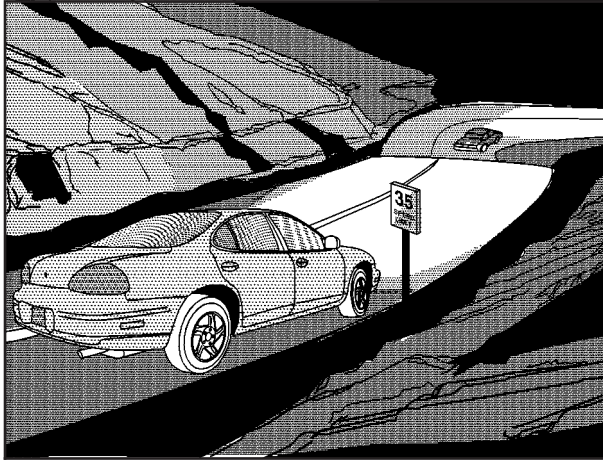

Night driving is more dangerous than day driving. One reason is that some drivers are likely to be impaired — by alcohol or drugs, with night vision problems, or by fatigue.

Here are some tips on night driving.

- Drive defensively.
- Don't drink and drive.
- Adjust your inside rearview mirror to reduce the glare from headlamps behind you.
- Since you can't see as well, you may need to slow down and keep more space between you and other vehicles.
- Slow down, especially on higher speed roads. Your headlamps can light up only so much road ahead.
- In remote areas, watch for animals.
- If you're tired, pull off the road in a safe place and rest.

No one can see as well at night as in the daytime. But as we get older these differences increase. A 50-year-old driver may require at least twice as much light to see the same thing at night as a 20-year-old.

What you do in the daytime can also affect your night vision. For example, if you spend the day in bright sunshine you are wise to wear sunglasses. Your eyes will have less trouble adjusting to night. But if you're driving, don't wear sunglasses at night. They may cut down on glare from headlamps, but they also make a lot of things invisible.

You can be temporarily blinded by approaching headlamps. It can take a second or two, or even several seconds, for your eyes to readjust to the dark. When you are faced with severe glare (as from a driver who doesn't lower the high beams, or a vehicle with misaimed headlamps), slow down a little. Avoid staring directly into the approaching headlamps.

Keep your windshield and all the glass on your vehicle clean — inside and out. Glare at night is made much worse by dirt on the glass. Even the inside of the glass can build up a film caused by dust. Dirty glass makes lights dazzle and flash more than clean glass would, making the pupils of your eyes contract repeatedly.

Remember that your headlamps light up far less of a roadway when you are in a turn or curve. Keep your eyes moving; that way, it's easier to pick out dimly lighted objects. Just as your headlamps should be checked regularly for proper aim, so should your eyes be examined regularly. Some drivers suffer from night blindness — the inability to see in dim light — and aren't even aware of it.

Driving in Rain and on Wet Roads

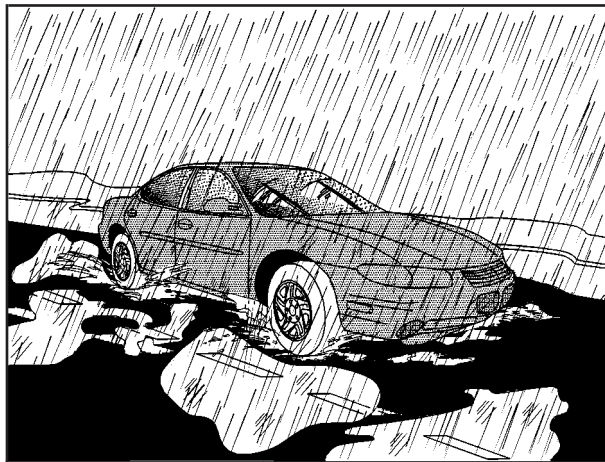

Rain and wet roads can mean driving trouble. On a wet road, you can't stop, accelerate or turn as well because your tire-to-road traction isn't as good as on dry roads. And, if your tires don't have much tread left, you'll get even less traction. It's always wise to go slower and be cautious if rain starts to fall while you are driving. The surface may get wet suddenly when your reflexes are tuned for driving on dry pavement.

The heavier the rain, the harder it is to see. Even if your windshield wiper blades are in good shape, a heavy rain can make it harder to see road signs and traffic signals, pavement markings, the edge of the road and even people walking.

It's wise to keep your windshield wiping equipment in good shape and keep your windshield washer tank filled with washer fluid. Replace your windshield wiper inserts when they show signs of streaking or missing areas on the windshield, or when strips of rubber start to separate from the inserts.

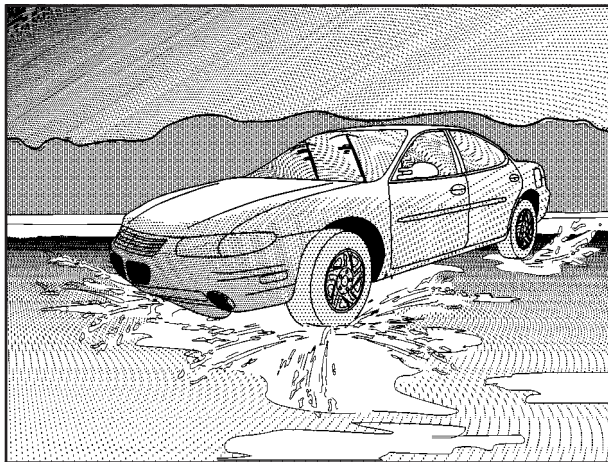

Driving too fast through large water puddles or even going through some car washes can cause problems, too. The water may affect your brakes. Try to avoid puddles. But if you can't, try to slow down before you hit them.

⚠ CAUTION:

Wet brakes can cause accidents. They won't work as well in a quick stop and may cause pulling to one side. You could lose control of the vehicle.

After driving through a large puddle of water or a car wash, apply your brake pedal lightly until your brakes work normally.

Hydroplaning

Hydroplaning is dangerous. So much water can build up under your tires that they can actually ride on the water. This can happen if the road is wet enough and you're going fast enough. When your vehicle is hydroplaning, it has little or no contact with the road.

Hydroplaning doesn't happen often. But it can if your tires do not have much tread or if the pressure in one or more is low. It can happen if a lot of water is standing on the road. If you can see reflections from trees, telephone poles or other vehicles, and raindrops "dimple" the water's surface, there could be hydroplaning.

Hydroplaning usually happens at higher speeds. There just isn't a hard and fast rule about hydroplaning. The best advice is to slow down when it is raining.

Driving Through Deep Standing Water

Notice: If you drive too quickly through deep puddles or standing water, water can come in through your engine's air intake and badly damage your engine. Never drive through water that is slightly lower than the underbody of your vehicle. If you can't avoid deep puddles or standing water, drive through them very slowly.

Driving Through Flowing Water

CAUTION:

Flowing or rushing water creates strong forces. If you try to drive through flowing water, as you might at a low water crossing, your vehicle can be carried away. As little as six inches of flowing water can carry away a smaller vehicle. If this happens, you and other vehicle occupants could drown. Don't ignore police warning signs, and otherwise be very cautious about trying to drive through flowing water.

Some Other Rainy Weather Tips

- Besides slowing down, allow some extra following distance. And be especially careful when you pass another vehicle. Allow yourself more clear room ahead, and be prepared to have your view restricted by road spray.
- Have good tires with proper tread depth. See *Tires on page 5-68*.

City Driving



One of the biggest problems with city streets is the amount of traffic on them. You'll want to watch out for what the other drivers are doing and pay attention to traffic signals.

Here are ways to increase your safety in city driving:

- Know the best way to get to where you are going. Get a city map and plan your trip into an unknown part of the city just as you would for a cross-country trip.
- Try to use the freeways that rim and crisscross most large cities. You'll save time and energy. See the next part, "Freeway Driving."
- Treat a green light as a warning signal. A traffic light is there because the corner is busy enough to need it. When a light turns green, and just before you start to move, check both ways for vehicles that have not cleared the intersection or may be running the red light.

Freeway Driving



Mile for mile, freeways (also called thruways, parkways, expressways, turnpikes or superhighways) are the safest of all roads. But they have their own special rules.

The most important advice on freeway driving is: Keep up with traffic and keep to the right. Drive at the same speed most of the other drivers are driving. Too-fast or too-slow driving breaks a smooth traffic flow. Treat the left lane on a freeway as a passing lane.

At the entrance, there is usually a ramp that leads to the freeway. If you have a clear view of the freeway as you drive along the entrance ramp, you should begin to check traffic. Try to determine where you expect to blend with the flow. Try to merge into the gap at close to the prevailing speed. Switch on your turn signal, check your mirrors and glance over your shoulder as often as necessary. Try to blend smoothly with the traffic flow.

Once you are on the freeway, adjust your speed to the posted limit or to the prevailing rate if it's slower. Stay in the right lane unless you want to pass.

Before changing lanes, check your mirrors. Then use your turn signal.

Just before you leave the lane, glance quickly over your shoulder to make sure there isn't another vehicle in your "blind" spot.

Once you are moving on the freeway, make certain you allow a reasonable following distance.

Expect to move slightly slower at night.

When you want to leave the freeway, move to the proper lane well in advance. If you miss your exit, do not, under any circumstances, stop and back up. Drive on to the next exit.

The exit ramp can be curved, sometimes quite sharply. The exit speed is usually posted. Reduce your speed according to your speedometer, not to your sense of motion. After driving for any distance at higher speeds, you may tend to think you are going slower than you actually are.

Before Leaving on a Long Trip

Make sure you're ready. Try to be well rested. If you must start when you're not fresh — such as after a day's work — don't plan to make too many miles that first part of the journey. Wear comfortable clothing and shoes you can easily drive in.

Is your vehicle ready for a long trip? If you keep it serviced and maintained, it's ready to go. If it needs service, have it done before starting out. Of course, you'll find experienced and able service experts in GM dealerships all across North America. They'll be ready and willing to help if you need it.

Here are some things you can check before a trip:

- *Windshield Washer Fluid:* Is the reservoir full? Are all windows clean inside and outside?
- *Wiper Blades:* Are they in good shape?
- *Fuel, Engine Oil, Other Fluids:* Have you checked all levels?
- *Lamps:* Are they all working? Are the lenses clean?
- *Tires:* They are vitally important to a safe, trouble-free trip. Is the tread good enough for long-distance driving? Are the tires all inflated to the recommended pressure?
- *Weather Forecasts:* What's the weather outlook along your route? Should you delay your trip a short time to avoid a major storm system?
- *Maps:* Do you have up-to-date maps?

Highway Hypnosis

Is there actually such a condition as “highway hypnosis”? Or is it just plain falling asleep at the wheel? Call it highway hypnosis, lack of awareness, or whatever.

There is something about an easy stretch of road with the same scenery, along with the hum of the tires on the road, the drone of the engine, and the rush of the wind against the vehicle that can make you sleepy. Don't let it happen to you! If it does, your vehicle can leave the road in *less than a second*, and you could crash and be injured.

What can you do about highway hypnosis? First, be aware that it can happen.

Then here are some tips:

- Make sure your vehicle is well ventilated, with a comfortably cool interior.
- Keep your eyes moving. Scan the road ahead and to the sides. Check your rearview mirrors and your instruments frequently.
- If you get sleepy, pull off the road into a rest, service or parking area and take a nap, get some exercise, or both. For safety, treat drowsiness on the highway as an emergency.

Hill and Mountain Roads



Driving on steep hills or mountains is different from driving in flat or rolling terrain.

If you drive regularly in steep country, or if you're planning to visit there, here are some tips that can make your trips safer and more enjoyable.

- Keep your vehicle in good shape. Check all fluid levels and also the brakes, tires, cooling system and transaxle. These parts can work hard on mountain roads.
- Know how to go down hills. The most important thing to know is this: let your engine do some of the slowing down. Shift to a lower gear when you go down a steep or long hill.

 **CAUTION:**

If you don't shift down, your brakes could get so hot that they wouldn't work well. You would then have poor braking or even none going down a hill. You could crash. Shift down to let your engine assist your brakes on a steep downhill slope.

 **CAUTION:**

Coasting downhill in NEUTRAL (N) or with the ignition off is dangerous. Your brakes will have to do all the work of slowing down. They could get so hot that they wouldn't work well. You would then have poor braking or even none going down a hill. You could crash. Always have your engine running and your vehicle in gear when you go downhill.

- Know how to go uphill. You may want to shift down to a lower gear. The lower gears help cool your engine and transaxle, and you can climb the hill better.
- Stay in your own lane when driving on two-lane roads in hills or mountains. Don't swing wide or cut across the center of the road. Drive at speeds that let you stay in your own lane.
- As you go over the top of a hill, be alert. There could be something in your lane, like a stalled car or an accident.
- You may see highway signs on mountains that warn of special problems. Examples are long grades, passing or no-passing zones, a falling rocks area or winding roads. Be alert to these and take appropriate action.

Winter Driving



Here are some tips for winter driving:

- Have your vehicle in good shape for winter.
- You may want to put winter emergency supplies in your trunk.



Include an ice scraper, a small brush or broom, a supply of windshield washer fluid, a rag, some winter outer clothing, a small shovel, a flashlight, a red cloth and a couple of reflective warning triangles. And, if you will be driving under severe conditions, include a small bag of sand, a piece of old carpet or a couple of burlap bags to help provide traction. Be sure you properly secure these items in your vehicle.

Driving on Snow or Ice

Most of the time, those places where your tires meet the road probably have good traction.

However, if there is snow or ice between your tires and the road, you can have a very slippery situation. You'll have a lot less traction or "grip" and will need to be very careful.

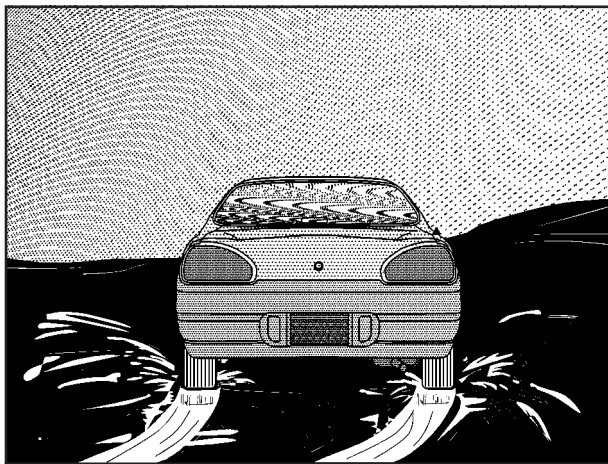

What's the worst time for this? "Wet ice." Very cold snow or ice can be slick and hard to drive on. But wet ice can be even more trouble because it may offer the least traction of all. You can get wet ice when it's about freezing (32°F; 0°C) and freezing rain begins to fall. Try to avoid driving on wet ice until salt and sand crews can get there.

Whatever the condition – smooth ice, packed, blowing or loose snow – drive with caution.

If you have traction control or enhanced traction, keep the system on. It will improve your ability to accelerate when driving on a slippery road. Even though your vehicle has a traction control system you'll want to slow down and adjust your driving to the road conditions. See *Traction Control System (TCS) on page 4-10*.

If you don't have a traction control or enhanced traction system, accelerate gently. Try not to break the fragile traction. If you accelerate too fast, the drive wheels will spin and polish the surface under the tires even more.

Unless you have the anti-lock braking system, you'll want to brake very gently, too. (If you do have anti-lock, see *Braking on page 4-6*. This system improves your vehicle's stability when you make a hard stop on a slippery road.) Whether you have the anti-lock braking system or not, you'll want to begin stopping sooner than you would on dry pavement. Without anti-lock brakes,

if you feel your vehicle begin to slide, let up on the brakes a little. Push the brake pedal down steadily to get the most traction you can.

Remember, unless you have anti-lock, if you brake so hard that your wheels stop rolling, you'll just slide. Brake so your wheels always keep rolling and you can still steer.

- Whatever your braking system, allow greater following distance on any slippery road.
- Watch for slippery spots. The road might be fine until you hit a spot that's covered with ice. On an otherwise clear road, ice patches may appear in shaded areas where the sun can't reach; around clumps of trees, behind buildings or under bridges. Sometimes the surface of a curve or an overpass may remain icy when the surrounding roads are clear. If you see a patch of ice ahead of you, brake before you are on it. Try not to brake while you're actually on the ice, and avoid sudden steering maneuvers.

If You're Caught in a Blizzard

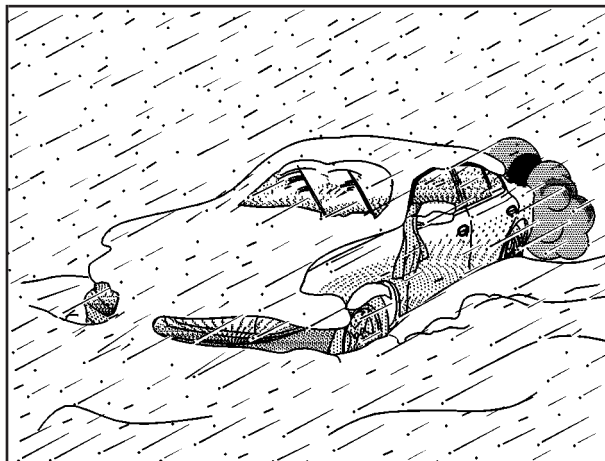

If you are stopped by heavy snow, you could be in a serious situation. You should probably stay with your vehicle unless you know for sure that you are near help and you can hike through the snow. Here are some things to do to summon help and keep yourself and your passengers safe:

- Turn on your hazard flashers.
- Tie a red cloth to your vehicle to alert police that you've been stopped by the snow.

- Put on extra clothing or wrap a blanket around you. If you have no blankets or extra clothing, make body insulators from newspapers, burlap bags, rags, floor mats – anything you can wrap around yourself or tuck under your clothing to keep warm.

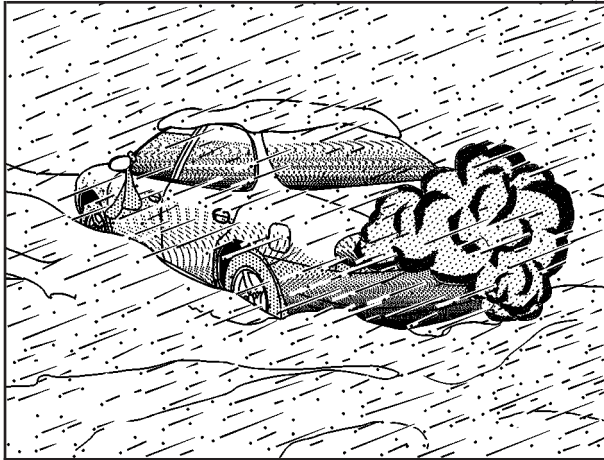

You can run the engine to keep warm, but be careful.

⚠ CAUTION:

Snow can trap exhaust gases under your vehicle. This can cause deadly CO (carbon monoxide) gas to get inside. CO could overcome you and kill you. You can't see it or smell it, so you might not know it is in your vehicle. Clear away snow from around the base of your vehicle, especially any that is blocking your exhaust pipe. And check around again from time to time to be sure snow doesn't collect there.

Open a window just a little on the side of the vehicle that's away from the wind. This will help keep CO out.

Run your engine only as long as you must. This saves fuel. When you run the engine, make it go a little faster than just idle. That is, push the accelerator slightly. This uses less fuel for the heat that you get and it keeps the battery charged. You will need a well-charged battery to restart the vehicle, and possibly for signaling later on with your headlamps. Let the heater run for a while.

Then, shut the engine off and close the window almost all the way to preserve the heat. Start the engine again and repeat this only when you feel really uncomfortable from the cold. But do it as little as possible. Preserve the fuel as long as you can. To help keep warm, you can get out of the vehicle and do some fairly vigorous exercises every half hour or so until help comes.

If You Are Stuck: In Sand, Mud, Ice or Snow

In order to free your vehicle when it is stuck, you will need to spin the wheels, but you don't want to spin your wheels too fast. The method known as "rocking" can help you get out when you're stuck, but you must use caution.

CAUTION:

If you let your tires spin at high speed, they can explode, and you or others could be injured. And, the transaxle or other parts of the vehicle can overheat. That could cause an engine compartment fire or other damage. When you're stuck, spin the wheels as little as possible. Don't spin the wheels above 35 mph (55 km/h) as shown on the speedometer.

Notice: Spinning your wheels can destroy parts of your vehicle as well as the tires. If you spin the wheels too fast while shifting your transaxle back and forth, you can destroy your transaxle. See “Rocking Your Vehicle To Get It Out.”

For information about using tire chains on your vehicle, see *Tire Chains on page 5-77*.

Rocking Your Vehicle To Get It Out

First, turn your steering wheel left and right. That will clear the area around your front wheels. If your vehicle has traction control, you should turn the system off. See *Traction Control System (TCS) on page 4-10*. Then shift back and forth between REVERSE (R) and a forward gear, spinning the wheels as little as possible. Release the accelerator pedal while you shift, and press lightly on the accelerator pedal when the transaxle is in gear. By slowly spinning your wheels in the forward and reverse directions, you will cause a rocking motion that may free your vehicle. If that doesn't get you out after a few tries, you may need to be towed out. If you do need to be towed out, see “Towing Your Vehicle” following.

Towing

Towing Your Vehicle

Consult your dealer or a professional towing service if you need to have your disabled vehicle towed. See *Roadside Assistance Program on page 7-6*.

If you want to tow your vehicle behind another vehicle for recreational purposes (such as behind a motorhome), see “Recreational Vehicle Towing” following.

Recreational Vehicle Towing

Recreational vehicle towing means towing your vehicle behind another vehicle – such as behind a motorhome. The two most common types of recreational vehicle towing are known as “dinghy towing” (towing your vehicle with all four wheels on the ground) and “dolly towing” (towing your vehicle with two wheels on the ground and two wheels up on a device known as a “dolly”).

With the proper preparation and equipment, many vehicles can be towed in these ways. See “Dinghy Towing” and “Dolly Towing,” following.

Here are some important things to consider before you do recreational vehicle towing:

- What's the towing capacity of the towing vehicle? Be sure you read the tow vehicle manufacturer's recommendations.
- How far will you tow? Some vehicles have restrictions on how far and how long they can tow.
- Do you have the proper towing equipment? See your dealer or trailering professional for additional advice and equipment recommendations.
- Is your vehicle ready to be towed? Just as you would prepare your vehicle for a long trip, you'll want to make sure your vehicle is prepared to be towed. See *Before Leaving on a Long Trip* on page 4-25.

Dinghy Towing

Notice: Towing your vehicle with all four wheels on the ground will damage drivetrain components.

Your vehicle was not designed to be towed with all four wheels on the ground. If your vehicle must be towed, you should use a dolly. See "Dolly Towing" following for more information.

Dolly Towing

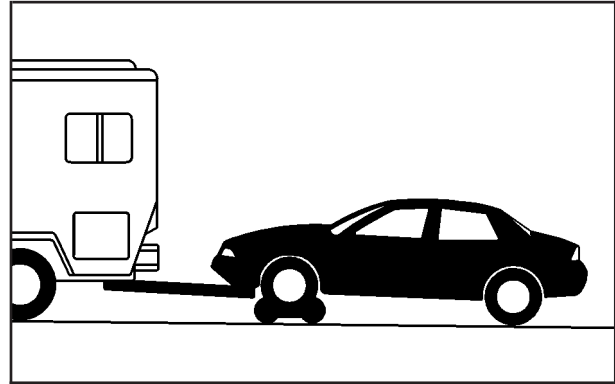

Your vehicle can be towed using a dolly. To tow your vehicle using a dolly, follow these steps:

1. Put the front wheels on the dolly.
2. Put the vehicle in PARK (P).
3. Set the parking brake and then remove the key.
4. Clamp the steering wheel in a straight-ahead position.
5. Release the parking brake.

Loading Your Vehicle

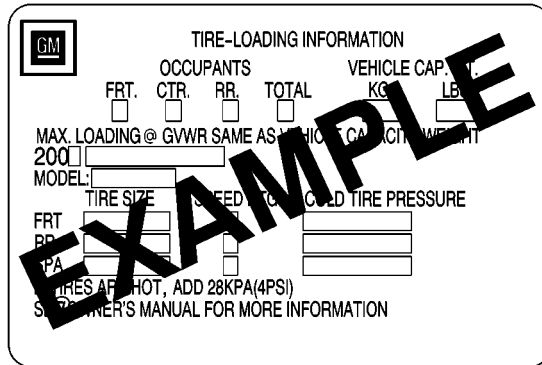

GM

TIRE-LOADING INFORMATION

OCCUPANTS VEHICLE CAP. WT.

FRT.	CTR.	RR.	TOTAL	KG	LB
<input type="checkbox"/>	<input type="checkbox"/>	<input type="checkbox"/>	<input type="checkbox"/>	<input type="checkbox"/>	<input type="checkbox"/>

MAX. LOADING @ GVWR SAME AS VEHICLE CAPACITY WEIGHT
200

MODEL:

TIRE SIZE	SPEED	COOL	TIRE PRESSURE
FRT <input type="text"/>	<input type="text"/>	<input type="text"/>	<input type="text"/>
RR <input type="text"/>	<input type="text"/>	<input type="text"/>	<input type="text"/>
PA <input type="text"/>	<input type="text"/>	<input type="text"/>	<input type="text"/>

TIRES ARE HOT, ADD 28KPA(4PSI)
SEE OWNER'S MANUAL FOR MORE INFORMATION

Two labels on your vehicle show how much weight it may properly carry. The Tire-Loading Information label is on the inside of the trunk lid. The label tells you the proper size, speed rating and recommended inflation pressures for the tires on your vehicle. It also gives you important information about the number of people that can be in your vehicle and the total weight you can carry. This weight is called the vehicle capacity weight and includes the weight of all occupants, cargo and all non-factory installed options.

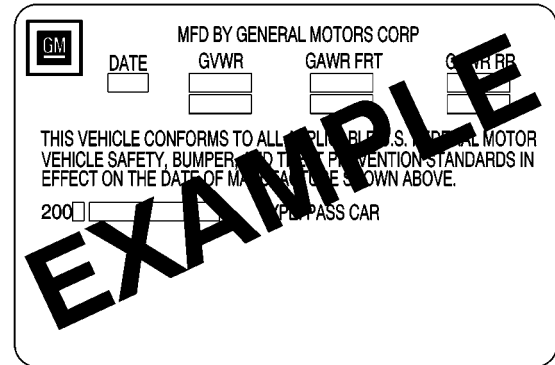

GM

MFD BY GENERAL MOTORS CORP

DATE	GVWR	GAWR FRT	GAWR RR
<input type="text"/>	<input type="text"/>	<input type="text"/>	<input type="text"/>

THIS VEHICLE CONFORMS TO ALL APPLICABLE U.S. FEDERAL MOTOR VEHICLE SAFETY, BUMPER AND TRAFFIC PREVENTION STANDARDS IN EFFECT ON THE DATE OF MANUFACTURE SHOWN ABOVE.

200 TYPE: PASS CAR

The other label is the Certification label, found on the rear edge of the driver's door. It tells you the gross weight capacity of your vehicle, called the Gross Vehicle Weight Rating (GVWR). The GVWR includes the weight of the vehicle, all occupants, fuel and cargo. Never exceed the GVWR for your vehicle or the Gross Axle Weight Rating (GAWR) for either the front or rear axle.

If you do have a heavy load, spread it out. Don't carry more than 167 lbs (75 kg) in your trunk.

 **CAUTION:**

Do not load your vehicle any heavier than the GVWR, or either the maximum front or rear GAWR. If you do, parts on your vehicle can break, and it can change the way your vehicle handles. These could cause you to lose control and crash. Also, overloading can shorten the life of your vehicle.

Notice: Your warranty does not cover parts or components that fail because of overloading.

If you put things inside your vehicle — like suitcases, tools, packages or anything else — they will go as fast as the vehicle goes. If you have to stop or turn quickly, or if there is a crash, they'll keep going.

 **CAUTION:**

Things you put inside your vehicle can strike and injure people in a sudden stop or turn, or in a crash.

- Put things in the trunk of your vehicle. In a trunk, put them as far forward as you can. Try to spread the weight evenly.
- Never stack heavier things, like suitcases, inside the vehicle so that some of them are above the tops of the seats.
- Don't leave an unsecured child restraint in your vehicle.
- When you carry something inside the vehicle, secure it whenever you can.
- Don't leave a seat folded down unless you need to.

Towing a Trailer

CAUTION:

If you don't use the correct equipment and drive properly, you can lose control when you pull a trailer. For example, if the trailer is too heavy, the brakes may not work well — or even at all. You and your passengers could be seriously injured. You may also damage your vehicle; the resulting repairs would not be covered by your warranty. Pull a trailer only if you have followed all the steps in this section. Ask your dealer for advice and information about towing a trailer with your vehicle.

Your vehicle can tow a trailer if it is equipped with the proper trailer towing equipment. To identify what the vehicle trailering capacity is for your vehicle, you should read the information in “Weight of the Trailer” that appears later in this section. But trailering is different than just driving your vehicle by itself. Trailering means changes in handling, durability and fuel economy. Successful, safe trailering takes correct equipment, and it has to be used properly.

That's the reason for this part. In it are many time-tested, important trailering tips and safety rules. Many of these are important for your safety and that of your passengers. So please read this section carefully before you pull a trailer.

Load-pulling components such as the engine, transaxle, wheel assemblies and tires are forced to work harder against the drag of the added weight. The engine is required to operate at relatively higher speeds and under greater loads, generating extra heat. What's more, the trailer adds considerably to wind resistance, increasing the pulling requirements.

If You Do Decide To Pull A Trailer

If you do, here are some important points:

- There are many different laws, including speed limit restrictions, having to do with trailering. Make sure your rig will be legal, not only where you live but also where you'll be driving. A good source for this information can be state or provincial police.
- Consider using a sway control. You can ask a hitch dealer about sway controls.
- Don't tow a trailer at all during the first 1,000 miles (1 600 km) your new vehicle is driven. Your engine, axle or other parts could be damaged.
- Then, during the first 500 miles (800 km) that you tow a trailer, don't drive over 50 mph (80 km/h) and don't make starts at full throttle. This helps your engine and other parts of your vehicle wear in at the heavier loads.
- Obey speed limit restrictions when towing a trailer. Don't drive faster than the maximum posted speed for trailers, or no more than 55 mph (90 km/h), to save wear on your vehicle's parts.

Three important considerations have to do with weight:

- the weight of the trailer,
- the weight of the trailer tongue
- and the total weight on your vehicle's tires.

Weight of the Trailer

How heavy can a trailer safely be?

It should never weigh more than 1000 lbs (454 kg). But even that can be too heavy.

It depends on how you plan to use your rig. For example, speed, altitude, road grades, outside temperature and how much your vehicle is used to pull a trailer are all important. And, it can also depend on any special equipment that you have on your vehicle.

You can ask your dealer for our trailering information or advice, or you can write us at:

Pontiac-GMC Customer Assistance Center
P.O. Box 33172
Detroit, MI 48232-5172

In Canada, write to:

General Motors of Canada Limited
Customer Communication Centre, 163-005
1908 Colonel Sam Drive
Oshawa, Ontario L1H 8P7

Weight of the Trailer Tongue

The tongue load (A) of any trailer is an important weight to measure because it affects the total or gross weight of your vehicle. The Gross Vehicle Weight (GVW) includes the curb weight of the vehicle, any cargo you may carry in it, and the people who will be riding in the vehicle. And if you tow a trailer, you must add the tongue load to the GVW because your vehicle will be carrying that weight, too. See *Loading Your Vehicle on page 4-35* for more information about your vehicle's maximum load capacity.

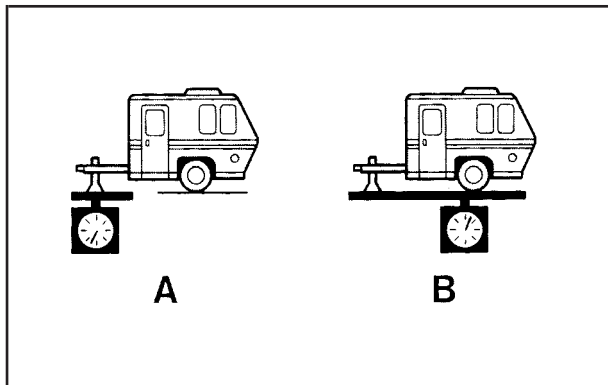

If you're using a weight-carrying hitch or a weight-distributing hitch, the trailer tongue (A) should weigh 10 to 15 percent of the total loaded trailer weight (B).

After you've loaded your trailer, weigh the trailer and then the tongue, separately, to see if the weights are proper. If they aren't, you may be able to get them right simply by moving some items around in the trailer.

Total Weight on Your Vehicle's Tires

Be sure your vehicle's tires are inflated to the upper limit for cold tires. You'll find these numbers on the Tire Loading Information label, found on the inside of the trunk lid, or see *Loading Your Vehicle on page 4-35*. Then be sure you don't go over the GVW limit for your vehicle, including the weight of the trailer tongue.

Hitches

It's important to have the correct hitch equipment. Crosswinds, large trucks going by and rough roads are a few reasons why you'll need the right hitch. Here are some rules to follow:

- The rear bumper on your vehicle is not intended for hitches. Do not attach rental hitches or other bumper-type hitches to it. Use only a frame-mounted hitch that does not attach to the bumper.
- Will you have to make any holes in the body of your vehicle when you install a trailer hitch? If you do, then be sure to seal the holes later when you remove the hitch. If you don't seal them, deadly carbon monoxide (CO) from your exhaust can get into your vehicle. See *Engine Exhaust on page 2-31*. Dirt and water can, too.

Safety Chains

You should always attach chains between your vehicle and your trailer. Cross the safety chains under the tongue of the trailer so that the tongue will not drop to the road if it becomes separated from the hitch. Instructions about safety chains may be provided by the hitch manufacturer or by the trailer manufacturer. Follow the manufacturer's recommendation for attaching safety chains and do not attach them to the bumper. Always leave just enough slack so you can turn with your rig. And, never allow safety chains to drag on the ground.

Trailer Brakes

Because you have anti-lock brakes, do not try to tap into your vehicle's brake system. If you do, both brake systems won't work well, or at all.

Driving with a Trailer

Towing a trailer requires a certain amount of experience. Before setting out for the open road, you'll want to get to know your rig. Acquaint yourself with the feel of handling and braking with the added weight of the trailer. And always keep in mind that the vehicle you are driving is now a good deal longer and not nearly as responsive as your vehicle is by itself.

Before you start, check the trailer hitch and platform (and attachments), safety chains, electrical connector, lamps, tires and mirror adjustment. If the trailer has electric brakes, start your vehicle and trailer moving and then apply the trailer brake controller by hand to be sure the brakes are working. This lets you check your electrical connection at the same time.

During your trip, check occasionally to be sure that the load is secure, and that the lamps and any trailer brakes are still working.

Following Distance

Stay at least twice as far behind the vehicle ahead as you would when driving your vehicle without a trailer. This can help you avoid situations that require heavy braking and sudden turns.

Passing

You'll need more passing distance up ahead when you're towing a trailer. And, because you're a good deal longer, you'll need to go much farther beyond the passed vehicle before you can return to your lane.

Backing Up

Hold the bottom of the steering wheel with one hand. Then, to move the trailer to the left, just move that hand to the left. To move the trailer to the right, move your hand to the right. Always back up slowly and, if possible, have someone guide you.

Making Turns

Notice: Making very sharp turns while trailering could cause the trailer to come in contact with the vehicle. Your vehicle could be damaged.

Avoid making very sharp turns while trailering.

When you're turning with a trailer, make wider turns than normal. Do this so your trailer won't strike soft shoulders, curbs, road signs, trees or other objects. Avoid jerky or sudden maneuvers. Signal well in advance.

Turn Signals When Towing a Trailer

When you tow a trailer, your vehicle may need a different turn signal flasher and/or extra wiring. Check with your dealer. The arrows on your instrument panel will flash whenever you signal a turn or lane change. Properly hooked up, the trailer lamps will also flash, telling other drivers you're about to turn, change lanes or stop.

When towing a trailer, the arrows on your instrument panel will flash for turns even if the bulbs on the trailer are burned out. Thus, you may think drivers behind you are seeing your signal when they are not. It's important to check occasionally to be sure the trailer bulbs are still working.

Your vehicle has bulb warning lights. When you plug a trailer lighting system into your vehicle's lighting system, its bulb warning lights may not let you know if one of your lamps goes out. So, when you have a trailer lighting system plugged in, be sure to check your vehicle and trailer lamps from time to time to be sure they're all working. Once you disconnect the trailer lamps, the bulb warning lights again can tell you if one of your vehicle lamps is out.

Driving On Grades

Reduce speed and shift to a lower gear before you start down a long or steep downgrade. If you don't shift down, you might have to use your brakes so much that they would get hot and no longer work well.

On a long uphill grade, shift down and reduce your speed to around 45 mph (70 km/h) to reduce the possibility of engine and transaxle overheating.

If you have overdrive, you may have to drive in THIRD (3) instead of AUTOMATIC OVERDRIVE (D).

Parking on Hills

CAUTION:

You really should not park your vehicle, with a trailer attached, on a hill. If something goes wrong, your rig could start to move. People can be injured, and both your vehicle and the trailer can be damaged.

But if you ever have to park your rig on a hill, here's how to do it:

1. Apply your regular brakes, but don't shift into PARK (P) yet.
2. Have someone place chocks under the trailer wheels.
3. When the wheel chocks are in place, release the regular brakes until the chocks absorb the load.
4. Reapply the regular brakes. Then apply your parking brake, and then shift to PARK (P).
5. Release the regular brakes.

When You Are Ready to Leave After Parking on a Hill

1. Apply your regular brakes and hold the pedal down while you:
 - start your engine,
 - shift into a gear, and
 - release the parking brake.
2. Let up on the brake pedal.
3. Drive slowly until the trailer is clear of the chocks.
4. Stop and have someone pick up and store the chocks.

Maintenance When Trailer Towing

Your vehicle will need service more often when you're pulling a trailer. See *Part A: Scheduled Maintenance Services on page 6-4* for more information. Things that are especially important in trailer operation are automatic transaxle fluid (don't overfill), engine oil, drive belts, cooling system and brake system. Each of these is covered in this manual, and the Index will help you find them quickly. If you're trailering, it's a good idea to review this information before you start your trip.

Check periodically to see that all hitch nuts and bolts are tight.

Engine Cooling When Trailer Towing

Your cooling system may temporarily overheat during severe operating conditions. See *Engine Overheating on page 5-29*.

Section 5 Service and Appearance Care

Service	5-3	Brakes	5-45
Doing Your Own Service Work	5-3	Battery	5-48
Adding Equipment to the Outside of Your Vehicle	5-4	Jump Starting	5-49
Fuel	5-4	Headlamp Aiming	5-56
Gasoline Octane	5-4	Bulb Replacement	5-59
Gasoline Specifications	5-5	Halogen Bulbs	5-59
California Fuel	5-5	Headlamps and Sidemarkers Lamps	5-60
Additives	5-6	Front Turn Signal, Parking and Fog Lamps	5-62
Fuels in Foreign Countries	5-7	Center High-Mounted Stoplamp (CHMSL)	5-64
Filling Your Tank	5-7	Taillamps, Turn Signal, and Stoplamps	5-64
Filling a Portable Fuel Container	5-10	Back-Up Lamps	5-65
Checking Things Under the Hood	5-10	Replacement Bulbs	5-66
Hood Release	5-11	Windshield Wiper Blade Replacement	5-67
Engine Compartment Overview	5-12	Tires	5-68
Engine Oil	5-16	Inflation -- Tire Pressure	5-69
Supercharger Oil	5-21	Tire Pressure Monitor System	5-70
Engine Air Cleaner/Filter	5-22	Tire Inspection and Rotation	5-71
Automatic Transaxle Fluid	5-24	When It Is Time for New Tires	5-72
Engine Coolant	5-26	Buying New Tires	5-73
Radiator Pressure Cap	5-29	Uniform Tire Quality Grading	5-74
Engine Overheating	5-29	Wheel Alignment and Tire Balance	5-75
Cooling System	5-32	Wheel Replacement	5-75
Power Steering Fluid	5-42	Tire Chains	5-77
Windshield Washer Fluid	5-43		

Section 5 Service and Appearance Care

If a Tire Goes Flat	5-78	Vehicle Identification	5-98
Changing a Flat Tire	5-78	Vehicle Identification Number (VIN)	5-98
Compact Spare Tire	5-89	Service Parts Identification Label	5-98
Appearance Care	5-90	Electrical System	5-99
Cleaning the Inside of Your Vehicle	5-90	Add-On Electrical Equipment	5-99
Care of Safety Belts	5-93	Headlamp Wiring	5-99
Weatherstrips	5-93	Windshield Wiper Fuses	5-99
Cleaning the Outside of Your Vehicle	5-93	Power Windows and Other Power Options	5-99
Sheet Metal Damage	5-95	Fuses and Circuit Breakers	5-99
Finish Damage	5-95	Capacities and Specifications	5-104
Underbody Maintenance	5-96	Capacities and Specifications	5-104
Chemical Paint Spotting	5-96	Normal Maintenance Replacement Parts	5-105
GM Vehicle Care/Appearance Materials	5-96	Normal Maintenance Replacement Parts	5-105

Service

Your dealer knows your vehicle best and wants you to be happy with it. We hope you'll go to your dealer for all your service needs. You'll get genuine GM parts and GM-trained and supported service people.

We hope you'll want to keep your GM vehicle all GM. Genuine GM parts have one of these marks:



ACDelco®



GM Parts®



GM Goodwrench®

Doing Your Own Service Work

If you want to do some of your own service work, you'll want to use the proper service manual. It tells you much more about how to service your vehicle than this manual can. To order the proper service manual, see *Service Publications Ordering Information on page 7-10*.

Your vehicle has an air bag system. Before attempting to do your own service work, see *Servicing Your Air Bag-Equipped Vehicle on page 1-56*.

You should keep a record with all parts receipts and list the mileage and the date of any service work you perform. See *Part E: Maintenance Record on page 6-17*.

CAUTION:

You can be injured and your vehicle could be damaged if you try to do service work on a vehicle without knowing enough about it.

- Be sure you have sufficient knowledge, experience, the proper replacement parts and tools before you attempt any vehicle maintenance task.

CAUTION: (Continued)

CAUTION: (Continued)

- **Be sure to use the proper nuts, bolts and other fasteners. “English” and “metric” fasteners can be easily confused. If you use the wrong fasteners, parts can later break or fall off. You could be hurt.**

Adding Equipment to the Outside of Your Vehicle

Things you might add to the outside of your vehicle can affect the airflow around it. This may cause wind noise and affect windshield washer performance. Check with your dealer before adding equipment to the outside of your vehicle.

Fuel

The 8th digit of your vehicle identification number (VIN) shows the code letter or number that identifies your engine. You will find the VIN at the top left of the instrument panel. See *Vehicle Identification Number (VIN) on page 5-98*.

Gasoline Octane

If your vehicle has the 3800 V6 engine (VIN Code 2), use regular unleaded gasoline with a posted octane of 87 or higher. If the octane is less than 87, you may get a heavy knocking noise when you drive. If it is bad enough, it can damage your engine. A little pinging noise when you accelerate or drive uphill is considered normal. This does not indicate a problem exists or that a higher-octane fuel is necessary.

If your vehicle has the 3800 Supercharged V6 engine (VIN Code 4), use premium unleaded gasoline with a posted octane of 91 or higher for best performance. You may also use middle grade or regular unleaded gasoline rated at 87 octane or higher, but your vehicle's acceleration may be slightly reduced. If the octane is less than 87, you may get a heavy knocking noise when you drive. If it is bad enough, it can damage your engine.

Gasoline Specifications

It is recommended that gasoline meet specifications which were developed by automobile manufacturers around the world and contained in the World-Wide Fuel Charter which is available from the Alliance of Automobile Manufacturers at www.autoalliance.org. Gasoline meeting these specifications could provide improved driveability and emission control system performance compared to other gasoline.



Canada Only

In Canada, look for the “Auto Makers’ Choice” label on the pump.

California Fuel

If your vehicle is certified to meet California Emission Standards (see the underhood emission control label), it is designed to operate on fuels that meet California specifications. If this fuel is not available in states adopting California emissions standards, your vehicle will operate satisfactorily on fuels meeting federal specifications, but emission control system performance may be affected. The malfunction indicator lamp may turn on (see *Malfunction Indicator Lamp on page 3-40*) and your vehicle may fail a smog-check test. If this occurs, return to your authorized GM dealer for diagnosis. If it is determined that the condition is caused by the type of fuel used, repairs may not be covered by your warranty.

Additives

To provide cleaner air, all gasolines in the United States are now required to contain additives that will help prevent engine and fuel system deposits from forming, allowing your emission control system to work properly. You should not have to add anything to your fuel. However, some gasolines contain only the minimum amount of additive required to meet U.S. Environmental Protection Agency regulations. General Motors recommends that you buy gasolines that are advertised to help keep fuel injectors and intake valves clean. If your vehicle experiences problems due to dirty injectors or valves, try a different brand of gasoline.

Gasolines containing oxygenates, such as ethers and ethanol, and reformulated gasolines may be available in your area to contribute to clean air. General Motors recommends that you use these gasolines, particularly if they comply with the specifications described earlier.

Notice: Your vehicle was not designed for fuel that contains methanol. Don't use fuel containing methanol. It can corrode metal parts in your fuel system and also damage the plastic and rubber parts. That damage wouldn't be covered under your warranty.

Some gasolines that are not reformulated for low emissions may contain an octane-enhancing additive called methylcyclopentadienyl manganese tricarbonyl (MMT); ask the attendant where you buy gasoline whether the fuel contains MMT. General Motors does not recommend the use of such gasolines. Fuels containing MMT can reduce the life of spark plugs and the performance of the emission control system may be affected. The malfunction indicator lamp may turn on. If this occurs, return to your authorized GM dealer for service.

Fuels in Foreign Countries

If you plan on driving in another country outside the United States or Canada, the proper fuel may be hard to find. Never use leaded gasoline or any other fuel not recommended in the previous text on fuel. Costly repairs caused by use of improper fuel wouldn't be covered by your warranty.

To check the fuel availability, ask an auto club, or contact a major oil company that does business in the country where you'll be driving.

Filling Your Tank

CAUTION:

Fuel vapor burns violently and a fuel fire can cause bad injuries. To help avoid injuries to you and others, read and follow all the instructions on the pump island. Turn off your engine when you are refueling. Don't smoke if you're near fuel or refueling your vehicle. Keep sparks, flames and smoking materials away from fuel. Don't leave the fuel pump unattended when refueling your vehicle — this is against the law in some places. Keep children away from the fuel pump; never let children pump fuel.

Turn the vehicle off before refueling.



The fuel cap is located behind a hinged door on the driver's side of the vehicle.



While refueling, let the fuel cap hang by the tether below the fuel fill opening.

To remove the fuel cap, turn it slowly to the left (counterclockwise). The fuel cap has a spring in it; if you let go of the cap too soon, it will spring back to the right.

⚠ CAUTION:

If you spill fuel and then something ignites it, you could be badly burned. Fuel can spray out on you if you open the fuel cap too quickly. This spray can happen if your tank is nearly full, and is more likely in hot weather. Open the fuel cap slowly and wait for any “hiss” noise to stop. Then unscrew the cap all the way.

Be careful not to spill fuel. Don't top off or overfill your tank, and wait a few seconds after you have finished pumping before you remove the nozzle. Clean fuel from painted surfaces as soon as possible. See *Cleaning the Outside of Your Vehicle* on page 5-93.

When you put the fuel cap back on, turn it to the right (clockwise) until you hear three "clicks." Make sure you fully install the cap. The diagnostic system can determine if the fuel cap has been left off or improperly installed. This would allow fuel to evaporate into the atmosphere. See *Malfunction Indicator Lamp* on page 3-40.

 **CAUTION:**

If a fire starts while you're refueling, don't remove the nozzle. Shut off the flow of fuel by shutting off the pump or by notifying the station attendant. Leave the area immediately.

Notice: If you need a new fuel cap, be sure to get the right type. Your dealer can get one for you. If you get the wrong type, it may not fit properly. This may cause your malfunction indicator lamp to light and may damage your fuel tank and emissions system. See "Malfunction Indicator Lamp" in the Index.

Filling a Portable Fuel Container

CAUTION:

Never fill a portable fuel container while it is in your vehicle. Static electricity discharge from the container can ignite the gasoline vapor. You can be badly burned and your vehicle damaged if this occurs. To help avoid injury to you and others:

- Dispense gasoline only into approved containers.
- Do not fill a container while it is inside a vehicle, in a vehicle's trunk, pickup bed or on any surface other than the ground.
- Bring the fill nozzle in contact with the inside of the fill opening before operating the nozzle. Contact should be maintained until the filling is complete.
- Don't smoke while pumping gasoline.

Checking Things Under the Hood

CAUTION:

An electric fan under the hood can start up and injure you even when the engine is not running. Keep hands, clothing and tools away from any underhood electric fan.

CAUTION:

Things that burn can get on hot engine parts and start a fire. These include liquids like fuel, oil, coolant, brake fluid, windshield washer and other fluids, and plastic or rubber. You or others could be burned. Be careful not to drop or spill things that will burn onto a hot engine.

Hood Release

To open the hood, do the following:



1. Pull the hood release handle located inside the vehicle near the parking brake pedal.



2. Go to the front of the vehicle and release the secondary hood latch, located near the center front of the engine compartment, by moving it to the right.
3. Lift the hood.

Before closing the hood, be sure all filler caps are on properly. Then pull the hood down and close it firmly.

Engine Compartment Overview

3800 V6 Engine

When you open the hood on a vehicle equipped with the 3800 V6 engine, you'll see:

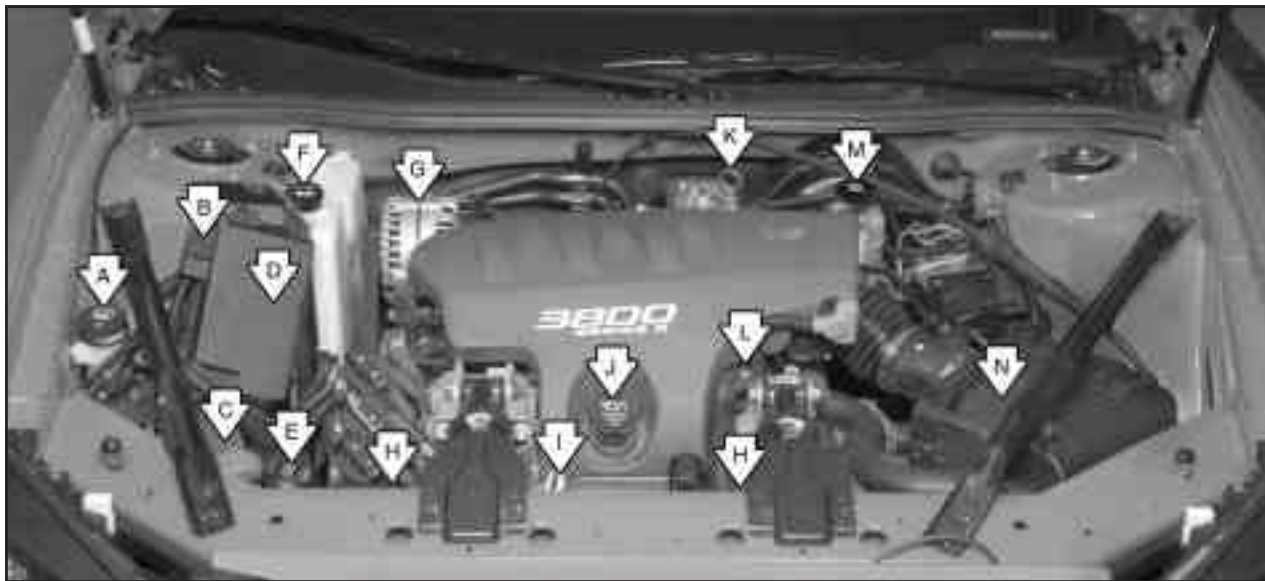

3800 V6 Engine

- A. Windshield Washer Fluid Reservoir. (See *Windshield Washer Fluid* on page 5-43.)
- B. Remote Positive (+) Battery Terminal. (See *Jump Starting* on page 5-49.)
- C. Battery. (See *Battery* on page 5-48).
- D. Underhood Fuse Block. (See *Fuses and Circuit Breakers* on page 5-99.)
- E. Radiator Pressure Cap. (See *Cooling System* on page 5-32).
- F. Engine Coolant Recovery Tank. (See “Checking Coolant” under *Cooling System* on page 5-32.)
- G. Power Steering Fluid Reservoir (low in engine compartment). (See *Power Steering Fluid* on page 5-42.)
- H. Electric Cooling Fan. (See *Cooling System* on page 5-32.)
- I. Engine Oil Dipstick. (See *Engine Oil* on page 5-16.)
- J. Engine Oil Fill Cap. See *Engine Oil* on page 5-16.
- K. Automatic Transaxle Fluid Dipstick. (See *Automatic Transaxle Fluid* on page 5-24.)
- L. Engine Coolant Bleed Valve. (See “How to Add Coolant to the Radiator” under *Cooling System* on page 5-32.)
- M. Brake Master Cylinder. (See “Brake Fluid” under *Brakes* on page 5-45.)
- N. Engine Air Cleaner/Filter. (See *Engine Air Cleaner/Filter* on page 5-22.)

3800 V6 Supercharged Engine

When you open the hood on a vehicle equipped with the 3800 V6 Supercharged engine, you'll see:

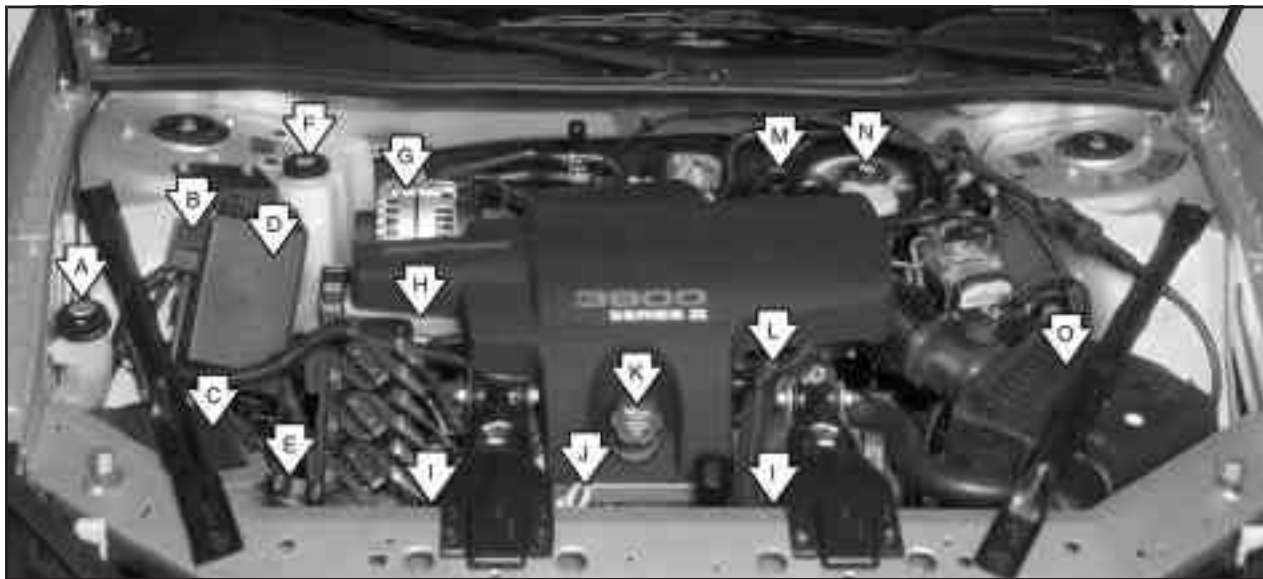

3800 V6 Supercharged Engine

- A. Windshield Washer Fluid Reservoir. (See *Windshield Washer Fluid* on page 5-43.)
- B. Remote Positive (+) Battery Terminal. (See *Jump Starting* on page 5-49.)
- C. Battery. (See *Battery* on page 5-48.)
- D. Underhood Fuse Block. (See *Fuses and Circuit Breakers* on page 5-99.)
- E. Radiator Pressure Cap. (See *Cooling System* on page 5-32.)
- F. Engine Coolant Recovery Tank. (See “Checking Coolant” under *Cooling System* on page 5-32.)
- G. Power Steering Fluid Reservoir (low in engine compartment). (See *Power Steering Fluid* on page 5-42.)
- H. Supercharger Oil Fill Location. (See *Supercharger Oil* on page 5-21.)
- I. Electric Cooling Fan. (See *Cooling System* on page 5-32.)
- J. Engine Oil Dipstick. (See *Engine Oil* on page 5-16.)
- K. Engine Oil Fill Cap. (See *Engine Oil* on page 5-16.)
- L. Engine Coolant Bleed Valve. (See “How to Add Coolant to the Radiator” under *Cooling System* on page 5-32.)
- M. Automatic Transaxle Fluid Dipstick. (See *Automatic Transaxle Fluid* on page 5-24.)
- N. Brake Master Cylinder. (See “Brake Fluid” under *Brakes* on page 5-45.)
- O. Engine Air Cleaner/Filter. (See *Engine Air Cleaner/Filter* on page 5-22.)

Engine Oil



If this symbol, along with the LOW OIL LEVEL message appears on the Driver Information Center (DIC), it means you need to check your engine oil level right away.

For more information, see “LOW OIL LEVEL” under *DIC Warnings and Messages on page 3-65*.

You should check your engine oil level regularly; this is an added reminder.

Checking Engine Oil

It's a good idea to check your engine oil every time you get fuel. In order to get an accurate reading, the oil must be warm and the vehicle must be on level ground.

The engine oil dipstick handle is a yellow loop. See *Engine Compartment Overview on page 5-12* for the location of the engine oil dipstick.

Turn off the engine and give the oil several minutes to drain back into the oil pan. If you don't, the oil dipstick might not show the actual level.

Pull out the dipstick and clean it with a paper towel or cloth, then push it back in all the way. Remove it again, keeping the tip down, and check the level.



When to Add Engine Oil

If the oil is at or below the cross-hatched area at the tip of the dipstick, then you'll need to add at least one quart of oil. But you must use the right kind. This section explains what kind of oil to use. For engine oil crankcase capacity, see *Capacities and Specifications on page 5-104*.

Notice: Don't add too much oil. If your engine has so much oil that the oil level gets above the cross-hatched area that shows the proper operating range, your engine could be damaged.



See *Engine Compartment Overview on page 5-12* for the location of the engine oil fill cap.

Be sure to add enough oil to put the level somewhere in the proper operating range in the cross-hatched area. Push the dipstick all the way back in when you're through.

What Kind of Engine Oil to Use

Look for two things:

- GM6094M

Your vehicle's engine requires oil meeting GM Standard GM6094M. You should look for and use only an oil that meets GM Standard GM6094M.

- SAE 5W-30

As shown in the viscosity chart, SAE 5W-30 is best for your vehicle. However, if it's going to be 0°F (-18°C) or above and SAE 5W-30 is not available, you may use SAE 10W-30.

These numbers on an oil container show its viscosity, or thickness. Do not use other viscosity oils such as SAE 20W-50.

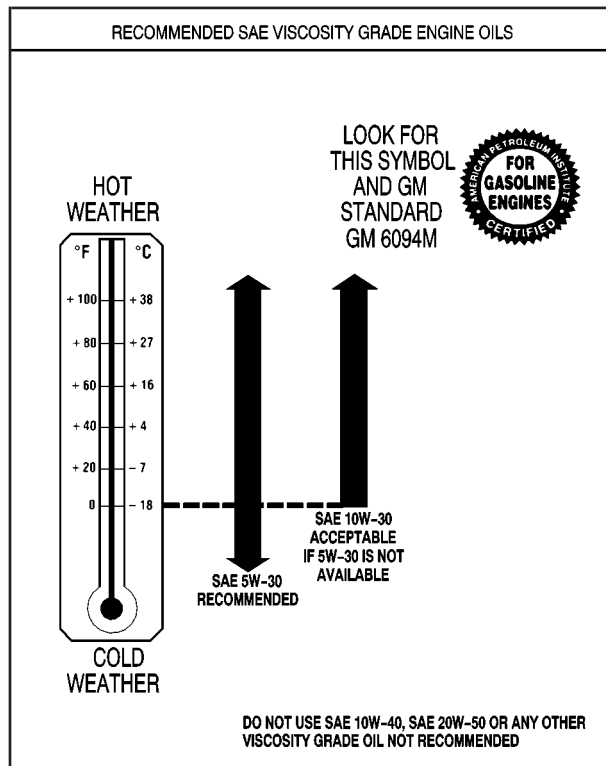



Oils meeting these requirements should also have the starburst symbol on the container. This symbol indicates that the oil has been certified by the American Petroleum Institute (API).

You should look for this information on the oil container, and use *only* those oils that are identified as meeting GM Standard GM6094M and have the starburst symbol on the front of the oil container.

Notice: Use only engine oil identified as meeting GM Standard GM6094M and showing the American Petroleum Institute Certified For Gasoline Engines starburst symbol. Failure to use the recommended oil can result in engine damage not covered by your warranty.

GM Goodwrench® oil meets all the requirements for your vehicle.

If you are in an area of extreme cold, where the temperature falls below -20°F (-29°C), it is recommended that you use either an SAE 5W-30 synthetic oil or an SAE 0W-30 oil. Both will provide easier cold starting and better protection for your engine at extremely low temperatures.

Engine Oil Additives

Don't add anything to your oil. The recommended oils with the starburst symbol that meet GM Standard GM6094M are all you will need for good performance and engine protection.

When to Change Engine Oil (GM Oil Life System)

Your vehicle has a computer system that lets you know when to change the engine oil and filter. This is based on engine revolutions and engine temperature, and not on mileage. Based on driving conditions, the mileage at which an oil change will be indicated can vary considerably. For the oil life system to work properly, you must reset the system every time the oil is changed.

When the system has calculated that oil life has been diminished, it will indicate that an oil change is necessary. A CHANGE OIL SOON light will come on. Change your oil as soon as possible within the next two times you stop for fuel. It is possible that, if you are driving under the best conditions, the oil life system may not indicate that an oil change is necessary for over a year. However, your engine oil and filter must be changed at least once a year and at this time the system must be reset. Your dealer has GM-trained service people who will perform this work using genuine GM parts and reset the system. It is also important to check your oil regularly and keep it at the proper level.

If the system is ever reset accidentally, you must change your oil at 3,000 miles (5 000 km) since your last oil change. Remember to reset the oil life system whenever the oil is changed.

How to Reset the GM Oil Life System

The GM Oil Life System calculates when to change your engine oil and filter based on vehicle use. Anytime your oil is changed, reset the system so it can calculate when the next oil change is required. If a situation occurs where you change your oil prior to a CHANGE OIL SOON message appearing on the DIC, reset the system.

To reset the GM Oil Life System, after the oil has been changed, use the following procedure:

1. Press the options button on the DIC until ENGINE OIL MONITOR appears on the DIC screen.
2. Press the set/reset button to reset the system.

The next screen indicates that the engine oil monitor system has been reset.

If the vehicle is equipped with the trip computer DIC, when the gage button is pressed and the OIL LIFE REMAINING mode appears, it should read 100 percent OIL LIFE REMAINING.

What to Do with Used Oil

Used engine oil contains certain elements that may be unhealthy for your skin and could even cause cancer. Don't let used oil stay on your skin for very long. Clean your skin and nails with soap and water, or a good hand cleaner. Wash or properly dispose of clothing or rags containing used engine oil. See the manufacturer's warnings about the use and disposal of oil products.

Used oil can be a threat to the environment. If you change your own oil, be sure to drain all the oil from the filter before disposal. Never dispose of oil by putting it in the trash, pouring it on the ground, into sewers, or into streams or bodies of water. Instead, recycle it by taking it to a place that collects used oil. If you have a problem properly disposing of your used oil, ask your dealer, a service station or a local recycling center for help.

Supercharger Oil



Unless you are technically qualified and have the proper tools, you should let your dealer or a qualified service center perform this maintenance.

See *Engine Compartment Overview* on page 5-12 for the Supercharger Oil fill location.

When to Check

Check oil level every 30,000 miles (50 000 km) or every 36 months, whichever occurs first.

What Kind of Oil to Use

Use only the recommended supercharger oil. See *Part D: Recommended Fluids and Lubricants* on page 6-16.

How to Check and Add Oil

Park the vehicle on a level surface. Check oil only when the engine is cold. Allow the engine to cool two to three hours after running.

CAUTION:

If you remove the supercharger oil fill plug while the engine is hot, pressure may cause hot oil to blow out of the oil fill hole. You may be burned. Do not remove the plug until the engine cools.

1. Clean the area around the oil fill plug before removing it.
2. Remove the oil fill plug.
3. The oil level is correct when it just reaches the bottom of the threads of the inspection hole.
4. Replace the oil plug with the O-ring in place. Tighten to 88 lb-in (10 N•m).

Engine Air Cleaner/Filter

The engine air cleaner/filter is located in the engine compartment on the driver's side of the vehicle. See *Engine Compartment Overview on page 5-12* for more information on location.

When to Inspect the Engine Air Cleaner/Filter

Inspect the air cleaner/filter every 15,000 miles (25,000 km) and replace every 30,000 miles (50,000 km). If you are driving in dusty/dirty conditions, inspect the filter at each engine oil change.

How to Inspect the Engine Air Cleaner/Filter

To inspect the air cleaner/filter, remove the filter from the vehicle and lightly shake the filter to release loose dust and dirt. If the filter remains “caked” with dirt, a new filter is required.

To inspect or replace the engine air cleaner/filter do the following:



1. Loosen the two clips on the top of the engine air cleaner/filter housing and lift the filter cover tabs out of the housing.
2. Push the filter cover housing toward the engine.
3. Pull out the filter.
4. Check or install a new engine air cleaner/filter. See *Normal Maintenance Replacement Parts* on page 5-105.

5. To reinstall the cover, position the tabs through the slots on the housing. A notch on the sides of the filter cover will indicate the correct engagement. Reinstall the two clips on the top of the housing when you are finished.

⚠ CAUTION:

Operating the engine with the air cleaner/filter off can cause you or others to be burned. The air cleaner not only cleans the air, it helps to stop flame if the engine backfires. If it isn't there and the engine backfires, you could be burned. Don't drive with it off, and be careful working on the engine with the air cleaner/filter off.

Notice: If the air cleaner/filter is off, a backfire can cause a damaging engine fire. And, dirt can easily get into your engine, which will damage it. Always have the air cleaner/filter in place when you're driving.

Automatic Transaxle Fluid

When to Check and Change

A good time to check your automatic transaxle fluid level is when the engine oil is changed.

Change both the fluid and filter every 50,000 miles (83 000 km) if the vehicle is mainly driven under one or more of these conditions:

- In heavy city traffic where the outside temperature regularly reaches 90°F (32°C) or higher.
- In hilly or mountainous terrain.
- When doing frequent trailer towing.
- Uses such as found in taxi, police or delivery service.

If you do not use your vehicle under any of these conditions, change the fluid and filter at 100,000 miles (166 000 km).

See *Part A: Scheduled Maintenance Services on page 6-4*.

How to Check

Because this operation can be a little difficult, you may choose to have this done at the dealership service department.

If you do it yourself, be sure to follow all the instructions here, or you could get a false reading on the dipstick.

Notice: Too much or too little fluid can damage your transaxle. Too much can mean that some of the fluid could come out and fall on hot engine or exhaust system parts, starting a fire. Too little fluid could cause the transaxle to overheat. Be sure to get an accurate reading if you check your transaxle fluid.

Wait at least 30 minutes before checking the transaxle fluid level if you have been driving:

- When outside temperatures are above 90°F (32°C).
- At high speed for quite a while.
- In heavy traffic – especially in hot weather.
- While pulling a trailer.

To get the right reading, the fluid should be at normal operating temperature, which is 180°F to 200°F (82°C to 93°C).

Get the vehicle warmed up by driving about 15 miles (24 km) when outside temperatures are above 50°F (10°C). If it's colder than 50°F (10°C), you may have to drive longer.

Checking the Fluid Level

Prepare your vehicle as follows:

- Park your vehicle on a level place. Keep the engine running.
- With the parking brake applied, place the shift lever in PARK (P).
- With your foot on the brake pedal, move the shift lever through each gear range, pausing for about three seconds in each range. Then, position the shift lever in PARK (P).
- Let the engine run at idle for three to five minutes.

Then, without shutting off the engine, follow these steps:



The transaxle fluid dipstick handle is the red loop located near the rear of the engine. See *Engine Compartment Overview* on page 5-12 for more information on location.

1. Pull out the dipstick and wipe it with a clean rag or paper towel.
2. Push it back in all the way, wait three seconds and then pull it back out again.



3. Check both sides of the dipstick, and read the lower level. The fluid level must be in the cross-hatched area.
4. If the fluid level is in the acceptable range, push the dipstick back in all the way.

How to Add Fluid

Refer to the Maintenance Schedule to determine what kind of transaxle fluid to use. See *Part D: Recommended Fluids and Lubricants on page 6-16*.

If the fluid level is low, add only enough of the proper fluid to bring the level into the cross-hatched area on the dipstick.

1. Pull out the dipstick.
2. Using a long-neck funnel, add enough fluid at the dipstick hole to bring it to the proper level.
It doesn't take much fluid, generally less than one pint (0.5 L). Don't overfill.

Notice: We recommend you use only fluid labeled DEXRON®-III, because fluid with that label is made especially for your automatic transaxle. Damage caused by fluid other than DEXRON®-III is not covered by your new vehicle warranty.

3. After adding fluid, recheck the fluid level as described under "How to Check" listed previously in this section.
4. When the correct fluid level is obtained, push the dipstick back in all the way.

Engine Coolant

The cooling system in your vehicle is filled with DEX-COOL® engine coolant. This coolant is designed to remain in your vehicle for 5 years or 150,000 miles (240 000 km), whichever occurs first, if you add only DEX-COOL® extended life coolant.

The following explains your cooling system and how to add coolant when it is low. If you have a problem with engine overheating or if you need to add coolant to your radiator, see *Engine Overheating on page 5-29*.

A 50/50 mixture of clean, drinkable water and DEX-COOL[®] engine coolant will:

- Give freezing protection down to -34°F (-37°C).
- Give boiling protection up to 265°F (129°C).
- Protect against rust and corrosion.
- Help keep the proper engine temperature.
- Let the warning lights and gages work as they should.

Notice: When adding coolant, it is important that you use only DEX-COOL[®] (silicate-free) coolant. If coolant other than DEX-COOL[®] is added to the system, premature engine, heater core or radiator corrosion may result. In addition, the engine coolant will require change sooner – at 30,000 miles (50,000 km) or 24 months, whichever occurs first. Damage caused by the use of coolant other than DEX-COOL[®] is not covered by your new vehicle warranty.

What to Use

Use a mixture of one-half clean, drinkable water and one-half DEX-COOL[®] engine coolant which won't damage aluminum parts. If you use this coolant mixture, you don't need to add anything else.

CAUTION:

Adding only plain water to your cooling system can be dangerous. Plain water, or some other liquid such as alcohol, can boil before the proper coolant mixture will. Your vehicle's coolant warning system is set for the proper coolant mixture. With plain water or the wrong mixture, your engine could get too hot but you wouldn't get the overheat warning. Your engine could catch fire and you or others could be burned. Use a 50/50 mixture of clean, drinkable water and DEX-COOL[®] coolant.

Notice: If you use an improper coolant mixture, your engine could overheat and be badly damaged. The repair cost wouldn't be covered by your warranty. Too much water in the mixture can freeze and crack the engine, radiator, heater core and other parts.

If you have to add coolant more than four times a year, have your dealer check your cooling system.

Notice: If you use the proper coolant, you don't have to add extra inhibitors or additives which claim to improve the system. These can be harmful.

Checking Coolant

The coolant recovery tank is located in the engine compartment toward the rear of the engine on the passenger's side of the vehicle. See *Engine Compartment Overview on page 5-12* for more information on location.

The vehicle must be on a level surface when checking the coolant level.



When your engine is cold, the coolant level should be at the COLD mark or a little higher.

When your engine is warm, the level should be up to the HOT mark or a little higher.

Adding Coolant

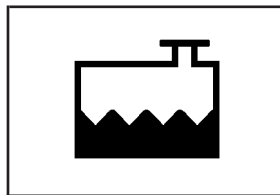

This symbol, along with the LOW COOLANT LEVEL warning message will appear in the Driver Information Center (DIC) when coolant needs to be added to the coolant recovery tank.

See *DIC Controls and Displays on page 3-45* for more information.

If you need more coolant, add the proper DEX-COOL[®] coolant mixture at the coolant recovery tank, but be careful not to spill it.

If the coolant recovery tank is completely empty, add coolant to the radiator. See *Engine Overheating on page 5-29*.

 **CAUTION:**

Turning the radiator pressure cap when the engine and radiator are hot can allow steam and scalding liquids to blow out and burn you badly. With the coolant recovery tank, you will almost never have to add coolant at the radiator. Never turn the radiator pressure cap -- even a little -- when the engine and radiator are hot.

 **CAUTION:**

You can be burned if you spill coolant on hot engine parts. Coolant contains ethylene glycol, and it will burn if the engine parts are hot enough. Don't spill coolant on a hot engine.

Occasionally check the coolant level in the radiator. For information on how to add coolant to the radiator, see *Cooling System on page 5-32*.

Radiator Pressure Cap

Notice: Your radiator cap is a pressure-type cap and must be tightly installed to prevent coolant loss and possible engine damage from overheating. Be sure the arrows on the cap line up with the overflow tube on the radiator filler neck.

The radiator pressure cap is located in the front of the engine compartment on the passenger's side, near the diagonal cross brace. See *Engine Compartment Overview on page 5-12* for more information on location.

Engine Overheating

You will find a coolant temperature gage and a warning light concerning an overheated engine condition on the instrument panel cluster. See *Engine Coolant Temperature Gage on page 3-39* and *Engine Coolant Temperature Warning Light on page 3-39*.

Overheated Engine Protection Operating Mode

This emergency operating mode allows your vehicle to be driven to a safe place in an emergency situation. If an overheated engine condition exists, an overheat protection mode which alternates firing groups of cylinders helps prevent engine damage. In this mode, you will notice a significant loss in power and engine performance. The engine coolant temperature gage will indicate an overheat condition exists. Driving extended miles (km) and/or towing a trailer in the overheat protection mode should be avoided.

Notice: After driving in the overheated engine protection operating mode, to avoid engine damage, allow the engine to cool before attempting any repair. The engine oil will be severely degraded. Repair the cause of coolant loss, change the oil and reset the oil life system. See “Engine Oil” in the Index.

If Steam Is Coming From Your Engine



CAUTION:

Steam from an overheated engine can burn you badly, even if you just open the hood. Stay away from the engine if you see or hear steam coming from it. Just turn it off and get everyone away from the vehicle until it cools

CAUTION: (Continued)

CAUTION: (Continued)

down. Wait until there is no sign of steam or coolant before you open the hood.

If you keep driving when your engine is overheated, the liquids in it can catch fire. You or others could be badly burned. Stop your engine if it overheats, and get out of the vehicle until the engine is cool.

See “Overheated Engine Protection Operating Mode” in the Index for information on driving to a safe place in an emergency.

Notice: If your engine catches fire because you keep driving with no coolant, your vehicle can be badly damaged. The costly repairs would not be covered by your warranty. See “Overheated Engine Protection Operating Mode” in the Index for information on driving to a safe place in an emergency.

If No Steam is Coming From Your Engine

An overheat warning can indicate a serious problem.

If you get an engine overheat warning, but see or hear no steam, the problem may not be too serious. Sometimes the engine can get a little too hot when you:

- Climb a long hill on a hot day.
- Stop after high-speed driving.
- Idle for long periods in traffic.
- Tow a trailer.

If you get the overheat warning with no sign of steam, try this for a minute or so:

1. In heavy traffic let the engine idle in NEUTRAL (N) while stopped. If it's safe to do so, pull off the road, shift to PARK (P) or NEUTRAL (N) and let the engine idle.
2. Turn on your heater to full hot at the highest fan speed and open the windows as necessary.

If you no longer have the overheat warning, you can drive. Just to be safe, drive slower for about 10 minutes. If the warning doesn't come back on, you can drive normally.

If the warning continues, and you have not stopped, pull over, stop, and park your vehicle right away.

If there's still no sign of steam, you can idle the engine for three minutes while you're parked. If you still have the warning, turn off the engine and get everyone out of the vehicle until it cools down. Also, see "Overheated Engine Protection Operating Mode" listed previously in this section.

You may decide not to lift the hood but to get service help right away.

Cooling System

When you decide it's safe to lift the hood, here's what you'll see:

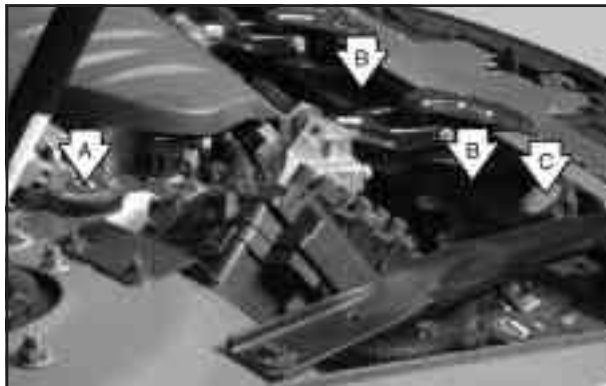

3800 V6 Engine

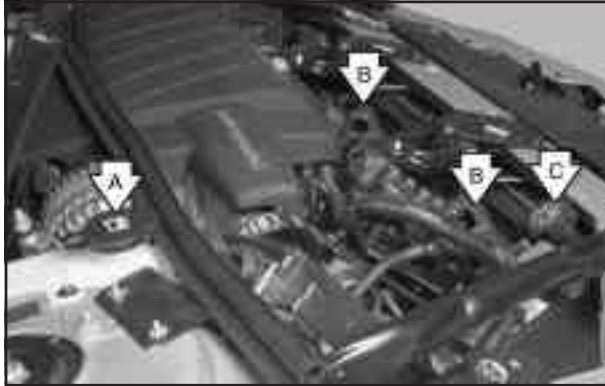

3800 V6 Supercharged

- A. Coolant Recovery Tank
- B. Electric Engine Cooling Fan
- C. Radiator Pressure Cap

CAUTION:

An electric engine cooling fan under the hood can start up even when the engine is not running and can injure you. Keep hands, clothing and tools away from any underhood electric fan.

If the coolant inside the coolant recovery tank is boiling, don't do anything else until it cools down. The vehicle should be parked on a level surface.



When the engine is cold, the coolant level should be at or above the COLD mark on the coolant recovery tank.

If it isn't, you may have a leak at the pressure cap or in the radiator hoses, heater hoses, radiator, water pump or somewhere else in the cooling system.

CAUTION:

Heater and radiator hoses, and other engine parts, can be very hot. Don't touch them. If you do, you can be burned.

CAUTION: (Continued)

CAUTION: (Continued)

Don't run the engine if there is a leak. If you run the engine, it could lose all coolant. That could cause an engine fire, and you could be burned. Get any leak fixed before you drive the vehicle.

If there seems to be no leak, with the engine on, check to see if the electric engine cooling fans are running. If the engine is overheating, both fans should be running. If they aren't, your vehicle needs service.

Notice: Engine damage from running your engine without coolant isn't covered by your warranty. See "Overheated Engine Protection Operating Mode" in the Index for information on driving to a safe place in an emergency.

Notice: When adding coolant, it is important that you use only DEX-COOL[®] (silicate-free) coolant. If coolant other than DEX-COOL[®] is added to the system, premature engine, heater core or radiator corrosion may result. In addition, the engine coolant will require change sooner — at 30,000 miles (50 000 km) or 24 months, whichever occurs first. Damage caused by the use of coolant other than DEX-COOL[®] is not covered by your new vehicle warranty.

How to Add Coolant to the Coolant Recovery Tank

CAUTION:

Adding only plain water to your cooling system can be dangerous. Plain water, or some other liquid such as alcohol, can boil before the proper coolant mixture will. Your vehicle's coolant warning system is set for the proper coolant mixture. With plain water or the wrong mixture, your engine could get too hot but you wouldn't get the overheat warning. Your engine could catch fire and you or others could be burned. Use a 50/50 mixture of clean, drinkable water and DEX-COOL[®] coolant.

If you haven't found a problem yet, but the coolant level isn't at the COLD mark, add a 50/50 mixture of clean, drinkable water and DEX-COOL[®] engine coolant at the coolant recovery tank. See *Engine Coolant* on page 5-26 for more information.



Notice: In cold weather, water can freeze and crack the engine, radiator, heater core and other parts. Use the recommended coolant and the proper coolant mixture.

CAUTION:

You can be burned if you spill coolant on hot engine parts. Coolant contains ethylene glycol and it will burn if the engine parts are hot enough. Don't spill coolant on a hot engine.

When the coolant in the coolant recovery tank is at the COLD mark, start your vehicle.

If the overheat warning continues, there's one more thing you can try. You can add the proper coolant mixture directly to the radiator, but be sure the cooling system is cool before you do it.

⚠ CAUTION:

Steam and scalding liquids from a hot cooling system can blow out and burn you badly. They are under pressure, and if you turn the radiator pressure cap -- even a little -- they can come out at high speed. Never turn the cap when the cooling system, including the radiator pressure cap, is hot. Wait for the cooling system and radiator pressure cap to cool if you ever have to turn the pressure cap.



How to Add Coolant to the Radiator

Notice: Your engine has a specific radiator fill procedure. Failure to follow this procedure could cause your engine to overheat and be severely damaged.



The radiator pressure cap is located on the passenger's side of the vehicle in the front of the engine compartment, near the battery and the diagonal cross brace. See *Engine Compartment Overview* on page 5-12 for more information on location.

You can remove the radiator pressure cap when the cooling system, including the radiator pressure cap and upper radiator hose, is no longer hot.

1. Turn the pressure cap slowly counterclockwise until it first stops. Don't press down while turning the pressure cap.

If you hear a hiss, wait for that to stop. A hiss means there is still some pressure left.

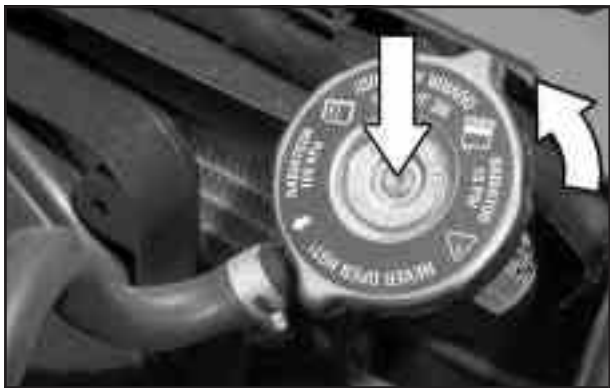

2. Then keep turning the pressure cap, but now push down as you turn it. Remove the pressure cap.

⚠ CAUTION:

You can be burned if you spill coolant on hot engine parts. Coolant contains ethylene glycol and it will burn if the engine parts are hot enough. Don't spill coolant on a hot engine.

3. If the vehicle has the 3800 V6 engine, remove the Series III V6 engine cover shield to access the bleed valve.

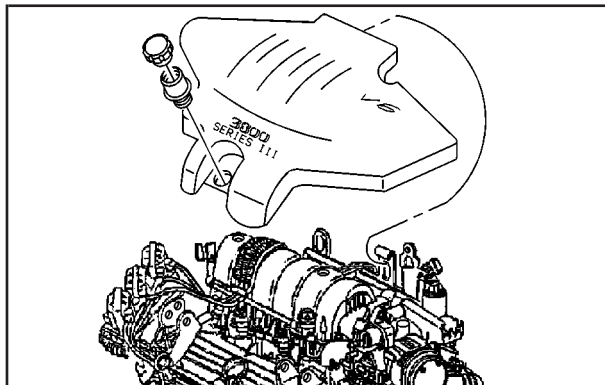

3800 Engine

- 3.1. Clean the area around the engine oil fill tube and cap before removing. Twist the oil fill tube, with cap attached, counterclockwise and remove it.

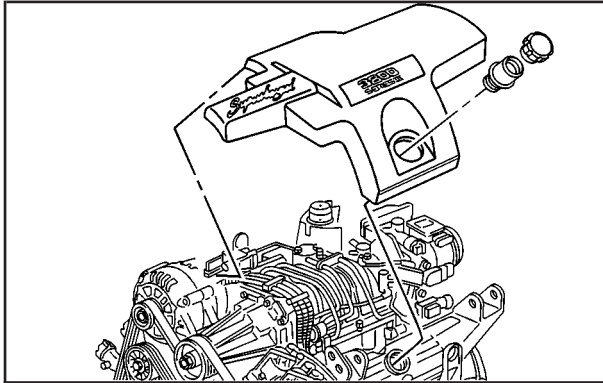

3800 Supercharged Engine

- 3.2. Lift the engine cover shield at the front, slide the catch tab out of the engine bracket and remove the cover shield.
- 3.3. Put the oil fill tube, with cap attached, in the valve cover oil fill hole until you're ready to replace the cover shield.



Thermostat Housing

4. After the engine cools, open the coolant air bleed valve located on the thermostat housing near the heater hose.



5. Fill the radiator with the proper DEX-COOL[®] coolant mixture, up to the base of the filler neck. See *Engine Coolant* on page 5-26 for more information about the proper coolant mixture.

If you see a stream of coolant coming from an air bleed valve, close the valve. Otherwise, close the valve after the radiator is filled.

6. Rinse or wipe any spilled coolant from the engine and the compartment.

7. Replace the 3800 Series III V6 engine cover shield.
 - 7.1. Remove the oil fill tube, with cap attached, from the valve cover.
 - 7.2. Insert the catch tab on the cover shield under the bracket on the engine.
 - 7.3. Place the hole in the cover shield over the hole in the valve cover. Install oil fill tube and cap by twisting clockwise.



8. Then fill the coolant recovery tank to the COLD mark.

9. Put the cap back on the coolant recovery tank, but leave the radiator pressure cap off.



10. Start the engine and let it run until you can feel the upper radiator hose getting hot. Watch out for the engine cooling fans.
11. By this time, the coolant level inside the radiator filler neck may be lower. If the level is lower, add more of the proper DEX-COOL[®] coolant mixture through the filler neck until the level reaches the base of the filler neck.



12. Then replace the radiator pressure cap. At any time during this procedure if coolant begins to flow out of the filler neck, reinstall the pressure cap. Be sure the arrow on the pressure cap lines up like this.
13. Check the coolant in the recovery tank. The level in the coolant recovery tank should be at the HOT mark when the engine is hot or at the COLD mark when the engine is cold.

Power Steering Fluid

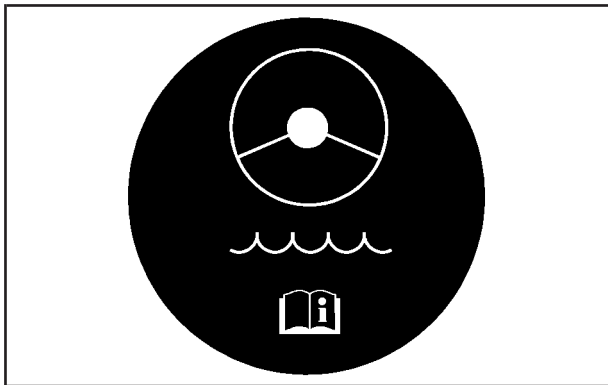

The power steering fluid reservoir is located in the engine compartment next to the engine coolant recovery tank. It sits low in the engine compartment. See *Engine Compartment Overview* on page 5-12.

When to Check Power Steering Fluid

It is not necessary to regularly check power steering fluid unless you suspect there is a leak in the system or you hear an unusual noise. A fluid loss in this system could indicate a problem. Have the system inspected and repaired.

How to Check Power Steering Fluid

Turn the key off, let the engine compartment cool down, wipe the cap and the top of the reservoir clean, then unscrew the cap and wipe the dipstick with a clean rag. Replace the cap and completely tighten it. Then remove the cap again and look at the fluid level on the dipstick.



The fluid level should be between the ADD and HOT marks when the engine is cold

When the engine compartment is hot, the level should be at the HOT mark.

If the fluid is at the ADD mark when the engine is cold or hot, you should add power steering fluid.

What to Use

To determine what kind of fluid to use, see *Part D: Recommended Fluids and Lubricants* on page 6-16. Always use the proper fluid. Failure to use the proper fluid can cause leaks and damage hoses and seals.

Windshield Washer Fluid

When to Add

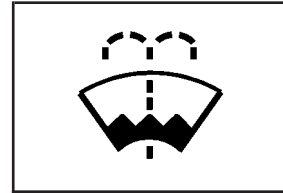

This symbol, along with the LOW WASHER FLUID message will appear in the Driver's Information Center (DIC) when the windshield washer fluid is low.

What to Use

When you need to add windshield washer fluid, be sure to read the manufacturer's instructions before use. If you will be operating your vehicle in an area where the temperature may fall below freezing, use a fluid that has sufficient protection against freezing.

Adding Washer Fluid

The windshield washer fluid reservoir is located in the engine compartment on the passenger's side of the vehicle near the diagonal cross brace. See *Engine Compartment Overview on page 5-12* for reservoir location.



Open the cap with the washer symbol on it. Add washer fluid until the tank is full.

Notice:

- **When using concentrated washer fluid, follow the manufacturer's instructions for adding water.**
- **Don't mix water with ready-to-use washer fluid. Water can cause the solution to freeze and damage your washer fluid tank and other parts of the washer system. Also, water doesn't clean as well as washer fluid.**
- **Fill your washer fluid tank only three-quarters full when it's very cold. This allows for expansion if freezing occurs, which could damage the tank if it is completely full.**
- **Don't use engine coolant (antifreeze) in your windshield washer. It can damage your washer system and paint.**

Brakes

Brake Fluid

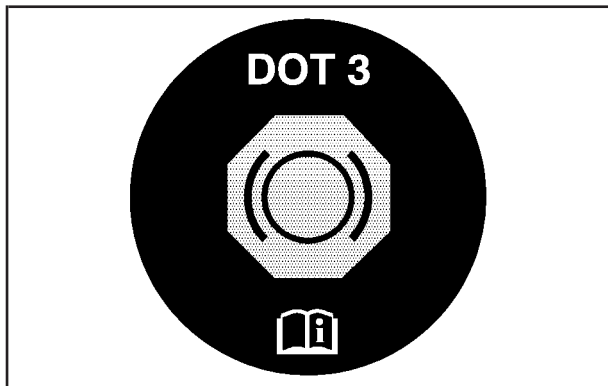

Your brake master cylinder reservoir is filled with DOT-3 brake fluid. See *Engine Compartment Overview on page 5-12* for the location of the reservoir.

There are only two reasons why the brake fluid level in the reservoir might go down. The first is that the brake fluid goes down to an acceptable level during normal brake lining wear. When new linings are put in,

the fluid level goes back up. The other reason is that fluid is leaking out of the brake system. If it is, you should have your brake system fixed, since a leak means that sooner or later your brakes won't work well, or won't work at all.

So, it isn't a good idea to "top off" your brake fluid. Adding brake fluid won't correct a leak. If you add fluid when your linings are worn, then you'll have too much fluid when you get new brake linings. You should add (or remove) brake fluid, as necessary, only when work is done on the brake hydraulic system.

CAUTION:

If you have too much brake fluid, it can spill on the engine. The fluid will burn if the engine is hot enough. You or others could be burned, and your vehicle could be damaged. Add brake fluid only when work is done on the brake hydraulic system.

BRAKE

United States



Canada

When your brake fluid falls to a low level, your brake warning light will come on. See *Brake System Warning Light* on page 3-36.

What to Add

When you do need brake fluid, use only DOT-3 brake fluid. Use new brake fluid from a sealed container only. See *Part D: Recommended Fluids and Lubricants* on page 6-16.

Always clean the brake fluid reservoir cap and the area around the cap before removing it. This will help keep dirt from entering the reservoir.

⚠ CAUTION:

With the wrong kind of fluid in your brake system, your brakes may not work well, or they may not even work at all. This could cause a crash. Always use the proper brake fluid.

Notice:

- **Using the wrong fluid can badly damage brake system parts. For example, just a few drops of mineral-based oil, such as engine oil, in your brake system can damage brake system parts so badly that they'll have to be replaced. Don't let someone put in the wrong kind of fluid.**
- **If you spill brake fluid on your vehicle's painted surfaces, the paint finish can be damaged. Be careful not to spill brake fluid on your vehicle. If you do, wash it off immediately. See "Appearance Care" in the Index.**

Brake Wear

Your vehicle has four-wheel disc brakes.

Disc brake pads have built-in wear indicators that make a high-pitched warning sound when the brake pads are worn and new pads are needed. The sound may come and go or be heard all the time your vehicle is moving (except when you are pushing on the brake pedal firmly).

CAUTION:

The brake wear warning sound means that soon your brakes won't work well. That could lead to an accident. When you hear the brake wear warning sound, have your vehicle serviced.

Notice: Continuing to drive with worn-out brake pads could result in costly brake repair.

Some driving conditions or climates may cause a brake squeal when the brakes are first applied or lightly applied. This does not mean something is wrong with your brakes.

Properly torqued wheel nuts are necessary to help prevent brake pulsation. When tires are rotated, inspect brake pads for wear and evenly tighten wheel nuts in the proper sequence to GM torque specifications.

Brake linings should always be replaced as complete axle sets.

See *Brake System Inspection* on page 6-15.

Brake Pedal Travel

See your dealer if the brake pedal does not return to normal height, or if there is a rapid increase in pedal travel. This could be a sign of brake trouble.

Brake Adjustment

Every time you apply the brakes, with or without the vehicle moving, your brakes adjust for wear.

Replacing Brake System Parts

The braking system on a vehicle is complex. Its many parts have to be of top quality and work well together if the vehicle is to have really good braking. Your vehicle was designed and tested with top-quality GM brake parts. When you replace parts of your braking system — for example, when your brake linings wear down and you need new ones put in — be sure you get new approved GM replacement parts. If you don't, your brakes may no longer work properly. For example, if someone puts in brake linings that are wrong for your vehicle, the balance between your front and rear brakes can change — for the worse. The braking performance you've come to expect can change in many other ways if someone puts in the wrong replacement brake parts.

Battery

Your new vehicle comes with a maintenance free ACDelco® battery. When it's time for a new battery, get one that has the replacement number shown on the original battery's label. We recommend an ACDelco® battery. See *Engine Compartment Overview on page 5-12* for battery location.

Warning: Battery posts, terminals and related accessories contain lead and lead compounds, chemicals known to the State of California to cause cancer and reproductive harm. Wash hands after handling.

If your battery has a very low charge or is dead, you may not be able to remove the ignition key from the ignition switch or shift out of PARK (P). Refer to *Shifting Out of Park (P) on page 2-30*.

Vehicle Storage

If you're not going to drive your vehicle for 25 days or more, remove the black, negative (-) cable from the battery. This will help keep your battery from running down.

CAUTION:

Batteries have acid that can burn you and gas that can explode. You can be badly hurt if you aren't careful. See "Jump Starting" next for tips on working around a battery without getting hurt.

Contact your dealer to learn how to prepare your vehicle for longer storage periods.

Also, for your audio system, see *Theft-Deterrent Feature on page 3-128*.

Jump Starting

If your battery has run down, you may want to use another vehicle and some jumper cables to start your vehicle. Be sure to follow the steps listed below to do it safely.

CAUTION:

Batteries can hurt you. They can be dangerous because:

- They contain acid that can burn you.
- They contain gas that can explode or ignite.
- They contain enough electricity to burn you.

If you don't follow these steps exactly, some or all of these things can hurt you.

Notice: Ignoring these steps could result in costly damage to your vehicle that wouldn't be covered by your warranty.

Trying to start your vehicle by pushing or pulling it won't work, and it could damage your vehicle.

Notice: If the other system isn't a 12-volt system with a negative ground, both vehicles can be damaged.

1. Check the other vehicle. It must have a 12-volt battery with a negative ground system.
2. Get the vehicles close enough so the jumper cables can reach, but be sure the vehicles aren't touching each other. If they are, it could cause a ground connection you don't want. You wouldn't be able to start your vehicle, and the bad grounding could damage the electrical systems.

To avoid the possibility of the vehicles rolling, set the parking brake firmly on both vehicles involved in the jump start procedure. Put an automatic transaxle in PARK (P) or a manual transaxle in NEUTRAL (N) before setting the parking brake.

Notice: If you leave your radio on, it could be badly damaged. The repairs wouldn't be covered by your warranty.

3. Turn off the ignition on both vehicles. Unplug unnecessary accessories plugged into the cigarette lighter or in the accessory power outlet. Turn off the radio and all lamps that aren't needed. This will avoid sparks and help save both batteries. And it could save your radio!
4. Open the hoods and locate the batteries. Find the positive (+) and negative (-) terminal locations on each vehicle. You will not need to access your battery for jump starting. Your vehicle has a remote positive (+) jump starting terminal for that purpose located under the underhood fuse block. The underhood fuse block is located in the engine compartment on the passenger's side of the vehicle, near the diagonal cross brace. See *Engine Compartment Overview* on page 5-12 for more information on location.



To uncover the remote positive (+) terminal, depress the tab at the bottom of the fuse block and pull the cover off.



You should always use the remote positive (+) terminal instead of the positive (+) terminal on the battery.

 **CAUTION:**

An electric fan can start up even when the engine is not running and can injure you. Keep hands, clothing and tools away from any underhood electric fan.

 **CAUTION:**

Fans or other moving engine parts can injure you badly. Keep your hands away from moving parts once the engine is running.

 **CAUTION:**

Using a match near a battery can cause battery gas to explode. People have been hurt doing this, and some have been blinded. Use a flashlight if you need more light.

Be sure the battery has enough water. You don't need to add water to the ACDelco® battery installed in your new vehicle. But if a battery has filler caps, be sure the right amount of fluid is there. If it is low, add water to take care of that first. If you don't, explosive gas could be present.

Battery fluid contains acid that can burn you. Don't get it on you. If you accidentally get it in your eyes or on your skin, flush the place with water and get medical help immediately.

5. Check that the jumper cables don't have loose or missing insulation. If they do, you could get a shock. The vehicles could be damaged too.

Before you connect the cables, here are some basic things you should know. Positive (+) will go to positive (+) or to a remote positive (+) terminal if the vehicle has one. Negative will go to a heavy, unpainted metal engine part or to a remote negative (-) terminal if the vehicle has one.

Don't connect positive (+) to negative (-), or you'll get a short that would damage the battery and maybe other parts, too. And don't connect the negative (-) cable to the negative (-) terminal on the dead battery because this can cause sparks.



6. Connect the red positive (+) cable to the positive (+) terminal location on the vehicle with the dead battery. Use a remote positive (+) terminal if the vehicle has one.



7. Don't let the other end touch metal. Connect it to the positive (+) terminal location on the vehicle with the good battery. Use a remote positive (+) terminal if the vehicle has one.



8. Now connect the black negative (-) cable to the negative (-) terminal location on the vehicle with the good battery. Use a remote negative (-) terminal if the vehicle has one.

Don't let the other end touch anything until the next step. The other end of the negative (-) cable *doesn't* go to the dead battery. It goes to a heavy, unpainted metal part or to a remote negative (-) terminal on the vehicle with the dead battery.



10. Now start the vehicle with the good battery and run the engine for a while.
11. Try to start the vehicle that had the dead battery. If it won't start after a few tries, it probably needs service.

Notice: Damage to your vehicle may result from electrical shorting if jumper cables are removed incorrectly. To prevent electrical shorting, take care that the cables don't touch each other or any other metal. The repairs wouldn't be covered by your warranty.

9. Connect the other end of the negative (-) cable at least 18 inches (45 cm) away from the dead battery, but not near engine parts that move. The electrical connection is just as good there, and the chance of sparks getting back to the battery is much less.

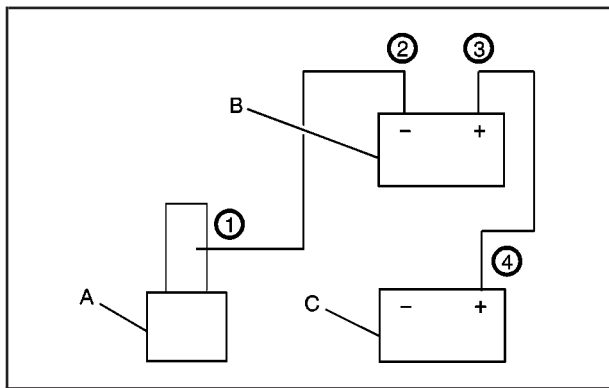

Jumper Cable Removal

- A. Heavy, Unpainted Metal Engine Part
- B. Good Battery or Remote Positive (+) Terminal
- C. Dead Battery or Remote Positive (+) Terminal

To disconnect the jumper cables from both vehicles, do the following:

1. Disconnect the black negative (-) cable from the vehicle that had the dead battery.
2. Disconnect the black negative (-) cable from the vehicle with the good battery.
3. Disconnect the red positive (+) cable from the vehicle with the good battery.
4. Disconnect the red positive (+) cable from the other vehicle.
5. Return the remote positive (+) terminal cover to its original position.

Headlamp Aiming

The vehicle has a visual optical headlamp aiming system. The aim has been preset at the factory and should need no further adjustment

If the vehicle is damaged in an accident, the headlamp aim may be affected and adjustment may be necessary.

If oncoming vehicles flash their high beams at you, this may also mean the vertical aim needs to be adjusted.

It is recommended that you take the vehicle to your dealer for service if the headlamps need to be re-aimed. However, it is possible for you to re-aim the headlamps as described in the following procedure.

The vehicle should be properly prepared as follows:

- The vehicle should be placed so the headlamps are 25 ft. (7.6 m) from a light colored wall or other flat surface.
- The vehicle must have all four tires on a perfectly level surface which is level all the way to the wall or other flat surface.
- The vehicle should be placed so it is perpendicular to the wall or other flat surface.
- The vehicle should not have any snow, ice or mud attached to it.
- The vehicle should be fully assembled and all other work stopped while headlamp aiming is being done.
- The vehicle should be normally loaded with a full tank of fuel and one person or 160 lbs (75 kg) on the driver's seat.
- Tires should be properly inflated.

Headlamp aiming is done with the vehicle's low-beam lamps. The high-beam lamps will be correctly aimed if the low-beam lamps are aimed properly.

The vertical headlamp aiming screws are under the hood near the headlamps.



Adjustment screws can be turned with an E8 Torx® socket or T15 Torx® screwdriver.

Headlamp Vertical Aiming

1. Find the aim dot on the lens of the low beam lamp.



2. Measure the distance from the ground to the aim dot on the lamp. Record the distance.

3. At the wall or other flat surface, measure from the ground upward the recorded distance from Step 2 and draw or tape a horizontal line the width of the vehicle.

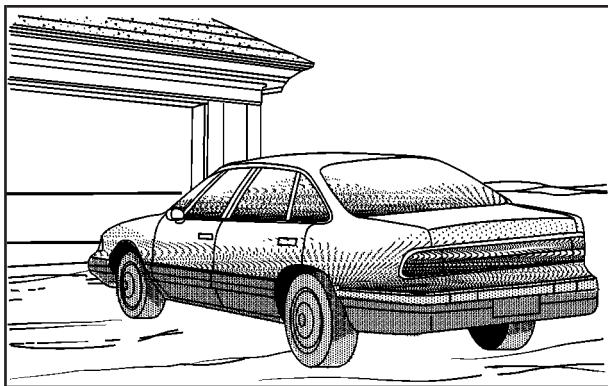

4. Turn on the low-beam headlamps and place a piece of cardboard or equivalent in front of the headlamp not being aimed. This should allow only the beam of light from the headlamp being aimed to be seen on the flat surface.

Notice: Do not cover a headlamp to improve beam cut-off when aiming. Covering a headlamp may cause excessive heat build-up which may cause damage to the headlamp.

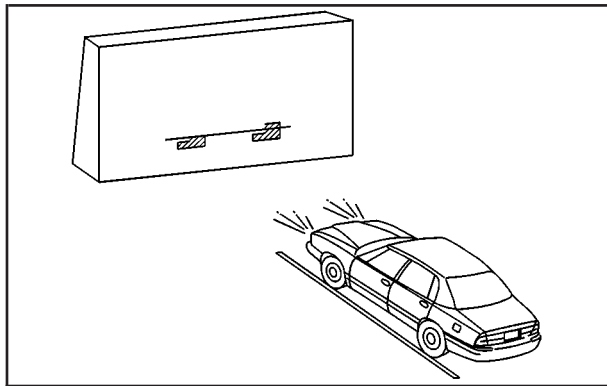

5. Turn the vertical aiming screw until the headlamp beam is aimed to the horizontal tape line. The top edge of the cut-off should be positioned at the bottom edge of the horizontal tape line.
6. Repeat steps 4 and 5 for the opposite headlamp.

Bulb Replacement

For the proper type of replacement bulb, see *Replacement Bulbs on page 5-66*.

For any bulb changing procedure not listed in this section, contact your dealer.

Halogen Bulbs

CAUTION:

Halogen bulbs have pressurized gas inside and can burst if you drop or scratch the bulb. You or others could be injured. Be sure to read and follow the instructions on the bulb package.

Headlamps and Sidemarkers Lamps

1. Open the hood and replace the bulb for the appropriate lamp listed below.



- A. High-Beam Headlamp
- B. Low-Beam Headlamp
- C. Sidemarker Lamp



2. Pull up half-way on the plastic retaining clip on the electrical connector.



3. Pull the headlamp assembly straight out from the vehicle. Be careful to avoid scratching or chipping the paint on the vehicle while removing.

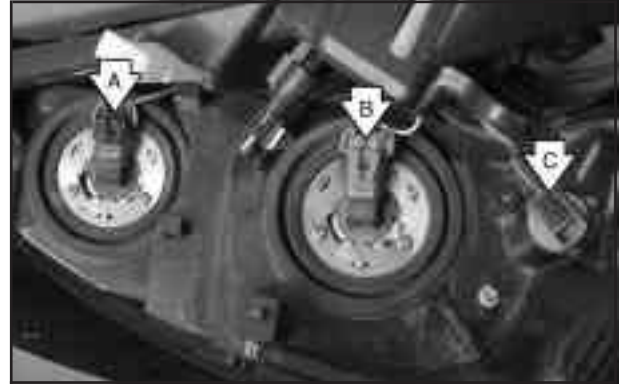

4. Turn the bulb socket ring one-quarter of a turn counterclockwise to remove it from the headlamp assembly. Pull the old bulb from the socket.
5. Place the new bulb into the socket.
6. Turn the bulb socket ring one-quarter turn clockwise to reinstall it back into the headlamp assembly.
7. Carefully reinstall the headlamp assembly. Be careful to avoid scratching or chipping the paint on the vehicle while reinstalling the assembly.
8. Push down on the plastic retaining clip on the electrical connector, making sure the headlamp assembly is secure.

Front Turn Signal, Parking and Fog Lamps

The front turn signal, parking and fog lamps are located below the high, low-beam and sidemarker lamps

1. Open the hood. Replace the bulb for the appropriate lamp listed below.

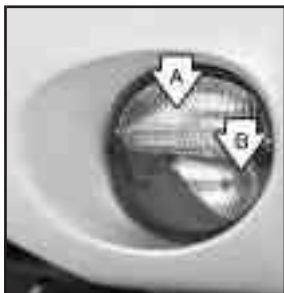

- A. Front Turn Signal, Parking Lamp
- B. Fog Lamp

2. Remove the headlamps.



3. Pull up half-way on the plastic retaining clip on the electrical connector.



4. Pull the headlamp assembly straight out from the vehicle.



The front turn signal, parking lamp and fog lamp bulbs are located below the headlamp assembly. The arrow shows the turn signal/parking lamp bulb. The fog lamp bulb is below it.

5. Turn the bulb socket one-quarter of a turn counterclockwise to remove it from its assembly.
6. Pull the old bulb from the socket and replace it with a new one.
7. Turn the bulb socket a quarter turn clockwise to reinstall it.
8. Carefully reinstall the headlamp assembly. Be careful to avoid scratching or chipping the paint on the vehicle.
9. Push down on the plastic retaining clip on the electrical connector, making sure the headlamp assembly is secure.

Center High-Mounted Stoplamp (CHMSL)

The LED bulb for the center high-mounted stoplamp is located in the spoiler. See your dealer for replacement.

Taillamps, Turn Signal, and Stoplamps

1. Open the trunk. Replace the bulb for the appropriate lamp listed below.

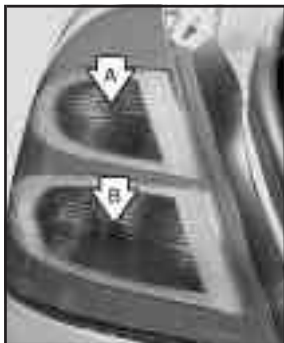

- A. Taillamp
- B. Taillamps, Turn Signal and Stop Lamps

2. Remove the convenience net, if equipped, by removing the net hook attachments.
3. Pull the trunk trim and carpet away from the back of the trunk.
4. Remove the bottom bolt and nut wings.



5. Carefully remove the taillamp assembly by pulling it out from the vehicle. Be careful to avoid scratching or chipping the paint on the vehicle.



6. Turn the appropriate lamp socket a quarter turn counterclockwise and remove it.

7. Remove the old bulb.
8. Place the new bulb into the socket and turn the lamp socket clockwise to install it.
9. Carefully reinstall the taillamp assembly by reversing Steps 2 through 5.

Back-Up Lamps

The back-up lamps are located on the trunk lid.



To replace the back-up lamp bulbs, do the following:

1. Open the trunk.

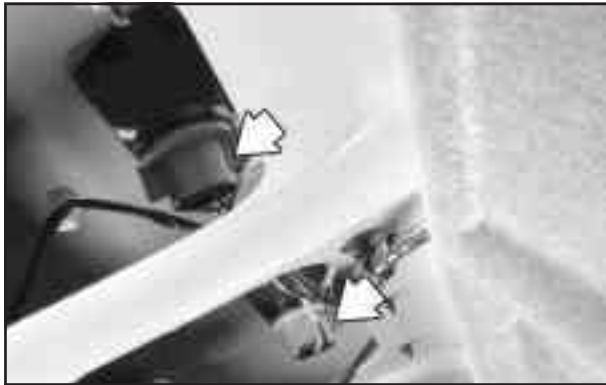

Replacement Bulbs

Exterior Lamps	Bulb Number
Back-Up Lamp	3157
Front Park/Turn Lamp	3757 KA
Front Sidemarker	194
Halogen Headlamps-Low Beam	9006
Halogen Headlamps-High Beam	9005
Stop/Taillamp/Turn Signal Lamps	3057
For any bulb not listed here contact your dealer.	

2. Turn the appropriate lamp socket a quarter turn counterclockwise and remove it.
3. Remove the old bulb.
4. Put the new bulb into the lamp socket.
5. Turn the bulb a quarter turn clockwise to reinstall it.

Windshield Wiper Blade Replacement

Remove and replace a windshield wiper by following these steps:

1. Put the ignition in ACCESSORY and turn the windshield wipers on.
2. Stop the windshield wipers when they are in the upright position by turning the key to the off position.
3. Pull the windshield arm away from the windshield.

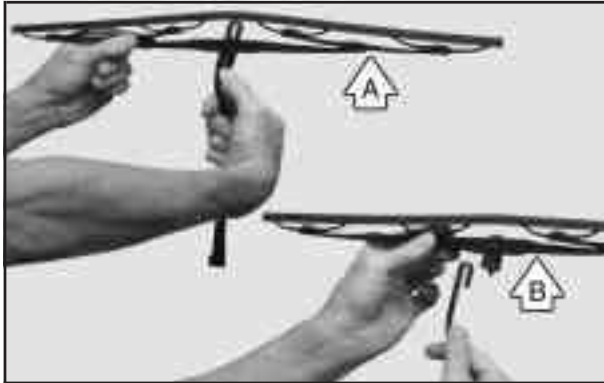

4. Push the release lever on the windshield arm (A).
5. Slide the assembly up and off the arm (B).

To attach a new windshield wiper arm do the following:

1. Push the new wiper blade assembly onto the arm of the windshield wiper. Make sure it snaps over the release button.
2. Place the windshield wiper on the window.
3. Put the ignition in the off position.
4. Turn the windshield wipers off.

Windshield wiper blades should be inspected at least twice a year for wear or cracking. See "Wiper Blade Check" under *At Least Twice a Year* on page 6-11 in the maintenance schedule for more information.

Replacement blades come in different types and are removed in different ways. For the proper type and length, see *Normal Maintenance Replacement Parts* on page 5-105.

Tires

Your new vehicle comes with high-quality tires made by a leading tire manufacturer. If you ever have questions about your tire warranty and where to obtain service, see your Pontiac Warranty booklet for details.

CAUTION:

Poorly maintained and improperly used tires are dangerous.

- **Overloading your tires can cause overheating as a result of too much friction. You could have an air-out and a serious accident. See “Loading Your Vehicle” in the Index.**

CAUTION: (Continued)

CAUTION: (Continued)

- **Underinflated tires pose the same danger as overloaded tires. The resulting accident could cause serious injury. Check all tires frequently to maintain the recommended pressure. Tire pressure should be checked when your tires are cold.**
- **Overinflated tires are more likely to be cut, punctured or broken by a sudden impact — such as when you hit a pothole. Keep tires at the recommended pressure.**
- **Worn, old tires can cause accidents. If your tread is badly worn, or if your tires have been damaged, replace them.**

Inflation -- Tire Pressure

The Tire-Loading Information label, which is on the inside of the trunk lid, shows the correct inflation pressures for your tires when they're cold. "Cold" means your vehicle has been sitting for at least three hours or driven no more than 1 mile (1.6 km).

Notice: Don't let anyone tell you that underinflation or overinflation is all right. It's not. If your tires don't have enough air (underinflation), you can get the following:

- Too much flexing
- Too much heat
- Tire overloading
- Bad wear
- Bad handling
- Bad fuel economy

If your tires have too much air (overinflation), you can get the following:

- Unusual wear
- Bad handling
- Rough ride
- Needless damage from road hazards

When to Check

Check your tires once a month or more.

Don't forget your compact spare tire. It should be at 60 psi (420 kPa).

How to Check

Use a good quality pocket-type gage to check tire pressure. You can't tell if your tires are properly inflated simply by looking at them. Radial tires may look properly inflated even when they're underinflated.

Be sure to put the valve caps back on the valve stems. They help prevent leaks by keeping out dirt and moisture.

Tire Pressure Monitor System

This vehicle has the tire inflation monitor system, it can alert you to a large change in the pressure of one tire. The system “learns” the pressure at each tire throughout the operating speed range of your vehicle. The system normally takes between 45 and 90 minutes of driving to learn the tire pressures. This time may be longer depending on your individual driving habits. Learning need not be accumulated during a single trip. Once learned, the system will remember the tire pressures until the system is recalibrated.

See *DIC Warnings and Messages on page 3-65* for more information.

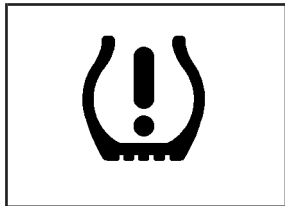

This symbol, along with the CHECK TIRE PRESSURE warning message will appear in the Driver Information Center (DIC) if the pressure in one tire becomes 12 psi (83 kPa) lower than the other three tires.

The tire inflation monitor system won't alert you if the pressure in more than one tire is low, if the system is not properly calibrated, or if the vehicle is moving faster than 70 mph (110 km/h).

The tire inflation monitor system detects differences in tire rotation speeds that are caused by changes in tire pressure. The system can alert you about a low tire – but it doesn't replace normal tire maintenance. See *Tires on page 5-68*.

When the CHECK TIRE PRESSURE warning message comes on, you should stop as soon as you can and check all your tires for damage. (If a tire is flat, see *If a Tire Goes Flat on page 5-78*). Also, check the tire pressure in all four tires as soon as you can. See *Inflation -- Tire Pressure on page 5-69*.

The CHECK TIRE PRESSURE warning message will also be displayed (while the ignition is on) until you reset (calibrate) the system. To reset the system, see “Tire Inflation Monitor System” under the options mode in *DIC Controls and Displays on page 3-45*.

Don't reset the tire inflation monitor system without first correcting the cause of the problem and checking and adjusting the pressure in all four tires. If you reset the system when the tire pressures are incorrect, the system will not work properly and may not alert you when a tire is low.

Any time you adjust a tire's pressure, rotate your tires, or have one or more tires repaired or replaced, you'll need to reset (calibrate) the tire inflation monitor system. You'll also need to reset the system whenever you buy new tires and whenever the vehicle's battery has been disconnected.

Tire Inspection and Rotation

Tires should be rotated every 7,500 miles (12 500 km).

Any time you notice unusual wear, rotate your tires as soon as possible and check wheel alignment. Also check for damaged tires or wheels. See *When It Is Time for New Tires* on page 5-72 and *Wheel Replacement* on page 5-75 for more information.

The purpose of regular rotation is to achieve more uniform wear for all tires on the vehicle. The first rotation is the most important. See “Part A: Scheduled Maintenance Services,” in Section 6, for scheduled rotation intervals.

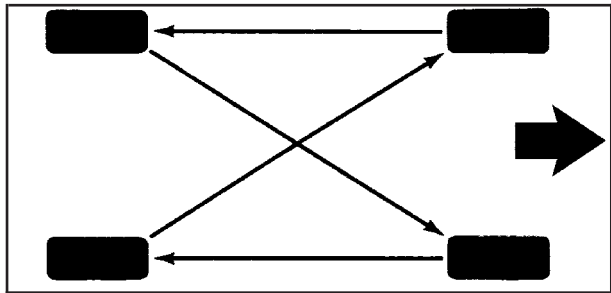

When rotating your tires, always use the correct rotation pattern shown here.

Don't include the compact spare tire in your tire rotation.

After the tires have been rotated, adjust the front and rear inflation pressures as shown on the Tire-Loading Information label. Make certain that all wheel nuts are properly tightened. See “Wheel Nut Torque” under *Capacities and Specifications* on page 5-104.

CAUTION:

Rust or dirt on a wheel, or on the parts to which it is fastened, can make wheel nuts become loose after a time. The wheel could come off and cause an accident. When you change a wheel, remove any rust or dirt from places where the wheel attaches to the vehicle. In an emergency, you can use a cloth or a paper towel to do this; but be sure to use a scraper or wire brush later, if you need to, to get all the rust or dirt off. See “Changing a Flat Tire” in the Index.

When It Is Time for New Tires

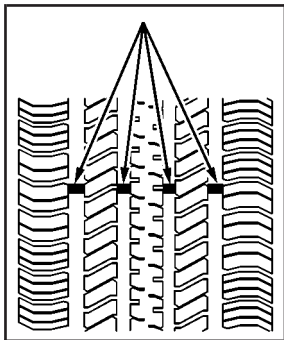

One way to tell when it's time for new tires is to check the treadwear indicators, which will appear when your tires have only 1/16 inch (1.6 mm) or less of tread remaining.

You need a new tire if any of the following statements are true:

- You can see the indicators at three or more places around the tire.
- You can see cord or fabric showing through the tire's rubber.
- The tread or sidewall is cracked, cut or snagged deep enough to show cord or fabric.
- The tire has a bump, bulge or split.
- The tire has a puncture, cut or other damage that can't be repaired well because of the size or location of the damage.

Buying New Tires

To find out what kind and size of tires you need, look at the Tire-Loading Information label.

The tires installed on your vehicle when it was new had a Tire Performance Criteria Specification (TPC Spec) number on each tire's sidewall. When you get new tires, get ones with that same TPC Spec number. That way your vehicle will continue to have tires that are designed to give proper endurance, handling, speed rating, traction, ride and other things during normal service on your vehicle. If your tires have an all-season tread design, the TPC number will be followed by an "MS" (for mud and snow).

If you ever replace your tires with those not having a TPC Spec number, make sure they are the same size, load range, speed rating and construction type (bias, bias-belted or radial) as your original tires.

CAUTION:

Mixing tires could cause you to lose control while driving. If you mix tires of different sizes or types (radial and bias-belted tires), the vehicle may not handle properly, and you could have a crash. Using tires of different sizes may also cause damage to your vehicle. Be sure to use the same size and type tires on all wheels. It's all right to drive with your compact spare temporarily, it was developed for use on your vehicle. See "Compact Spare Tire" in the index.

CAUTION:

If you use bias-ply tires on your vehicle, the wheel rim flanges could develop cracks after many miles of driving. A tire and/or wheel could fail suddenly, causing a crash. Use only radial-ply tires with the wheels on your vehicle.

Uniform Tire Quality Grading

Quality grades can be found where applicable on the tire sidewall between tread shoulder and maximum section width. For example:

Treadwear 200 Traction AA Temperature A

The following information relates to the system developed by the United States National Highway Traffic Safety Administration, which grades tires by treadwear, traction and temperature performance. (This applies only to vehicles sold in the United States.)

The grades are molded on the sidewalls of most passenger car tires. The Uniform Tire Quality Grading system does not apply to deep tread, winter-type snow tires, space-saver or temporary use spare tires, tires with nominal rim diameters of 10 to 12 inches (25 to 30 cm), or to some limited-production tires.

While the tires available on General Motors passenger cars and light trucks may vary with respect to these grades, they must also conform to federal safety requirements and additional General Motors Tire Performance Criteria (TPC) standards.

Treadwear

The treadwear grade is a comparative rating based on the wear rate of the tire when tested under controlled conditions on a specified government test course. For example, a tire graded 150 would wear one and a half (1.5) times as well on the government course as a tire graded 100. The relative performance of tires depends upon the actual conditions of their use, however, and may depart significantly from the norm due to variations in driving habits, service practices and differences in road characteristics and climate.

Traction – AA, A, B, C

The traction grades, from highest to lowest, are AA, A, B, and C. Those grades represent the tire's ability to stop on wet pavement as measured under controlled conditions on specified government test surfaces of asphalt and concrete. A tire marked C may have poor traction performance. Warning: The traction grade assigned to this tire is based on straight-ahead braking traction tests, and does not include acceleration, cornering, hydroplaning, or peak traction characteristics.

Temperature – A, B, C

The temperature grades are A (the highest), B, and C, representing the tire's resistance to the generation of heat and its ability to dissipate heat when tested under controlled conditions on a specified indoor laboratory test wheel. Sustained high temperature can cause the material of the tire to degenerate and reduce tire life, and excessive temperature can lead to sudden tire failure. The grade C corresponds to a level of performance which all passenger car tires must meet under the Federal Motor Vehicle Safety Standard No. 109. Grades B and A represent higher levels of performance on the laboratory test wheel than the minimum required by law.

Warning: The temperature grade for this tire is established for a tire that is properly inflated and not overloaded. Excessive speed, underinflation, or excessive loading, either separately or in combination, can cause heat buildup and possible tire failure.

Wheel Alignment and Tire Balance

The wheels on your vehicle were aligned and balanced carefully at the factory to give you the longest tire life and best overall performance.

Scheduled wheel alignment and wheel balancing are not needed. However, if you notice unusual tire wear or your vehicle pulling one way or the other, the alignment may need to be reset. If you notice your vehicle vibrating when driving on a smooth road, your wheels may need to be rebalanced.

Wheel Replacement

Replace any wheel that is bent, cracked or badly rusted or corroded. If wheel nuts keep coming loose, the wheel, wheel bolts and wheel nuts should be replaced. If the wheel leaks air, replace it (except some aluminum wheels, which can sometimes be repaired). See your dealer if any of these conditions exist.

Your dealer will know the kind of wheel you need.

Each new wheel should have the same load-carrying capacity, diameter, width, offset and be mounted the same way as the one it replaces.

If you need to replace any of your wheels, wheel bolts or wheel nuts, replace them only with new GM original equipment parts. This way, you will be sure to have the right wheel, wheel bolts and wheel nuts for your vehicle.

CAUTION:

Using the wrong replacement wheels, wheel bolts or wheel nuts on your vehicle can be dangerous. It could affect the braking and handling of your vehicle, make your tires lose air and make you lose control. You could have a collision in which you or others could be injured. Always use the correct wheel, wheel bolts and wheel nuts for replacement.

Notice: The wrong wheel can also cause problems with bearing life, brake cooling, speedometer or odometer calibration, headlamp aim, bumper height, vehicle ground clearance and tire or tire chain clearance to the body and chassis.

See *Changing a Flat Tire* on page 5-78 for more information.

Used Replacement Wheels

CAUTION:

Putting a used wheel on your vehicle is dangerous. You can't know how it's been used or how far it's been driven. It could fail suddenly and cause a crash. If you have to replace a wheel, use a new GM original equipment wheel.

Tire Chains

CAUTION:

If your vehicle has P225/55R17 size tires, don't use tire chains, there's not enough clearance.

Tire chains used on a vehicle without the proper amount of clearance can cause damage to the brakes, suspension or other vehicle parts. The area damaged by the tire chains could cause you to lose control of your vehicle and you or others may be injured in a crash.

Use another type of traction device only if its manufacturer recommends it for use on your vehicle and tire size combination and road conditions. Follow that manufacturer's instructions. To help avoid damage to your

CAUTION: (Continued)

CAUTION: (Continued)

vehicle, drive slowly, readjust or remove the device if it's contacting your vehicle, and don't spin your wheels.

If you do find traction devices that will fit, install them on the front tires.

Notice: If your vehicle does not have P225/55R17 size tires, use tire chains only where legal and only when you must. Use only SAE Class "S" type chains that are the proper size for your tires. Install them on the front tires and tighten them as tightly as possible with the ends securely fastened. Drive slowly and follow the chain manufacturer's instructions. If you can hear the chains contacting your vehicle, stop and retighten them. If the contact continues, slow down until it stops. Driving too fast or spinning the wheels with chains on will damage your vehicle.

If a Tire Goes Flat

It's unusual for a tire to “blowout” while you're driving, especially if you maintain your tires properly. If air goes out of a tire, it's much more likely to leak out slowly.

But if you should ever have a “blowout”, here are a few tips about what to expect and what to do:

If a front tire fails, the flat tire will create a drag that pulls the vehicle toward that side. Take your foot off the accelerator pedal and grip the steering wheel firmly. Steer to maintain lane position, and then gently brake to a stop well out of the traffic lane.

A rear blowout, particularly on a curve, acts much like a skid and may require the same correction you'd use in a skid. In any rear blowout, remove your foot from the accelerator pedal. Get the vehicle under control by steering the way you want the vehicle to go. It may be very bumpy and noisy, but you can still steer. Gently brake to a stop — well off the road if possible.

If a tire goes flat, the next part shows how to use your jacking equipment to change a flat tire safely.

Changing a Flat Tire

If a tire goes flat, avoid further tire and wheel damage by driving slowly to a level place. Turn on your hazard warning flashers.

CAUTION:

Changing a tire can cause an injury. The vehicle can slip off the jack and roll over you or other people. You and they could be badly injured. Find a level place to change your tire.

To help prevent the vehicle from moving:

- 1. Set the parking brake firmly.**
- 2. Put the shift lever in PARK (P).**
- 3. Turn off the engine.**

CAUTION: (Continued)

CAUTION: (Continued)

To be even more certain the vehicle won't move, you can put blocks at the front and rear of the tire farthest away from the one being changed. That would be the tire on the other side of the vehicle, at the opposite end.

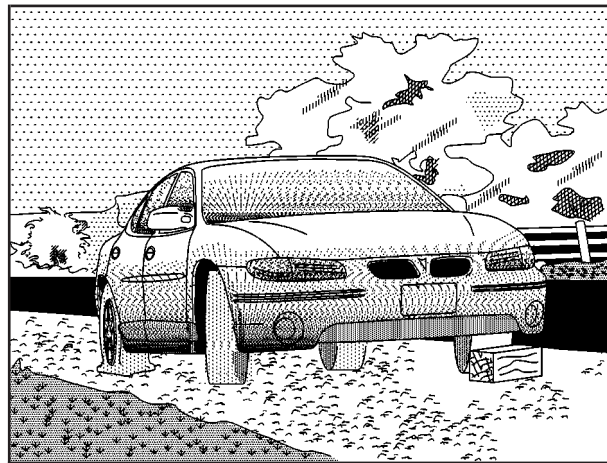

The following steps will tell you how to use the jack and change a tire.

Removing the Spare Tire and Tools

The equipment you'll need is in the trunk.



1. Turn the center nut on the compact spare tire cover counterclockwise to remove it.



2. Remove the compact spare tire. See *Compact Spare Tire on page 5-89* for more information about the compact spare tire.

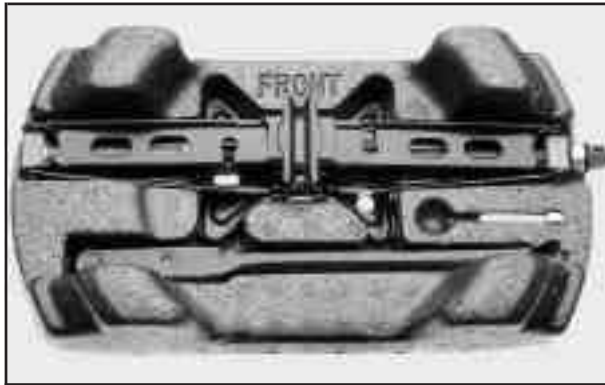

3. Turn the nut holding the jack counterclockwise and remove it. Then remove the jack and wrench.

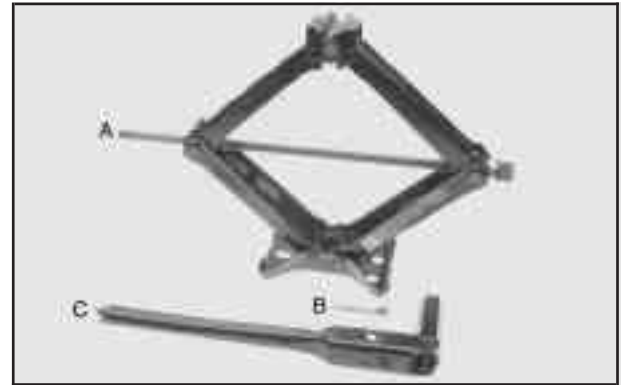

4. The tools you'll be using include the jack (A) extension and protector/guide (B) and the wheel wrench (C).

Removing Wheel Nut Caps



If there is a wheel cover, loosen the plastic nut caps with the wheel wrench. They won't come off. Then, using the flat end of the wheel wrench, pry along the edge of the cover until it comes off.

Removing the Flat Tire and Installing the Spare Tire



1. Using the wheel wrench, loosen all the wheel nuts. Don't remove them yet.
2. Turn the jack handle clockwise to raise the vehicle. Raise the vehicle far enough off the ground for the spare tire to fit underneath the wheel well.

⚠ CAUTION:

Getting under a vehicle when it is jacked up is dangerous. If the vehicle slips off the jack you could be badly injured or killed. Never get under a vehicle when it is supported only by a jack.

⚠ CAUTION:

Raising your vehicle with the jack improperly positioned can damage the vehicle and even make the vehicle fall. To help avoid personal injury and vehicle damage, be sure to fit the jack lift head into the proper location before raising the vehicle.

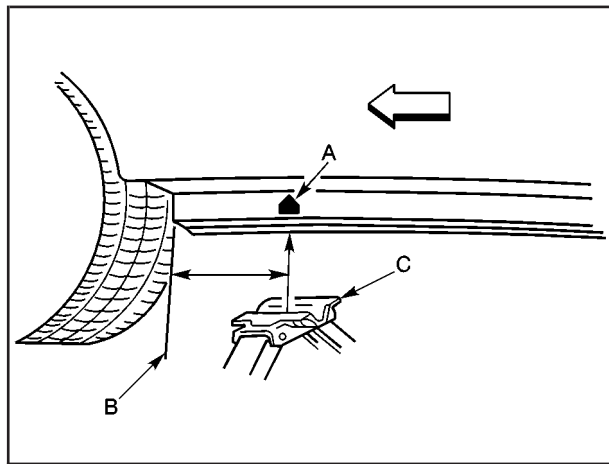

For jacking at the vehicle's front location, put the jack lift head (C) about 6 inches (15 cm) from the rear edge of the front wheel opening (B). Line up the jack with the arrow (A) as shown. Put the compact spare tire near you.

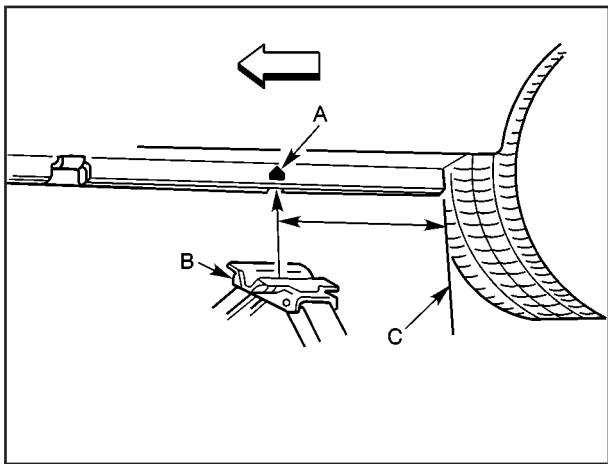

For jacking at the vehicle's rear location, put the jack lift head (B) about 9 inches (23 cm) from the front edge of the rear wheel opening (C). Line up the jack with the arrow (A) as shown.

Put the compact spare tire near you.

3. Raise the vehicle by turning the jack handle clockwise. Raise the vehicle far enough off the ground for the spare tire to fit underneath the wheel well. Remove all wheel nuts and take off the flat tire.

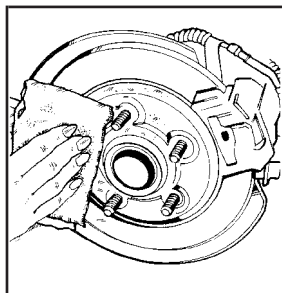

4. Remove any rust or dirt from the wheel bolts, mounting surfaces and spare wheel.

⚠ CAUTION:

Rust or dirt on the wheel, or on the parts to which it is fastened, can make the wheel nuts become loose after a time. The wheel could come off and cause an accident. When you change a wheel, remove any rust or dirt from the places where the wheel attaches to the vehicle. In an emergency, you can use a cloth or a paper towel to do this; but be sure to use a scraper or wire brush later, if you need to, to get all the rust or dirt off.

⚠ CAUTION:

Never use oil or grease on studs or nuts. If you do, the nuts might come loose. Your wheel could fall off, causing a serious accident.

5. Place the spare on the wheel mounting surface.



6. Reinstall the wheel nuts with the rounded end of the nuts toward the wheel. Tighten each nut by hand until the wheel is held against the hub.

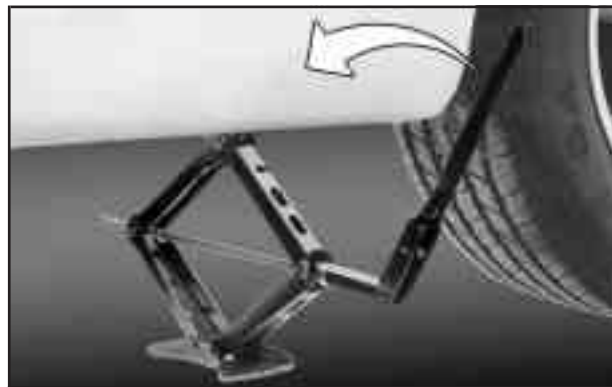

7. Lower the vehicle by turning the jack handle counterclockwise. Lower the jack completely.

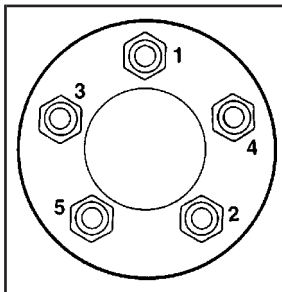

8. Tighten the wheel nuts firmly in a crisscross sequence as shown.

9. Reinstall the wheel trim. If the vehicle has plastic caps tighten them by hand. With a wheel wrench, tighten the plastic caps an additional quarter turn clockwise.

⚠ CAUTION:

Incorrect wheel nuts or improperly tightened wheel nuts can cause the wheel to come loose and even come off. This could lead to an accident. Be sure to use the correct wheel nuts. If you have to replace them, be sure to get new GM original equipment wheel nuts.

CAUTION: (Continued)

CAUTION: (Continued)

Stop somewhere as soon as you can and have the nuts tightened with a torque wrench to the proper torque specification. See “Capacities and Specifications” in the Index for wheel nut torque specification.

Notice: Improperly tightened wheel nuts can lead to brake pulsation and rotor damage. To avoid expensive brake repairs, evenly tighten the wheel nuts in the proper sequence and to the proper torque specification. See “Capacities and Specifications” in the index for the wheel nut torque specification.

10. Don't try to put the wheel cover on your compact spare tire. It won't fit. Store the wheel cover in the trunk until you have the flat tire repaired or replaced.

Notice: Wheel covers won't fit on your compact spare. If you try to put a wheel cover on your compact spare, you could damage the cover or the spare.

Storing the Flat Tire and Tools

CAUTION:

Storing a jack, a tire, or other equipment in the passenger compartment of the vehicle could cause injury. In a sudden stop or collision, loose equipment could strike someone. Store all these in the proper place.

After you've put the compact spare tire on your vehicle, you'll need to store the flat tire in the trunk. Use the following procedure to secure the flat tire in the trunk.



When storing a full-size tire, you must use the extension to help avoid wheel surface damage. Use the extension and protector/guide located in the foam holder. To store a full-size tire, place the tire in the trunk valve stem facing down, with the protector/guide placed through a wheel bolt hole. Remove the protector and attach the retainer securely. When putting the compact spare back in the trunk, place the protector/guide back in the foam holder. Store the cover as far forward as possible.

Storing the Spare Tire and Tools

CAUTION:

Storing a jack, a tire, or other equipment in the passenger compartment of the vehicle could cause injury. In a sudden stop or collision, loose equipment could strike someone. Store all these in the proper place.

Compact Spare Tire

The compact spare tire is for temporary use only. Replace the compact spare tire with a full-size tire as soon as you can. See *Compact Spare Tire on page 5-89*. See the storage instructions label on the trunk lid to properly position your compact spare tire in the trunk.

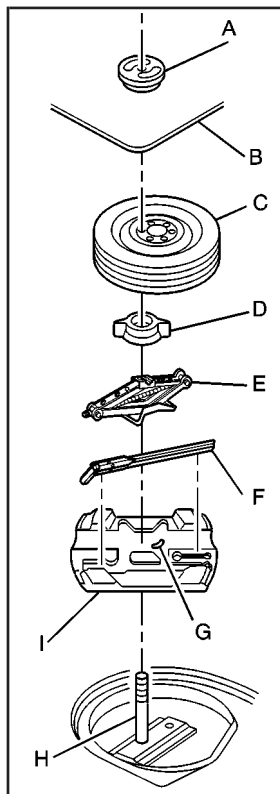

- A. Retainer
- B. Cover
- C. Compact Spare Tire
- D. Nut
- E. Jack
- F. Wheel Wrench
- G. Extension and Protective Guide
- H. Bolt Screw
- I. Foam Holder

Compact Spare Tire

Although the compact spare tire was fully inflated when your vehicle was new, it can lose air after a time. Check the inflation pressure regularly. It should be 60 psi (420 kPa).

After installing the compact spare on your vehicle, you should stop as soon as possible and make sure your spare tire is correctly inflated. The compact spare is made to perform well at speeds up to 65 mph (105 km/h) for distances up to 3,000 miles (5 000 km), so you can finish your trip and have your full-size tire repaired or replaced where you want. Of course, it's best to replace your spare with a full-size tire as soon as you can. Your spare will last longer and be in good shape in case you need it again.

Notice: When the compact spare is installed, don't take your vehicle through an automatic car wash with guide rails. The compact spare can get caught on the rails. That can damage the tire and wheel, and maybe other parts of your vehicle.

Don't use your compact spare on other vehicles.

And don't mix your compact spare tire or wheel with other wheels or tires. They won't fit. Keep your spare tire and its wheel together.

Notice: Tire chains won't fit your compact spare. Using them can damage your vehicle and can damage the chains too. Don't use tire chains on your compact spare.

Appearance Care

Remember, cleaning products can be hazardous. Some are toxic. Others can burst into flames if you strike a match or get them on a hot part of the vehicle. Some are dangerous if you breathe their fumes in a closed space. When you use anything from a container to clean your vehicle, be sure to follow the manufacturer's warnings and instructions. And always open your doors or windows when you're cleaning the inside.

Never use these to clean your vehicle:

- Gasoline
- Benzene
- Naphtha
- Carbon Tetrachloride
- Acetone
- Paint Thinner
- Turpentine
- Lacquer Thinner
- Nail Polish Remover

They can all be hazardous – some more than others – and they can all damage your vehicle, too.

Don't use any of these unless this manual says you can. In many uses, these will damage your vehicle:

- Alcohol
- Laundry Soap
- Bleach
- Reducing Agents

Cleaning the Inside of Your Vehicle

Use a vacuum cleaner often to get rid of dust and loose dirt. Wipe vinyl, leather, plastic and painted surfaces with a clean, damp cloth.

Cleaning Fabric/Carpet

Your dealer has cleaners for the cleaning of fabric and carpet. They will clean normal spots and stains very well.

You can get GM-approved cleaning products from your dealer. See *GM Vehicle Care/Appearance Materials* on page 5-96.

Here are some cleaning tips:

- Always read the instructions on the cleaner label.
- Clean up stains as soon as you can – before they set.
- Carefully scrape off any excess stain.
- Use a clean cloth or sponge, and change to a clean area often. A soft brush may be used if stains are stubborn.
- If a ring forms on fabric after spot cleaning, clean the entire area immediately or it will set.

Using Cleaner on Fabric

1. Vacuum and brush the area to remove any loose dirt.
2. Always clean a whole trim panel or section. Mask surrounding trim along stitch or welt lines.
3. Follow the directions on the container label.
4. Apply cleaner with a clean sponge. Don't saturate the material and don't rub it roughly.
5. As soon as you've cleaned the section, use a sponge to remove any excess cleaner.
6. Wipe cleaned area with a clean, water-dampened towel or cloth.
7. Wipe with a clean cloth and let dry.

Special Fabric Cleaning Problems

Stains caused by such things as catsup, coffee (black), egg, fruit, fruit juice, milk, soft drinks, vomit, urine and blood can be removed as follows:

1. Carefully scrape off excess stain, then sponge the soiled area with cool water.
2. If a stain remains, follow the cleaner instructions described earlier.
3. If an odor lingers after cleaning vomit or urine, treat the area with a water/baking soda solution: 1 teaspoon (5 ml) of baking soda to 1 cup (250 ml) of lukewarm water.
4. Let dry.

Stains caused by candy, ice cream, mayonnaise, chili sauce and unknown stains can be removed as follows:

1. Carefully scrape off excess stain.
2. Clean with cool water and allow to dry completely.
3. If a stain remains, follow the cleaner instructions described earlier.

Cleaning Vinyl

Use warm water and a clean cloth.

- Rub with a clean, damp cloth to remove dirt. You may have to do this more than once.
- Things like tar, asphalt and shoe polish will stain if you don't get them off quickly. Use a clean cloth and vinyl cleaner. See your dealer for this product.

Cleaning Leather

Use a soft cloth with lukewarm water and a mild soap or saddle soap and wipe dry with a soft cloth. Then, let the leather dry naturally. Do not use heat to dry.

- For stubborn stains, use a leather cleaner.
- *Never* use oils, varnishes, solvent-based or abrasive cleaners, furniture polish or shoe polish on leather.
- Soiled or stained leather should be cleaned immediately. If dirt is allowed to work into the finish, it can harm the leather.

Cleaning the Top of the Instrument Panel

Use only mild soap and water to clean the top surfaces of the instrument panel. Sprays containing silicones or waxes may cause annoying reflections in the windshield and even make it difficult to see through the windshield under certain conditions.

Cleaning Interior Plastic Components

Use only a mild soap and water solution on a soft cloth or sponge. Commercial cleaners may affect the surface finish.

Cleaning Glass Surfaces

Glass should be cleaned often. GM Glass Cleaner or a liquid household glass cleaner will remove normal tobacco smoke and dust films on interior glass. See *GM Vehicle Care/Appearance Materials on page 5-96*.

Notice: Don't use abrasive cleaners on glass, because they may cause scratches. Avoid placing decals on the inside rear window, since they may have to be scraped off later. If abrasive cleaners are used on the inside of the rear window, an electric defogger element may be damaged. Any temporary license should not be attached across the defogger grid.

Care of Safety Belts

Keep belts clean and dry.

CAUTION:

Do not bleach or dye safety belts. If you do, it may severely weaken them. In a crash, they might not be able to provide adequate protection. Clean safety belts only with mild soap and lukewarm water.

Weatherstrips

Silicone grease on weatherstrips will make them last longer, seal better, and not stick or squeak. Apply silicone grease with a clean cloth at least every six months. During very cold, damp weather more frequent application may be required. See *Part D: Recommended Fluids and Lubricants* on page 6-16.

Cleaning the Outside of Your Vehicle

The paint finish on your vehicle provides beauty, depth of color, gloss retention and durability.

Washing Your Vehicle

The best way to preserve your vehicle's finish is to keep it clean by washing it often with lukewarm or cold water.

Don't wash your vehicle in the direct rays of the sun. Use a car washing soap. Don't use strong soaps or chemical detergents. Be sure to rinse the vehicle well, removing all soap residue completely. You can get GM-approved cleaning products from your dealer. See *GM Vehicle Care/Appearance Materials* on page 5-96. Don't use cleaning agents that are petroleum based, or that contain acid or abrasives. All cleaning agents should be flushed promptly and not allowed to dry on the surface, or they could stain. Dry the finish with a soft, clean chamois or an all-cotton towel to avoid surface scratches and water spotting.

High pressure car washes may cause water to enter your vehicle.

Cleaning Exterior Lamps/Lenses

Use only lukewarm or cold water, a soft cloth and a car washing soap to clean exterior lamps and lenses. Follow instructions under “Washing Your Vehicle.”

Finish Care

Occasional waxing or mild polishing of your vehicle by hand may be necessary to remove residue from the paint finish. You can get GM-approved cleaning products from your dealer. See *GM Vehicle Care/Appearance Materials* on page 5-96.

Your vehicle has a “basecoat/clearcoat” paint finish. The clearcoat gives more depth and gloss to the colored basecoat. Always use waxes and polishes that are non-abrasive and made for a basecoat/clearcoat paint finish.

Notice: Machine compounding or aggressive polishing on a basecoat/clearcoat paint finish may dull the finish or leave swirl marks.

Foreign materials such as calcium chloride and other salts, ice melting agents, road oil and tar, tree sap, bird droppings, chemicals from industrial chimneys, etc., can damage your vehicle’s finish if they remain on painted surfaces. Wash the vehicle as soon as possible. If necessary, use non-abrasive cleaners that are marked safe for painted surfaces to remove foreign matter.

Exterior painted surfaces are subject to aging, weather and chemical fallout that can take their toll over a period of years. You can help to keep the paint finish looking new by keeping your vehicle garaged or covered whenever possible.

Cleaning Windshield and Wiper Blades

If the windshield is not clear after using the windshield washer, or if the wiper blade chatters when running, wax, sap or other material may be on the blade or windshield.

Clean the outside of the windshield with a full-strength glass cleaning liquid. The windshield is clean if beads do not form when you rinse it with water.

Grime from the windshield will stick to the wiper blades and affect their performance. Clean the blade by wiping vigorously with a cloth soaked in full-strength windshield washer solvent. Then rinse the blade with water.

Check the wiper blades and clean them as necessary; replace blades that look worn.

Cleaning Aluminum Wheels

Keep your wheels clean using a soft clean cloth with mild soap and water. Rinse with clean water. After rinsing thoroughly, dry with a soft clean towel. A wax may then be applied.

The surface of these wheels is similar to the painted surface of your vehicle. Don't use strong soaps, chemicals, abrasive polishes, abrasive cleaners, cleaners with acid, or abrasive cleaning brushes on them because you could damage the surface. Do not use chrome polish on aluminum wheels.

Don't take your vehicle through an automatic car wash that has silicone carbide tire cleaning brushes. These brushes can also damage the surface of these wheels.

Cleaning Tires

To clean your tires, use a stiff brush with tire cleaner.

Notice: When applying a tire dressing, always take care to wipe off any overspray or splash from all painted surfaces on the body or wheels of the vehicle. Petroleum-based products may damage the paint finish and tires.

Sheet Metal Damage

If your vehicle is damaged and requires sheet metal repair or replacement, make sure the body repair shop applies anti-corrosion material to parts repaired or replaced to restore corrosion protection.

Original manufacturer replacement parts will provide the corrosion protection while maintaining the warranty.

Finish Damage

Any stone chips, fractures or deep scratches in the finish should be repaired right away. Bare metal will corrode quickly and may develop into major repair expense.

Minor chips and scratches can be repaired with touch-up materials available from your dealer. Larger areas of finish damage can be corrected in your dealer's body and paint shop.

Underbody Maintenance

Chemicals used for ice and snow removal and dust control can collect on the underbody. If these are not removed, accelerated corrosion (rust) can occur on the underbody parts such as fuel lines, frame, floor pan and exhaust system even though they have corrosion protection.

At least every spring, flush these materials from the underbody with plain water. Clean any areas where mud and debris can collect. Dirt packed in close areas of the frame should be loosened before being flushed. Your dealer or an underbody car washing system can do this for you.

Chemical Paint Spotting

Some weather and atmospheric conditions can create a chemical fallout. Airborne pollutants can fall upon and attack painted surfaces on your vehicle. This damage can take two forms: blotchy, ring-shaped discolorations, and small, irregular dark spots etched into the paint surface.

Although no defect in the paint job causes this, GM will repair, at no charge to the owner, the surfaces of new vehicles damaged by this fallout condition within 12 months or 12,000 miles (20 000 km) of purchase, whichever occurs first.

GM Vehicle Care/Appearance Materials

See your GM dealer for more information on purchasing the following products.

GM Vehicle Care/Appearance Materials

Description	Usage
Polishing Cloth Wax-Treated	Interior and exterior polishing cloth.
Tar and Road Oil Remover	Removes tar, road oil and asphalt.
Chrome Cleaner and Polish	Use on chrome or stainless steel.
White Sidewall Tire Cleaner	Removes soil and black marks from whitewalls.
Vinyl Cleaner	Cleans vinyl tops, upholstery and convertible tops.
Glass Cleaner	Removes dirt, grime, smoke and fingerprints.

GM Vehicle Care/Appearance Materials (cont'd)

Description	Usage
Chrome and Wire Wheel Cleaner	Removes dirt and grime from chrome wheels and wire wheel covers.
Finish Enhancer	Removes dust, fingerprints, and surface contaminants, Spray on wipe off.
Swirl Remover Polish	Removes swirl marks, fine scratches and other light surface contamination.
Cleaner Wax	Removes light scratches and protects finish.
Foaming Tire Shine Low Gloss	Cleans, shines and protects in one easy step, no wiping necessary.

GM Vehicle Care/Appearance Materials (cont'd)

Description	Usage
Wash Wax Concentrate	Medium foaming shampoo. Cleans and lightly waxes. Biodegradable and phosphate free.
Spot Lifter	Quickly and easily removes spots and stains from carpets, vinyl and cloth upholstery.
Odor Eliminator	Odorless spray odor eliminator used on fabrics, vinyl, leather and carpet.
See your General Motors parts department for these products. See <i>Part D: Recommended Fluids and Lubricants</i> on page 6-16.	

Vehicle Identification

Vehicle Identification Number (VIN)



This is the legal identifier for your vehicle. It appears on a plate in the front corner of the instrument panel, on the driver's side. You can see it if you look through the windshield from outside your vehicle. The VIN also appears on the Vehicle Certification and Service Parts labels and the certificates of title and registration.

Engine Identification

The 8th character in your VIN is the engine code. This code will help you identify your engine, specifications and replacement parts.

Service Parts Identification Label

You'll find this label on the inside of your trunk lid. It's very helpful if you ever need to order parts. On this label is:

- your VIN,
- the model designation,
- paint information and
- a list of all production options and special equipment.

Be sure that this label is not removed from the vehicle.

Electrical System

Add-On Electrical Equipment

Notice: Don't add anything electrical to your vehicle unless you check with your dealer first. Some electrical equipment can damage your vehicle and the damage wouldn't be covered by your warranty. Some add-on electrical equipment can keep other components from working as they should.

Your vehicle has an air bag system. Before attempting to add anything electrical to your vehicle see *Servicing Your Air Bag-Equipped Vehicle* on page 1-56.

Headlamp Wiring

The headlamp circuit is protected by individual fuses in the underhood fuse block. An electrical overload will cause the fuse to blow. If this happens, have your headlamp system checked right away.

Windshield Wiper Fuses

The windshield wiper motor is protected by a circuit breaker and a fuse. If the motor overheats due to heavy snow, etc., the wiper will stop until the motor cools. If the overload is caused by some electrical problem, have it fixed.

Power Windows and Other Power Options

Circuit breakers in the fuse panel protect the power windows and other power accessories. When the current load is too heavy, the circuit breaker opens and closes, protecting the circuit until the problem is fixed.

Fuses and Circuit Breakers

The wiring circuits in your vehicle are protected from short circuits by a combination of fuses, circuit breakers and fusible thermal links in the wiring itself. This greatly reduces the chance of fires caused by electrical problems.

Look at the silver-colored band inside the fuse. If the band is broken or melted, replace the fuse. Be sure you replace a bad fuse with a new one of the identical size and rating. Spare fuses and a fuse puller are located in the underhood fuse block. See *Underhood Fuse Block* later in this section.

Instrument Panel Fuse Block



Some fuses are in a fuse block located on the end of the instrument panel on the passenger side. To get to the fuse block lift up on the side panel.

A fuse usage chart is on the inside of this panel.

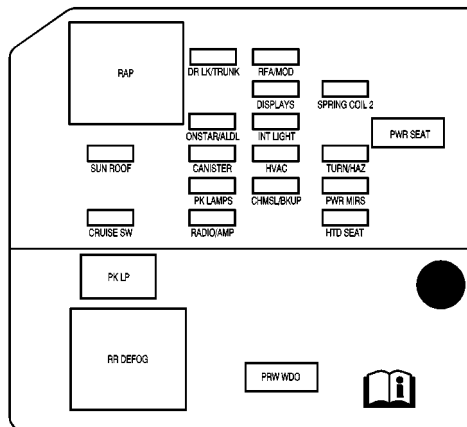

Circuit Breakers	Usage
RAP	Retained Accessory Power
SUN ROOF	Sunroof
CRUISE SW	Cruise Switch
PK LP	Parking Lamps

Circuit Breakers	Usage
RR DEFOG	Rear Window Defogger
DR LK/TRUNK	Door Lock/Trunk
ONSTAR/ALDL	Onstar [®] /Diagnostic Link
CANNISTER	Fuel Tank Solenoid Cannister
PK LAMPS	Parking Lamps
RADIO/AMP	Radio Amplifier
RFA/MOD	Remote Function Activator (Remote Keyless Entry)
DISPLAYS	Instrument Panel Displays/HUD/DIC
INT LIGHT	Interior Lamps
HVAC	Climate Controls

Circuit Breakers	Usage
CHMSL/BKUP	Center High Mounted Stop Lamp/Back-Up Lamps
PWR WDO	Power Windows
SPRING COIL 2	Steering Wheel Control Switches
PWR SEAT	Power Seat
TURN/HAZ	Turn Signals/Hazard Warning Lamps
PWR MIRS	Power Mirrors
HTD SEAT	Heated Seat

To reinstall the end panel, position the lower section with the edge, on the side opening and press the sides of the panel until it snaps into place.

Underhood Fuse Block



Some fuses are located in a fuse block in the engine compartment on the passenger's side. Unscrew the bolt in the center of the fuse block cover and remove the cover.

A fuse chart is on the inside of the cover. To take the cover off, press the tab at the bottom of the cover and pull.

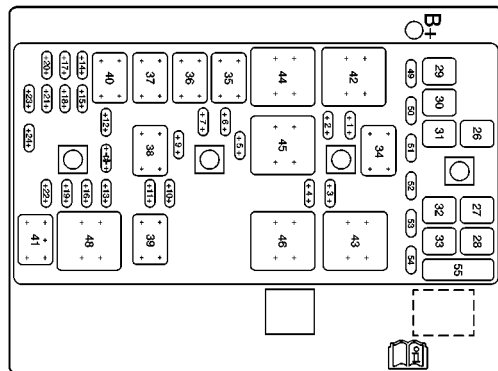

Fuses	Usage
-------	-------

1	Left Front High-Beam Headlamp
2	Right Front High-Beam Headlamp
3	Left Front Low-Beam Headlamp
4	Right Front Low-Beam Headlamp
5	Windshield Wipers/Washer
6	Washer/Remote Vehicle Current
7	Fog Lamps
9	SIR
10	Auxilliary Power
11	Horn
12	Emission

Fuses	Usage	Relays	Usage
13	A/C Clutch	34	Hghi-Beam Headlamps
14	Oxygen Sensor	35	Low-Beam Headlamps
15	Power Control Module	36	Fog Lamps
16	Power Control Module/Electronic Throttle Control	37	Iginition 1
17	Electronic Throttle Control	38	Air Conditioner Compressor
18	Display	39	Horn
19	Anti-Lock Brake Solenoid	40	Powertrain
20	Fuel Injection	41	Fuel Pump
21	Transmission Solenoid	42	Fan 1
22	Fuel Pump	43	Fan 3
23	Anti-Lock Brakes	44	Windshield Wiper/High
24	Electronic Ignition	45	Windshield Wiper
26	Battery Main 1	46	Fan 2
27	Battery Main 2	48	Crank
28	Battery Main 3	49	Spare Fuse
29	Fan 1	50	Spare Fuse
30	Battery Main 4	51	Spare Fuse
31	Anti-Lock Brake Motor	52	Blank
32	Fan 2	53	Blank
33	Starter	54	Blank
		55	Fuse Puller
			A/C Clutch

Capacities and Specifications

Please refer to *Part D: Recommended Fluids and Lubricants on page 6-16* for more information.

Capacities and Specifications

Application	Capacities	
	English	Metric
Air Conditioning Refrigerant R134a	2.4 lbs	1.1 kg
Automatic Transaxle Pan Removal and Replacement After Complete Overhaul	7.4 quarts 10.0 quarts	7.0 L 9.5 L
When draining/replacing converter or auxiliary cooler, more fluid may be needed.		
Cooling System Including Reservoir 3800 V6 (Code K) 3800 V6 Supercharged (Code 1)	11.2 quarts 11.2 quarts	10.6 L 10.6 L
Engine Oil with Filter 3800 V6 (Code K) 3800 V6 Supercharged (Code 1)	4.3 quarts 4.3 quarts	4.1 L 4.1 L
Fuel Tank	17.0 gallons	64.0 L
Wheel Nut Torque	100 ft lb	140 N•m
All capacities are approximate. When adding fluid, be sure to fill to the appropriate level, as recommended in this manual. Recheck fluid level after filling. See <i>Part D: Recommended Fluids and Lubricants on page 6-16</i> for more information.		

Engine Specifications

Engine	VIN Code	Transmission	Spark Plug Gap	Firing Order
3800 V6 231 CID (3.8L L26)	2	Automatic	.060 inch (1.52mm)	1-6-5-4-3-2
3800 V6 Supercharged 231 CID (3.8L L32)	4	Automatic	.060 inch (1.52mm)	1-6-5-4-3-2

Normal Maintenance Replacement Parts

Normal Maintenance Replacement Parts

All Engines	
Automatic Transmission Filter	GM Part No. 24206433
Engine Air Cleaner /Filter	GM Part No. 24508572, A1614C*
Oil Filter	GM Part No. 25010792, PF47*
Passenger Compartment Air Filter Kit	GM Part No. 10406026
Spark Plugs	GM Part No. 12568387, 41-101*
Wiper Blades Type Length	Shepherd's Hook 22 inches (56 cm)
*ACDelco® part number	

Section 6 Maintenance Schedule

Maintenance Schedule	6-2	At Least Once a Year	6-11
Introduction	6-2	Part C: Periodic Maintenance Inspections	6-14
Maintenance Requirements	6-2	Steering, Suspension and Front Drive Axle	
Your Vehicle and the Environment	6-2	Boot and Seal Inspection	6-14
How This Section is Organized	6-3	Exhaust System Inspection	6-14
Part A: Scheduled Maintenance Services	6-4	Fuel System Inspection	6-14
Using Your Maintenance Schedule	6-4	Engine Cooling System Inspection	6-15
Scheduled Maintenance	6-5	Throttle System Inspection	6-15
Part B: Owner Checks and Services	6-10	Brake System Inspection	6-15
At Each Fuel Fill	6-10	Part D: Recommended Fluids and Lubricants	6-16
At Least Once a Month	6-10	Part E: Maintenance Record	6-17
At Least Twice a Year	6-11		

Maintenance Schedule

Introduction

Important: Keep engine oil at the proper level and change as recommended.



Have you purchased the GM Protection Plan? The Plan supplements your new vehicle warranties. See your Warranty and Owner Assistance booklet or your dealer for details.

Maintenance Requirements

Maintenance intervals, checks, inspections and recommended fluids and lubricants as prescribed in this manual are necessary to keep your vehicle in good working condition. Any damage caused by failure to follow scheduled maintenance may not be covered by warranty.

Your Vehicle and the Environment

Proper vehicle maintenance not only helps to keep your vehicle in good working condition, but also helps the environment. Improper vehicle maintenance can even affect the quality of the air we breathe. Improper fluid levels or the wrong tire inflation can increase the level of emissions from your vehicle. To help protect our environment, and to keep your vehicle in good condition, be sure to maintain your vehicle properly.

How This Section is Organized

This maintenance schedule is divided into five parts:

“Part A: Scheduled Maintenance Services” explains what to have done and how often. Some of these services can be complex, so unless you are technically qualified and have the necessary equipment, you should let your GM dealer’s service department do these jobs.

Your GM dealer has GM-trained and supported service people that will perform the work using genuine GM parts.

CAUTION:

Performing maintenance work on a vehicle can be dangerous. In trying to do some jobs, you can be seriously injured. Do your own maintenance work only if you have the required know-how and the proper tools and equipment for the job. If you have any doubt, have a qualified technician do the work.

If you want to get the service information, see *Service Publications Ordering Information* on page 7-10.

“Part B: Owner Checks and Services” tells you what should be checked and when. It also explains what you can easily do to help keep your vehicle in good condition.

“Part C: Periodic Maintenance Inspections” explains important inspections that your dealer’s service department can perform for you.

“Part D: Recommended Fluids and Lubricants” lists some recommended products necessary to help keep your vehicle properly maintained. These products, or their equivalents, should be used whether you do the work yourself or have it done.

“Part E: Maintenance Record” is a place for you to record and keep track of the maintenance performed on your vehicle. Keep your maintenance receipts. They may be needed to qualify your vehicle for warranty repairs.

Part A: Scheduled Maintenance Services

This part contains engine oil scheduled maintenance which explains the engine oil life system and how it indicates when to change the engine oil and filter. Also, listed are scheduled maintenance services which are to be performed at the mileage intervals specified.

Using Your Maintenance Schedule

We at General Motors want to keep your vehicle in good working condition. But we don't know exactly how you'll drive it. You may drive short distances only a few times a week. Or you may drive long distances all the time in very hot, dusty weather. You may use your vehicle in making deliveries. Or you may drive it to work, to do errands or in many other ways.

Because of the different ways people use their vehicles, maintenance needs may vary. You may need more frequent checks and replacements. So please read the following and note how you drive. If you have questions on how to keep your vehicle in good condition, see your dealer.

This part tells you the maintenance services you should have done and when to schedule them.

When you go to your dealer for your service needs, you'll know that GM-trained and supported service people will perform the work using genuine GM parts.

The proper fluids and lubricants to use are listed in Part D. Make sure whoever services your vehicle uses these. All parts should be replaced and all necessary repairs done before you or anyone else drives the vehicle.

This schedule is for vehicles that:

- carry passengers and cargo within recommended limits. You will find these on your vehicle's Tire-Loading Information label. See *Loading Your Vehicle on page 4-35*.
- are driven on reasonable road surfaces within legal driving limits.
- use the recommended fuel. See *Gasoline Octane on page 5-4*.

Scheduled Maintenance

The services shown in this schedule up to 100,000 miles (166 000 km) should be repeated after 100,000 miles (166 000 km) at the same intervals for the life of this vehicle. The services shown at 150,000 miles (240 000 km) should be repeated at the same interval after 150,000 miles (240 000 km) for the life of this vehicle.

See *Part B: Owner Checks and Services on page 6-10* and *Part C: Periodic Maintenance Inspections on page 6-14*.

Footnotes

† *The U.S. Environmental Protection Agency or the California Air Resources Board has determined that the failure to perform this maintenance item will not nullify the emission warranty or limit recall liability prior to the completion of the vehicle's useful life. We, however, urge that all recommended maintenance services be performed at the indicated intervals and the maintenance be recorded.*

+A good time to check your brakes is during tire rotation. See Brake System Inspection on page 6-15.

Engine Oil Scheduled Maintenance

Change engine oil and filter as indicated by the GM Oil Life System (or every 12 months, whichever occurs first). Reset the system.

Your vehicle has a computer system that lets you know when to change the engine oil and filter. This is based on engine revolutions and engine temperature, and not on mileage. Based on driving conditions, the mileage at which an oil change will be indicated can vary considerably. For the oil life system to work properly, you must reset the system every time the oil is changed.

When the system has calculated that oil life has been diminished, it will indicate that an oil change is necessary. A CHANGE OIL SOON light will come on. Change your oil as soon as possible within the next two times you stop for fuel. It is possible that, if you are driving under the best conditions, the oil life system may not indicate that an oil change is necessary for over a year. However, your engine oil and filter must be changed at least once a year and at this time the system must be reset. Your dealer has GM-trained service people who will perform this work using genuine GM parts and reset the system.

It is also important to check your oil regularly and keep it at the proper level.

If the system is ever reset accidentally, you must change your oil at 3,000 miles (5 000 km) since your last oil change. Remember to reset the oil life system whenever the oil is changed. See *Engine Oil* on page 5-16 for information on resetting the system.

An Emission Control Service.

See the mileage intervals following for additional services that may be performed with an engine oil change. After the services are performed, record the date, odometer reading and who performed the service on the maintenance record pages in Part E of this schedule.

7,500 Miles (12 500 km)

- Rotate tires. See *Tire Inspection and Rotation* on page 5-71 for proper rotation pattern and additional information. (See footnote +.)

15,000 Miles (25 000 km)

- Inspect engine air cleaner filter. If necessary, replace the filter. If vehicle is driven in dusty/dirty conditions, inspect filter at every engine oil change. See *Engine Air Cleaner/Filter* on page 5-22 for more information. *An Emission Control Service.* (See footnote †.)

- Rotate tires. See *Tire Inspection and Rotation* on page 5-71 for proper rotation pattern and additional information. (See footnote +.)
- Replace passenger compartment air filter. If you drive regularly under dusty conditions, the filter may require replacement more often.

22,500 Miles (37 500 km)

- Rotate tires. See *Tire Inspection and Rotation* on page 5-71 for proper rotation pattern and additional information. (See footnote +.)

30,000 Miles (50 000 km)

- Rotate tires. See *Tire Inspection and Rotation* on page 5-71 for proper rotation pattern and additional information. (See footnote +.)
- Replace passenger compartment air filter. If you drive regularly under dusty conditions, the filter may require replacement more often.
- Replace engine air cleaner filter. See *Engine Air Cleaner/Filter* on page 5-22 for more information. *An Emission Control Service.*
- For supercharged engines only: Check the supercharger oil level and add the proper supercharger oil as needed (or every 36 months, whichever occurs first). See *Part D: Recommended Fluids and Lubricants* on page 6-16. *An Emission Control Service.* (See footnote †.)

37,500 Miles (62 500 km)

- Rotate tires. See *Tire Inspection and Rotation on page 5-71* for proper rotation pattern and additional information. (See footnote +.)

45,000 Miles (75 000 km)

- Inspect engine air cleaner filter. If necessary, replace the filter. If vehicle is driven in dusty/dirty conditions, inspect filter at every engine oil change. See *Engine Air Cleaner/Filter on page 5-22* for more information. *An Emission Control Service.* (See footnote †.)
- Rotate tires. See *Tire Inspection and Rotation on page 5-71* for proper rotation pattern and additional information. (See footnote +.)
- Replace passenger compartment air filter. If you drive regularly under dusty conditions, the filter may require replacement more often.

50,000 Miles (83 000 km)

- Change automatic transaxle fluid and filter if the vehicle is mainly driven under one or more of these conditions:
 - In heavy city traffic where the outside temperature regularly reaches 90°F (32°C) or higher.
 - In hilly or mountainous terrain.
 - When doing frequent trailer towing.
 - Uses such as found in taxi, police or delivery service.

If you do not use your vehicle under any of these conditions, change the fluid and filter at 100,000 miles (166 000 km).

52,500 Miles (87 500 km)

- Rotate tires. See *Tire Inspection and Rotation on page 5-71* for proper rotation pattern and additional information. (See footnote +.)

60,000 Miles (100 000 km)

- ❑ For supercharged engines only: Check the supercharger oil level and add the proper supercharger oil as needed (or every 36 months, whichever occurs first). See *Part D: Recommended Fluids and Lubricants on page 6-16. An Emission Control Service. (See footnote †.)*
- ❑ Rotate tires. See *Tire Inspection and Rotation on page 5-71* for proper rotation pattern and additional information. *(See footnote +.)*
- ❑ Replace passenger compartment air filter. If you drive regularly under dusty conditions, the filter may require replacement more often.
- ❑ Replace engine air cleaner filter. See *Engine Air Cleaner/Filter on page 5-22* for more information. *An Emission Control Service.*

67,500 Miles (112 500 km)

- ❑ Rotate tires. See *Tire Inspection and Rotation on page 5-71* for proper rotation pattern and additional information. *(See footnote +.)*

75,000 Miles (125 000 km)

- ❑ Inspect engine air cleaner filter. If necessary, replace the filter. If vehicle is driven in dusty/dirty conditions, inspect filter at every engine oil change. See *Engine Air Cleaner/Filter on page 5-22* for more information. *An Emission Control Service. (See footnote †.)*
- ❑ Rotate tires. See *Tire Inspection and Rotation on page 5-71* for proper rotation pattern and additional information. *(See footnote +.)*
- ❑ Replace passenger compartment air filter. If you drive regularly under dusty conditions, the filter may require replacement more often.

82,500 Miles (137 500 km)

- ❑ Rotate tires. See *Tire Inspection and Rotation on page 5-71* for proper rotation pattern and additional information. *(See footnote +.)*

90,000 Miles (150 000 km)

- ❑ Replace engine air cleaner filter. See *Engine Air Cleaner/Filter on page 5-22* for more information. *An Emission Control Service.*
- ❑ For supercharged engines only: Check the supercharger oil level and add the proper supercharger oil as needed (or every 36 months, whichever occurs first). See *Part D: Recommended Fluids and Lubricants on page 6-16. An Emission Control Service. (See footnote †.)*
- ❑ Rotate tires. See *Tire Inspection and Rotation on page 5-71* for proper rotation pattern and additional information. *(See footnote +.)*
- ❑ Replace passenger compartment air filter. If you drive regularly under dusty conditions, the filter may require replacement more often.

97,500 Miles (162 500 km)

- ❑ Rotate tires. See *Tire Inspection and Rotation on page 5-71* for proper rotation pattern and additional information. *(See footnote +.)*

100,000 Miles (166 000 km)

- ❑ Inspect spark plug wires. *An Emission Control Service.*
- ❑ Replace spark plugs. *An Emission Control Service.*

- ❑ Change automatic transaxle fluid and filter if the vehicle is mainly driven under one or more of these conditions:
 - In heavy city traffic where the outside temperature regularly reaches 90°F (32°C) or higher.
 - In hilly or mountainous terrain.
 - When doing frequent trailer towing.
 - Uses such as found in taxi, police or delivery service.
- ❑ If you haven't used your vehicle under severe service conditions listed previously and, therefore, haven't changed your automatic transaxle fluid, change both the fluid and filter.

150,000 Miles (240 000 km)

- ❑ Drain, flush and refill cooling system (or every 60 months since last service, whichever occurs first). See *Engine Coolant on page 5-26* for what to use. Inspect hoses. Clean radiator, condenser, pressure cap and neck. Pressure test the cooling system and pressure cap. *An Emission Control Service.*
- ❑ Inspect engine accessory drive belt. *An Emission Control Service.*

Part B: Owner Checks and Services

Listed in this part are owner checks and services which should be performed at the intervals specified to help ensure the safety, dependability and emission control performance of your vehicle.

Be sure any necessary repairs are completed at once. Whenever any fluids or lubricants are added to your vehicle, make sure they are the proper ones, as shown in Part D.

At Each Fuel Fill

It is important for you or a service station attendant to perform these underhood checks at each fuel fill.

Engine Oil Level Check

Check the engine oil level and add the proper oil if necessary. See *Engine Oil on page 5-16* for further details.

Engine Coolant Level Check

Check the engine coolant level and add DEX-COOL[®] coolant mixture if necessary. See *Engine Coolant on page 5-26* for further details.

Windshield Washer Fluid Level Check

Check the windshield washer fluid level in the windshield washer tank and add the proper fluid if necessary. See *Windshield Washer Fluid on page 5-43* for further details.

At Least Once a Month

Tire Inflation Check

Make sure tires are inflated to the correct pressures. Don't forget to check your spare tire. See *Tires on page 5-68* for further details.

Cassette Tape Player Service

Clean cassette tape player. Cleaning should be done every 50 hours of tape play. See *Audio System(s) on page 3-88* for further details.

At Least Twice a Year

Restraint System Check

Make sure the safety belt reminder light and all your belts, buckles, latch plates, retractors and anchorages are working properly. Look for any other loose or damaged safety belt system parts. If you see anything that might keep a safety belt system from doing its job, have it repaired. Have any torn or frayed safety belts replaced.

Also look for any opened or broken air bag coverings, and have them repaired or replaced. (The air bag system does not need regular maintenance.)

Wiper Blade Check

Inspect wiper blades for wear or cracking. Replace blade inserts that appear worn or damaged or that streak or miss areas of the windshield. Also see *“Windshield Wiper and Wiper Blades”* under *Cleaning the Outside of Your Vehicle* on page 5-93.

Weatherstrip Lubrication

Silicone grease on weatherstrips will make them last longer, seal better, and not stick or squeak. Apply silicone grease with a clean cloth. During very cold, damp weather more frequent application may be required. See *Part D: Recommended Fluids and Lubricants* on page 6-16.

Automatic Transaxle Check

Check the transaxle fluid level; add if needed. See *Automatic Transaxle Fluid* on page 5-24. A fluid loss may indicate a problem. Check the system and repair if needed.

At Least Once a Year

Key Lock Cylinders Service

Lubricate the key lock cylinders with the lubricant specified in Part D.

Body Lubrication Service

Lubricate all hood hinges, hood latch assembly, secondary latch, pivots, spring anchor, release pawl, door hinges, rear compartment, glove box door, console door and any folding seat hardware. Part D tells you what to use. More frequent lubrication may be required when exposed to a corrosive environment.

Starter Switch Check

CAUTION:

When you are doing this check, the vehicle could move suddenly. If it does, you or others could be injured. Follow the steps below.

1. Before you start, be sure you have enough room around the vehicle.
2. Firmly apply both the parking brake and the regular brake. See *Parking Brake* on page 2-27 if necessary.

Do not use the accelerator pedal, and be ready to turn off the engine immediately if it starts.

3. Try to start the engine in each gear. The starter should work only in PARK (P) or NEUTRAL (N). If the starter works in any other position, your vehicle needs service.

Automatic Transaxle Shift Lock Control System Check

CAUTION:

When you are doing this check, the vehicle could move suddenly. If it does, you or others could be injured. Follow the steps below.

1. Before you start, be sure you have enough room around the vehicle. It should be parked on a level surface.
2. Firmly apply the parking brake. See *Parking Brake* on page 2-27 if necessary.
Be ready to apply the regular brake immediately if the vehicle begins to move.
3. With the engine off, turn the key to the RUN position, but don't start the engine. Without applying the regular brake, try to move the shift lever out of PARK (P) with normal effort. If the shift lever moves out of PARK (P), your vehicle needs service.

Ignition Transaxle Lock Check

While parked, and with the parking brake set, try to turn the ignition key to LOCK in each shift lever position.

- The key should turn to LOCK only when the shift lever is in PARK (P).
- The key should come out only in LOCK.

Parking Brake and Automatic Transaxle Park (P) Mechanism Check

CAUTION:

When you are doing this check, your vehicle could begin to move. You or others could be injured and property could be damaged. Make sure there is room in front of your vehicle in case it begins to roll. Be ready to apply the regular brake at once should the vehicle begin to move.

Park on a fairly steep hill, with the vehicle facing downhill. Keeping your foot on the regular brake, set the parking brake.

- To check the parking brake's holding ability: With the engine running and transaxle in NEUTRAL (N), slowly remove foot pressure from the regular brake pedal. Do this until the vehicle is held by the parking brake only.
- To check the PARK (P) mechanism's holding ability: With the engine running, shift to PARK (P). Then release the parking brake followed by the regular brake.

Underbody Flushing Service

At least every spring, use plain water to flush any corrosive materials from the underbody. Take care to clean thoroughly any areas where mud and other debris can collect.

Part C: Periodic Maintenance Inspections

Listed in this part are inspections and services which should be performed at least twice a year (for instance, each spring and fall). *You should let your dealer's service department do these jobs. Make sure any necessary repairs are completed at once.*

Proper procedures to perform these services may be found in a service manual. See *Service Publications Ordering Information on page 7-10.*

Steering, Suspension and Front Drive Axle Boot and Seal Inspection

Inspect the front and rear suspension and steering system for damaged, loose or missing parts, signs of wear or lack of lubrication. Inspect the power steering lines and hoses for proper hook-up, binding, leaks, cracks, chafing, etc. Clean and then inspect the drive axle boot seals for damage, tears or leakage. Replace seals if necessary.

Exhaust System Inspection

Inspect the complete exhaust system. Inspect the body near the exhaust system. Look for broken, damaged, missing or out-of-position parts as well as open seams, holes, loose connections or other conditions which could cause a heat build-up in the floor pan or could let exhaust fumes into the vehicle. See *Engine Exhaust on page 2-31.*

Fuel System Inspection

Inspect the complete fuel system for damage or leaks.

Engine Cooling System Inspection

Inspect the hoses and have them replaced if they are cracked, swollen or deteriorated. Inspect all pipes, fittings and clamps; replace as needed. Clean the outside of the radiator and air conditioning condenser. To help ensure proper operation, a pressure test of the cooling system and pressure cap is recommended at least once a year.

Throttle System Inspection

Inspect the throttle pedal system for interference or binding, and for damaged or missing parts. Replace parts as needed. Replace any components that have high effort or excessive wear.

Brake System Inspection

Inspect the complete system. Inspect brake lines and hoses for proper hook-up, binding, leaks, cracks, chafing, etc. Inspect disc brake pads for wear and rotors for surface condition. Inspect other brake parts, including calipers, parking brake, etc. Check parking brake adjustment. You may need to have your brakes inspected more often if your driving habits or conditions result in frequent braking.

Part D: Recommended Fluids and Lubricants

Fluids and lubricants identified below by name, part number or specification may be obtained from your dealer.

Usage	Fluid/Lubricant
Engine Oil	Engine oil which meets GM Standard GM6094M and displays the American Petroleum Institute Certified for Gasoline Engines starburst symbol. To determine the proper viscosity for your vehicle's engine, see <i>Engine Oil on page 5-16</i> .
Engine Coolant	50/50 mixture of clean, drinkable water and use only DEX-COOL [®] Coolant. See <i>Engine Coolant on page 5-26</i> .
Hydraulic Brake System	Delco Supreme 11 Brake Fluid or equivalent DOT-3 brake fluid.
Windshield Washer Solvent	GM Optikleen [®] Washer Solvent or equivalent.
Power Steering System	GM Power Steering Fluid (GM Part No. U.S. 89021184, in Canada 89021186, or equivalent).

Usage	Fluid/Lubricant
Automatic Transaxle	DEXRON [®] -III Automatic Transmission Fluid.
Key Lock Cylinders	Multi-Purpose Lubricant, Superlube (GM Part No. U.S. 12346241, in Canada 10953474, or equivalent).
Supercharger	Supercharger Oil (GM Part No. U.S. 12345982, in Canada 10953513). See <i>Supercharger Oil on page 5-21</i> .
Hood Latch Assembly, Secondary Latch, Pivots, Spring Anchor and Release Pawl	Lubriplate Lubricant Aerosol (GM Part No. U.S. 12346293, in Canada 992723, or equivalent) or lubricant meeting requirements of NLGI #2, Category LB or GC-LB.
Hood and Door Hinges	Multi-Purpose Lubricant, Superlube (GM Part No. U.S. 12346241, in Canada 10953474, or equivalent).
Weatherstrip Conditioning	Dielectric Silicone Grease (GM Part No. U.S. 12345579, in Canada 10953014, or equivalent).

Part E: Maintenance Record

After the scheduled services are performed, record the date, odometer reading and who performed the service and any additional information from "Owner Checks and Services" or "Periodic Maintenance" on the following record pages. Also, you should retain all maintenance receipts.

Maintenance Record

Date	Odometer Reading	Serviced By	Maintenance Record

Maintenance Record (cont'd)

Date	Odometer Reading	Serviced By	Maintenance Record

Section 7 Customer Assistance Information

Customer Assistance Information	7-2	Reporting Safety Defects	7-9
Customer Satisfaction Procedure	7-2	Reporting Safety Defects to the United States	
Online Owner Center	7-3	Government	7-9
Customer Assistance for Text Telephone		Reporting Safety Defects to the Canadian	
(TTY) Users	7-4	Government	7-10
Customer Assistance Offices	7-4	Reporting Safety Defects to	
GM Mobility Program for Persons with		General Motors	7-10
Disabilities	7-5	Service Publications Ordering Information	7-10
Roadside Assistance Program	7-6		
Courtesy Transportation	7-7		

Customer Assistance Information

Customer Satisfaction Procedure

Your satisfaction and goodwill are important to your dealer and to Pontiac. Normally, any concerns with the sales transaction or the operation of your vehicle will be resolved by your dealer's sales or service departments. Sometimes, however, despite the best intentions of all concerned, misunderstandings can occur. If your concern has not been resolved to your satisfaction, the following steps should be taken:

STEP ONE: Discuss your concern with a member of dealership management. Normally, concerns can be quickly resolved at that level. If the matter has already been reviewed with the sales, service or parts manager, contact the owner of the dealership or the general manager.

STEP TWO: If after contacting a member of dealership management, it appears your concern cannot be resolved by the dealership without further help, contact the Pontiac Customer Assistance Center by calling 1-800-762-2737. In Canada, contact GM of Canada Customer Communication Centre in Oshawa by calling 1-800-263-3777 (English) or 1-800-263-7854 (French).

We encourage you to call the toll-free number in order to give your inquiry prompt attention. Please have the following information available to give the Customer Assistance Representative:

- Vehicle Identification Number (This is available from the vehicle registration or title, or the plate at the top left of the instrument panel and visible through the windshield.)
- Dealership name and location
- Vehicle delivery date and present mileage

When contacting Pontiac, please remember that your concern will likely be resolved at a dealer's facility. That is why we suggest you follow Step One first if you have a concern.

STEP THREE: Both General Motors and your dealer are committed to making sure you are completely satisfied with your new vehicle. However, if you continue to remain unsatisfied after following the procedure outlined in Steps One and Two, you should file with the BBB Auto Line Program to enforce any additional rights you may have. Canadian owners refer to your Warranty and Owner Assistance Information booklet for information on the Canadian Motor Vehicle Arbitration Plan (CAMVAP).

The BBB Auto Line Program is an out of court program administered by the Council of Better Business Bureaus to settle automotive disputes regarding vehicle repairs or the interpretation of the New Vehicle Limited Warranty. Although you may be required to resort to this informal dispute resolution program prior to filing a court action, use of the program is free of charge and your case will generally be heard within 40 days. If you do not agree with the decision given in your case, you may reject it and proceed with any other venue for relief available to you.

You may contact the BBB Auto Line Program using the toll-free telephone number or write them at the following address:

BBB Auto Line Program
Council of Better Business Bureaus, Inc.
4200 Wilson Boulevard
Suite 800
Arlington, VA 22203-1804
Telephone: 1-800-955-5100

This program is available in all 50 states and the District of Columbia. Eligibility is limited by vehicle age, mileage and other factors. General Motors reserves the right to change eligibility limitations and/or discontinue its participation in this program.

Online Owner Center

The Owner Center is a resource for your GM ownership needs. You can find your specific vehicle information all in one place.

The Owner Center allows you to:

- Get e-mail service reminders.
- Access information about your specific vehicle, including tips and videos and an electronic version of this owner's manual. (United States only)
- Keep track of your vehicle's service history and maintenance schedule.
- Find GM dealers for service nationwide.
- Receive special promotions and privileges only available to members. (United States only)

Refer to the web for updated information.

To register your vehicle, visit www.MyGMLink.com. (United States) or My GM Canada within www.gmcanada.com (Canada).

Customer Assistance for Text Telephone (TTY) Users

To assist customers who are deaf, hard of hearing, or speech-impaired and who use Text Telephones (TTYs), Pontiac has TTY equipment available at its Customer Assistance Center. Any TTY user can communicate with Pontiac by dialing: 1-800-833-PONT (7668). (TTY users in Canada can dial 1-800-263-3830.)

Customer Assistance Offices

Pontiac encourages customers to call the toll-free number for assistance. If a U.S. customer wishes to write to Pontiac, the letter should be addressed to Pontiac's Customer Assistance Center.

United States – Customer Assistance

Pontiac-GMC Customer Assistance Center
P.O. Box 33172
Detroit, MI 48232-5172

1-800-762-2737 or
1-800-833-7668 (For Text Telephone devices (TTYs))
Roadside Assistance: 1-800-ROADSIDE (762-3743)
Fax Number: 313-381-0022

From Puerto Rico:
1-800-496-9992 (English)
1-800-496-9993 (Spanish)
Fax Number: 313-381-0022

From U.S. Virgin Islands:
1-800-496-9994
Fax Number: 313-381-0022

Canada – Customer Assistance

General Motors of Canada Limited
Customer Communication Centre, 163-005
1908 Colonel Sam Drive
Oshawa, Ontario L1H 8P7

1-800-263-3777 (English)
1-800-263-7854 (French)
1-800-263-3830 (For Text Telephone devices (TTYs))
Roadside Assistance: 1-800-268-6800

Overseas – Customer Assistance

Please contact the local General Motors Business Unit.

Mexico, Central America and Caribbean Islands/Countries (Except Puerto Rico and U.S. Virgin Islands) – Customer Assistance

General Motors de Mexico, S. de R.L. de C.V.
Customer Assistance Center
Paseo de la Reforma # 2740
Col. Lomas de Bezares
C.P. 11910, Mexico, D.F.
01-800-508-0000
Long Distance: 011-52-53 29 0 800

GM Mobility Program for Persons with Disabilities

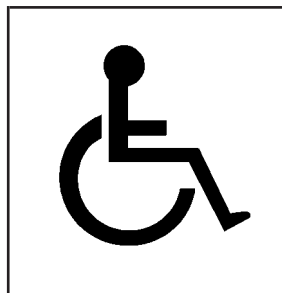

This program, available to qualified applicants, can reimburse you up to \$1,000 toward aftermarket driver or passenger adaptive equipment you may require for your vehicle (hand controls, wheelchair/scooter lifts, etc.).

This program can also provide you with free resource information, such as area driver assessment centers and mobility equipment installers. The program is available for a limited period of time from the date of vehicle purchase/lease. See your dealer for more details or call the GM Mobility Assistance Center at 1-800-323-9935. Text telephone (TTY) users, call 1-800-833-9935.

GM of Canada also has a Mobility Program. Call 1-800-GM-DRIVE (463-7483) for details. All TTY users call 1-800-263-3830.

Roadside Assistance Program

Security While You Travel

1-800-ROADSIDE (1-800-762-3743)

As the proud owner of a new Pontiac vehicle, you are automatically enrolled in the Pontiac Roadside Assistance program. This value-added service is intended to provide you with peace of mind as you drive in the city or travel the open road.

Pontiac's Roadside Assistance toll-free number is staffed by a team of technically trained advisors, who are available 24 hours a day, 365 days a year.

We take anxiety out of uncertain situations by providing minor repair information over the phone or making arrangements to tow your vehicle to the nearest Pontiac dealer.

We will provide the following services for 3 years/36,000 miles (60 000 km), at no expense to you:

- Fuel delivery
- Lock-out service (identification required)
- Tow to nearest dealership for warranty service
- Change a flat tire
- Jump starts

We have quick, easy access to telephone numbers of the following additional services depending on your needs:

- Hotels
- Glass replacement
- Tire repair facilities
- Rental vehicle or taxis
- Airports or train stations
- Police, fire departments or hospitals

In many instances, mechanical failures are covered under Pontiac's comprehensive warranty. However, when other services are utilized, our advisors will explain any payment obligations you might incur.

For prompt and efficient assistance when calling, please provide the following information to give the advisor:

- Location of vehicle
- Telephone number of your location
- Vehicle model, year and color
- Mileage of vehicle
- Vehicle Identification Number (VIN)
- Vehicle license plate number

Pontiac reserves the right to limit services or reimbursement to an owner or driver when, in Pontiac's judgement, the claims become excessive in frequency or type of occurrence.

While we hope you never have the occasion to use our service, it is added security while traveling for you and your family. Remember, we're only a phone call away. Pontiac Roadside Assistance: 1-800-ROADSIDE or 1-800-762-3743, text telephone (TTY) users, call 1-888-889-2438.

Canadian Roadside Assistance

Vehicles purchased in Canada have an extensive Roadside Assistance program accessible from anywhere in Canada or the United States. Please refer to the Warranty and Owner Assistance Information book.

Courtesy Transportation

Pontiac has always exemplified quality and value in its offering of motor vehicles. To enhance your ownership experience, we and our participating dealers are proud to offer Courtesy Transportation, a customer support program for new vehicles.

The Courtesy Transportation program is offered to retail purchase/lease customers in conjunction with the Bumper-to-Bumper coverage provided by the New Vehicle Limited Warranty. Several transportation options are available when warranty repairs are required. This will reduce your inconvenience during warranty repairs.

Plan Ahead When Possible

When your vehicle requires warranty service, you should contact your dealer and request an appointment. By scheduling a service appointment and advising your service consultant of your transportation needs, your dealer can help minimize your inconvenience.

If your vehicle cannot be scheduled into the service department immediately, keep driving it until it can be scheduled for service, unless, of course, the problem is safety-related. If it is, please call your dealership, let them know this, and ask for instructions.

If the dealer requests that you simply drop the vehicle off for service, you are urged to do so as early in the work day as possible to allow for same day repair.

Transportation Options

Warranty service can generally be completed while you wait. However, if you are unable to wait Pontiac helps minimize your inconvenience by providing several transportation options. Depending on the circumstances, your dealer can offer you one of the following:

Shuttle Service

Participating dealers can provide you with shuttle service to get you to your destination with minimal interruption of your daily schedule. This includes a one way shuttle ride to a destination up to 10 miles from the dealership.

Public Transportation or Fuel Reimbursement

If your vehicle requires overnight warranty repairs, reimbursement up to \$30 per day (five days maximum) may be available for the use of public transportation such as taxi or bus. In addition, should you arrange transportation through a friend or relative, reimbursement for reasonable fuel expenses up to \$10 per day (five day maximum) may be available. Claim amounts should reflect actual costs and be supported by original receipts.

Courtesy Rental Vehicle

When your vehicle is unavailable due to overnight warranty repairs, your dealer may arrange to provide you with a courtesy rental vehicle or reimburse you for a rental vehicle you obtained, at actual cost, up to a maximum of \$30.00 per day supported by receipts. This requires that you sign and complete a rental agreement and meet state, local and rental vehicle provider requirements. Requirements vary and may include minimum age requirements, insurance coverage, credit card, etc. You are responsible for fuel usage charges and may also be responsible for taxes, levies, usage fees, excessive mileage or rental usage beyond the completion of the repair.

Generally it is not possible to provide a like-vehicle as a courtesy rental.

Additional Program Information

Courtesy Transportation is available during the Bumper-to-Bumper warranty coverage period, but it *is not* part of the New Vehicle Limited Warranty. A separate booklet entitled *Warranty and Owner Assistance Information* furnished with each new vehicle provides detailed warranty coverage information.

Courtesy Transportation is available only at participating dealers and all program options, such as shuttle service, may not be available at every dealer. Please contact your dealer for specific information about availability. All Courtesy Transportation arrangements will be administered by appropriate dealer personnel.

Canadian Vehicles: For warranty repairs during the Complete Vehicle Coverage period of the General Motors of Canada New Vehicle Limited warranty, alternative transportation may be available under the Courtesy Transportation Program. Please consult your dealer for details.

General Motors reserves the right to unilaterally modify, change or discontinue Courtesy Transportation at any time and to resolve all questions of claim eligibility pursuant to terms and conditions described herein at its sole discretion.

Reporting Safety Defects

Reporting Safety Defects to the United States Government

If you believe that your vehicle has a defect which could cause a crash or could cause injury or death, you should immediately inform the National Highway Traffic Safety Administration (NHTSA), in addition to notifying General Motors.

If NHTSA receives similar complaints, it may open an investigation, and if it finds that a safety defect exists in a group of vehicles, it may order a recall and remedy campaign. However, NHTSA cannot become involved in individual problems between you, your dealer or General Motors.

To contact NHTSA, you may either call the Auto Safety Hotline toll-free at 1-800-424-9393 (or 366-0123 in the Washington, D.C. area) or write to:

NHTSA, U.S. Department of Transportation
Washington, D.C. 20590

You can also obtain other information about motor vehicle safety from the hotline.

Reporting Safety Defects to the Canadian Government

If you live in Canada, and you believe that your vehicle has a safety defect, you should immediately notify Transport Canada, in addition to notifying General Motors of Canada Limited. You may write to:

Transport Canada
330 Sparks Street
Tower C
Ottawa, Ontario K1A 0N5

Reporting Safety Defects to General Motors

In addition to notifying NHTSA (or Transport Canada) in a situation like this, we certainly hope you'll notify us. Please call us at 1-800-762-2737, or write:

Pontiac-GMC Customer Assistance Center
P.O. Box 33172
Detroit, MI 48232-5172

In Canada, please call us at 1-800-263-3777 (English) or 1-800-263-7854 (French). Or, write:

General Motors of Canada Limited
Customer Communication Centre, 163-005
1908 Colonel Sam Drive
Oshawa, Ontario L1H 8P7

Service Publications Ordering Information

Service Manuals

Service Manuals have the diagnosis and repair information on engines, transmission, axle, suspension, brakes, electrical, steering, body, etc.

RETAIL SELL PRICE: \$120.00

Transmission, Transaxle, Transfer Case Unit Repair Manual

This manual provides information on unit repair service procedures, adjustments, and specifications for GM transmissions, transaxles, and transfer cases.

RETAIL SELL PRICE: \$50.00

Service Bulletins

Service Bulletins give technical service information needed to knowledgeable service General Motors cars and trucks. Each bulletin contains instructions to assist in the diagnosis and service of your vehicle.

In Canada, information pertaining to Product Service Bulletins can be obtained by contacting your General Motors dealer or by calling 1-800-GM-DRIVE (1-800-463-7483).

Owner's Information

Owner publications are written specifically for owners and intended to provide basic operational information about the vehicle. The owner's manual will include the Maintenance Schedule for all models.

In-Portfolio: Includes a Portfolio, Owner's Manual, and Warranty Booklet.

RETAIL SELL PRICE: \$35.00

Without Portfolio: Owner's Manual only.

RETAIL SELL PRICE: \$25.00

Current and Past Model Order Forms

Service Publications are available for current and past model GM vehicles. To request an order form, please specify year and model name of the vehicle.

ORDER TOLL FREE: 1-800-551-4123 Monday-Friday 8:00 AM - 6:00 PM Eastern Time

For Credit Card Orders Only
(VISA-MasterCard-Discover), visit Helm, Inc. on the
World Wide Web at: www.helminc.com

Or you can write to:

Helm, Incorporated
P. O. Box 07130
Detroit, MI 48207

Prices are subject to change without notice and without incurring obligation. Allow ample time for delivery.

Note to Canadian Customers: All listed prices are quoted in U.S. funds. Canadian residents are to make checks payable in U.S. funds.

 **NOTES**

A

A/C OFF FOR ENGINE PROTECTION	3-65	Appearance Care	5-90
Accessory Power Outlets	3-23	Care of Safety Belts	5-93
Adding Washer Fluid	5-44	Chemical Paint Spotting	5-96
Additional Program Information	7-9	Cleaning the Inside of Your Vehicle	5-90
Additives, Fuel	5-6	Cleaning the Outside of Your Vehicle	5-93
Add-On Electrical Equipment	5-99	Finish Damage	5-95
Adjusting the Speakers		GM Vehicle Care/Appearance Materials	5-96
(Balance/Fade)	3-92, 3-103, 3-117	Sheet Metal Damage	5-95
Air Bag		Underbody Maintenance	5-96
Readiness Light	3-34	Weatherstrips	5-93
Air Bag Systems	1-48	Arming Confirmation	2-15
How Does an Air Bag Restrain?	1-54	Arming with the Power Lock Switch	2-14
Servicing Your Air Bag-Equipped Vehicle	1-56	Arming with the Remote Keyless	
What Makes an Air Bag Inflate?	1-53	Entry Transmitter	2-15
What Will You See After an		Ashtray	3-24
Air Bag Inflates?	1-54	Assist Handles	2-38
When Should an Air Bag Inflate?	1-53	Audio System(s)	3-88
Where Are the Air Bags?	1-50	Audio Steering Wheel Controls	3-129
Air Cleaner/Filter, Engine	5-22	Backglass Antenna	3-132
Air Conditioning	3-27	Care of Your Cassette Tape Player	3-130
AJAR	3-66	Care of Your CD Player	3-131
AM	3-130	Care of Your CDs	3-131
Antenna, Backglass	3-132	Radio with Cassette and CD	3-100
Antenna, XM™ Satellite Radio		Radio with CD	3-89
Antenna System	3-132	Radio with Six-Disc CD	3-114
Anti-lock Brake System (ABS)	4-7	Setting the Time	3-88
Anti-Lock Brake, System Warning Light	3-37	Theft-Deterrent Feature	3-128
		Understanding Radio Reception	3-130
		XM™ Satellite Radio Antenna System	3-132

Automatic Transaxle	5-24
Fluid	5-24
Operation	2-22
Automatic Transaxle Check	6-11
Automatic Transaxle Shift Lock Control System Check	6-12

B

Backglass Antenna	3-132
Backing Up	4-41
Base Level DIC	3-45
Battery	5-48
Battery Replacement	2-6
Battery Run-Down Protection	3-19
Before Leaving on a Long Trip	4-25
Body Lubrication Service	6-11
Brake	
Parking	2-27
System Inspection	6-15
System Warning Light	3-36
Brake Fluid	5-45
Brake Wear	5-47
Brakes	5-45
Braking	4-6
Braking in Emergencies	4-9
Break-In, New Vehicle	2-18

Bulb Replacement	5-59
Back-Up Lamps	5-65
Center High-Mounted Stoplamp (CHMSL)	5-64
Front Turn Signal, Parking and Fog Lamps	5-62
Halogen Bulbs	5-59
Headlamp Aiming	5-56
Headlamps and Sidemarkers Lamps	5-60
Replacement Bulbs	5-66
Taillamps, Turn Signal, and Stoplamps	5-64
Buying New Tires	5-73

C

California Fuel	5-5
Canada – Customer Assistance	7-4
Canadian Owners	ii
Canadian Roadside Assistance	7-7
Capacities and Specifications	5-104
Carbon Monoxide	4-28, 4-37, 2-10, 2-31
Care of	
Safety Belts	5-93
Your Cassette Tape Player	3-130
Your CD Player	3-131
Your CDs	3-131
Care of the HUD	3-22
Cassette Tape Messages	3-110
Cassette Tape Player Service	6-10
CD Adapter Kits	3-111
Center Console Storage Area	2-37

Center High-Mounted Stoplamp (CHMSL)	5-64	Cigarette Lighter	3-24
Chains, Tires	5-77	Cleaning	
CHANGE OIL SOON	3-66	Inside of Your Vehicle	5-90
CHARGING SYSTEM FAILURE	3-67	Outside of Your Vehicle	5-93
Check		Underbody Maintenance	5-96
Engine Light	3-40	Weatherstrips	5-93
Check Engine Light	3-40	Cleaning Aluminum Wheels	5-95
CHECK GAS CAP	3-67	Cleaning Exterior Lamps/Lenses	5-94
CHECK TIRE PRESSURE	3-68	Cleaning Fabric/Carpet	5-90
Checking Coolant	5-28	Cleaning Glass Surfaces	5-92
Checking Engine Oil	5-16	Cleaning Interior Plastic Components	5-92
Checking Things Under the Hood	5-10	Cleaning Leather	5-92
Checking Your Restraint Systems	1-56	Cleaning the Top of the Instrument Panel	5-92
Chemical Paint Spotting	5-96	Cleaning Tires	5-95
Child Restraints		Cleaning Vinyl	5-92
Child Restraint Systems	1-35	Cleaning Windshield and Wiper Blades	5-94
Infants and Young Children	1-32	Climate Control System	3-25
Lower Anchorages and Top Tethers for		Outlet Adjustment	3-29
Children (LATCH System)	1-41	Compact Disc Messages	3-99, 3-113, 3-128
Older Children	1-29	Compact Spare Tire	5-88, 5-89
Securing a Child Restraint Designed for		Content Theft-Deferrant	2-14
the LATCH System	1-43	Control of a Vehicle	4-6
Securing a Child Restraint in a Rear		Convenience Net	2-38
Seat Position	1-43	Coolant	
Securing a Child Restraint in the Right		Engine Temperature Gage	3-39
Front Seat Position	1-45	Engine Temperature Warning Light	3-39
Top Strap	1-39	Heater, Engine	2-20
Top Strap Anchor Location	1-40	Cooling System	5-32
Where to Put the Restraint	1-38	Courtesy Lamps	3-17

Cruise Control	3-8
Cruise Control Lever	3-8
CRUISE SET	3-69
Current and Past Model Order Forms	7-11
Customer Assistance Information	
Courtesy Transportation	7-7
Customer Assistance for Text	
Telephone (TTY) Users	7-4
Customer Assistance Offices	7-4
Customer Satisfaction Procedure	7-2
GM Mobility Program for Persons with	
Disabilities	7-5
Reporting Safety Defects to General Motors	7-10
Reporting Safety Defects to the	
Canadian Government	7-10
Reporting Safety Defects to the	
United States Government	7-9
Roadside Assistance Program	7-6
Service Publications Ordering Information	7-10

D

Daytime Running Lamps	3-15
Defensive Driving	4-2
Defogging and Defrosting	3-26
Delayed Entry Lighting	3-17
Delayed Exit Lighting	3-18
DELAYED LOCKING	3-69
Dinghy Towing	4-34

Disarming with the Remote Keyless Entry	
Transmitter	2-15
Disarming with Your Key	2-15
Doing Your Own Service Work	5-3
Dolly Towing	4-34
Door	
Last Door Closed Locking	2-8
Locks	2-7
Power Door Locks	2-8
Programmable Automatic Door Locks	2-9
Driver	
Position, Safety Belt	1-15
Driver Information Center (DIC)	3-45
DIC Controls and Displays	3-45
DIC Warnings and Messages	3-65
Driving	
At Night	4-19
City	4-23
Defensive	4-2
Drunken	4-3
Freeway	4-24
Hill and Mountain Roads	4-26
In Rain and on Wet Roads	4-20
Winter	4-28
Driving On Grades	4-42
Driving on Snow or Ice	4-29
Driving Through Deep Standing Water	4-22
Driving Through Flowing Water	4-22
Driving with a Trailer	4-41

E

Electrical System	
Add-On Equipment	5-99
Fuses and Circuit Breakers	5-99
Headlamp Wiring	5-99
Power Windows and Other Power Options	5-99
Windshield Wiper Fuses	5-99
Emergency Trunk Release Handle	2-11
Emissions Inspection and Maintenance Programs	3-42
Engine	
Air Cleaner/Filter	5-22
Battery	5-48
Check and Service Engine Soon Light	3-40
Coolant Heater	2-20
Coolant Temperature Gage	3-39
Coolant Temperature Warning Light	3-39
Coolant	5-26
Cooling System Inspection	6-15
Engine Compartment Overview	5-12
Exhaust	2-31
Oil	5-16
Overheating	5-29
Starting	2-19
Supercharger Oil	5-21
Engine Coolant Level Check	6-10
Engine Cooling When Trailer Towing	4-44
Engine Oil Additives	5-19

Engine Oil Level Check	6-10
Engine Oil Scheduled Maintenance	6-5
Enhanced Traction System (ETS)	4-11
Warning Light	3-38
Entry Lighting	3-17
Express-Down Window	2-13
Extender, Safety Belt	1-28
Exterior Lamp Control Lever	3-12
Exterior Lamps	3-12
Exterior Lighting Battery Saver	3-16

F

Fan	3-25
Filter	
Engine Air Cleaner	5-22
Finding a PTY Station (RDS and XM™)	3-93, 3-104, 3-118
Finding a Station	3-91, 3-102, 3-116
Finish Care	5-94
Finish Damage	5-95
Flash-To-Pass Feature	3-14
Flat Tire	5-78
Flat Tire, Changing	5-78
Fluid	
Automatic Transaxle	5-24
Power Steering	5-42
Windshield Washer	5-43
FM Stereo	3-130
Fog Lamp Light	3-44

Folding Rear Seat	1-8
Following Distance	4-41
Footnotes	6-5
Front Reading Lamps	3-18
Front Seat Storage Net	2-37
Front Turn Signal, Parking and Fog Lamps	5-62
Fuel	

Additives	5-6
California Fuel	5-5
Filling a Portable Fuel Container	5-10
Filling Your Tank	5-7
Fuels in Foreign Countries	5-7
Gage	3-44
Gasoline Octane	5-4
Gasoline Specifications	5-5
System Inspection	6-14

Fuses	
Fuses and Circuit Breakers	5-99
Windshield Wiper	5-99

G

Gage	
Engine Coolant Temperature	3-39
Fuel	3-44
Speedometer	3-33
Tachometer	3-33
Gasoline	5-4
Octane	5-4
Specifications	5-5

Glove Box	2-36
GM Mobility Program for Persons with Disabilities	7-5

H

Hazard Warning Flashers	3-4
Head Restraints	1-7
Headlamp	
Aiming	5-56
Headlamp Wiring	5-99
Headlamps	
Bulb Replacement	5-59
Front Turn Signal, Parking and Fog Lamps	5-62
Halogen Bulbs	5-59
Headlamps and Sidemarkers Lamps	5-60
HEADLAMPS SUGGESTED	3-70
Head-Up Display (HUD)	3-19
Heated Seats	1-5
Highbeam On Light	3-44
Highway Hypnosis	4-26
Hill and Mountain Roads	4-26
Hitches	4-40
Hood	
Checking Things Under	5-10
Release	5-11
Horn	3-5
HOT COOLANT	3-70
HOT ENGINE OIL. REDUCE SPEED	3-71

HOT TRANS FLUID	3-72
How to Add Coolant to the Coolant Recovery Tank	5-35
How to Add Coolant to the Radiator	5-37
How to Add Fluid	5-26
How to Check and Add Oil	5-22
How to Check Power Steering Fluid	5-42
How to Check	5-24, 5-69
How to Use This Manual	ii
How to Wear Safety Belts Properly	1-15
Hydroplaning	4-22

I

If No Steam is Coming From Your Engine	5-31
If Steam Is Coming From Your Engine	5-30
If the HUD Image Is Not Clear	3-22
If the Light is Flashing	3-41
If the Light Is On Steady	3-41
If You Are Stuck in Sand, Mud, Ice or Snow	4-32
If You Can't See the HUD Image When the Ignition Is On	3-22
If You Do Decide To Pull A Trailer	4-38
If You're Caught in a Blizzard	4-30
Ignition Positions	2-18
Ignition Transaxle Lock Check	6-13
Infants and Young Children, Restraints	1-32
Inflation -- Tire Pressure	5-69

Inspection	
Brake System	6-15
Engine Cooling System	6-15
Exhaust System	6-14
Fuel System	6-14
Part C - Periodic Maintenance	6-14
Steering, Suspension and Front Drive Axle	
Boot and Seal	6-14
Throttle System	6-15
Instrument Panel	
Cluster	3-32
Overview	3-2
Interior Lamps	3-16
Instrument Panel Brightness	3-16
Instrument Panel Fuse Block	5-100

J

Jump Starting	5-49
---------------------	------

K

KEY FOB BATTERY LOW	3-73
KEY IN IGNITION	3-73
Key Lock Cylinders Service	6-11
Keyless Entry System	2-4
Keys	2-2

L

Lamps	
Exterior	3-12
Interior	3-16
Lap-Shoulder Belt	1-15, 1-24
Last Door Closed Locking	2-8
LATCH System	
Child Restraints	1-41
Securing a Child Restraint Designed for the LATCH System	1-43
Leaving Your Vehicle	2-9
Leaving Your Vehicle With the Engine Running	2-29
LEFT FRONT TURN LAMP OUT	3-74
LEFT REAR TURN LAMP OUT	3-74
Light	
Air Bag Readiness	3-34
Anti-Lock Brake System Warning	3-37
Brake System Warning	3-36
Engine Coolant Temperature Warning	3-39
Enhanced Traction System (ETS) Warning Light	3-38
Fog Lamp	3-44
Highbeam On	3-44
Malfunction Indicator	3-40
Oil Pressure	3-43
Safety Belt Reminder	3-34
TCS Warning Light	3-38

Light (cont.)	
Traction Control System (TCS) Warning	3-38
Up-Shift	3-35
Loading Your Vehicle	4-35
Lockout Protection	2-9
Locks	
Door	2-7
Last Door Closed Locking	2-8
Leaving Your Vehicle	2-9
Lockout Protection	2-9
Power Door	2-8
Programmable Automatic Door Locks	2-9
Loss of Control	4-18
LOW BRAKE FLUID	3-75
LOW FUEL	3-75
LOW OIL LEVEL	3-76
LOW OIL PRESSURE	3-76
LOW WASHER FLUID	3-77
Lumbar	
Power Controls	1-5

M

Maintenance, Normal Replacement Parts	5-105
Maintenance Schedule	
At Each Fuel Fill	6-10
At Least Once a Month	6-10
At Least Once a Year	6-11
At Least Twice a Year	6-11

Maintenance Schedule (cont.)	
Brake System Inspection	6-15
Engine Cooling System Inspection	6-15
Exhaust System Inspection	6-14
Fuel System Inspection	6-14
How This Section is Organized	6-3
Introduction	6-2
Maintenance Requirements	6-2
Part A - Scheduled Maintenance Services	6-4
Part B - Owner Checks and Services	6-10
Part C - Periodic Maintenance Inspections	6-14
Part D - Recommended Fluids and Lubricants	6-16
Part E - Maintenance Record	6-17
Scheduled Maintenance	6-5
Steering, Suspension and Front Drive Axle Boot and Seal Inspection	6-14
Throttle System Inspection	6-15
Using Your	6-4
Your Vehicle and the Environment	6-2
Maintenance When Trailer Towing	4-44
Making Turns	4-42
Malfunction Indicator Light	3-40
Manual Climate Control System	3-25
Manual Seats	1-2
Matching Transmitter(s) to Your Vehicle	2-5
Message DIC Warnings and Messages	3-65

Mexico, Central America and Caribbean Islands/Countries (Except Puerto Rico and U.S. Virgin Islands) – Customer Assistance	7-5
Mirrors	
Manual Rearview Mirror	2-33
Manual Rearview Mirror with OnStar®	2-33
Outside Convex Mirror	2-34
Outside Power Mirrors	2-34
Mode	3-25
MyGMLink.com	7-3

N

New Vehicle Break-In	2-18
Normal Maintenance Replacement Parts	5-105

O

Odometer	3-33
Off-Road Recovery	4-16
Oil	
Engine	5-16
Pressure Light	3-43
Supercharger, Engine	5-21
Older Children, Restraints	1-29
Online Owner Center	7-3
OnStar® Personal Calling	2-36
OnStar® Services	2-35

OnStar [®] System	2-35
OnStar [®] Virtual Advisor	2-36
Other Warning Devices	3-5
Outlet Adjustment	3-29
Outside	
Convex Mirror	2-34
Power Mirrors	2-34
Overhead Console Reading Lamps	3-18
Overhead Console	2-36
Overheated Engine Protection Operating Mode	5-30
Overseas – Customer Assistance	7-5
Owners, Canadian	ii
Owner's Information	7-11

P

PARK LAMPS ON	3-78
Park (P)	
Shifting Into	2-28
Shifting Out of	2-30
Parking	
Brake	2-27
Over Things That Burn	2-30
Parking Brake and Automatic Transaxle	
Park (P) Mechanism Check	6-13
PARKING BRAKE ON	3-78
Parking on Hills	4-43

Part A - Scheduled Maintenance Services	6-4
Part B - Owner Checks and Services	6-10
Part C - Periodic Maintenance Inspections	6-14
Part D - Recommended Fluids and Lubricants	6-16
Part E - Maintenance Record	6-17
Passing	4-16, 4-41
PASS-Key [®] III	2-15
PASS-Key [®] III Operation	2-16
Performance Shifting with TAP-Shift [™]	2-25
Plan Ahead When Possible	7-7
Playing a Cassette Tape	3-109
Playing a Compact Disc	3-98, 3-111, 3-123
Playing a Specific Loaded	
Compact Disc	3-124
Playing the Radio	3-90, 3-101, 3-115
Power	
Accessory Outlets	3-23
Door Locks	2-8
Electrical System	5-99
Lumbar Controls	1-5
Seat	1-4
Steering Fluid	5-42
Windows	2-13
Power Steering	4-14
Pretensioners, Safety Belt	1-28
Programmable Automatic Door Locks	2-9

Q

Questions and Answers About Safety Belts 1-14

R

Radiator Pressure Cap 5-29
Radio Data System (RDS) 3-89, 3-100, 3-114
Radio Messages 3-95, 3-106
Radios 3-88
 Care of Your Cassette Tape Player 3-130
 Care of Your CD Player 3-131
 Care of Your CDs 3-131
 Radio with Cassette and CD 3-100
 Radio with CD 3-89
 Radio with Six-Disc CD 3-114
 Setting the Time 3-88
 Theft-Deterrent 3-128
 Understanding Reception 3-130
RDS Messages 3-94, 3-105, 3-120
READING LAMP ON 3-78
Rear Assist Handle Reading Lamps 3-18
Rear Safety Belt Comfort Guides 1-26
Rear Seat Passenger Positions 1-23
Rear Seat Passengers, Safety Belts 1-23
Rearview Mirror with OnStar® 2-33
Rearview Mirrors 2-33
Recirculation 3-28

Reclining Seatbacks 1-6
Recreational Vehicle Towing 4-33
REDUCED ENGINE POWER 3-79
Remote Keyless Entry System 2-4
Remote Keyless Entry System, Operation 2-5
Remote Trunk Release 2-10
Removing the Flat Tire and Installing the
 Spare Tire 5-82
Removing the Spare Tire and Tools 5-80
Removing Wheel Nut Caps 5-82
Replacement Bulbs 5-66
Replacing Brake System Parts 5-48
Replacing Restraint System Parts
 After a Crash 1-57
Reporting Safety Defects
 Canadian Government 7-10
 General Motors 7-10
 United States Government 7-9
Restraint System Check 6-11
 Checking Your Restraint Systems 1-56
 Replacing Restraint System Parts
 After a Crash 1-57
Restraint Systems
 Checking 1-56
 Replacing Parts 1-57
Retained Accessory Power (RAP) 2-19
Right Front Passenger Position, Safety Belts 1-23
RIGHT FRONT TURN LAMP OUT 3-79
RIGHT REAR TURN LAMP OUT 3-80

Roadside Assistance Program	7-6
Rocking Your Vehicle To Get It Out	4-33
Running Your Engine While You Are Parked	2-32

S

Safety Belt	
Pretensioners	1-28
Reminder Light	3-34
Safety Belts	
Care of	5-93
Driver Position	1-15
How to Wear Safety Belts Properly	1-15
Questions and Answers About Safety Belts	1-14
Rear Safety Belt Comfort Guides for	
Children and Small Adults	1-26
Rear Seat Passengers	1-23
Right Front Passenger Position	1-23
Safety Belt Extender	1-28
Safety Belt Use During Pregnancy	1-22
Safety Belts Are for Everyone	1-10
Safety Chains	4-40
Safety Warnings and Symbols	iii
Scheduled Maintenance	6-5
Seats	
Head Restraints	1-7
Heated Seats	1-5
Manual	1-2

Seats (cont.)	
Power Lumbar	1-5
Power Seat	1-4
Reclining Seatbacks	1-6
Split Folding Rear Seat	1-8
Securing a Child Restraint	
Designed for the LATCH System	1-43
Rear Seat Position	1-43
Right Front Seat Position	1-45
Security While You Travel	7-6
Service	5-3
Adding Equipment to the Outside	
of Your Vehicle	5-4
Doing Your Own Work	5-3
Engine Soon Light	3-40
Publications Ordering Information	7-10
SERVICE ABS SYSTEM	3-80
SERVICE BRAKE APPLY SENSOR	3-81
SERVICE BRAKE SYSTEM	3-81
Service Bulletins	7-10
Service Manuals	7-10
SERVICE PARK LAMPS	3-82
SERVICE STABILITY SYSTEM	3-83
SERVICE THEFT SYSTEM	3-83
SERVICE TRACTION SYSTEM	3-82
SERVICE VARIABLE EFFORT STEERING	3-84
SERVICE VEHICLE SOON	3-84
Setting Preset PTYs	
(RDS Only)	3-94, 3-105, 3-119
Setting Preset Stations	3-91, 3-102, 3-116

Setting the Time	3-88
Setting the Tone (Bass/Treble)	3-92, 3-103, 3-117
Sheet Metal Damage	5-95
Shifting Into Park (P)	2-28
Shifting Out of Park (P)	2-30
Shoulder Belt Height Adjuster	1-17
Skidding	4-18
Some Other Rainy Weather Tips	4-22
Special Fabric Cleaning Problems	5-91
Specifications, Capacities	5-104
Speedometer	3-33
Split Folding Rear Seat	1-8
Stabilitrak [®] Plus System	4-13
STABILITY CONTROL ACTIVE	3-85
STABILITY CONTROL OFF	3-85
Starter Switch Check	6-12
STARTING DISABLED DUE TO ELECTRONIC THROTTLE CONTROL	3-86
STARTING DISABLED DUE TO THEFT SYSTEM	3-86
Starting Your Engine	2-19
Steering	4-14
Steering in Emergencies	4-15
Steering, Suspension and Front Drive Axle Boot and Seal Inspection	6-14
Steering Tips	4-14
Steering Wheel Controls, Audio	3-129

Storage Areas	
Center Console Storage Area	2-37
Convenience Net	2-38
Front Seat Storage Net	2-37
Glove Box	2-36
Overhead Console	2-36
Storing the Flat Tire and Tools	5-87
Storing the Spare Tire and Tools	5-88
Stuck in Sand, Mud, Ice or Snow	4-32
Sun Visors	2-13
Sunglasses Storage Compartment	2-37
Sunroof	2-39

T

3800 V6 Engine	5-12
3800 V6 Supercharged Engine	5-14
Tachometer	3-33
Taillamps	
Turn Signal, and Stoplamps	5-64
TCS Warning Light	3-38
Temperature	3-27
THEFT SYSTEM NOT PROGRAMMED	3-86
Theft-Deterrent, Radio	3-128
Theft-Deterrent Systems	2-14
Content Theft-Deterrent	2-14
PASS-Key [®] III	2-15
PASS-Key [®] III Operation	2-16

Throttle System Inspection	6-15	Traction (cont.)	
Tilt Wheel	3-5	Enhanced Traction System (ETS)	
Tire Inflation Check	6-10	Warning Light	3-38
Tires	5-68	Stabilitrak® & Plus System	4-13
Buying New Tires	5-73	TRACTION CONTROL ACTIVE	3-87
Chains	5-77	TRACTION CONTROL OFF	3-87
Changing a Flat Tire	5-78	Trailer Brakes	4-40
Compact Spare Tire	5-89	Transaxle	
If a Tire Goes Flat	5-78	Fluid, Automatic	5-24
Inflation -- Tire Pressure	5-69	Transaxle Operation, Automatic	2-22
Inspection and Rotation	5-71	Transmission	
Pressure Monitor System	5-70	Up-Shift Light	3-35
Uniform Tire Quality Grading	5-74	Transmission, Transaxle, Transfer Case Unit	
Wheel Alignment and Tire Balance	5-75	Repair Manual	7-10
Wheel Replacement	5-75	Transportation Options	7-8
When It Is Time for New Tires	5-72	Trunk	2-10
To Use the Engine Coolant Heater	2-21	Trunk Assist Handle	2-11
Top Strap	1-39	Trunk Lock	2-10
Top Strap Anchor Location	1-40	Turn and Lane-Change Signals	3-14
Torque Lock	2-29	TURN SIGNAL ON	3-87
Total Weight on Your Vehicle's Tires	4-39	Turn Signals When Towing a Trailer	4-42
Towing			
Recreational Vehicle	4-33		
Towing a Trailer	4-37		
Your Vehicle	4-33		
Traction			
Control System (TCS)	4-10		
Control System Warning Light	3-38		
Enhanced Traction System (ETS)	4-11		

U

Underbody Flushing Service	6-13
Underhood Fuse Block	5-102
Understanding Radio Reception	3-130
Uniform Tire Quality Grading	5-74

United States – Customer Assistance	7-4
Uplevel DIC with Trip Computer	3-53
Up-Shift Light	3-35
Used Replacement Wheels	5-76
Using Cleaner on Fabric	5-91
Using Song List Mode	3-126

V

Variable Effort Steering	4-14
Vehicle	
Control	4-6
Damage Warnings	iv
Loading	4-35
Symbols	iv
Vehicle Identification	
Number (VIN)	5-98
Service Parts Identification Label	5-98
Vehicle Storage	5-48
Ventilation Adjustment	3-29
Visor Vanity Mirror	2-13
Visors	2-13

W

Warning Lights, Gages and Indicators	3-31
Warnings	3-65
DIC Warnings and Messages	3-65
Hazard Warning Flashers	3-4

Warnings (cont.)	
Other Warning Devices	3-5
Safety and Symbols	iii
Vehicle Damage	iv
Washing Your Vehicle	5-93
Weatherstrip Lubrication	6-11
Weight of the Trailer	4-38
Weight of the Trailer Tongue	4-39
What Kind of Engine Oil to Use	5-18
What Kind of Oil to Use	5-21
What to Do with Used Oil	5-21
What to Use	5-27, 5-43
Wheels	
Alignment and Tire Balance	5-75
Replacement	5-75
When to Add	5-43
When to Add Engine Oil	5-17
When to Change Engine Oil (GM Oil Life System)	5-20
When to Check	5-21, 5-69
When to Check and Change	5-24
When to Check Power Steering Fluid	5-42
When You Are Ready to Leave After Parking on a Hill	4-43
Where to Put the Restraint	1-38
Why Safety Belts Work	1-11
Window Lock-Out	2-13
Windows	2-12
Power	2-13

Windshield Washer	3-7
Fluid	5-43
Windshield Washer Fluid Level Check	6-10
Windshield Washer Lever	3-6
Windshield Wiper	
Blade Replacement	5-67
Fuses	5-99
Windshield Wipers	3-6
Winter Driving	4-28
Wiper Blade Check	6-11

X

XM™ Radio Satellite Service (USA Only)	3-101
XM™ Satellite Radio Antenna System	3-132
XM™ Satellite Radio Service (USA Only)	3-130
XM™ Radio Satellite Service (USA Only)	3-115
XM™ Radio Satellite Service (USA Only)	3-90

Y

Your Vehicle and the Environment	6-2
--	-----