

 PONTIAC

2003

GRAND PRIX

# The 2003 Pontiac Grand Prix Owner Manual

---

<b>Seats and Restraint Systems</b> .....	1-1	<b>Driving Your Vehicle</b> .....	4-1
Front Seats .....	1-2	Your Driving, the Road, and Your Vehicle .....	4-2
Safety Belts .....	1-7	Towing .....	4-33
Child Restraints .....	1-29	<b>Service and Appearance Care</b> .....	5-1
Supplemental Restraint System (SRS) .....	1-51	Service .....	5-3
Restraint System Check .....	1-58	Fuel .....	5-5
<b>Features and Controls</b> .....	2-1	Checking Things Under the Hood .....	5-10
Keys .....	2-3	Headlamp Aiming .....	5-59
Doors and Locks .....	2-8	Bulb Replacement .....	5-60
Windows .....	2-13	Windshield Wiper Blade Replacement .....	5-67
Theft-Deterrent Systems .....	2-15	Tires .....	5-68
Starting and Operating Your Vehicle .....	2-19	Appearance Care .....	5-88
Mirrors .....	2-33	Vehicle Identification .....	5-96
OnStar <sup>®</sup> System .....	2-38	Electrical System .....	5-97
Storage Areas .....	2-40	Capacities and Specifications .....	5-102
Sunroof .....	2-42	Normal Maintenance Replacement Parts .....	5-104
Vehicle Personalization .....	2-43	<b>Maintenance Schedule</b> .....	6-1
<b>Instrument Panel</b> .....	3-1	Maintenance Schedule .....	6-2
Instrument Panel Overview .....	3-2	<b>Customer Assistance Information</b> .....	7-1
Climate Controls .....	3-20	Customer Assistance Information .....	7-2
Warning Lights, Gages and Indicators .....	3-23	Reporting Safety Defects .....	7-9
Driver Information Center (DIC) .....	3-38	<b>Index</b> .....	1
Trip Computer .....	3-40		
Audio System(s) .....	3-44		

---



GENERAL MOTORS, GM, the GM Emblem, PONTIAC, the PONTIAC Emblem and the name GRAND PRIX are registered trademarks of General Motors Corporation.

This manual includes the latest information at the time it was printed. We reserve the right to make changes after that time without further notice. For vehicles first sold in Canada, substitute the name "General Motors of Canada Limited" for Pontiac Division whenever it appears in this manual.

Please keep this manual in your vehicle, so it will be there if you ever need it when you're on the road. If you sell the vehicle, please leave this manual in it so the new owner can use it.

Litho in U.S.A.  
Part No. 10325260 A First Edition

## Canadian Owners

You can obtain a French copy of this manual from your dealer or from:

Helm, Incorporated  
P.O. Box 07130  
Detroit, MI 48207

## How to Use This Manual

Many people read their owner's manual from beginning to end when they first receive their new vehicle. If you do this, it will help you learn about the features and controls for your vehicle. In this manual, you'll find that pictures and words work together to explain things.

## Index

A good place to look for what you need is the Index in back of the manual. It's an alphabetical list of what's in the manual, and the page number where you'll find it.

© Copyright General Motors Corporation 06/26/02  
All Rights Reserved

## Safety Warnings and Symbols

You will find a number of safety cautions in this book. We use a box and the word CAUTION to tell you about things that could hurt you if you were to ignore the warning.

 **CAUTION:**

**These mean there is something that could hurt you or other people.**

In the caution area, we tell you what the hazard is. Then we tell you what to do to help avoid or reduce the hazard. Please read these cautions. If you don't, you or others could be hurt.



You will also find a circle with a slash through it in this book. This safety symbol means "Don't," "Don't do this" or "Don't let this happen."

## Vehicle Damage Warnings

Also, in this book you will find these notices:

**Notice:** These mean there is something that could damage your vehicle.

A notice will tell you about something that can damage your vehicle. Many times, this damage would not be covered by your warranty, and it could be costly. But the notice will tell you what to do to help avoid the damage.

When you read other manuals, you might see CAUTION and NOTICE warnings in different colors or in different words.

You'll also see warning labels on your vehicle. They use the same words, CAUTION or NOTICE.









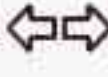

## Vehicle Symbols

Your vehicle has components and labels that use symbols instead of text. Symbols, used on your vehicle, are shown along with the text describing the operation or information relating to a specific component, control, message, gage or indicator.

If you need help figuring out a specific name of a component, gage or indicator reference the following topics:

- Seats and Restraint Systems in Section 1
- Features and Controls in Section 2
- Instrument Panel Overview in Section 3
- Climate Controls in Section 3
- Warning Lights, Gages and Indicators in Section 3
- Audio System(s) in Section 3
- Engine Compartment Overview in Section 5

These are some examples of vehicle symbols you may find on your vehicle:

CAUTION POSSIBLE INJURY		LATCH BOTH LAP AND SHOULDER BELTS TO PROTECT OCCUPANT DO NOT TWIST SAFETY BELT WHEN ATTACHING	 	MASTER LIGHTING SWITCH		ENGINE COOLANT TEMP		FUSE BOX ACCESS			
PROTECT EYES BY SHIELDING		FASTEN SEAT BELTS		AIR BAG		TURN SIGNALS		BATTERY CHARGING SYSTEM		ENGINE COOLANT FAN	
CAUSTIC BATTERY ACID COULD CAUSE BURNS		MOVE SEAT FULLY REARWARD SECURE CHILD SEAT		DO NOT INSTALL A REAR-FACING CHILD RESTRAINT IN THIS SEATING POSITION		PARKING LAMPS		BRAKE		FUEL	
AVOID SPARKS OR FLAMES		PULL BELT OUT COMPLETELY THEN SECURE CHILD SEAT		DO NOT INSTALL A FORWARD-FACING CHILD RESTRAINT IN THIS SEATING POSITION		HAZARD WARNING FLASHER		COOLANT		OWNER'S MANUAL	
SPARK OR FLAME COULD EXPLODE BATTERY		POWER WINDOW		DOOR LOCK UNLOCK		DAYTIME RUNNING LAMPS		ENGINE OIL PRESSURE		SERVICE	
						FOG LAMPS		ANTI-LOCK BRAKES		SERVICE MANUAL	

## NOTES

---

---

---

---

---

---

---

---

---

---

---

---

---

---

---

---

---

---

---

---

---

# Section 1 Seats and Restraint Systems

---

<b>Front Seats</b> .....	1-2	Top Strap .....	1-39
Manual Seats .....	1-2	Top Strap Anchor Location .....	1-40
Six-Way Power Driver Seat .....	1-3	Lower Anchorages and Top Tethers for Children (LATCH System) .....	1-41
Power Lumbar .....	1-3	Securing a Child Restraint Designed for the LATCH System .....	1-43
Heated Seats .....	1-4	Securing a Child Restraint in a Rear Outside Seat Position .....	1-43
Reclining Seatbacks .....	1-4	Securing a Child Restraint in a Center Rear Seat Position .....	1-46
Head Restraints .....	1-6	Securing a Child Restraint in the Right Front Seat Position .....	1-48
<b>Safety Belts</b> .....	1-7	<b>Supplemental Restraint   System (SRS)</b> .....	1-51
Safety Belts: They Are for Everyone .....	1-7	Where Are the Air Bags? .....	1-53
Questions and Answers About Safety Belts .....	1-11	When Should an Air Bag Inflate? .....	1-55
How to Wear Safety Belts Properly .....	1-12	What Makes an Air Bag Inflate? .....	1-55
Driver Position .....	1-12	How Does an Air Bag Restrain? .....	1-55
Safety Belt Use During Pregnancy .....	1-20	What Will You See After an Air Bag Inflates? .....	1-56
Right Front Passenger Position .....	1-20	Servicing Your Air Bag-Equipped Vehicle .....	1-57
Center Passenger Position .....	1-21	<b>Restraint System Check</b> .....	1-58
Rear Seat Passengers .....	1-22	Checking Your Restraint Systems .....	1-58
Rear Safety Belt Comfort Guides for Children and Small Adults .....	1-26	Replacing Restraint System Parts After a Crash .....	1-58
Safety Belt Extender .....	1-28		
<b>Child Restraints</b> .....	1-29		
Older Children .....	1-29		
Infants and Young Children .....	1-32		
Child Restraint Systems .....	1-35		
Where to Put the Restraint .....	1-38		



## Front Seats

### Manual Seats

#### CAUTION:

You can lose control of the vehicle if you try to adjust a manual driver's seat while the vehicle is moving. The sudden movement could startle and confuse you, or make you push a pedal when you don't want to. Adjust the driver's seat only when the vehicle is not moving.

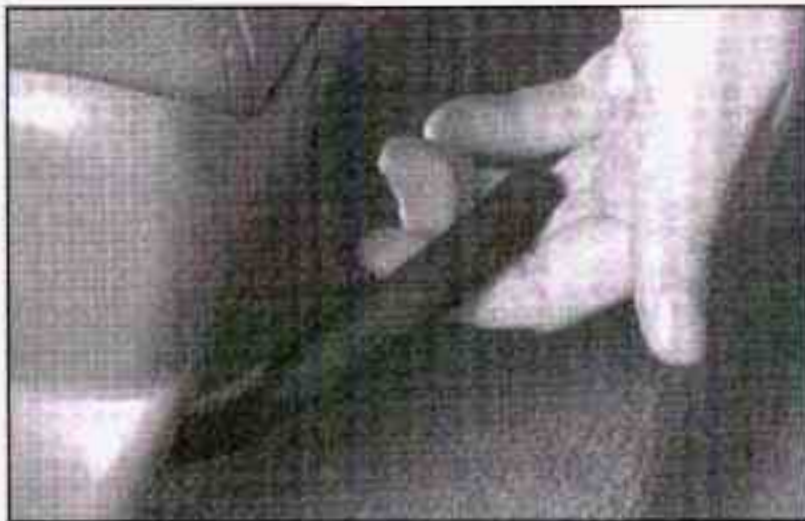

If your vehicle is equipped with manual seats, lift the lever, located under the front of the seat, using a twisting motion. This will unlock the seat. Slide the seat to where you want it and release the lever. Try to move the seat back and forth to make sure the seat is locked in place.

## Six-Way Power Driver Seat



If your vehicle has this feature, the control is located on the outboard side of the driver's seat cushion.

To adjust the seat, do any of the following:

- Move the seat forward or rearward by sliding the control toward the front or the rear.
- Raise or lower the seat cushion by sliding the control up or down.
- Raise or lower the front portion of the seat cushion by sliding the front of the control up or down.
- Raise or lower the rear portion of the seat cushion by sliding the rear of the control up or down.

## Power Lumbar



If your vehicle is equipped with this feature, there will be a control located on the outboard side of the driver's seat cushion, in front of the reclining seatback lever. To increase or decrease lumbar support, push the control forward or rearward. To adjust the lumbar support up or down, push the control up or down.

## Heated Seats



If your vehicle is equipped with this feature, the heated seat switch is located on the center console, behind the open storage bin.

Press LO to warm the seat to a lower temperature. Press HI to warm the seat to a higher temperature. To turn this feature off, place the switch in the center position. This feature only works when the ignition is turned on.

## Reclining Seatbacks

The recliner lever for the driver's and passenger's front seatback is located on the outboard side of each front seat cushion.

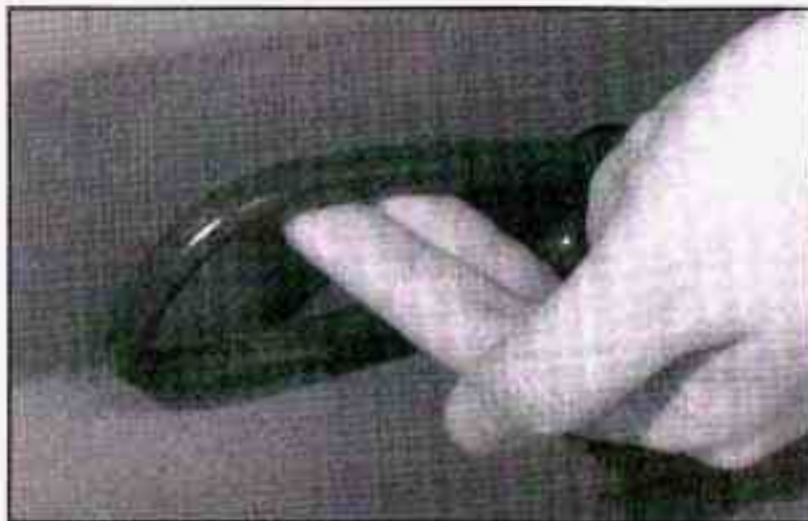

Lift the lever to release the seatback, then move the seatback to where you want it. Release the lever to lock the seatback in place. Pull up on the lever without pushing on the seatback and the seatback will move forward.



But don't have a seatback reclined if your vehicle is moving.

### **⚠ CAUTION:**

Sitting in a reclined position when your vehicle is in motion can be dangerous. Even if you buckle up, your safety belts can't do their job when you're reclined like this.

The shoulder belt can't do its job because it won't be against your body. Instead, it will be in front of you. In a crash you could go into it, receiving neck or other injuries.

The lap belt can't do its job either. In a crash the belt could go up over your abdomen. The belt forces would be there, not at your pelvic bones. This could cause serious internal injuries.

For proper protection when the vehicle is in motion, have the seatback upright. Then sit well back in the seat and wear your safety belt properly.

## Head Restraints



Slide the head restraint up or down so that the top of the restraint is closest to the top of your head. This position reduces the chance of a neck injury in a crash.

# Safety Belts

## Safety Belts: They Are for Everyone

This part of the manual tells you how to use safety belts properly. It also tells you some things you should not do with safety belts.

### CAUTION:

Don't let anyone ride where he or she can't wear a safety belt properly. If you are in a crash and you're not wearing a safety belt, your injuries can be much worse. You can hit things inside the vehicle or be ejected from it. You can be seriously injured or killed. In the same crash, you might not be, if you are buckled up. Always fasten your safety belt, and check that your passengers' belts are fastened properly too.

### CAUTION:

It is extremely dangerous to ride in a cargo area, inside or outside of a vehicle. In a collision, people riding in these areas are more likely to be seriously injured or killed. Do not allow people to ride in any area of your vehicle that is not equipped with seats and safety belts. Be sure everyone in your vehicle is in a seat and using a safety belt properly.



Your vehicle has a light that comes on as a reminder to buckle up. See *Safety Belt Reminder Light* on page 3-26.

In most states and in all Canadian provinces, the law says to wear safety belts. Here's why: *They work.*

You never know if you'll be in a crash. If you do have a crash, you don't know if it will be a bad one.

A few crashes are mild, and some crashes can be so serious that even buckled up, a person wouldn't survive. But most crashes are in between. In many of them, people who buckle up can survive and sometimes walk away. Without belts they could have been badly hurt or killed.

After more than 30 years of safety belts in vehicles, the facts are clear. In most crashes buckling up does matter... a lot!

## Why Safety Belts Work

When you ride in or on anything, you go as fast as it goes.

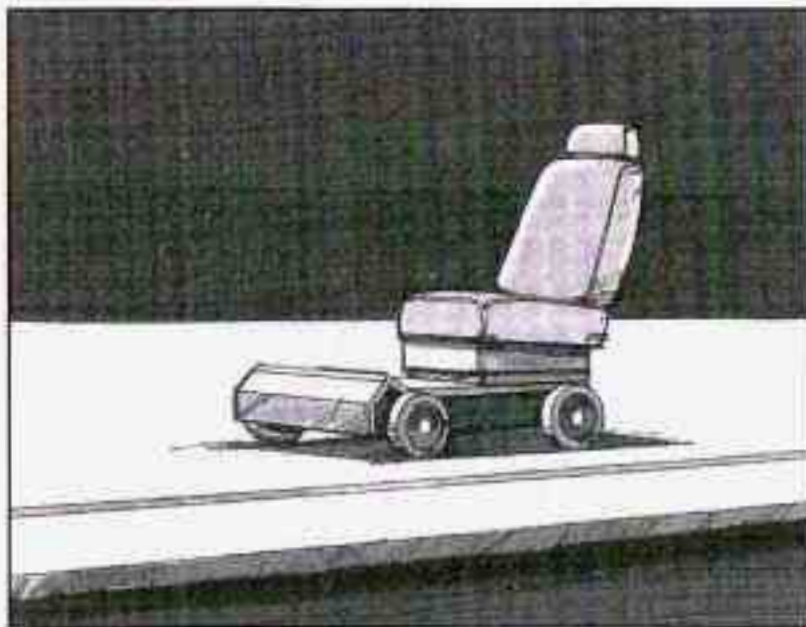

Take the simplest vehicle. Suppose it's just a seat on wheels.

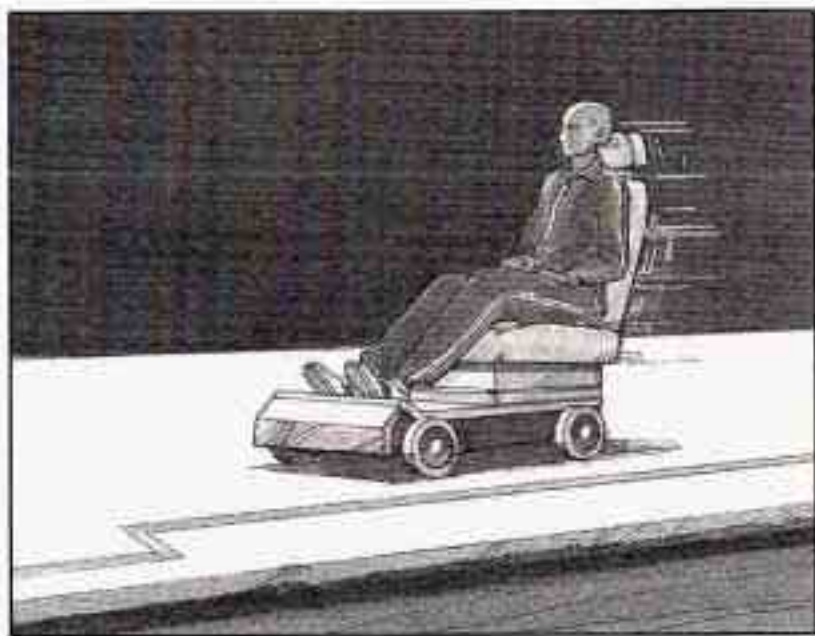

Put someone on it.

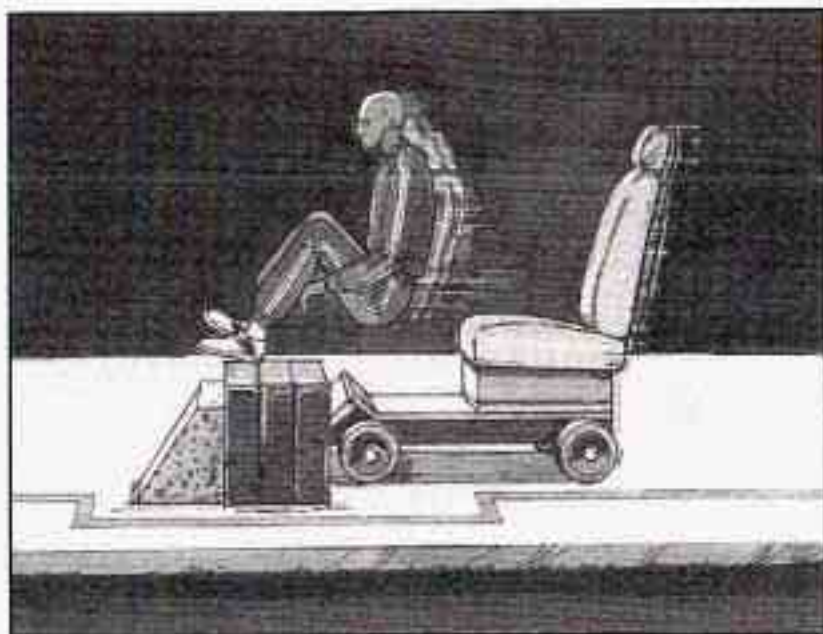

Get it up to speed. Then stop the vehicle. The rider doesn't stop.





The person keeps going until stopped by something.  
In a real vehicle, it could be the windshield...

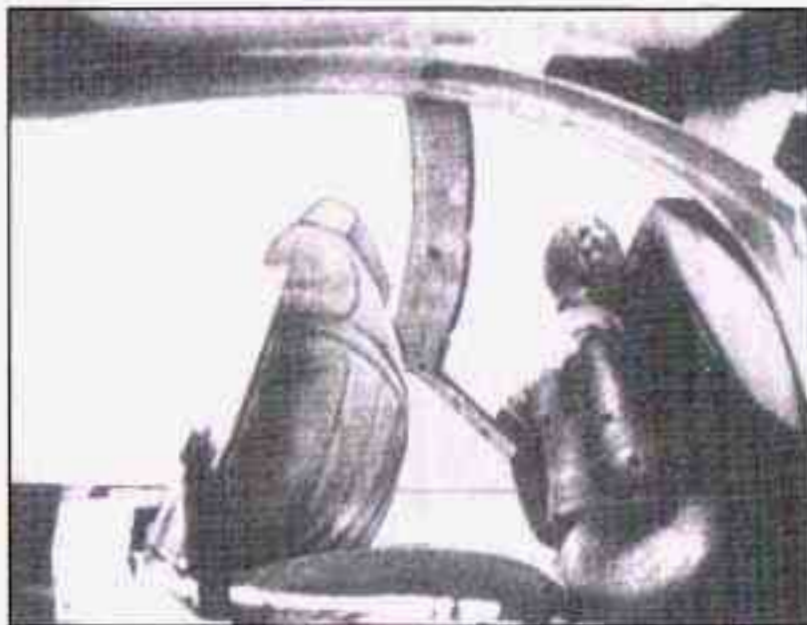

or the instrument panel...

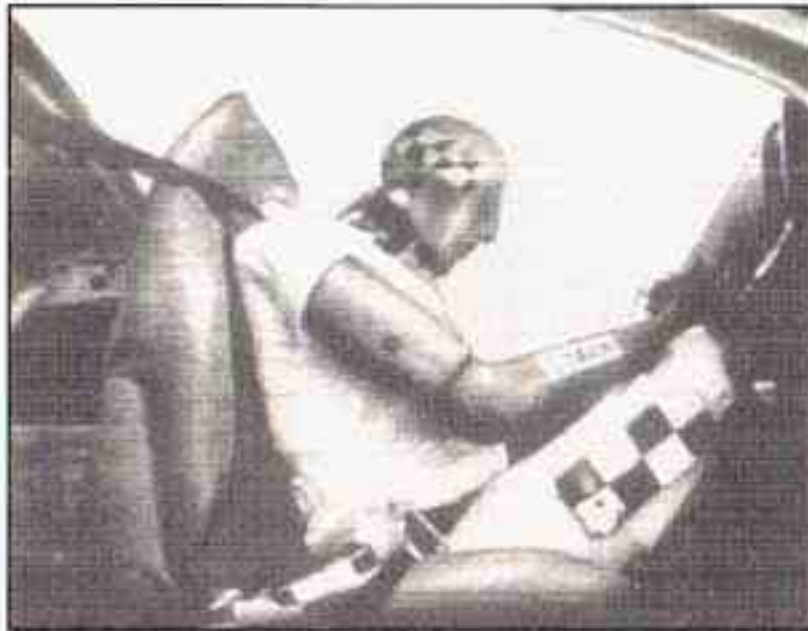

or the safety belts!

With safety belts, you slow down as the vehicle does. You get more time to stop. You stop over more distance, and your strongest bones take the forces. That's why safety belts make such good sense.

## Questions and Answers About Safety Belts

**Q:** Won't I be trapped in the vehicle after an accident if I'm wearing a safety belt?

**A:** You *could* be – whether you're wearing a safety belt or not. But you can unbuckle a safety belt, even if you're upside down. And your chance of being conscious during and after an accident, so you *can* unbuckle and get out, is *much* greater if you are belted.

**Q:** If my vehicle has air bags, why should I have to wear safety belts?

**A:** Air bags are in many vehicles today and will be in most of them in the future. But they are supplemental systems only; so they work *with* safety belts – not instead of them. Every air bag system ever offered for sale has required the use of safety belts. Even if you're in a vehicle that has air bags, you still have to buckle up to get the most protection. That's true not only in frontal collisions, but especially in side and other collisions.

**Q:** If I'm a good driver, and I never drive far from home, why should I wear safety belts?

**A:** You may be an excellent driver, but if you're in an accident – even one that isn't your fault – you and your passengers can be hurt. Being a good driver doesn't protect you from things beyond your control, such as bad drivers.

Most accidents occur within 25 miles (40 km) of home. And the greatest number of serious injuries and deaths occur at speeds of less than 40 mph (65 km/h).

Safety belts are for everyone.

## How to Wear Safety Belts Properly

This part is only for people of adult size.

Be aware that there are special things to know about safety belts and children. And there are different rules for smaller children and babies. If a child will be riding in your vehicle, see *Older Children on page 1-29* or *Infants and Young Children on page 1-32*. Follow those rules for everyone's protection.

First, you'll want to know which restraint systems your vehicle has.

We'll start with the driver position.

### Driver Position

This part describes the driver's restraint system.

### Lap-Shoulder Belt

The driver has a lap-shoulder belt. Here's how to wear it properly.

1. Close and lock the door.
2. Adjust the seat so you can sit up straight.  
To see how, see "Seats" in the Index.



3. Pick up the latch plate and pull the belt across you. Don't let it get twisted.  
The shoulder belt may lock if you pull the belt across you very quickly. If this happens, let the belt go back slightly to unlock it. Then pull the belt across you more slowly.
4. Push the latch plate into the buckle until it clicks.  
Pull up on the latch plate to make sure it is secure. If the belt isn't long enough, see *Safety Belt Extender* on page 1-28 at the end of this section.

Make sure the release button on the buckle is positioned so you would be able to unbuckle the safety belt quickly if you ever had to.



5. To make the lap part tight, pull down on the buckle end of the belt as you pull up on the shoulder belt.

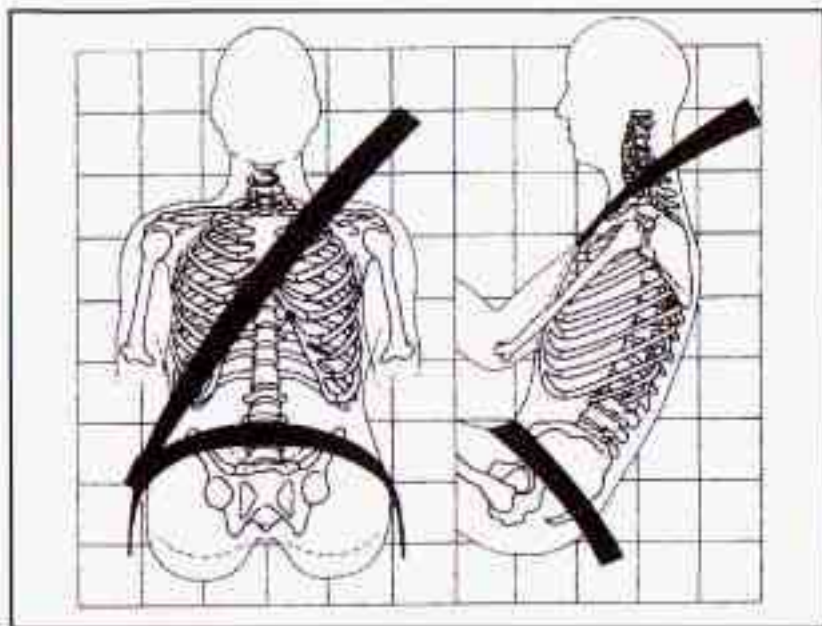

The lap part of the belt should be worn low and snug on the hips, just touching the thighs. In a crash, this applies force to the strong pelvic bones. And you'd be less likely to slide under the lap belt. If you slid under it, the belt would apply force at your abdomen. This could cause serious or even fatal injuries. The shoulder belt should go over the shoulder and across the chest. These parts of the body are best able to take belt restraining forces.

The safety belt locks if there's a sudden stop or crash, or if you pull the belt very quickly out of the retractor.

## Shoulder Belt Height Adjuster

Before you begin to drive, move the shoulder belt adjuster to the height that is right for you.



To move it down, squeeze the release lever and the shoulder belt guide as shown and move the height adjuster to the desired position. You can move the adjuster up just by pushing up on the shoulder belt guide. After you move the adjuster to where you want it, try to move it down without squeezing the release lever to make sure it has locked into position.

Adjust the height so that the shoulder portion of the belt is centered on your shoulder. The belt should be away from your face and neck, but not falling off your shoulder.

**Q:** What's wrong with this?

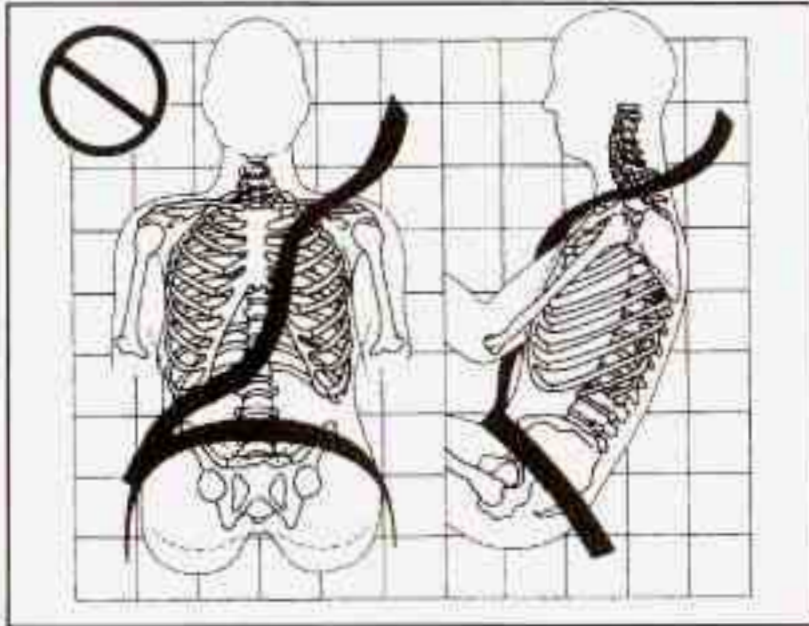

**A:** The shoulder belt is too loose. It won't give nearly as much protection this way.

**⚠ CAUTION:**

You can be seriously hurt if your shoulder belt is too loose. In a crash, you would move forward too much, which could increase injury. The shoulder belt should fit against your body.

**Q:** What's wrong with this?

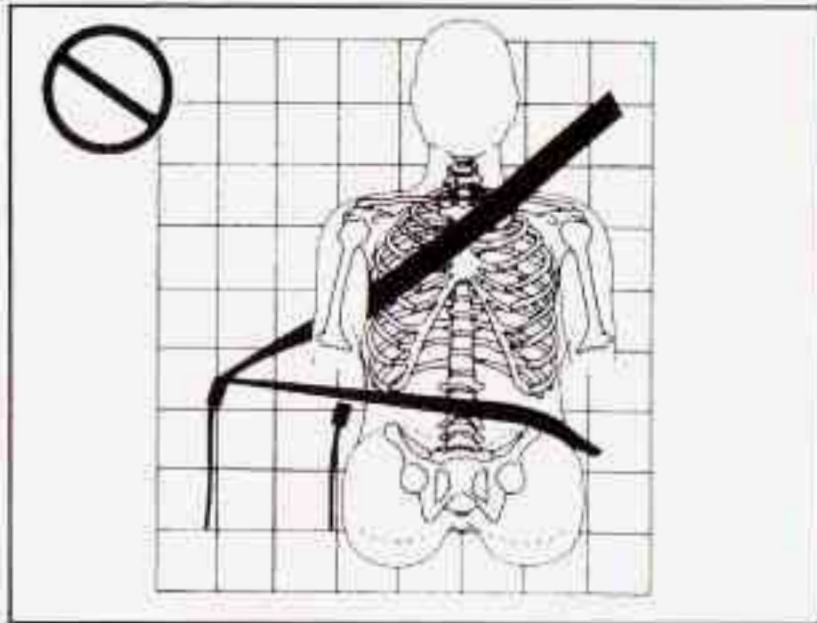

**A:** The belt is buckled in the wrong place.

**⚠ CAUTION:**

You can be seriously injured if your belt is buckled in the wrong place like this. In a crash, the belt would go up over your abdomen. The belt forces would be there, not at the pelvic bones. This could cause serious internal injuries. Always buckle your belt into the buckle nearest you.

**Q:** What's wrong with this?

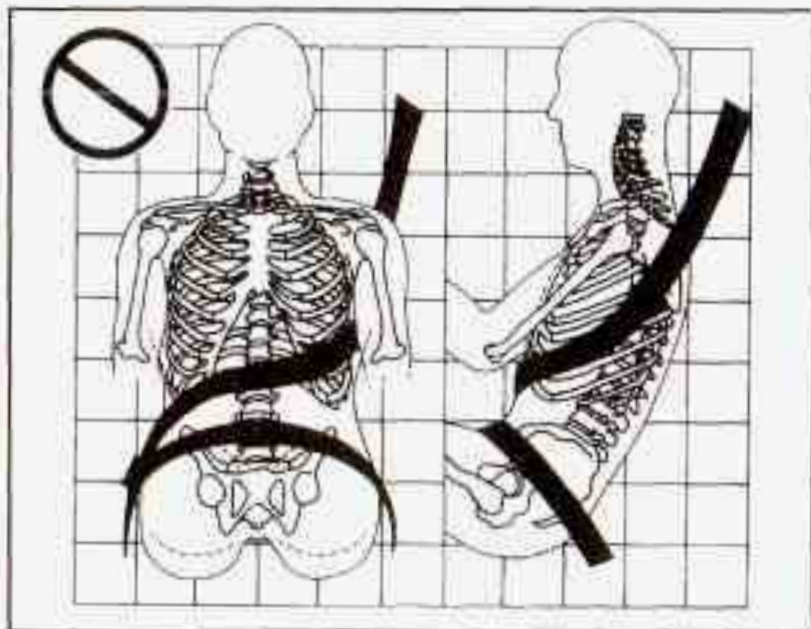

**A:** The shoulder belt is worn under the arm. It should be worn over the shoulder at all times.

**⚠ CAUTION:**

You can be seriously injured if you wear the shoulder belt under your arm. In a crash, your body would move too far forward, which would increase the chance of head and neck injury. Also, the belt would apply too much force to the ribs, which aren't as strong as shoulder bones. You could also severely injure internal organs like your liver or spleen.



**Q:** What's wrong with this?

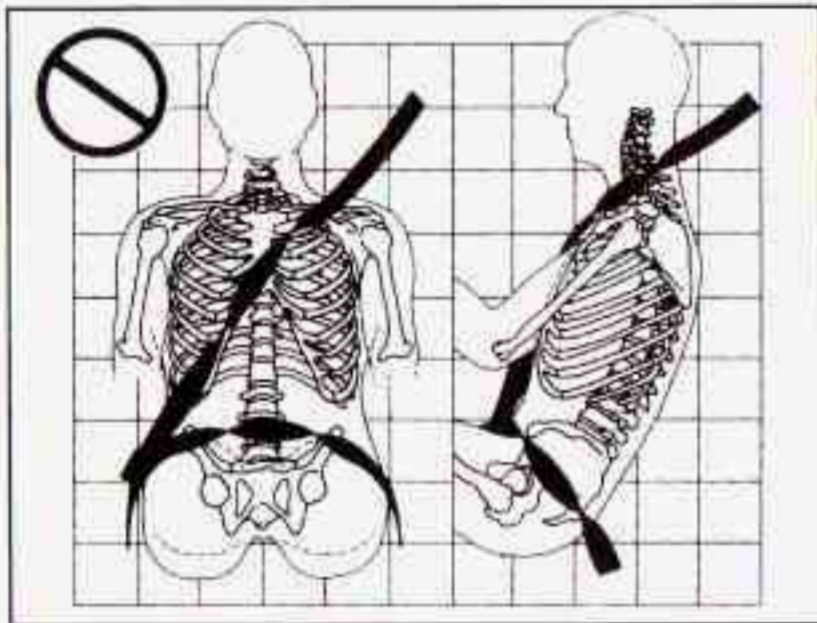

**A:** The belt is twisted across the body.

**⚠ CAUTION:**

You can be seriously injured by a twisted belt. In a crash, you wouldn't have the full width of the belt to spread impact forces. If a belt is twisted, make it straight so it can work properly, or ask your dealer to fix it.



To unfasten the belt, just push the button on the buckle. The belt should go back out of the way.

Before you close the door, be sure the belt is out of the way. If you slam the door on it, you can damage both the belt and your vehicle.

## Safety Belt Use During Pregnancy

Safety belts work for everyone, including pregnant women. Like all occupants, they are more likely to be seriously injured if they don't wear safety belts.

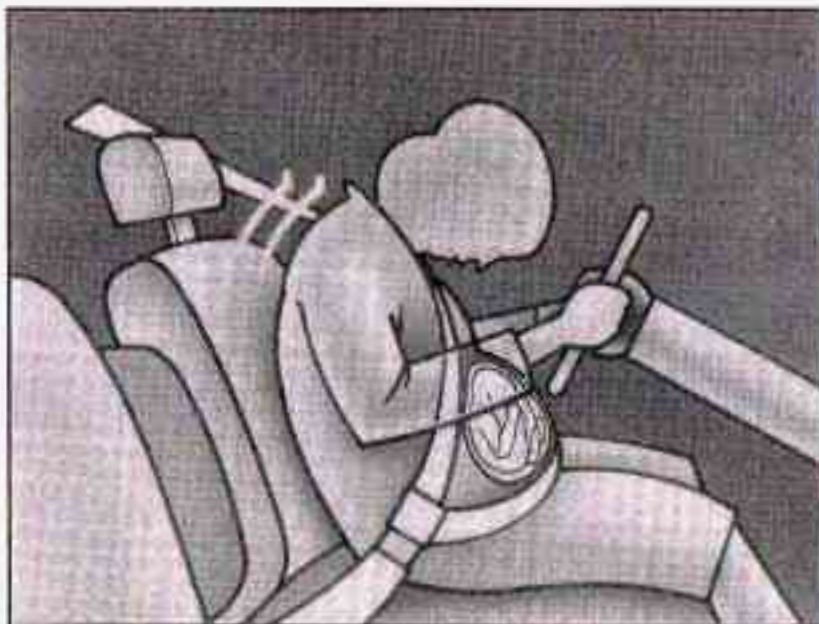

A pregnant woman should wear a lap-shoulder belt, and the lap portion should be worn as low as possible, below the rounding, throughout the pregnancy.

The best way to protect the fetus is to protect the mother. When a safety belt is worn properly, it's more likely that the fetus won't be hurt in a crash. For pregnant women, as for anyone, the key to making safety belts effective is wearing them properly.

## Right Front Passenger Position

To learn how to wear the right front passenger's safety belt properly, see *Driver Position on page 1-12*.

The right front passenger's safety belt works the same way as the driver's safety belt — except for one thing. If you ever pull the shoulder portion of the belt out all the way, you will engage the child restraint locking feature. If this happens, just let the belt go back all the way and start again.

## Center Passenger Position

### Lap Belt

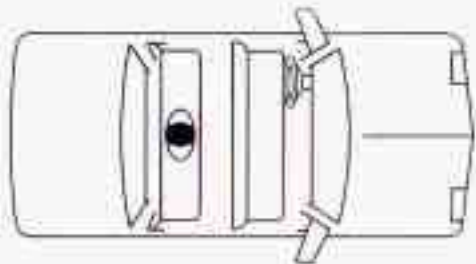

When you sit in the center seating position, you have a lap safety belt, which has no retractor. To make the belt longer, tilt the latch plate and pull it along the belt.

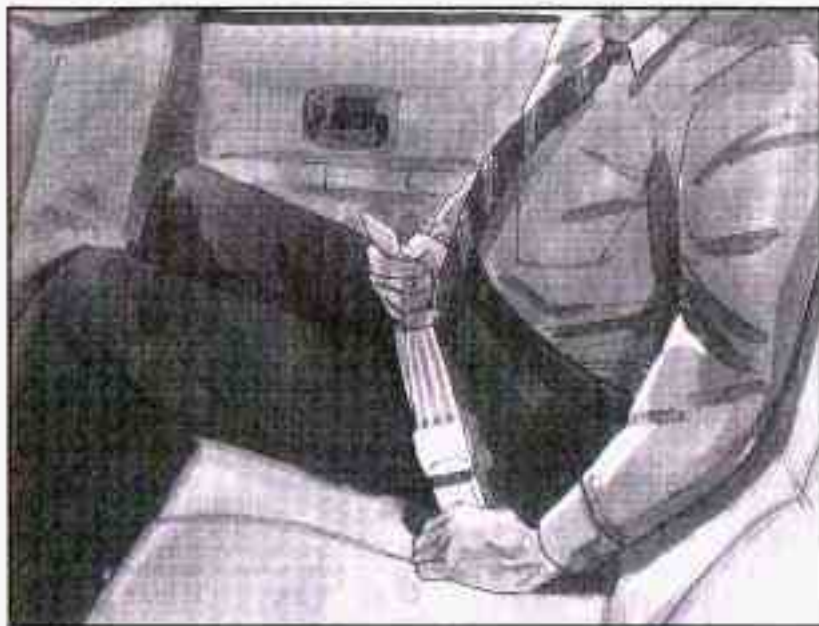

To make the belt shorter, pull its free end as shown until the belt is snug.

Buckle, position and release it the same way as the lap part of a lap-shoulder belt. If the belt isn't long enough, see *Safety Belt Extender* on page 1-28.

Make sure the release button on the buckle is positioned so you would be able to unbuckle the safety belt quickly if you ever had to.

## Rear Seat Passengers

It's very important for rear seat passengers to buckle up! Accident statistics show that unbelted people in the rear seat are hurt more often in crashes than those who are wearing safety belts.

Rear passengers who aren't safety belted can be thrown out of the vehicle in a crash. And they can strike others in the vehicle who are wearing safety belts.

## Rear Seat Outside Passenger Positions

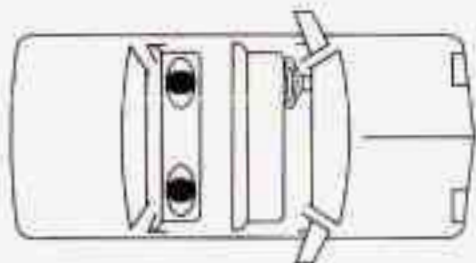

## Lap-Shoulder Belt

The positions next to the windows have lap-shoulder belts. Here's how to wear one properly.



1. Pick up the latch plate and pull the belt across you. Don't let it get twisted.

The shoulder belt may lock if you pull the belt across you very quickly. If this happens, let the belt go back slightly to unlock it. Then pull the belt across you more slowly.

2. Push the latch plate into the buckle until it clicks.

Pull up on the latch plate to make sure it is secure.

When the shoulder belt is pulled out all the way, it will lock. If it does, let it go back all the way and start again. If the belt is not long enough, see *Safety Belt Extender on page 1-28*.

Make sure the release button on the buckle is positioned so you would be able to unbuckle the safety belt quickly if you ever had to.



3. To make the lap part tight, pull down on the buckle end of the belt as you pull up on the shoulder part.

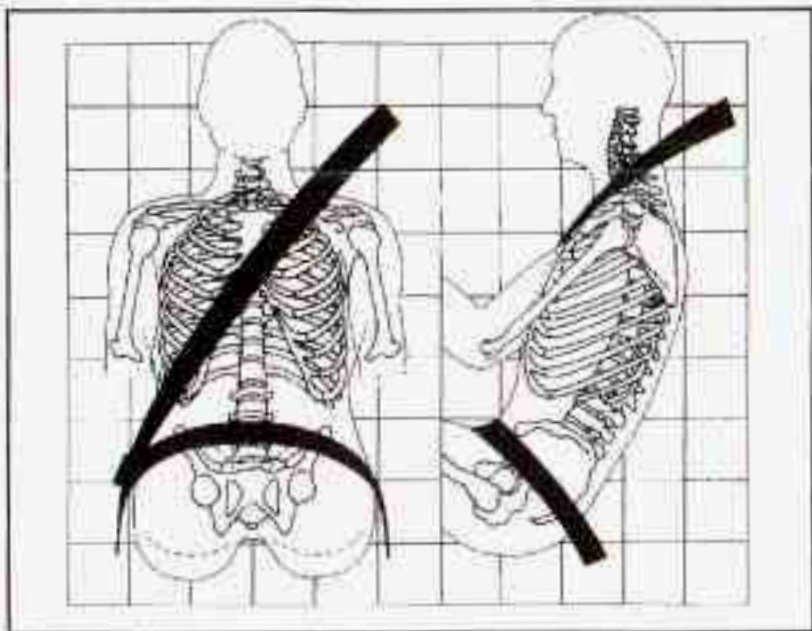

The lap part of the belt should be worn low and snug on the hips, just touching the thighs. In a crash this applies force to the strong pelvic bones. And you'd be less likely to slide under the lap belt. If you slid under it, the belt would apply force at your abdomen. This could cause serious or even fatal injuries. The shoulder belt should go over the shoulder and across the chest. These parts of the body are best able to take belt restraining forces.

The safety belt locks if there's a sudden stop or a crash, or if you pull the belt very quickly out of the retractor.

## CAUTION:

You can be seriously hurt if your shoulder belt is too loose. In a crash, you would move forward too much, which could increase injury. The shoulder belt should fit against your body.



To unlatch the belt, just push the button on the buckle.



## Rear Safety Belt Comfort Guides for Children and Small Adults

Your vehicle may have this feature already. If it doesn't, you can get it from any GM dealer.

Rear shoulder belt comfort guides will provide added safety belt comfort for older children who have outgrown booster seats and for small adults. When installed on a shoulder belt, the comfort guide better positions the belt away from the neck and head.

There is one guide available for each outside passenger position in the rear seat. To provide added safety belt comfort for children who have outgrown child restraints and booster seats and for smaller adults, the comfort guides may be installed on the shoulder belts.

Here's how to install a comfort guide and use the safety belt:

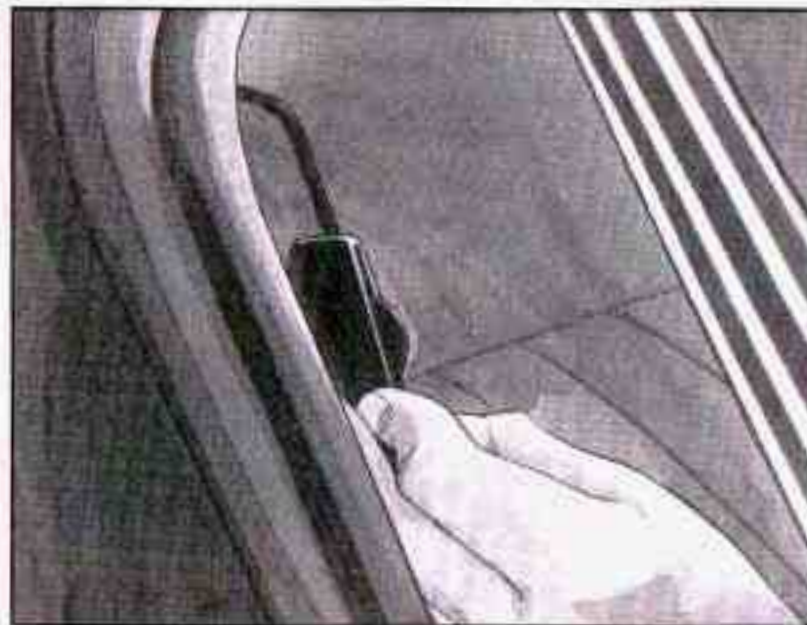

1. Pull the elastic cord out from between the edge of the seatback and the interior body to remove the guide from its storage clip.

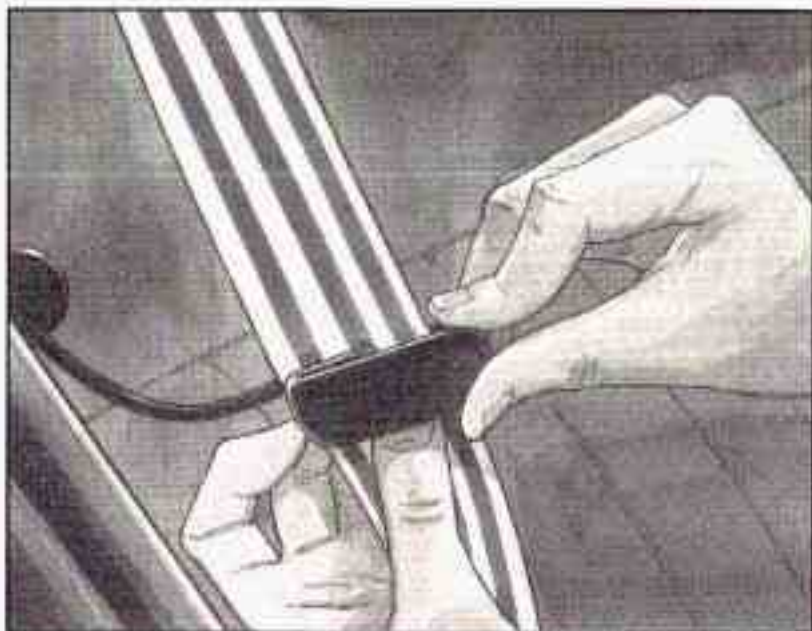

2. Slide the guide under and past the belt. The elastic cord must be under the belt. Then, place the guide over the belt, and insert the two edges of the belt into the slots of the guide.

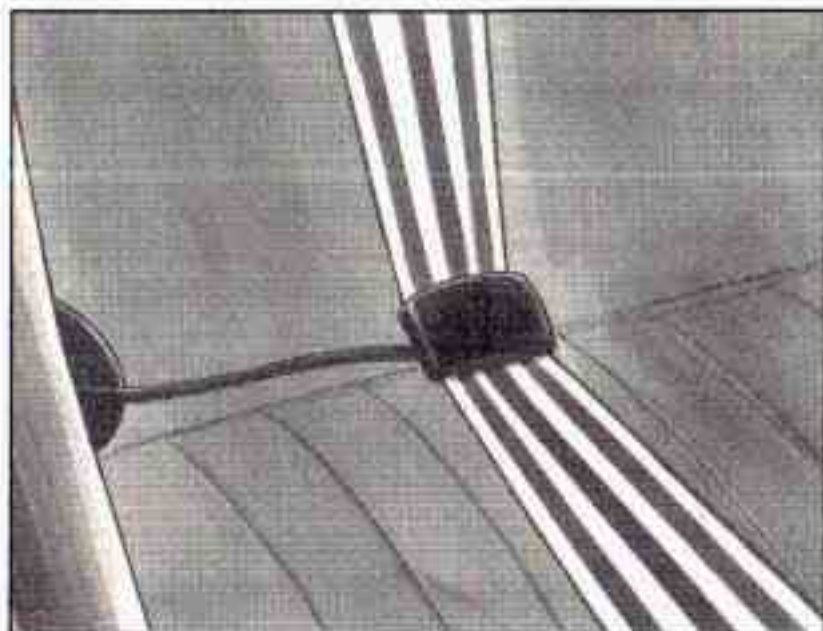

3. Be sure that the belt is not twisted and it lies flat. The elastic cord must be under the belt and the guide on top.

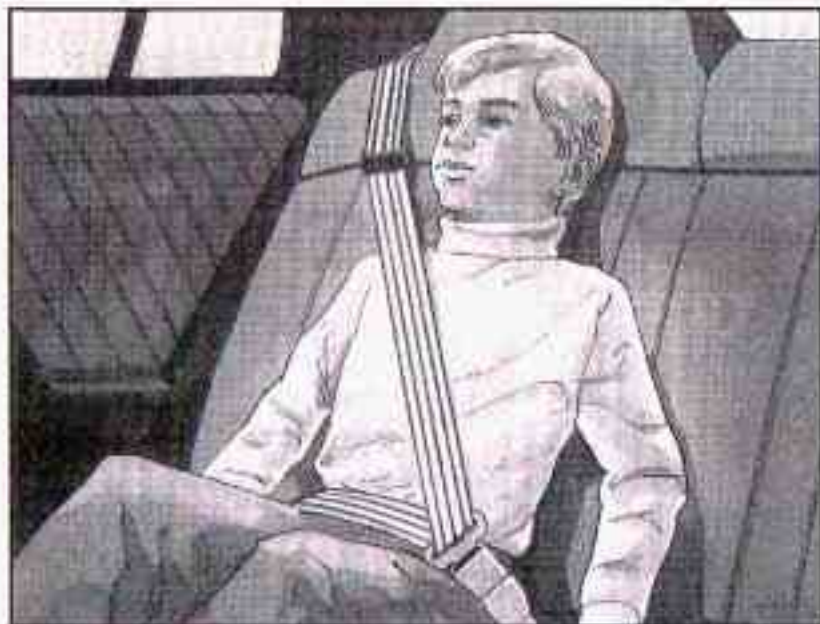

4. Buckle, position and release the safety belt as described in *Rear Seat Passengers* on page 1-22. Make sure that the shoulder belt crosses the shoulder.

To remove and store the comfort guides, squeeze the belt edges together so that you can take them out of the guides. Pull the guide upward to expose its storage clip, and then slide the guide onto the clip. Turn the guide and clip inward and in between the seatback and the interior body, leaving only the loop of the elastic cord exposed.

## Safety Belt Extender

If the vehicle's safety belt will fasten around you, you should use it.

But if a safety belt isn't long enough to fasten, your dealer will order you an extender. It's free. When you go in to order it, take the heaviest coat you will wear, so the extender will be long enough for you. The extender will be just for you, and just for the seat in your vehicle that you choose. Don't let someone else use it, and use it only for the seat it is made to fit. To wear it, just attach it to the regular safety belt.

# Child Restraints

## Older Children

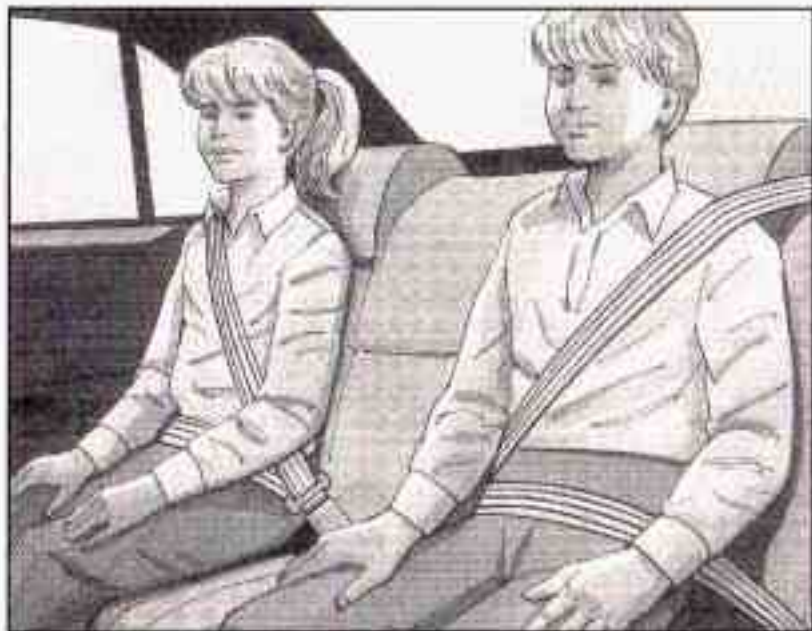

Older children who have outgrown booster seats should wear the vehicle's safety belts.

If you have the choice, a child should sit next to a window so the child can wear a lap-shoulder belt and get the additional restraint a shoulder belt can provide.

**Q:** What is the proper way to wear safety belts?

**A:** If possible, an older child should wear a lap-shoulder belt and get the additional restraint a shoulder belt can provide. The shoulder belt should not cross the face or neck. The lap belt should fit snugly below the hips, just touching the top of the thighs. It should never be worn over the abdomen, which could cause severe or even fatal internal injuries in a crash.

Accident statistics show that children are safer if they are restrained in the rear seat.

In a crash, children who are not buckled up can strike other people who are buckled up, or can be thrown out of the vehicle. Older children need to use safety belts properly.



**⚠ CAUTION:**

Never do this.

Here two children are wearing the same belt. The belt can't properly spread the impact forces. In a crash, the two children can be crushed together and seriously injured. A belt must be used by only one person at a time.

**Q:** What if a child is wearing a lap-shoulder belt, but the child is so small that the shoulder belt is very close to the child's face or neck?

**A:** Move the child toward the center of the vehicle, but be sure that the shoulder belt still is on the child's shoulder, so that in a crash the child's upper body would have the restraint that belts provide. If the child is sitting in a rear seat outside position, see *Rear Safety Belt Comfort Guides for Children and Small Adults* on page 1-26. If the child is so small that the shoulder belt is still very close to the child's face or neck, you might want to place the child in the center seat position, the one that has only a lap belt.

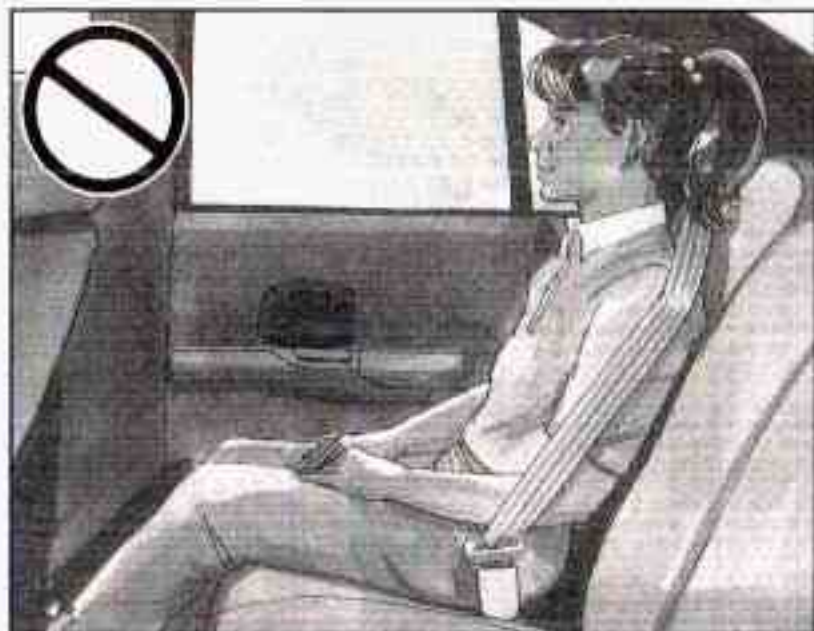

**⚠ CAUTION:**

Never do this.

Here a child is sitting in a seat that has a lap-shoulder belt, but the shoulder part is behind the child. If the child wears the belt in this way, in a crash the child might slide under the belt. The belt's force would then be applied right on the child's abdomen. That could cause serious or fatal injuries.

Wherever the child sits, the lap portion of the belt should be worn low and snug on the hips, just touching the child's thighs. This applies belt force to the child's pelvic bones in a crash.

## Infants and Young Children

Everyone in a vehicle needs protection! This includes infants and all other children. Neither the distance traveled nor the age and size of the traveler changes the need, for everyone, to use safety restraints. In fact, the law in every state in the United States and in every Canadian province says children up to some age must be restrained while in a vehicle.

Every time infants and young children ride in vehicles, they should have the protection provided by appropriate restraints. Young children should not use the vehicle's adult safety belts alone, unless there is no other choice. Instead, they need to use a child restraint.



### CAUTION:

People should never hold a baby in their arms while riding in a vehicle. A baby doesn't weigh much -- until a crash. During a crash a baby will become so heavy it is not possible to hold it.

CAUTION: (Continued)

**CAUTION: (Continued)**

For example, in a crash at only 25 mph (40 km/h), a 12-lb. (5.5 kg) baby will suddenly become a 240-lb. (110 kg) force on a person's arms. A baby should be secured in an appropriate restraint.



**⚠ CAUTION:**

Children who are up against, or very close to, any air bag when it inflates can be seriously injured or killed. Air bags plus lap-shoulder belts offer outstanding protection for adults and older children, but not for young children and infants. Neither the vehicle's safety belt system nor its air bag system is designed for them. Young children and infants need the protection that a child restraint system can provide.



**Q:** What are the different types of add-on child restraints?

**A:** Add-on child restraints, which are purchased by the vehicle's owner, are available in four basic types. Selection of a particular restraint should take into consideration not only the child's weight, height, and age but also whether or not the restraint will be compatible with the motor vehicle in which it will be used.

For most basic types of child restraints, there are many different models available. When purchasing a child restraint, be sure it is designed to be used in a motor vehicle. If it is, the restraint will have a label saying that it meets federal motor vehicle safety standards.

The restraint manufacturer's instructions that come with the restraint state the weight and height limitations for a particular child restraint. In addition, there are many kinds of restraints available for children with special needs.

 **CAUTION:**

**Newborn infants need complete support, including support for the head and neck. This is necessary because a newborn infant's neck is weak and its head weighs so much compared with the rest of its body. In a crash, an infant in a rear-facing seat settles into the restraint, so the crash forces can be distributed across the strongest part of an infant's body, the back and shoulders. Infants always should be secured in appropriate infant restraints.**

## **⚠ CAUTION:**

The body structure of a young child is quite unlike that of an adult or older child, for whom the safety belts are designed. A young child's hip bones are still so small that the vehicle's regular safety belt may not remain low on the hip bones, as it should. Instead, it may settle up around the child's abdomen. In a crash, the belt would apply force on a body area that's unprotected by any bony structure. This alone could cause serious or fatal injuries. Young children always should be secured in appropriate child restraints.

## **Child Restraint Systems**

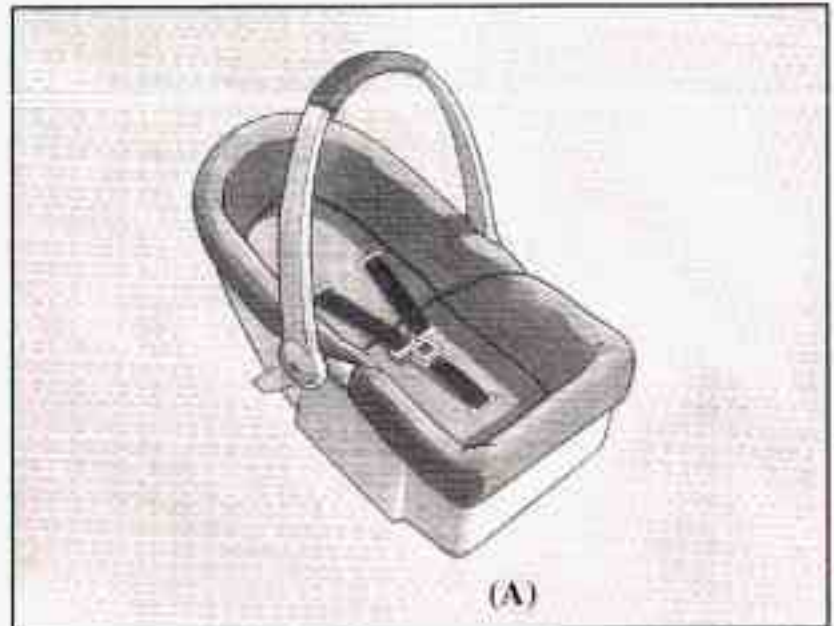

An infant car bed (A), a special bed made for use in a motor vehicle, is an infant restraint system designed to restrain or position a child on a continuous flat surface. Make sure that the infant's head rests toward the center of the vehicle.

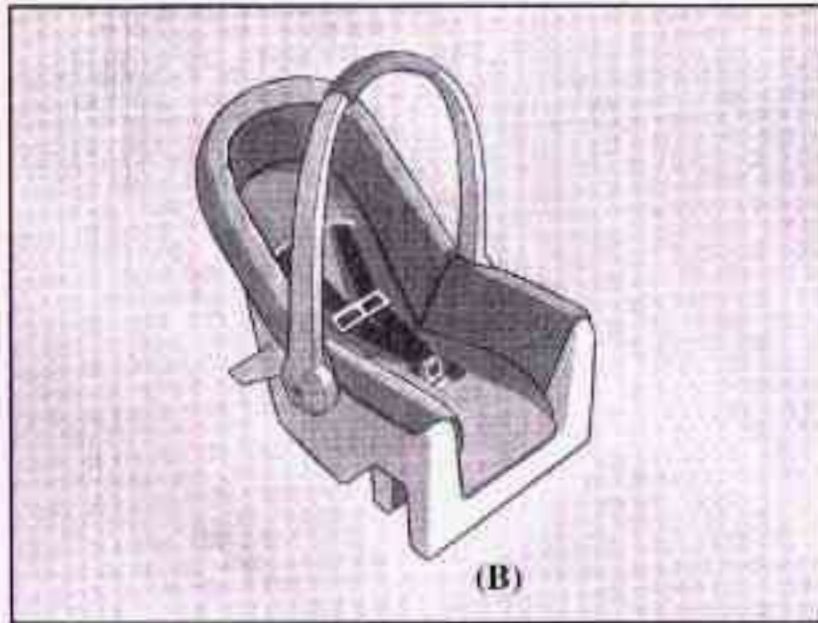

A rear-facing infant seat (B) provides restraint with the seating surface against the back of the infant. The harness system holds the infant in place and, in a crash, acts to keep the infant positioned in the restraint.

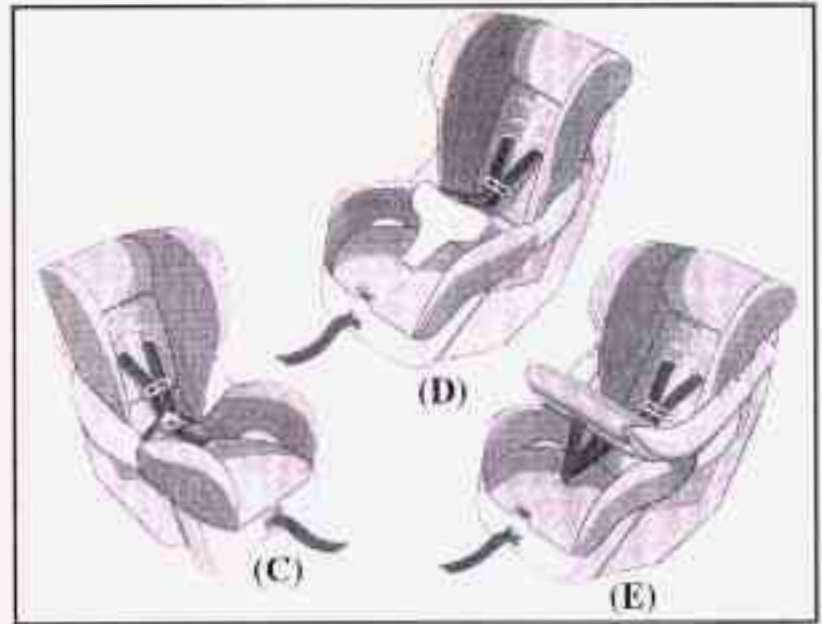

A forward-facing child seat (C-E) provides restraint for the child's body with the harness and also sometimes with surfaces such as T-shaped or shelf-like shields.

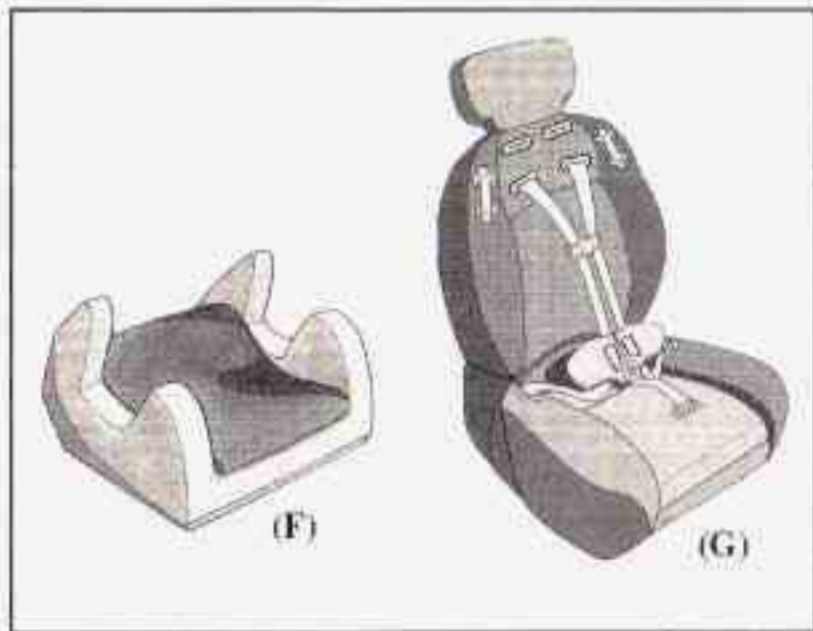

A booster seat (F-G) is a child restraint designed to improve the fit of the vehicle's safety belt system. Some booster seats have a shoulder belt positioner, and some high-back booster seats have a five-point harness. A booster seat can also help a child to see out the window.

**Q: How do child restraints work?**

**A:** A child restraint system is any device designed for use in a motor vehicle to restrain, seat, or position children. A built-in child restraint system is a permanent part of the motor vehicle. An add-on child restraint system is a portable one, which is purchased by the vehicle's owner.

For many years, add-on child restraints have used the adult belt system in the vehicle. To help reduce the chance of injury, the child also has to be secured within the restraint. The vehicle's belt system secures the add-on child restraint in the vehicle, and the add-on child restraint's harness system holds the child in place within the restraint.

One system, the three-point harness, has straps that come down over each of the infant's shoulders and buckle together at the crotch. The five-point harness system has two shoulder straps, two hip straps and a crotch strap. A shield may take the place of hip straps. A T-shaped shield has shoulder straps that are attached to a flat pad which rests low against the child's body. A shelf- or armrest-type shield has straps that are attached to a wide, shelf-like shield that swings up or to the side.

When choosing a child restraint, be sure the child restraint is designed to be used in a vehicle. If it is, it will have a label saying that it meets federal motor vehicle safety standards.

Then follow the instructions for the restraint. You may find these instructions on the restraint itself or in a booklet, or both. These restraints use the belt system in your vehicle, but the child also has to be secured within the restraint to help reduce the chance of personal injury. When securing an add-on child restraint, refer to the instructions that come with the restraint which may be on the restraint itself or in a booklet, or both, and to this manual. The child restraint instructions are important, so if they are not available, obtain a replacement copy from the manufacturer.

## Where to Put the Restraint

Accident statistics show that children are safer if they are restrained in the rear rather than the front seat. General Motors, therefore, recommends that child restraints be secured in a rear seat, including an infant riding in a rear-facing infant seat, a child riding in a forward-facing child seat and an older child riding in a booster seat. *Never* put a rear-facing child restraint in the front passenger seat.

Here's why:

### **CAUTION:**

**A child in a rear-facing child restraint can be seriously injured or killed if the right front passenger's air bag inflates. This is because the back of the rear-facing child restraint would be very close to the inflating air bag. Always secure a rear-facing child restraint in a rear seat.**

**You may secure a forward-facing child restraint in the right front seat, but before you do, always move the front passenger seat as far back as it will go. It's better to secure the child restraint in a rear seat.**

Wherever you install it, be sure to secure the child restraint properly.

Keep in mind that an unsecured child restraint can move around in a collision or sudden stop and injure people in the vehicle. Be sure to properly secure any child restraint in your vehicle – even when no child is in it.

## Top Strap

Some child restraints have a top strap, or "top tether". It can help restrain the child restraint during a collision. For it to work, a top strap must be properly anchored to the vehicle. Some top strap-equipped child restraints are designed for use with or without the top strap being anchored. Others require the top strap always to be anchored. Be sure to read and follow the instructions for your child restraint. If yours requires that the top strap be anchored, don't use the restraint unless it is anchored properly.

If the child restraint does not have a top strap, one can be obtained, in kit form, for many child restraints. Ask the child restraint manufacturer whether or not a kit is available.

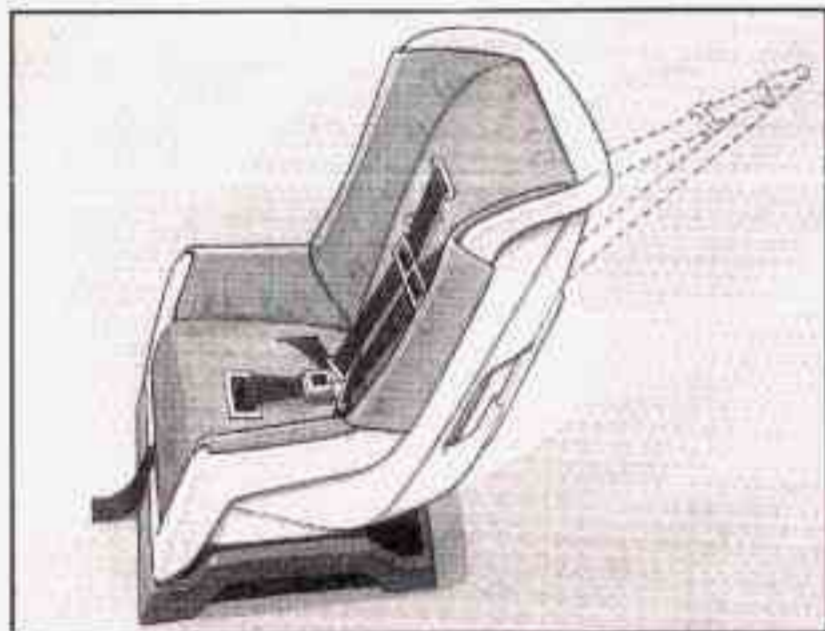

In Canada, the law requires that forward-facing child restraints have a top strap, and that the strap be anchored. In the United States, some child restraints also have a top strap. If your child restraint has a top strap, it should be anchored.

Anchor the top strap to one of the following anchor points. Be sure to use an anchor point located on the same side of the vehicle as the seating position where the child restraint will be placed.

Once you have the top strap anchored, you'll be ready to secure the child restraint itself. Tighten the top strap when and as the child restraint manufacturer's instructions say.

## Top Strap Anchor Location

Your vehicle has top strap anchors already installed for the rear seating positions. You'll find them behind the rear seat on the filler panel.

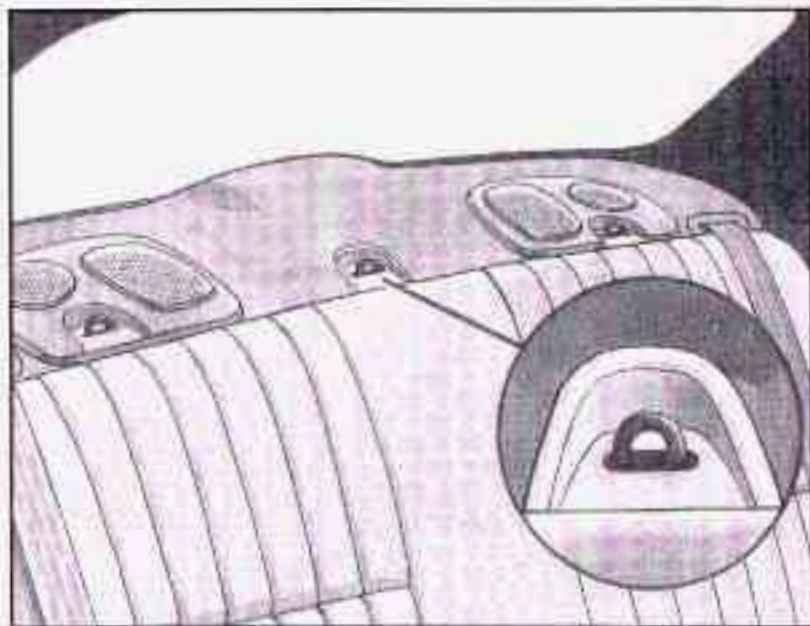

## Lower Anchorages and Top Tethers for Children (LATCH System)

Your vehicle has the LATCH system. You'll find anchors (A) in all three rear seating positions.

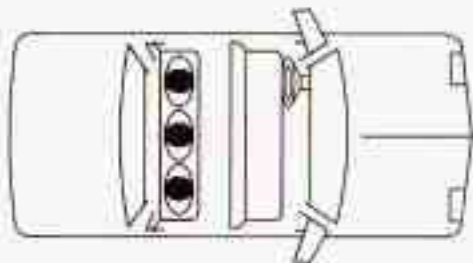

To assist you in locating the lower anchors for this child restraint system, each seating position with the LATCH system will have a dot on the seatback directly above the anchor.

In order to use the system, you need either a forward-facing child restraint that has attaching points (B) at its base and a top tether anchor (C), or a rear-facing child restraint that has attaching points (B), as shown here.

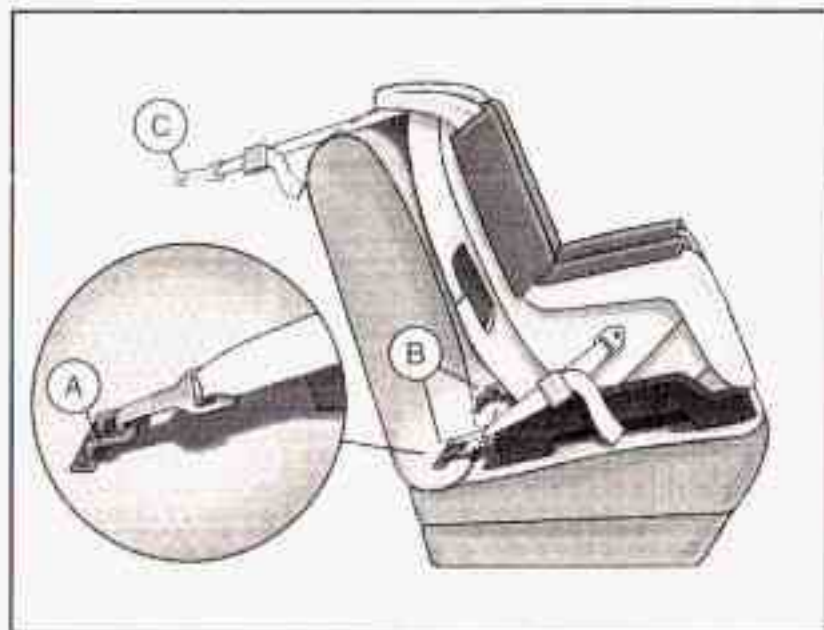

- A. Vehicle anchor
- B. LATCH system attachment points
- C. Top strap



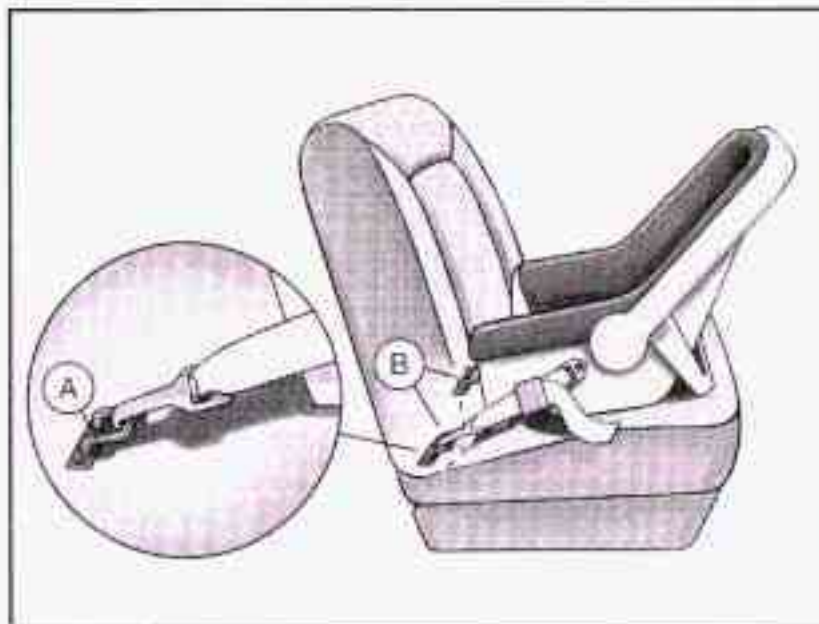

A. Vehicle anchor

B. LATCH system attachment points

With this system, use the LATCH system instead of the vehicle's safety belts to secure a child restraint.

## **⚠ CAUTION:**

If a LATCH-type child restraint isn't attached to its anchorage points, the restraint won't be able to protect a child sitting there. In a crash, the child could be seriously injured or killed. Make sure that a LATCH-type child restraint is properly installed using the anchorage points, or use the vehicle's safety belts to secure the restraint. See "Securing a Child Restraint Designed for the LATCH System", "Securing a Child Restraint in a Rear Outside Seat Position" or "Securing a Child Restraint in a Center Rear Seat Position" in the Index for information on how to secure a child restraint in your vehicle.

## Securing a Child Restraint Designed for the LATCH System

1. Find the anchors for the seating position you want to use, where the bottom of the seatback meets the back of the seat cushion.
2. Put the child restraint on the seat.
3. Attach the anchor points on the child restraint to the anchors in the vehicle. The child restraint instructions will show you how.
4. If the child restraint is forward-facing, attach the top strap to the top strap anchor. See *Top Strap on page 1-39*. Tighten the top strap according to the child restraint instructions.
5. Push and pull the child restraint in different directions to be sure it is secure.

To remove the child restraint, simply unhook the top strap from the top tether anchor and then disconnect the anchor points.

## Securing a Child Restraint in a Rear Outside Seat Position

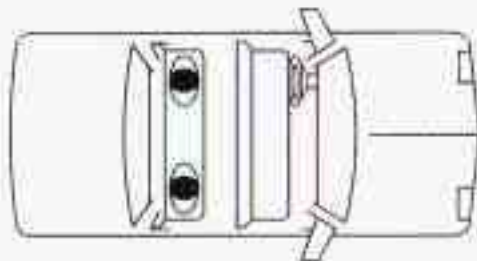

If your child restraint is equipped with the LATCH system, see *Lower Anchorages and Top Tethers for Children (LATCH System) on page 1-41*.

You'll be using the lap-shoulder belt. See *Top Strap on page 1-39* if the child restraint has one. Be sure to follow the instructions that came with the child restraint. Secure the child in the child restraint when and as the instructions say.

1. Put the restraint on the seat.
2. Pick up the latch plate, and run the lap and shoulder portions of the vehicle's safety belt through or around the restraint. The child restraint instructions will show you how.

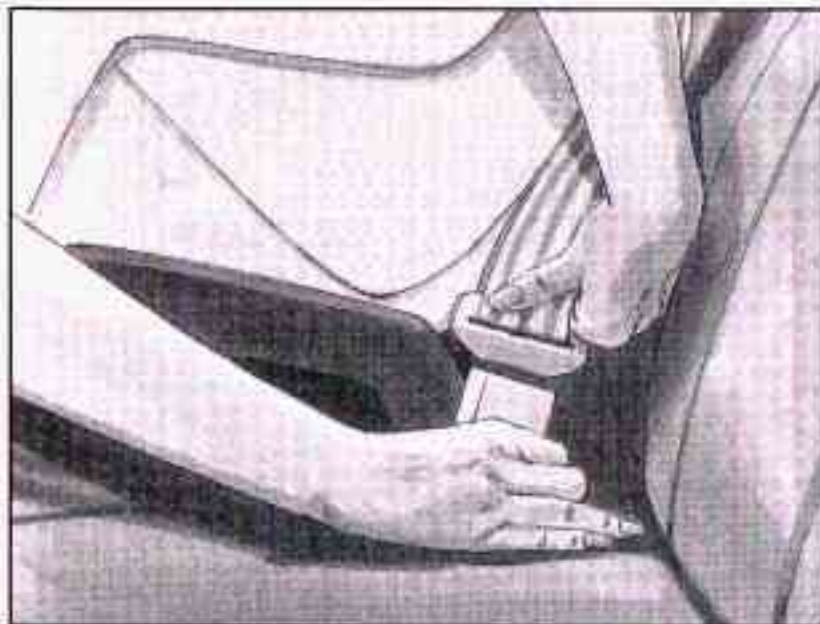

3. Buckle the belt. Make sure the release button is positioned so you would be able to unbuckle the safety belt quickly if you ever had to.



4. Pull the rest of the shoulder belt all the way out of the retractor to set the lock.

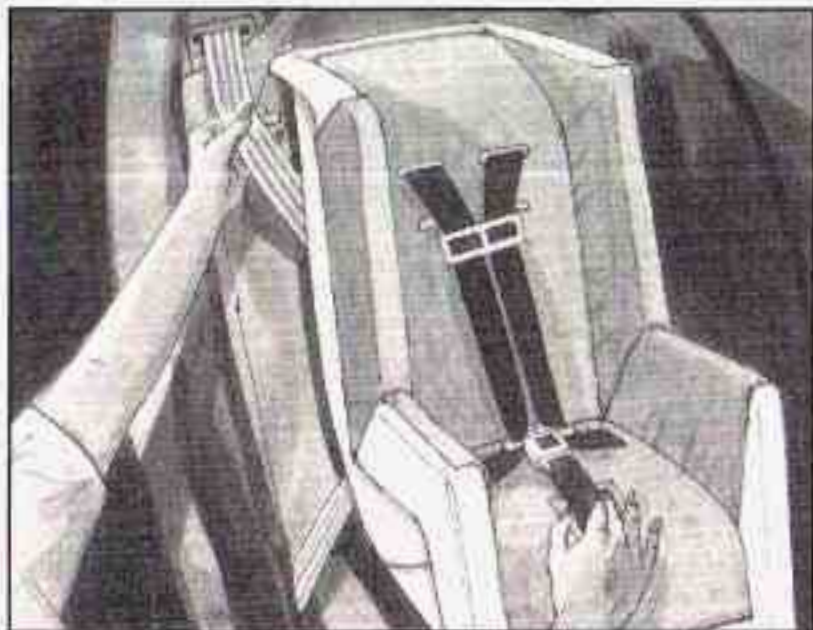

5. To tighten the belt, feed the shoulder belt back into the retractor while you push down on the child restraint. If you're using a forward-facing child restraint, you may find it helpful to use your knee to push down on the child restraint as you tighten the belt.
6. Push and pull the child restraint in different directions to be sure it is secure.

To remove the child restraint, just unbuckle the vehicle's safety belt and let it go back all the way. The safety belt will move freely again and be ready to work for an adult or larger child passenger.

## Securing a Child Restraint in a Center Rear Seat Position

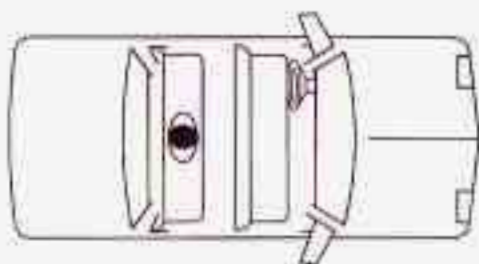

If your child restraint is equipped with the LATCH system, see *Lower Anchorages and Top Tethers for Children (LATCH System)* on page 1-41.

You'll be using the lap belt.

Be sure to follow the instructions that came with the child restraint. Secure the child restraint when and as the instructions say.

See *Top Strap* on page 1-39 if the child restraint has one.



1. Make the belt as long as possible by tilting the latch plate and pulling it along the belt.
2. Put the restraint on the seat.
3. Run the vehicle's safety belt through or around the restraint. The child restraint instructions will show you how.



4. Buckle the belt. Make sure the release button is positioned so you would be able to unbuckle the safety belt quickly if you ever had to.
5. To tighten the belt, pull its free end while you push down on the child restraint. If you're using a forward-facing child restraint, you may find it helpful to use your knee to push the child restraint as you tighten the belt.
6. Push and pull the child restraint in different directions to be sure it is secure.

To remove the child restraint, just unbuckle the vehicle's safety belt. It will be ready to work for an adult or larger child passenger.

## Securing a Child Restraint in the Right Front Seat Position

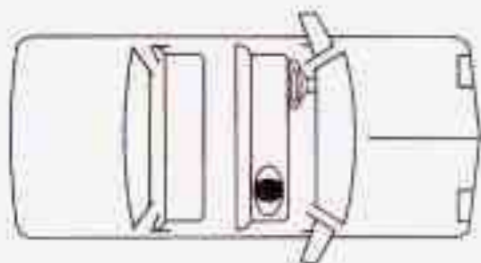

Your vehicle has a right front passenger air bag. *Never* put a rear facing child restraint in this seat. Here's why:

### **⚠ CAUTION:**

A child in a rear-facing child restraint can be seriously injured or killed if the right front passenger's air bag inflates. This is because the back of the rear-facing child restraint would be very close to the inflating air bag. Always secure a rear-facing child restraint in a rear seat.

Although a rear seat is a safer place, you can secure a forward-facing child restraint in the right front seat.

You'll be using the lap-shoulder belt. See the earlier part about the *Top Strap* on page 1-39, if the child restraint has one. Be sure to follow the instructions that came with the child restraint. Secure the child in the child restraint when and as the instructions say.

1. Because your vehicle has a right front passenger's air bag, always move the seat as far back as it will go before securing a forward-facing child restraint. See *Manual Seats* on page 1-2.
2. Put the restraint on the seat.
3. Pick up the latch plate and run the lap and shoulder portions of the vehicle's safety belt through or around the restraint. The child restraint instructions will show you how.



4. Buckle the belt. Make sure the release button is positioned so you would be able to unbuckle the safety belt quickly if you ever had to.



5. Pull the rest of the lap belt all the way out of the retractor to set the lock.



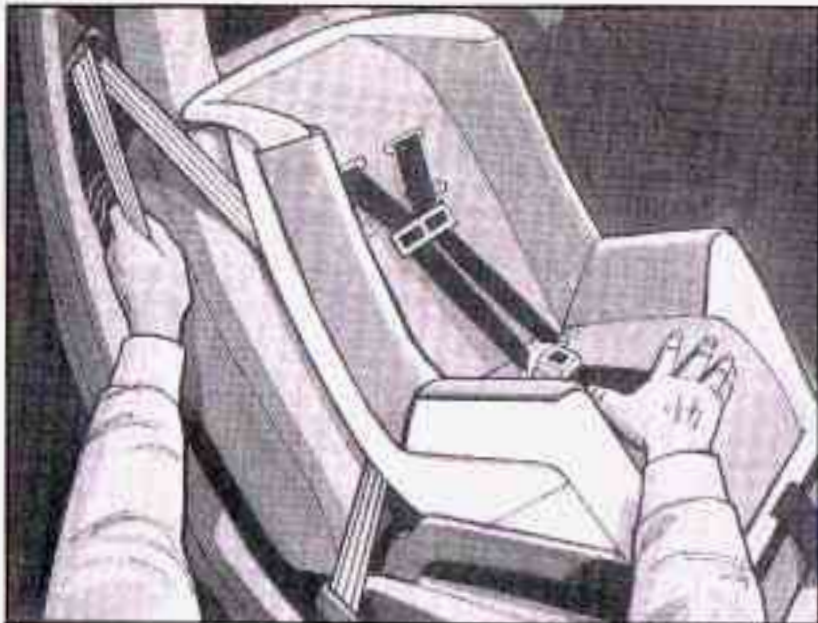

6. To tighten the belt, feed the shoulder belt back into the retractor while you push down on the child restraint. You may find it helpful to use your knee to push down on the child restraint as you tighten the belt.
7. Push and pull the child restraint in different directions to be sure it is secure.

To remove the child restraint, just unbuckle the vehicle's safety belt and let it go back all the way. The safety belt will move freely again and be ready to work for an adult or larger child passenger.

## Supplemental Restraint System (SRS)

This part explains the Supplemental Restraint System (SRS) or air bag system.

Your vehicle has air bags – one air bag for the driver and another air bag for the right front passenger.

Frontal air bags are designed to help reduce the risk of injury from the force of an inflating air bag. But these air bags must inflate very quickly to do their job and comply with federal regulations.

Here are the most important things to know about the air bag system:

### CAUTION:

You can be severely injured or killed in a crash if you aren't wearing your safety belt — even if you have air bags. Wearing your safety belt during a crash helps reduce your chance of hitting things inside the vehicle or being ejected from it. Air bags are designed to work with safety belts, but don't replace them.

CAUTION: (Continued)

### CAUTION: (Continued)

Air bags are designed to deploy only in moderate to severe frontal and near frontal crashes. They aren't designed to inflate at all in rollover, rear or low-speed frontal crashes, or in many side crashes. And, for some unrestrained occupants, air bags may provide less protection in frontal crashes than more forceful air bags have provided in the past. Everyone in your vehicle should wear a safety belt properly — whether or not there's an air bag for that person.

 **CAUTION:**

Air bags inflate with great force, faster than the blink of an eye. If you're too close to an inflating air bag, as you would be if you were leaning forward, it could seriously injure you. Safety belts help keep you in position before and during a crash. Always wear your safety belt, even with air bags. The driver should sit as far back as possible while still maintaining control of the vehicle.

 **CAUTION:**

Anyone who is up against, or very close to, any air bag when it inflates can be seriously injured or killed. Air bags plus lap-shoulder belts offer the best protection for adults, but not for young children and infants. Neither the vehicle's safety belt system nor its air bag system is designed for them. Young children and infants need the protection that a child restraint system can provide. Always secure children properly in your vehicle. To read how, see the parts of this manual called "Older Children" and "Infants and Young Children".

SRS AIR BAG

United States



Canada

There is a air bag readiness light on the instrument panel, which shows SRS AIR BAG or the air bag symbol.

The system checks the air bag electrical system for malfunctions. The light tells you if there is an electrical problem. See *Air Bag Readiness Light* on page 3-26 for more information.

## Where Are the Air Bags?

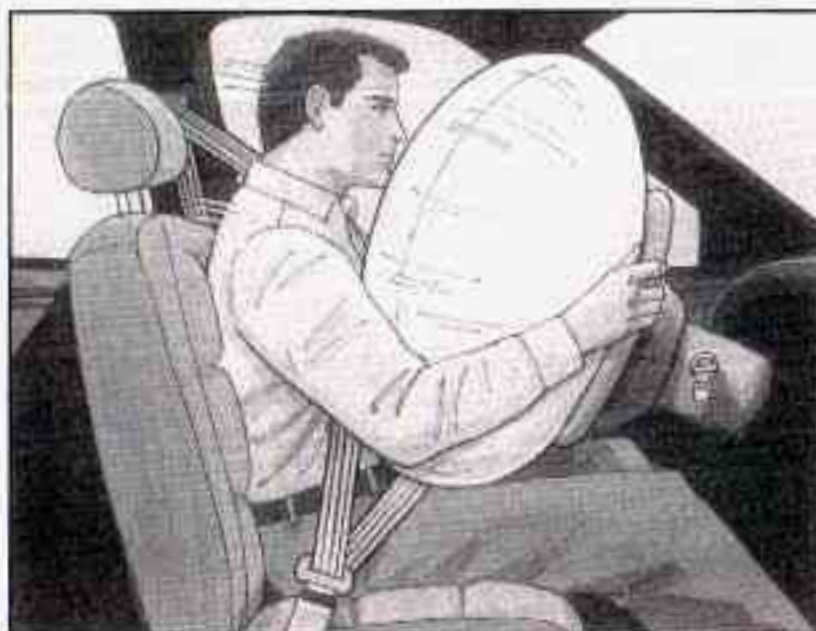

The driver's air bag is in the middle of the steering wheel.



The right front passenger's air bag is in the instrument panel on the passenger's side.

**⚠ CAUTION:**

If something is between an occupant and an air bag, the bag might not inflate properly or it might force the object into that person causing severe injury or even death. The path of an inflating air bag must be kept clear. Don't put anything between an occupant and an air bag, and don't attach or put anything on the steering wheel hub or on or near any other air bag covering.

## When Should an Air Bag Inflate?

An air bag is designed to inflate in a moderate to severe frontal, or near-frontal crash. The air bag will inflate only if the impact speed is above the system's designed "threshold level." If your vehicle goes straight into a wall that doesn't move or deform, the threshold level is about 12 to 18 mph (19 to 29 km/h). The threshold level can vary, however, with specific vehicle design, so that it can be somewhat above or below this range. If your vehicle strikes something that will move or deform, such as a parked car, the threshold level will be higher. The air bag is not designed to inflate in rollovers, rear impacts, or in many side impacts because inflation would not help the occupant.

In any particular crash, no one can say whether an air bag should have inflated simply because of the damage to a vehicle or because of what the repair costs were. Inflation is determined by the angle of the impact and how quickly the vehicle slows down in frontal or near-frontal impacts.

## What Makes an Air Bag Inflate?

In an impact of sufficient severity, the air bag sensing system detects that the vehicle is in a crash. The sensing system triggers a release of gas from the inflator, which inflates the air bag. The inflator, air bag, and related hardware are all part of the air bag modules inside the steering wheel and in the instrument panel in front of the right front passenger.

## How Does an Air Bag Restrain?

In moderate to severe frontal or near-frontal collisions, even belted occupants can contact the steering wheel or the instrument panel. Air bags supplement the protection provided by safety belts. Air bags distribute the force of the impact more evenly over the occupant's upper body, stopping the occupant more gradually. But air bags would not help you in many types of collisions, including rollovers, rear impacts and many side impacts, primarily because an occupant's motion is not toward those air bags. Air bags should never be regarded as anything more than a supplement to safety belts, and then only in moderate to severe frontal or near-frontal collisions.

## What Will You See After an Air Bag Inflates?

After an air bag inflates, it quickly deflates, so quickly that some people may not even realize the air bag inflated. Some components of the air bag module — the steering wheel hub for the driver's air bag or the instrument panel for the right front passenger's bag — will be hot for a short time. The parts of the bag that come into contact with you may be warm, but not too hot to touch. There will be some smoke and dust coming from the vents in the deflated air bags. Air bag inflation doesn't prevent the driver from seeing or being able to steer the vehicle, nor does it stop people from leaving the vehicle.

### CAUTION:

**When an air bag inflates, there is dust in the air. This dust could cause breathing problems for people with a history of asthma or other breathing trouble. To avoid this, everyone in the vehicle should get out as soon as it is safe.**

**CAUTION: (Continued)**

### **CAUTION: (Continued)**

**to do so. If you have breathing problems but can't get out of the vehicle after an air bag inflates, then get fresh air by opening a window or a door. If you experience breathing problems following an air bag deployment, you should seek medical attention.**

In many crashes severe enough to inflate an air bag, windshields are broken by vehicle deformation. Additional windshield breakage may also occur from the right front passenger air bag.

- Air bags are designed to inflate only once. After an air bag inflates, you'll need some new parts for your air bag system. If you don't get them, the air bag system won't be there to help protect you in another crash. A new system will include air bag modules and possibly other parts. The service manual for your vehicle covers the need to replace other parts.

- Your vehicle is equipped with a crash sensing and diagnostic module, which records information about the air bag system. The module records information about the readiness of the system, when the system commands air bag inflation and driver's safety belt usage at deployment.
- Let only qualified technicians work on your air bag system. Improper service can mean that your air bag system won't work properly. See your dealer for service.

**Notice:** If you damage the covering for the driver's or the right front passenger's air bag, the bag may not work properly. You may have to replace the air bag module in the steering wheel or both the air bag module and the instrument panel for the right front passenger's air bag. Do not open or break the air bag coverings.

## Servicing Your Air Bag-Equipped Vehicle

Air bags affect how your vehicle should be serviced. There are parts of the air bag system in several places around your vehicle. You don't want the system to inflate while someone is working on your vehicle. Your dealer and the service manual have information about servicing your vehicle and the air bag system. To purchase a service manual, see *Service Publications Ordering Information* on page 7-10.

### CAUTION:

For up to 10 seconds after the ignition key is turned off and the battery is disconnected, an air bag can still inflate during improper service. You can be injured if you are close to an air bag when it inflates. Avoid yellow connectors. They are probably part of the air bag system. Be sure to follow proper service procedures, and make sure the person performing work for you is qualified to do so.

The air bag system does not need regular maintenance.



## Restraint System Check

### Checking Your Restraint Systems

Now and then, make sure the safety belt reminder light and all your belts, buckles, latch plates, retractors and anchorages are working properly. Look for any other loose or damaged safety belt system parts. If you see anything that might keep a safety belt system from doing its job, have it repaired.

Torn or frayed safety belts may not protect you in a crash. They can rip apart under impact forces. If a belt is torn or frayed, get a new one right away.

Also look for any opened or broken air bag covers, and have them repaired or replaced. (The air bag system does not need regular maintenance.)

## Replacing Restraint System Parts After a Crash

### CAUTION:

**A crash can damage the restraint systems in your vehicle. A damaged restraint system may not properly protect the person using it, resulting in serious injury or even death in a crash. To help make sure your restraint systems are working properly after a crash, have them inspected and any necessary replacements made as soon as possible.**

If you've had a crash, do you need new belts or LATCH system parts?

After a very minor collision, nothing may be necessary. But if the belts were stretched, as they would be if worn during a more severe crash, then you need new parts.

If the LATCH system was being used during a more severe crash, you may need new LATCH system parts.

If belts are cut or damaged, replace them. Collision damage also may mean you will need to have LATCH system, safety belt or seat parts repaired or replaced. New parts and repairs may be necessary even if the belt or LATCH system wasn't being used at the time of the collision.

If an air bag inflates, you'll need to replace air bag system parts. See the part on the air bag system earlier in this section.

📌 NOTES

---

---

---

---

---

---

---

---

---

---

---

---

---

---

---

---

---

---

---

---

---

---

---

---

---

---



## Section 2 Features and Controls

---

<b>Keys</b> .....	2-3	Shifting Into Park (P) .....	2-28
Remote Keyless Entry System .....	2-4	Shifting Out of Park (P) .....	2-30
Remote Keyless Entry System Operation .....	2-5	Parking Over Things That Burn .....	2-30
<b>Doors and Locks</b> .....	2-8	Engine Exhaust .....	2-31
Door Locks .....	2-8	Running Your Engine While You Are Parked .....	2-32
Power Door Locks .....	2-9	<b>Mirrors</b> .....	2-33
Last Door Closed Locking .....	2-9	Manual Rearview Mirror .....	2-33
Programmable Automatic Door Locks .....	2-10	Automatic Dimming Rearview Mirror with OnStar <sup>SM</sup> , Compass and Temperature Display .....	2-33
Lockout Protection .....	2-10	Automatic Dimming Rearview Mirror with Compass and Temperature Display .....	2-34
Leaving Your Vehicle .....	2-11	Outside Power Mirrors .....	2-37
Trunk .....	2-11	Outside Convex Mirror .....	2-37
<b>Windows</b> .....	2-13	<b>OnStar<sup>SM</sup> System</b> .....	2-38
Power Windows .....	2-14	<b>Storage Areas</b> .....	2-40
Sun Visors .....	2-14	Glove Box .....	2-40
<b>Theft-Deterrent Systems</b> .....	2-15	Overhead Console .....	2-40
Content Theft-Deterrent .....	2-15	Center Console Storage Area .....	2-40
PASS-Key <sup>SM</sup> III .....	2-16	Assist Handles .....	2-41
PASS-Key <sup>SM</sup> III Operation .....	2-17	Purse or Litter Bag Holder .....	2-41
<b>Starting and Operating Your Vehicle</b> .....	2-19	Rear Storage Area .....	2-41
New Vehicle Break-In .....	2-19	Convenience Net .....	2-41
Ignition Positions .....	2-19	Trunk Access Panel .....	2-41
Starting Your Engine .....	2-20	<b>Sunroof</b> .....	2-42
Engine Coolant Heater .....	2-23		
Automatic Transaxle Operation .....	2-24		
Parking Brake .....	2-27		

## Section 2    Features and Controls

---

<b>Vehicle Personalization</b> .....	2-43	Remote Driver Unlock Control .....	2-48
Entering Programming Mode .....	2-44	Remote Lock and Unlock Confirmation .....	2-49
Delayed Illumination and Exit Lighting .....	2-44	Content Theft-Deterrent System .....	2-51
Automatic Door Locks .....	2-45	Arming and Disarming the Content Theft-Deterrent System .....	2-52
Last Door Closed Locking and Lockout Protection .....	2-47	Exiting Programming Mode .....	2-53

## Keys

### CAUTION:

Leaving children in a vehicle with the ignition key is dangerous for many reasons. A child or others could be badly injured or even killed.

They could operate the power windows or other controls or even make the vehicle move.

Don't leave the keys in a vehicle with children.



The key can be used for the ignition, as well as the door lock and storage compartments.

When a new key is delivered, it will come with a bar coded tag attached to the key ring. Keep the bar code tag that came with the original keys. Give this tag to your dealer if you need a new key made.

Your vehicle has the PASS-Key<sup>®</sup> III vehicle theft system. The key has a transponder in the key head that matches a decoder in the vehicle's steering column. If a replacement key or an additional key is needed, it must be purchased from your dealer. The key will have PK3 stamped on it.

Any new PASS-Key<sup>™</sup> III key must be programmed before it will start your vehicle. See *PASS-Key<sup>®</sup> III on page 2-16* for more information on programming your new key.

In an emergency, contact Pontiac Roadside Assistance. See *Roadside Assistance Program on page 7-5* for more information.

**Notice:** Your vehicle has a number of features that can help prevent theft. You can have a lot of trouble getting into your vehicle if you ever lock your keys inside. You may even have to damage your vehicle to get in. So be sure you have spare keys.

If your vehicle is equipped with the OnStar system with an active subscription and you lock your keys inside the vehicle, OnStar may be able to send a command to unlock your vehicle. See *OnStar<sup>®</sup> System on page 2-38* for more information.

## Remote Keyless Entry System

Your keyless entry system operates on a radio frequency subject to Federal Communications Commission (FCC) Rules and with Industry Canada.

This device complies with Part 15 of the FCC Rules. Operation is subject to the following two conditions:

1. This device may not cause interference, and
2. This device must accept any interference received, including interference that may cause undesired operation of the device.

This device complies with RSS-210 of Industry Canada. Operation is subject to the following two conditions:

1. This device may not cause interference, and
2. This device must accept any interference received, including interference that may cause undesired operation of the device.

Changes or modifications to this system by other than an authorized service facility could void authorization to use this equipment.

At times you may notice a decrease in range. This is normal for any remote keyless entry system. If the transmitter does not work or if you have to stand closer to your vehicle for the transmitter to work, try this:

- Check the distance. You may be too far from your vehicle. You may need to stand closer during rainy or snowy weather.
- Check the location. Other vehicles or objects may be blocking the signal. Take a few steps to the left or right, hold the transmitter higher, and try again.
- Check to determine if battery replacement is necessary. See "Battery Replacement" under *Remote Keyless Entry System Operation* on page 2-5.
- If you are still having trouble, see your dealer or a qualified technician for service.

## Remote Keyless Entry System Operation

You can lock and unlock your doors or unlock your trunk from about 3 feet (1 m) up to 30 feet (9 m) away using the remote keyless entry transmitter supplied with your vehicle.

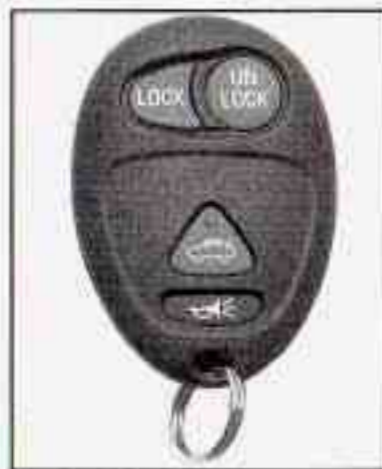



**LOCK:** To lock all the doors, press the LOCK button. See *Power Door Locks* on page 2-9 for more details on power door lock features.

If your vehicle is equipped with the content theft-deterrent system, the LOCK button may arm the system. See *Content Theft-Deterrent* on page 2-15 for more information.



**UNLOCK:** When you press the UNLOCK button, only the driver's door will unlock. If you press UNLOCK again within five seconds, all the doors will unlock. If you would like all the doors to unlock the first time you press UNLOCK, see *Power Door Locks on page 2-9*. The UNLOCK button on the remote keyless entry transmitter will disarm the content theft deterrent system. See *Content Theft-Deterrent on page 2-15* for more details.

 **(Open Trunk):** Press the button with the trunk symbol to open your trunk. The transaxle must be in PARK (P) for this feature to operate.

 **(Remote Alarm):** When you press the button with the horn symbol, the headlamps will flash and the horn will sound. This will allow you to attract attention if needed.

Your vehicle may have Remote Lock/Unlock Confirmation. This feature provides feedback to the holder of the remote keyless entry transmitter that a command has been received by the keyless entry receiver. To signal that a command has been received, the headlamps will flash and the horn may sound briefly. See *Vehicle Personalization on page 2-43* for programming information.

## Matching Transmitter(s) to Your Vehicle

Each remote keyless entry transmitter is coded to prevent another transmitter from unlocking your vehicle. If a transmitter is lost or stolen, a replacement can be purchased through your dealer. Remember to bring any remaining transmitters with you when you go to your dealer. When the dealer matches the replacement transmitter to your vehicle, any remaining transmitters must also be matched. Once your dealer has coded the new transmitter, the lost transmitter will not unlock your vehicle. Each vehicle can have a maximum of four transmitters matched to it.

## Battery Replacement

Under normal use, the battery in your remote keyless entry transmitter should last about three years.

You can tell the battery is weak if the transmitter won't work at the normal range in any location. If you have to get close to your vehicle before the transmitter works, it's probably time to change the battery.

**Notice:** When replacing the battery, use care not to touch any of the circuitry. Static from your body transferred to these surfaces may damage the transmitter.



To replace the battery do the following:

1. Insert a flat object like a coin into the slot on the side of the transmitter and twist to separate the halves.
2. Gently pry the battery out of the transmitter. Do not use the metal flanges to remove the battery.
3. Put the new battery into the transmitter as shown on the transmitter. Use a type CR2032 battery, or equivalent type.
4. Reassemble the transmitter. Make sure the halves are snapped together tightly so water will not get in.
5. Check the transmitter operation.

# Doors and Locks

## Door Locks

### CAUTION:

Unlocked doors can be dangerous.

- Passengers — especially children — can easily open the doors and fall out of a moving vehicle. When a door is locked, the handle won't open it. You increase the chance of being thrown out of the vehicle in a crash if the doors aren't locked. So, wear safety belts properly and lock the doors whenever you drive.
- Young children who get into unlocked vehicles may be unable to get out. A child can be overcome by extreme heat and can suffer permanent injuries or even death from heat stroke. Always lock your vehicle whenever you leave it.
- Outsiders can easily enter through an unlocked door when you slow down or stop your vehicle. Locking your doors can help prevent this from happening.

There are several ways to lock and unlock your vehicle:

To lock or unlock your vehicle from the outside, use your key or remote keyless entry transmitter.



To unlock or lock your doors from inside the vehicle, push the manual lever forward or rearward.

## Power Door Locks

To unlock all doors from inside the vehicle, press the front of the power door lock switch on either front door.

If the content theft-deterrent system is armed, the power door lock switch will not unlock the doors until the system is disarmed. See *Content Theft-Deterrent on page 2-15* for more information on disarming the system.

You can lock all doors from inside the vehicle by pressing the rear of the power lock switch on either front door. The content theft-deterrent system, may be programmed to arm the system when the rear of the power lock switch is pressed. See *Content Theft-Deterrent System on page 2-51* for more details.

## Last Door Closed Locking

The last door closed locking feature makes it more convenient for you to use your power door locks to lock all the doors when leaving your vehicle. When a door is open, three chimes will sound the first time you attempt to lock the doors using the power door lock switch or the keyless entry transmitter. The chimes indicate that the last door closed locking is being used. All doors can be opened for five seconds from the time the last door has been closed. Five seconds after the last door is closed, all doors will lock. You can lock the doors immediately by using the power door lock switch or the remote keyless entry transmitter.

The last door closed locking feature will not activate when the ignition is in RUN or ACCESSORY.

To turn the last door closed locking feature on or off, see *Vehicle Personalization on page 2-43*.

## Programmable Automatic Door Locks

All of the doors will lock automatically when you move your shift lever out of PARK (P). All doors will unlock automatically when the ignition is turned off while the shift lever is in PARK (P). If you prefer to have your doors unlocked automatically at any time, see *Vehicle Personalization on page 2-43*.

If someone needs to get in or out of the vehicle after the doors have been automatically locked, place the shift lever into PARK (P). Unlock all doors using the power door lock switch or unlock the door you want using the inside manual lever. If you have programmed the Automatic Door Locks to unlock the doors when the shift lever is shifted into PARK (P), then the doors will automatically unlock for you. See *Vehicle Personalization on page 2-43* for programming information.

If you don't want the doors to unlock automatically when you turn the ignition off, see *Vehicle Personalization on page 2-43*.

## Lockout Protection

The lockout deterrent feature makes it difficult for you to lock your keys in the vehicle. If the driver's door is open while the keys are in the ignition, you will not be able to use your power door lock switch.

This feature cannot guarantee that you'll never be locked out of your vehicle. If you don't leave the keys in the ignition, or if you use the manual door lock, you could still lock your keys inside your vehicle. Always remember to take your keys with you.

To turn this feature on or off, see *Vehicle Personalization on page 2-43*.

## Leaving Your Vehicle

If you are leaving the vehicle, take your keys, open your door and set the locks from inside. Then get out and close the door.

## Trunk

### CAUTION:

It can be dangerous to drive with the trunk lid open because carbon monoxide (CO) gas can come into your vehicle. You can't see or smell CO. It can cause unconsciousness and even death.

CAUTION: (Continued)

### CAUTION: (Continued)

If you must drive with the trunk lid open or if electrical wiring or other cable connections must pass through the seal between the body and the trunk lid:

- Make sure all other windows are shut.
- Turn the fan on your heating or cooling system to its highest speed and select the control setting that will force outside air into your vehicle. See "Climate Controls" in the Index.
- If you have air outlets on or under the instrument panel, open them all the way.

See "Engine Exhaust" in the Index.

## Trunk Lock

To unlock the trunk from the outside, insert the key into the lock on the trunk and turn it clockwise. You can also press the trunk symbol on the remote keyless entry transmitter.

## Remote Trunk Release

This feature is used to unlock the trunk from inside the vehicle.



Press the TRUNK button located behind the glove box door.

The shift lever must be in PARK (P) for the remote trunk release button to work.

## Emergency Trunk Release Handle

**Notice:** The emergency trunk release handle is not designed to be used to tie down the trunk lid or as an anchor point when securing items in the trunk. Improper use of the emergency trunk release handle could damage it.

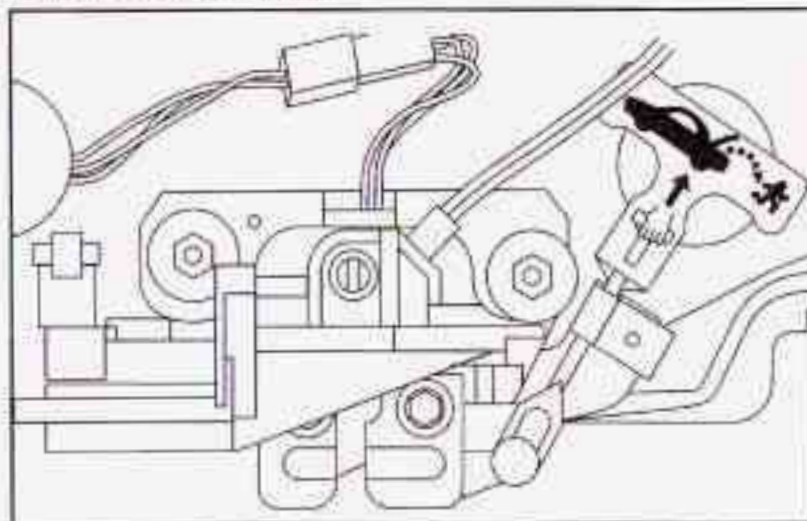

There is a glow-in-the-dark emergency trunk release handle located inside the trunk on the latch. This handle will glow following exposure to light. Pull the release handle to open the trunk from the inside.

## Windows

### **⚠ CAUTION:**

Leaving children in a vehicle with the windows closed is dangerous. A child can be overcome by the extreme heat and can suffer permanent injuries or even death from heat stroke. Never leave a child alone in a vehicle, especially with the windows closed in warm or hot weather.





## Power Windows



Use the switches on the driver's door armrest to operate each of the windows while the ignition is on or while Retained Accessory Power (RAP) is active. See "Retained Accessory Power (RAP)" under *Ignition Positions* on page 2-19 for more information.

In addition, each passenger door has a window switch.

### Express-Down Window

The driver's window switch has an express-down feature. This switch is labeled AUTO. Tap the rear of the switch, and the driver's window will open a small amount. If the rear of the switch is fully pressed and released, the window will go all the way down.

To stop the window while it is lowering, press the front of the switch. To raise the window, press and hold the front of the switch.

### Window Lock-Out

The driver's window switch includes a lock-out feature. Push LOCK OUT to stop front and rear passengers from using their window switches. The driver can still control all the windows with the lock on. Push LOCK OUT again to return to normal window operation. When the colored band on the switch is showing, the passengers can operate their windows.

### Sun Visors

To block out glare, you can swing down the visors. You can also swing them from front to side. The visors also have extenders that you can pull out for added coverage.

### Visor Vanity Mirror

Open the cover on the sun visor to expose the vanity mirror. If the vehicle has the optional lighted vanity mirrors, the lamps come on when you open the cover.

## Theft-Deterrent Systems

Vehicle theft is big business, especially in some cities. Although your vehicle has a number of theft-deterrent features, we know that nothing we put on it can make it impossible to steal.

### Content Theft-Deterrent

Your vehicle has a theft-deterrent alarm system,



A red light located on top of the instrument panel, toward the center of the vehicle and near the windshield, will flash slowly when the system is armed.

While armed, the doors will not unlock with the power door lock switch. The alarm will sound if someone tampers with the trunk lock, enters the vehicle without using the remote keyless entry transmitter or key to unlock the doors, or turns the ignition on. The horn will sound and the headlamps will flash for up to two minutes. The system will also cut off the fuel supply, preventing the vehicle from being driven.

### Arming with the Power Lock Switch

Your alarm system can be programmed to arm when you use either power lock switch to lock the doors while any door is open and the key is removed from the ignition. If you would like to arm the system with the power lock switch, see *Vehicle Personalization on page 2-43*. When programmed, the red light will flash quickly to let you know that the system is ready to arm with the power lock switches. When you press the rear of a power door lock switch, the red light will stop flashing and stay on to let you know that the system is arming. After all the doors are closed and locked, the red light will begin flashing at a very slow rate to let you know the system is armed.

## Arming with the Remote Keyless Entry Transmitter

The alarm system will arm when you use the remote keyless entry transmitter to lock the doors after the key is removed from the ignition. The red light will turn on to let you know the system is arming. After all doors are closed and locked, the red light will begin flashing at a very slow rate to let you know the system is armed.

## Arming Confirmation

If the remote unlock confirmation is on, the headlamps will flash briefly to let you know when the alarm system has armed. See *Vehicle Personalization on page 2-43* for programming information.

## Disarming with the Remote Keyless Entry Transmitter

The alarm system will disarm when you use your remote keyless entry transmitter to unlock the doors. The red light will go off to let you know the system is disarmed.

## Disarming with Your Key

The alarm system will disarm when you use the key to unlock the doors. The red light will stop flashing when the system is disarmed. If you would like the key to disarm the alarm system, see *Vehicle Personalization on page 2-43*.

## PASS-Key® III

Your PASS-Key<sup>®</sup> III system operates on a radio frequency subject to Federal Communications Commission (FCC) Rules and with Industry Canada.

This device complies with Part 15 of the FCC Rules. Operation is subject to the following two conditions: (1) this device may not cause harmful interference, and (2) this device must accept any interference received, including interference that may cause undesired operation.

This device complies with RSS-210 of Industry Canada. Operation is subject to the following two conditions: (1) this device may not cause interference, and (2) this device must accept any interference received, including interference that may cause undesired operation of the device.

Changes or modifications to this system by other than an authorized service facility could void authorization to use this equipment.

PASS-Key<sup>®</sup> III uses a radio frequency transponder in the key that matches a decoder in your vehicle.

## PASS-Key<sup>®</sup> III Operation

Your vehicle is equipped with PASS-Key<sup>®</sup> III (Personalized Automotive Security System) theft-deterrent system. PASS-Key<sup>®</sup> III is a passive theft-deterrent system. This means you don't have to do anything special to arm or disarm the system. It works when you insert or remove the key from the ignition.

When the PASS-Key<sup>®</sup> III system senses that someone is using the wrong key, it shuts down the vehicle's starter and fuel systems. The starter will not work and fuel will stop being delivered to the engine. Anyone using a trial-and-error method to start the vehicle will be discouraged because of the high number of electrical key codes.

When trying to start the vehicle if the engine does not start and the SECURITY light comes on, the key may have a damaged transponder. Turn the ignition off and try again.

If the engine still does not start, and the key appears to be undamaged, try another ignition key. At this time, you may also want to check the fuse, see *Fuses and Circuit Breakers on page 5-97*. If the engine still does not start with the other key, your vehicle needs service. If your vehicle does start, the first key may be faulty. See your dealer who can service the PASS-Key<sup>®</sup> III to have a new key made. In an emergency, contact Pontiac Roadside Assistance. See *Roadside Assistance Program on page 7-5* for more information.

It is possible for the PASS-Key<sup>®</sup> III decoder to learn the transponder value of a new or replacement key. Up to 10 additional keys may be programmed for the vehicle. This procedure is for learning additional keys only. If all the currently programmed keys are lost or do not operate, you must see your dealer or a locksmith who can service PASS-Key<sup>®</sup> III to have keys made and programmed to the system.

See your dealer or a locksmith who can service PASS-Key<sup>®</sup> III to get a new key blank that is cut exactly as the ignition key that operates the system.

**Canadian Owners:** If you lose or damage your keys, only a GM dealer can service PASS-Key<sup>®</sup> III to have new keys made. To program additional keys, you will need two current driver's keys (black in color). You must add a step to the following procedure. After Step 2, repeat Steps 1 and 2 with the second current driver's key (black in color). Then continue with Step 3.

To program the new key do the following:

1. Verify that the new key has PK3 stamped on it.
2. Insert the master key in the ignition and start the engine. If the engine will not start, see your dealer for service.
3. After the engine has started, turn the key to OFF, and remove the key.
4. Insert the key to be programmed and turn it to RUN within five seconds of removing the original key.

5. The SECURITY light will turn off once the key has been programmed. It may not be apparent that the SECURITY light went on due to how quickly the key is programmed.
6. Repeat Steps 1 through 5 if additional keys are to be programmed.

If you are ever driving and the SECURITY light comes on and stays on, you will be able to restart your engine if you turn it off. Your PASS-Key<sup>®</sup> III system, however, is not working properly and must be serviced by your dealer. Your vehicle is not protected by the PASS-Key<sup>®</sup> III system at this time.

If you lose or damage your PASS-Key<sup>®</sup> III key, see your dealer or a locksmith who can service PASS-Key<sup>®</sup> III to have a new key made.

# Starting and Operating Your Vehicle

## New Vehicle Break-In

*Notice:* Your vehicle doesn't need an elaborate "break-in." But it will perform better in the long run if you follow these guidelines:

- Don't drive at any one speed — fast or slow — for the first 500 miles (805 km). Don't make full-throttle starts.
- Avoid making hard stops for the first 200 miles (322 km) or so. During this time your new brake linings aren't yet broken in. Hard stops with new linings can mean premature wear and earlier replacement. Follow this breaking-in guideline every time you get new brake linings.
- Don't tow a trailer during break-in. See "Towing a Trailer" in the Index for more information.

## Ignition Positions

With the key in the ignition switch, you can turn it to five different positions. The ignition switch is located on the right side of the steering column.

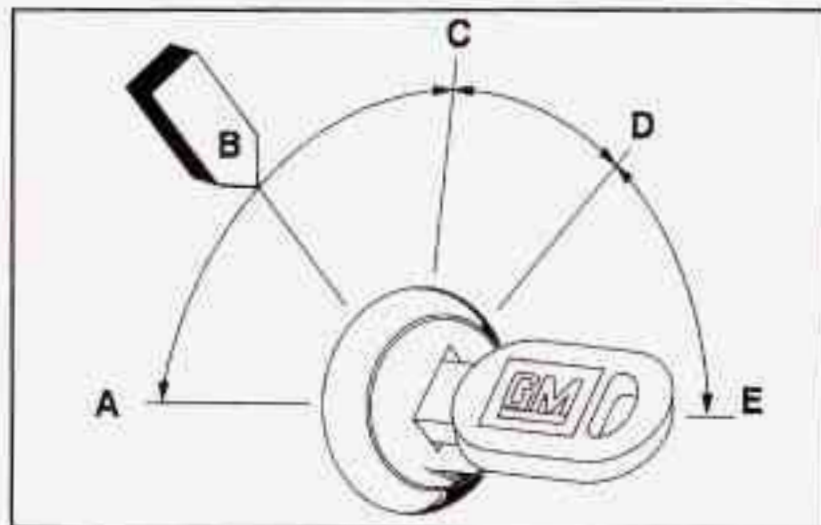

**A (ACCESSORY):** This position lets you use things like the radio and windshield wipers while the engine is off. To use accessory, push in the key and turn it toward you. The steering wheel will stay locked.

**Notice:** If your key seems stuck in LOCK and you can't turn it, be sure you are using the correct key; if so, is it all the way in? Turn the key only with your hand. Using a tool to force it could break the key or the ignition switch. If none of these works, then your vehicle needs service.

**B (LOCK):** This position locks the ignition, steering wheel and transaxle. It's a theft-deterrent feature. It's also the only position from which you can remove the key.

**C (OFF):** This position lets you turn off the engine but still turn the steering wheel. It doesn't lock the steering wheel like LOCK. Use OFF if you must have the vehicle pushed or towed.

**D (RUN):** This position is where the key returns to after you start the vehicle. With the engine off, you can use RUN to display some of the warning and indicator lights.

**E (START):** This position starts the engine.

A warning chime will sound if you open the driver's door while the ignition is in OFF, LOCK or ACCESSORY and the key is in the ignition.

## Retained Accessory Power (RAP)

With Retained Accessory Power, (RAP), the power windows, audio system and sunroof will continue to work up to 10 minutes after the ignition key is turned to OFF and none of the doors are opened.

## Starting Your Engine

Move your shift lever to PARK (P) or NEUTRAL (N). Your engine won't start in any other position – that's a safety feature. To restart while you're already moving, use NEUTRAL (N) only.

**Notice:** Don't try to shift to PARK (P) if your vehicle is moving. If you do, you could damage the transaxle. Shift to PARK (P) only when your vehicle is stopped.

## Shift Lock Release

This vehicle is equipped with an electric shift lock release system. The shift lock release is designed to do the following:

- Prevent ignition key removal unless the shift lever is in PARK (P) with the shift lever button fully released.
- Prevent movement of the shift lever out of PARK (P) unless the ignition is in a position other than OFF or LOCK. The shift lock release is always functional except in the case of a dead or low voltage (less than 9 V) battery.

If your vehicle has a dead battery or a battery with low voltage, there is an override access slot that will allow you to override the shift lock release.



The override access slot is located on the upper right side of the console shift panel.

To use the slot, do the following:

1. Verify that the shift lever is in PARK (P) and that the shift lever button is fully released.
2. Locate the override access slot on the upper right side of the shift panel.

3. Remove the override access slot cap.
4. Insert a key into the access slot, press in and hold.
5. Press the shift lever button in and hold.
6. Remove the key from the slot.
7. Pull the shift lever into the desired gear position.
8. Reinstall the override access slot cap.

You will not be able to remove the key from the ignition unless the shift lever is in the PARK (P) position with the shift lever button fully released.

## Starting Your 3100 V6 Engine

1. With your foot off the accelerator pedal, turn your ignition key to START. When the engine starts, let go of the key. The idle speed will go down as your engine gets warm.

**Notice:** Holding your key in START for longer than 15 seconds at a time will cause your battery to be drained much sooner. And the excessive heat can damage your starter motor. Wait about 15 seconds between each try to help avoid draining your battery or damaging your starter.



2. If your engine won't start (or starts but then stops), it could be flooded with too much gasoline. Try pushing your accelerator pedal all the way to the floor and holding it there as you hold the key in START for not more than 15 seconds at a time. This clears the extra gasoline from the engine.

**Notice:** Your engine is designed to work with the electronics in your vehicle. If you add electrical parts or accessories, you could change the way the engine operates. Before adding electrical equipment, check with your dealer. If you don't, your engine might not perform properly.

## Starting Your 3800 Series II V6 Engine

1. With your foot off the accelerator pedal, turn your ignition key to START. When the engine starts, let go of the key. The idle speed will go down as your engine gets warm.

**Notice:** Holding your key in START for longer than 15 seconds at a time will cause your battery to be drained much sooner. And the excessive heat can damage your starter motor. Wait about 15 seconds between each try to help avoid draining your battery or damaging your starter.

2. If it doesn't start within 10 seconds, hold your key in START for about 10 seconds at a time until your engine starts. Wait about 15 seconds between each try.
3. If your engine still won't start (or starts but then stops), it could be flooded with too much gasoline. Try pushing your accelerator pedal all the way to the floor and holding it there as you hold the key in START for about three seconds. If the vehicle starts briefly but then stops again, do the same thing. This time keep the pedal down for five or six seconds to clear the extra gasoline from the engine. After waiting about 15 seconds, repeat the normal starting procedure.

**Notice:** Your engine is designed to work with the electronics in your vehicle. If you add electrical parts or accessories, you could change the way the engine operates. Before adding electrical equipment, check with your dealer. If you don't, your engine might not perform properly.

## Engine Coolant Heater

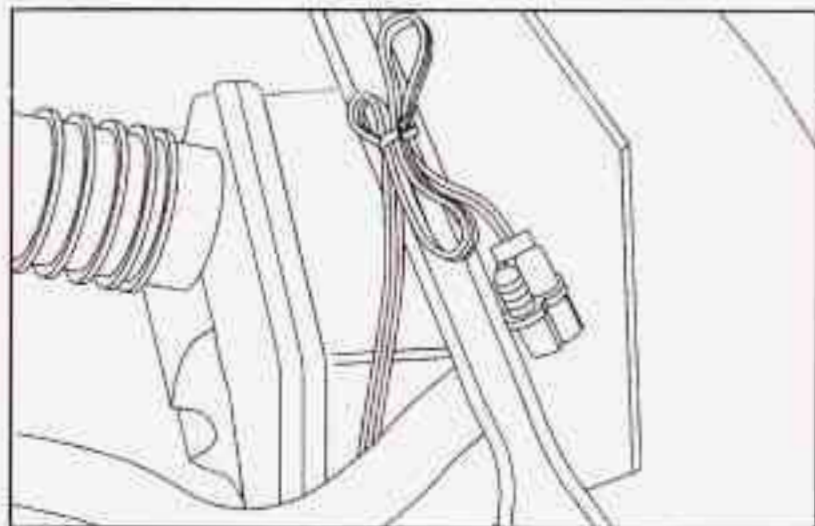

Your vehicle may be equipped with an engine coolant heater. In very cold weather, 0°F (-18°C) or colder, the engine coolant heater can help. You'll get easier starting and better fuel economy during engine warm-up. Usually, the coolant heater should be plugged in a minimum of four hours prior to starting your vehicle. At temperatures above 32°F (0°C), use of the coolant heater is not required.

## To Use the Engine Coolant Heater

1. Turn off the engine.
2. Open the hood and unwrap the electrical cord. The cord is located below the engine air cleaner/filter near the coolant reservoir bottle. See *Engine Compartment Overview* on page 5-12 for more information on location.
3. Plug it into a normal, grounded 110-volt AC outlet.

### **⚠ CAUTION:**

Plugging the cord into an ungrounded outlet could cause an electrical shock. Also, the wrong kind of extension cord could overheat and cause a fire. You could be seriously injured. Plug the cord into a properly grounded three-prong 110-volt AC outlet. If the cord won't reach, use a heavy-duty three-prong extension cord rated for at least 15 amps.

4. Before starting the engine, be sure to unplug and store the cord as it was before to keep it away from moving engine parts. If you don't, it could be damaged.

How long should you keep the coolant heater plugged in? The answer depends on the outside temperature, the kind of oil you have, and some other things. Instead of trying to list everything here, we ask that you contact your dealer in the area where you'll be parking your vehicle. The dealer can give you the best advice for that particular area.

## Automatic Transaxle Operation

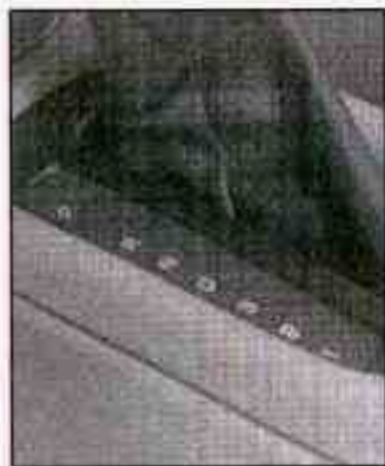

The automatic transaxle has a shift lever on the console between the seats. There is also a display of the gear positions on the instrument panel cluster near the speedometer and tachometer.

Maximum engine speed is limited when your vehicle is in PARK (P) or NEUTRAL (N) to protect driveline components from improper operation.

There are several different positions for the shift lever.

**PARK (P):** This position locks the front wheels. It's the best position to use when you start the engine because the vehicle can't move easily.

### **CAUTION:**

It is dangerous to get out of your vehicle if the shift lever is not fully in PARK (P) with the parking brake firmly set. Your vehicle can roll.

Don't leave your vehicle when the engine is running unless you have to. If you have left the engine running, the vehicle can move suddenly. You or others could be injured. To be sure your vehicle won't move, even when you're on fairly level ground, always set your parking brake and move the shift lever to PARK (P). See "Shifting Into Park (P)" in the Index. If you're pulling a trailer, see "Towing a Trailer" in the Index.

Make sure the shift lever is fully in PARK (P) before starting the engine. The vehicle has an automatic transaxle shift lock control system. You must fully apply the regular brakes and press the shift control button located on the front of the shift lever, before you can shift from PARK (P) when the ignition is in RUN. If you cannot shift out of PARK (P), ease pressure on the shift lever by pushing it all the way into PARK (P) while keeping the brake pedal pushed down. Release the shift lever button. Then move the shift lever out of PARK (P), being sure to press the shift lever button. See *Shifting Out of Park (P)* on page 2-30.

**REVERSE (R):** Use this gear to back up.

**Notice:** Shifting to REVERSE (R) while your vehicle is moving forward could damage your transaxle. Shift to REVERSE (R) only after your vehicle is stopped.

To rock the vehicle back and forth to get out of snow, ice or sand without damaging the transaxle, see *If You Are Stuck: In Sand, Mud, Ice or Snow* on page 4-32.

**NEUTRAL (N):** In this position, the engine doesn't connect with the wheels. To restart when you're already moving, use NEUTRAL (N) only. Also, use NEUTRAL (N) when the vehicle is being towed.

 **CAUTION:**

Shifting into a drive gear while your engine is "racing" (running at high speed) is dangerous. Unless your foot is firmly on the brake pedal, your vehicle could move very rapidly. You could lose control and hit people or objects. Don't shift into a drive gear while your engine is racing.

**Notice:** Damage to your transaxle caused by shifting into a drive gear with the engine racing isn't covered by your warranty.

**AUTOMATIC OVERDRIVE (ⓓ):** This position is for normal driving. If you need more power for passing, and you're:

- Going less than 35 mph (55 km/h), push your accelerator pedal about halfway down.
- Going about 35 mph (55 km/h) or more, push the accelerator pedal all the way down.

You'll shift down to the next gear and have more power.

**Notice:** If your vehicle seems to start up rather slowly, or if it seems not to shift gears as you go faster, something may be wrong with a transaxle system sensor. If you drive very far that way, your vehicle can be damaged. So, if this happens, have your vehicle serviced right away. Until then, you can use **SECOND (2)** when you are driving less than 35 mph (55 km/h) and **AUTOMATIC OVERDRIVE (D)** for higher speeds.

**THIRD (3):** This position is also used for normal driving, but it offers more power and lower fuel economy than **AUTOMATIC OVERDRIVE (D)**.

Here are some times you might choose **THIRD (3)** instead of **AUTOMATIC OVERDRIVE (D)**:

- When driving on hilly, winding roads.
- When towing a trailer, so there is less shifting between gears.
- When going down a steep hill.
- When driving in non-highway scenarios (i.e. city streets, etc.).

**SECOND (2):** This position gives you more power but lower fuel economy than **THIRD (3)**. You can use **SECOND (2)** on hills. It can help control your speed as you go down steep mountain roads, but then you would also want to use your brakes off and on.

**Notice:** Don't drive in **SECOND (2)** for more than 25 miles (40 km), or at speeds over 55 mph (90 km/h), or you can damage your transaxle. Use **THIRD (3)** or **AUTOMATIC OVERDRIVE (D)** as much as possible. Don't shift into **SECOND (2)** unless you are going slower than 65 mph (105 km/h) or you can damage your engine.

**FIRST (1):** This position gives you even more power but lower fuel economy than **SECOND (2)**. You can use it on very steep hills, or in deep snow or mud. If the shift lever is in **FIRST (1)**, the transaxle won't shift into first gear until the vehicle is going slowly enough.

**Notice:** If your front wheels won't turn, don't try to drive. This might happen if you were stuck in very deep sand or mud or were up against a solid object. You could damage your transaxle. Also, if you stop when going uphill, don't hold your vehicle there with only the accelerator pedal. This could overheat and damage the transaxle. Use your brakes to hold your vehicle in position on a hill.

## Parking Brake



The parking brake is located to the left of the brake pedal near the driver's door.

To set the parking brake, hold the regular brake pedal down with the right foot. Push down on the parking brake pedal, with the left foot.

To release the parking brake, hold the regular brake pedal down with the right foot and push the parking brake pedal with the left foot. When you lift the left foot, the parking brake pedal will follow it to the released position.

A warning chime will sound if the parking brake is set, the ignition is on and the shift lever is not in PARK (P) or NEUTRAL (N).

**Notice:** Driving with the parking brake on can cause your rear brakes to overheat. You may have to replace them, and you could also damage other parts of your vehicle.

If you are towing a trailer and parking on a hill, see *Towing a Trailer on page 4-37*. That section shows what to do first to keep the trailer from moving.

## Shifting Into Park (P)

### CAUTION:

It can be dangerous to get out of your vehicle if the shift lever is not fully in PARK (P) with the parking brake firmly set. Your vehicle can roll. If you have left the engine running, the vehicle can move suddenly. You or others could be injured. To be sure your vehicle won't move, even when you're on fairly level ground, use the steps that follow. If you're pulling a trailer, see "Towing a Trailer" in the Index.

1. Hold the brake pedal down with your right foot and set the parking brake.

2. Move the shift lever into PARK (P) like this:

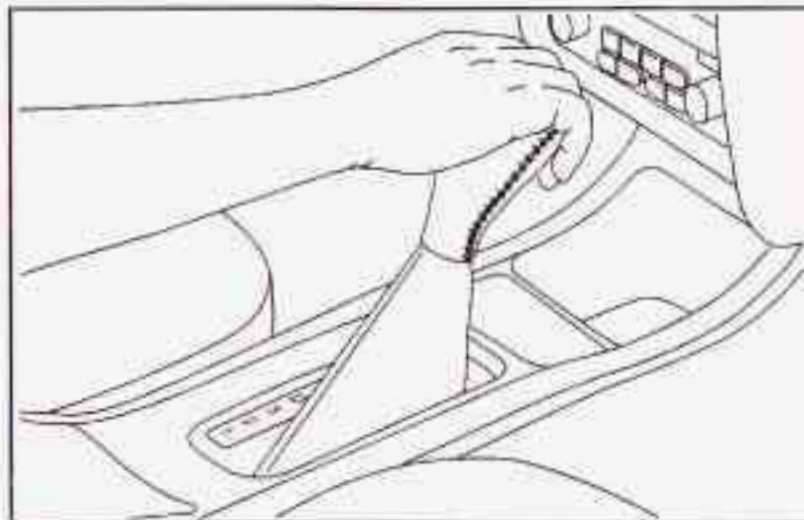

- Press in and hold the shift lever button, located on the front of the shift lever.
  - Push the lever all the way toward the front of the vehicle.
3. Turn the ignition key to LOCK.
  4. Remove the key and take it with you. If you can leave your vehicle with the ignition key in your hand, your vehicle is in PARK (P).

## Leaving Your Vehicle With the Engine Running

### CAUTION:

It can be dangerous to leave your vehicle with the engine running. Your vehicle could move suddenly if the shift lever is not fully in PARK (P) with the parking brake firmly set. And, if you leave the vehicle with the engine running, it could overheat and even catch fire. You or others could be injured. Don't leave your vehicle with the engine running.

If you have to leave your vehicle with the engine running, be sure the vehicle is in PARK (P) and the parking brake is firmly set before you leave it. After you've moved the shift lever into PARK (P), hold the regular brake pedal down. Then, see if you can move the shift lever away from PARK (P) (without first pushing the shift lever button). If you can, it means that the shift lever wasn't fully locked into PARK (P).

## Torque Lock

If you are parking on a hill and you don't shift your transaxle into PARK (P) properly, the weight of the vehicle may put too much force on the parking pawl in the transaxle. You may find it difficult to pull the shift lever out of PARK (P). This is called "torque lock". To prevent torque lock, set the parking brake and then shift into PARK (P) properly before you leave the driver's seat. To find out how, see *Shifting Into Park (P)* on page 2-28.

When you are ready to drive, move the shift lever out of PARK (P) *before* you release the parking brake.

If torque lock does occur, you may need to have another vehicle push yours a little uphill to take some of the pressure from the parking pawl in the transaxle, so you can pull the shift lever out of PARK (P).



## Shifting Out of Park (P)

Your vehicle has an automatic transaxle shift lock control system. You must fully apply your regular brakes before you can shift from PARK (P) while the ignition is in RUN. See *Automatic Transaxle Operation* on page 2-24.

If you cannot shift out of PARK (P), ease pressure on the shift lever by pushing it all the way into PARK (P) while keeping the brake pedal down. Release the shift lever button. Then move the shift lever out of PARK (P), being sure to press the shift lever button.

## Parking Over Things That Burn

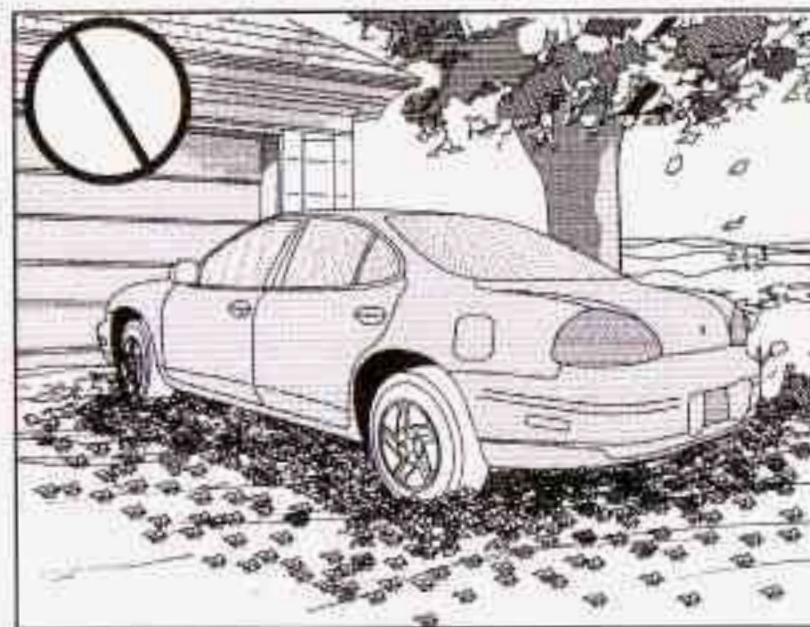

### CAUTION:

Things that can burn could touch hot exhaust parts under your vehicle and ignite. Don't park over papers, leaves, dry grass or other things that can burn.

## Engine Exhaust

### CAUTION:

Engine exhaust can kill. It contains the gas carbon monoxide (CO), which you can't see or smell. It can cause unconsciousness and death.

You might have exhaust coming in if:

- Your exhaust system sounds strange or different.
- Your vehicle gets rusty underneath.
- Your vehicle was damaged in a collision.
- Your vehicle was damaged when driving over high points on the road or over road debris.

CAUTION: (Continued)

### CAUTION: (Continued)

- Repairs weren't done correctly.
- Your vehicle or exhaust system had been modified improperly.

If you ever suspect exhaust is coming into your vehicle:

- Drive it only with all the windows down to blow out any CO; and
- Have your vehicle fixed immediately.

## Running Your Engine While You Are Parked

It's better not to park with the engine running. But if you ever have to, here are some things to know.

### CAUTION:

Idling the engine with the climate control system off could allow dangerous exhaust into your vehicle. See the earlier Caution under "Engine Exhaust."

Also, idling in a closed-in place can let deadly carbon monoxide (CO) into your vehicle even if the fan is at the highest setting. One place this can happen is a garage. Exhaust — with CO — can come in easily. NEVER park in a garage with the engine running.

Another closed-in place can be a blizzard. See "Winter Driving" in the Index.

### CAUTION:

It can be dangerous to get out of your vehicle if the shift lever is not fully in PARK (P) with the parking brake firmly set. Your vehicle can roll. Don't leave your vehicle when the engine is running unless you have to. If you've left the engine running, the vehicle can move suddenly. You or others could be injured. To be sure your vehicle won't move, even when you're on fairly level ground, always set your parking brake and move the shift lever to PARK (P).

Follow the proper steps to be sure your vehicle won't move. See *Shifting Into Park (P)* on page 2-28.

If you are parking on a hill and if you're pulling a trailer, also see *Towing a Trailer* on page 4-37.

## Mirrors

### Manual Rearview Mirror

To reduce glare from lamps behind you, pull the lever located in the center of the bottom of the mirror toward you to the night position. To return the mirror back to the day position, push the lever away from you.

### Automatic Dimming Rearview Mirror with OnStar<sup>®</sup>, Compass and Temperature Display

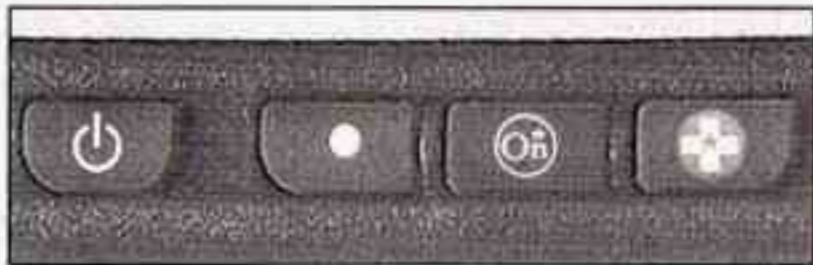

Your vehicle may have an automatic-dimming rearview mirror with a compass and temperature display and the OnStar<sup>®</sup> system.

The mirror also has an eight-point compass and temperature display in the upper right corner on the mirror face and a three-button OnStar<sup>®</sup> system.

When the automatic dimming feature is turned on, the mirror automatically changes to reduce glare from headlamps behind you. A photocell on the mirror senses when it is becoming dark outside. Another photocell built into the mirror face senses when headlamps are behind you.

At night, when the glare is too bright, the mirror will gradually darken to reduce glare. This change may take a few seconds. The mirror will return to its clear, daytime state when the glare is reduced.

### Mirror Operation

**⏻ (On/Off):** The button with this symbol is the on/off button for the mirror functions such as automatic dimming and temperature display. It is the far left button located on the lower part of the mirror face.

A light on the mirror will be lit while the feature is turned on.

## Temperature Display

Press the on/off button to change the temperature display. You can select °F, °C, or turn the display off.

## Compass Operation

There is a compass display in the window in the upper right corner of the mirror face. The compass displays a maximum of two characters. For example, NE is displayed for north-east.

The compass may need to be calibrated. See "Compass Calibration" under *Automatic Dimming Rearview Mirror with Compass and Temperature Display* on page 2-34 for more information.

The other three buttons are for the OnStar<sup>®</sup> system. See your dealer for more information on the system and how to subscribe to OnStar<sup>®</sup>. See *OnStar<sup>®</sup> System* on page 2-38 for more information about the services OnStar<sup>®</sup> provides.

## Automatic Dimming Rearview Mirror with Compass and Temperature Display



Your vehicle may have an automatic-dimming rearview mirror with a compass and temperature display.

When turned on, this mirror automatically dims to the proper level to minimize glare from headlamps behind you after dark.

The mirror has an eight-point compass and temperature display in the upper right corner of the mirror face. The display shows the current outside temperature and the vehicle's current direction.

## Mirror Operation

The automatic dimming feature is turned on or off by briefly pressing the COMP button located on the bottom of the mirror face. A light on the mirror will be lit while the feature is turned on. It will go out while the feature is turned off.

## Temperature Display

The TEMP button located on the bottom of the mirror face changes the temperature display. You can select °F, °C, or turn the display off.

## Compass Variance

Press the COMP button once briefly to turn the compass on or off. When on, the display will show the compass direction, with a maximum of two characters. For example, NE is displayed for north-east.

## Compass Calibration

Press and hold the COMP button down for six seconds to activate the compass calibration mode. If your vehicle has the optional mirror with the compass, temperature display and OnStar system, press the on/off button for nine seconds.

CAL will be displayed in the compass/temperature window on the mirror.

The mirror can be calibrated in one of two ways:

- Drive the vehicle in circles at 5 mph (8 km/h) or less until CAL is no longer displayed in the compass window.
- Drive the vehicle on your everyday routine. (This method may take longer to calibrate).

## Compass Variation

Compass variance is the difference between earth's magnetic north and true geographic north. If not adjusted to account for compass variance, your compass could give false readings. The mirror is set to zone eight upon leaving the factory. It will be necessary to adjust the compass to compensate for compass variance if you live outside zone eight. Under certain circumstances, such as during a long distance cross-country trip, it will be necessary to adjust for compass variance.

To adjust for compass variance, do the following:

1. Find your current location and variance zone number on the map.

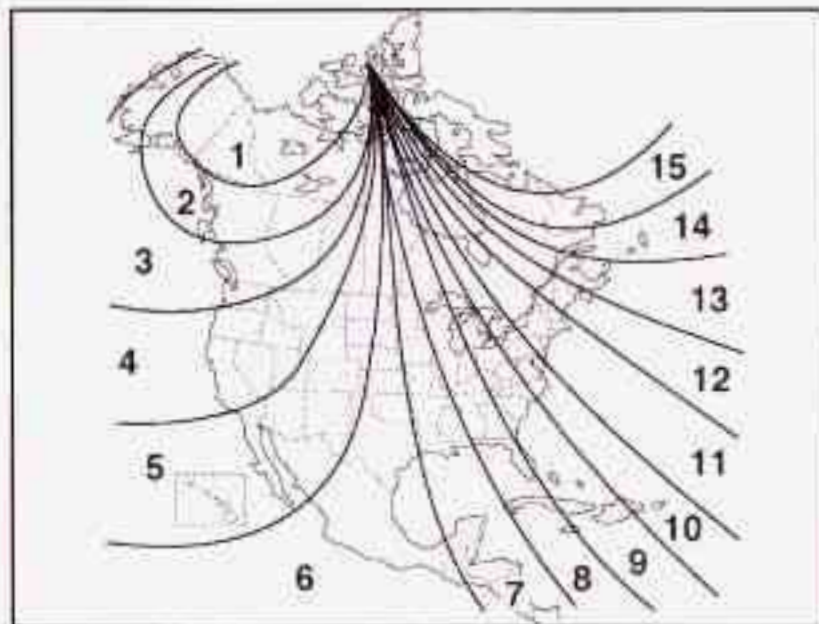

2. Press and hold the COMP button for three seconds. If your vehicle has the optional mirror with the compass, temperature display and OnStar<sup>®</sup> system, press the on/off button for six seconds. Release the button when ZONE is displayed. The number shown is the current zone number.
3. Scroll through the zone numbers that appear in the compass/temperature window on the mirror by pressing the COMP button or the on/off button. Once you find your zone number, release the button. After about four seconds, the mirror will return to the compass and temperature display, and the new zone number will be set.

## Outside Power Mirrors



The power mirror control is located near the driver's window, on the armrest.

Turn the control counterclockwise to adjust the left mirror or clockwise to adjust the right mirror. Then move the control in the direction you want the mirror to go.

## Outside Convex Mirror

Your passenger's side mirror is convex. A convex mirror's surface is curved so you can see more from the driver's seat.

### CAUTION:

A convex mirror can make things (like other vehicles) look farther away than they really are. If you cut too sharply into the right lane, you could hit a vehicle on your right. Check your inside mirror or glance over your shoulder before changing lanes.



## OnStar<sup>®</sup> System

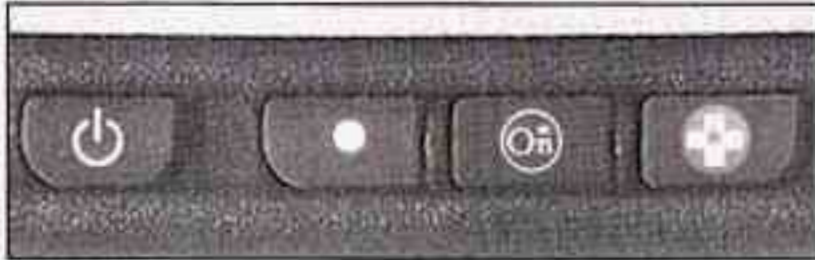

OnStar<sup>™</sup> uses global positioning system (GPS) satellite technology, wireless communications, and state of the art call centers to provide you with a wide range of safety, security, information and convenience services. An OnStar<sup>™</sup> subscription plan is included in the price of your vehicle. You can easily upgrade or extend your OnStar<sup>™</sup> services to meet your personal needs.

A complete OnStar<sup>™</sup> user's guide and the terms and conditions of the OnStar<sup>™</sup> Subscription Service Agreement are included in your OnStar<sup>™</sup>-equipped vehicle's glove box literature. For more information, visit [www.onstar.com](http://www.onstar.com), contact OnStar<sup>™</sup> at 1-888-4-ONSTAR (1-888-466-7827), or press the blue OnStar<sup>™</sup> button to speak to an OnStar<sup>™</sup> advisor 24 hours a day, 7 days a week.

## OnStar<sup>™</sup> Services

OnStar<sup>™</sup> provides a number of service plans to closely meet your needs. Some of the services currently provided by OnStar<sup>™</sup> are:

- Automatic Notification of Air Bag Deployment
- Emergency Services
- Roadside Assistance Stolen Vehicle Tracking
- AccidentAssist
- Remote Door Unlock
- Remote Diagnostics
- OnStar<sup>™</sup> MED-NET (Requires separate activation and annual fee on some plans)
- Online and Personal Concierge Services
- Route Support
- RideAssist
- Information and Convenience Services

## **OnStar<sup>®</sup> Personal Calling**

With OnStar<sup>™</sup> Personal Calling, you have a safer way to stay connected while driving. It's a hands-free wireless phone that's integrated into your vehicle. You can place calls nationwide using voice-activated dialing with no contracts, no roaming charges and no access fees. To find out more about OnStar<sup>™</sup> Personal Calling, refer to the OnStar<sup>™</sup> owner's guide in your vehicle's glove box, or call OnStar<sup>™</sup> at 1-888-4-ONSTAR (1-888-466-7827).

## **OnStar<sup>®</sup> Virtual Advisor**

With OnStar<sup>™</sup> Virtual Advisor you can listen to your favorite news, entertainment and information topics, such as traffic and weather reports, stock quotes and sports scores. You listen to your e-mail through your vehicle's speakers, and reply with your hands on the wheel and your eyes on the road.

A completed Subscription Service Agreement is required prior to delivery of OnStar<sup>™</sup> services and prepaid calling minutes are also required for OnStar<sup>™</sup> Personal Calling and OnStar<sup>™</sup> Virtual Advisor use. Terms and conditions of the Subscription Service Agreement can be found at [www.onstar.com](http://www.onstar.com).

## Storage Areas

### Glove Box

Use your key to lock and unlock the glove box. To open, lift the right side of the latch.

### Overhead Console

The overhead console has reading lamps and storage compartments including one for your garage door opener and one for sunglasses.

#### Garage Door Opener Compartment

You can store your garage door opener in the rear compartment of the overhead console, and operate it from this position. To install your garage door opener, follow these instructions:

1. Open the compartment by pressing the latch forward. Remove the hook and loop patch.
2. Peel the protective backing from the hook and loop patch and press it firmly to the back of your garage door opener.

3. Be sure that the button on your garage door opener is centered above the area with raised lines on the compartment door. Make sure the button is facing down and press the opener firmly into place.
4. Add one peg at a time until your garage door opener operates with the compartment door closed while pressing the button.

#### Sunglasses Storage Compartment

The sunglasses storage compartment is the second compartment from the rear on the overhead console. To open the sunglasses storage compartment, press the release latch forward and pull the compartment down to the full open position.

#### Center Console Storage Area

To open the armrest storage area, pull up on the front edge of the latch. The console has cassette and CD storage.

The center console also contains two cupholders.

Below the center ashtray is an open storage compartment. In front of this, you may have a smaller compartment.

## Assist Handles

An assist handle with a reading lamp is located over each rear side window. The handle can be used to help you get in or out of the vehicle. Press the reading lamp to turn it on. Press it again to turn it off.

## Purse or Litter Bag Holder

On the front of the center console, to the right of the accessory power outlet, there is a hook that can be used to hold a purse or litter bag.

## Rear Storage Area

If you have a trunk access panel, you will also have a pull down armrest that contains an open storage bin and two cupholders.

## Convenience Net

The vehicle may have a convenience net. You'll see it on the back wall of the trunk.

Put small loads, like grocery bags, behind the net. It can help keep them from falling over during sharp turns or quick starts and stops.

The net isn't for larger, heavier loads, which should be stored in the trunk as far forward as possible.

You can unhook the net so that it will lie flat when you're not using it.

## Trunk Access Panel

If the vehicle has rear seat armrests, you will also have a trunk access panel.



This feature allows access to the trunk from the rear seat area. To use the trunk access panel, pull the rear armrest down, unlock the access panel with the ignition key and pull it down.

## Sunroof

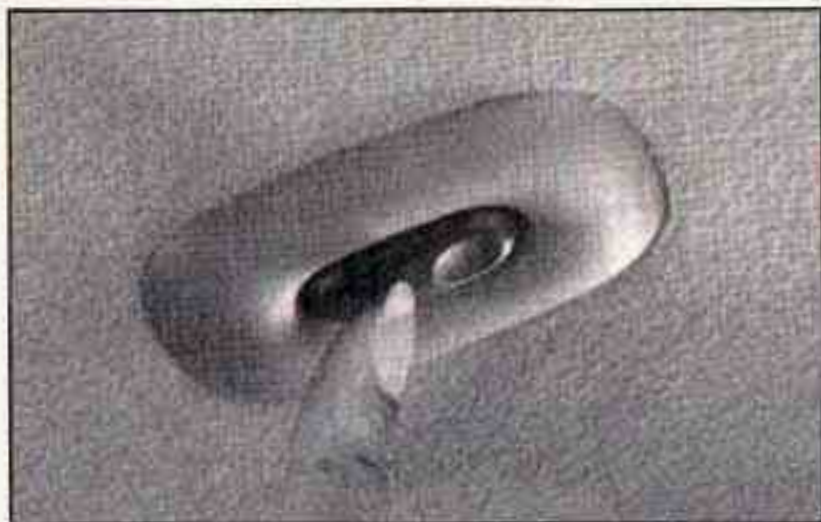

**Base Version Shown**

Your vehicle may be equipped with a sunroof. The sunroof includes a sliding glass panel and a one-piece sunshade. The switch to control the sunroof is located in the headliner on the roof panel. The switch works only while the ignition is on or RAP is active. See *Ignition Positions on page 2-19*.

**Vent:** Push the rear of the switch once and the sunroof will open to the vent position only. You will need to open the sunshade by hand.

**Open/Express-Open:** Push the rear of the switch a second time and the sunroof will open the remainder of the way. This is the express-open feature.

**Close:** Push and hold the front of the switch until the sunroof motor stops. The sunshade must be closed by hand.

## Vehicle Personalization

Your vehicle's locks and lighting systems can be programmed with several different features. The features you can program depend on the options that came with your vehicle. The following chart shows the features that can be programmed. To determine which features your vehicle is equipped with, follow the steps listed for entering the programming mode.

Feature							
Number of Chimes Sounded	Delayed Illumination/ Exit Lighting	Automatic Door Locks	Last Door Closed Locking/ Lockout Deterrent	Remote Driver's Door Unlock Control	Remote Lock/ Unlock Confirmation	Content Theft	Content Theft Arming/ Disarming
2	X	X	X	—	—	—	—
3	X	X	X	X	—	—	—
4	X	X	X	X	X	X	X

## Entering Programming Mode

To program features, your vehicle must be in this programming mode. Follow these steps:

1. Turn the ignition key to LOCK or OFF.
2. Remove the MALL PGM fuse from the instrument panel fuse block. See *Fuses and Circuit Breakers on page 5-97*.
3. Turn the ignition key to ACCESSORY.
4. Count the number of chimes you hear. You will hear up to four chimes, depending on vehicle content. See "Vehicle Personalization" listed previously.

You can now program your choices. After programming a feature, you can exit the programming mode at any time.

## Delayed Illumination and Exit Lighting

With delayed illumination, the interior lamps will stay on for about 25 seconds after all doors are closed.

With exit lighting, the interior lamps will come on and stay on for about 25 seconds whenever you remove the key from the ignition.

## Programmable Modes

**Mode 1:** Both Features Off – The interior lamps will turn on or off at the same instant that a door is opened or closed.

**Mode 2:** Delayed Illumination Only –The interior lamps will stay on for about 25 seconds after all the doors are closed, or until you lock the doors.

**Mode 3:** Exit Lighting Only –The interior lamps will come on whenever you remove the key from the ignition and stay on for about 25 seconds, or until you lock the doors.

**Mode 4:** Both Features On –This combines Modes 2 and 3.

Before your vehicle was shipped from the factory, it was programmed to Mode 4. The mode to which your vehicle was programmed may have been changed since it left the factory. To determine the mode to which your vehicle is programmed or to program your vehicle to a different mode, do the following:

1. Follow the instructions for *Entering Programming Mode on page 2-44*.
2. Turn the interior lamps thumbwheel all the way to the right and then back slightly to the left.

3. Count the number of chimes you hear. The number of chimes tells you which mode your vehicle is set for. If you do not wish to change the current mode, you can either exit the programming mode by following the instructions later in this section or program the next feature available on your vehicle.
4. Turn the interior lamps thumbwheel all the way to the right and then back slightly to the left again to change the current mode.
5. Repeat Step 4 until you hear the number of chimes that matches the number of the mode you want.

The mode you selected is now set. You can either exit the programming mode by following the instructions later in this section or program the next feature available on your vehicle. See *Exiting Programming Mode* on page 2-53.

## Automatic Door Locks

With automatic door locks, all doors will automatically lock when you shift out of PARK (P) and automatically unlock when the ignition is turned to OFF.

## Programmable Modes

**Mode 1:** Both Features Off – Automatic door locking and unlocking are disabled. You will always need to lock your doors manually before driving to increase occupant safety.

- All doors will lock when you press the power door lock switch rearward or when you press the LOCK on the remote keyless entry transmitter (if equipped).
- All doors will unlock when you press the power door lock switch forward or when you press UNLOCK on the remote keyless entry transmitter (if equipped).

**Mode 2:** Automatic Door Locking Only

- Automatic Door Unlocking: The automatic door unlock feature is turned off.
- Automatic Door Locking: Shift out of PARK (P) with the ignition on and the driver's door closed, all doors will lock automatically.



### Mode 3: Automatic Unlocking with the Ignition Off

- Automatic Door Unlocking: Turn off the ignition with the transaxle in PARK (P) and all doors will unlock automatically.
- Automatic Door Locking: Shift out of PARK (P) with the ignition on and the driver's door closed and all doors will lock automatically.

### Mode 4: Automatic Unlocking and Locking with Transaxle in PARK (P)

- Automatic Door Unlocking: Shift into PARK (P) with the ignition on and all doors will unlock automatically.
- Automatic Door Locking: Shift out of PARK (P) with the ignition on and the driver's door closed and all doors will lock automatically.

Before your vehicle was shipped from the factory, it was programmed to Mode 3. The mode to which your vehicle was programmed may have been changed since it left the factory.

To determine the mode to which your vehicle is programmed or to program your vehicle to a different mode, do the following:

1. Follow the instructions for *Entering Programming Mode* on page 2-44.
2. Press LOCK on the power door lock switch.
3. Count the number of chimes you hear. The number of chimes tells you which mode your vehicle is set for. If you do not wish to change the current mode, you can either exit the programming mode by following the instructions later in this section or program the next feature available on your vehicle.
4. Press LOCK on the power door lock switch again to change the current mode.
5. Repeat Step 4 until you hear the number of chimes that matches the mode you want.

The mode you selected is now set. You can either exit the programming mode by following the instructions later in this section or program the next feature available on your vehicle. See *Exiting Programming Mode* on page 2-53.

## Last Door Closed Locking and Lockout Protection

With the last door closed locking and lockout prevention features, your vehicle will do the following:

- If you leave your key in the ignition and leave the driver's door open, you won't be able to use the power door lock switches to lock the doors.
- The doors will not lock when you press LOCK on the driver's door arm rest or the lock button on the remote keyless entry transmitter (if equipped) while any door is open. Instead, you will hear three chimes which let you know that the last door closed locking feature is in operation. Five seconds after all the doors are closed, all the doors will automatically lock.

## Programmable Modes

**Mode 1:** Both Features Off – Doors will always lock immediately when you press LOCK on the driver's door armrest or the remote keyless entry transmitter, if equipped.

**Mode 2:** Lockout Prevention Only - If you leave your key in the ignition with the driver's door open, you will not be able to lock the doors using your power locks.

**Mode 3:** Last Door Closed Locking Only - If the power door lock switch or remote keyless entry transmitter, if equipped, is used to lock the vehicle while any door is open and the key is out of the ignition, you will hear three chimes. The doors will not lock. Five seconds after the last door is closed, all doors will lock.

**Mode 4:** Both Features On – This combines Modes 2 and 3.

Before your vehicle was shipped from the factory, it was programmed to Mode 4. The mode to which your vehicle was programmed may have changed since it left the factory. To determine the mode to which your vehicle is programmed or to program your vehicle to a different mode, do the following:

1. Follow the instructions for *Entering Programming Mode* on page 2-44.
2. Press UNLOCK on the driver's door armrest or the unlock button on the remote keyless entry transmitter.

3. Count the number of chimes you hear. The number of chimes tells you which mode your vehicle is set for. If you do not wish to change the current mode, you can either exit the programming mode by following the instructions later in this section or program the next feature available on your vehicle.
4. Press UNLOCK again to change the current mode.
5. Repeat Step 4 until you hear the number of chimes that matches the mode you want.

The mode you selected is now set. You can either exit the programming mode by following the instructions later in this section or program the next feature available on your vehicle. See *Exiting Programming Mode on page 2-53*.

## Remote Driver Unlock Control

With the remote driver's unlock control feature, if equipped, you can program your vehicle to do the following:

- When you press UNLOCK on your remote keyless entry transmitter, the driver's door will unlock, and
- when you press UNLOCK on your remote keyless entry transmitter again within five seconds, all doors will unlock.

## Programmable Modes

**Mode 1:** Remote All Doors Unlock – When you press UNLOCK on the remote keyless entry transmitter once, all doors will unlock.

**Mode 2:** Remote Driver's Door and All Doors Unlock – When you press UNLOCK on the remote keyless entry transmitter once, the driver's door will unlock. If you press UNLOCK again within five seconds, all doors will unlock.

Before your vehicle was shipped from the factory, it was programmed to Mode 2. The mode to which your vehicle was programmed may have been changed since it left the factory. To determine the mode to which your vehicle is programmed or to program your vehicle to a different mode, do the following:

1. Follow the instructions for *Entering Programming Mode on page 2-44*.
2. Press UNLOCK on the remote keyless entry transmitter.
3. Count the number of chimes you hear. The number of chimes tells you which mode the vehicle is set for. If you do not wish to change the current mode, you can either exit the programming mode by following the instructions later in this section or program the next feature available on your vehicle.

4. Press UNLOCK on the remote keyless entry transmitter again to change the current mode.
5. Repeat Step 4 until you hear the number of chimes that matches the mode you want.

The mode you selected is now set. You can either exit the programming mode by following the instructions later in this section or program the next feature available on your vehicle. See *Exiting Programming Mode on page 2-53*.

## Remote Lock and Unlock Confirmation

With the remote lock and unlock confirmation feature, if equipped, you can program your vehicle to do the following:

- When you use the remote keyless entry transmitter to lock your vehicle, your headlamps will flash to let you know the command has been received. If you press LOCK on the remote keyless entry transmitter again within five seconds, the horn will sound briefly and the headlamps will flash to let you know your vehicle is locked.
- When you use the remote keyless entry transmitter to unlock your vehicle, your headlamps will flash to let you know the command has been received.

## Programmable Modes

**Mode 1:** Both Features Off - Remote lock and unlock confirmation are disabled.

**Mode 2:** Exterior Lamps Flash Only

- Remote Lock Confirmation: When you use the remote keyless entry transmitter to lock the vehicle, the headlamps will flash to let you know the command is received.
- Remote Unlock Confirmation: When you use the remote keyless entry transmitter to unlock the vehicle or open the trunk, the headlamps will flash to let you know when the command is received.

**Mode 3:** Exterior Lamps Flash and Horn Sound

- Remote Lock Confirmation: When you use the remote keyless entry transmitter to lock the vehicle, the horn will sound briefly and the headlamps will flash to let you know the command is received.
- Remote Unlock Confirmation: When you use the remote keyless entry transmitter to unlock the vehicle or open the trunk, the headlamps will flash to let you know the command is received.

**Mode 4:** Exterior Lamps and Horn Sound - on second LOCK press only.

- **Remote Lock Confirmation:** When you use the remote keyless entry transmitter to lock the vehicle, the headlamps will flash to let you know the command is received. The horn will sound briefly and the headlamps will flash if you press the LOCK button again within five seconds.
- **Remote Unlock Confirmation:** When you use the remote keyless entry transmitter to unlock the vehicle or open the trunk, the headlamps will flash to let you know the command is received.

Before your vehicle was shipped from the factory, it was programmed to Mode 4. The mode to which your vehicle was programmed may have been changed since it left the factory. To determine the mode to which your vehicle is programmed or to program your vehicle to a different mode, do the following:

1. Follow the instructions for *Entering Programming Mode on page 2-44*.
2. Press the LOCK button on the remote keyless entry transmitter.

3. Count the number of chimes you hear. The number of chimes tells you which mode the vehicle is set for. If you do not wish to change the current mode, you can either exit the programming mode by following the instructions later in this section or program the next feature available on your vehicle.
4. Press LOCK on the remote keyless entry transmitter again to change the current mode.
5. Repeat Step 4 until you hear the number of chimes that matches the number of the mode you want.

The mode you selected is now set. You can either exit the programming mode by following the instructions later in this section or program the next feature available on your vehicle. See *Exiting Programming Mode on page 2-53*.

## Content Theft-Deterrent System

Your vehicle is equipped with a content theft-deterrent alarm system. Once armed, the system will go off if someone tries to enter the vehicle without using the remote keyless entry transmitter or the correct key, or when someone turns the ignition on with an incorrect key. The horn will sound, and your vehicle's headlamps will flash for about two minutes.

### Programmable Modes

**Mode 1:** Not Used

**Mode 2:** Content Theft On – If anyone tampers with the trunk lock or opens a door while the content theft-deterrent system is armed, an alarm will sound and the headlamps will flash for up to two minutes.

**Mode 3:** Content Theft Off – The content theft-deterrent system is always disarmed.

**Mode 4:** Not Used

Before your vehicle was shipped from the factory, it was programmed to Mode 2. The mode to which your vehicle was programmed may have been changed since it left the factory.

To determine the mode to which your vehicle is programmed or to program your vehicle to a different mode, do the following:

1. Follow the instructions for *Entering Programming Mode* on page 2-44.
2. Turn the parking lamps on, then off.
3. Count the number of chimes you hear. The number of chimes tells you which mode the vehicle is set for. If you do not wish to change the current mode, you can either exit the programming mode by following the instructions later in this section or program the next feature available on your vehicle.
4. Turn the parking lamps on, then off again to change the current mode.
5. Repeat Step 4 until you hear the number of chimes that matches the number of the mode you want.

The mode you selected is now set. You can either exit the programming mode by following the instructions later in this section or program the next feature available on your vehicle. See *Exiting Programming Mode* on page 2-53.

## Arming and Disarming the Content Theft-Deterrent System

To arm and disarm the content theft-deterrent system, if equipped, the system must be turned on by using Mode 2 listed previously in this section under *Content Theft-Deterrent System on page 2-51*.

With the arming and disarming feature, you can do the following:

- Arm the system when you lock the doors using either power door lock switch while any door is open and the key is removed from the ignition.
- Arm the system when you lock the doors with your remote keyless entry transmitter and the key is removed from the ignition.
- Disarm the system when you unlock the doors with your key or remote keyless entry transmitter.

## Programmable Modes

### Mode 1: Power Door Lock Switch Arming Off

- The content theft-deterrent system will arm when you lock the doors with the remote keyless entry transmitter. The key must be removed from the ignition when you lock the doors or the content theft-deterrent system will not arm.

- The content theft-deterrent system will disarm when you unlock the doors with the keys or the remote keyless entry transmitter.

### Mode 2: Remote Keyless Entry Transmitter Arm/Disarm Only

- The content theft-deterrent system will arm when you lock the doors with the remote keyless entry transmitter. The key must be removed from the ignition when you lock the doors or the content theft-deterrent system will not arm.
- The content theft-deterrent system will disarm when you unlock the doors with the remote keyless entry transmitter.

While this mode provides increased security, it can be a problem if the remote keyless entry transmitter is damaged, lost or if it fails to operate for any reason while the content theft-deterrent system is armed. The content theft-deterrent system must be disarmed for the engine to run and while in Mode 2, the key can no longer disarm the system.

If your vehicle is equipped with the OnStar<sup>®</sup> system, OnStar<sup>®</sup> will not be able to remotely unlock your vehicle if it has been programmed to Mode 2.

### **Mode 3: Standard Arming and Disarming**

- The content theft-deterrent system will arm when you lock the doors using either power door lock switch while any door is open and the key is removed from the ignition.
- The content theft-deterrent system will arm when you lock the doors with your remote keyless entry transmitter. The key must be removed from the ignition when you lock the doors or the content theft-deterrent system will not arm.
- The content theft-deterrent system will disarm when you unlock the doors with the key or the remote keyless entry transmitter.

Before your vehicle was shipped from the factory, it was programmed to Mode 1. The mode to which your vehicle was programmed may have been changed since it left the factory. To determine the mode to which your vehicle is programmed or to program your vehicle to a different mode, do the following:

1. Follow the instructions for *Entering Programming Mode* on page 2-44.
2. Insert a second ignition key fully into any door key cylinder and turn it to the unlock position.  
This step is necessary to prevent accidental programming of this feature to Mode 2.

Do not program this feature to Mode 2 without first reading the note contained in the description for that mode. The door key lock cylinder must remain in the unlock position during Steps 2 through 4.

3. Press the horn symbol on the remote keyless entry transmitter.
4. Count the number of chimes you hear. The number of chimes tells you which mode the vehicle is set for. If you do not wish to change the current mode, you can either exit the programming mode by following the instructions later in this section or program the next feature available on your vehicle.
5. Press the horn symbol on the remote keyless entry transmitter again to change the current mode.
6. Repeat Step 5 until you hear the number of chimes that matches the mode you want.
7. Remove the key from the door key cylinder.

The mode you selected is now set. You can either exit the programming mode by following the instructions at the end of this section or program the next feature available on your vehicle. See "Exit Programming Mode" following.

## **Exiting Programming Mode**

To exit programming mode, turn the key from ACCESSORY to OFF and put the MALL PGM fuse back into the instrument panel fuse block.





## Section 3 Instrument Panel

---

<b>Instrument Panel Overview</b> .....	3-2	Low Traction Light .....	3-30
Hazard Warning Flashers .....	3-3	Engine Coolant Temperature Warning Light .....	3-31
Other Warning Devices .....	3-4	Engine Coolant Temperature Gage .....	3-31
Horn .....	3-4	Malfunction Indicator Lamp .....	3-32
Tilt Wheel .....	3-4	Oil Pressure Light .....	3-35
Turn Signal/Multifunction Lever .....	3-5	Low Oil Level Light .....	3-36
Exterior Lamps .....	3-10	Security Light .....	3-36
Interior Lamps .....	3-12	Fuel Gage .....	3-37
Head-Up Display (HUD) .....	3-15	Low Fuel Warning Light .....	3-37
Accessory Power Outlets .....	3-18	<b>Driver Information Center (DIC)</b> .....	3-38
Auxiliary Power Connection (Power Drop) .....	3-19	<b>Trip Computer</b> .....	3-40
Ashtrays and Cigarette Lighter .....	3-19	Control Buttons .....	3-42
<b>Climate Controls</b> .....	3-20	Functions .....	3-42
Dual Climate Control System .....	3-20	<b>Audio System(s)</b> .....	3-44
Outlet Adjustment .....	3-22	Setting the Time .....	3-44
<b>Warning Lights, Gages and Indicators</b> .....	3-23	Radio with Cassette .....	3-45
Instrument Panel Cluster .....	3-24	Radio with CD (Base Level) .....	3-48
Speedometer and Odometer .....	3-25	Radio with CD (Up Level) .....	3-51
Tachometer .....	3-25	Theft-Deterrent Feature .....	3-54
Safety Belt Reminder Light .....	3-26	Audio Steering Wheel Controls .....	3-56
Air Bag Readiness Light .....	3-26	Understanding Radio Reception .....	3-57
Charging System Light .....	3-27	Care of Your Cassette Tape Player .....	3-58
Brake System Warning Light .....	3-28	Care of Your CDs .....	3-59
Anti-Lock Brake System Warning Light .....	3-29	Care of Your CD Player .....	3-59
Traction Control System (TCS) Warning Light .....	3-29	Backglass Antenna .....	3-59
Enhanced Traction System Warning Light .....	3-30		

## Instrument Panel Overview

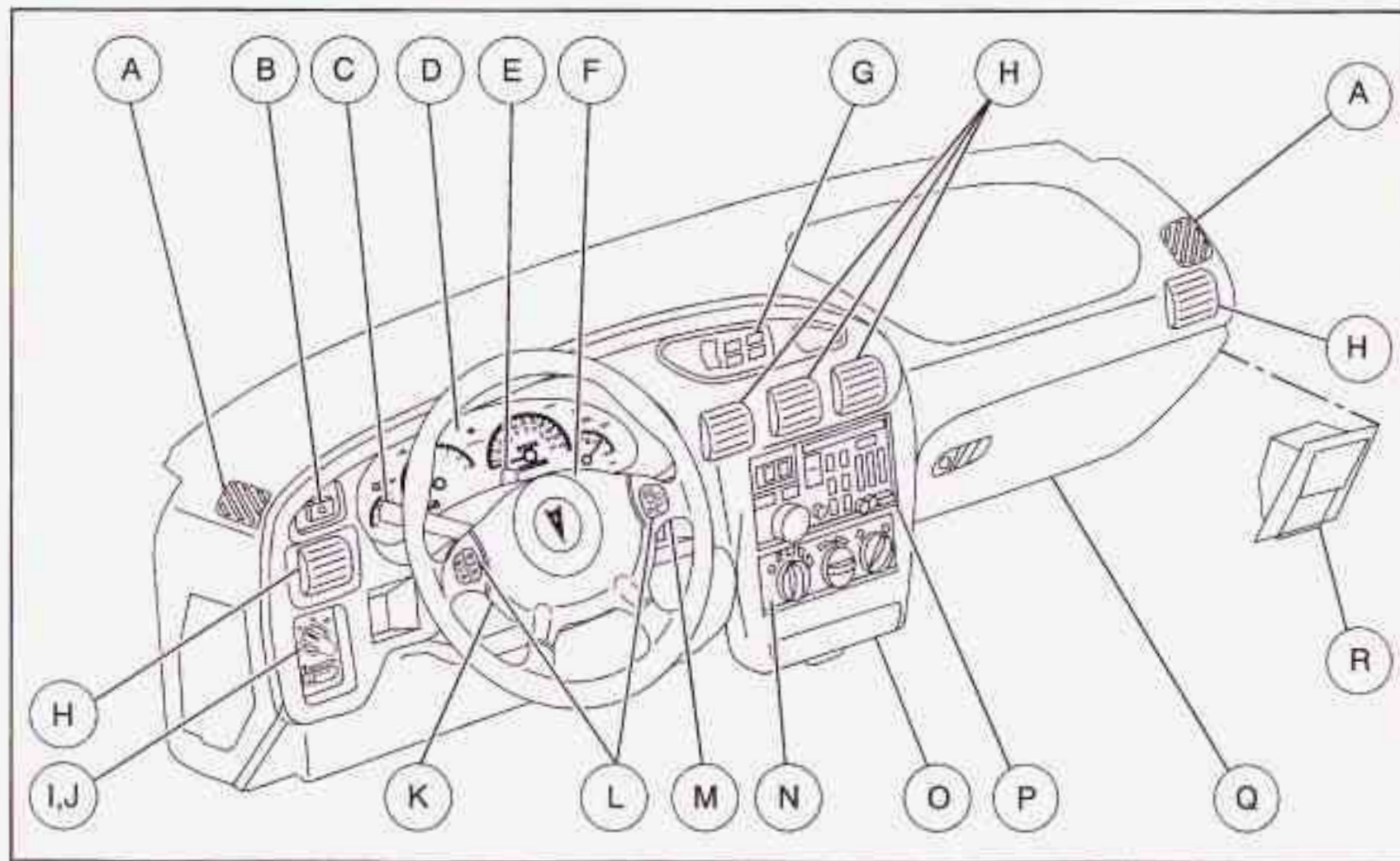

The main components of the instrument panel are the following:

- A. Side Window Defogger Outlets
- B. Fog Lamps Switch
- C. Turn Signal/Multifunction Lever
- D. Instrument Panel Cluster
- E. Hazard Warning Button
- F. Horn
- G. Trip Computer (If Equipped) and/or Driver Information Center (DIC)
- H. Instrument Panel Outlets
- I. Interior Lamps Control
- J. Exterior Lamps Control
- K. Tilt Steering Wheel Control
- L. Audio Steering Controls (If Equipped)
- M. Head Up Display (HUD) Controls (Option)
- N. Climate Controls
- O. Ashtray and Cigarette Lighter
- P. Audio System
- Q. Glove Box
- R. Instrument Panel Fuse Block

## Hazard Warning Flashers

Your hazard warning flashers let you warn others. They also let police know you have a problem. Your front and rear turn signal lamps will flash on and off.



The hazard warning flasher button is located on top of the steering column.

The hazard warning flashers work no matter what position your key is in, and even if the key isn't in.

Press the button to make your front and rear turn signal lamps flash on and off. Press the button again to turn the flashers off.

When the hazard warning flashers are on, your turn signals and brake lamps won't work.

## Other Warning Devices

If you carry reflective triangles, you can set one up at the side of the road about 300 feet (100 m) behind your vehicle.

## Horn

Press near or on the horn symbols on your steering wheel pad to sound the horn.

## Tilt Wheel

A tilt steering wheel allows you to adjust the steering wheel before you drive. You can raise it to the highest level to give your legs more room when you exit and enter the vehicle, or you can lower it so that you're more comfortable while driving.

The lever to adjust it is located on the left side of the steering column, below the turn signal/multifunction lever.



To tilt the wheel, hold the steering wheel and pull the lever. Move the steering wheel to a comfortable level, then release the lever to lock the wheel in place.

## Turn Signal/Multifunction Lever

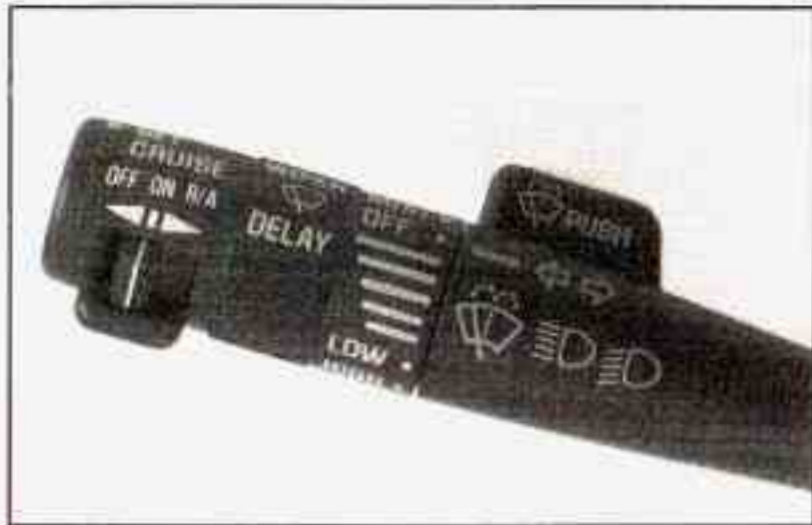

The lever on the left side of the steering column includes the following:

- Turn and Lane Change Signals
- Headlamp High/Low-Beam Changer
- Flash-to-Pass Feature
- Windshield Wipers
- Windshield Washer
- Cruise Control

For information on the exterior lamps, see *Exterior Lamps* on page 3-10.

## Turn and Lane-Change Signals

The turn signal has two upward (for right) and two downward (for left) positions. These positions allow you to signal a turn or a lane change.

To signal a turn, move the lever all the way up or down. When the turn is finished, the lever will return to its original position automatically.

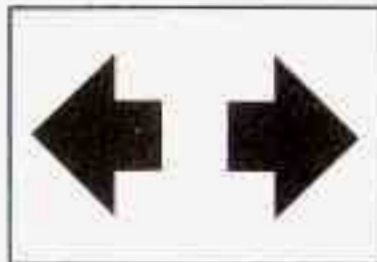

An arrow on the instrument panel cluster will flash in the direction of the turn or lane change.

To signal a lane change, just raise or lower the lever until the arrow starts to flash. Hold it there until you complete your lane change. The lever will return to its original position when you release it.

As you signal a turn or a lane change, if the arrow flashes faster than normal, a signal bulb may be burned out and other drivers won't see your turn signal.

If a bulb is burned out, replace it to help avoid an accident. If the arrows don't go on at all when you signal a turn, check for burned-out bulbs and then check the fuse. See *Fuses and Circuit Breakers* on page 5-97.

A chime will sound if you leave the turn signal on for more than 3/4 mile (1.2 km).

## Headlamp High/Low-Beam Changer

To change the headlamps from low-beam to high-beam, or high to low, pull the multifunction lever all the way toward you. Then release it.

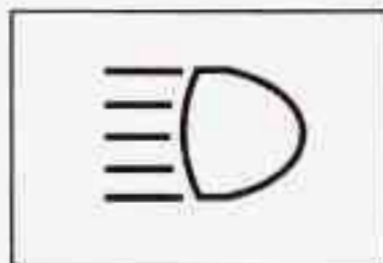

When the high beams are on, this light on the instrument panel cluster will appear. While the high-beam headlamps are on, the fog lamps will not illuminate.

If your vehicle is equipped with the Head-Up-Display (HUD), an arrow will appear in the display area to indicate that the high beams are on. See *Head-Up Display (HUD)* on page 3-15 for more information.

## Flash-to-Pass

This feature lets you use the high-beam headlamps to signal a driver in front of you that you want to pass. It works even if your headlamps are in the automatic or off position.

To use it, pull the turn signal lever toward you, then release it.

If the headlamps are in the automatic position or on low-beam, the high-beam headlamps will turn on and the high-beam indicator on the instrument panel cluster will come on. They will stay on as long as you hold the lever toward you. Release the lever to return to the initial position.

If your vehicle is equipped with the Head-Up-Display (HUD), an arrow will appear in the display area to indicate that the high beams are on.

## Windshield Wipers

To operate the windshield wipers, turn the band marked WIPER located on the multifunction lever, upward or downward.

**MIST:** Turn the band to MIST for a single wiping cycle. Hold it there until the windshield wipers start, then let it go. The windshield wipers will stop after one cycle. For more cycles, hold the band on MIST longer.

**OFF:** Turn the band to OFF to turn the windshield wipers off.

**DELAY (Delayed Wiping):** Turn the band upward to choose one of the five delay settings. For longer periods of time between wiper blade cycles, select a low setting. For shorter periods of time between wiper blade cycles, select a higher setting. The further the band is turned upward, the longer the delay between wiper cycles.

**LOW:** Turn the band to LOW for steady wiping at a low speed.

**HIGH:** Turn the band to HIGH for steady wiping at a high speed.

Be sure to clear ice and snow from the wiper blades before using them. If they're frozen to the windshield, carefully loosen or thaw them. If the blades do become damaged, get new blades or blade inserts.

Heavy snow or ice can overload the wipers. A circuit breaker will stop them until the motor cools. Clear away snow or ice to prevent an overload.

## Windshield Washer

 **PUSH:** Press the paddle with the word PUSH and the washer symbol on it, located on top of the multifunction lever, to spray washer fluid on the windshield. The wipers will clear the windshield and then either stop or return to the set speed.

### CAUTION:

**In freezing weather, don't use your washer until the windshield is warmed. Otherwise the washer fluid can form ice on the windshield, blocking your vision.**



## Cruise Control

With cruise control, you can maintain a speed of about 25 mph (40 km/h) or more without keeping your foot on the accelerator. This can really help on long trips. Cruise control does not work at speeds below approximately 25 mph (40 km/h).

When you apply the brakes, the cruise control shuts off.

### CAUTION:

- Cruise control can be dangerous where you can't drive safely at a steady speed. So, don't use your cruise control on winding roads or in heavy traffic.
- Cruise control can be dangerous on slippery roads. On such roads, fast changes in tire traction can cause needless wheel spinning, and you could lose control. Don't use cruise control on slippery roads.

If your vehicle is in cruise control when the traction control system on the 3800 Supercharged V6 engine or the enhanced traction system on the 3100 V6 and 3800 V6 engine begins to limit wheel spin, the cruise control will automatically disengage. See *Traction Control System (TCS)* on page 4-10 or *Enhanced Traction System (ETS)* on page 4-11. When road conditions allow you to safely use it again, you may turn the cruise control back on.

## Setting Cruise Control

### CAUTION:

If you leave your cruise control on when you're not using cruise, you might hit a button and go into cruise when you don't want to. You could be startled and even lose control. Keep the cruise control switch off until you want to use cruise control.

1. Move the cruise control switch to ON.
2. Get up to the speed you want.
3. Push in the SET button at the end of the multifunction lever and release it.
4. Take your foot off the accelerator pedal.

## Resuming a Set Speed

Suppose you set the cruise control at a desired speed and then you apply the brake. This, of course, shuts off the cruise control. But you don't need to reset it.

Once you're going about 25 mph (40 km/h) or more again, you can move the cruise control switch from ON to R/A (Resume/Accelerate) briefly. You'll go right back up to your chosen speed and stay there.

## Increasing Speed While Using Cruise Control

There are two ways to go to a higher speed:

- Use the accelerator pedal to get to the higher speed. Push in the SET button, then release the button and the accelerator pedal. You'll now cruise at the higher speed.
- Move the cruise switch from ON to R/A. Hold it there until you get up to the speed you want, and then release the switch. To increase your speed in very small amounts, move the switch to R/A briefly and then release it. Each time you do this, your vehicle will go about 1 mph (1.6 km/h) faster.

The accelerate feature will only work after you set the cruise control speed by pushing the SET button.

## Reducing Speed While Using Cruise Control

There are two ways to reduce your speed while using cruise control:

- Push in the SET button until you reach the lower speed you want, then release it.
- To slow down in very small amounts, push the SET button briefly. Each time you do this, you'll go about 1 mph (1.6 km/h) slower.

## Passing Another Vehicle While Using Cruise Control

Use the accelerator pedal to increase your speed. When you take your foot off the pedal, the vehicle will slow down to the cruise control speed you set earlier.

## Using Cruise Control on Hills

How well the cruise control will work on hills depends upon your speed, load and the steepness of the hills. When going up steep hills, you may have to step on the accelerator pedal to maintain your speed. When going downhill, you may have to brake or shift to a lower gear to keep your speed down. Of course, applying the brake takes you out of cruise control. Many drivers find this to be too much trouble and don't use cruise control on steep hills.

## Ending Cruise Control

There are two ways to turn off the cruise control:

- Step lightly on the brake pedal,
- or move the cruise switch to OFF.

## Erasing Speed Memory

When you turn off the cruise control or the ignition, or shift into PARK (P) or NEUTRAL (N), the cruise control set speed memory is erased.

## Exterior Lamps



The exterior lamp control is located on the lower left side of the instrument panel, to the left of the steering wheel.

The exterior lamp has three positions.

**OFF:** Turning the control to this position, turns off all lamps, except the Daytime Running Lamps (DRL).

**P** (Parking Lamps): Turning the control to this position turns on the parking lamps, together with the following:

- Sidemarkers Lamps
- Taillamps
- License Plate Lamp
- Instrument Panel Lights

**D** (Headlamps): Turning the control to this position turns on the headlamps, together with the previously listed lamps and lights.

A warning chime will sound if you open the driver's door when you turn the ignition switch to LOCK or ACCESSORY with the lamps on.

## Daytime Running Lamps (DRL) / Automatic Headlamp System

Daytime Running Lamps (DRL) can make it easier for others to see the front of your vehicle during the day. DRL can be helpful in many different driving conditions, but they can be especially helpful in the short periods after dawn and before sunset. Fully functional daytime running lamps are required on all vehicles first sold in Canada.

A light sensor on top of the instrument panel makes the DRL work, so be sure it isn't covered.

The DRL system will make your low-beam headlamps come on at a reduced brightness when the following conditions are met:

- The ignition is on,
- the exterior lamps control is off,
- the transaxle is not in PARK (P) and
- the parking brake is released.

When the DRL are on, only your low-beam headlamps, at a reduced brightness, will be on. The taillamps, sidemarker and other lamps won't be on. Your instrument panel won't be lit up either.

When it's dark enough outside, your headlamps will change to full brightness. The other lamps that come on with your headlamps will also come on.

When it's bright enough outside, the headlamps will go out, and your low-beam headlamps will change to the reduced brightness of DRL.

To idle your vehicle with the DRL off, set the parking brake while the ignition is in OFF or LOCK. Then start your vehicle. The DRL will stay off until you shift out of PARK (P) and release the parking brake.

As with any vehicle, you should turn on the regular headlamps system when you need it.

## Fog Lamps

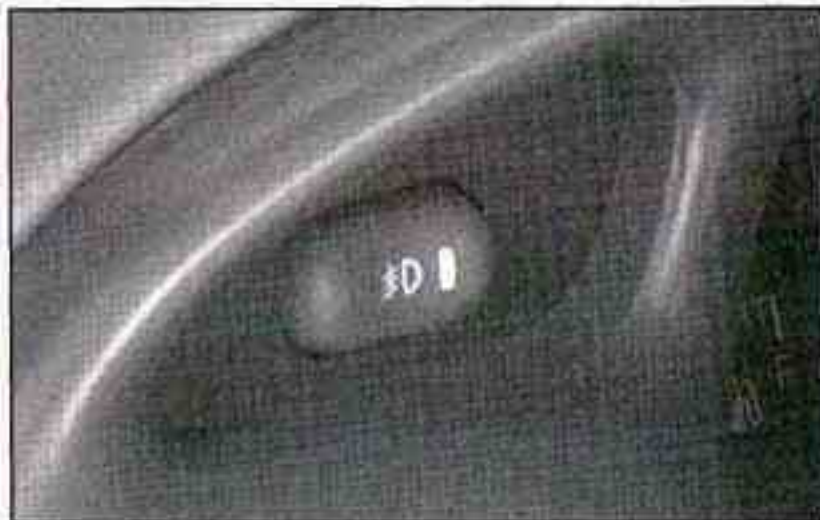

The fog lamps switch is located on the upper corner of the instrument panel, to the left of the instrument panel cluster.

For this feature to work the exterior lamps control must be on. To turn the fog lamps on, press the right side of the fog lamp switch. A light will glow in the switch to let you know that they are on. Press the left side of the switch to turn the fog lamps off.

## Interior Lamps

### Instrument Panel Brightness

This feature controls the brightness of the instrument panel lights.



The thumbwheel for this feature is located on the instrument panel, to the left of the steering wheel.

Turn the thumbwheel to the right to increase the brightness of the instrument panel lights and to the left to decrease the brightness.

## Courtesy Lamps

When a door is open, the courtesy lamps will automatically come on. You can also turn these lamps on by manually turning the interior lamps thumbwheel all the way to the right.

## Entry Lighting

The entry lighting feature illuminates the interior of the vehicle before you enter. The interior lamps will come on for 40 seconds when you unlock the doors using the remote keyless entry transmitter (if equipped) and the ignition is in LOCK or OFF. After 40 seconds have elapsed, the interior lamps will slowly fade out. The lamps will fade out before 40 seconds have elapsed if you do the following:

- Lock all doors using the remote keyless entry transmitter (if equipped).
- Lock the doors using the power door lock switch.

When any door is opened, entry lighting is canceled. The interior lamps will stay on while any door is opened and slowly fade out when all doors are closed.

The interior lamps may stay on for up to 25 seconds after all doors have been closed if they have not been locked. See *Delayed Illumination and Exit Lighting* on page 2-44.

## Delayed Lighting

The delayed lighting feature will continue to illuminate the interior of the vehicle for 25 seconds after all the doors have been closed so that you can find the ignition and buckle the seat belt at night. Delayed lighting will not occur while the ignition is in RUN or ACCESSORY. After 25 seconds have elapsed, the interior lamps will slowly fade out. The lamps will fade out before the 25 seconds have elapsed if you do any of the following:

- Turn the ignition to RUN or ACCESSORY.
- Lock all doors using the remote keyless entry transmitter (if equipped).
- Lock the doors using the power door lock switch.

To turn delayed lighting feature off or on, see *Vehicle Personalization* on page 2-43.

## Delayed Exit Lighting

For exiting the vehicle at night, the vehicle is equipped with the delayed exit lighting feature. The interior lamps will illuminate for up to 25 seconds when you remove the key from the ignition. After 25 seconds have elapsed, the interior lamps will slowly fade out. The lamps will fade out before the 25 seconds have elapsed if you do any of the following:

- Insert the key and turn the ignition to RUN or ACCESSORY.
- Lock all doors using the remote keyless entry transmitter (if equipped).
- Lock the doors using the power door lock switch.

When any door is opened, delayed exit lighting is canceled. The interior lamps will stay on while any door is opened and will slowly fade out when all the doors are closed. The interior lamps may stay on for up to 25 seconds after all the doors have been closed if they have not been locked. See *Delayed Illumination and Exit Lighting* on page 2-44.

To turn the delayed exit lighting feature off or on, see *Vehicle Personalization* on page 2-43.

## Overhead Console Reading Lamps

Your vehicle may have reading lamps on the overhead console. These lamps will turn on when you open the doors. When the doors are closed, push the button next to each lamp to turn them on and off. The overhead console also contains an open storage bin.

## Front Reading Lamps

If the vehicle has the optional sunroof, you will have reading lamps in front of the sunroof switch located on the headliner. These lamps will come on when you open the doors. The lamps can be turned on and off manually by pressing the button behind each reading lamp when the doors are closed.

## Rear Assist Handle Reading Lamps

Your vehicle may have reading lamps on each rear assist handle. Press the reading lamp to turn it on. Press it again to turn it off.

## Battery Run-Down Protection

Your vehicle has a feature to help prevent you from draining the battery in case you accidentally leave the interior, trunk or underhood lamps on. If you leave any of these lamps on while the ignition is in LOCK or OFF, they will automatically turn off after 10 minutes. The lamps won't come back on again until you do one of the following:

- Turn the ignition to RUN or ACCESSORY.
- Turn the interior lamps thumbwheel completely to the right, then back slightly to the left.
- Open (or close and reopen) a door that is closed.

If the vehicle has less than 15 miles (25 km) on the odometer, the battery saver will turn off the lamps after only three minutes.

## Head-Up Display (HUD)

### CAUTION:

If the HUD image is too bright or too high in your field of view, it may take you more time to see things you need to see when it's dark outside. Be sure to keep the HUD image dim and placed low in your field of view.

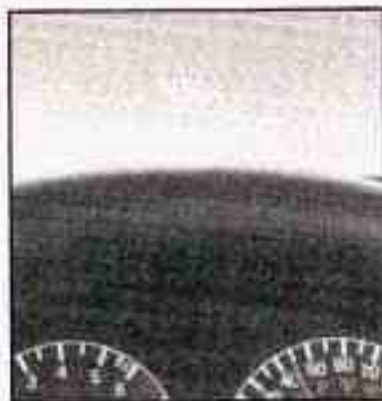

If your vehicle is equipped with the Head-Up Display (HUD), you can see the speedometer reading (in English or metric units) and a brief display of the current radio station or CD track, displayed "through" the windshield.

When you sit up straight in your seat, the HUD image will appear straight ahead near the front bumper.



The HUD also shows the following lights when they are lit on the instrument panel cluster:

- Turn Signal Indicators
- High-Beam Indicator Symbol
- Low Fuel Symbol

The HUD will display CHECK GAGES when the following items are lit on the instrument panel cluster:

- Oil Warning Symbol
- Coolant Temperature Symbol
- Charging System Symbol

When the ignition key is turned to RUN, the entire HUD image will come on. Then the Head-Up Display will operate normally.

**Notice:** Although the HUD image appears to be near the front of the vehicle, do not use it as a parking aid. The HUD was not designed for that purpose. If you try to use it as such, you may misjudge the distance and damage your vehicle.

When the HUD is on, the speedometer reading will be displayed continually. The current radio station or CD track number will only be displayed for three seconds after the radio or CD track status changes. This will happen whenever one of the radio controls is pressed, either on the radio itself or on the optional steering wheel controls.

To adjust the HUD so you can see it properly do the following:



1. Adjust your seat, if necessary, to a comfortable position.
2. Start the engine and adjust the HUD controls located on the instrument panel, to the right of the steering wheel. Move the DIM thumbwheel up or down to adjust brightness.

3. Press the top of the UP/DN switch until the HUD image stops moving. Then press the bottom of the switch until the image is as low as possible but in full view.
4. Move the DIM thumbwheel down until the HUD image is no brighter than necessary. To turn the HUD off, move the DIM thumbwheel all the way down.

If the sun comes out, it becomes cloudy, or if you turn on your headlamps, you may need to adjust the HUD brightness again. The HUD will automatically dim when the headlamps change from the DRL mode to full intensity. Polarized sunglasses could make the HUD image harder to see.

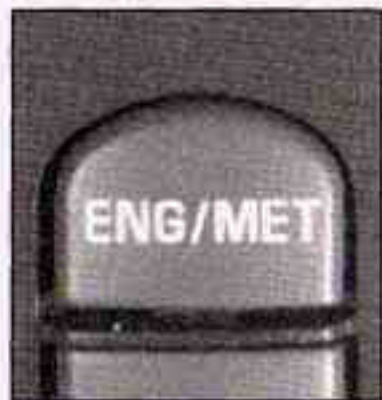

Push the ENG/MET button on the trip calculator, located above the audio controls on the trip computer (if equipped) on the instrument panel, to switch the HUD display between English to metric.

If your vehicle is not equipped with the trip calculator, you cannot change the display.

## Care of the HUD

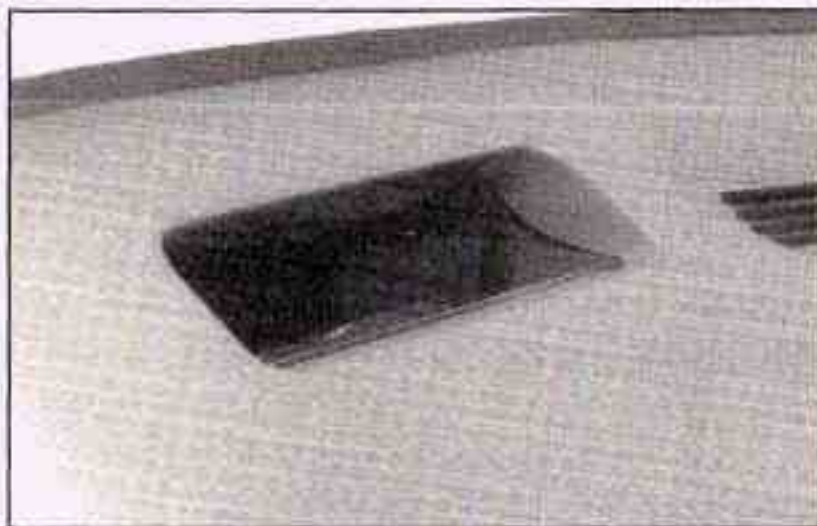

Clean the inside of the windshield as needed to remove any dirt or film that reduces the sharpness or clarity of the HUD image.

To clean the HUD, spray household glass cleaner on a soft, clean cloth. Wipe the HUD lens gently, then dry it. Do not spray cleaner directly on the lens because the cleaner could leak into the unit.

## If You Can't See the HUD Image When the Ignition Is On

- Is anything covering the HUD unit?
- Is the HUD dimmer setting bright enough?
- Is the HUD image adjusted to the proper height?
- Still no HUD image? Check the fuse in the instrument panel fuse block. See *Fuses and Circuit Breakers* on page 5-97.

## If the HUD Image Is Not Clear

- Is the HUD image too bright?
- Are the windshield and HUD lens clean?

The windshield is part of the HUD system. If you ever need a new windshield, be sure to get one designed for HUD. If you don't, the HUD image may look blurred and out of focus.

## Accessory Power Outlets

Your vehicle has a 12-volt outlet which can be used to plug in electrical equipment such as a cellular telephone, a compact disc player, etc. It is located on the passenger's side, near the floor.



Remove the tethered cap to use the outlet. When not using the outlet, be sure to cover it with the protective cap.

The accessory power outlet will only operate while the ignition is on and for a few minutes after turning the ignition off. If you would like to operate an accessory for an extended period of time, see your dealer for more information.

**Notice:** When using an accessory power outlet, maximum electrical load must not exceed amperage rating. Always turn off any electrical equipment when not in use. Leaving electrical equipment on for extended periods will drain your battery.

Certain electrical accessories may not be compatible with the accessory power outlet and could result in blown vehicle or adapter fuses. If you experience a problem, see your dealer for additional information on the accessory power plugs.

**Notice:** Adding some electrical equipment to your vehicle can damage it or keep other things from working as they should. This wouldn't be covered by your warranty. Check with your dealer before adding electrical equipment, and never use anything that exceeds the amperage rating.

When adding electrical equipment, be sure to follow the proper installation instructions included with the equipment.

**Notice:** Power outlets are designed for accessory plugs only. Do not hang any type of accessory or accessory bracket from the plug. Improper use of the power outlet can cause damage not covered by your warranty.

## Auxiliary Power Connection (Power Drop)

The vehicle is equipped with an auxiliary power connection. This feature provides power, ground and accessing wires which can be used to add aftermarket electrical equipment to the vehicle. The connection is located on the passenger's side of the vehicle, below the glove box on the right side of the console.

## Ashtrays and Cigarette Lighter

The center front ashtray is on the instrument panel. To open it, pull at the bottom of the ashtray until it is fully open. To remove the ashtray cup, lift the tabs on the sides and pull out.

**Notice:** Don't put papers or other flammable items into your ashtrays. Hot cigarettes or other smoking materials could ignite them, causing a damaging fire.

To use the lighter, located inside the center front ashtray, push it in all the way and let go. When it's ready, it will pop back out by itself.

**Notice:** Don't hold a cigarette lighter in with your hand while it is heating. If you do, it won't be able to back away from the heating element when it's ready. That can make it overheat, damaging the lighter and the heating element.

# Climate Controls

## Dual Climate Control System

With this system you can control the heating, cooling and ventilation for your vehicle.



Use the mode knob located on the right side of the climate control panel to select the following modes:

**MAX (Maximum):** This mode recirculates much of the air inside your vehicle and sends it through the instrument panel outlets. The air conditioning compressor will run automatically in this setting unless the temperature is at or below freezing.

**VENT:** This mode directs air to the instrument panel outlets.

**BI-LEVEL:** This mode directs half of the air to the instrument panel outlets, and then directs the remaining air to the floor outlets. Some air may be directed toward the windshield. Cooler air is directed to the upper outlets and warmer air to the floor outlets.

**FLOOR:** This mode directs most of the air to the floor outlets with some air directed toward the outboard outlets (for the side windows) and a little air directed to the windshield.

The mode knob can also be used to select defog or defrost mode. Information on defogging and defrosting, see "Defogging and Defrosting" later in this section.

**FAN:** Turn the knob located on the left of the climate control panel clockwise or counterclockwise to increase or decrease the fan speed.

**Driver or Passenger (Temperature Levers):** Slide the lever(s) up or down to increase or decrease the temperature.

**A/C (Air Conditioning):** Press this button to turn the air-conditioning system on or off. When A/C is pressed, an indicator light above the button will come on to let you know that A/C is active. The instrument brightness control may have to be adjusted to the highest setting during the daytime in order to see the indicator light.

On hot days, open the windows to let hot inside air escape; then close them. This helps to reduce the time it takes for your vehicle to cool down. It also helps the system to operate more efficiently.

For quick cool down on hot days:

1. Select the MAX recirculation mode.
2. Select A/C.
3. Select the coolest temperature.
4. Select the highest fan speed.

Using these settings together for long periods of time may cause the air inside your vehicle to become too dry. To prevent this from happening, after the air in your vehicle has cooled, change the mode from MAX to another mode such as bi-level.

The air-conditioning system removes moisture from the air, so you may sometimes notice a small amount of water dripping underneath your vehicle while idling or after turning off the engine. This is normal.

## Defogging and Defrosting

There are two modes to clear fog from your windshield. Use the floor/defog mode to clear the windows of fog or moisture and warm the passengers. Use the defrost mode to remove fog or frost from the windshield more quickly.

Turn the mode knob to select the defog or defrost mode.

 **(Floor/Defog):** This mode directs the air equally between the windshield and the floor outlets. When you select this mode, the system turns on the air-conditioning compressor unless the outside temperature is at or below freezing.

 **FRONT (Defrost):** Pressing FRONT directs most of the air to the windshield and the side window outlets, with some air directed to the floor outlets. In this mode, the system will automatically run the air-conditioning compressor, unless the outside temperature is at or below freezing.

## Rear Window Defogger

The rear window defogger uses a warming grid to remove fog or frost from the rear window.

The rear window defogger will only work when the ignition is in RUN.

 **REAR:** Press this button to turn the rear window defogger on or off. When this button is pressed an indicator light above the button will come on to show that the rear window defogger is active. The instrument brightness control may have to be adjusted to the highest setting during the daytime in order to see the indicator light.

Be sure to clear as much snow from the rear window as possible.

The rear window defogger will turn off approximately 15 minutes after the button is pressed. If turned on again, the defogger will only run for approximately seven and one-half minutes before turning off. The defogger can also be turned off by pressing the button again or by turning off the engine.

**Notice:** Don't use a razor blade or something else sharp on the inside of the rear window. If you do, you could cut or damage the defogger and the repairs would not be covered by your warranty. Do not attach a temporary vehicle license, tape, a decal or anything similar to the defogger grid.

## Outlet Adjustment



Use the controls located in the center of each outlet to change the direction of the airflow.

## Operation Tips

- Clear away any ice, snow or leaves from the air inlets at the base of the windshield that may block the flow of air into your vehicle.
- Use of non-GM approved hood deflectors may adversely affect the performance of the system.
- Keep the path under the front seats clear of objects to help circulate the air inside of your vehicle more effectively.

## Warning Lights, Gages and Indicators

This part describes the warning lights and gages that may be on your vehicle. The pictures will help you locate them.

Warning lights and gages can signal that something is wrong before it becomes serious enough to cause an expensive repair or replacement. Paying attention to your warning lights and gages could also save you or others from injury.

Warning lights come on when there may be or is a problem with one of your vehicle's functions. As you will see in the details on the next few pages, some warning lights come on briefly when you start the engine just to let you know they're working. If you are familiar with this section, you should not be alarmed when this happens.

Gages can indicate when there may be or is a problem with one of your vehicle's functions. Often gages and warning lights work together to let you know when there's a problem with your vehicle.

When one of the warning lights comes on and stays on when you are driving, or when one of the gages shows there may be a problem, check the section that tells you what to do about it. Please follow this manual's advice. Waiting to do repairs can be costly – and even dangerous. So please get to know your warning lights and gages. They're a big help.

Your vehicle may also have a Driver Information Center (DIC) that works along with the warning lights and gages. See *Driver Information Center (DIC)* on page 3-38.



## Instrument Panel Cluster

Your instrument panel cluster is designed to let you know at a glance how your vehicle is running. You'll know how fast you're going, about how much fuel is in your tank and many other things you need to drive safely and economically.

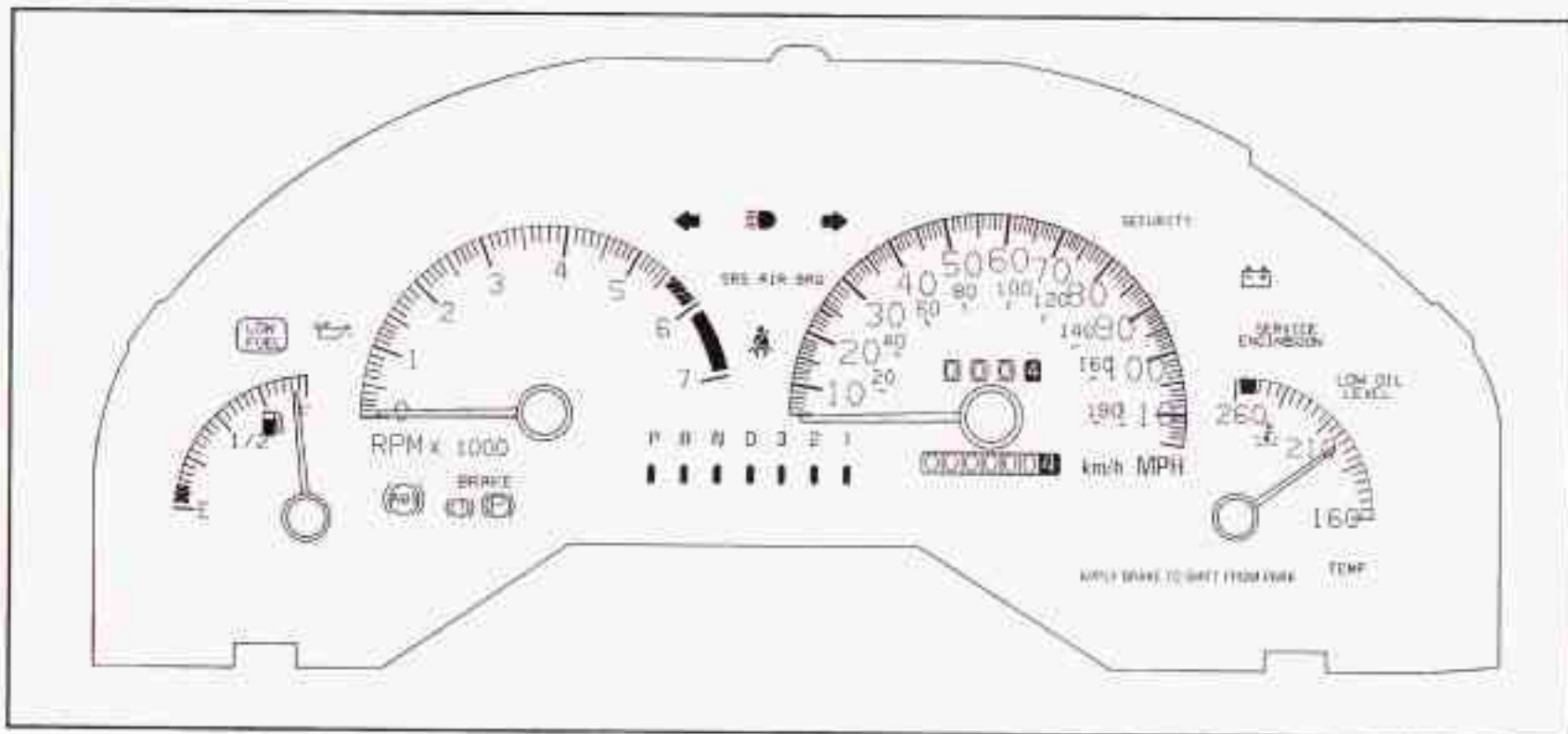

United States ABS-Equipped Version Shown, Canada Similar

Your vehicle is equipped with this cluster or one very similar to it. It includes indicator warning lights and gages that are explained on the following pages. Be sure to read about them.

## Speedometer and Odometer

The speedometer lets you see your speed in both miles per hour (mph) and kilometers per hour (km/h). The odometer shows how far the vehicle has been driven in either miles (used in the United States) or in kilometers (used in Canada).

The vehicle has a tamper-resistant odometer. If you see silver lines between the numbers, you'll know someone has probably tampered with it and the numbers may not be correct.

You may wonder what happens if the vehicle needs a new odometer installed. If the new one can be set to the mileage total of the old odometer, then that will be done. If it can't, then it will be set at zero and a label must be put on the driver's door to show the old mileage reading when the new odometer was installed.

## Trip Odometer

The trip odometer tells how far you have driven since you last reset it. To set it to zero, press the reset button located to the right of the instrument panel cluster.

## Tachometer

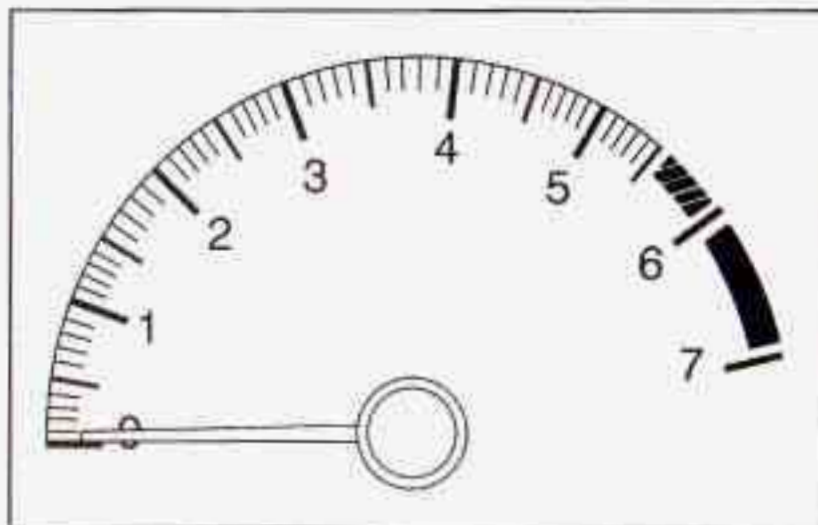

The tachometer displays the engine speed in thousands of revolutions per minute (rpm).

**Notice:** Do not operate the engine with the tachometer in the shaded warning area, or engine damage may occur.

## Safety Belt Reminder Light

When the key is turned to RUN, a chime will come on for several seconds to remind people to fasten their safety belts, unless the driver's safety belt is already buckled.



The safety belt light will also come on and stay on for several seconds, then it will flash for several more.

If the driver's belt is already buckled, neither the chime nor the light will come on.

## Air Bag Readiness Light

There is an air bag readiness light on the instrument panel, which shows the words SRS AIR BAG or the air bag symbol. The system checks the air bag's electrical system for malfunctions. The light tells you if there is an electrical problem. The system check includes the air bag sensors, the air bag modules, the wiring and the crash sensing and diagnostic module. For more information on the air bag system, see *Supplemental Restraint System (SRS)* on page 1-51.

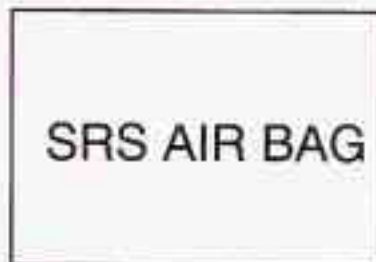

**United States**



**Canada**

This light will come on when you start your vehicle, and it will flash for a few seconds. Then the light should go out. This means the system is ready.

If the air bag readiness light stays on after you start the vehicle or comes on when you are driving, your air bag system may not work properly. Have your vehicle serviced right away.

### **CAUTION:**

**If the air bag readiness light stays on after you start your vehicle, it means the air bag system may not be working properly. The air bags in your vehicle may not inflate in a crash, or they could even inflate without a crash. To help avoid injury to yourself or others, have your vehicle serviced right away if the air bag readiness light stays on after you start your vehicle.**

The air bag readiness light should flash for a few seconds when you turn the ignition key to RUN. If the light doesn't come on then, have it fixed so it will be ready to warn you if there is a problem.

## Charging System Light

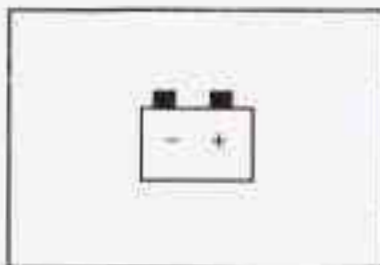

The charging system light will come on briefly when you turn on the ignition as a check to show you it's working. Then it will go out.

If it stays on, or comes on while you are driving, you may have a problem with the electrical charging system. It could indicate that you have a loose drive belt or another electrical problem. Have it checked right away. Driving while this light is on could drain your battery.

If you must drive a short distance with the light on, be certain to turn off all your accessories, such as the radio and air conditioner.

## Brake System Warning Light

Your vehicle's hydraulic brake system is divided into two parts. If one part isn't working, the other part can still work and stop you. For good braking, though, you need both parts working well.

If the warning light comes on, there is a brake problem. Have your brake system inspected right away.



United States

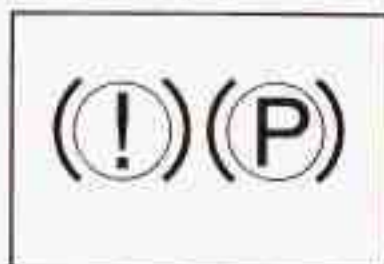

Canada

This light should come on when you turn the key to RUN. If it doesn't come on then, have it fixed so it will be ready to warn you if there's a problem.

If the light comes on while you are driving, carefully pull off the road and stop. You may notice that the pedal is harder to push. Or, the pedal may go closer to the floor. It may take longer to stop. If the light is still on, have the vehicle towed for service. See *Towing Your Vehicle* on page 4-33.

### CAUTION:

Your brake system may not be working properly if the brake system warning light is on. Driving with the brake system warning light on can lead to an accident. If the light is still on after you've pulled off the road and stopped carefully, have the vehicle towed for service.

While the ignition is on, the brake system warning light will also come on when you set your parking brake. The light will stay on if your parking brake doesn't release fully. If it stays on after your parking brake is fully released, it means you have a brake problem.

## Anti-Lock Brake System Warning Light

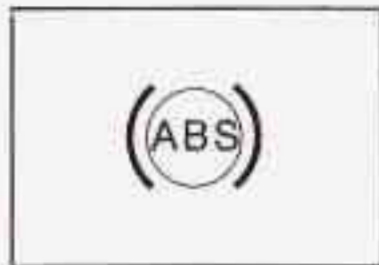

If your vehicle has the optional anti-lock brake system, this light will come on when your engine is started and may stay on for several seconds. That's normal.

If the anti-lock brake system warning light stays on longer than normal after you've started your engine, turn the ignition off. If the light comes on and stays on while you're driving, stop as soon as possible and turn the ignition off. Then start the engine again to reset the system. If the light still stays on, or comes on again while you're driving, your vehicle needs service. If the light is on and the regular brake system warning light isn't on, you still have brakes, but you don't have anti-lock brakes.

The anti-lock brake system warning light should come on briefly when you turn the ignition key to RUN. This is normal. If the light doesn't come on then, have it fixed so it will be ready to warn you if there is a problem.

## Traction Control System (TCS) Warning Light



If your vehicle is equipped with the 3800 supercharged V6 engine, the traction control system warning light may come on for the following reasons:

- If you turn the system off by pressing the TCS button located on the far right side of the trip computer, the warning light will come on and stay on. To turn the system back on, press the button again. The warning light should go off. See *Traction Control System (TCS)* on page 4-10 for more information.
- If there's a brake system problem that is specifically related to traction control, the traction control system will turn off and the warning light will come on. If your brakes begin to overheat, the traction control system will turn off and the warning light will come on until your brakes cool down.

If the traction control system warning light comes on and stays on for an extended period of time when the system is turned on, your vehicle needs service.

## Enhanced Traction System Warning Light

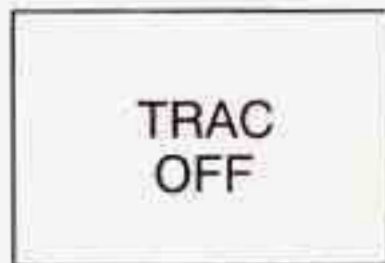

If your vehicle is equipped with a 3100 V6 or 3800 V6 engine and the optional ABS brake system, the Enhanced Traction System warning light may come on for the following reasons:

- If you turn the system off by pressing the TRAC button on the far right side of the Driver Information Center or trip computer (if equipped), the warning light will come on and stay on. To turn the system back on, press the button again. The warning light should go off. See *Enhanced Traction System (ETS) on page 4-11* for more information.
- If the Enhanced Traction System warning light comes on and stays on for an extended period of time while the system is turned on, your vehicle needs service. Adjust your driving accordingly.
- If the traction control system is affected by an engine-related problem, the system will turn off and the warning light will come on.

When this warning light is on, the system will not limit wheel spin. Adjust your driving accordingly.

## Low Traction Light

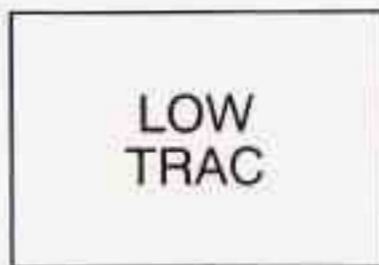

If your vehicle has the Enhanced Traction System or the Traction Control System, this light will also come on while the system is limiting wheel spin.

You may feel or hear the system working, but this is normal. Slippery road conditions may exist if the low traction light comes on, so adjust your driving accordingly. The light will stay on for a few seconds after the Enhanced Traction System or the Traction Control System stops limiting wheel spin. See *Enhanced Traction System (ETS) on page 4-11* or *Traction Control System (TCS) on page 4-10*.

The low traction light also comes on briefly when you turn the ignition key to RUN. If the light doesn't come on then, have it fixed so it will be there to tell you when the Traction Control System or Enhanced Traction System is active.

## Engine Coolant Temperature Warning Light



This light tells you that the engine coolant has overheated or the radiator cooling fan is not working.

If you have been operating the vehicle under normal driving conditions, you should pull off the road, stop the vehicle and turn off the engine as soon as possible.

See *Engine Overheating* on page 5-33.

## Engine Coolant Temperature Gage

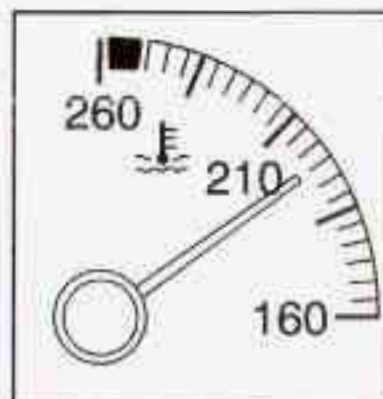

United States

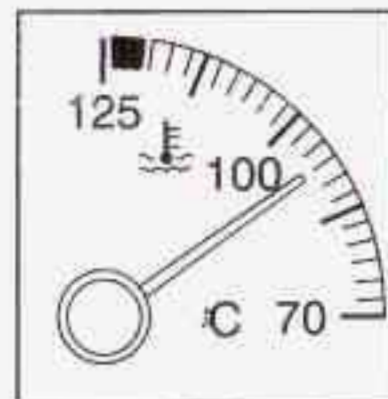

Canada

Your vehicle has a gage that shows the engine coolant temperature. If the gage pointer moves into the shaded area, the engine is too hot.

That reading means the same thing as the warning light. It means that the engine coolant has overheated. If you have been operating the vehicle under normal conditions, you should pull off the road, stop the vehicle, and turn off the engine as soon as possible.

See *Engine Overheating* on page 5-33.



## Malfunction Indicator Lamp

### Service Engine Soon Light in the United States or Check Engine Light in Canada



United States

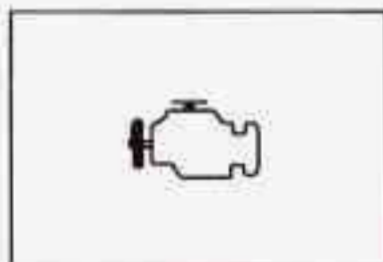

Canada

Your vehicle is equipped with a computer which monitors operation of the fuel, ignition and emission control systems.

This system is called OBD II (On-Board Diagnostics-Second Generation) and is intended to assure that emissions are at acceptable levels for the life of the vehicle, helping to produce a cleaner environment.

The SERVICE ENGINE SOON or CHECK ENGINE light comes on to indicate that there is a problem and service is required. Malfunctions often will be indicated by the system before any problem is apparent. This may prevent more serious damage to your vehicle. This system is also designed to assist your service technician in correctly diagnosing any malfunction.

**Notice:** If you keep driving your vehicle with this light on, after a while, your emission controls may not work as well, your fuel economy may not be as good and your engine may not run as smoothly. This could lead to costly repairs that may not be covered by your warranty.

**Notice:** Modifications made to the engine, transaxle, exhaust, intake or fuel system of your vehicle or the replacement of the original tires with other than those of the same Tire Performance Criteria (TPC) can affect your vehicle's emission controls and may cause this light to come on. Modifications to these systems could lead to costly repairs not covered by your warranty. This may also result in a failure to pass a required Emission Inspection/Maintenance test.

This light should come on, as a check to show you it is working, when the ignition is on and the engine is not running. If the light doesn't come on, have it repaired. This light will also come on during a malfunction in one of two ways:

- **Light Flashing** — A misfire condition has been detected. A misfire increases vehicle emissions and may damage the emission control system on your vehicle. Dealer or qualified service center diagnosis and service may be required.
- **Light On Steady** — An emission control system malfunction has been detected on your vehicle. Dealer or qualified service center diagnosis and service may be required.

## If the Light Is Flashing

The following may prevent more serious damage to your vehicle:

- Reducing vehicle speed.
- Avoiding hard accelerations.
- Avoiding steep uphill grades.
- If you are towing a trailer, reduce the amount of cargo being hauled as soon as it is possible.

If the light stops flashing and remains on steady, see "If the Light Is On Steady" following.

If the light continues to flash, when it is safe to do so, *stop the vehicle*. Find a safe place to park your vehicle. Turn the key off, wait at least 10 seconds and restart the engine. If the light remains on steady, see "If the Light Is On Steady" following. If the light is still flashing, follow the previous steps, and drive the vehicle to your dealer or qualified service center for service.

## If the Light Is On Steady

You may be able to correct the emission system malfunction by considering the following:

Did you recently put fuel into your vehicle?

If so, reinstall the fuel cap, making sure to fully install the cap. See *Filling Your Tank on page 5-7*. The diagnostic system can determine if the fuel cap has been left off or improperly installed. A loose or missing fuel cap will allow fuel to evaporate into the atmosphere. A few driving trips with the cap properly installed should turn the light off.

Did you just drive through a deep puddle of water?

If so, your electrical system may be wet. The condition will usually be corrected when the electrical system dries out. A few driving trips should turn the light off.

Are you low on fuel?

As your engine starts to run out of fuel, your engine may not run as efficiently as designed since small amounts of air are sucked into the fuel line causing misfire. The system can detect this. Adding fuel should correct this condition. Make sure to install the fuel cap properly. See *Filling Your Tank on page 5-7*. It will take a few driving trips to turn the light off.

Have you recently changed brands of fuel?

If so, be sure to fuel your vehicle with quality fuel. See *Gasoline Octane on page 5-5*. Poor fuel quality will cause your engine not to run as efficiently as designed. You may notice this as stalling after start-up, stalling when you put the vehicle into gear, misfiring, hesitation on acceleration or stumbling on acceleration. (These conditions may go away once the engine is warmed up.) This will be detected by the system and cause the light to turn on.

If you experience one or more of these conditions, change the fuel brand you use. It will require at least one full tank of the proper fuel to turn the light off.

If none of the above steps have made the light turn off, have your dealer or qualified service center check the vehicle. Your dealer has the proper test equipment and diagnostic tools to fix any mechanical or electrical problems that may have developed.

## Emissions Inspection and Maintenance Programs

Some state/provincial and local governments have or may begin programs to inspect the emission control equipment on your vehicle. Failure to pass this inspection could prevent you from getting a vehicle registration.

Here are some things you need to know to help your vehicle pass an inspection:

Your vehicle will not pass this inspection if the SERVICE ENGINE SOON or CHECK ENGINE light is on or not working properly.

Your vehicle will not pass this inspection if the OBD (on-board diagnostic) system determines that critical emission control systems have not been completely diagnosed by the system. The vehicle would be considered not ready for inspection. This can happen if you have recently replaced your battery or if your battery has run down. The diagnostic system is designed to evaluate critical emission control systems during normal driving. This may take several days of routine driving. If you have done this and your vehicle still does not pass the inspection for lack of OBD system readiness, see your dealer or qualified service center to prepare the vehicle for inspection.

## Oil Pressure Light

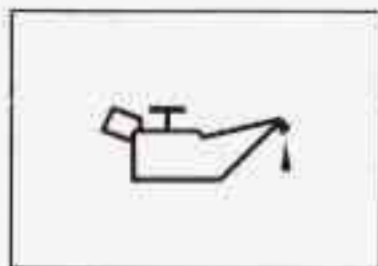

United States

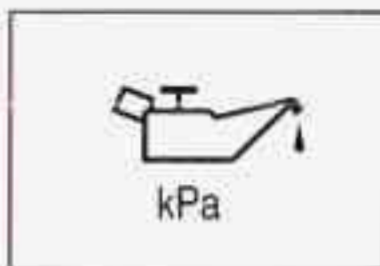

Canada

If you have a problem with your oil pressure, this light may stay on after you start your engine, or come on when you are driving.

This indicates that oil is not going through your engine quickly enough to keep it lubricated. The engine could be low on oil or could have some other oil problem. Have it fixed right away.

The oil light could also come on in two other situations:

- While the ignition is on but the engine is not running, the light will come on as a test to show you it's working. The light will go out when you turn

the ignition to RUN. If it doesn't come on with the ignition on, you may have a problem with the fuse or bulb. Have it fixed right away.

- If you make a hard stop, the light may come on for a moment. This is normal.

### CAUTION:

**Don't keep driving if the oil pressure is low. If you do, your engine can become so hot that it catches fire. You or others could be burned. Check your oil as soon as possible and have your vehicle serviced.**

**Notice:** Damage to your engine from neglected oil problems can be costly and is not covered by your warranty.

## Low Oil Level Light

A rectangular box containing the text "LOW OIL LEVEL" in all caps, centered.

LOW OIL  
LEVEL

The engine is equipped with an oil level monitoring system. When the ignition key is turned to RUN, the LOW OIL LEVEL light will briefly flash.

If the light does not flash, have it fixed so it will be ready to warn you if there is a problem.

If the light stays on, stop the vehicle on a level surface and turn the engine off. Check the oil level using the engine oil dipstick. See *Engine Oil* on page 5-18.

The oil level monitoring system only checks the oil level during the brief period when the ignition key is between RUN and START. It does not monitor engine oil level while the engine is running. Additionally, an oil level check is only performed if the engine has been turned off for a considerable period of time, allowing the oil normally in circulation to drain back into the oil pan.

## Security Light

A rectangular box containing the text "SECURITY" in all caps, centered.

SECURITY

This message is displayed to monitor the PASS-Key<sup>®</sup> III system.

If the SECURITY message is displayed continuously while driving, there may be a problem with the PASS-Key<sup>®</sup> III system. Your vehicle will not be protected by PASS-Key<sup>®</sup> III, and you should see your dealer for service. For more information see *PASS-Key<sup>®</sup> III* on page 2-16.

## Fuel Gage

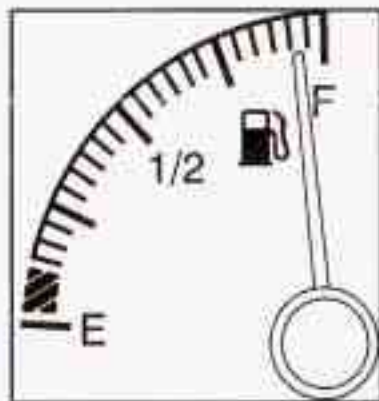

United States



Canada

The fuel gage tells you about how much fuel you have left while the ignition is on. When the indicator nears empty, you still have a little fuel left, but you should get more soon.

Here are four things owners usually ask about the fuel gage. All these situations are normal and do not indicate a problem with the fuel gage:

- At the gas station, the pump shuts off before the gage reads full.
- It takes more (or less) fuel to fill up than the gage indicates. For example, the gage reads half full, but it took more (or less) than half the tank's capacity to fill it.

- The gage pointer may move while cornering, braking or speeding up.
- The gage may not indicate full when the ignition is turned off.

## Low Fuel Warning Light



If your fuel is low, the warning light near the fuel gage will go on.

It will also come on for a few seconds when you first turn on the ignition as a check to show you it's working properly. If it doesn't come on then, see your dealer for service.

## Driver Information Center (DIC)

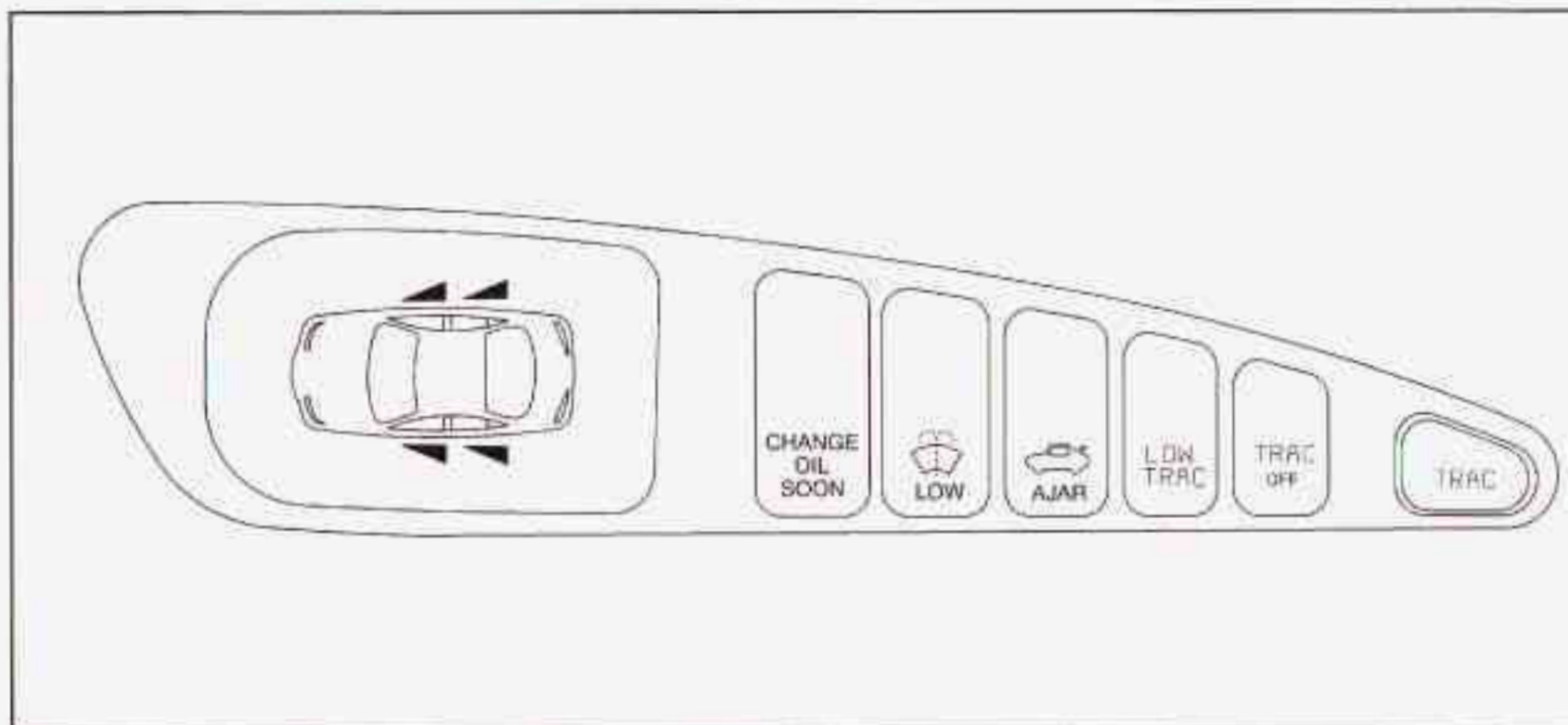

3100 V6 or 3800 V6 Engine Vehicles Equipped with the ABS Brake System

The Driver Information Center (DIC) gives you important safety and maintenance facts. When you turn the ignition on, all of the DIC lights illuminate for a few seconds. After this, the DIC will begin working.

## Functions

 **(Door Ajar):** If one of the doors is ajar, this light will appear next to that door on the vehicle outline.

**CHANGE OIL SOON:** This light will appear when the system indicates that it's time for an oil change. The system predicts remaining oil life using data from length of drives, coolant temperature, engine rpm and vehicle speed. It alerts you to change the oil on a schedule consistent with the vehicle's driving conditions. After changing the oil, the system must be reset. See *How to Reset the GM Oil Life System™* under *Engine Oil* on page 5-18.

 **LOW:** This light will come on when the ignition is on and the fluid in the washer fluid container is low.

 **AJAR:** This light alerts you that the trunk is not fully closed.

**LOW TRAC (Low Traction):** If your vehicle is equipped with anti-lock brakes, this light will come on when the enhanced traction system is limiting wheel spin. See *Enhanced Traction System (ETS)* on page 4-11 or *Low Traction Light* on page 3-30.

**TRAC OFF (Traction Off):** If your vehicle is equipped with anti-lock brakes, this light lets you know that the enhanced traction system has been disabled and will not limit wheel spin. See *Enhanced Traction System Warning Light* on page 3-30 or *Low Traction Light* on page 3-30.

**TRAC (Traction):** If the vehicle has anti-lock brakes and the enhanced traction system, you will have a disable button on the far right side of the DIC. The enhanced traction system is automatically activated when you turn the ignition on. This button will activate/deactivate the system. If you need to disable the system, such as when you are stuck and are rocking the vehicle back and forth, push this button. See *If You Are Stuck: In Sand, Mud, Ice or Snow* on page 4-32.



## Trip Computer

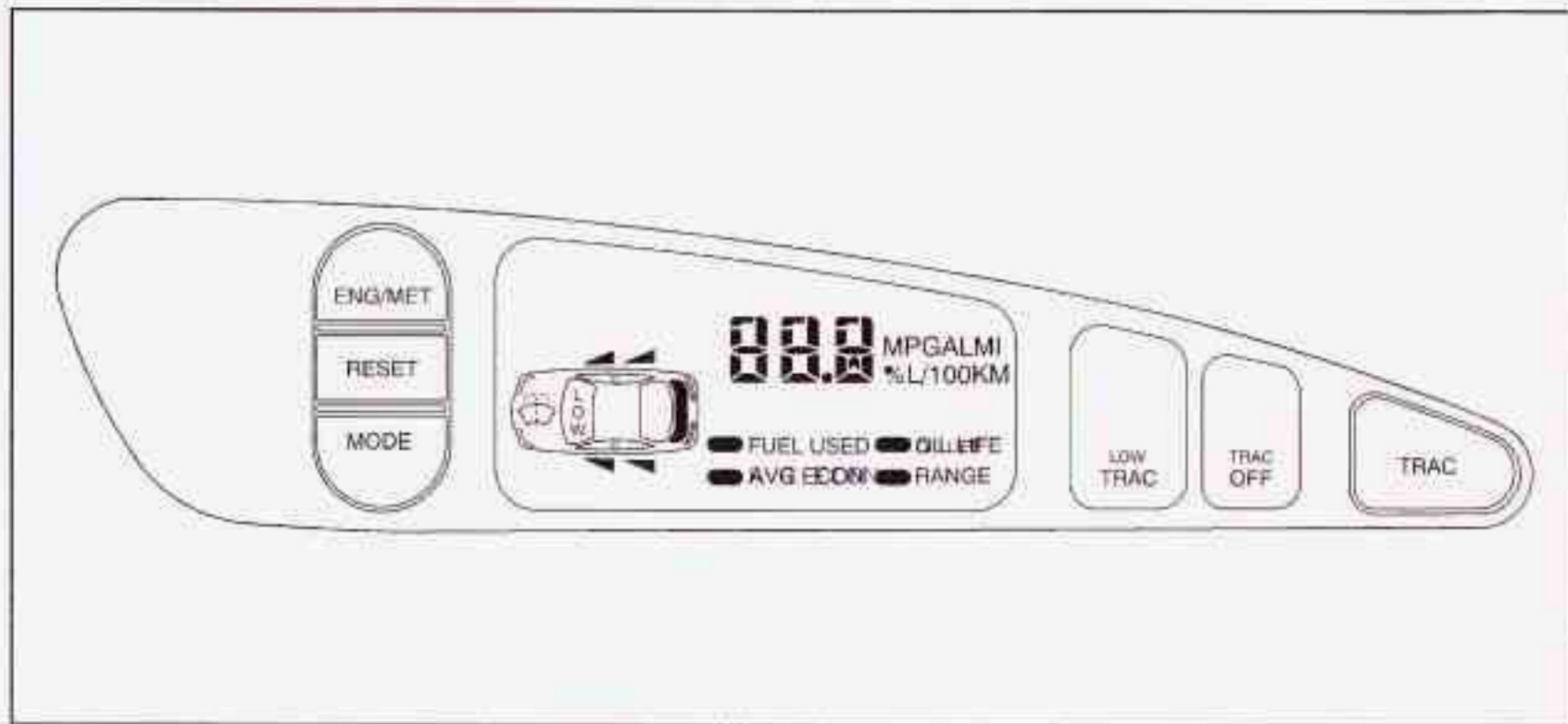

3800 V6 Engine Vehicles Equipped with the ABS Brake System

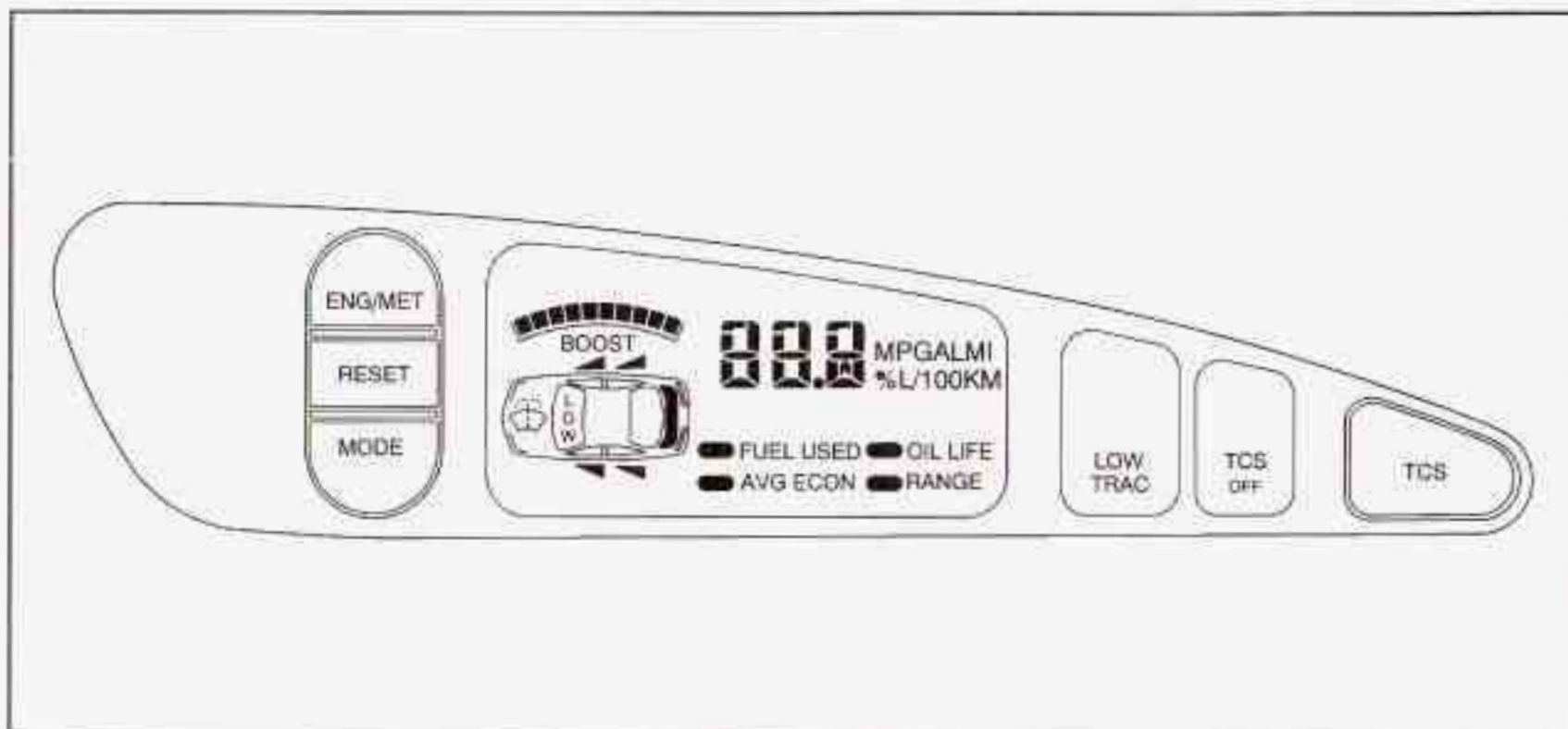

### 3800 V6 Supercharged Engine

When you start the engine, the trip computer, if equipped, will display a mode. A lighted oval will appear to the left of the mode currently being used.

## Control Buttons

The trip computer has three buttons that control its functions.

**ENG/MET (English/Metric):** Press this button to change the display from English to metric units or metric to English.

**RESET:** Press this button for two seconds to reset the mode displayed.

**MODE:** Press this button to change the function mode, (Fuel Used, AVG ECON, OIL LIFE, RANGE) being displayed.

## Functions

**FUEL USED:** This mode shows the total amount of fuel used since you last reset it. The amount can be displayed in gallons or liters.

**AVG ECON (Average Economy):** This mode shows the average fuel economy since you last reset it.

**OIL LIFE:** This shows a percentage of the engine's oil remaining useful life. The system predicts remaining oil life using data from length of drives, coolant temperature, engine rpm and vehicle speed. Each time you get an oil change, be sure to reset this function so that it will give you an accurate percentage. See *"How to Reset the GM Oil Life System"* under *Engine Oil* on page 5-18.

**RANGE:** This mode shows how much farther you can travel with the fuel you have remaining in the gas tank before refueling. When the range displays L, for 40 to 50 miles (64.36 to 80.45 km), the display will flash LOW continuously. The range is calculated from the AVG ECON value multiplied by the fuel remaining in the tank.

**LOW:** This light will come on the vehicle outline when the ignition is on and the fluid in the washer fluid container is low.

**DOOR AJAR:** If one of the doors is left ajar, a light will appear next to that door on the vehicle outline.

**BOOST GAGE:** If you have the 3800 V6 supercharged engine, this gage will show the amount of boost the engine is receiving.

**TRUNK AJAR:** If the trunk is not fully closed, the trunk area will light up on the vehicle outline.

**LOW TRAC (Low Traction):** This light will come on when the enhanced traction system (3100 or 3800 V6 engine) or the traction control system (3800 supercharged V6 engine) is limiting wheel spin. See *Traction Control System (TCS)* on page 4-10, *Enhanced Traction System (ETS)* on page 4-11 and *Low Traction Light* on page 3-30.

**TRAC OFF (Traction Off) or TCS OFF (Traction Control System Off):** This light lets you know that the enhanced traction system (3100 or 3800 V6 engine) or

the traction control system (3800 supercharged V6 engine) has been disabled and will not limit wheel spin. See *Traction Control System (TCS) Warning Light* on page 3-29, *Enhanced Traction System Warning Light* on page 3-30 and *Low Traction Light* on page 3-30.

**TRAC (Traction) or TCS (Traction Control System):** If the vehicle has the enhanced traction system (3100 or 3800 V6 engine) or the traction control system (3800 supercharged V6 engine), you will have a disable button on the far right side of the trip computer. The enhanced traction system and traction control system are automatically activated when you turn the ignition on. This button will activate/deactivate the system. If you need to disable the system, such as when you are stuck and are rocking the vehicle back and forth, push this button. See *If You Are Stuck: In Sand, Mud, Ice or Snow* on page 4-32.

## Audio System(s)

**Notice:** Before you add any sound equipment to your vehicle – like a tape player, CB radio, mobile telephone or two-way radio – be sure you can add what you want. If you can, it's very important to do it properly. Added sound equipment may interfere with the operation of your vehicle's engine, Delphi Electronics radio or other systems, and even damage them. Your vehicle's systems may interfere with the operation of sound equipment that has been added improperly.

**So, before adding sound equipment, check with your dealer and be sure to check federal rules covering mobile radio and telephone units.**

Your audio system has been designed to operate easily and to give years of listening pleasure. You will get the most enjoyment out of it if you acquaint yourself with it first. Find out what your audio system can do and how to operate all of its controls to be sure you're getting the most out of the advanced engineering that went into it.

Your vehicle may have a feature called Retained Accessory Power (RAP). With RAP, you can play your audio system even after the ignition is turned off. See "Retained Accessory Power (RAP)" under *Ignition Positions* on page 2-19.

## Setting the Time

Press RECALL, then press and hold HR or MIN for two seconds. Then press and hold HR until the correct hour appears on the display. AM or PM will also appear. Press and hold MIN until the correct minute appears on the display. The time can only be set with the ignition off.

## Radio with Cassette



### Playing the Radio

**POWER:** Push this knob to turn the system on and off.

**VOL (Volume):** Turn this knob to increase or to decrease volume.

**RECALL:** Press this button to switch the display between the radio station frequency and the time. Time display is available with the ignition turned off.

### Finding a Station

**AM/FM:** Press this button to switch between AM, FM1 and FM2. The display will show your selection.

**TUNE:** Press this knob lightly so it extends. Turn it to choose radio stations. Press the knob back into its stored position when you're not using it.

**▲ SEEK ▼:** Press the up or the down arrow to go to the next or to the previous station and stay there.

### Setting Preset Stations

The six numbered pushbuttons let you return to your favorite stations. You can set up to 18 stations (six AM, six FM1 and six FM2) by performing the following steps:

1. Turn the radio on.
2. Press AM/FM to select AM, FM1 or FM2.
3. Tune in the desired station.
4. Press and hold one of the six numbered pushbuttons until SET appears on the display. Whenever you press that numbered pushbutton, the station you set will return.
5. Repeat the steps for each pushbutton.

## Setting the Tone (Bass/Treble)

**BASS:** Slide the lever to the right or to the left to increase or to decrease bass.

**TREBLE:** Slide the lever to the right or to the left to increase or to decrease treble. If a station is weak or noisy, you may want to decrease the treble.

## Adjusting the Speakers (Balance/Fade)

**BAL (Balance):** Press this knob lightly so it extends. Turn this knob to move the sound toward the left or the right speakers.

**FADE:** Press this knob lightly so it extends. Turn this knob to move the sound toward the front or the rear speakers.

Press these knobs back into their stored positions when you're not using them.

## Playing a Cassette Tape

Your tape player is built to work best with tapes that are up to 30 to 45 minutes long on each side. Tapes longer than that are so thin they may not work well in this player.

While the tape is playing, use the VOL, FADE, BAL, BASS and TREBLE controls just as you do for the radio. The display will show an arrow to show which side of the tape is playing. When the down indicator arrow is lit, selections listed on the bottom side of the cassette are playing. When the up arrow is lit, selections listed on the top side of the cassette are playing. The tape player automatically begins playing the other side when it reaches the end of the tape.

If an error appears on the display, see "Cassette Tape Messages" later in this section.

**1 PREV (Previous):** Your tape must have at least three seconds of silence between each selection for previous to work. Press this pushbutton to search for the previous selection on the tape. Press PREV again or the SEEK down arrow to stop searching.

**2 NEXT:** Your tape must have at least three seconds of silence between each selection for next or seek to work. Press this pushbutton to search for the next selection on the tape. If you hold the pushbutton, the player will continue moving forward through the tape. Press NEXT again or the SEEK up arrow to stop searching.

**3 PROG (Program):** Press this pushbutton to play the other side of the tape.

**4  (Dolby):** Press this pushbutton to reduce background noise. The double-D symbol will appear on the display.

Dolby Noise Reduction is manufactured under a license from Dolby Laboratories Licensing Corporation. Dolby and the double-D symbol are trademarks of Dolby Laboratories Licensing Corporation.

**5 REV (Reverse):** Press this pushbutton to reverse the tape rapidly. Press it again to return to playing speed. The radio will play while the tape reverses. You may select stations during reverse operation using SEEK or TUNE.

**6 FWD (Forward):** Press this pushbutton to advance quickly. Press the pushbutton again to return to playing speed. The radio will play while the tape advances. You may select stations during forward operation using SEEK or TUNE.

**▲ SEEK ▼:** Press the up or the down arrow to seek to the next or to the previous selection on the tape.

**AM/FM:** Press this button to listen to the radio when a tape is playing.

**TAPE/PLAY:** Press this button to change to playing a tape when listening to the radio. The tape symbol with an arrow will appear on the display while the tape is active.

**▲ EJECT:** Press this button to stop a tape when it is playing and to remove a tape when it is not playing. The eject button may be activated with either the ignition or radio off. Cassettes may be loaded with the radio and ignition off if this button is pressed first.

## Cassette Tape Messages

**E (Error):** If this message and a number appears while trying to play a cassette tape, it could be one of the following:

- **E10:** The tape is tight and the player can't turn the tape hubs. Remove the tape. Hold the tape with the open end down and try to turn the right hub counterclockwise with a pencil. Turn the tape over and repeat. If the hubs do not turn easily, your tape may be damaged and should not be used in the player. Try a new tape to make sure your player is working properly.
- **E11:** The tape is broken. Try a new tape.
- **E14:** Wrapped tape. Try a new tape.



**CLN (Clean):** If this message appears on the display, the cassette tape player needs to be cleaned. It will still play tapes, but you should clean it as soon as possible to prevent damage to the tapes and player. See *Care of Your Cassette Tape Player* on page 3-58.

If any error occurs repeatedly or if an error can't be corrected, contact your dealer. If your radio displays an error number, write it down and provide it to your dealer when reporting the problem.

## CD Adapter Kits

It is possible to use a portable CD player adapter kit with your cassette tape player after activating the bypass feature on your tape player.

To activate the bypass feature, use the following steps:

1. Turn the ignition on.
2. Turn the radio off.
3. Press and hold TAPE/PLAY for three seconds. The tape symbol on the display will flash for two seconds, indicating the feature is active.
4. Insert the adapter into the cassette slot. It will power up the radio and begin playing.

The override feature will remain active until EJECT is pressed.

## Radio with CD (Base Level)



## Playing the Radio

**POWER:** Push this knob to turn the system on and off.

**VOL (Volume):** Turn the knob to increase or to decrease volume.

**RECALL:** Press this button to switch the display between the radio station frequency and the time. Time display is available with the ignition turned off.

## Finding a Station

**AM/FM:** Press this button to switch between AM, FM1 and FM2. The display will show your selection.

**TUNE:** Press this knob lightly so it extends. Turn it to choose radio stations. Press the knob back into its stored position when you're not using it.

**▲ SEEK ▼:** Press the up or the down arrow to go to the next or to the previous station and stay there.

## Setting Preset Stations

The six numbered pushbuttons let you return to your favorite stations. You can set up to 18 stations (six AM, six FM1 and six FM2) by performing the following steps:

1. Turn the radio on.
2. Press AM/FM to select AM, FM1 or FM2.
3. Tune in the desired station.
4. Press and hold one of the six numbered pushbuttons until SET appears on the display. Whenever you press that numbered pushbutton, the station you set will return.
5. Repeat the steps for each pushbutton.

## Setting the Tone (Bass/Treble)

**BASS:** Slide the lever to the right or to the left to increase or to decrease bass.

**TREBLE:** Slide the lever to the right or to the left to increase or to decrease treble. If a station is weak or noisy, you may want to decrease the treble.

## Adjusting the Speakers (Balance/Fade)

**BAL (Balance):** Press this knob lightly so it extends. Turn it to move the sound toward the left or the right speakers.

**FADE:** Press this knob lightly so it extends. Turn it to move the sound toward the front or the rear speakers.

Press these knobs back into their stored positions when you're not using them.

## Playing a Compact Disc

Insert a disc partway into the slot, label side up. The player will pull it in. The compact disc symbol will appear on the display. If the ignition and the radio are on, the disc will begin playing. CD will appear on the display next to the compact disc symbol. If you want to insert a disc when the ignition is off, first press the EJECT button.

The integral CD player can play the smaller 8 cm single discs with an adapter ring. Full-size compact discs and the smaller discs are loaded in the same manner. If an error appears on the display, see "Compact Disc Messages" later in this section.

**1 PREV (Previous):** Press this pushbutton to go to the start of the current track if more than eight seconds have played. If you hold the pushbutton or press it more than once, the player will continue moving back through the disc.

**2 NEXT:** Press this pushbutton to go to the start of the next track. If you hold the pushbutton or press it more than once, the player will continue moving forward through the disc.

**3 RDM (Random):** Press this pushbutton to hear the tracks in random, rather than sequential, order. The display will show RDM. Press RDM again to turn off random play.

**5 REV (Reverse):** Press and hold this pushbutton to quickly reverse within a track. You will hear sound at a reduced volume. The display will show elapsed time.

**6 FWD (Forward):** Press and hold this pushbutton to quickly advance within a track. You will hear sound at a reduced volume. The display will show elapsed time.

**▲ SEEK ▼:** Press the up or the down arrow to go to the next or to the previous selection on the tape.

**RECALL:** Press this button to see what track is currently playing. Press it again within five seconds to see how long the track has been playing. When a new track starts to play, the track number will also appear. Press it a third time and the time of day will be displayed.

**AM/FM:** Press this button to listen to the radio when a CD is playing. The CD will stop but remain in the player.

**CD/PLAY:** Press this button to play a CD when listening to the radio.

**▲ EJECT:** Press this button to stop a CD when it is playing or to remove a CD when it is not playing. The EJECT button will work with the radio off.

## Compact Disc Messages

**E (Error):** If this message and a number appears on the radio display or if the disc comes out, it could be for one of the following reasons:

- You're driving on a very rough road. When the road becomes smoother, the disc should play.
- It's very hot. When the temperature returns to normal, the disc should play.
- The disc is dirty, scratched, wet or upside down.
- The air is very humid. If so, wait about an hour and try again.

If the CD is not playing correctly, for any other reason, try a known good CD.

If any error occurs repeatedly or if an error can't be corrected, contact your dealer. If your radio displays an error number, write it down and provide it to your dealer when reporting the problem.

## Radio with CD (Up Level)



## Playing the Radio

**POWER:** Push this knob to turn the system on and off.

**VOL (Volume):** Turn the knob to increase or to decrease volume.

**RECALL:** Press this button to switch the display between the radio station frequency and the time. Pressing this button with the ignition off will display the time.

## Finding a Station

**AM/FM:** Press this button to switch between AM, FM1 and FM2. The display will show your selection.

**TUNE:** Press this knob lightly so it extends. Turn it to choose radio stations. Press the knob back into its stored position when you're not using it.

**▲ SEEK ▼:** Press the up or the down arrow to go to the next or to the previous station and stay there.

## Setting Preset Stations

The six numbered pushbuttons let you return to your favorite stations. You can set up to 18 stations (six AM, six FM1 and six FM2) by performing the following steps:

1. Turn the radio on.
2. Press AM/FM to select AM, FM1 or FM2.
3. Tune in the desired station.

4. Press and hold one of the six numbered pushbuttons until SET appears on the display. Whenever you press that numbered pushbutton, the station you set will return.

5. Repeat the steps for each pushbutton.

## Setting the Tone (Bass/Treble)

**Equalizer:** A seven-band equalizer is part of your audio system. Slide the levers up to boost or down to reduce frequency range.

## Adjusting the Speakers (Balance/Fade)

**BAL (Balance):** Press this knob lightly so it extends. Turn it to move the sound toward the left or the right speakers.

**FADE:** Press this knob lightly so it extends. Turn it to move the sound toward the front or the rear speakers.

Press these knobs back into their stored positions when you're not using them.

## Playing a Compact Disc

Insert a disc partway into the slot, label side up. The player will pull it in. The compact disc symbol will appear on the display. If the ignition and the radio are on, the disc will begin playing. CD will appear on the display next to the compact disc symbol. If you want to insert a disc when the ignition is off, first press the EJECT button.

The integral CD player can play the smaller 8 cm single discs. Full-size compact discs and the smaller discs are loaded in the same manner.

If an error appears on the display, see "Compact Disc Messages" later in this section.

**1 PREV (Previous):** Press this pushbutton to go to the start of the current track if more than eight seconds have played. If you hold the pushbutton or press it more than once, the player will continue moving back through the disc.

**2 NEXT:** Press this pushbutton to go to the start of the next track. If you hold the pushbutton or press it more than once, the player will continue moving forward through the disc.

**3 RDM (Random):** Press this pushbutton to hear the tracks in random, rather than sequential, order. The display will show RDM. Press RDM again to turn off random play.

**5 REV (Reverse):** Press and hold this pushbutton to quickly reverse within a track. You will hear sound at a reduced volume. The display will show elapsed time.

**6 FWD (Forward):** Press and hold this pushbutton to quickly advance forward within a track. You will hear sound at a reduced volume. The display will show elapsed time.

**▲ SEEK ▼:** Press the up or the down arrow to go to the next or to the previous track.

**RECALL:** Press this button to see what track is currently playing. Press it again within five seconds to see how long the track has been playing. When a new track starts to play, the track number will also appear. Press it a third time and the time of day will be displayed.

**AM/FM:** Press this button to listen to the radio when a disc is playing. The disc will stop but remain in the player.

**CD/PLAY:** Press this button to play a CD when listening to the radio.

**▲ EJECT:** Press this button to stop a CD when it is playing or to remove a CD when it is not playing. The EJECT button will work with the radio off.

## Compact Disc Messages

**E (Error):** If this message and a number appears on the radio display or if the disc comes out, it could be for one of the following reasons:

- You're driving on a very rough road. When the road becomes smoother, the disc should play.
- It's very hot. When the temperature returns to normal, the disc should play.
- The disc is dirty, scratched, wet or upside down.
- The air is very humid. If so, wait about an hour and try again.

If the CD is not playing correctly, for any other reason, try a known good CD.

If any error occurs repeatedly or if an error can't be corrected, contact your dealer. If your radio displays an error number, write it down and provide it to your dealer when reporting the problem.

## Theft-Deterrent Feature

THEFTLOCK<sup>®</sup> is designed to discourage theft of your radio. It works by using a secret code to disable all radio functions whenever battery power is interrupted.

The THEFTLOCK feature for the radio may be used or ignored. If ignored, the system plays normally and the radio is not protected by the feature. If THEFTLOCK is activated, your radio will not operate if stolen.

When THEFTLOCK is activated, the radio will display LOC to indicate a locked condition anytime battery power is removed. If your battery loses power for any reason, you must unlock the radio with the secret code before it will operate.

## Activating the Theft-Deterrent Feature

The instructions which follow explain how to enter your secret code to activate the THEFTLOCK system. Read through all nine steps before starting the procedure.

If you allow more than 15 seconds to elapse between any steps, the radio automatically reverts to time and you must start the procedure over at Step 4.

1. Write down any three or four-digit number from 000 to 1999 and keep it in a safe place separate from the vehicle.

2. Turn the ignition on.
3. Turn the radio off.
4. Press the 1 and 4 pushbuttons at the same time. Hold them down until --- shows on the display. Next you will use the secret code number which you have written down.
5. Press MIN and 000 will appear on the display.
6. Press MIN again to make the last two digits agree with your code.
7. Press HR to make the first one or two digits agree with your code.
8. Press AM/FM after you have confirmed that the code matches the secret code you have written down. The display will show REP to let you know that you need to repeat Steps 5 through 7 to confirm your secret code.
9. Press AM/FM and this time the display will show SEC to let you know that your radio is secure.

With the ignition off, the THEFTLOCK LED indicator will flash, indicating a secured radio.

## Unlocking the Theft-Deterrent Feature After a Power Loss

Enter your secret code as follows; pause no more than 15 seconds between steps:

1. Turn the ignition on. LOC will appear on the display.
2. Press MIN and 000 will appear on the display.
3. Press MIN again to make the last two digits agree with your code.
4. Press HR to make the first one or two digits agree with your code.
5. Press AM/FM after you have confirmed that the code matches the secret code you have written down. The display will show SEC, indicating the radio is now operable and secure.

If you enter the wrong code eight times, INOP will appear on the display. You will have to wait an hour with the ignition on before you can try again. When you try again, you will only have three more chances (eight tries per chance) to enter the correct code before INOP appears.

If you lose or forget your code, contact your dealership.



## Disabling the Theft-Deterrent Feature

Enter your secret code as follows; pause no more than 15 seconds between steps:

1. Turn the ignition on.
2. Turn the radio off.
3. Press the 1 and 4 pushbuttons at the same time. Hold them down until SEC shows on the display.
4. Press MIN and 000 will appear on the display.
5. Press MIN again to make the last two digits agree with your code.
6. Press HR to make the first one or two digits agree with your code.
7. Press AM/FM after you have confirmed that the code matches the secret code you have written down. The display will show ---, indicating that the radio is no longer secured.

If the code entered is incorrect, SEC will appear on the display. The radio will remain secured until the correct code is entered.

When battery power is removed and later applied to a secured radio, the radio won't turn on and LOC will appear on the display.

To unlock a secured radio, see "Unlocking the Theft-Deterrent Feature After a Power Loss" earlier in this section.

## Audio Steering Wheel Controls

If your vehicle has this feature, you can control certain radio functions using the buttons on your steering wheel.



**PRESET:** Press this button to play the stations you have programmed on the radio preset pushbuttons. The radio will go to a preset station, play for a few seconds, then go to the next station. When a cassette tape is playing, press this button to change tape sides. Press this button again to stop scanning the preset stations.

**AM FM:** Press this button to select AM, FM1 or FM2. The band you select will be displayed. The frequency will also be displayed and, if the station is in stereo, the stereo indicator will also be displayed. If a cassette tape or compact disc is playing, it will stop and the radio will play.

**▼ SEEK ▲:** Press the up or the down arrow to go to the next or to the previous radio station and stay there.

If a cassette tape is playing, press the up or the down arrow to search for the next or the previous selection on the tape. Your tape must have at least three seconds of silence between each selection for SEEK to work. If a compact disc is playing, press the up arrow to go to the start of the next track. Press the down arrow to go to the start of the current track if more than eight seconds have played. If less than eight seconds have played, press the down arrow to go to the previous track.

**▲ VOL (Volume) ▼:** Press the up or the down arrow to increase or to decrease volume.

**PLAY:** Press this button to play a cassette tape or compact disc when listening to the radio.

**MUTE:** Press this button to silence the system. Press it again, or any other radio button, to turn on the sound.

## Understanding Radio Reception

### AM

The range for most AM stations is greater than for FM, especially at night. The longer range, however, can cause stations to interfere with each other. AM can pick up noise from things like storms and power lines. Try reducing the treble to reduce this noise if you ever get it.

### FM

FM stereo will give you the best sound, but FM signals will reach only about 10 to 40 miles (16 to 65 km). Tall buildings or hills can interfere with FM signals, causing the sound to come and go.

## Care of Your Cassette Tape Player

A tape player that is not cleaned regularly can cause reduced sound quality, ruined cassettes or a damaged mechanism. Cassette tapes should be stored in their cases away from contaminants, direct sunlight and extreme heat. If they aren't, they may not operate properly or may cause failure of the tape player.

Your tape player should be cleaned regularly after every 50 hours of use. Your radio may display CLN to indicate that you have used your tape player for 50 hours without resetting the tape clean timer. If this message appears on the display, your cassette tape player needs to be cleaned. It will still play tapes, but you should clean it as soon as possible to prevent damage to your tapes and player. If you notice a reduction in sound quality, try a known good cassette to see if the tape or the tape player is at fault. If this other cassette has no improvement in sound quality, clean the tape player.

For best results, use a scrubbing action, non-abrasive cleaning cassette with pads which scrub the tape head as the hubs of the cleaner cassette turn. The recommended cleaning cassette is available through your dealership.

The cut tape detection feature of your cassette tape player may identify the cleaning cassette tape as a damaged tape, in error. To prevent the cleaning cassette from being ejected, use the following steps:

1. Turn the ignition on.
2. Turn the radio off.
3. Press and hold the TAPE/PLAY button for five seconds. The tape symbol on the display will flash for two seconds.
4. Insert the scrubbing action cleaning cassette.
5. Eject the cleaning cassette after the manufacturer's recommended cleaning time.

After the cleaning cassette is ejected, the cut tape detection feature will be active again.

You may also choose a non-scrubbing action, wet-type cleaner which uses a cassette with a fabric belt to clean the tape head. This type of cleaning cassette will not eject on its own. A non-scrubbing action cleaner may not clean as thoroughly as the scrubbing type cleaner. The use of a non-scrubbing action, dry-type cleaning cassette is not recommended.

After you clean the player, press and hold EJECT for five seconds to reset the CLN indicator. The radio will display --- to show the indicator was reset.

Cassettes are subject to wear and the sound quality may degrade over time. Always make sure the cassette tape is in good condition before you have your tape player serviced.

## Care of Your CDs

Handle discs carefully. Store them in their original cases or other protective cases and away from direct sunlight and dust. If the surface of a disc is soiled, dampen a clean, soft cloth in a mild, neutral detergent solution and clean it, wiping from the center to the edge.

Be sure never to touch the side without writing when handling discs. Pick up discs by grasping the outer edges or the edge of the hole and the outer edge.

## Care of Your CD Player

The use of CD lens cleaner discs is not advised, due to the risk of contaminating the lens of the CD optics with lubricants internal to the CD mechanism.

## Backglass Antenna

The AM-FM antenna is integrated with the rear window defogger, located in the rear window. Be sure that the inside surface of the rear window is not scratched and that the lines on the glass are not damaged.

If the inside surface is damaged, it could interfere with radio reception. Also, for proper radio reception, the antenna connector at the top-center of the rear window needs to be properly attached to the post on the glass.

**Notice:** Do not try to clear frost or other material from the inside of the rear window with a razor blade or anything else that is sharp. This may damage the rear defogger grid and affect your radio's ability to pick up stations clearly. The repairs wouldn't be covered by your warranty.

Because this antenna is built into your rear window, there is a reduced risk of damage caused by car washes and vandals.

If you choose to add a cellular telephone to your vehicle, and the antenna needs to be attached to the glass, be sure that you do not damage the grid lines for the AM-FM antenna. There is enough space between the lines to attach a cellular telephone antenna without interfering with radio reception.

Do not apply aftermarket glass tinting to the back glass. The metallic film in some tinting materials will interfere with or distort the incoming radio reception. Care must be taken when cleaning the rear window because it breaks in the resistive material heating element and will adversely affect radio and defogger performance. See your dealer for details.



## Section 4 Driving Your Vehicle

---

<b>Your Driving, the Road, and Your Vehicle</b> .....	4-2	City Driving .....	4-22
Defensive Driving .....	4-2	Freeway Driving .....	4-23
Drunken Driving .....	4-3	Before Leaving on a Long Trip .....	4-24
Control of a Vehicle .....	4-6	Highway Hypnosis .....	4-25
Braking .....	4-6	Hill and Mountain Roads .....	4-25
Traction Control System (TCS) .....	4-10	Winter Driving .....	4-27
Enhanced Traction System (ETS) .....	4-11	If You Are Stuck: In Sand, Mud, Ice or Snow .....	4-32
Steering .....	4-13	<b>Towing</b> .....	4-33
Off-Road Recovery .....	4-15	Towing Your Vehicle .....	4-33
Passing .....	4-15	Recreational Vehicle Towing .....	4-33
Loss of Control .....	4-16	Loading Your Vehicle .....	4-35
Driving at Night .....	4-18	Towing a Trailer .....	4-37
Driving in Rain and on Wet Roads .....	4-19		

# Your Driving, the Road, and Your Vehicle

## Defensive Driving

The best advice anyone can give about driving is: Drive defensively.

Please start with a very important safety device in your vehicle: Buckle up. See *Safety Belts: They Are for Everyone* on page 1-7.

Defensive driving really means “be ready for anything.” On city streets, rural roads or freeways, it means “always expect the unexpected.”

Assume that pedestrians or other drivers are going to be careless and make mistakes. Anticipate what they might do. Be ready for their mistakes.

Rear-end collisions are about the most preventable of accidents. Yet they are common. Allow enough following distance. It's the best defensive driving maneuver, in both city and rural driving. You never know when the vehicle in front of you is going to brake or turn suddenly.

Defensive driving requires that a driver concentrate on the driving task. Anything that distracts from the driving task — such as concentrating on a cellular telephone call, reading, or reaching for something on the floor — makes proper defensive driving more difficult and can even cause a collision, with resulting injury. Ask a passenger to help do things like this, or pull off the road in a safe place to do them yourself. These simple defensive driving techniques could save your life.

## Drunken Driving

Death and injury associated with drinking and driving is a national tragedy. It's the number one contributor to the highway death toll, claiming thousands of victims every year.

Alcohol affects four things that anyone needs to drive a vehicle:

- Judgment
- Muscular Coordination
- Vision
- Attentiveness.

Police records show that almost half of all motor vehicle-related deaths involve alcohol. In most cases, these deaths are the result of someone who was drinking and driving. In recent years, more than 16,000 annual motor vehicle-related deaths have been associated with the use of alcohol, with more than 300,000 people injured.

Many adults — by some estimates, nearly half the adult population — choose never to drink alcohol, so they never drive after drinking. For persons under 21, it's against the law in every U.S. state to drink alcohol. There are good medical, psychological and developmental reasons for these laws.

The obvious way to eliminate the leading highway safety problem is for people never to drink alcohol and then drive. But what if people do? How much is "too much" if someone plans to drive? It's a lot less than many might think. Although it depends on each person and situation, here is some general information on the problem.

The Blood Alcohol Concentration (BAC) of someone who is drinking depends upon four things:

- The amount of alcohol consumed
- The drinker's body weight
- The amount of food that is consumed before and during drinking
- The length of time it has taken the drinker to consume the alcohol.



According to the American Medical Association, a 180 lb (82 kg) person who drinks three 12 ounce (355 ml) bottles of beer in an hour will end up with a BAC of about 0.06 percent. The person would reach the same BAC by drinking three 4 ounce (120 ml) glasses of wine or three mixed drinks if each had 1 – 1/2 ounces (45 ml) of a liquor like whiskey, gin or vodka.

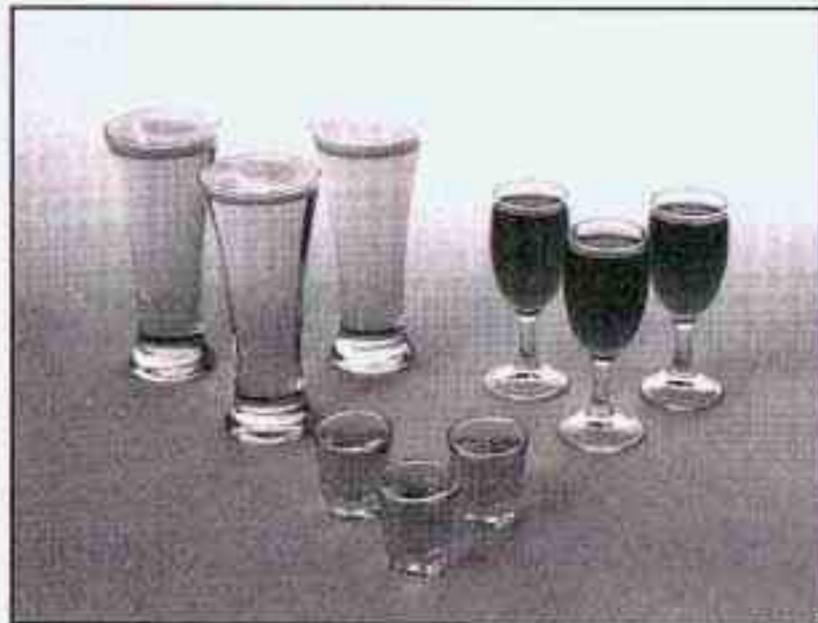

It's the amount of alcohol that counts. For example, if the same person drank three double martinis (3 ounces or 90 ml of liquor each) within an hour, the person's BAC would be close to 0.12 percent. A person who consumes food just before or during drinking will have a somewhat lower BAC level.

There is a gender difference, too. Women generally have a lower relative percentage of body water than men. Since alcohol is carried in body water, this means that a woman generally will reach a higher BAC level than a man of her same body weight when each has the same number of drinks.

The law in an increasing number of U.S. states, and throughout Canada, sets the legal limit at 0.08 percent. In some other countries, the limit is even lower. For example, it is 0.05 percent in both France and Germany. The BAC limit for all commercial drivers in the United States is 0.04 percent.

The BAC will be over 0.10 percent after three to six drinks (in one hour). Of course, as we've seen, it depends on how much alcohol is in the drinks, and how quickly the person drinks them.

But the ability to drive is affected well below a BAC of 0.10 percent. Research shows that the driving skills of many people are impaired at a BAC approaching 0.05 percent, and that the effects are worse at night. All drivers are impaired at BAC levels above 0.05 percent. Statistics show that the chance of being in a collision increases sharply for drivers who have a BAC of 0.05 percent or above. A driver with a BAC level of 0.06 percent has doubled his or her chance of having a collision. At a BAC level of 0.10 percent, the chance of this driver having a collision is 12 times greater; at a level of 0.15 percent, the chance is 25 times greater!

The body takes about an hour to rid itself of the alcohol in one drink. No amount of coffee or number of cold showers will speed that up. "I'll be careful" isn't the right answer. What if there's an emergency, a need to take sudden action, as when a child darts into the street? A person with even a moderate BAC might not be able to react quickly enough to avoid the collision.

There's something else about drinking and driving that many people don't know. Medical research shows that alcohol in a person's system can make crash injuries worse, especially injuries to the brain, spinal cord or heart. This means that when anyone who has been drinking — driver or passenger — is in a crash, that person's chance of being killed or permanently disabled is higher than if the person had not been drinking.

 **CAUTION:**

**Drinking and then driving is very dangerous. Your reflexes, perceptions, attentiveness and judgement can be affected by even a small amount of alcohol. You can have a serious — or even fatal — collision if you drive after drinking. Please don't drink and drive or ride with a driver who has been drinking. Ride home in a cab; or if you're with a group, designate a driver who will not drink.**

## Control of a Vehicle

You have three systems that make your vehicle go where you want it to go. They are the brakes, the steering and the accelerator. All three systems have to do their work at the places where the tires meet the road.

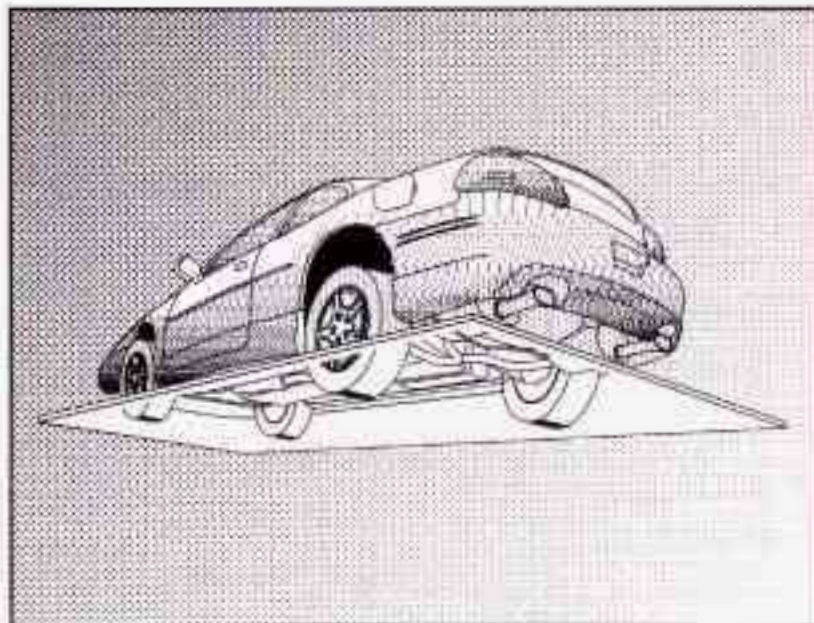

Sometimes, as when you're driving on snow or ice, it's easy to ask more of those control systems than the tires and road can provide. That means you can lose control of your vehicle. Also see *Traction Control System (TCS)* on page 4-10 and *Enhanced Traction System (ETS)* on page 4-11.

## Braking

Braking action involves *perception time* and *reaction time*.

First, you have to decide to push on the brake pedal. That's *perception time*. Then you have to bring up your foot and do it. That's *reaction time*.

Average *reaction time* is about  $\frac{3}{4}$  of a second. But that's only an average. It might be less with one driver and as long as two or three seconds or more with another. Age, physical condition, alertness, coordination and eyesight all play a part. So do alcohol, drugs and frustration. But even in  $\frac{3}{4}$  of a second, a vehicle moving at 60 mph (100 km/h) travels 66 feet (20 m). That could be a lot of distance in an emergency, so keeping enough space between your vehicle and others is important.

And, of course, actual stopping distances vary greatly with the surface of the road (whether it's pavement or gravel); the condition of the road (wet, dry, icy); tire tread; the condition of your brakes; the weight of the vehicle and the amount of brake force applied.

Avoid needless heavy braking. Some people drive in spurts — heavy acceleration followed by heavy braking — rather than keeping pace with traffic. This is a mistake. Your brakes may not have time to cool between hard stops. Your brakes will wear out much faster if you do a lot of heavy braking. If you keep pace with the traffic and allow realistic following distances, you will eliminate a lot of unnecessary braking. That means better braking and longer brake life.

If your engine ever stops while you're driving, brake normally but don't pump your brakes. If you do, the pedal may get harder to push down. If your engine stops, you will still have some power brake assist. But you will use it when you brake. Once the power assist is used up, it may take longer to stop and the brake pedal will be harder to push.

## Anti-lock Brake System (ABS)

Your vehicle may have anti-lock brakes. ABS is an advanced electronic braking system that will help prevent a braking skid.

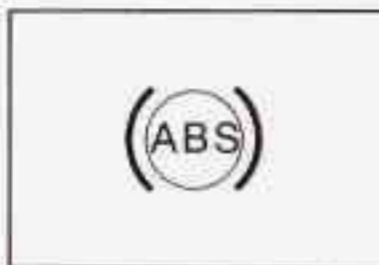

If your vehicle has anti-lock brakes, this warning light on the instrument panel will come on briefly when you start your vehicle.

When you start your engine, or when you begin to drive away, your anti-lock brake system will check itself. You may hear a momentary motor or clicking noise while this test is going on, and you may even notice that your brake pedal moves or pulses a little. This is normal.

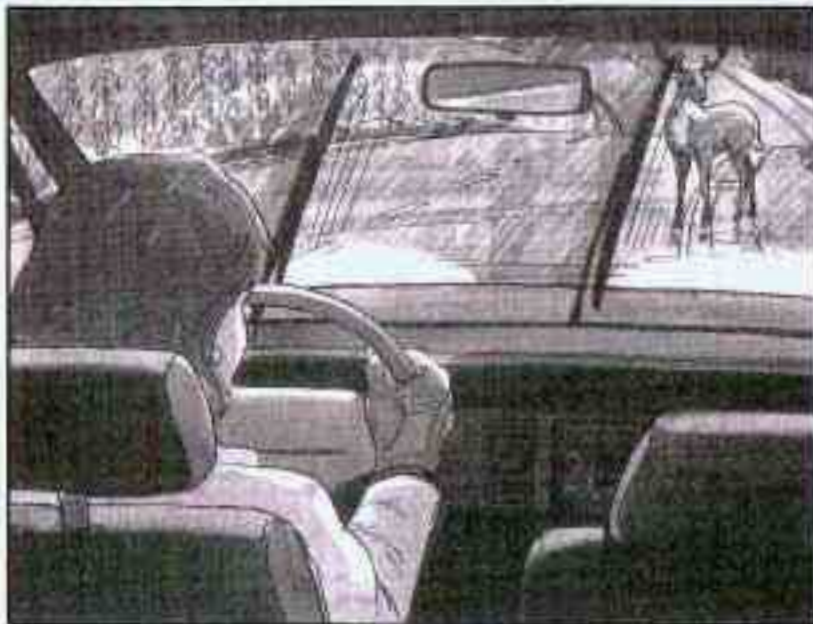

Let's say the road is wet and you're driving safely. Suddenly, an animal jumps out in front of you. You slam on the brakes and continue braking. Here's what happens with ABS:

A computer senses that wheels are slowing down. If one of the wheels is about to stop rolling, the computer will separately work the brakes at each front wheel and at both rear wheels.

The anti-lock system can change the brake pressure faster than any driver could. The computer is programmed to make the most of available tire and road conditions. This can help you steer around the obstacle while braking hard.



As you brake, your computer keeps receiving updates on wheel speed and controls braking pressure accordingly.

Remember: Anti-lock doesn't change the time you need to get your foot up to the brake pedal or always decrease stopping distance. If you get too close to the vehicle in front of you, you won't have time to apply your brakes if that vehicle suddenly slows or stops. Always leave enough room up ahead to stop, even though you have anti-lock brakes.

## Using Anti-Lock

Don't pump the brakes. Just hold the brake pedal down firmly and let anti-lock work for you. You may feel a slight brake pedal pulsation or notice some noise, but this is normal.

## Braking in Emergencies

At some time, nearly every driver gets into a situation that requires hard braking.

If you have anti-lock, you can steer and brake at the same time. However, if you don't have anti-lock, your first reaction — to hit the brake pedal hard and hold it down — may be the wrong thing to do.

Your wheels can stop rolling. Once they do, the vehicle can't respond to your steering. Momentum will carry it in whatever direction it was headed when the wheels stopped rolling. That could be off the road, into the very thing you were trying to avoid, or into traffic.

If you don't have anti-lock, use a "squeeze" braking technique. This will give you maximum braking while maintaining steering control. You can do this by pushing on the brake pedal with steadily increasing pressure.

In an emergency, you will probably want to squeeze the brakes hard without locking the wheels. If you hear or feel the wheels sliding, ease off the brake pedal. This will help you retain steering control. If you *do* have anti-lock, it's different. See "Anti-Lock Brakes."

In many emergencies, steering can help you more than even the very best braking.

## Traction Control System (TCS)

If your vehicle has the 3800 supercharged V6 engine it has a traction control system that limits wheel spin. This is especially useful in slippery road conditions. The system operates only if it senses that one or both of the front wheels are spinning or beginning to lose traction. When this happens, the system works the front brakes and reduces engine power to limit wheel spin.



LOW  
TRAC

This light will come on when your traction control system is limiting wheel spin. See *Traction Control System (TCS) Warning Light* on page 3-29.

You may feel or hear the system working, but this is normal.

If your vehicle is in cruise control when the traction control system begins to limit wheel spin, the cruise control will automatically disengage. When road conditions allow you to safely use it again, you may reengage the cruise control. See "Cruise Control" under *Turn Signal/Multifunction Lever* on page 3-5.



TCS  
OFF

This light should come on briefly when you start the engine. If it stays on or comes on while you are driving, there is a problem with your traction control system.

See *Traction Control System (TCS) Warning Light* on page 3-29. When this warning light is on, the system will not limit wheel spin. Adjust your driving accordingly.

The traction control system automatically comes on whenever you start your vehicle. To limit wheel spin, especially in slippery road conditions, you should always leave the system on. But you can turn the traction control system off if you ever need to. You should turn the system off if your vehicle ever gets stuck in sand, mud or snow and rocking the vehicle is required. See "Rocking Your Vehicle to Get It Out" under *If You Are Stuck: In Sand, Mud, Ice or Snow* on page 4-32.

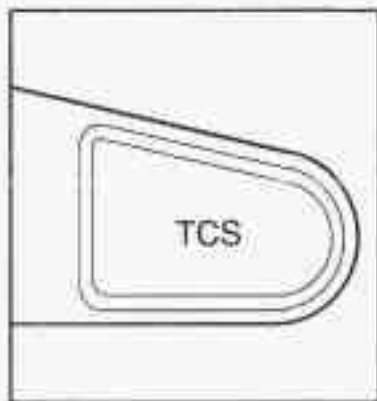

To turn the system off, press the button located on the instrument panel DIC (Driver's Information Center) or Trip Computer, if equipped.

The traction control system warning light will come on and stay on. If the system is limiting wheel spin when you press the button, the warning light will come on and the system will turn off instantly.

You can turn the system back on at any time by pressing the button again. The traction control system warning light should go off.

## Enhanced Traction System (ETS)

If your vehicle has the 3100 V6 or 3800 V6 engine and anti-lock brakes, your vehicle may have an Enhanced Traction System (ETS) that limits wheel spin. This is especially useful in slippery road conditions. The system operates only if it senses that one or both of the front wheels are spinning or beginning to lose traction. When this happens, the system reduces engine power and may also upshift the transaxle to limit wheel spin.

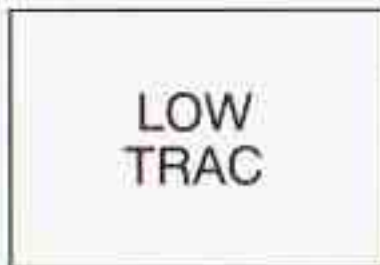

This light will come on when your Enhanced Traction System is limiting wheel spin. See *Enhanced Traction System Warning Light on page 3-29*.

If your vehicle is in cruise control when the enhanced traction system begins to limit wheel spin, the cruise control will automatically disengage. When road conditions allow you to safely use it again, you may re-engage the cruise control. See "Cruise Control" under *Turn Signal/Multifunction Lever on page 3-5*.



The Enhanced Traction System operates in all transaxle shift lever positions. But the system can upshift the transaxle only as high as the shift lever position you've chosen, so you should use the lower gears only when necessary. See *Automatic Transaxle Operation* on page 2-24.



This TRAC OFF warning light will come on to let you know if there's a problem.

See *Enhanced Traction System Warning Light* on page 3-30. When this warning light is on, the system will not limit wheel spin. Adjust your driving accordingly.

To limit wheel spin, especially in slippery road conditions, you should always leave the Enhanced Traction System on. But you can turn the system off if you ever need to. You should turn the system off if your vehicle ever gets stuck in sand, mud or snow and rocking the vehicle is required. See "Rocking Your Vehicle To Get It Out" under *If You Are Stuck: In Sand, Mud, Ice or Snow* on page 4-32.

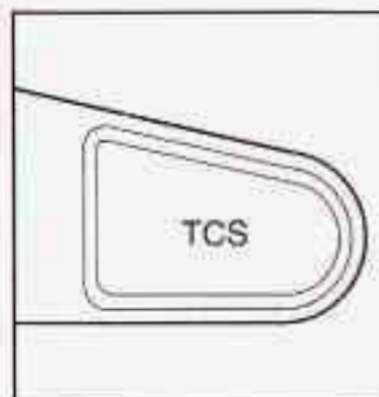

To turn the system on or off, press the TCS button on the far right end of the Driver Information Center (DIC) or the trip computer (if equipped).

When you turn the system off, the Enhanced Traction System warning light will come on and stay on. If the Enhanced Traction System is limiting wheel spin when you press the button to turn the system off, the warning light will come on and the system will turn off right away.

You can turn the system back on at any time by pressing the button again. The Enhanced Traction System warning light should go off.

## Steering

### Power Steering

If you lose power steering assist because the engine stops or the system is not functioning, you can steer but it will take much more effort.

### Variable Effort Steering

If your vehicle has this steering system, the system provides less steering effort for parking and when driving at speeds below 20 mph (32 km/h). Steering effort will increase at higher speeds for improved road feel.

## Steering Tips

### Driving on Curves

It's important to take curves at a reasonable speed.

A lot of the "driver lost control" accidents mentioned on the news happen on curves. Here's why:

Experienced driver or beginner, each of us is subject to the same laws of physics when driving on curves. The traction of the tires against the road surface makes it possible for the vehicle to change its path when you turn the front wheels. If there's no traction, inertia will keep the vehicle going in the same direction. If you've ever tried to steer a vehicle on wet ice, you'll understand this.

The traction you can get in a curve depends on the condition of your tires and the road surface, the angle at which the curve is banked, and your speed. While you're in a curve, speed is the one factor you can control.

Suppose you're steering through a sharp curve. Then you suddenly accelerate. Both control systems — steering and braking — have to do their work where the tires meet the road. Unless you have four-wheel anti-lock brakes, adding the hard braking can demand too much of those places. You can lose control.

The same thing can happen if you're steering through a sharp curve and you suddenly accelerate. Those two control systems — steering and acceleration — can overwhelm those places where the tires meet the road and make you lose control. See *Traction Control System (TCS)* on page 4-10 or *Enhanced Traction System (ETS)* on page 4-11.

What should you do if this ever happens? Ease up on the brake or accelerator pedal, steer the vehicle the way you want it to go, and slow down.

Speed limit signs near curves warn that you should adjust your speed. Of course, the posted speeds are based on good weather and road conditions. Under less favorable conditions you'll want to go slower.

If you need to reduce your speed as you approach a curve, do it before you enter the curve, while your front wheels are straight ahead.

Try to adjust your speed so you can “drive” through the curve. Maintain a reasonable, steady speed. Wait to accelerate until you are out of the curve, and then accelerate gently into the straightaway.

## Steering in Emergencies

There are times when steering can be more effective than braking. For example, you come over a hill and find a truck stopped in your lane, or a car suddenly pulls out from nowhere, or a child darts out from between parked cars and stops right in front of you. You can avoid these problems by braking — if you can stop in time. But sometimes you can't; there isn't room. That's the time for evasive action — steering around the problem.

Your vehicle can perform very well in emergencies like these. First apply your brakes.

See *Braking on page 4-6*. It is better to remove as much speed as you can from a possible collision. Then steer around the problem, to the left or right depending on the space available.



An emergency like this requires close attention and a quick decision. If you are holding the steering wheel at the recommended 9 and 3 o'clock positions, you can turn it a full 180 degrees very quickly without removing either hand. But you have to act fast, steer quickly, and just as quickly straighten the wheel once you have avoided the object.

The fact that such emergency situations are always possible is a good reason to practice defensive driving at all times and wear safety belts properly.

## Off-Road Recovery

You may find that your right wheels have dropped off the edge of a road onto the shoulder while you're driving.

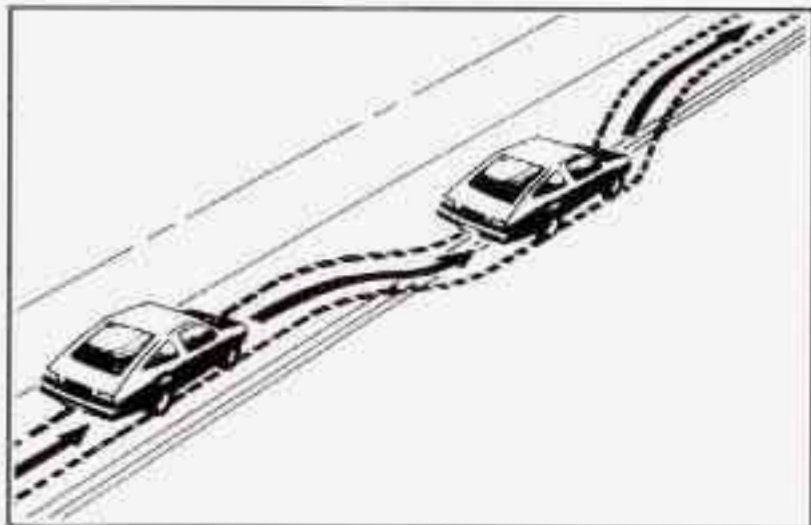

If the level of the shoulder is only slightly below the pavement, recovery should be fairly easy. Ease off the accelerator and then, if there is nothing in the way, steer so that your vehicle straddles the edge of the pavement. You can turn the steering wheel up to one-quarter turn until the right front tire contacts the pavement edge. Then turn your steering wheel to go straight down the roadway.

## Passing

The driver of a vehicle about to pass another on a two-lane highway waits for just the right moment, accelerates, moves around the vehicle ahead, then goes back into the right lane again. A simple maneuver?

Not necessarily! Passing another vehicle on a two-lane highway is a potentially dangerous move, since the passing vehicle occupies the same lane as oncoming traffic for several seconds. A miscalculation, an error in judgment, or a brief surrender to frustration or anger can suddenly put the passing driver face to face with the worst of all traffic accidents — the head-on collision.

So here are some tips for passing:

- "Drive ahead." Look down the road, to the sides and to crossroads for situations that might affect your passing patterns. If you have any doubt whatsoever about making a successful pass, wait for a better time.
- Watch for traffic signs, pavement markings and lines. If you can see a sign up ahead that might indicate a turn or an intersection, delay your pass. A broken center line usually indicates it's all right to pass (providing the road ahead is clear). Never cross a solid line on your side of the lane or a double solid line, even if the road seems empty of approaching traffic.

- Do not get too close to the vehicle you want to pass while you're awaiting an opportunity. For one thing, following too closely reduces your area of vision, especially if you're following a larger vehicle. Also, you won't have adequate space if the vehicle ahead suddenly slows or stops. Keep back a reasonable distance.
- When it looks like a chance to pass is coming up, start to accelerate but stay in the right lane and don't get too close. Time your move so you will be increasing speed as the time comes to move into the other lane. If the way is clear to pass, you will have a "running start" that more than makes up for the distance you would lose by dropping back. And if something happens to cause you to cancel your pass, you need only slow down and drop back again and wait for another opportunity.
- If other vehicles are lined up to pass a slow vehicle, wait your turn. But take care that someone isn't trying to pass you as you pull out to pass the slow vehicle. Remember to glance over your shoulder and check the blind spot.
- Check your mirrors, glance over your shoulder, and start your left lane change signal before moving out of the right lane to pass. When you are far enough ahead of the passed vehicle to see its front in your

inside mirror, activate your right lane change signal and move back into the right lane. (Remember that your right outside mirror is convex. The vehicle you just passed may seem to be farther away from you than it really is.)

- Try not to pass more than one vehicle at a time on two-lane roads. Reconsider before passing the next vehicle.
- Don't overtake a slowly moving vehicle too rapidly. Even though the brake lamps are not flashing, it may be slowing down or starting to turn.
- If you're being passed, make it easy for the following driver to get ahead of you. Perhaps you can ease a little to the right.

## Loss of Control

Let's review what driving experts say about what happens when the three control systems (brakes, steering and acceleration) don't have enough friction where the tires meet the road to do what the driver has asked.

In any emergency, don't give up. Keep trying to steer and constantly seek an escape route or area of less danger.

## Skidding

In a skid, a driver can lose control of the vehicle. Defensive drivers avoid most skids by taking reasonable care suited to existing conditions, and by not “overdriving” those conditions. But skids are always possible.

The three types of skids correspond to your vehicle’s three control systems. In the braking skid, your wheels aren’t rolling. In the steering or cornering skid, too much speed or steering in a curve causes tires to slip and lose cornering force. And in the acceleration skid, too much throttle causes the driving wheels to spin.

A cornering skid is best handled by easing your foot off the accelerator pedal.

If you do not have the Enhanced Traction System or the Traction Control System, or if the system is off, then an acceleration skid is also best handled by easing your foot off the accelerator pedal.

If your vehicle starts to slide, ease your foot off the accelerator pedal and quickly steer the way you want the vehicle to go. If you start steering quickly enough, your vehicle may straighten out. Always be ready for a second skid if it occurs.

Of course, traction is reduced when water, snow, ice, gravel or other material is on the road. For safety, you’ll want to slow down and adjust your driving to these conditions. It is important to slow down on slippery surfaces because stopping distance will be longer and vehicle control more limited.

While driving on a surface with reduced traction, try your best to avoid sudden steering, acceleration or braking (including engine braking by shifting to a lower gear). Any sudden changes could cause the tires to slide. You may not realize the surface is slippery until your vehicle is skidding. Learn to recognize warning clues — such as enough water, ice or packed snow on the road to make a “mirrored surface” — and slow down when you have any doubt.

If you have the anti-lock braking system, remember: It helps avoid only the braking skid. If you do not have anti-lock, then in a braking skid (where the wheels are no longer rolling), release enough pressure on the brakes to get the wheels rolling again. This restores steering control. Push the brake pedal down steadily when you have to stop suddenly. As long as the wheels are rolling, you will have steering control.

## Driving at Night

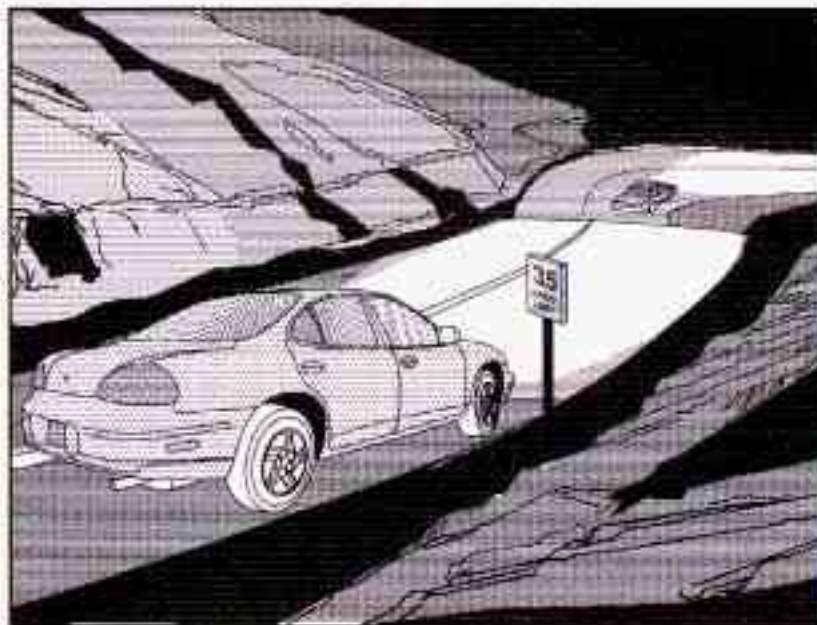

Night driving is more dangerous than day driving. One reason is that some drivers are likely to be impaired — by alcohol or drugs, with night vision problems, or by fatigue.

Here are some tips on night driving.

- Drive defensively.
- Don't drink and drive.
- Adjust your inside rearview mirror to reduce the glare from headlamps behind you.
- Since you can't see as well, you may need to slow down and keep more space between you and other vehicles.
- Slow down, especially on higher speed roads. Your headlamps can light up only so much road ahead.
- In remote areas, watch for animals.
- If you're tired, pull off the road in a safe place and rest.

No one can see as well at night as in the daytime. But as we get older these differences increase. A 50-year-old driver may require at least twice as much light to see the same thing at night as a 20-year-old.

What you do in the daytime can also affect your night vision. For example, if you spend the day in bright sunshine you are wise to wear sunglasses. Your eyes will have less trouble adjusting to night. But if you're driving, don't wear sunglasses at night. They may cut down on glare from headlamps, but they also make a lot of things invisible.

You can be temporarily blinded by approaching headlamps. It can take a second or two, or even several seconds, for your eyes to readjust to the dark. When you are faced with severe glare (as from a driver who doesn't lower the high beams, or a vehicle with misaimed headlamps), slow down a little. Avoid staring directly into the approaching headlamps.

Keep your windshield and all the glass on your vehicle clean — inside and out. Glare at night is made much worse by dirt on the glass. Even the inside of the glass can build up a film caused by dust. Dirty glass makes lights dazzle and flash more than clean glass would, making the pupils of your eyes contract repeatedly.

Remember that your headlamps light up far less of a roadway when you are in a turn or curve. Keep your eyes moving; that way, it's easier to pick out dimly lighted objects. Just as your headlamps should be checked regularly for proper aim, so should your eyes be examined regularly. Some drivers suffer from night blindness — the inability to see in dim light — and aren't even aware of it.

## Driving in Rain and on Wet Roads



Rain and wet roads can mean driving trouble. On a wet road, you can't stop, accelerate or turn as well because your tire-to-road traction isn't as good as on dry roads. And, if your tires don't have much tread left, you'll get even less traction. It's always wise to go slower and be cautious if rain starts to fall while you are driving. The surface may get wet suddenly when your reflexes are tuned for driving on dry pavement.



The heavier the rain, the harder it is to see. Even if your windshield wiper blades are in good shape, a heavy rain can make it harder to see road signs and traffic signals, pavement markings, the edge of the road and even people walking.

It's wise to keep your windshield wiping equipment in good shape and keep your windshield washer tank filled with washer fluid. Replace your windshield wiper inserts when they show signs of streaking or missing areas on the windshield, or when strips of rubber start to separate from the inserts.



Driving too fast through large water puddles or even going through some car washes can cause problems, too. The water may affect your brakes. Try to avoid puddles. But if you can't, try to slow down before you hit them.

### **⚠ CAUTION:**

**Wet brakes can cause accidents. They won't work as well in a quick stop and may cause pulling to one side. You could lose control of the vehicle.**

**After driving through a large puddle of water or a car wash, apply your brake pedal lightly until your brakes work normally.**

## **Hydroplaning**

Hydroplaning is dangerous. So much water can build up under your tires that they can actually ride on the water. This can happen if the road is wet enough and you're going fast enough. When your vehicle is hydroplaning, it has little or no contact with the road.

Hydroplaning doesn't happen often. But it can if your tires do not have much tread or if the pressure in one or more is low. It can happen if a lot of water is standing on the road. If you can see reflections from trees, telephone poles or other vehicles, and raindrops "dimple" the water's surface, there could be hydroplaning.

Hydroplaning usually happens at higher speeds. There just isn't a hard and fast rule about hydroplaning. The best advice is to slow down when it is raining.

## Driving Through Deep Standing Water

**Notice:** If you drive too quickly through deep puddles or standing water, water can come in through your engine's air intake and badly damage your engine. Never drive through water that is slightly lower than the underbody of your vehicle. If you can't avoid deep puddles or standing water, drive through them very slowly.

## Driving Through Flowing Water

### CAUTION:

Flowing or rushing water creates strong forces. If you try to drive through flowing water, as you might at a low water crossing, your vehicle can be carried away. As little as six inches of flowing water can carry away a smaller vehicle. If this happens, you and other vehicle occupants could drown. Don't ignore police warning signs, and otherwise be very cautious about trying to drive through flowing water.

## Some Other Rainy Weather Tips

- Besides slowing down, allow some extra following distance. And be especially careful when you pass another vehicle. Allow yourself more clear room ahead, and be prepared to have your view restricted by road spray.
- Have good tires with proper tread depth. See *Tires* on page 5-68.

## City Driving



One of the biggest problems with city streets is the amount of traffic on them. You'll want to watch out for what the other drivers are doing and pay attention to traffic signals.

Here are ways to increase your safety in city driving:

- Know the best way to get to where you are going. Get a city map and plan your trip into an unknown part of the city just as you would for a cross-country trip.
- Try to use the freeways that rim and crisscross most large cities. You'll save time and energy. See the next part, "Freeway Driving."
- Treat a green light as a warning signal. A traffic light is there because the corner is busy enough to need it. When a light turns green, and just before you start to move, check both ways for vehicles that have not cleared the intersection or may be running the red light.

## Freeway Driving

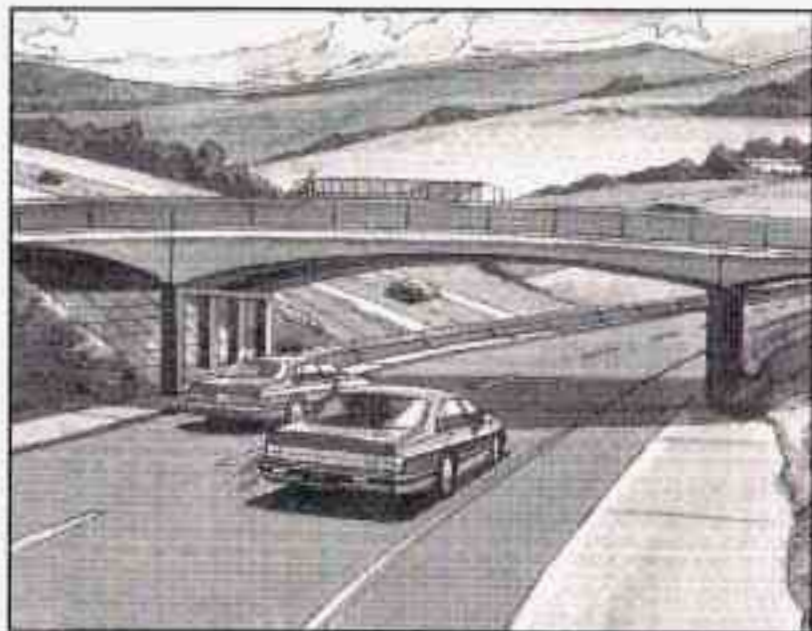

Mile for mile, freeways (also called thruways, parkways, expressways, turnpikes or superhighways) are the safest of all roads. But they have their own special rules.

The most important advice on freeway driving is: Keep up with traffic and keep to the right. Drive at the same speed most of the other drivers are driving. Too-fast or too-slow driving breaks a smooth traffic flow. Treat the left lane on a freeway as a passing lane.

At the entrance, there is usually a ramp that leads to the freeway. If you have a clear view of the freeway as you drive along the entrance ramp, you should begin to check traffic. Try to determine where you expect to blend with the flow. Try to merge into the gap at close to the prevailing speed. Switch on your turn signal, check your mirrors and glance over your shoulder as often as necessary. Try to blend smoothly with the traffic flow.

Once you are on the freeway, adjust your speed to the posted limit or to the prevailing rate if it's slower. Stay in the right lane unless you want to pass.

Before changing lanes, check your mirrors. Then use your turn signal.

Just before you leave the lane, glance quickly over your shoulder to make sure there isn't another vehicle in your "blind" spot.

Once you are moving on the freeway, make certain you allow a reasonable following distance.

Expect to move slightly slower at night.

When you want to leave the freeway, move to the proper lane well in advance. If you miss your exit, do not, under any circumstances, stop and back up. Drive on to the next exit.

The exit ramp can be curved, sometimes quite sharply. The exit speed is usually posted. Reduce your speed according to your speedometer, not to your sense of motion. After driving for any distance at higher speeds, you may tend to think you are going slower than you actually are.

## Before Leaving on a Long Trip

Make sure you're ready. Try to be well rested. If you must start when you're not fresh — such as after a day's work — don't plan to make too many miles that first part of the journey. Wear comfortable clothing and shoes you can easily drive in.

Is your vehicle ready for a long trip? If you keep it serviced and maintained, it's ready to go. If it needs service, have it done before starting out.

Of course, you'll find experienced and able service experts in dealerships all across North America. They'll be ready and willing to help if you need it.

Here are some things you can check before a trip:

- *Windshield Washer Fluid:* Is the reservoir full? Are all windows clean inside and outside?
- *Wiper Blades:* Are they in good shape?
- *Fuel, Engine Oil, Other Fluids:* Have you checked all levels?
- *Lamps:* Are they all working? Are the lenses clean?
- *Tires:* They are vitally important to a safe, trouble-free trip. Is the tread good enough for long-distance driving? Are the tires all inflated to the recommended pressure?
- *Weather Forecasts:* What's the weather outlook along your route? Should you delay your trip a short time to avoid a major storm system?
- *Maps:* Do you have up-to-date maps?

## Highway Hypnosis

Is there actually such a condition as "highway hypnosis"? Or is it just plain falling asleep at the wheel? Call it highway hypnosis, lack of awareness, or whatever.

There is something about an easy stretch of road with the same scenery, along with the hum of the tires on the road, the drone of the engine, and the rush of the wind against the vehicle that can make you sleepy. Don't let it happen to you! If it does, your vehicle can leave the road in *less than a second*, and you could crash and be injured.

What can you do about highway hypnosis? First, be aware that it can happen.

Then here are some tips:

- Make sure your vehicle is well ventilated, with a comfortably cool interior.
- Keep your eyes moving. Scan the road ahead and to the sides. Check your rearview mirrors and your instruments frequently.
- If you get sleepy, pull off the road into a rest, service or parking area and take a nap, get some exercise, or both. For safety, treat drowsiness on the highway as an emergency.

## Hill and Mountain Roads



Driving on steep hills or mountains is different from driving in flat or rolling terrain.

If you drive regularly in steep country, or if you're planning to visit there, here are some tips that can make your trips safer and more enjoyable.

- Keep your vehicle in good shape. Check all fluid levels and also the brakes, tires, cooling system and transaxle. These parts can work hard on mountain roads.
- Know how to go down hills. The most important thing to know is this: let your engine do some of the slowing down. Shift to a lower gear when you go down a steep or long hill.

### CAUTION:

**If you don't shift down, your brakes could get so hot that they wouldn't work well. You would then have poor braking or even none going down a hill. You could crash. Shift down to let your engine assist your brakes on a steep downhill slope.**

### CAUTION:

**Coasting downhill in NEUTRAL (N) or with the ignition off is dangerous. Your brakes will have to do all the work of slowing down. They could get so hot that they wouldn't work well. You would then have poor braking or even none going down a hill. You could crash. Always have your engine running and your vehicle in gear when you go downhill.**

- Know how to go uphill. You may want to shift down to a lower gear. The lower gears help cool your engine and transaxle, and you can climb the hill better.
- Stay in your own lane when driving on two-lane roads in hills or mountains. Don't swing wide or cut across the center of the road. Drive at speeds that let you stay in your own lane.
- As you go over the top of a hill, be alert. There could be something in your lane, like a stalled car or an accident.
- You may see highway signs on mountains that warn of special problems. Examples are long grades, passing or no-passing zones, a falling rocks area or winding roads. Be alert to these and take appropriate action.

## Winter Driving

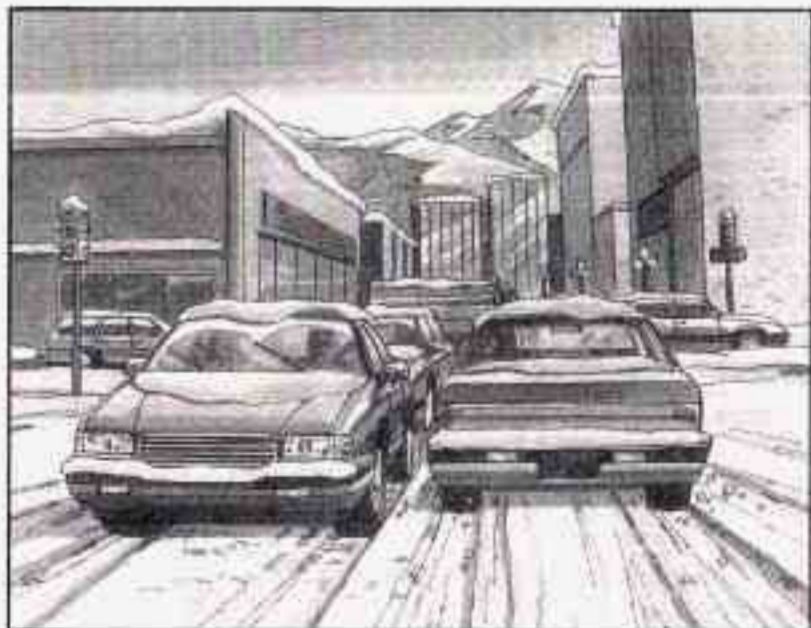

Here are some tips for winter driving:

- Have your vehicle in good shape for winter.
- You may want to put winter emergency supplies in your trunk.

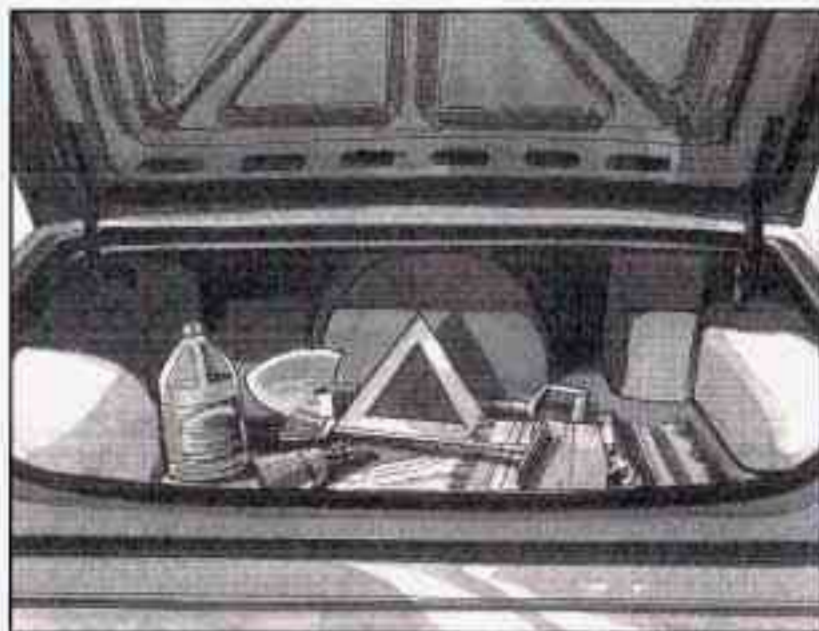

Include an ice scraper, a small brush or broom, a supply of windshield washer fluid, a rag, some winter outer clothing, a small shovel, a flashlight, a red cloth and a couple of reflective warning triangles. And, if you will be driving under severe conditions, include a small bag of sand, a piece of old carpet or a couple of burlap bags to help provide traction. Be sure you properly secure these items in your vehicle.



## Driving on Snow or Ice

Most of the time, those places where your tires meet the road probably have good traction.

However, if there is snow or ice between your tires and the road, you can have a very slippery situation.

You'll have a lot less traction or "grip" and will need to be very careful.

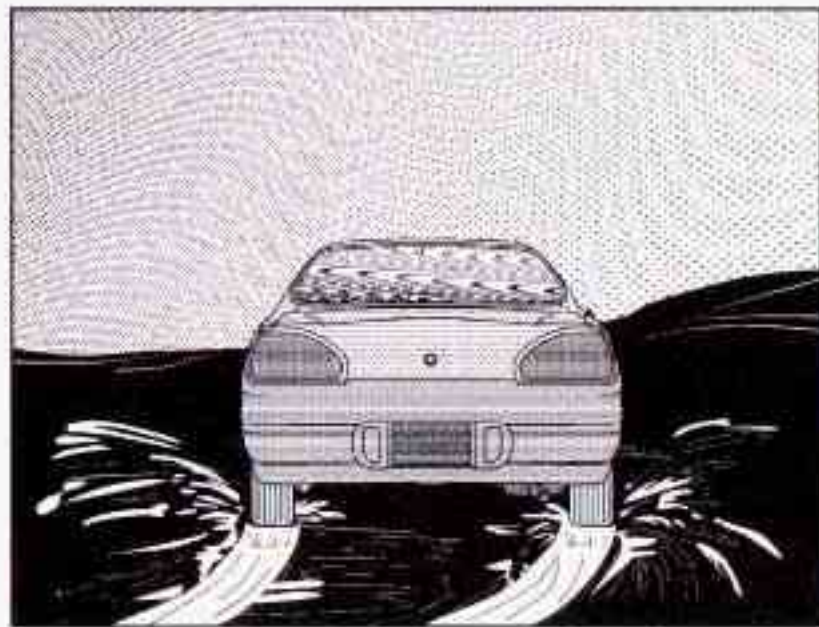

What's the worst time for this? "Wet ice." Very cold snow or ice can be slick and hard to drive on. But wet ice can be even more trouble because it may offer the least traction of all. You can get wet ice when it's about freezing (32°F; 0°C) and freezing rain begins to fall. Try to avoid driving on wet ice until salt and sand crews can get there.

Whatever the condition — smooth ice, packed, blowing or loose snow — drive with caution.

If you have traction control or enhanced traction, keep the system on. It will improve your ability to accelerate when driving on a slippery road. Even though your vehicle has a traction control system you'll want to slow down and adjust your driving to the road conditions. See *Traction Control System (TCS)* on page 4-10.

If you don't have a traction control or enhanced traction system, accelerate gently. Try not to break the gentle traction. If you accelerate too fast, the drive wheels will spin and polish the surface under the tires even more.

Unless you have the anti-lock braking system, you'll want to brake very gently, too. (If you do have anti-lock, see *Braking* on page 4-6. This system improves your vehicle's stability when you make a hard stop on a slippery road.) Whether you have the anti-lock braking system or not, you'll want to begin stopping sooner than you would on dry pavement.

Without anti-lock brakes, if you feel your vehicle begin to slide, let up on the brakes a little. Push the brake pedal down steadily to get the most traction you can.

Remember, unless you have anti-lock, if you brake so hard that your wheels stop rolling, you'll just slide. Brake so your wheels always keep rolling and you can still steer.

- Whatever your braking system, allow greater following distance on any slippery road.
- Watch for slippery spots. The road might be fine until you hit a spot that's covered with ice. On an otherwise clear road, ice patches may appear in shaded areas where the sun can't reach: around clumps of trees, behind buildings or under bridges. Sometimes the surface of a curve or an overpass may remain icy when the surrounding roads are clear. If you see a patch of ice ahead of you, brake before you are on it. Try not to brake while you're actually on the ice, and avoid sudden steering maneuvers.

## If You're Caught in a Blizzard

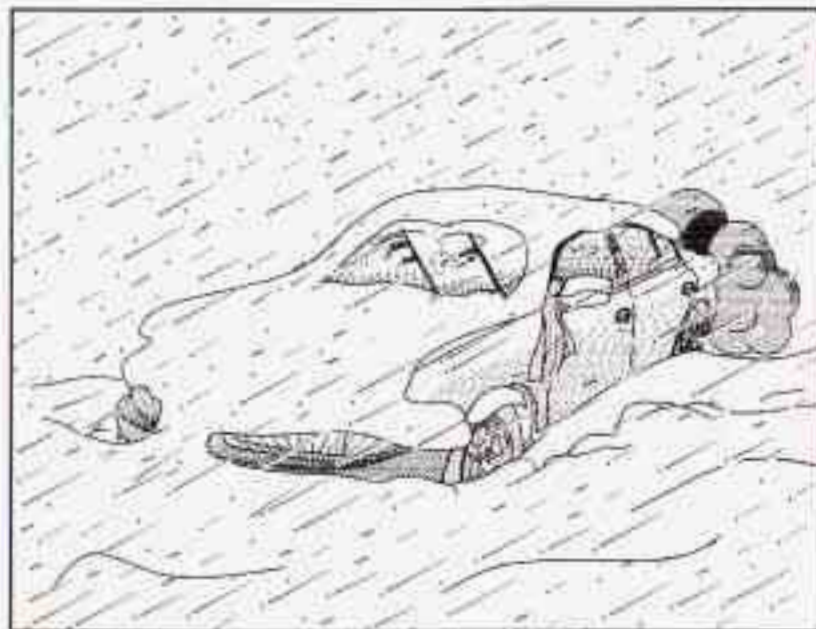

If you are stopped by heavy snow, you could be in a serious situation. You should probably stay with your vehicle unless you know for sure that you are near help and you can hike through the snow.

Here are some things to do to summon help and keep yourself and your passengers safe:

- Turn on your hazard flashers.
- Tie a red cloth to your vehicle to alert police that you've been stopped by the snow.
- Put on extra clothing or wrap a blanket around you. If you have no blankets or extra clothing, make body insulators from newspapers, burlap bags, rags, floor mats — anything you can wrap around yourself or tuck under your clothing to keep warm.

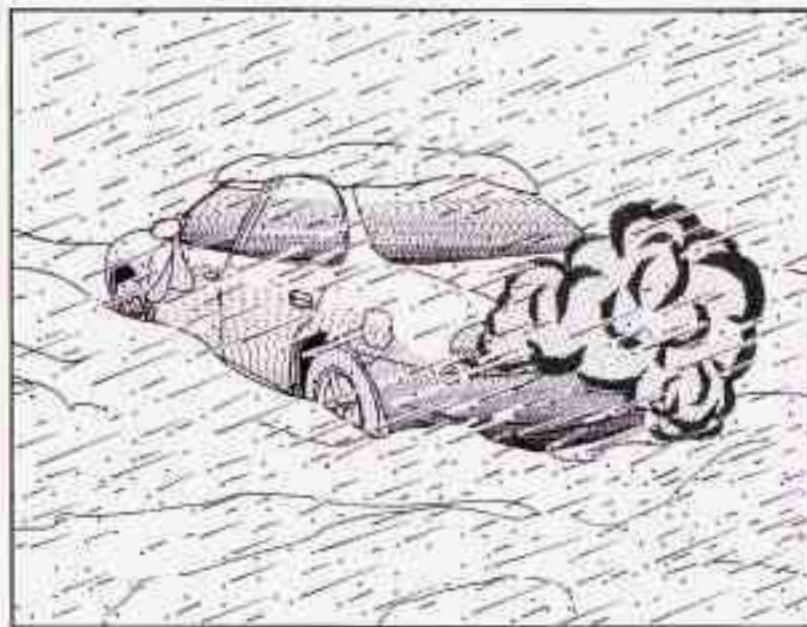

You can run the engine to keep warm, but be careful.

 **CAUTION:**

Snow can trap exhaust gases under your vehicle. This can cause deadly CO (carbon monoxide) gas to get inside. CO could overcome you and kill you. You can't see it or smell it, so you might not know it is in your vehicle. Clear away snow from around the base of your vehicle, especially any that is blocking your exhaust pipe. And check around again from time to time to be sure snow doesn't collect there.

Open a window just a little on the side of the vehicle that's away from the wind. This will help keep CO out.

Run your engine only as long as you must. This saves fuel. When you run the engine, make it go a little faster than just idle. That is, push the accelerator slightly. This uses less fuel for the heat that you get and it keeps the battery charged. You will need a well-charged battery to restart the vehicle, and possibly for signaling later on with your headlamps. Let the heater run for a while.

Then, shut the engine off and close the window almost all the way to preserve the heat. Start the engine again and repeat this only when you feel really uncomfortable from the cold. But do it as little as possible. Preserve the fuel as long as you can. To help keep warm, you can get out of the vehicle and do some fairly vigorous exercises every half hour or so until help comes.

## If You Are Stuck: In Sand, Mud, Ice or Snow

In order to free your vehicle when it is stuck, you will need to spin the wheels, but you don't want to spin your wheels too fast. The method known as "rocking" can help you get out when you're stuck, but you must use caution.

### CAUTION:

**If you let your tires spin at high speed, they can explode, and you or others could be injured. And, the transaxle or other parts of the vehicle can overheat. That could cause an engine compartment fire or other damage. When you're stuck, spin the wheels as little as possible. Don't spin the wheels above 35 mph (55 km/h) as shown on the speedometer.**

**Notice:** Spinning your wheels can destroy parts of your vehicle as well as the tires. If you spin the wheels too fast while shifting your transaxle back and forth, you can destroy your transaxle. See "Rocking Your Vehicle To Get It Out."

For information about using tire chains on your vehicle, see *Tire Chains* on page 5-75.

## Rocking Your Vehicle To Get It Out

First, turn your steering wheel left and right. That will clear the area around your front wheels. If your vehicle has traction control, you should turn the system off. See *Traction Control System (TCS)* on page 4-10. Then shift back and forth between REVERSE (R) and a forward gear, spinning the wheels as little as possible. Release the accelerator pedal while you shift, and press lightly on the accelerator pedal when the transaxle is in gear. By slowly spinning your wheels in the forward and reverse directions, you will cause a rocking motion that may free your vehicle. If that doesn't get you out after a few tries, you may need to be towed out. If you do need to be towed out, see "Towing Your Vehicle" following.

# Towing

## Towing Your Vehicle

Consult your dealer or a professional towing service if you need to have your disabled vehicle towed. See *Roadside Assistance Program on page 7-5*.

If you want to tow your vehicle behind another vehicle for recreational purposes (such as behind a motorhome), see "Recreational Vehicle Towing" following.

## Recreational Vehicle Towing

Recreational vehicle towing means towing your vehicle behind another vehicle – such as behind a motorhome. The two most common types of recreational vehicle towing are known as "dinghy towing" (towing your vehicle with all four wheels on the ground) and "dolly towing" (towing your vehicle with two wheels on the ground and two wheels up on a device known as a "dolly").

With the proper preparation and equipment, many vehicles can be towed in these ways. See "Dinghy Towing" and "Dolly Towing," following.

Here are some important things to consider before you do recreational vehicle towing.

- What's the towing capacity of the towing vehicle? Be sure you read the tow vehicle manufacturer's recommendations.
- How far will you tow? Some vehicles have restrictions on how far and how long they can tow.
- Do you have the proper towing equipment? See your dealer or trailering professional for additional advice and equipment recommendations.
- Is your vehicle ready to be towed? Just as you would prepare your vehicle for a long trip, you'll want to make sure your vehicle is prepared to be towed. See *Before Leaving on a Long Trip on page 4-24*.

## Dinghy Towing

**Notice:** Towing your vehicle with all four wheels on the ground will damage drivetrain components.

Your vehicle was not designed to be towed with all four wheels on the ground. If your vehicle must be towed, you should use a dolly. See "Dolly Towing" following for more information.

## Dolly Towing

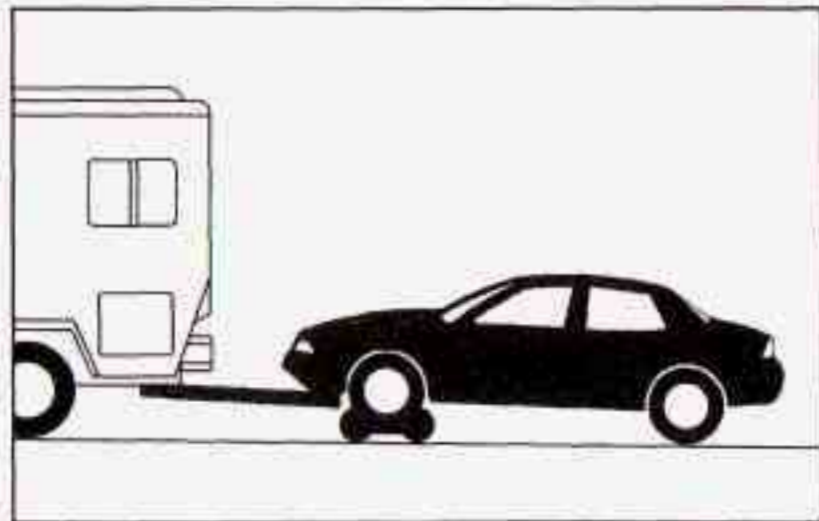

Your vehicle can be towed using a dolly. To tow your vehicle using a dolly, follow these steps:

1. Put the front wheels on the dolly.
2. Put the vehicle in PARK (P).
3. Set the parking brake and then remove the key.
4. Clamp the steering wheel in a straight-ahead position.
5. Release the parking brake.

## Loading Your Vehicle



**TIRE-LOADING INFORMATION**

**OCCUPANTS**

FRT.	CTR.	RR.	TOTAL
<input type="checkbox"/>	<input type="checkbox"/>	<input type="checkbox"/>	<input type="checkbox"/>

**VEHICLE CAP.**

KG	LB
<input type="checkbox"/>	<input type="checkbox"/>

MAX. LOADING @ GVWR SAME AS WEIGHT CAPACITY WEIGHT  
200

MODEL:

**TIRE SIZE**  **RECOMMENDED TIRE PRESSURE**

FRT.	RR.
<input type="checkbox"/>	<input type="checkbox"/>

TIRES ARE HOT, ADD 29KPA(4PSI)  
SEE OWNER'S MANUAL FOR MORE INFORMATION

Two labels on your vehicle show how much weight it may properly carry. The Tire-Loading Information label is on the inside of the trunk lid. The label tells you the proper size, speed rating and recommended inflation pressures for the tires on your vehicle. It also give you important information about the number of people that can be in your vehicle and the total weight you can carry. This weight is called the vehicle capacity weight and includes the weigh of all occupants, cargo and all non-factory installed options.



**MFD BY GENERAL MOTORS CORP.**

**DATE**  **GVWR**  **GAWR FRT**  **GAWR RR**

THIS VEHICLE CONFORMS TO ALL APPLICABLE U.S. FEDERAL MOTOR VEHICLE SAFETY, BUMPER AND TRAFFIC PREVENTION STANDARDS IN EFFECT ON THE DATE OF MANUFACTURE SHOWN ABOVE.

200  **PASS CAR**

The other label is the Certification label, found on the rear edge of the driver's door. It tells you the gross weight capacity of your vehicle, called the Gross Vehicle Weight Rating (GVWR). The GVWR includes the weight of the vehicle, all occupants, fuel and cargo. Never exceed the GVWR for your vehicle or the Gross Axle Weight Rating (GAWR) for either the front or rear axle.



If you do have a heavy load, spread it out. Don't carry more than 167 pounds (75 kg) in your trunk.

### CAUTION:

Do not load your vehicle any heavier than the GVWR, or either the maximum front or rear GAWR. If you do, parts on your vehicle can break, and it can change the way your vehicle handles. These could cause you to lose control and crash. Also, overloading can shorten the life of your vehicle.

**Notice:** Your warranty does not cover parts or components that fail because of overloading.

If you put things inside your vehicle — like suitcases, tools, packages or anything else — they will go as fast as the vehicle goes. If you have to stop or turn quickly, or if there is a crash, they'll keep going.

### CAUTION:

Things you put inside your vehicle can strike and injure people in a sudden stop or turn, or in a crash.

- Put things in the trunk of your vehicle. In a trunk, put them as far forward as you can. Try to spread the weight evenly.
- Never stack heavier things, like suitcases, inside the vehicle so that some of them are above the tops of the seats.
- Don't leave an unsecured child restraint in your vehicle.
- When you carry something inside the vehicle, secure it whenever you can.
- Don't leave a seat folded down unless you need to.

## Towing a Trailer

### CAUTION:

If you don't use the correct equipment and drive properly, you can lose control when you pull a trailer. For example, if the trailer is too heavy, the brakes may not work well – or even at all. You and your passengers could be seriously injured. You may also damage your vehicle; the resulting repairs would not be covered by your warranty. Pull a trailer only if you have followed all the steps in this section. Ask your dealer for advice and information about towing a trailer with your vehicle.

Your vehicle can tow a trailer if it is equipped with the proper trailer towing equipment. To identify what the vehicle trailering capacity is for your vehicle, you should read the information in "Weight of the Trailer" that appears later in this section. But trailering is different than just driving your vehicle by itself. Trailering means changes in handling, durability and fuel economy. Successful, safe trailering takes correct equipment, and it has to be used properly.

That's the reason for this part. In it are many time-tested, important trailering tips and safety rules. Many of these are important for your safety and that of your passengers. So please read this section carefully before you pull a trailer.

Load-pulling components such as the engine, transaxle, wheel assemblies and tires are forced to work harder against the drag of the added weight. The engine is required to operate at relatively higher speeds and under greater loads, generating extra heat. What's more, the trailer adds considerably to wind resistance, increasing the pulling requirements.

## If You Do Decide To Pull A Trailer

If you do, here are some important points:

- There are many different laws, including speed limit restrictions, having to do with trailering. Make sure your rig will be legal, not only where you live but also where you'll be driving. A good source for this information can be state or provincial police.
- Consider using a sway control. You can ask a hitch dealer about sway controls.
- Don't tow a trailer at all during the first 1,000 miles (1 600 km) your new vehicle is driven. Your engine, axle or other parts could be damaged.
- Then, during the first 500 miles (800 km) that you tow a trailer, don't drive over 50 mph (80 km/h) and don't make starts at full throttle. This helps your engine and other parts of your vehicle wear in at the heavier loads.
- Obey speed limit restrictions when towing a trailer. Don't drive faster than the maximum posted speed for trailers, or no more than 55 mph (90 km/h), to save wear on your vehicle's parts.

Three important considerations have to do with weight:

- the weight of the trailer,
- the weight of the trailer tongue
- and the total weight on your vehicle's tires.

## Weight of the Trailer

How heavy can a trailer safely be?

It should never weigh more than 1000 lbs (454 kg). But even that can be too heavy.

It depends on how you plan to use your rig. For example, speed, altitude, road grades, outside temperature and how much your vehicle is used to pull a trailer are all important. And, it can also depend on any special equipment that you have on your vehicle.

You can ask your dealer for our trailering information or advice, or you can write us at:

Pontiac-GMC Customer Assistance Center  
P.O. Box 33172  
Detroit, MI 48232-5172

In Canada, write to:

General Motors of Canada Limited  
Customer Communication Centre, 163-005  
1908 Colonel Sam Drive  
Oshawa, Ontario L1H 8P7

## Weight of the Trailer Tongue

The tongue load (A) of any trailer is an important weight to measure because it affects the total or gross weight of your vehicle. The Gross Vehicle Weight (GVW) includes the curb weight of the vehicle, any cargo you may carry in it, and the people who will be riding in the vehicle. And if you tow a trailer, you must add the tongue load to the GVW because your vehicle will be carrying that weight, too. See *Loading Your Vehicle* on page 4-35 for more information about your vehicle's maximum load capacity.

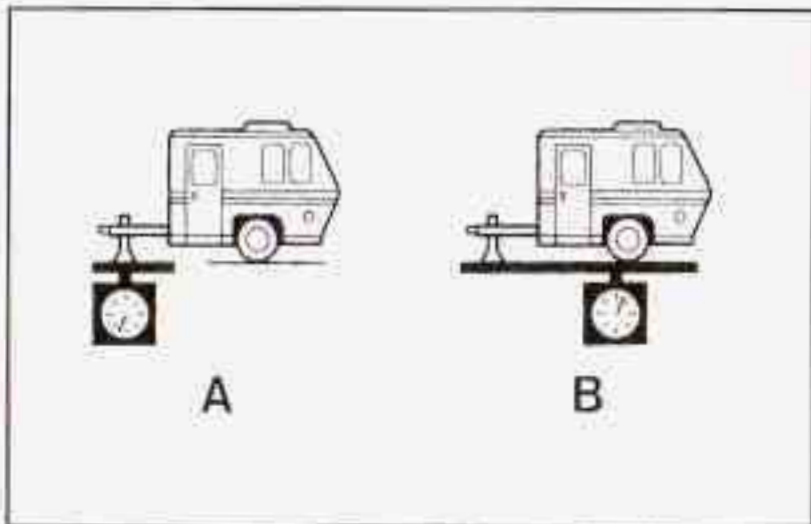

If you're using a weight-carrying hitch or a weight-distributing hitch, the trailer tongue (A) should weigh 10–15 percent of the total loaded trailer weight (B).

After you've loaded your trailer, weigh the trailer and then the tongue, separately, to see if the weights are proper. If they aren't, you may be able to get them right simply by moving some items around in the trailer.

## Total Weight on Your Vehicle's Tires

Be sure your vehicle's tires are inflated to the upper limit for cold tires. You'll find these numbers on the Tire Loading Information label, found on the inside of the trunk lid, or see *Loading Your Vehicle* on page 4-35. Then be sure you don't go over the GVW limit for your vehicle, including the weight of the trailer tongue.

## Hitches

It's important to have the correct hitch equipment. Crosswinds, large trucks going by and rough roads are a few reasons why you'll need the right hitch. Here are some rules to follow:

- The rear bumper on your vehicle is not intended for hitches. Do not attach rental hitches or other bumper-type hitches to it. Use only a frame-mounted hitch that does not attach to the bumper.
- Will you have to make any holes in the body of your vehicle when you install a trailer hitch? If you do, then be sure to seal the holes later when you remove the hitch. If you don't seal them, deadly carbon monoxide (CO) from your exhaust can get into your vehicle. See *Engine Exhaust on page 2-31*. Dirt and water can, too.

## Safety Chains

You should always attach chains between your vehicle and your trailer. Cross the safety chains under the tongue of the trailer so that the tongue will not drop to the road if it becomes separated from the hitch. Instructions about safety chains may be provided by the hitch manufacturer or by the trailer manufacturer. Follow the manufacturer's recommendation for attaching safety chains and do not attach them to the bumper. Always leave just enough slack so you can turn with your rig. And, never allow safety chains to drag on the ground.

## Trailer Brakes

Because you have anti-lock brakes, do not try to tap into your vehicle's brake system. If you do, both brake systems won't work well, or at all.

## Driving with a Trailer

Towing a trailer requires a certain amount of experience. Before setting out for the open road, you'll want to get to know your rig. Acquaint yourself with the feel of handling and braking with the added weight of the trailer. And always keep in mind that the vehicle you are driving is now a good deal longer and not nearly as responsive as your vehicle is by itself.

Before you start, check the trailer hitch and platform (and attachments), safety chains, electrical connector, lamps, tires and mirror adjustment. If the trailer has electric brakes, start your vehicle and trailer moving and then apply the trailer brake controller by hand to be sure the brakes are working. This lets you check your electrical connection at the same time.

During your trip, check occasionally to be sure that the load is secure, and that the lamps and any trailer brakes are still working.

## Following Distance

Stay at least twice as far behind the vehicle ahead as you would when driving your vehicle without a trailer. This can help you avoid situations that require heavy braking and sudden turns.

## Passing

You'll need more passing distance up ahead when you're towing a trailer. And, because you're a good deal longer, you'll need to go much farther beyond the passed vehicle before you can return to your lane.

## Backing Up

Hold the bottom of the steering wheel with one hand. Then, to move the trailer to the left, just move that hand to the left. To move the trailer to the right, move your hand to the right. Always back up slowly and, if possible, have someone guide you.

## Making Turns

***Notice:*** Making very sharp turns while trailering could cause the trailer to come in contact with the vehicle. Your vehicle could be damaged. Avoid making very sharp turns while trailering.

When you're turning with a trailer, make wider turns than normal. Do this so your trailer won't strike soft shoulders, curbs, road signs, trees or other objects. Avoid jerky or sudden maneuvers. Signal well in advance.

## Turn Signals When Towing a Trailer

When you tow a trailer, your vehicle may need a different turn signal flasher and/or extra wiring. Check with your dealer. The arrows on your instrument panel will flash whenever you signal a turn or lane change. Properly hooked up, the trailer lamps will also flash, telling other drivers you're about to turn, change lanes or stop.

When towing a trailer, the arrows on your instrument panel will flash for turns even if the bulbs on the trailer are burned out. Thus, you may think drivers behind you are seeing your signal when they are not. It's important to check occasionally to be sure the trailer bulbs are still working.

Your vehicle has bulb warning lights. When you plug a trailer lighting system into your vehicle's lighting system, its bulb warning lights may not let you know if one of your lamps goes out. So, when you have a trailer lighting system plugged in, be sure to check your vehicle and trailer lamps from time to time to be sure they're all working. Once you disconnect the trailer lamps, the bulb warning lights again can tell you if one of your vehicle lamps is out.

## Driving On Grades

Reduce speed and shift to a lower gear before you start down a long or steep downgrade. If you don't shift down, you might have to use your brakes so much that they would get hot and no longer work well.

On a long uphill grade, shift down and reduce your speed to around 45 mph (70 km/h) to reduce the possibility of engine and transaxle overheating.

If you have overdrive, you may have to drive in THIRD (3) instead of AUTOMATIC OVERDRIVE (D).

## Parking on Hills

### CAUTION:

**You really should not park your vehicle, with a trailer attached, on a hill. If something goes wrong, your rig could start to move. People can be injured, and both your vehicle and the trailer can be damaged.**

But if you ever have to park your rig on a hill, here's how to do it:

1. Apply your regular brakes, but don't shift into PARK (P) yet.
2. Have someone place chocks under the trailer wheels.
3. When the wheel chocks are in place, release the regular brakes until the chocks absorb the load.
4. Reapply the regular brakes. Then apply your parking brake, and then shift to PARK (P).
5. Release the regular brakes.

## When You Are Ready to Leave After Parking on a Hill

1. Apply your regular brakes and hold the pedal down while you:
  - start your engine,
  - shift into a gear, and
  - release the parking brake.

2. Let up on the brake pedal.
3. Drive slowly until the trailer is clear of the chocks.
4. Stop and have someone pick up and store the chocks.

## Maintenance When Trailer Towing

Your vehicle will need service more often when you're pulling a trailer. See *Part A: Scheduled Maintenance Services on page 6-4* for more information. Things that are especially important in trailer operation are automatic transaxle fluid (don't overfill), engine oil, drive belts, cooling system and brake system. Each of these is covered in this manual, and the Index will help you find them quickly. If you're trailering, it's a good idea to review this information before you start your trip.

Check periodically to see that all hitch nuts and bolts are tight.

## Engine Cooling When Trailer Towing

Your cooling system may temporarily overheat during severe operating conditions. See *Engine Overheating on page 5-33*.





## Section 5 Service and Appearance Care

---

<b>Service</b> .....	5-3	<b>Brakes</b> .....	5-49
Doing Your Own Service Work .....	5-4	<b>Battery</b> .....	5-52
Adding Equipment to the Outside of Your Vehicle .....	5-4	<b>Jump Starting</b> .....	5-53
<b>Fuel</b> .....	5-5	<b>Headlamp Aiming</b> .....	5-59
Gasoline Octane .....	5-5	<b>Bulb Replacement</b> .....	5-60
Gasoline Specifications .....	5-5	Halogen Bulbs .....	5-60
California Fuel .....	5-6	Headlamps .....	5-60
Additives .....	5-6	Front Turn Signal and Sidemarker Lamps .....	5-62
Fuels in Foreign Countries .....	5-7	Center High-Mounted Stoplamp (CHMSL) .....	5-63
Filling Your Tank .....	5-7	Taillamps, Sidemarker and Back-Up Lamps .....	5-64
Filling a Portable Fuel Container .....	5-9	Replacement Bulbs .....	5-66
<b>Checking Things Under the Hood</b> .....	5-10	<b>Windshield Wiper Blade Replacement</b> .....	5-67
Hood Release .....	5-10	<b>Tires</b> .....	5-68
Engine Compartment Overview .....	5-12	Inflation -- Tire Pressure .....	5-68
Engine Oil .....	5-18	Tire Inspection and Rotation .....	5-69
Supercharger Oil .....	5-24	When It Is Time for New Tires .....	5-70
Engine Air Cleaner/Filter .....	5-25	Buying New Tires .....	5-71
Automatic Transaxle Fluid .....	5-27	Uniform Tire Quality Grading .....	5-72
Engine Coolant .....	5-30	Wheel Alignment and Tire Balance .....	5-73
Radiator Pressure Cap .....	5-33	Wheel Replacement .....	5-73
Engine Overheating .....	5-33	Tire Chains .....	5-75
Cooling System .....	5-36	If a Tire Goes Flat .....	5-76
Power Steering Fluid .....	5-46	Changing a Flat Tire .....	5-76
Windshield Washer Fluid .....	5-48	Compact Spare Tire .....	5-87

## Section 5 Service and Appearance Care

---

<b>Appearance Care</b> .....	5-88	<b>Electrical System</b> .....	5-97
Cleaning the Inside of Your Vehicle .....	5-88	Add-On Electrical Equipment .....	5-97
Care of Safety Belts .....	5-91	Headlamp Wiring .....	5-97
Weatherstrips .....	5-91	Windshield Wiper Fuses .....	5-97
Cleaning the Outside of Your Vehicle .....	5-91	Power Windows and Other Power Options .....	5-97
Sheet Metal Damage .....	5-93	Fuses and Circuit Breakers .....	5-97
Finish Damage .....	5-93	<b>Capacities and Specifications</b> .....	5-102
Underbody Maintenance .....	5-93	Capacities and Specifications .....	5-102
Chemical Paint Spotting .....	5-94	<b>Normal Maintenance Replacement Parts</b> .....	5-104
GM Vehicle Care/Appearance Materials .....	5-94	Normal Maintenance Replacement Parts .....	5-104
<b>Vehicle Identification</b> .....	5-96		
Vehicle Identification Number (VIN) .....	5-96		
Service Parts Identification Label .....	5-96		

## Service

Your dealer knows your vehicle best and wants you to be happy with it. We hope you'll go to your dealer for all your service needs. You'll get genuine GM parts and GM-trained and supported service people.

We hope you'll want to keep your GM vehicle all GM. Genuine GM parts have one of these marks:

***ACDelco***

---

**GENUINE**  
**GM Parts**

---

**GM**  
**Goodwrench**

## Doing Your Own Service Work

If you want to do some of your own service work, you'll want to use the proper service manual. It tells you much more about how to service your vehicle than this manual can. To order the proper service manual, see *Service Publications Ordering Information on page 7-10*.

Your vehicle has an air bag system. Before attempting to do your own service work, see *Servicing Your Air Bag-Equipped Vehicle on page 1-57*.

You should keep a record with all parts receipts and list the mileage and the date of any service work you perform. See *Part E: Maintenance Record on page 6-16*.

### CAUTION:

**You can be injured and your vehicle could be damaged if you try to do service work on a vehicle without knowing enough about it.**

- **Be sure you have sufficient knowledge, experience, the proper replacement parts and tools before you attempt any vehicle maintenance task.**
- **Be sure to use the proper nuts, bolts and other fasteners. "English" and "metric" fasteners can be easily confused. If you use the wrong fasteners, parts can later break or fall off. You could be hurt.**

## Adding Equipment to the Outside of Your Vehicle

Things you might add to the outside of your vehicle can affect the airflow around it. This may cause wind noise and affect windshield washer performance. Check with your dealer before adding equipment to the outside of your vehicle.

## Fuel

The 8th digit of your vehicle identification number (VIN) shows the code letter or number that identifies your engine. You will find the VIN at the top left of the instrument panel. See *Vehicle Identification Number (VIN)* on page 5-96.

## Gasoline Octane

If your vehicle has the 3100 V6 engine (VIN Code J) or 3800 V6 engine (VIN Code K), use regular unleaded gasoline with a posted octane of 87 or higher. If the octane is less than 87, you may get a heavy knocking noise when you drive. If it is bad enough, it can damage your engine. A little pinging noise when you accelerate or drive uphill is considered normal. This does not indicate a problem exists or that a higher-octane fuel is necessary.

If your vehicle has the 3800 Supercharged V6 engine (VIN Code 1), use only premium unleaded gasoline with a posted octane of 91 or higher. In an emergency, you may be able to use a lower octane – as low as 87 – if heavy knocking does not occur. Refill your tank with premium fuel as soon as possible. If you are using 91 octane or higher-octane fuel and you hear knocking, your engine needs service.

## Gasoline Specifications

It is recommended that gasoline meet specifications which were developed by the American Automobile Manufacturers Association and endorsed by the Canadian Vehicle Manufacturers Association for better vehicle performance and engine protection. Gasoline meeting these specifications could provide improved driveability and emission control system performance compared to other gasoline.



**Canada Only**

In Canada, look for the "Auto Makers' Choice" label on the pump.

## California Fuel

If your vehicle is certified to meet California Emission Standards (see the underhood emission control label), it is designed to operate on fuels that meet California specifications. If this fuel is not available in states adopting California emissions standards, your vehicle will operate satisfactorily on fuels meeting federal specifications, but emission control system performance may be affected. The malfunction indicator lamp may turn on (see *Malfunction Indicator Lamp on page 3-32*) and your vehicle may fail a smog-check test. If this occurs, return to your authorized GM dealer for diagnosis. If it is determined that the condition is caused by the type of fuel used, repairs may not be covered by your warranty.

## Additives

To provide cleaner air, all gasolines in the United States are now required to contain additives that will help prevent engine and fuel system deposits from forming, allowing your emission control system to work properly. You should not have to add anything to your fuel. Gasolines containing oxygenates, such as ethers and ethanol, and reformulated gasolines may be available in your area to contribute to clean air. General Motors recommends that you use these gasolines, particularly if they comply with the specifications described earlier.

**Notice:** Your vehicle was not designed for fuel that contains methanol. Don't use fuel containing methanol. It can corrode metal parts in your fuel system and also damage the plastic and rubber parts. That damage wouldn't be covered under your warranty.

Some gasolines that are not reformulated for low emissions may contain an octane-enhancing additive called methylcyclopentadienyl manganese tricarbonyl (MMT); ask the attendant where you buy gasoline whether the fuel contains MMT. General Motors does not recommend the use of such gasolines. Fuels containing MMT can reduce the life of spark plugs and the performance of the emission control system may be affected. The malfunction indicator lamp may turn on. If this occurs, return to your authorized GM dealer for service.

## Fuels in Foreign Countries

If you plan on driving in another country outside the United States or Canada, the proper fuel may be hard to find. Never use leaded gasoline or any other fuel not recommended in the previous text on fuel. Costly repairs caused by use of improper fuel wouldn't be covered by your warranty.

To check the fuel availability, ask an auto club, or contact a major oil company that does business in the country where you'll be driving.

## Filling Your Tank

### CAUTION:

**Fuel vapor is highly flammable. It burns violently, and that can cause very bad injuries. Don't smoke if you're near fuel or refueling your vehicle. Keep sparks, flames and smoking materials away from fuel.**

Turn the vehicle off before refueling.



The fuel cap is located behind a hinged door on the driver's side of your vehicle.



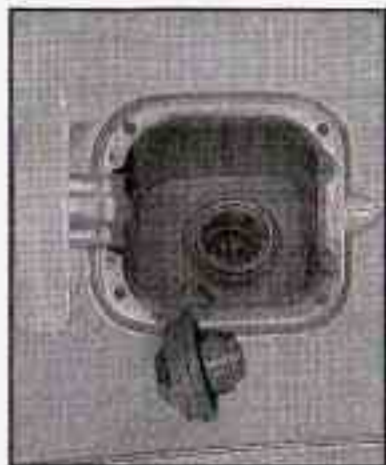

While refueling, let the fuel cap hang by the tether below the fuel fill opening.

To remove the fuel cap, turn it slowly to the left (counterclockwise). The fuel cap has a spring in it; if you let go of the cap too soon, it will spring back to the right.

**⚠ CAUTION:**

If you get fuel on yourself and then something ignites it, you could be badly burned. Fuel can spray out on you if you open the fuel cap too quickly. This spray can happen if your tank is nearly full, and is more likely in hot weather. Open the fuel cap slowly and wait for any “hiss” noise to stop. Then unscrew the cap all the way.

Be careful not to spill fuel. Clean fuel from painted surfaces as soon as possible. See *Cleaning the Outside of Your Vehicle* on page 5-91. When filling the tank do not overfill by squeezing in much more fuel after the pump shuts off.

When you put the fuel cap back on, turn it to the right (clockwise) until you hear a clicking sound. Make sure you fully install the cap. The diagnostic system can determine if the fuel cap has been left off or improperly installed. This would allow fuel to evaporate into the atmosphere. See *Malfunction Indicator Lamp* on page 3-32.

**Notice:** If you need a new fuel cap, be sure to get the right type. Your dealer can get one for you. If you get the wrong type, it may not fit properly. This may cause your malfunction indicator lamp to light and may damage your fuel tank and emissions system. See "Malfunction Indicator Lamp" in the Index.

## Filling a Portable Fuel Container

### CAUTION:

Never fill a portable fuel container while it is in your vehicle. Static electricity discharge from the container can ignite the gasoline vapor. You can be badly burned and your vehicle damaged if this occurs. To help avoid injury to you and others:

- Dispense gasoline only into approved containers.
- Do not fill a container while it is inside a vehicle, in a vehicle's trunk, pickup bed or on any surface other than the ground.
- Bring the fill nozzle in contact with the inside of the fill opening before operating the nozzle. Contact should be maintained until the filling is complete.
- Don't smoke while pumping gasoline.

## Checking Things Under the Hood

### CAUTION:

An electric fan under the hood can start up and injure you even when the engine is not running. Keep hands, clothing and tools away from any underhood electric fan.

### CAUTION:

Things that burn can get on hot engine parts and start a fire. These include liquids like fuel, oil, coolant, brake fluid, windshield washer and other fluids, and plastic or rubber. You or others could be burned. Be careful not to drop or spill things that will burn onto a hot engine.

## Hood Release

To open the hood do the following:

1. Pull the handle located inside the vehicle near the parking brake.



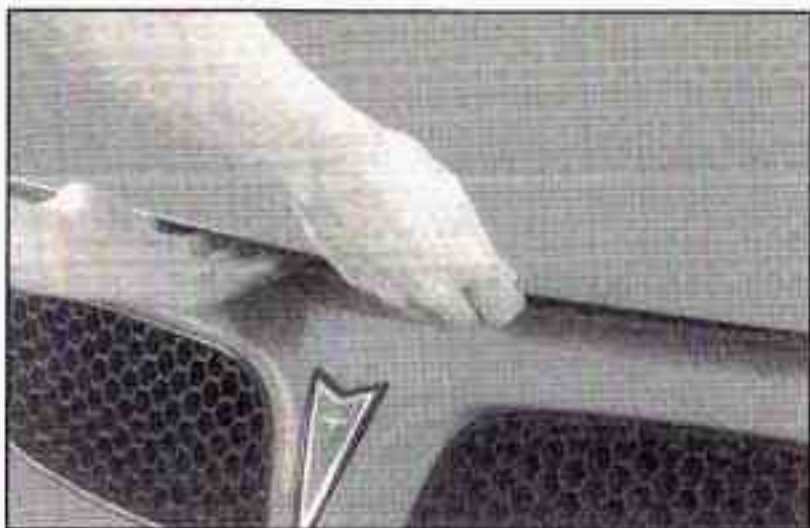

2. Next, go to the front of the vehicle and release the secondary hood latch.

3. Lift the hood.

Before closing the hood of your vehicle, be sure all the filler caps are on properly. Then pull the hood down and close it firmly.

## Engine Compartment Overview

When you open the hood of a vehicle with a 3100 V6 (Code J) engine, you'll see:

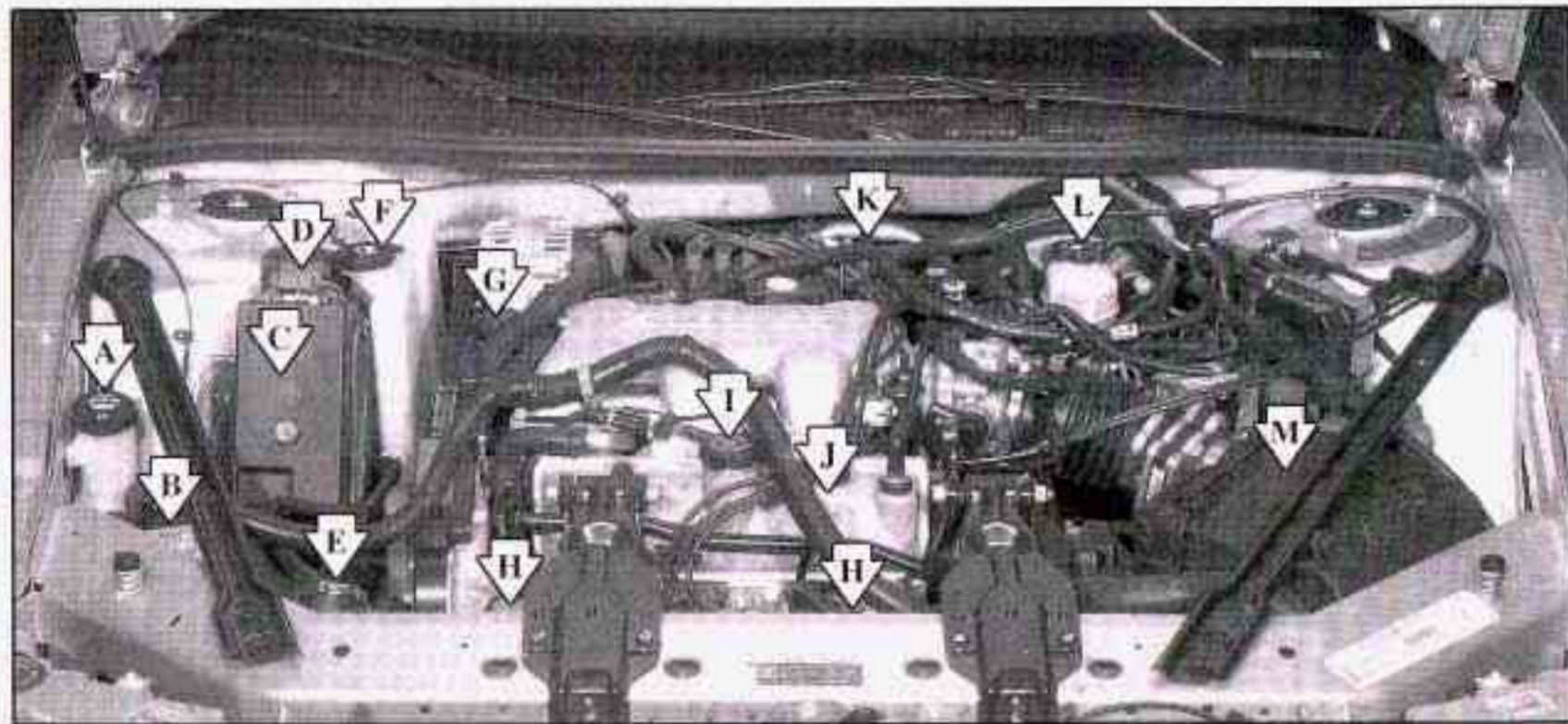

- A. Windshield Washer Fluid Reservoir
- B. Battery
- C. Underhood Fuse Block
- D. Remote Positive (+) Battery Terminal
- E. Radiator Pressure Cap
- F. Engine Coolant Recovery Tank
- G. Power Steering Fluid Reservoir  
(low in engine compartment, below generator)
- H. Electric Engine Cooling Fan
- I. Engine Oil Fill Cap
- J. Engine Oil Dipstick
- K. Automatic Transaxle Fluid Dipstick
- L. Brake Fluid Reservoir
- M. Engine Air Cleaner/Filter

When you open the hood of a vehicle with a the 3800 V6 (Code K) engine, you'll see:

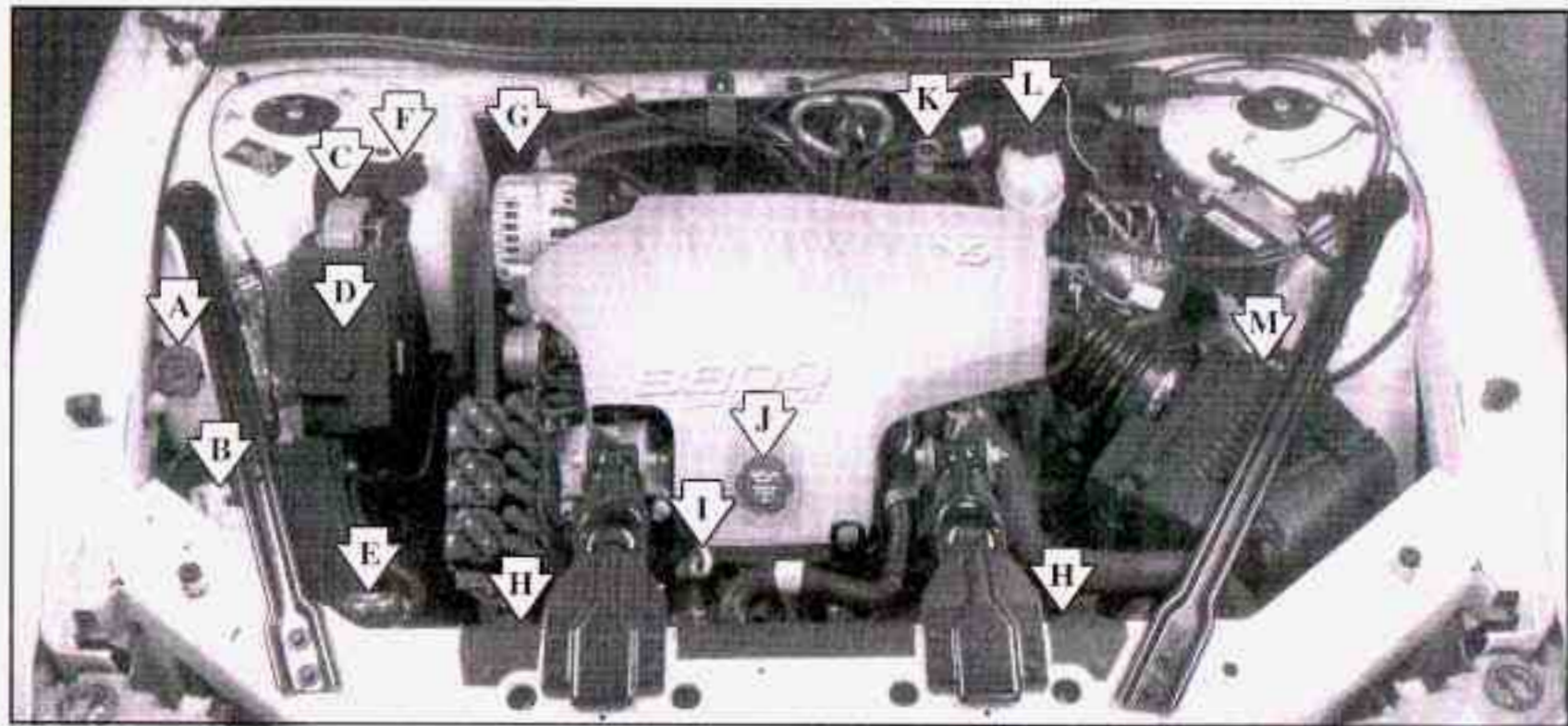

- A. Windshield Washer Fluid
- B. Battery
- C. Remote Positive (+) Battery Terminal
- D. Underhood Fuse Block
- E. Radiator Fill Cap
- F. Engine Coolant Recovery Tank
- G. Power Steering Fluid Reservoir  
(low in engine compartment, below generator)
- H. Electric Engine Cooling Fan
- I. Engine Oil Dipstick
- J. Engine Oil Fill Cap
- K. Automatic Transaxle Fluid Dipstick
- L. Brake Fluid Reservoir
- M. Engine Air Cleaner/Filter



When you open the hood of a vehicle with a 3800 V6 Supercharged (Code 1) engine, you'll see:

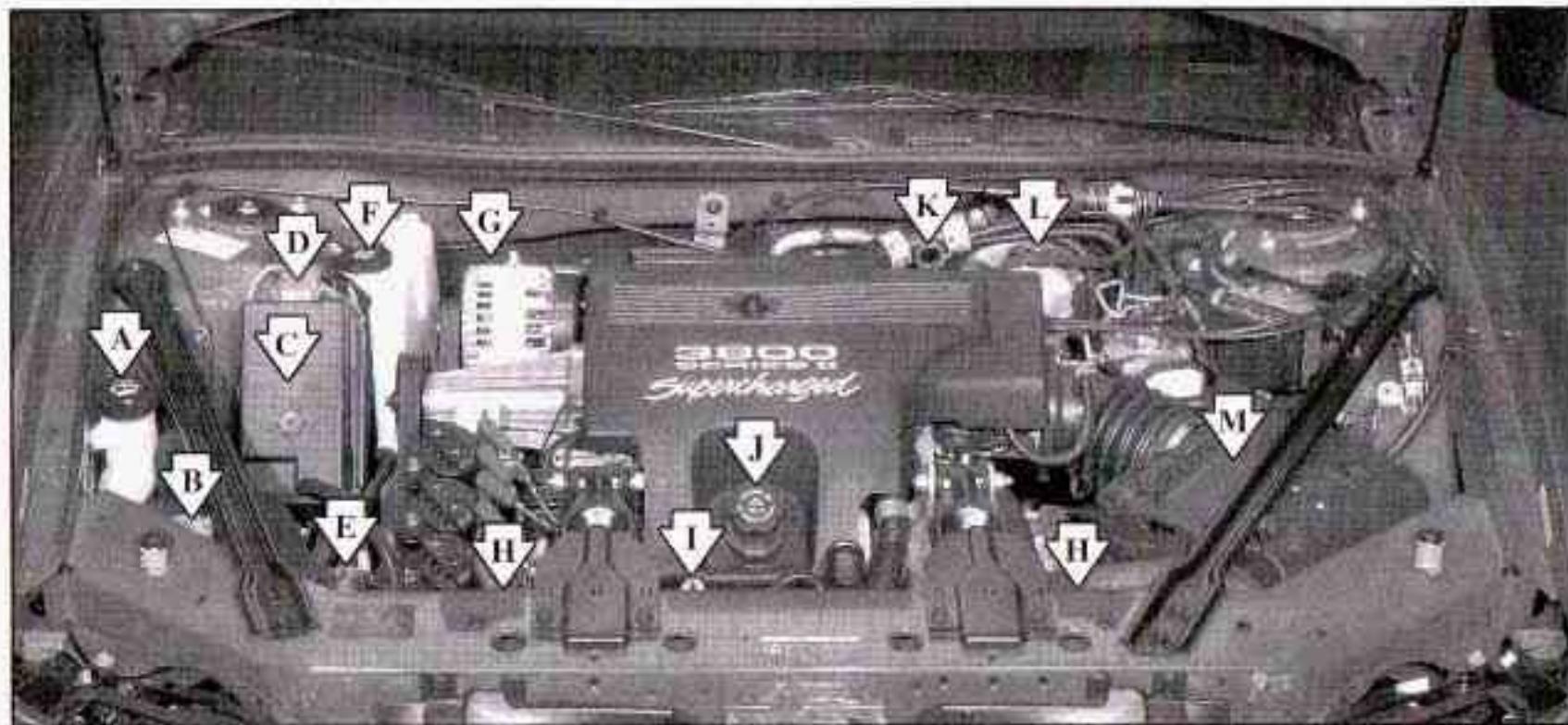

- A. Windshield Washer Fluid Reservoir
- B. Battery
- C. Underhood Fuse Block
- D. Remote Positive (+) Battery Terminal
- E. Radiator Pressure Cap
- F. Engine Coolant Recovery Tank
- G. Power Steering Fluid Reservoir  
(low in engine compartment, below generator)
- H. Electric Cooling Fan

- I. Engine Oil Dipstick
- J. Engine Oil Fill Cap
- K. Transaxle Fluid Dipstick
- L. Brake Master Cylinder Reservoir
- M. Engine Air Cleaner/Filter

Before closing the hood of your vehicle, be sure all the filler caps are on properly. Then pull the hood down and close it firmly.

## Engine Oil

**LOW OIL  
LEVEL**

If the **LOW OIL LEVEL** light appears on the instrument cluster, it means you need to check your engine oil level right away.

For more information, see *Low Oil Level Light* on page 3-36.

You should check your engine oil level regularly; this is an added reminder.

## Checking Engine Oil

It's a good idea to check your engine oil every time you get fuel. In order to get an accurate reading, the oil must be warm and the vehicle must be on level ground.



**3100 V6 Engine**



**3800 V6 or 3800 V6  
Supercharged Engine**

The engine oil dipstick handle is the yellow loop located near the front of the engine. See *Engine Compartment Overview* on page 5-12 for more information on location.

Turn off the engine and give the oil several minutes to drain back into the oil pan. If you don't, the oil dipstick might not show the actual level.

Pull out the dipstick and clean it with a paper towel or cloth, then push it back in all the way. Remove it again, keeping the tip down, and check the level.



**3100 V6 Engine**

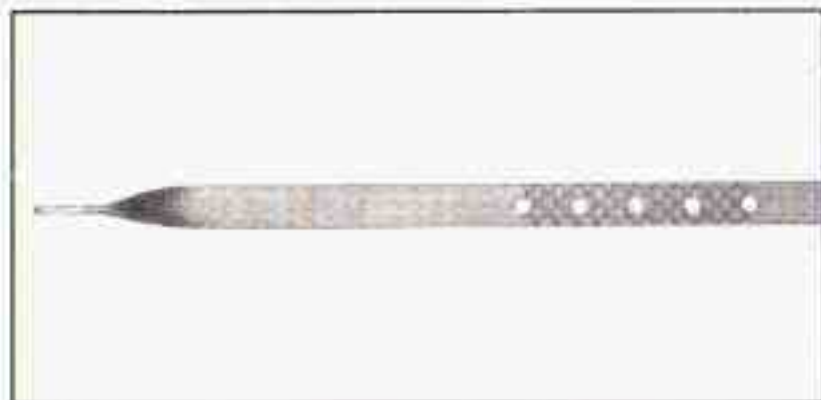

**3800 V6 or 3800 V6 Supercharged Engine**

## When to Add Engine Oil

If the oil is at or below the bottom hatchmark, then you'll need to add at least one quart of oil. But you must use the right kind. This part explains what kind of oil to use. For engine oil crankcase capacity, see *Capacities and Specifications* on page 5-102.

**Notice:** Don't add too much oil. If your engine has so much oil that the oil level gets above the cross-hatched area that shows the proper operating range, your engine could be damaged.



3100 V6 Engine



3800 V6 or 3800 V6  
Supercharged Engine

The engine oil fill cap will have one of these symbols on it, depending on the engine. It is located on the front of the engine, near the center of the engine compartment and the yellow-looped engine oil dipstick. See *Engine Compartment Overview on page 5-12* for more information on location.

Be sure to fill it enough to put the level somewhere in the proper operating range in the cross-hatched area. Push the dipstick all the way back in when you're through.

## What Kind of Engine Oil to Use

Oils recommended for your vehicle can be identified by looking for the starburst symbol.

This symbol indicates that the oil has been certified by the American Petroleum Institute (API). Do not use any oil which does not carry this starburst symbol.



If you choose to perform the engine oil change service yourself, be sure the oil you use has the starburst symbol on the front of the oil container. If you have your oil changed for you, be sure the oil put into your engine is American Petroleum Institute certified for gasoline engines.

You should also use the proper viscosity oil for your vehicle, as shown in the viscosity chart.

## RECOMMENDED SAE VISCOSITY GRADE ENGINE OILS

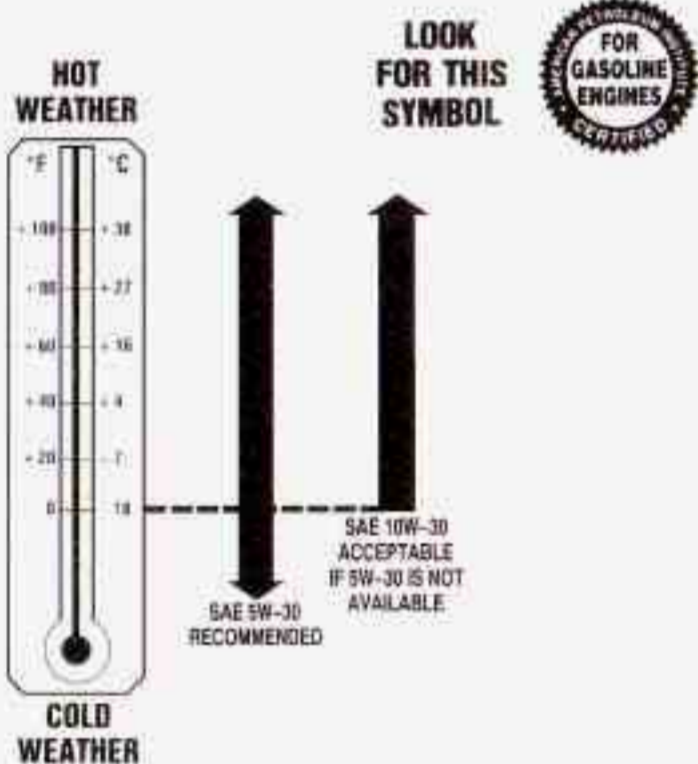

DO NOT USE SAE 10W-40, SAE 20W-50 OR ANY OTHER VISCOSITY GRADE OIL, NOT RECOMMENDED.

3100 V6 Engine

As in the chart shown previously, if you have the 3100 V6 engine, SAE 5W-30 is the only viscosity grade recommended for your vehicle. You should look for and use only oils which have the API Starburst symbol and which are also identified as SAE 5W-30. If you cannot find such SAE 5W-30 oils, you can use an SAE 10W-30 oil which has the API Starburst symbol, if it's going to be 0°F (-18°C) or above. Do not use other viscosity grade oils, such as SAE 10W-40 or SAE 20W-50 under any conditions.

As shown in the following chart, if you have the 3800 V6 engine, SAE 10W-30 is the viscosity grade recommended for your vehicle. However, you can use SAE 5W-30 if it's going to be colder than 60°F (16°C) before your next oil change. When it is very cold, colder than 0°F (-18°C) you should use an SAE 5W-30 oil. These numbers on an oil container show its viscosity, or thickness. Do not use other viscosity grade oils, such as SAE 10W-40 or SAE 20W-50 under any conditions.

## RECOMMENDED SAE VISCOSITY GRADE ENGINE OILS

FOR BEST FUEL ECONOMY AND COLD STARTING, SELECT THE LOWEST SAE VISCOSITY GRADE OIL FOR THE EXPECTED TEMPERATURE RANGE.

**HOT  
WEATHER**



**COLD  
WEATHER**

**LOOK  
FOR THIS  
SYMBOL**



DO NOT USE SAE 20W-50 OR ANY OTHER GRADE OIL NOT RECOMMENDED

3800 V6 or 3800 V6 Supercharged Engine

**Notice:** Use only engine oil with the American Petroleum Institute Certified For Gasoline Engines starburst symbol. Failure to use the recommended oil can result in engine damage not covered by your warranty.

GM Goodwrench<sup>®</sup> oil meets all the requirements for your vehicle.

If you are in an area of extreme cold, where the temperature falls below  $-20^{\circ}\text{F}$  ( $-29^{\circ}\text{C}$ ), it is recommended that you use either an SAE 5W-30 synthetic oil or an SAE 0W-30 oil. Both will provide easier cold starting and better protection for your engine at extremely low temperatures.

## Engine Oil Additives

Don't add anything to your oil. The recommended oils with the starburst symbol are all you will need for good performance and engine protection.

## When to Change Engine Oil (GM Oil Life System™)

Your vehicle has a computer system that lets you know when to change the engine oil and filter. This is based on engine revolutions and engine temperature, and not on mileage. Based on driving conditions, the mileage at which an oil change will be indicated can vary considerably. For the oil life system to work properly, you must reset the system every time the oil is changed.

When the system has calculated that oil life has been diminished, it will indicate that an oil change is necessary. A CHANGE OIL SOON light will come on. Change your oil as soon as possible within the next two times you stop for fuel. It is possible that, if you are driving under the best conditions, the oil life system may not indicate that an oil change is necessary for over a year. However, your engine oil and filter must be changed at least once a year and at this time the system must be reset. It is also important to check your oil regularly and keep it at the proper level.

If the system is ever reset accidentally, you must change your oil at 3,000 miles (5,000 km) since your last oil change. Remember to reset the oil life system whenever the oil is changed.

## How to Reset the GM Oil Life System

The GM Oil Life System™ calculates when to change your engine oil and filter based on vehicle use. Anytime your oil is changed, reset the system so it can calculate when the next oil change is required. If a situation occurs where you change your oil prior to a CHANGE OIL SOON light being turned on, reset the system.

To reset the GM Oil Life System™ after the oil has been changed, use one of the following two procedures:

Using the Driver Information Center (DIC)

1. With the ignition key in RUN but the engine off, fully push and release the accelerator pedal slowly three times within five seconds.
2. If the CHANGE OIL SOON light flashes, the system is resetting.
3. Turn the key to OFF after the light stops flashing, then start the vehicle.

If the CHANGE OIL SOON light comes back on, the engine oil life monitor has not reset. Repeat the procedure.

Using the Trip Computer (If Equipped)

1. Press the MODE button until the light appears lit next to OIL LIFE.
2. Press and hold the RESET button for three seconds. The oil life percentage should change to 100%.



## What to Do with Used Oil

Used engine oil contains certain elements that may be unhealthy for your skin and could even cause cancer. Don't let used oil stay on your skin for very long. Clean your skin and nails with soap and water, or a good hand cleaner. Wash or properly dispose of clothing or rags containing used engine oil. See the manufacturer's warnings about the use and disposal of oil products.

Used oil can be a threat to the environment. If you change your own oil, be sure to drain all the oil from the filter before disposal. Never dispose of oil by putting it in the trash, pouring it on the ground, into sewers, or into streams or bodies of water. Instead, recycle it by taking it to a place that collects used oil. If you have a problem properly disposing of your used oil, ask your dealer, a service station or a local recycling center for help.

## Supercharger Oil



Unless you are technically qualified and have the proper tools, you should let your dealer or a qualified service center perform this maintenance.

## When to Check

Check oil level every 30,000 miles (50,000 km) or every 36 months, whichever occurs first.

## What Kind of Oil to Use

Use only the recommended supercharger oil. See *Part D: Recommended Fluids and Lubricants* on page 6-15.

## How to Check and Add Oil

Park the vehicle on a level surface. Check oil only when the engine is cold. Allow the engine to cool two to three hours after running.

### CAUTION:

If you remove the supercharger oil fill plug while the engine is hot, pressure may cause hot oil to blow out of the oil fill hole. You may be burned. Do not remove the plug until the engine cools.

1. Clean the area around the oil fill plug before removing it.
2. Remove the oil fill plug.
3. The oil level is correct when it just reaches the bottom of the threads of the inspection hole.
4. Replace the oil plug with the O-ring in place. Tighten to 88 lb-in (10 N·m).

## Engine Air Cleaner/Filter

The engine air cleaner/filter is located in the engine compartment on the driver's side of the vehicle. See *Engine Compartment Overview* on page 5-12 for more information on location.

To check or replace the engine air cleaner/filter do the following:



1. Loosen the two clips on the top of the engine air cleaner/filter housing and lift the filter cover tabs out of the housing.
2. Push the filter cover housing toward the engine.

3. Pull out the filter.
4. Check or install a new engine air cleaner/filter. See *Normal Maintenance Replacement Parts* on page 5-104.
5. To reinstall the cover, position the tabs through the slots on the housing. A notch on the sides of the filter cover will indicate the correct engagement. Reinstall the two clips on the top of the housing when you are finished.

Refer to the Maintenance Schedule to determine when to replace the air filter.

See *Part A: Scheduled Maintenance Services* on page 6-4.

 **CAUTION:**

**Operating the engine with the air cleaner/filter off can cause you or others to be burned. The air cleaner not only cleans the air, it stops flame if the engine backfires. If it isn't there and the engine backfires, you could be burned. Don't drive with it off, and be careful working on the engine with the air cleaner/filter off.**

**Notice:** If the air cleaner/filter is off, a backfire can cause a damaging engine fire. And, dirt can easily get into your engine, which will damage it. Always have the air cleaner/filter in place when you're driving.

## Automatic Transaxle Fluid

### When to Check and Change

A good time to check your automatic transaxle fluid level is when the engine oil is changed.

Change both the fluid and filter every 50,000 miles (83,000 km) if the vehicle is mainly driven under one or more of these conditions:

- In heavy city traffic where the outside temperature regularly reaches 90°F (32°C) or higher.
- In hilly or mountainous terrain.
- When doing frequent trailer towing.
- Uses such as found in taxi, police or delivery service.

If you do not use your vehicle under any of these conditions, change the fluid and filter at 100,000 miles (166,000 km).

See *Part A: Scheduled Maintenance Services on page 6-4*.

### How to Check

Because this operation can be a little difficult, you may choose to have this done at the dealership service department.

If you do it yourself, be sure to follow all the instructions here, or you could get a false reading on the dipstick.

**Notice:** Too much or too little fluid can damage your transaxle. Too much can mean that some of the fluid could come out and fall on hot engine or exhaust system parts, starting a fire. Too little fluid could cause the transaxle to overheat. Be sure to get an accurate reading if you check your transaxle fluid.

Wait at least 30 minutes before checking the transaxle fluid level if you have been driving:

- When outside temperatures are above 90°F (32°C).
- At high speed for quite a while.
- In heavy traffic — especially in hot weather.
- While pulling a trailer.

To get the right reading, the fluid should be at normal operating temperature, which is 180°F to 200°F (82°C to 93°C).

Get the vehicle warmed up by driving about 15 miles (24 km) when outside temperatures are above 50°F (10°C). If it's colder than 50°F (10°C), you may have to drive longer.

## Checking the Fluid Level

Prepare your vehicle as follows:

- Park your vehicle on a level place. Keep the engine running.
- With the parking brake applied, place the shift lever in PARK (P).
- With your foot on the brake pedal, move the shift lever through each gear range, pausing for about three seconds in each range. Then, position the shift lever in PARK (P).
- Let the engine run at idle for three to five minutes.

Then, without shutting off the engine, follow these steps:



**3100 V6 Engine**



**3800 V6 or 3800 V6  
Supercharged Engine**

The transaxle fluid dipstick handle is the black loop located near the rear of the engine. See *Engine Compartment Overview on page 5-12* for more information on location.

1. Pull out the dipstick and wipe it with a clean rag or paper towel.
2. Push it back in all the way, wait three seconds and then pull it back out again.

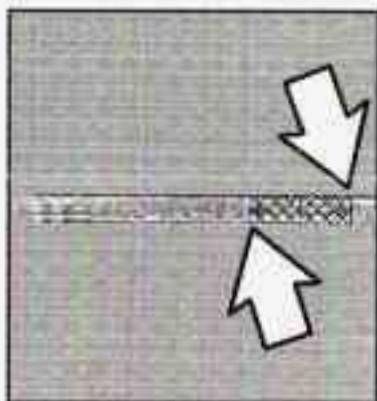

**3100 V6 Engine**



**3800 V6 or 3800 V6 Supercharged Engine**

3. Check both sides of the dipstick, and read the lower level. The fluid level must be in the cross-hatched area.
4. If the fluid level is in the acceptable range, push the dipstick back in all the way.

## How to Add Fluid

Refer to the Maintenance Schedule to determine what kind of transaxle fluid to use. See *Part D: Recommended Fluids and Lubricants* on page 6-15.

If the fluid level is low, add only enough of the proper fluid to bring the level into the cross-hatched area on the dipstick.

1. Pull out the dipstick.
2. Using a long-neck funnel, add enough fluid at the dipstick hole to bring it to the proper level.  
It doesn't take much fluid, generally less than one pint (0.5 L). Don't overfill.

**Notice:** We recommend you use only fluid labeled DEXRON<sup>®</sup>-III, because fluid with that label is made especially for your automatic transaxle. Damage caused by fluid other than DEXRON<sup>®</sup>-III is not covered by your new vehicle warranty.

3. After adding fluid, recheck the fluid level as described under "How to Check" listed previously in this section.
4. When the correct fluid level is obtained, push the dipstick back in all the way.

## Engine Coolant

The cooling system in your vehicle is filled with DEX-COOL<sup>®</sup> engine coolant. This coolant is designed to remain in your vehicle for 5 years or 150,000 miles (240,000 km), whichever occurs first, if you add only DEX-COOL<sup>®</sup> extended life coolant.

The following explains your cooling system and how to add coolant when it is low. If you have a problem with engine overheating or if you need to add coolant to your radiator, see *Engine Overheating on page 5-33*.

A 50/50 mixture of clean, drinkable water and DEX-COOL<sup>®</sup> engine coolant will:

- Give freezing protection down to -34°F (-37°C).
- Give boiling protection up to 265°F (129°C)
- Protect against rust and corrosion.
- Help keep the proper engine temperature.
- Let the warning lights and gauges work as they should.

**Notice:** When adding coolant, it is important that you use only DEX-COOL<sup>®</sup> (silicate-free) coolant. If coolant other than DEX-COOL<sup>®</sup> is added to the system, premature engine, heater core or radiator corrosion may result. In addition, the engine coolant will require change sooner – at 30,000 miles (50,000 km) or 24 months, whichever occurs first. Damage caused by the use of coolant other than DEX-COOL<sup>®</sup> is not covered by your new vehicle warranty.

### What to Use

Use a mixture of one-half clean, drinkable water and one-half DEX-COOL<sup>®</sup> engine coolant which won't damage aluminum parts. If you use this coolant mixture, you don't need to add anything else.

#### CAUTION:

Adding only plain water to your cooling system can be dangerous. Plain water, or some other liquid such as alcohol, can boil before the proper coolant mixture will. Your vehicle's coolant warning system is set for the proper

CAUTION: (Continued)

## CAUTION: (Continued)

coolant mixture. With plain water or the wrong mixture, your engine could get too hot but you wouldn't get the overheat warning. Your engine could catch fire and you or others could be burned. Use a 50/50 mixture of clean, drinkable water and DEX-COOL<sup>®</sup> coolant.

**Notice:** If you use an improper coolant mixture, your engine could overheat and be badly damaged. The repair cost wouldn't be covered by your warranty. Too much water in the mixture can freeze and crack the engine, radiator, heater core and other parts.

If you have to add coolant more than four times a year, have your dealer check your cooling system.

**Notice:** If you use the proper coolant, you don't have to add extra inhibitors or additives which claim to improve the system. These can be harmful.

## Checking Coolant

The coolant recovery tank is located in the engine compartment toward the rear of the engine on the passenger's side of the vehicle.

See *Engine Compartment Overview* on page 5-12 for more information on location. The vehicle must be on a level surface.



When your engine is cold, the coolant level should be at the COLD mark or a little higher. When your engine is warm, the level should be up to the HOT mark or a little higher.

When your engine is warm, the level should be up to the HOT mark or a little higher.



## Adding Coolant

If you need more coolant, add the proper DEX-COOL<sup>®</sup> coolant mixture at the coolant recovery tank, but be careful not to spill it.

If the coolant recovery tank is completely empty, add coolant to the radiator. See *Engine Overheating* on page 5-33.

### CAUTION:

Turning the radiator pressure cap when the engine and radiator are hot can allow steam and scalding liquids to blow out and burn you badly. With the coolant recovery tank, you will almost never have to add coolant at the radiator. Never turn the radiator pressure cap -- even a little -- when the engine and radiator are hot.

### CAUTION:

You can be burned if you spill coolant on hot engine parts. Coolant contains ethylene glycol, and it will burn if the engine parts are hot enough. Don't spill coolant on a hot engine.

Occasionally check the coolant level in the radiator. For information on how to add coolant to the radiator, see *Cooling System* on page 5-36.

## Radiator Pressure Cap

**Notice:** Your radiator cap is a pressure-type cap and must be tightly installed to prevent coolant loss and possible engine damage from overheating. Be sure the arrows on the cap line up with the overflow tube on the radiator filler neck.

The radiator pressure cap is located in the front of the engine compartment on the passenger's side, near the diagonal cross brace. See *Engine Compartment Overview* on page 5-12 for more information on location.

## Engine Overheating

You will find a coolant temperature gage and a warning light concerning an overheated engine condition on the instrument panel cluster. See *Engine Coolant Temperature Gage* on page 3-31 and *Engine Coolant Temperature Warning Light* on page 3-31.

## Overheated Engine Protection Operating Mode

This emergency operating mode allows your vehicle to be driven to a safe place in an emergency situation. If an overheated engine condition exists, an overheat protection mode which alternates firing groups of cylinders helps prevent engine damage. In this mode, you will notice a significant loss in power and engine performance. The engine coolant temperature gage will indicate an overheat condition exists. Driving extended miles (km) and/or towing a trailer in the overheat protection mode should be avoided.

**Notice:** After driving in the overheated engine protection operating mode, to avoid engine damage, allow the engine to cool before attempting any repair. The engine oil will be severely degraded. Repair the cause of coolant loss, change the oil and reset the oil life system. See "Engine Oil" in the Index.

## If Steam Is Coming From Your Engine



### CAUTION: (Continued)

everyone away from the vehicle until it cools down. Wait until there is no sign of steam or coolant before you open the hood.

If you keep driving when your engine is overheated, the liquids in it can catch fire. You or others could be badly burned. Stop your engine if it overheats, and get out of the vehicle until the engine is cool.

See "Overheated Engine Protection Operating Mode" in the Index for information on driving to a safe place in an emergency.

### CAUTION:

Steam from an overheated engine can burn you badly, even if you just open the hood. Stay away from the engine if you see or hear steam coming from it. Just turn it off and get

CAUTION: (Continued)

*Notice:* If your engine catches fire because you keep driving with no coolant, your vehicle can be badly damaged. The costly repairs would not be covered by your warranty. See "Overheated Engine Protection Operating Mode" in the Index for information on driving to a safe place in an emergency.

## If No Steam is Coming From Your Engine

An overheat warning can indicate a serious problem.

If you get an engine overheat warning, but see or hear no steam, the problem may not be too serious.

Sometimes the engine can get a little too hot when you:

- Climb a long hill on a hot day.
- Stop after high-speed driving.
- Idle for long periods in traffic.
- Tow a trailer.

If you get the overheat warning with no sign of steam, try this for a minute or so:

1. In heavy traffic let the engine idle in NEUTRAL (N) while stopped. If it's safe to do so, pull off the road, shift to PARK (P) or NEUTRAL (N) and let the engine idle.
2. Turn on your heater to full hot at the highest fan speed and open the windows as necessary.

If you no longer have the overheat warning, you can drive. Just to be safe, drive slower for about 10 minutes. If the warning doesn't come back on, you can drive normally.

If the warning continues, and you have not stopped, pull over, stop, and park your vehicle right away.

If there's still no sign of steam, you can idle the engine for three minutes while you're parked. If you still have the warning, turn off the engine and get everyone out of the vehicle until it cools down. Also, see "Overheated Engine Protection Operating Mode" listed previously in this section.

You may decide not to lift the hood but to get service help right away.

## Cooling System

When you decide it's safe to lift the hood, here's what you'll see:



**3100 V6 Engine**

- A. Coolant Recovery Tank
- B. Electric Engine Cooling Fans
- C. Radiator Pressure Cap



**3800 V6 and 3800 V6 Supercharged Engines**

- A. Coolant Recovery Tank
- B. Electric Engine Cooling Fans
- C. Radiator Pressure Cap

**⚠ CAUTION:**

An electric engine cooling fan under the hood can start up even when the engine is not running and can injure you. Keep hands, clothing and tools away from any underhood electric fan.

If the coolant inside the coolant recovery tank is boiling, don't do anything else until it cools down. The vehicle should be parked on a level surface.

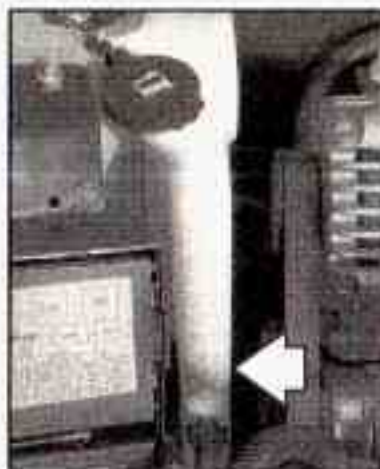

When the engine is cold, the coolant level should be at or above the COLD mark on the coolant recovery tank.

If it isn't, you may have a leak at the pressure cap or in the radiator hoses, heater hoses, radiator, water pump or somewhere else in the cooling system.

## CAUTION:

Heater and radiator hoses, and other engine parts, can be very hot. Don't touch them. If you do, you can be burned.

Don't run the engine if there is a leak. If you run the engine, it could lose all coolant. That could cause an engine fire, and you could be burned. Get any leak fixed before you drive the vehicle.

If there seems to be no leak, with the engine on, check to see if the electric engine cooling fans are running. If the engine is overheating, both fans should be running. If they aren't, your vehicle needs service.

**Notice:** Engine damage from running your engine without coolant isn't covered by your warranty. See "Overheated Engine Protection Operating Mode" in the Index for information on driving to a safe place in an emergency.

**Notice:** When adding coolant, it is important that you use only DEX-COOL<sup>®</sup> (silicate-free) coolant. If coolant other than DEX-COOL<sup>®</sup> is added to the system, premature engine, heater core or radiator corrosion may result. In addition, the engine coolant will require change sooner — at 30,000 miles (50 000 km) or 24 months, whichever occurs first. Damage caused by the use of coolant other than DEX-COOL<sup>®</sup> is not covered by your new vehicle warranty.

## How to Add Coolant to the Coolant Recovery Tank

If you haven't found a problem yet, but the coolant level isn't at the COLD mark, add a 50/50 mixture of clean, drinkable water and DEX-COOL<sup>®</sup> engine coolant at the coolant recovery tank. See *Engine Coolant* on page 5-30 for more information.

**⚠ CAUTION:**

Adding only plain water to your cooling system can be dangerous. Plain water, or some other liquid such as alcohol, can boil before the proper coolant mixture will. Your vehicle's coolant warning system is set for the proper coolant mixture. With plain water or the wrong mixture, your engine could get too hot but you wouldn't get the overheat warning. Your engine could catch fire and you or others could be burned. Use a 50/50 mixture of clean, drinkable water and DEX COOL<sup>®</sup> coolant.

*Notice:* In cold weather, water can freeze and crack the engine, radiator, heater core and other parts. Use the recommended coolant and the proper coolant mixture.

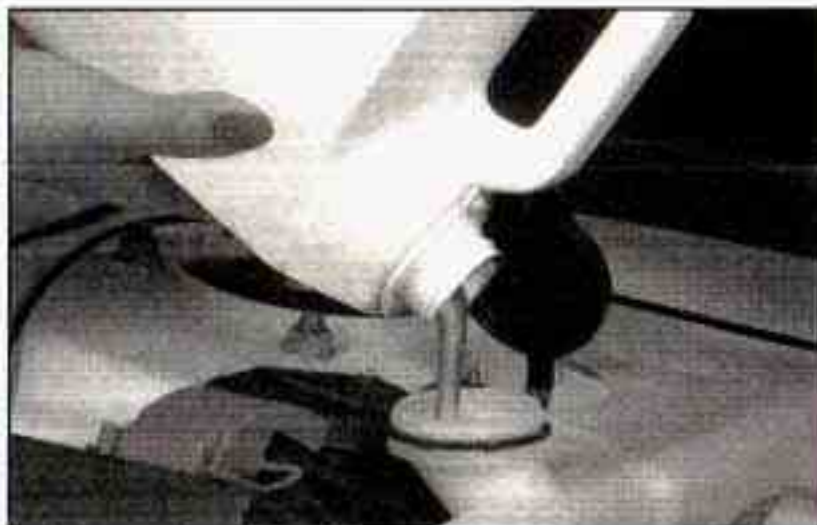

**⚠ CAUTION:**

You can be burned if you spill coolant on hot engine parts. Coolant contains ethylene glycol and it will burn if the engine parts are hot enough. Don't spill coolant on a hot engine.

When the coolant in the coolant recovery tank is at the COLD mark, start your vehicle.



If the overheat warning continues, there's one more thing you can try. You can add the proper coolant mixture directly to the radiator, but be sure the cooling system is cool before you do it.

**⚠ CAUTION:**

Steam and scalding liquids from a hot cooling system can blow out and burn you badly. They are under pressure, and if you turn the radiator pressure cap – even a little – they can come out at high speed. Never turn the cap when the cooling system, including the radiator pressure cap, is hot. Wait for the cooling system and radiator pressure cap to cool if you ever have to turn the pressure cap.

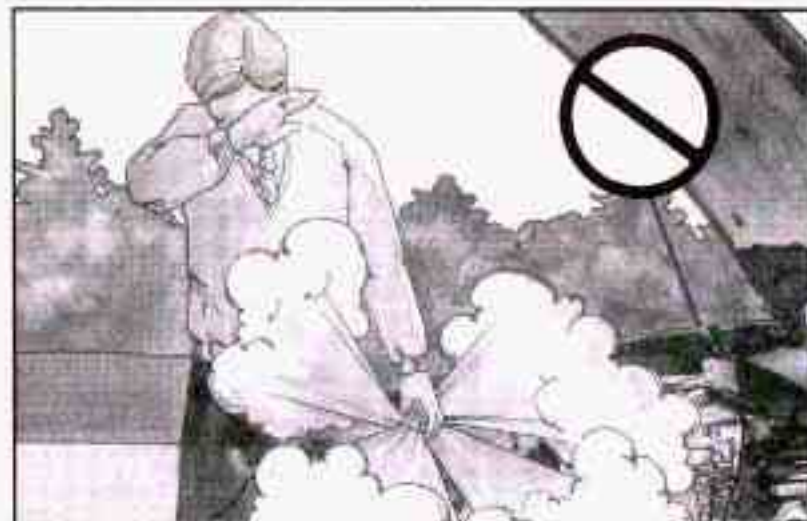

## How to Add Coolant to the Radiator

**Notice:** Your engine has a specific radiator fill procedure. Failure to follow this procedure could cause your engine to overheat and be severely damaged.

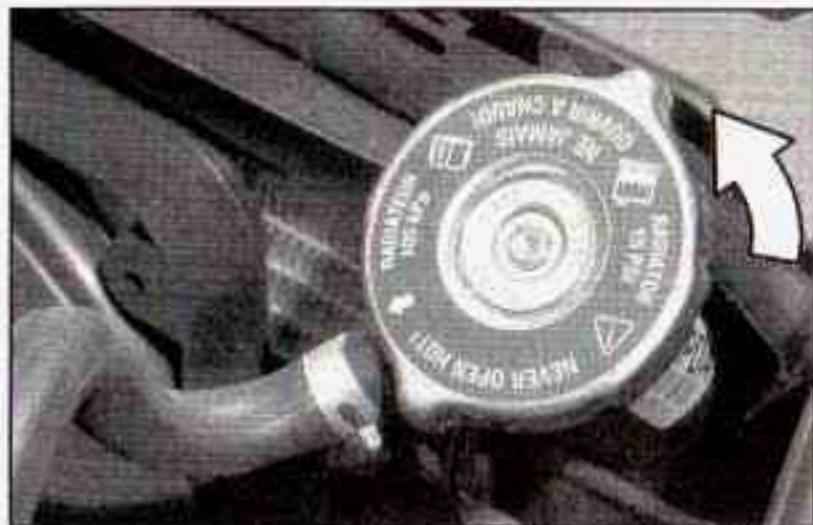

The radiator pressure cap is located on the passenger's side of the vehicle in the front of the engine compartment, near the battery and the diagonal cross brace. See *Engine Compartment Overview* on page 5-12 for more information on location.

You can remove the radiator pressure cap when the cooling system, including the radiator pressure cap and upper radiator hose, is no longer hot.

1. Turn the pressure cap slowly counterclockwise until it first stops. (Don't press down while turning the pressure cap).

If you hear a hiss, wait for that to stop. A hiss means there is still some pressure left.

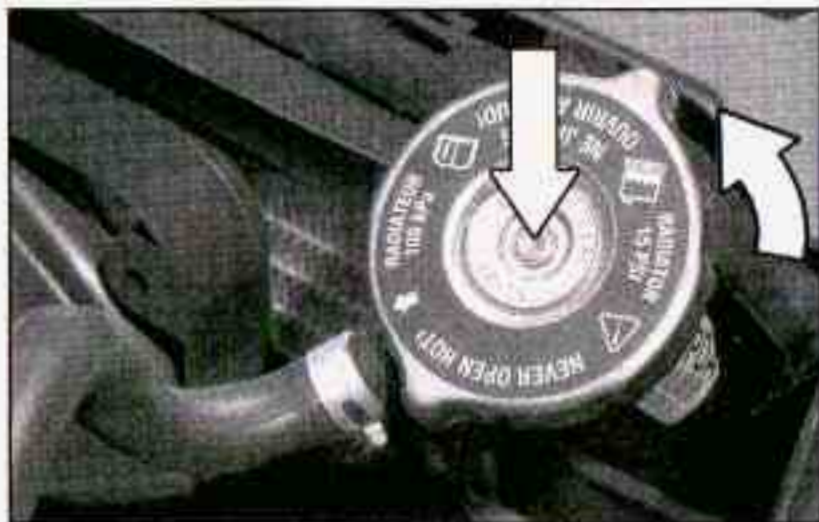

2. Then keep turning the pressure cap, but now push down as you turn it. Remove the pressure cap.

**⚠ CAUTION:**

**You can be burned if you spill coolant on hot engine parts. Coolant contains ethylene glycol and it will burn if the engine parts are hot enough. Don't spill coolant on a hot engine.**

3. If you have the 3800 V6 engine, remove the 3800 Series II V6 engine cover shield to access the bleed valve.

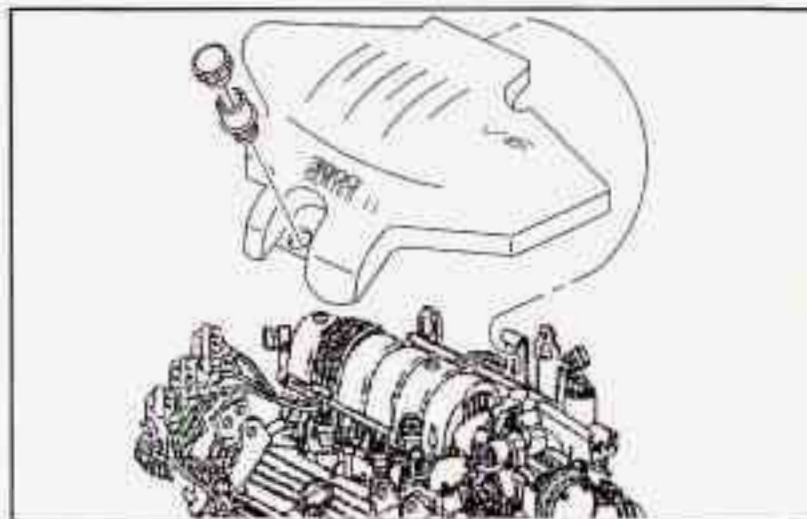

- 3.1. Clean the area around the engine oil fill tube and cap before removing. Twist the oil fill tube, with cap attached, counterclockwise and remove it.
- 3.2. If you have the supercharged engine, remove the nut in the center of the cover shield.

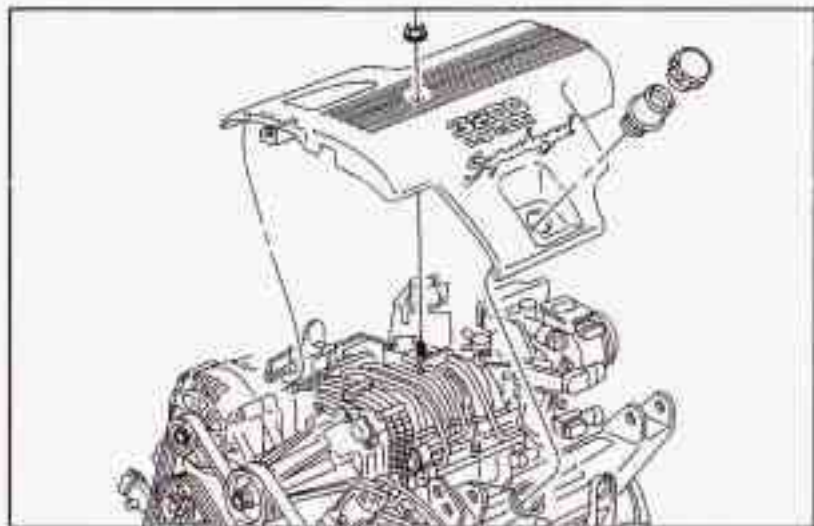

- 3.3. Lift the engine cover shield at the front, slide the catch tab out of the engine bracket and remove the cover shield.
- 3.4. Put the oil fill tube, with cap attached, in the valve cover oil fill hole until you're ready to replace the cover shield.

4. After the engine cools, open the coolant air bleed valve or valves.



**Thermostat Bypass  
Tube (3100 V6)**



**Thermostat Housing  
(3100 V6)**

3100 V6 engine: There are two bleed valves. One is located on the thermostat housing. The other is located on the thermostat bypass tube.



**Thermostat Housing  
(3800 V6)**

3800 V6 engine: There is one bleed valve. It is located on the thermostat housing.



5. Fill the radiator with the proper DEX-COOL<sup>®</sup> coolant mixture, up to the base of the filler neck. See *Engine Coolant on page 5-30* for more information about the proper coolant mixture.

If you see a stream of coolant coming from an air bleed valve, close the valve. Otherwise, close the valves after the radiator is filled.

6. Rinse or wipe any spilled coolant from the engine and the compartment.
7. If you have the 3800 V6 engine, replace the 3800 Series II V6 engine cover shield.
  - 7.1. Remove the oil fill tube, with cap attached, from the valve cover.
  - 7.2. Insert the catch tab on the cover shield under the bracket on the engine.
  - 7.3. Place the hole in the cover shield over the hole in the valve cover. Install oil fill tube and cap by twisting clockwise.
  - 7.4. If you have the supercharged engine, install the nut in the center of the cover shield.



8. Then fill the coolant recovery tank to COLD mark.
9. Put the cap back on the coolant recovery tank, but leave the pressure cap off.

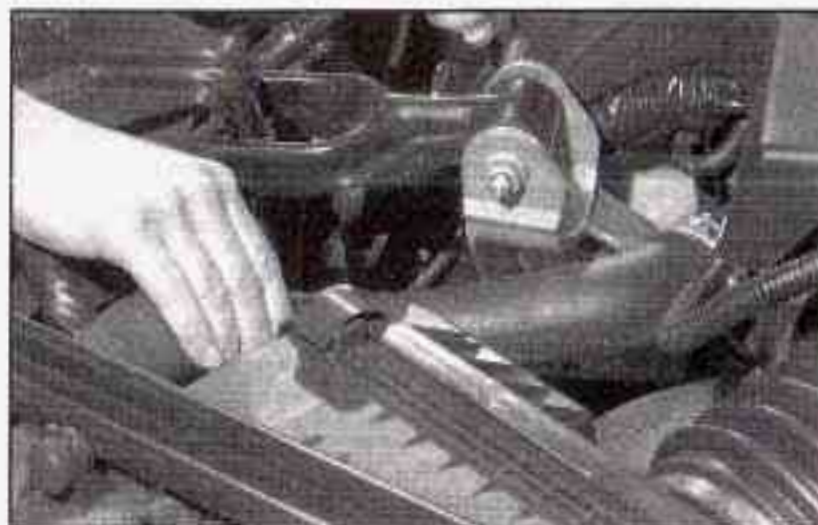

10. Start the engine and let it run until you can feel the upper radiator hose getting hot. Watch out for the engine cooling fans.
11. By this time, the coolant level inside the radiator filler neck may be lower. If the level is lower, add more of the proper DEX-COOL<sup>®</sup> coolant mixture through the filler neck until the level reaches the base of the filler neck.



12. Then replace the pressure cap. At any time during this procedure if coolant begins to flow out of the filler neck, reinstall the pressure cap. Be sure the arrow on the pressure cap lines up like this.
13. Check the coolant in the recovery tank. The level in the coolant recovery tank should be at the HOT mark when the engine is hot or at the COLD mark when the engine is cold.

## Power Steering Fluid

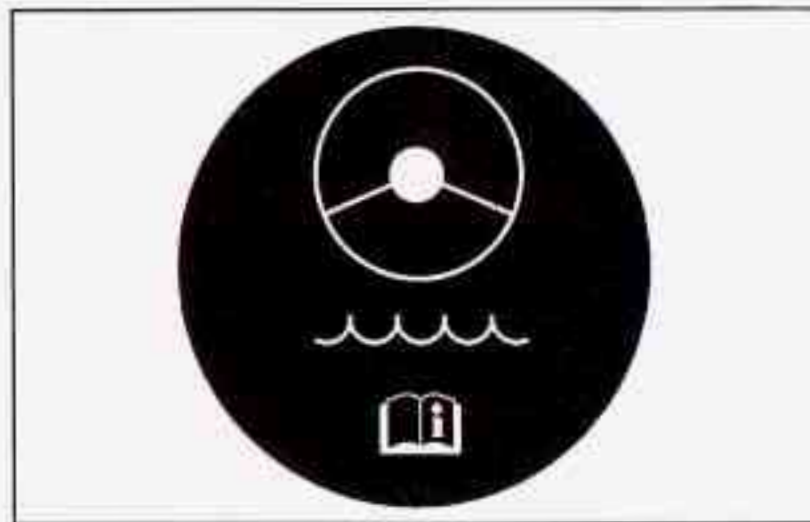

The power steering fluid reservoir is located in the engine compartment next to the engine coolant recovery tank. In the 3800 V6 (Code K) engine and the 3800 V6 Supercharged (Code I) engine, the power steering fluid reservoir sits low in the engine compartment. See *Engine Compartment Overview on page 5-12*.

## When to Check Power Steering Fluid

It is not necessary to regularly check power steering fluid unless you suspect there is a leak in the system or you hear an unusual noise. A fluid loss in this system could indicate a problem. Have the system inspected and repaired. See *Engine Compartment Overview* on page 5-12 for reservoir location.

## How to Check Power Steering Fluid

Turn the key off, let the engine compartment cool down, wipe the cap and the top of the reservoir clean, then unscrew the cap and wipe the dipstick with a clean rag. Replace the cap and completely tighten it. Then remove the cap again and look at the fluid level on the dipstick.



3100 V6 Engine

The level should be at the C (3100 V6 engine) or COLD (3800 V6 and 3800 V6 Supercharged engines) mark. If necessary, add only enough fluid to bring the level up to the mark.



3800 V6 or 3800 V6 Supercharged Engine

When the engine compartment is hot, the level should be at the H (3100 V6 engine) or HOT (3800 V6 and 3800 V6 Supercharged engines) mark. If the fluid is at the ADD mark, you should add fluid.

## What to Use

To determine what kind of fluid to use, see *Part D: Recommended Fluids and Lubricants* on page 6-15. Always use the proper fluid. Failure to use the proper fluid can cause leaks and damage hoses and seals.



## Windshield Washer Fluid

### What to Use

When you need windshield washer fluid, be sure to read the manufacturer's instructions before use. If you will be operating your vehicle in an area where the temperature may fall below freezing, use a fluid that has sufficient protection against freezing. See *Engine Compartment Overview* on page 5-12 for reservoir location.

### Adding Washer Fluid

The windshield washer fluid reservoir is located in the engine compartment on the passenger's side of the vehicle near the diagonal cross brace.



Open the cap with the washer symbol on it. Add washer fluid until the tank is full.

#### *Notice:*

- When using concentrated washer fluid, follow the manufacturer's instructions for adding water.
- Don't mix water with ready-to-use washer fluid. Water can cause the solution to freeze and damage your washer fluid tank and other parts of the washer system. Also, water doesn't clean as well as washer fluid.
- Fill your washer fluid tank only three-quarters full when it's very cold. This allows for expansion if freezing occurs, which could damage the tank if it is completely full.
- Don't use engine coolant (antifreeze) in your windshield washer. It can damage your washer system and paint.

## Brakes

### Brake Fluid



Your brake master cylinder reservoir is on the driver's side of the engine compartment. It is filled with DOT-3 brake fluid. See *Engine Compartment Overview* on page 5-12.

There are only two reasons why the brake fluid level in the reservoir might go down. The first is that the brake fluid goes down to an acceptable level during

normal brake lining wear. When new linings are put in, the fluid level goes back up. The other reason is that fluid is leaking out of the brake system. If it is, you should have your brake system fixed, since a leak means that sooner or later your brakes won't work well, or won't work at all.

So, it isn't a good idea to "top off" your brake fluid. Adding brake fluid won't correct a leak. If you add fluid when your linings are worn, then you'll have too much fluid when you get new brake linings. You should add (or remove) brake fluid, as necessary, only when work is done on the brake hydraulic system.

#### CAUTION:

**If you have too much brake fluid, it can spill on the engine. The fluid will burn if the engine is hot enough. You or others could be burned, and your vehicle could be damaged. Add brake fluid only when work is done on the brake hydraulic system.**

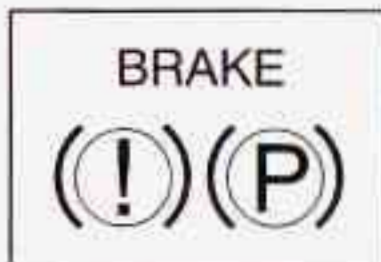

United States

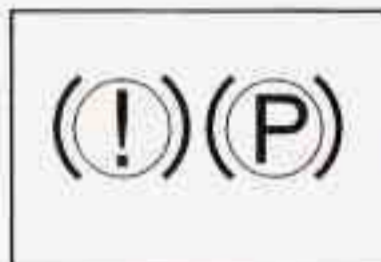

Canada

When your brake fluid falls to a low level, your brake warning light will come on. See *Brake System Warning Light* on page 3-28.

### What to Add

When you do need brake fluid, use only DOT-3 brake fluid. Use new brake fluid from a sealed container only. See *Part D: Recommended Fluids and Lubricants* on page 6-15.

Always clean the brake fluid reservoir cap and the area around the cap before removing it. This will help keep dirt from entering the reservoir.

### CAUTION:

With the wrong kind of fluid in your brake system, your brakes may not work well, or they may not even work at all. This could cause a crash. Always use the proper brake fluid.

#### Notice:

- Using the wrong fluid can badly damage brake system parts. For example, just a few drops of mineral-based oil, such as engine oil, in your brake system can damage brake system parts so badly that they'll have to be replaced. Don't let someone put in the wrong kind of fluid.
- If you spill brake fluid on your vehicle's painted surfaces, the paint finish can be damaged. Be careful not to spill brake fluid on your vehicle. If you do, wash it off immediately. See "Appearance Care" in the Index.

## Brake Wear

Your vehicle has four-wheel disc brakes.

Disc brake pads have built-in wear indicators that make a high-pitched warning sound when the brake pads are worn and new pads are needed. The sound may come and go or be heard all the time your vehicle is moving (except when you are pushing on the brake pedal firmly).

### CAUTION:

The brake wear warning sound means that soon your brakes won't work well. That could lead to an accident. When you hear the brake wear warning sound, have your vehicle serviced.

**Notice:** Continuing to drive with worn-out brake pads could result in costly brake repair.

Some driving conditions or climates may cause a brake squeal when the brakes are first applied or lightly applied. This does not mean something is wrong with your brakes.

Properly torqued wheel nuts are necessary to help prevent brake pulsation. When tires are rotated, inspect brake pads for wear and evenly tighten wheel nuts in the proper sequence to GM torque specifications.

Brake linings should always be replaced as complete axle sets.

See *Brake System Inspection* on page 6-14.

## Brake Pedal Travel

See your dealer if the brake pedal does not return to normal height, or if there is a rapid increase in pedal travel. This could be a sign of brake trouble.

## Brake Adjustment

Every time you apply the brakes, with or without the vehicle moving, your brakes adjust for wear.

## Replacing Brake System Parts

The braking system on a vehicle is complex. Its many parts have to be of top quality and work well together if the vehicle is to have really good braking. Your vehicle was designed and tested with top-quality GM brake parts. When you replace parts of your braking system — for example, when your brake linings wear down and you need new ones put in — be sure you get new approved GM replacement parts. If you don't, your brakes may no longer work properly. For example, if someone puts in brake linings that are wrong for your vehicle, the balance between your front and rear brakes can change — for the worse. The braking performance you've come to expect can change in many other ways if someone puts in the wrong replacement brake parts.

## Battery

Your new vehicle comes with a maintenance-free ACDelco<sup>®</sup> battery. When it's time for a new battery, get one that has the replacement number shown on the original battery's label. We recommend an ACDelco<sup>®</sup> battery. See *Engine Compartment Overview* on page 5-12 for battery location.

**Warning:** Battery posts, terminals and related accessories contain lead and lead compounds, chemicals known to the State of California to cause cancer and reproductive harm. Wash hands after handling.

If your battery has a very low charge or is dead, you may not be able to remove the ignition key from the ignition switch or shift out of Park (P). Refer to *Shifting Out of Park (P)* on page 2-30.

## Vehicle Storage

If you're not going to drive your vehicle for 25 days or more, remove the black, negative (-) cable from the battery. This will help keep your battery from running down.

### CAUTION:

Batteries have acid that can burn you and gas that can explode. You can be badly hurt if you aren't careful. See "Jump Starting" next for tips on working around a battery without getting hurt.

Contact your dealer to learn how to prepare your vehicle for longer storage periods.

Also, for your audio system, see *Theft-Deterrent Feature* on page 3-54.

## Jump Starting

If your battery has run down, you may want to use another vehicle and some jumper cables to start your vehicle. Be sure to follow the steps listed below to do it safely.

### CAUTION:

Batteries can hurt you. They can be dangerous because:

- They contain acid that can burn you.
- They contain gas that can explode or ignite.
- They contain enough electricity to burn you.

**If you don't follow these steps exactly, some or all of these things can hurt you.**

**Notice:** Ignoring these steps could result in costly damage to your vehicle that wouldn't be covered by your warranty.

Trying to start your vehicle by pushing or pulling it won't work, and it could damage your vehicle.

**Notice:** If the other system isn't a 12-volt system with a negative ground, both vehicles can be damaged.

1. Check the other vehicle. It must have a 12-volt battery with a negative ground system.
2. Get the vehicles close enough so the jumper cables can reach, but be sure the vehicles aren't touching each other. If they are, it could cause a ground connection you don't want. You wouldn't be able to start your vehicle, and the bad grounding could damage the electrical systems.

To avoid the possibility of the vehicles rolling, set the parking brake firmly on both vehicles involved in the jump start procedure. Put an automatic transaxle in PARK (P) or a manual transaxle in NEUTRAL before setting the parking brake.

**Notice:** If you leave your radio on, it could be badly damaged. The repairs wouldn't be covered by your warranty.

3. Turn off the ignition on both vehicles. Unplug unnecessary accessories plugged into the cigarette lighter or in the accessory power outlet. Turn off the radio and all lamps that aren't needed. This will avoid sparks and help save both batteries. And it could save your radio!

4. Open the hoods and locate the batteries. Find the positive (+) and negative (-) terminal locations on each vehicle. You will not need to access your battery for jump starting. Your vehicle has a remote positive (+) jump starting terminal for that purpose. The terminal is located in the engine compartment on the passenger's side of the vehicle, near the diagonal cross brace. See *Engine Compartment Overview* on page 5-12 for more information on location.

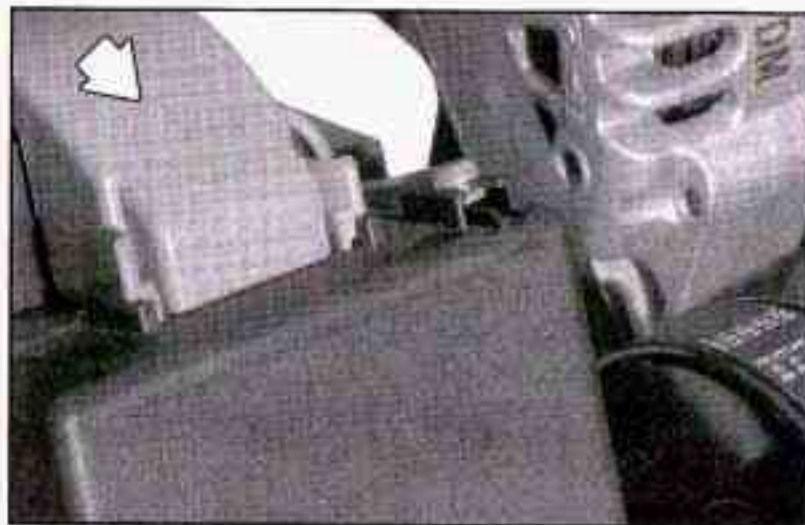

To uncover the remote positive (+) terminal, squeeze the sides of the plastic cap and slide the cap off. You should always use the remote positive (+) terminal instead of the positive (+) terminal on the battery.

 **CAUTION:**

An electric fan can start up even when the engine is not running and can injure you. Keep hands, clothing and tools away from any underhood electric fan.

 **CAUTION:**

Fans or other moving engine parts can injure you badly. Keep your hands away from moving parts once the engine is running.

 **CAUTION:**

Using a match near a battery can cause battery gas to explode. People have been hurt doing this, and some have been blinded. Use a flashlight if you need more light.

Be sure the battery has enough water. You don't need to add water to the ACDelco<sup>®</sup> battery installed in your new vehicle. But if a battery has filler caps, be sure the right amount of fluid is there. If it is low, add water to take care of that first. If you don't, explosive gas could be present.

Battery fluid contains acid that can burn you. Don't get it on you. If you accidentally get it in your eyes or on your skin, flush the place with water and get medical help immediately.



5. Check that the jumper cables don't have loose or missing insulation. If they do, you could get a shock. The vehicles could be damaged too.



Before you connect the cables, here are some basic things you should know. Positive (+) will go to positive (+) or to a remote positive (+) terminal if the vehicle has one. Negative will go to a heavy, unpainted metal engine part or to a remote negative (-) terminal if the vehicle has one.

Don't connect positive (+) to negative (-), or you'll get a short that would damage the battery and maybe other parts, too. And don't connect the negative (-) cable to the negative (-) terminal on the dead battery because this can cause sparks.

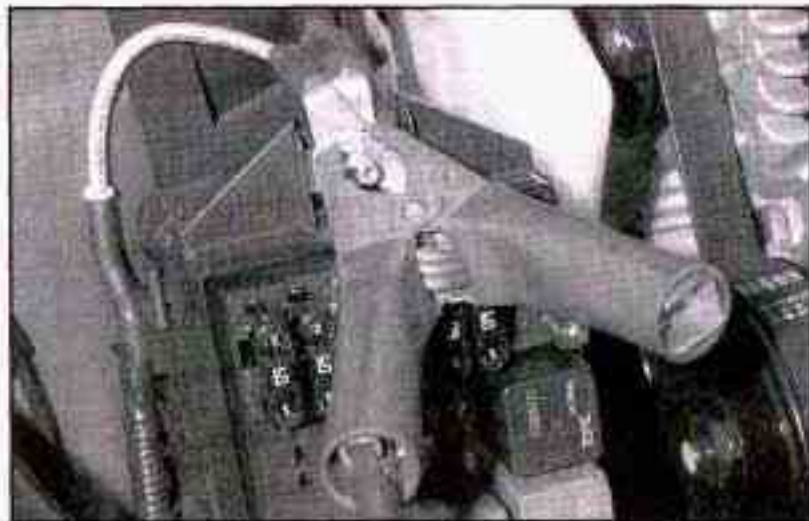

6. Connect the red positive (+) cable to the positive (+) terminal location on the vehicle with the dead battery. Use a remote positive (+) terminal if the vehicle has one.

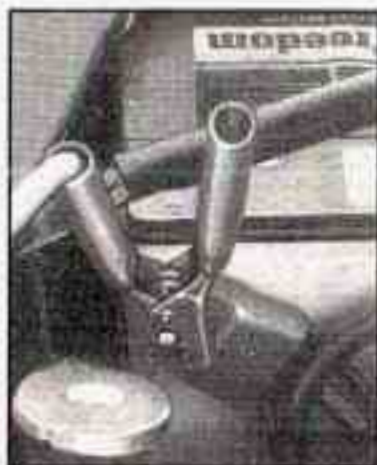

7. Don't let the other end touch metal. Connect it to the positive (+) terminal location on the vehicle with the good battery. Use a remote positive (+) terminal if the vehicle has one.



8. Now connect the black negative (-) cable to the negative (-) terminal location on the vehicle with the good battery. Use a remote negative (-) terminal if the vehicle has one.

9. Don't let the other end touch anything until the next step. The other end of the negative (-) cable *doesn't* go to the dead battery. It goes to a heavy, unpainted metal part or to a remote negative (c) terminal on the vehicle with the dead battery.

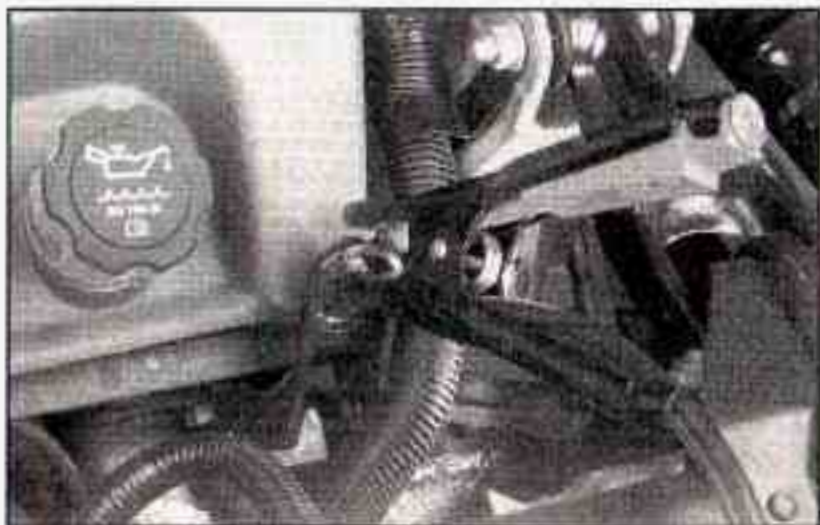

10. Connect the other end of the negative (-) cable at least 18 inches (45 cm) away from the dead battery, but not near engine parts that move. The electrical connection is just as good there, and the chance of sparks getting back to the battery is much less.

11. Now start the vehicle with the good battery and run the engine for a while.
12. Try to start the vehicle that had the dead battery. If it won't start after a few tries, it probably needs service.

**Notice:** Damage to your vehicle may result from electrical shorting if jumper cables are removed incorrectly. To prevent electrical shorting, take care that the cables don't touch each other or any other metal. The repairs wouldn't be covered by your warranty.

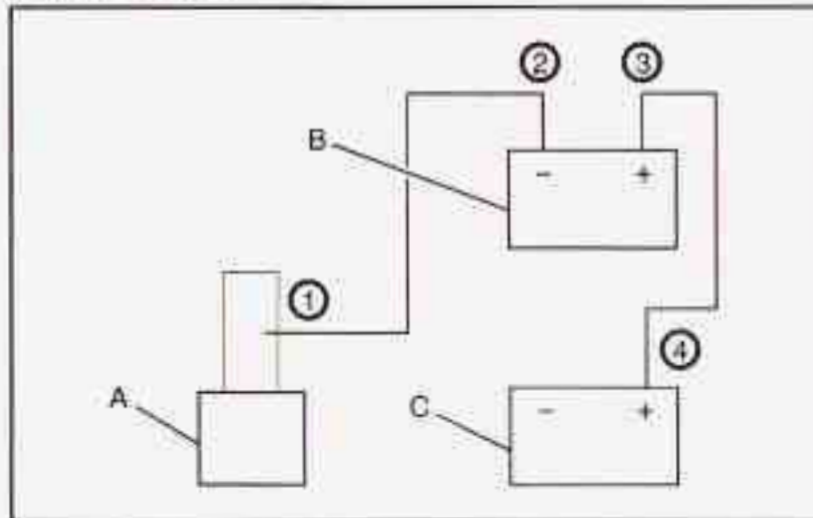

Jumper Cable Removal

- A. Heavy, Unpainted Metal Engine Part
- B. Good Battery or Remote Positive (+) Terminal
- C. Dead Battery or Remote Positive (+) Terminal

To disconnect the jumper cables from both vehicles, do the following:

1. Disconnect the black negative (-) cable from the vehicle that had the dead battery.
2. Disconnect the black negative (-) cable from the vehicle with the good battery.
3. Disconnect the red positive (+) cable from the vehicle with the good battery.
4. Disconnect the red positive (+) cable from the other vehicle.
5. Return the remote positive (+) terminal cover to its original position.

## Headlamp Aiming

The aim of your vehicle's headlamps can be adjusted by using aim tips located on the outer surface of the lens. The aim has been pre-set at the factory and should need no further adjustment.

If your vehicle is damaged in an accident, the headlamp aim may be affected. Aim adjustment to the low beam may be necessary if it is difficult to see lane markers (for horizontal aim), or if oncoming drivers flash their high beams at you (for vertical aim). If you believe your headlamps need to be re-aimed, it is recommended that you take your vehicle to the dealer for assistance.

## Bulb Replacement

For the proper type of replacement bulb, see *Replacement Bulbs* on page 5-66.

For any bulb changing procedure not listed in this section, contact your dealer.

## Halogen Bulbs

### CAUTION:

Halogen bulbs have pressurized gas inside and can burst if you drop or scratch the bulb. You or others could be injured. Be sure to read and follow the instructions on the bulb package.

## Headlamps

1. Open the hood.



2. Remove the two bolts from the top of the headlamp assembly.



3. Carefully remove the headlamp assembly from the vehicle. Be careful to avoid scratching or chipping the paint on the vehicle while removing.
4. Lift the plastic tab on the electrical connector and pull the connector out.



5. Turn the lamp socket ring a quarter turn counterclockwise to remove it from the headlamp assembly. Pull the old bulb from the socket.

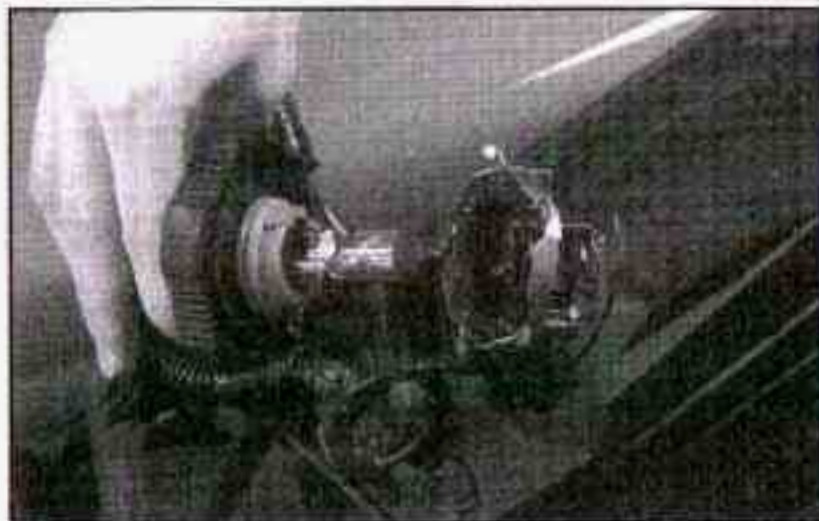

6. Place the new bulb into the socket.
7. Turn the bulb socket one-quarter turn clockwise to reinstall it.
8. Turn the lamp socket ring a quarter turn clockwise to place it back into the headlamp assembly.
9. Lift the plastic tab on the electrical connector and reinstall the connector.
10. Carefully reinstall the headlamp assembly. Be careful to avoid scratching or chipping the paint on the vehicle while reinstalling the assembly.
11. Reinstall the two bolts on the top of the headlamp assembly.

## Front Turn Signal and Sidemarker Lamps

1. Open the hood.



2. Remove the two bolts from the top of the headlamp assembly.
3. Remove the headlamp assembly from the vehicle. Be careful to avoid scratching or chipping the paint on the vehicle while removing it.
4. Turn the front sidemarker bulb socket a quarter turn counterclockwise to remove.

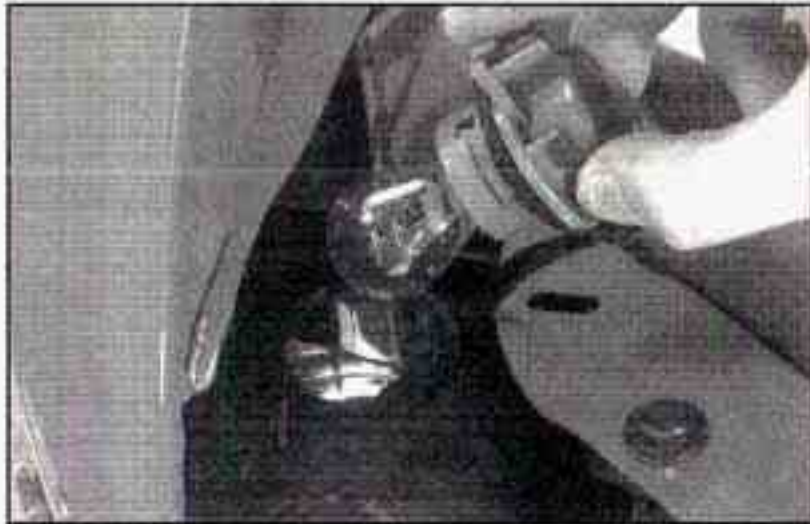

5. Remove the old bulb from the socket.
6. Place the new bulb into the socket.
7. Turn the bulb socket a quarter turn clockwise to reinstall it.
8. Carefully reinstall the headlamp assembly. Be careful to avoid scratching or chipping the paint on the vehicle.
9. Reinstall the two bolts on the top of the headlamp assembly.

## Center High-Mounted Stoplamp (CHMSL)

1. Open the trunk.



2. Reach through the access opening in the trunk and remove the slotted vent by squeezing the ends and pulling down.





3. Remove the old bulb by turning it a quarter turn counterclockwise.
4. Place the new bulb into the bulb socket.
5. Turn the bulb a quarter turn clockwise. Reinstall the vent.

## Taillamps, Sidemarker and Back-Up Lamps

1. Open the trunk.
2. Unhook the convenience net (if equipped) and remove it.

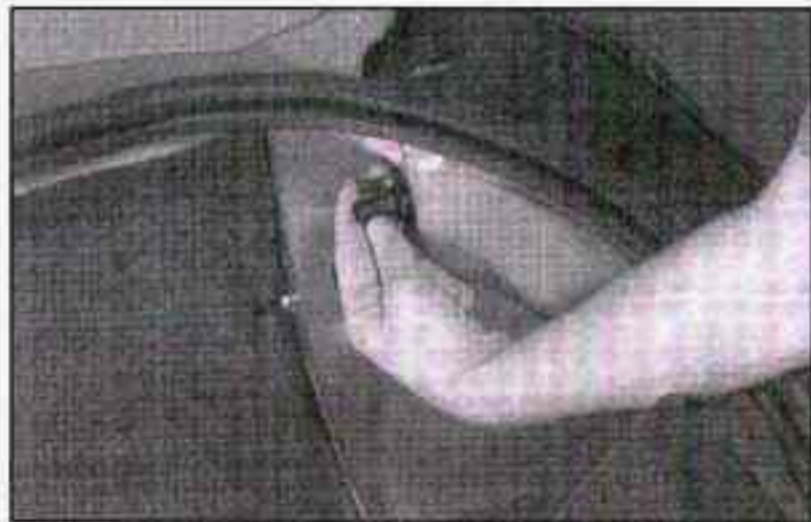

3. Unscrew the upper convenience net hook attachment.

4. Pull the trunk trim carpeting away from the rear of the trunk.
5. Remove the upper trunk trim hook and the two plastic wing nuts from the taillamp.

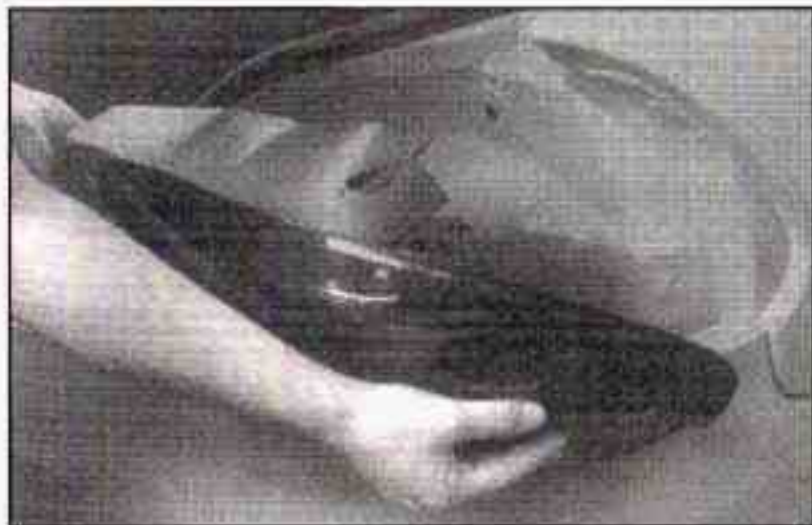

6. Carefully remove the taillamp assembly. Be careful to avoid scratching or chipping the paint on the vehicle.

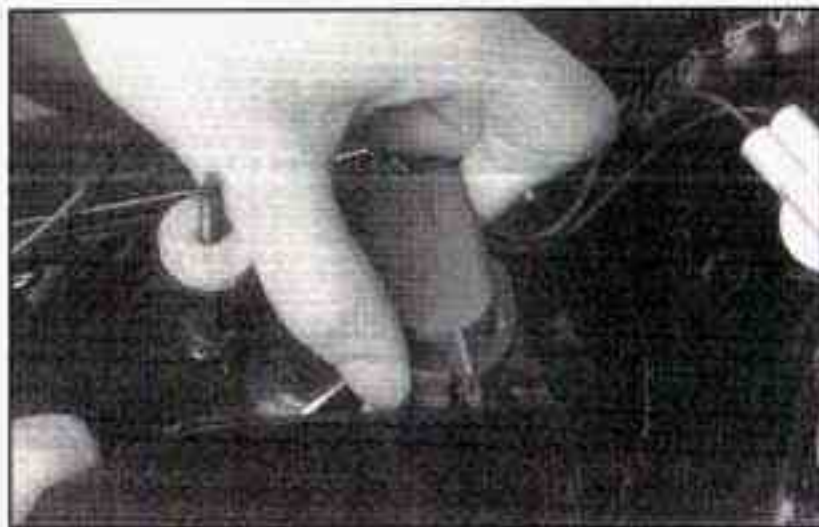

7. Turn the lamp socket a quarter turn counterclockwise to remove.

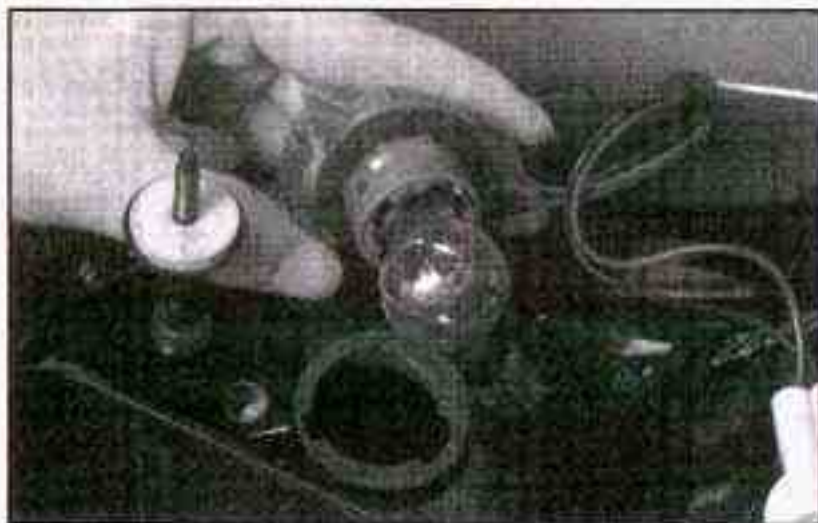

## Replacement Bulbs

For any bulbs not listed here, contact your dealer.

Exterior Lamp	Bulb Number
Back-Up	3057
Center High-Mounted Stop (CHMSL)	1141
Front Parking/Turn Signal	3357A
Headlamps High/Low Beam	9007
Sidemarkers (Front and Rear)	194
Tail/Stop Turn Signal	3057

8. Remove the old bulb.
9. Place the new bulb into the socket.
10. Turn the lamp socket a quarter turn clockwise to reinstall it.
11. Carefully reinstall the taillamp assembly by reversing Steps 1 through 5. Be careful to avoid scratching or chipping the vehicle's paint.

## Windshield Wiper Blade Replacement

Windshield wiper blades should be inspected at least twice a year for wear or cracking. See "Wiper Blade Check" under *At Least Twice a Year on page 6-10* for more information.

Replacement blades come in different types and are removed in different ways. For the proper type and length, see *Normal Maintenance Replacement Parts on page 5-104*.

To remove the wiper blade do the following:

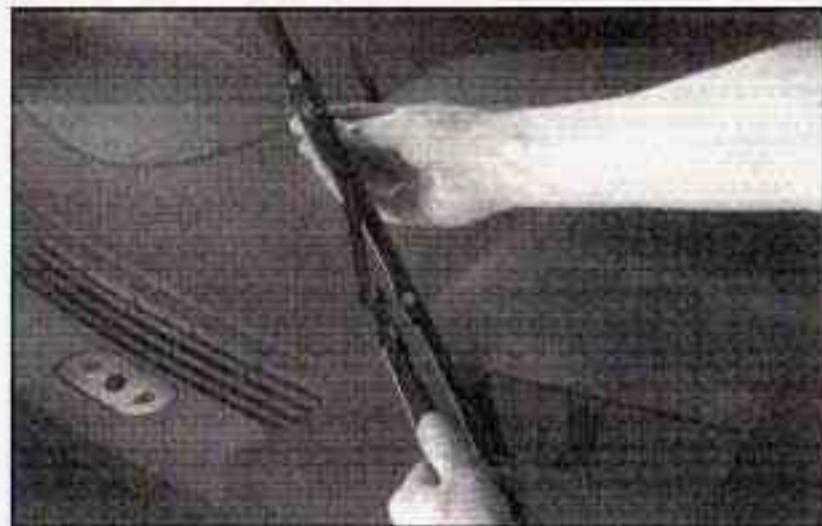

1. Pull the windshield wiper arm away from the windshield.
2. Push the release lever and slide the wiper assembly toward the driver's side of the vehicle.
3. Install a new blade by reversing Steps 1 and 2.

## Tires

Your new vehicle comes with high-quality tires made by a leading tire manufacturer. If you ever have questions about your tire warranty and where to obtain service, see your Pontiac Warranty booklet for details.

### CAUTION:

Poorly maintained and improperly used tires are dangerous.

- Overloading your tires can cause overheating as a result of too much friction. You could have an air-out and a serious accident. See "Loading Your Vehicle" in the Index.
- Underinflated tires pose the same danger as overloaded tires. The resulting accident could cause serious injury. Check all tires frequently to maintain the recommended pressure. Tire pressure should be checked when your tires are cold.

CAUTION: (Continued)

### CAUTION: (Continued)

- Overinflated tires are more likely to be cut, punctured or broken by a sudden impact — such as when you hit a pothole. Keep tires at the recommended pressure.
- Worn, old tires can cause accidents. If your tread is badly worn, or if your tires have been damaged, replace them.

## Inflation -- Tire Pressure

The Tire-Loading Information label, which is on the inside of the trunk lid, shows the correct inflation pressures for your tires when they're cold. "Cold" means your vehicle has been sitting for at least three hours or driven no more than 1 mile (1.6 km).

**Notice:** Don't let anyone tell you that underinflation or overinflation is all right. It's not. If your tires don't have enough air (underinflation), you can get the following:

- Too much flexing
- Too much heat
- Tire overloading

- Bad wear
- Bad handling
- Bad fuel economy

If your tires have too much air (overinflation), you can get the following:

- Unusual wear
- Bad handling
- Rough ride
- Needless damage from road hazards

## When to Check

Check your tires once a month or more.

Don't forget your compact spare tire. It should be at 60 psi (420 kPa).

## How to Check

Use a good quality pocket-type gage to check tire pressure. You can't tell if your tires are properly inflated simply by looking at them. Radial tires may look properly inflated even when they're underinflated.

Be sure to put the valve caps back on the valve stems. They help prevent leaks by keeping out dirt and moisture.

## Tire Inspection and Rotation

Tires should be rotated every 7,500 miles (12 500 km).

Any time you notice unusual wear, rotate your tires as soon as possible and check wheel alignment. Also check for damaged tires or wheels. See *When It Is Time for New Tires* on page 5-70 and *Wheel Replacement* on page 5-73 for more information.

The purpose of regular rotation is to achieve more uniform wear for all tires on the vehicle. The first rotation is the most important. See "Part A: Scheduled Maintenance Services," in Section 6, for scheduled rotation intervals.

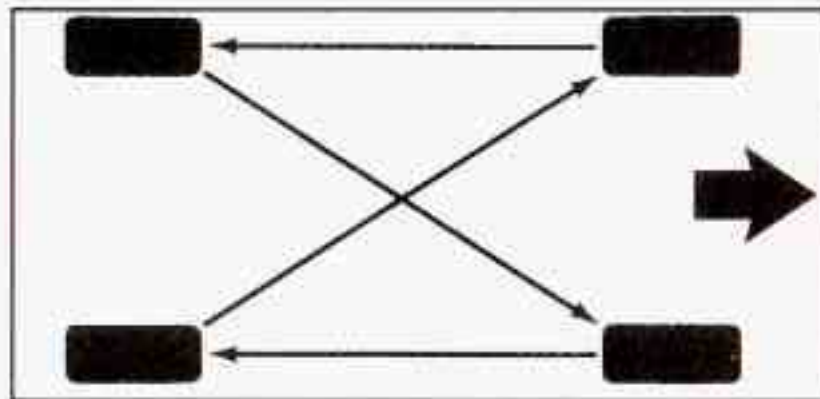

When rotating your tires, always use the correct rotation pattern shown here.

Don't include the compact spare tire in your tire rotation.

After the tires have been rotated, adjust the front and rear inflation pressures as shown on the Tire-Loading Information label. Make certain that all wheel nuts are properly tightened. See "Wheel Nut Torque" under *Capacities and Specifications* on page 5-102.

### CAUTION:

Rust or dirt on a wheel, or on the parts to which it is fastened, can make wheel nuts become loose after a time. The wheel could come off and cause an accident. When you change a wheel, remove any rust or dirt from places where the wheel attaches to the vehicle. In an emergency, you can use a cloth or a paper towel to do this; but be sure to use a scraper or wire brush later, if you need to, to get all the rust or dirt off. See "Changing a Flat Tire" in the Index.

## When It Is Time for New Tires

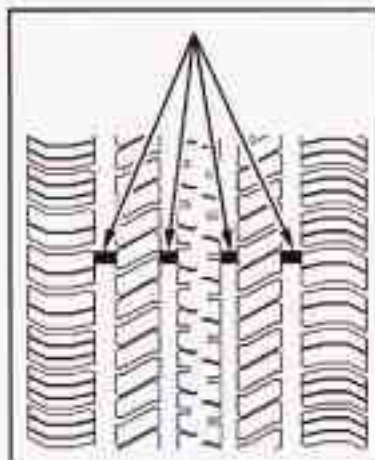

One way to tell when it's time for new tires is to check the treadwear indicators, which will appear when your tires have only 1/16 inch (1.6 mm) or less of tread remaining.

You need a new tire if any of the following statements are true:

- You can see the indicators at three or more places around the tire.
- You can see cord or fabric showing through the tire's rubber.
- The tread or sidewall is cracked, cut or snagged deep enough to show cord or fabric.

- The tire has a bump, bulge or split.
- The tire has a puncture, cut or other damage that can't be repaired well because of the size or location of the damage.

## Buying New Tires

To find out what kind and size of tires you need, look at the Tire-Loading Information label.

The tires installed on your vehicle when it was new had a Tire Performance Criteria Specification (TPC Spec) number on each tire's sidewall. When you get new tires, get ones with that same TPC Spec number. That way your vehicle will continue to have tires that are designed to give proper endurance, handling, speed rating, traction, ride and other things during normal service on your vehicle. If your tires have an all-season tread design, the TPC number will be followed by an "MS" (for mud and snow).

If you ever replace your tires with those not having a TPC Spec number, make sure they are the same size, load range, speed rating and construction type (bias, bias-belted or radial) as your original tires.

### CAUTION:

Mixing tires could cause you to lose control while driving. If you mix tires of different sizes or types (radial and bias-belted tires), the vehicle may not handle properly, and you could have a crash. Using tires of different sizes may also cause damage to your vehicle. Be sure to use the same size and type tires on all wheels. It's all right to drive with your compact spare temporarily, it was developed for use on your vehicle. See "Compact Spare Tire" in the index.

### CAUTION:

If you use bias-ply tires on your vehicle, the wheel rim flanges could develop cracks after many miles of driving. A tire and/or wheel could fail suddenly, causing a crash. Use only radial-ply tires with the wheels on your vehicle.



## Uniform Tire Quality Grading

Quality grades can be found where applicable on the tire sidewall between tread shoulder and maximum section width. For example:

### **Treadwear 200 Traction AA Temperature A**

The following information relates to the system developed by the United States National Highway Traffic Safety Administration, which grades tires by treadwear, traction and temperature performance. (This applies only to vehicles sold in the United States.)

The grades are molded on the sidewalls of most passenger car tires. The Uniform Tire Quality Grading system does not apply to deep tread, winter-type snow tires, space-saver or temporary use spare tires, tires with nominal rim diameters of 10 to 12 inches (25 to 30 cm), or to some limited-production tires.

While the tires available on General Motors passenger cars and light trucks may vary with respect to these grades, they must also conform to federal safety requirements and additional General Motors Tire Performance Criteria (TPC) standards.

## Treadwear

The treadwear grade is a comparative rating based on the wear rate of the tire when tested under controlled conditions on a specified government test course. For example, a tire graded 150 would wear one and a half (1.5) times as well on the government course as a tire graded 100. The relative performance of tires depends upon the actual conditions of their use, however, and may depart significantly from the norm due to variations in driving habits, service practices and differences in road characteristics and climate.

### **Traction – AA, A, B, C**

The traction grades, from highest to lowest, are AA, A, B, and C. Those grades represent the tire's ability to stop on wet pavement as measured under controlled conditions on specified government test surfaces of asphalt and concrete. A tire marked C may have poor traction performance. Warning: The traction grade assigned to this tire is based on straight-ahead braking traction tests, and does not include acceleration, cornering, hydroplaning, or peak traction characteristics.

## Temperature – A, B, C

The temperature grades are A (the highest), B, and C, representing the tire's resistance to the generation of heat and its ability to dissipate heat when tested under controlled conditions on a specified indoor laboratory test wheel. Sustained high temperature can cause the material of the tire to degenerate and reduce tire life, and excessive temperature can lead to sudden tire failure. The grade C corresponds to a level of performance which all passenger car tires must meet under the Federal Motor Vehicle Safety Standard No. 109. Grades B and A represent higher levels of performance on the laboratory test wheel than the minimum required by law.

**Warning:** The temperature grade for this tire is established for a tire that is properly inflated and not overloaded. Excessive speed, underinflation, or excessive loading, either separately or in combination, can cause heat buildup and possible tire failure.

## Wheel Alignment and Tire Balance

The wheels on your vehicle were aligned and balanced carefully at the factory to give you the longest tire life and best overall performance.

Scheduled wheel alignment and wheel balancing are not needed. However, if you notice unusual tire wear or your vehicle pulling one way or the other, the alignment may need to be reset. If you notice your vehicle vibrating when driving on a smooth road, your wheels may need to be rebalanced.

## Wheel Replacement

Replace any wheel that is bent, cracked or badly rusted or corroded. If wheel nuts keep coming loose, the wheel, wheel bolts and wheel nuts should be replaced. If the wheel leaks air, replace it (except some aluminum wheels, which can sometimes be repaired). See your dealer if any of these conditions exist.

Your dealer will know the kind of wheel you need.

Each new wheel should have the same load-carrying capacity, diameter, width, offset and be mounted the same way as the one it replaces.

If you need to replace any of your wheels, wheel bolts or wheel nuts, replace them only with new GM original equipment parts. This way, you will be sure to have the right wheel, wheel bolts and wheel nuts for your vehicle.

 **CAUTION:**

Using the wrong replacement wheels, wheel bolts or wheel nuts on your vehicle can be dangerous. It could affect the braking and handling of your vehicle, make your tires lose air and make you lose control. You could have a collision in which you or others could be injured. Always use the correct wheel, wheel bolts and wheel nuts for replacement.

**Notice:** The wrong wheel can also cause problems with bearing life, brake cooling, speedometer or odometer calibration, headlamp aim, bumper height, vehicle ground clearance and tire or tire chain clearance to the body and chassis.

See *Changing a Flat Tire* on page 5-76 for more information.

## Used Replacement Wheels

 **CAUTION:**

Putting a used wheel on your vehicle is dangerous. You can't know how it's been used or how far it's been driven. It could fail suddenly and cause a crash. If you have to replace a wheel, use a new GM original equipment wheel.

## Tire Chains

### CAUTION:

If your vehicle is an SE model with P225/60R16 size tires, don't use tire chains, there's not enough clearance.

Tire chains used on a vehicle without the proper amount of clearance can cause damage to the brakes, suspension or other vehicle parts. The area damaged by the tire chains could cause you to lose control of your vehicle and you or others may be injured in a crash.

Use another type of traction device only if its manufacturer recommends it for use on your vehicle and tire size combination and road conditions. Follow that manufacturer's

CAUTION: (Continued)

### CAUTION: (Continued)

instructions. To help avoid damage to your vehicle, drive slowly, readjust or remove the device if it's contacting your vehicle, and don't spin your wheels.

If you do find traction devices that will fit, install them on the front tires.

*Notice:* If your vehicle is a GT model, a GTP model, or if you have an SE model without P225/60R16 size tires, use tire chains only where legal and only when you must. Use only SAE Class "S" type chains that are the proper size for your tires. Install them on the front tires and tighten them as tightly as possible with the ends securely fastened. Drive slowly and follow the chain manufacturer's instructions. If you can hear the chains contacting your vehicle, stop and retighten them. If the contact continues, slow down until it stops. Driving too fast or spinning the wheels with chains on will damage your vehicle.

## If a Tire Goes Flat

It's unusual for a tire to "blow out" while you're driving, especially if you maintain your tires properly. If air goes out of a tire, it's much more likely to leak out slowly. But if you should ever have a "blowout", here are a few tips about what to expect and what to do:

If a front tire fails, the flat tire will create a drag that pulls the vehicle toward that side. Take your foot off the accelerator pedal and grip the steering wheel firmly. Steer to maintain lane position, and then gently brake to a stop well out of the traffic lane.

A rear blowout, particularly on a curve, acts much like a skid and may require the same correction you'd use in a skid. In any rear blowout, remove your foot from the accelerator pedal. Get the vehicle under control by steering the way you want the vehicle to go. It may be very bumpy and noisy, but you can still steer. Gently brake to a stop — well off the road if possible.

If a tire goes flat, the next part shows how to use your jacking equipment to change a flat tire safely.

## Changing a Flat Tire

If a tire goes flat, avoid further tire and wheel damage by driving slowly to a level place. Turn on your hazard warning flashers.

### CAUTION:

**Changing a tire can cause an injury. The vehicle can slip off the jack and roll over you or other people. You and they could be badly injured. Find a level place to change your tire. To help prevent the vehicle from moving:**

- 1. Set the parking brake firmly.**
- 2. Put the shift lever in PARK (P).**
- 3. Turn off the engine.**

**To be even more certain the vehicle won't move, you can put blocks at the front and rear of the tire farthest away from the one being changed. That would be the tire on the other side of the vehicle, at the opposite end.**

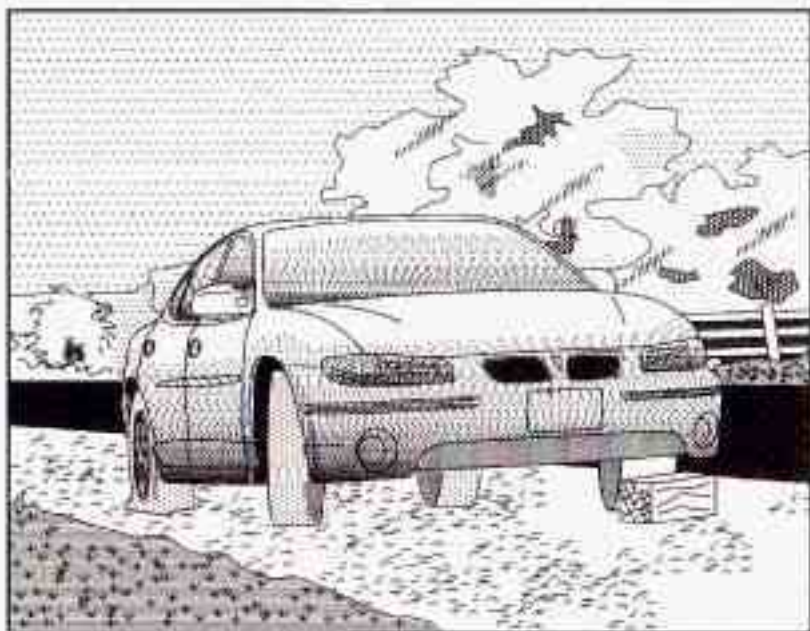

The following steps will tell you how to use the jack and change a tire.

## Removing the Spare Tire and Tools

The equipment you'll need is in the trunk.

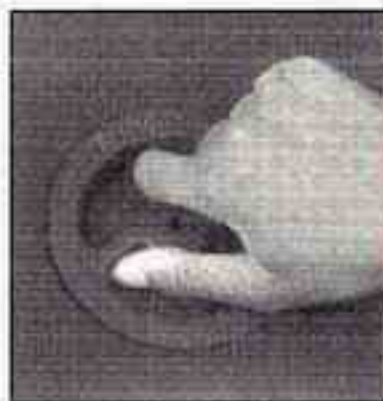

1. Turn the center nut on the compact spare tire cover counterclockwise to remove it.

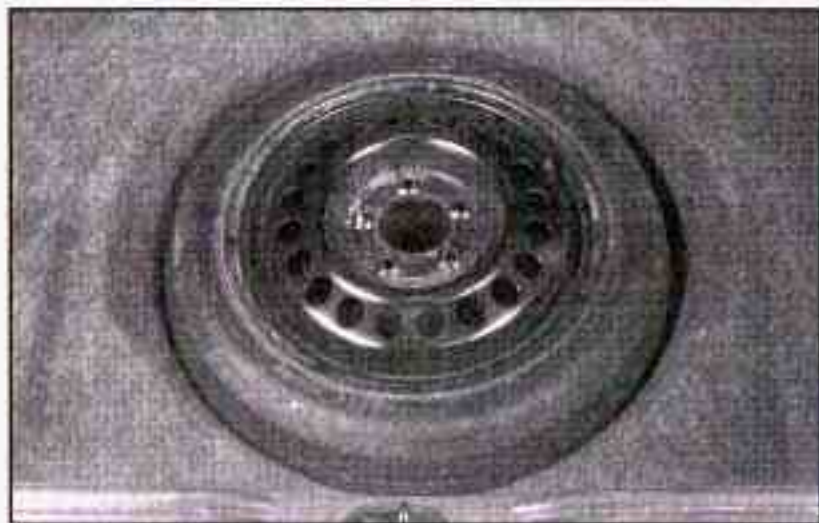

2. Remove the compact spare tire. See *Compact Spare Tire* on page 5-87 for more information about the compact spare tire.

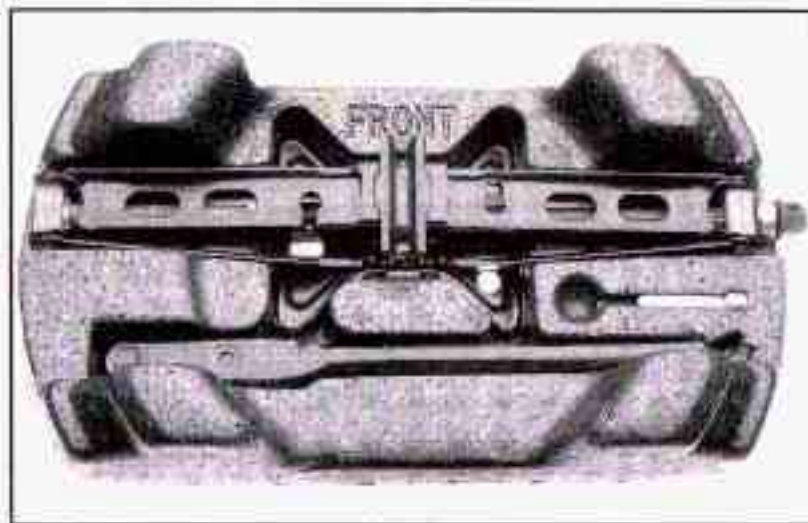

3. Turn the nut holding the jack counterclockwise and remove it. Then remove the jack and wrench.

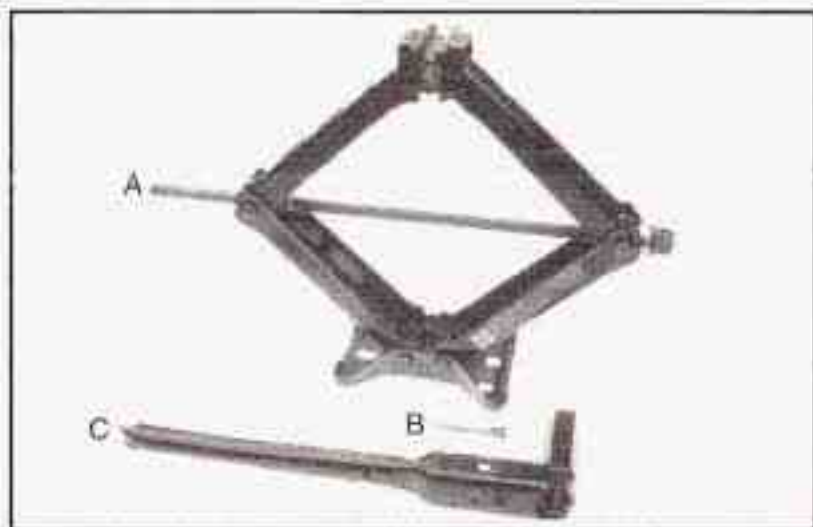

4. The tools you'll be using include the jack (A) extension and protector/guide (B) and the wheel wrench (C).

## Removing Wheel Covers and Wheel Nut Caps

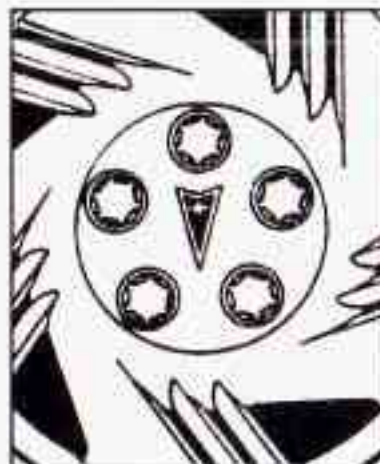

If there is a wheel cover, loosen the plastic nut caps with the wheel wrench. They won't come off. Then, using the flat end of the wheel wrench, pry along the edge of the cover until it comes off.



## Removing the Flat Tire and Installing the Spare Tire

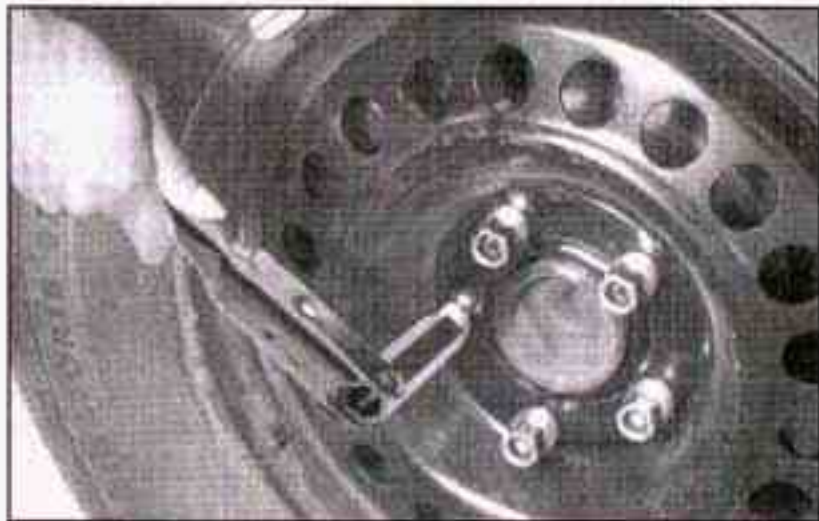

1. Using the wheel wrench, loosen all the wheel nuts. Don't remove them yet.
2. Turn the jack handle clockwise to raise the vehicle. Raise the vehicle far enough off the ground for the spare tire to fit underneath the wheel well.

### CAUTION:

Getting under a vehicle when it is jacked up is dangerous. If the vehicle slips off the jack you could be badly injured or killed. Never get under a vehicle when it is supported only by a jack.

### CAUTION:

Raising your vehicle with the jack improperly positioned can damage the vehicle and even make the vehicle fall. To help avoid personal injury and vehicle damage, be sure to fit the jack lift head into the proper location before raising the vehicle.

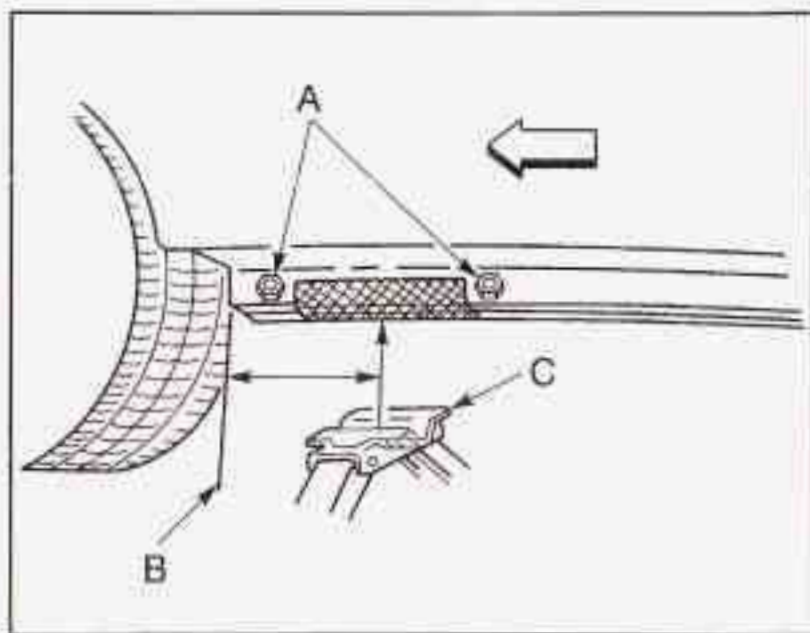

For jacking at the vehicle's front location, put the jack lift head (C) about 6 inches (15 cm) from the rear edge of the front wheel opening (B) or between the two bolts (A) as shown.

Put the compact spare tire near you.

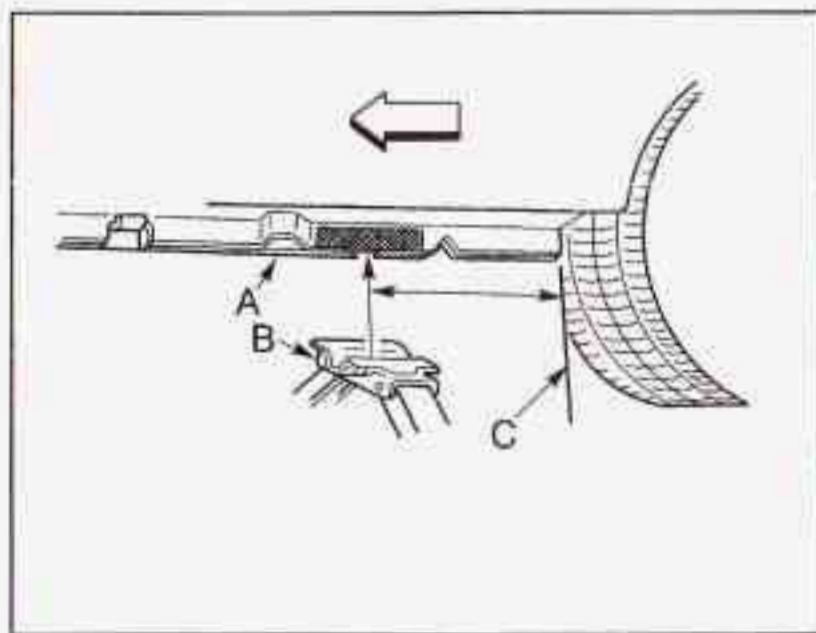

For jacking at the vehicle's rear location, put the jack lift head (B) about 5.5 inches (14 cm) from the front edge of the rear wheel opening (C) or just behind the off-set (A) as shown.

Put the compact spare tire near you.

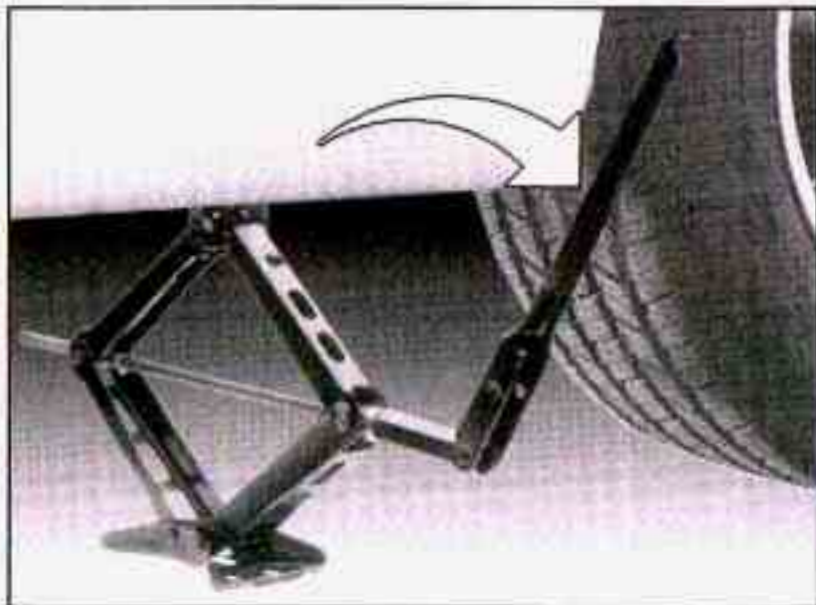

3. Raise the vehicle by turning the jack handle clockwise. Raise the vehicle far enough off the ground for the spare tire to fit underneath the wheel well. Remove all wheel nuts and take off the flat tire.

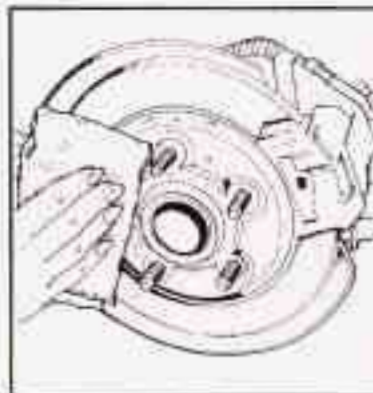

4. Remove any rust or dirt from the wheel bolts, mounting surfaces and spare wheel.

**⚠ CAUTION:**

Rust or dirt on the wheel, or on the parts to which it is fastened, can make the wheel nuts become loose after a time. The wheel could come off and cause an accident. When you change a wheel, remove any rust or dirt from the places where the wheel attaches to the vehicle. In an emergency, you can use a cloth or a paper towel to do this; but be sure to use a scraper or wire brush later, if you need to, to get all the rust or dirt off.

**⚠ CAUTION:**

Never use oil or grease on studs or nuts. If you do, the nuts might come loose. Your wheel could fall off, causing a serious accident.

5. Place the spare on the wheel mounting surface.



6. Reinstall the wheel nuts with the rounded end of the nuts toward the wheel. Tighten each nut by hand until the wheel is held against the hub.

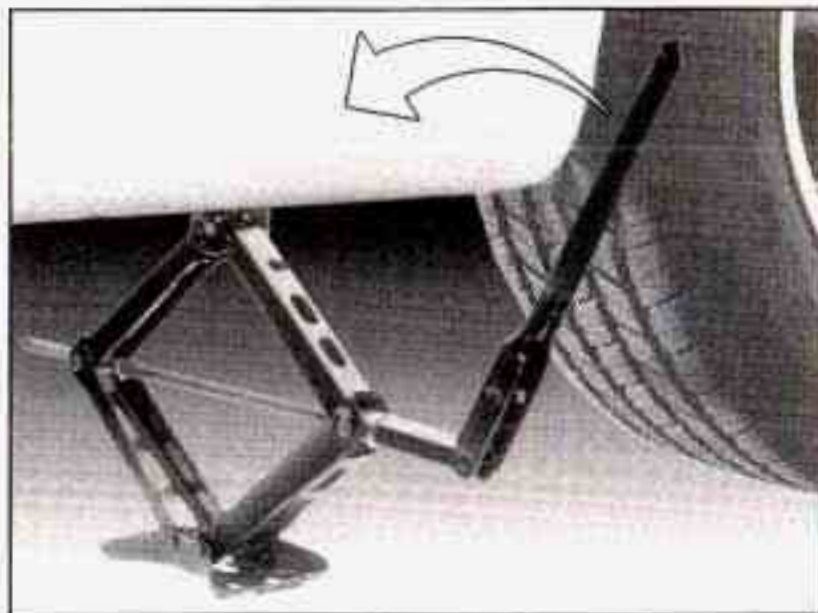

7. Lower the vehicle by turning the jack handle counterclockwise. Lower the jack completely.

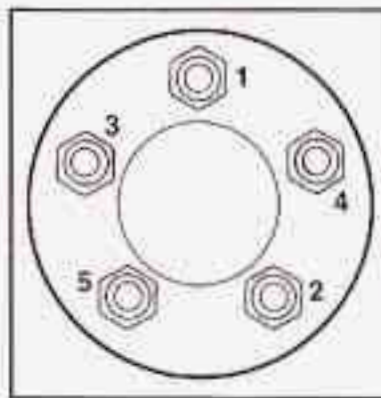

8. Tighten the wheel nuts firmly in a crisscross sequence as shown.

9. Reinstall the wheel trim. If the vehicle has plastic caps tighten them by hand. With a wheel wrench, tighten the plastic caps an additional quarter turn clockwise.

**⚠ CAUTION:**

Incorrect wheel nuts or improperly tightened wheel nuts can cause the wheel to come loose and even come off. This could lead to an accident. Be sure to use the correct wheel nuts. If you have to replace them, be sure to get new GM original equipment wheel nuts. Stop somewhere as soon as you can and have the nuts tightened with a torque wrench to the proper torque specification. See "Capacities and Specifications" in the Index for wheel nut torque specification.

**Notice:** Improperly tightened wheel nuts can lead to brake pulsation and rotor damage. To avoid expensive brake repairs, evenly tighten the wheel nuts in the proper sequence and to the proper torque specification. See "Capacities and Specifications" in the index for the wheel nut torque specification.

10. Don't try to put the wheel cover on your compact spare tire. It won't fit. Store the wheel cover in the trunk until you have the flat tire repaired or replaced.

**Notice:** Wheel covers won't fit on your compact spare. If you try to put a wheel cover on your compact spare, you could damage the cover or the spare.

## Storing the Flat Tire and Tools

### **⚠ CAUTION:**

Storing a jack, a tire, or other equipment in the passenger compartment of the vehicle could cause injury. In a sudden stop or collision, loose equipment could strike someone. Store all these in the proper place.

After you've put the compact spare tire on your vehicle, you'll need to store the flat tire in the trunk. Use the following procedure to secure the flat tire in the trunk.



When storing a full-size tire, you must use the extension to help avoid wheel surface damage. Use the extension and protector/guide located in the foam holder. To store a full-size tire, place the tire in the trunk valve stem facing down, with the protector/guide placed through a wheel bolt hole. Remove the protector and attach the retainer securely. When putting the compact spare back in the trunk, place the protector/guide back in the foam holder. Store the cover as far forward as possible.

## Storing the Spare Tire and Tools

### **⚠ CAUTION:**

Storing a jack, a tire, or other equipment in the passenger compartment of the vehicle could cause injury. In a sudden stop or collision, loose equipment could strike someone. Store all these in the proper place.

## Compact Spare Tire

The compact spare tire is for temporary use only. Replace the compact spare tire with a full-size tire as soon as you can. See *Compact Spare Tire* on page 5-87. See the storage instructions label on the trunk lid to properly position your compact spare tire in the trunk.

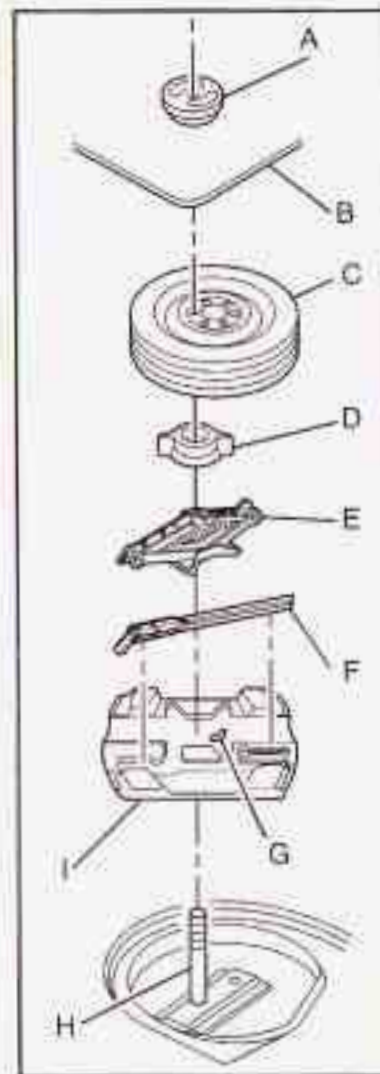

- A. Retainer
- B. Cover
- C. Compact Spare Tire
- D. Nut
- E. Jack
- F. Wheel Wrench
- G. Extension and Protective Guide
- H. Bolt Screw
- I. Foam Holder

## Compact Spare Tire

Although the compact spare tire was fully inflated when your vehicle was new, it can lose air after a time. Check the inflation pressure regularly. It should be 60 psi (420 kPa).

After installing the compact spare on your vehicle, you should stop as soon as possible and make sure your spare tire is correctly inflated. The compact spare is made to perform well at speeds up to 65 mph (105 km/h) for distances up to 3,000 miles (5 000 km), so you can finish your trip and have your full-size tire repaired or replaced where you want. Of course, it's best to replace your spare with a full-size tire as soon as you can. Your spare will last longer and be in good shape in case you need it again.

**Notice:** When the compact spare is installed, don't take your vehicle through an automatic car wash with guide rails. The compact spare can get caught on the rails. That can damage the tire and wheel, and maybe other parts of your vehicle.

Don't use your compact spare on other vehicles.

And don't mix your compact spare tire or wheel with other wheels or tires. They won't fit. Keep your spare tire and its wheel together.

**Notice:** Tire chains won't fit your compact spare. Using them can damage your vehicle and can damage the chains too. Don't use tire chains on your compact spare.



## Appearance Care

Remember, cleaning products can be hazardous. Some are toxic. Others can burst into flames if you strike a match or get them on a hot part of the vehicle. Some are dangerous if you breathe their fumes in a closed space. When you use anything from a container to clean your vehicle, be sure to follow the manufacturer's warnings and instructions. And always open your doors or windows when you're cleaning the inside.

*Never* use these to clean your vehicle:

- Gasoline
- Benzene
- Naphtha
- Carbon Tetrachloride
- Acetone
- Paint Thinner
- Turpentine
- Lacquer Thinner
- Nail Polish Remover

They can all be hazardous — some more than others — and they can all damage your vehicle, too.

Don't use any of these unless this manual says you can. In many uses, these will damage your vehicle:

- Alcohol
- Laundry Soap
- Bleach
- Reducing Agents

## Cleaning the Inside of Your Vehicle

Use a vacuum cleaner often to get rid of dust and loose dirt. Wipe vinyl, leather, plastic and painted surfaces with a clean, damp cloth.

### Fabric/Carpet

Your dealer has cleaners for the cleaning of fabric and carpet. They will clean normal spots and stains very well.

You can get GM – approved cleaning products from your dealer. See *GM Vehicle Care/Appearance Materials* on page 5-94.

Here are some cleaning tips:

- Always read the instructions on the cleaner label.
- Clean up stains as soon as you can – before they set.
- Carefully scrape off any excess stain.
- Use a clean cloth or sponge, and change to a clean area often. A soft brush may be used if stains are stubborn.
- If a ring forms on fabric after spot cleaning, clean the entire area immediately or it will set.

## Using Cleaner on Fabric

1. Vacuum and brush the area to remove any loose dirt.
2. Always clean a whole trim panel or section. Mask surrounding trim along stitch or welt lines.
3. Follow the directions on the container label.
4. Apply cleaner with a clean sponge. Don't saturate the material and don't rub it roughly.
5. As soon as you've cleaned the section, use a sponge to remove any excess cleaner.
6. Wipe cleaned area with a clean, water-dampened towel or cloth.
7. Wipe with a clean cloth and let dry.

## Special Fabric Cleaning Problems

Stains caused by such things as catsup, coffee (black), egg, fruit, fruit juice, milk, soft drinks, vomit, urine and blood can be removed as follows:

1. Carefully scrape off excess stain, then sponge the soiled area with cool water.
2. If a stain remains, follow the cleaner instructions described earlier.
3. If an odor lingers after cleaning vomit or urine, treat the area with a water/baking soda solution: 1 teaspoon (5 ml) of baking soda to 1 cup (250 ml) of lukewarm water.
4. Let dry.

Stains caused by candy, ice cream, mayonnaise, chili sauce and unknown stains can be removed as follows:

1. Carefully scrape off excess stain.
2. Clean with cool water and allow to dry completely.
3. If a stain remains, follow the cleaner instructions described earlier.

## Vinyl

Use warm water and a clean cloth.

- Rub with a clean, damp cloth to remove dirt. You may have to do this more than once.
- Things like tar, asphalt and shoe polish will stain if you don't get them off quickly. Use a clean cloth and vinyl/leather cleaner. See your dealer for this product.

## Leather

Use a soft cloth with lukewarm water and a mild soap or saddle soap and wipe dry with a soft cloth. Then, let the leather dry naturally. Do not use heat to dry.

- For stubborn stains, use a leather cleaner. See your dealer for this product.
- *Never* use oils, varnishes, solvent-based or abrasive cleaners, furniture polish or shoe polish on leather.
- Soiled or stained leather should be cleaned immediately. If dirt is allowed to work into the finish, it can harm the leather.

## Top of the Instrument Panel

Use only mild soap and water to clean the top surfaces of the instrument panel. Sprays containing silicones or waxes may cause annoying reflections in the windshield and even make it difficult to see through the windshield under certain conditions.

## Interior Plastic Components

Use only a mild soap and water solution on a soft cloth or sponge. Commercial cleaners may affect the surface finish.

## Glass Surfaces

Glass should be cleaned often. GM Glass Cleaner or a liquid household glass cleaner will remove normal tobacco smoke and dust films on interior glass. See *GM Vehicle Care/Appearance Materials* on page 5-94.

**Notice:** Don't use abrasive cleaners on glass, because they may cause scratches. Avoid placing decals on the inside rear window, since they may have to be scraped off later. If abrasive cleaners are used on the inside of the rear window, an electric defogger element may be damaged. Any temporary license should not be attached across the defogger grid.

## Care of Safety Belts

Keep belts clean and dry.

### CAUTION:

Do not bleach or dye safety belts. If you do, it may severely weaken them. In a crash, they might not be able to provide adequate protection. Clean safety belts only with mild soap and lukewarm water.

## Weatherstrips

Silicone grease on weatherstrips will make them last longer, seal better, and not stick or squeak. Apply silicone grease with a clean cloth at least every six months. During very cold, damp weather more frequent application may be required. See *Part D: Recommended Fluids and Lubricants* on page 6-15.

## Cleaning the Outside of Your Vehicle

The paint finish on your vehicle provides beauty, depth of color, gloss retention and durability.

### Washing Your Vehicle

The best way to preserve your vehicle's finish is to keep it clean by washing it often with lukewarm or cold water.

Don't wash your vehicle in the direct rays of the sun. Use a car washing soap. Don't use strong soaps or chemical detergents. Be sure to rinse the vehicle well, removing all soap residue completely. You can get GM-approved cleaning products from your dealer. See *GM Vehicle Care/Appearance Materials* on page 5-94. Don't use cleaning agents that are petroleum based, or that contain acid or abrasives. All cleaning agents should be flushed promptly and not allowed to dry on the surface, or they could stain. Dry the finish with a soft, clean chamois or an all-cotton towel to avoid surface scratches and water spotting.

High pressure car washes may cause water to enter your vehicle.

## Cleaning Exterior Lamps/Lenses

Use only lukewarm or cold water, a soft cloth and a car washing soap to clean exterior lamps and lenses. Follow instructions under "Washing Your Vehicle."

## Finish Care

Occasional waxing or mild polishing of your vehicle by hand may be necessary to remove residue from the paint finish. You can get GM-approved cleaning products from your dealer. See *GM Vehicle Care/Appearance Materials* on page 5-94.

Your vehicle has a "basecoat/clearcoat" paint finish. The clearcoat gives more depth and gloss to the colored basecoat. Always use waxes and polishes that are non-abrasive and made for a basecoat/clearcoat paint finish.

**Notice:** Machine compounding or aggressive polishing on a basecoat/clearcoat paint finish may dull the finish or leave swirl marks.

Foreign materials such as calcium chloride and other salts, ice melting agents, road oil and tar, tree sap, bird droppings, chemicals from industrial chimneys, etc., can damage your vehicle's finish if they remain on painted surfaces. Wash the vehicle as soon as

possible. If necessary, use non-abrasive cleaners that are marked safe for painted surfaces to remove foreign matter.

Exterior painted surfaces are subject to aging, weather and chemical fallout that can take their toll over a period of years. You can help to keep the paint finish looking new by keeping your vehicle garaged or covered whenever possible.

## Windshield and Wiper Blades

If the windshield is not clear after using the windshield washer, or if the wiper blade chatters when running, wax, sap or other material may be on the blade or windshield.

Clean the outside of the windshield with a full-strength glass cleaning liquid. The windshield is clean if beads do not form when you rinse it with water.

Grime from the windshield will stick to the wiper blades and affect their performance. Clean the blade by wiping vigorously with a cloth soaked in full-strength windshield washer solvent. Then rinse the blade with water.

Check the wiper blades and clean them as necessary; replace blades that look worn.

## Aluminum or Chrome Plated Wheels

Keep your wheels clean using a soft clean cloth with mild soap and water. Rinse with clean water. After rinsing thoroughly, dry with a soft clean towel. A wax may then be applied.

The surface of these wheels is similar to the painted surface of your vehicle. Don't use strong soaps, chemicals, abrasive polishes, abrasive cleaners, cleaners with acid, or abrasive cleaning brushes on them because you could damage the surface. Do not use chrome polish on aluminum wheels.

Don't take your vehicle through an automatic car wash that has silicone carbide tire cleaning brushes. These brushes can also damage the surface of these wheels.

## Tires

To clean your tires, use a stiff brush with tire cleaner.

**Notice:** When applying a tire dressing, always take care to wipe off any overspray or splash from all painted surfaces on the body or wheels of the vehicle. Petroleum-based products may damage the paint finish and tires.

## Sheet Metal Damage

If your vehicle is damaged and requires sheet metal repair or replacement, make sure the body repair shop applies anti-corrosion material to parts repaired or replaced to restore corrosion protection.

Original manufacturer replacement parts will provide the corrosion protection while maintaining the warranty.

## Finish Damage

Any stone chips, fractures or deep scratches in the finish should be repaired right away. Bare metal will corrode quickly and may develop into major repair expense.

Minor chips and scratches can be repaired with touch-up materials available from your dealer or other service outlets. Larger areas of finish damage can be corrected in your dealer's body and paint shop.

## Underbody Maintenance

Chemicals used for ice and snow removal and dust control can collect on the underbody. If these are not removed, accelerated corrosion (rust) can occur on the underbody parts such as fuel lines, frame, floor pan and exhaust system even though they have corrosion protection.

At least every spring, flush these materials from the underbody with plain water. Clean any areas where mud and debris can collect. Dirt packed in close areas of the frame should be loosened before being flushed. Your dealer or an underbody car washing system can do this for you.

## Chemical Paint Spotting

Some weather and atmospheric conditions can create a chemical fallout. Airborne pollutants can fall upon and attack painted surfaces on your vehicle. This damage can take two forms: blotchy, ringlet-shaped discolorations, and small irregular dark spots etched into the paint surface.

Although no defect in the paint job causes this, GM will repair, at no charge to the owner, the surfaces of new vehicles damaged by this fallout condition within 12 months or 12,000 miles (20 000 km) of purchase, whichever occurs first.

## GM Vehicle Care/Appearance Materials

See your GM dealer for more information on purchasing the following products.

### GM Vehicle Care/Appearance Materials

Description	Usage
Polishing Cloth Wax – Treated	Interior and exterior polishing cloth.
Tar and Road Oil Remover	Removes tar, road oil and asphalt.
Chrome Cleaner and Polish	Use on chrome or stainless steel.
White Sidewall Tire Cleaner	Removes soil and black marks from whitewalls.
Vinyl Cleaner	Cleans vinyl tops, upholstery and convertible tops.
Glass Cleaner	Removes dirt, grime, smoke and fingerprints.

## GM Vehicle Care/Appearance Materials (cont'd)

Description	Usage
Chrome and Wire Wheel Cleaner	Removes dirt and grime from chrome wheels and wire wheel covers.
Finish Enhancer	Removes dust, fingerprints, and surface contaminants. Spray on wipe off.
Swirl Remover Polish	Removes swirl marks, fine scratches and other light surface contamination.
Cleaner Wax	Removes light scratches and protects finish.
Foaming Tire Shine Low Gloss	Cleans, shines and protects in one easy step, no wiping necessary.

## GM Vehicle Care/Appearance Materials (cont'd)

Description	Usage
Wash Wax Concentrate	Medium foaming shampoo. Cleans and lightly waxes. Biodegradable and phosphate free.
Spot Lifter	Quickly and easily removes spots and stains from carpets, vinyl and cloth upholstery.
Odor Eliminator	Odorless spray odor eliminator used on fabrics, vinyl, leather and carpet.
See your General Motors parts department for these products. See <i>Part D: Recommended Fluids and Lubricants</i> on page 6-15.	



## Vehicle Identification

### Vehicle Identification Number (VIN)



This is the legal identifier for your vehicle. It appears on a plate in the front corner of the instrument panel, on the driver's side. You can see it if you look through the windshield from outside your vehicle. The VIN also appears on the Vehicle Certification and Service Parts labels and the certificates of title and registration.

### Engine Identification

The 8th character in your VIN is the engine code. This code will help you identify your engine, specifications and replacement parts.

## Service Parts Identification Label

You'll find this label on the inside of your trunk lid. It's very helpful if you ever need to order parts. On this label is:

- your VIN,
- the model designation,
- paint information and
- a list of all production options and special equipment.

Be sure that this label is not removed from the vehicle.

## Electrical System

### Add-On Electrical Equipment

**Notice:** Don't add anything electrical to your vehicle unless you check with your dealer first. Some electrical equipment can damage your vehicle and the damage wouldn't be covered by your warranty. Some add-on electrical equipment can keep other components from working as they should.

Your vehicle has an air bag system. Before attempting to add anything electrical to your vehicle, see *Servicing Your Air Bag-Equipped Vehicle* on page 1-57.

### Headlamp Wiring

The headlamp circuit is protected by individual fuses in the underhood fuse block. An electrical overload will cause the fuse to blow. If this happens, have your headlamp system checked right away.

### Windshield Wiper Fuses

The windshield wiper motor is protected by a circuit breaker and a fuse. If the motor overheats due to heavy snow, etc., the wiper will stop until the motor cools. If the overload is caused by some electrical problem, have it fixed.

## Power Windows and Other Power Options

Circuit breakers in the fuse panel protect the power windows and other power accessories. When the current load is too heavy, the circuit breaker opens and closes, protecting the circuit until the problem is fixed.

## Fuses and Circuit Breakers

The wiring circuits in your vehicle are protected from short circuits by a combination of fuses, circuit breakers and fusible thermal links in the wiring itself. This greatly reduces the chance of fires caused by electrical problems.

Look at the silver-colored band inside the fuse. If the band is broken or melted, replace the fuse. Be sure you replace a bad fuse with a new one of the identical size and rating. See *Underhood Fuse Block* later in this section.

## Instrument Panel Fuse Block



Some fuses are in a fuse block located inside of the glove box behind a small bin on the right side. To open, pull the cover out. The fuse block is inside. On the back edge of this cover is a fuse usage chart.

To reinstall the bin, position the lower end and turn the top into position. Press on the sides until it snaps into place.

FUSE USAGE CHART					
CIRCUIT BREAKERS			MALL PDM	MALL	WIPER
HEADLAMP	STR WHL ELUM		STR WHL CTRL	SUNROOF	RADIO
		RADIO AMP	PWR LOCK	HSEAT/LUM	R DEFOG
SEAT	PASSKEY III	BAP	HAZARD	PWR MRR	HVAC HI
	CIG LTR	INT LAMP	STOP LAMP	ONSTAR	
	ECM	CRUISE	IP-IGN	SIR	TURN
PWR WDO					BTSI
				HVAC CTRL	DIC/HVAC
			PWR DRCP	CANISTER VENT	DRL
For More Information, See Owner's Manual					

Circuit Breakers	Usage
HEADLAMP	Headlamps
SEAT	Power Seat, Power Lumbar
BLANK	Blank
PWR WDO	Power Windows
BLANK	Blank
BLANK	Blank
BLANK	Blank

<b>Circuit Breakers</b>	<b>Usage</b>
MALL PGM	Mall Module – Program
MALL	Mall Module
WIPER	Wipers
STR WHL ILLUM	Steering Wheel Illumination
BLANK	Blank
STR WHL CTRL	Steering Wheel Control
SUNROOF	Sunroof
RADIO	Radio
BLANK	Blank
RADIO AMP	Bose Amplifier
PWR LOCK	Mall Module – Power Locks
HSEAT/LUM	Heated Seats, Power Lumbar
R DEFOG	Rear Window Defogger
PASS KEY III	PASS-Key <sup>®</sup> III Security System
RAP	Retained Accessory Power
HAZARD	Hazard Flashers
PWR MIR	Power Mirrors
HVAC HI	HVAC Blower – HI
CIG LT	Cigarette Lighter, DLC, Floor Console Accessory Outlet
INT LAMP	Mall Module – Interior Lamps
STOP LAMP	Stoptlamp

<b>Circuit Breakers</b>	<b>Usage</b>
ONSTAR	OnStar <sup>®</sup> System
BLANK	Blank
ECM	Electronic Control Module
CRUISE	Cruise Control
I/P-IGN	Chime/Mall Module, Cluster, Trip Computer, Head-Up Display, Automatic Transaxle Shift Lock Control
SIR	Supplemental Inflatable Restraint (Air Bag)
TURN	Turn Signal
BLANK	Blank
BLANK	Blank
BLANK	Blank
BLANK	Blank
BTSI	Automatic Transaxle Shift Lock Control
BLANK	Blank
BLANK	Blank
BLANK	Blank
HVAC CTRL	Blower Control, HVAC
DIC/HVAC	Rear Defog, HVAC, Driver Information Center, Daytime Running Lamps, Heated Seats
BLANK	Blank

Circuit Breakers	Usage
BLANK	Blank
PWR DROP	Power Drop Ignition
CANISTER VENT	Canister Vent Solenoid
DRL	Daytime Running Lamps

## Underhood Fuse Block



Some fuses are located in a fuse block in the engine compartment on the passenger's side. Unscrew the bolt in the center of the fuse block cover and remove the cover.

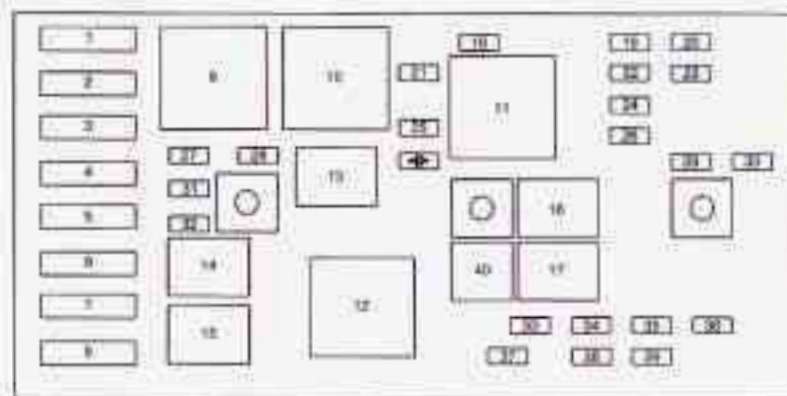

Fuses	Usage
1	Cooling Fan 2
2	Spare
3	Headlamps
4	Battery Main 2
5	Ignition Main 1
6	Cooling Fan 1
7	Battery Main 1
8	Ignition Main 2
18	Fuel Injections
19	Spare
20	Spare

Fuses	Usage
21	Mass Air Flow (MAF), Heated Sensors, Canister Purge, Boost Solenoid
22	Spare
23	Spare
24	Spare
25	Ignition Module
26	Spare
27	Trunk Release, Back-Up Lamps
28	AC Clutch, ABS Ignition
29	Remote Keyless Entry, Theft-Deterrent, Trip Computer, HVAC Module, Security LED
30	Alt Sense
31	Torque Converter Clutch (TCC)
32	Fuel Pump
33	Electronic Control Module/Powertrain Control Module
34	Spare
35	Fog Lamps

Fuses	Usage
36	Horn
37	Chime/Mail Module, Taillamps, Parking Lamps, Sidemarkers Lamps, Dimmable Lamps
38	Spare Fuse
39	Not Used
40	Mini Fuse Puller

Relays	Usage
	Air Conditioning Clutch Diode
9	Cooling Fan
10	Cooling Fan 2
11	Ignition Main
12	Cooling Fan 1
13	Air Conditioning Clutch
14	Fuel Pump
15	Spare
16	Horn
17	Fog Lamp

## Capacities and Specifications

Please refer to *Part D: Recommended Fluids and Lubricants on page 6-15* for more information.

### Capacities and Specifications

Application	Capacities	
	English	Metric
Air Conditioning Refrigerant R-134a	2.4 lbs	1.1 kg
<b>Automatic Transaxle</b> Pan Removal and Replacement After Complete Overhaul	7.4 quarts 10.0 quarts	7.0 L 9.5 L
When draining/replacing converter or auxiliary cooler, more fluid may be needed.		
<b>Cooling System Including Reservoir</b> 3100 V6 (Code J) 3800 V6 (Code K) 3800 V6 Supercharged (Code 1)	11.0 quarts 11.2 quarts 11.2 quarts	10.4 L 10.6 L 10.6 L

## Capacities and Specifications (cont'd)

Application	Capacities	
	English	Metric
<b>Engine Oil with Filter</b> 3100 V6 (Code J) 3800 V6 (Code K) 3800 V6 Supercharged (Code 1)	4.3 quarts 4.3 quarts 4.3 quarts	4.1 L 4.1 L 4.1 L
Fuel Tank	17.2 gallons	65 L
All capacities are approximate. When adding fluid, be sure to fill to the appropriate level, as recommended in this manual. Recheck fluid level after filling. See <i>Part D. Recommended Fluids and Lubricants on page 6-15</i> for more information.		

## Engine Specifications

Engine	VIN Code	Spark Plug Gap	Firing Order	Wheel Nut Torque
3100 V6 191 CID (3.1L LG8)	J	.060 inch (1.52mm)	1-2-3-4-5-6	100 ft lb (140 N•m)
3800 V6 231 CID (3.8L L36)	K	.060 inch (1.52mm)	1-6-5-4-3-2	100 ft lb (140 N•m)
3800 V6 Supercharged 231 CID (3.8L L67)	1	.060 inch (1.52mm)	1-6-5-4-3-2	100 ft lb (140 N•m)



## Normal Maintenance Replacement Parts

### Normal Maintenance Replacement Parts

All Engines	
Automatic Transmission Filter	24206433*
Engine Air Cleaner / Filter*	GM Part No. 24508572, A1614C*
Oil Filter*	PF47*
Passenger Compartment Air Filter Kit	10406026
Spark Plugs	41-101*
<b>Wiper Blades</b> Type Length	Shepherd's Hook 22 inches (56 cm)

\*AC Delco<sup>®</sup> part number.

## Section 6 Maintenance Schedule

---

<b>Maintenance Schedule</b> .....	6-2	At Least Once a Year .....	6-10
Introduction .....	6-2	Part C: Periodic Maintenance Inspections .....	6-13
Your Vehicle and the Environment .....	6-2	Steering, Suspension and Front Drive Axle	
Maintenance Requirements .....	6-2	Boot and Seal Inspection .....	6-13
How This Section is Organized .....	6-3	Exhaust System Inspection .....	6-13
Part A: Scheduled Maintenance Services .....	6-4	Fuel System Inspection .....	6-13
Using Your Maintenance Schedule .....	6-4	Engine Cooling System Inspection .....	6-13
Scheduled Maintenance .....	6-5	Throttle System Inspection .....	6-14
Part B: Owner Checks and Services .....	6-9	Brake System Inspection .....	6-14
At Each Fuel Fill .....	6-9	Part D: Recommended Fluids and Lubricants ...	6-15
At Least Once a Month .....	6-9	Part E: Maintenance Record .....	6-16
At Least Twice a Year .....	6-10		

## Maintenance Schedule

### Introduction

**IMPORTANT:**  
KEEP ENGINE OIL  
AT THE PROPER  
LEVEL AND CHANGE AS  
RECOMMENDED



*Have you purchased the GM Protection Plan?  
The Plan supplements your new vehicle warranties.  
See your Warranty and Owner Assistance booklet  
or your dealer for details.*

## Your Vehicle and the Environment

Proper vehicle maintenance not only helps to keep your vehicle in good working condition, but also helps the environment. All recommended maintenance procedures are important. Improper vehicle maintenance can even affect the quality of the air we breathe. Improper fluid levels or the wrong tire inflation can increase the level of emissions from your vehicle. To help protect our environment, and to keep your vehicle in good condition, please maintain your vehicle properly.

### Maintenance Requirements

Maintenance intervals, checks, inspections and recommended fluids and lubricants as prescribed in this manual are necessary to keep your vehicle in good working condition. Any damage caused by failure to follow recommended maintenance may not be covered by warranty.

## How This Section is Organized

This maintenance schedule is divided into five parts:

**“Part A: Scheduled Maintenance Services”** explains what to have done and how often. Some of these services can be complex, so unless you are technically qualified and have the necessary equipment, you should let your dealer’s service department or another qualified service center do these jobs.

### CAUTION:

Performing maintenance work on a vehicle can be dangerous. In trying to do some jobs, you can be seriously injured. Do your own maintenance work only if you have the required know-how and the proper tools and equipment for the job. If you have any doubt, have a qualified technician do the work.

If you want to get the service information, see *Service Publications Ordering Information* on page 7-10.

**“Part B: Owner Checks and Services”** tells you what should be checked and when. It also explains what you can easily do to help keep your vehicle in good condition.

**“Part C: Periodic Maintenance Inspections”** explains important inspections that your dealer’s service department or another qualified service center should perform.

**“Part D: Recommended Fluids and Lubricants”** lists some recommended products necessary to help keep your vehicle properly maintained. These products, or their equivalents, should be used whether you do the work yourself or have it done.

**“Part E: Maintenance Record”** is a place for you to record and keep track of the maintenance performed on your vehicle. Keep your maintenance receipts. They may be needed to qualify your vehicle for warranty repairs.

## Part A: Scheduled Maintenance Services

This part contains engine oil scheduled maintenance which explains the engine oil life system and how it indicates when to change the engine oil and filter. Also, listed are scheduled maintenance services which are to be performed at the mileage intervals specified.

### Using Your Maintenance Schedule

We at General Motors want to keep your vehicle in good working condition. But we don't know exactly how you'll drive it. You may drive short distances only a few times a week. Or you may drive long distances all the time in very hot, dusty weather. You may use your vehicle in making deliveries. Or you may drive it to work, to do errands or in many other ways.

Because of the different ways people use their vehicles, maintenance needs may vary. You may need more frequent checks and replacements. So please read the following and note how you drive. If you have questions on how to keep your vehicle in good condition, see your dealer.

This part tells you the maintenance services you should have done and when you should schedule them. When you go to your dealer for your service needs, you'll know that GM-trained and supported service people will perform the work using genuine GM parts.

The proper fluids and lubricants to use are listed in Part D. Make sure whoever services your vehicle uses these. All parts should be replaced and all necessary repairs done before you or anyone else drives the vehicle.

This schedule is for vehicles that:

- carry passengers and cargo within recommended limits. You will find these on your vehicle's Tire-Loading Information label. See *Loading Your Vehicle on page 4-35*.
- are driven on reasonable road surfaces within legal driving limits.
- use the recommended fuel. See *Gasoline Octane on page 5-5*.

## Scheduled Maintenance

The services shown in this schedule up to 100,000 miles (166 000 km) should be repeated after 100,000 miles (166 000 km) at the same intervals for the life of this vehicle. The services shown at 150,000 miles (240 000 km) should be repeated at the same interval after 150,000 miles (240 000 km) for the life of this vehicle.

See *Part B: Owner Checks and Services* on page 6-9 and *Part C: Periodic Maintenance Inspections* on page 6-13.

## Footnotes

† *The U.S. Environmental Protection Agency or the California Air Resources Board has determined that the failure to perform this maintenance item will not nullify the emission warranty or limit recall liability prior to the completion of the vehicle's useful life. We, however, urge that all recommended maintenance services be performed at the indicated intervals and the maintenance be recorded.*

+*A good time to check your brakes is during tire rotation. See Brake System Inspection on page 6-14.*

## Engine Oil Scheduled Maintenance

**Change engine oil and filter as indicated by the GM Oil Life System™ (or every 12 months, whichever occurs first). Reset the system.**

Your vehicle has a computer system that lets you know when to change the engine oil and filter. This is based on engine revolutions and engine temperature, and not on mileage. Based on driving conditions, the mileage at which an oil change will be indicated can vary considerably. For the oil life system to work properly, you must reset the system every time the oil is changed.

When the system has calculated that oil life has been diminished, it will indicate that an oil change is necessary. A CHANGE OIL SOON light will come on. Change your oil as soon as possible within the next two times you stop for fuel. It is possible that, if you are driving under the best conditions, the oil life system may not indicate that an oil change is necessary for over a year. However, your engine oil and filter must be changed at least once a year and at this time the system must be reset. It is also important to check your oil regularly and keep it at the proper level.

If the system is ever reset accidentally, you must change your oil at 3,000 miles (5 000 km) since your last oil change. Remember to reset the oil life system whenever the oil is changed. See *Engine Oil* on page 5-18 for information on resetting the system.

After the services are performed, record the date, odometer reading and who performed the service on the maintenance record pages in Part E of this schedule.

*An Emission Control Service,*

### **7,500 Miles (12 500 km)**

- Rotate tires. See *Tire Inspection and Rotation* on page 5-69 for proper rotation pattern and additional information. (See footnote +.)

### **15,000 Miles (25 000 km)**

- Inspect engine air cleaner filter if you are driving in dusty conditions. Replace filter if necessary. *An Emission Control Service.* (See footnote †.)
- Rotate tires. See *Tire Inspection and Rotation* on page 5-69 for proper rotation pattern and additional information. (See footnote +.)

### **22,500 Miles (37 500 km)**

- Rotate tires. See *Tire Inspection and Rotation* on page 5-69 for proper rotation pattern and additional information. (See footnote +.)

### **30,000 Miles (50 000 km)**

- Rotate tires. See *Tire Inspection and Rotation* on page 5-69 for proper rotation pattern and additional information. (See footnote +.)
- Replace engine air cleaner filter. *An Emission Control Service.*
- For supercharged engines only: Check the supercharger oil level and add the proper supercharger oil as needed (or every 36 months, whichever occurs first). See *Part D: Recommended Fluids and Lubricants* on page 6-15. *An Emission Control Service.* (See footnote †.)

### **37,500 Miles (62 500 km)**

- Rotate tires. See *Tire Inspection and Rotation* on page 5-69 for proper rotation pattern and additional information. (See footnote +.)

## 45,000 Miles (75 000 km)

- ❑ Inspect engine air cleaner filter if you are driving in dusty conditions. Replace filter if necessary. *An Emission Control Service. (See footnote †.)*
- ❑ Rotate tires. See *Tire Inspection and Rotation* on page 5-69 for proper rotation pattern and additional information. *(See footnote +.)*

## 50,000 Miles (83 000 km)

- ❑ Change automatic transaxle fluid and filter if the vehicle is mainly driven under one or more of these conditions:
  - In heavy city traffic where the outside temperature regularly reaches 90°F (32°C) or higher.
  - In hilly or mountainous terrain.
  - When doing frequent trailer towing.
  - Uses such as found in taxi, police or delivery service.

*If you do not use your vehicle under any of these conditions, change the fluid and filter at 100,000 miles (166 000 km).*

## 52,500 Miles (87 500 km)

- ❑ Rotate tires. See *Tire Inspection and Rotation* on page 5-69 for proper rotation pattern and additional information. *(See footnote +.)*

## 60,000 Miles (100 000 km)

- ❑ For supercharged engines only: Check the supercharger oil level and add the proper supercharger oil as needed (or every 36 months, whichever occurs first). See *Part D: Recommended Fluids and Lubricants* on page 6-15. *An Emission Control Service. (See footnote †.)*
- ❑ Rotate tires. See *Tire Inspection and Rotation* on page 5-69 for proper rotation pattern and additional information. *(See footnote +.)*
- ❑ Replace engine air cleaner filter. *An Emission Control Service.*

## 67,500 Miles (112 500 km)

- ❑ Rotate tires. See *Tire Inspection and Rotation* on page 5-69 for proper rotation pattern and additional information. *(See footnote +.)*

## 75,000 Miles (125 000 km)

- ❑ Inspect engine air cleaner filter if you are driving in dusty conditions. Replace filter if necessary. *An Emission Control Service. (See footnote †.)*
- ❑ Rotate tires. See *Tire Inspection and Rotation* on page 5-69 for proper rotation pattern and additional information. *(See footnote +.)*



## 82,500 Miles (137 500 km)

- ❑ Rotate tires. See *Tire Inspection and Rotation on page 5-69* for proper rotation pattern and additional information. (See footnote +.)

## 90,000 Miles (150 000 km)

- ❑ Replace engine air cleaner filter. *An Emission Control Service.*
- ❑ For supercharged engines only: Check the supercharger oil level and add the proper supercharger oil as needed (or every 36 months, whichever occurs first). See *Part D: Recommended Fluids and Lubricants on page 6-15. An Emission Control Service.* (See footnote +.)
- ❑ Rotate tires. See *Tire Inspection and Rotation on page 5-69* for proper rotation pattern and additional information. (See footnote +.)

## 97,500 Miles (162 500 km)

- ❑ Rotate tires. See *Tire Inspection and Rotation on page 5-69* for proper rotation pattern and additional information. (See footnote +.)

## 100,000 Miles (166 000 km)

- ❑ Inspect spark plug wires. *An Emission Control Service.*
- ❑ Replace spark plugs. *An Emission Control Service.*

- ❑ Change automatic transaxle fluid and filter if the vehicle is mainly driven under one or more of these conditions:
  - In heavy city traffic where the outside temperature regularly reaches 90°F (32°C) or higher.
  - In hilly or mountainous terrain.
  - When doing frequent trailer towing.
  - Uses such as found in taxi, police or delivery service.
- ❑ If you haven't used your vehicle under severe service conditions listed previously and, therefore, haven't changed your automatic transaxle fluid, change both the fluid and filter.

## 150,000 Miles (240 000 km)

- ❑ Drain, flush and refill cooling system (or every 60 months since last service, whichever occurs first). See *Engine Coolant on page 5-30* for what to use. Inspect hoses. Clean radiator, condenser, pressure cap and neck. Pressure test the cooling system and pressure cap. *An Emission Control Service.*
- ❑ Inspect engine accessory drive belt. *An Emission Control Service.*

## Part B: Owner Checks and Services

Listed in this part are owner checks and services which should be performed at the intervals specified to help ensure the safety, dependability and emission control performance of your vehicle.

Be sure any necessary repairs are completed at once. Whenever any fluids or lubricants are added to your vehicle, make sure they are the proper ones, as shown in Part D.

### At Each Fuel Fill

*It is important for you or a service station attendant to perform these underhood checks at each fuel fill.*

#### Engine Oil Level Check

Check the engine oil level and add the proper oil if necessary. See *Engine Oil* on page 5-18 for further details.

#### Engine Coolant Level Check

Check the engine coolant level and add DEX-COOL<sup>®</sup> coolant mixture if necessary. See *Engine Coolant* on page 5-30 for further details.

#### Windshield Washer Fluid Level Check

Check the windshield washer fluid level in the windshield washer tank and add the proper fluid if necessary. See *Windshield Washer Fluid* on page 5-48 for further details.

### At Least Once a Month

#### Tire Inflation Check

Make sure tires are inflated to the correct pressures. Don't forget to check your spare tire. See *Tires* on page 5-68 for further details.

#### Cassette Tape Player Service

Clean cassette tape player. Cleaning should be done every 50 hours of tape play. See *Audio System(s)* on page 3-44 for further details.

## At Least Twice a Year

### Restraint System Check

Make sure the safety belt reminder light and all your belts, buckles, latch plates, retractors and anchorages are working properly. Look for any other loose or damaged safety belt system parts. If you see anything that might keep a safety belt system from doing its job, have it repaired. Have any torn or frayed safety belts replaced.

Also look for any opened or broken air bag coverings, and have them repaired or replaced. (The air bag system does not need regular maintenance.)

### Wiper Blade Check

Inspect wiper blades for wear or cracking. Replace blade inserts that appear worn or damaged or that streak or miss areas of the windshield. Also see "*Windshield Wiper and Wiper Blades*" under *Cleaning the Outside of Your Vehicle* on page 5-91.

### Weatherstrip Lubrication

Silicone grease on weatherstrips will make them last longer, seal better, and not stick or squeak. Apply silicone grease with a clean cloth. During very cold,

damp weather more frequent application may be required. See *Part D: Recommended Fluids and Lubricants* on page 6-15.

### Automatic Transaxle Check

Check the transaxle fluid level; add if needed. See *Automatic Transaxle Fluid* on page 5-27. A fluid loss may indicate a problem. Check the system and repair if needed.

## At Least Once a Year

### Key Lock Cylinders Service

Lubricate the key lock cylinders with the lubricant specified in Part D.

### Body Lubrication Service

Lubricate all hood hinges, hood latch assembly, secondary latch, pivots, spring anchor, release pawl, door hinges, rear compartment, glove box door, console door and any folding seat hardware. Part D tells you what to use. More frequent lubrication may be required when exposed to a corrosive environment.

## Starter Switch Check

### CAUTION:

When you are doing this check, the vehicle could move suddenly. If it does, you or others could be injured. Follow the steps below.

1. Before you start, be sure you have enough room around the vehicle.
2. Firmly apply both the parking brake and the regular brake. See *Parking Brake* on page 2-27 if necessary.

Do not use the accelerator pedal, and be ready to turn off the engine immediately if it starts.

3. Try to start the engine in each gear. The starter should work only in PARK (P) or NEUTRAL (N). If the starter works in any other position, your vehicle needs service.

## Automatic Transaxle Shift Lock Control System Check

### CAUTION:

When you are doing this check, the vehicle could move suddenly. If it does, you or others could be injured. Follow the steps below.

1. Before you start, be sure you have enough room around the vehicle. It should be parked on a level surface.
2. Firmly apply the parking brake. See *Parking Brake* on page 2-27 if necessary.  
Be ready to apply the regular brake immediately if the vehicle begins to move.
3. With the engine off, turn the key to the RUN position, but don't start the engine. Without applying the regular brake, try to move the shift lever out of PARK (P) with normal effort. If the shift lever moves out of PARK (P), your vehicle needs service.

## Ignition Transaxle Lock Check

While parked, and with the parking brake set, try to turn the ignition key to LOCK in each shift lever position.

- The key should turn to LOCK only when the shift lever is in PARK (P).
- The key should come out only in LOCK.

## Parking Brake and Automatic Transaxle Park (P) Mechanism Check

### CAUTION:

When you are doing this check, your vehicle could begin to move. You or others could be injured and property could be damaged. Make sure there is room in front of your vehicle in case it begins to roll. Be ready to apply the regular brake at once should the vehicle begin to move.

Park on a fairly steep hill, with the vehicle facing downhill. Keeping your foot on the regular brake, set the parking brake.

- To check the parking brake's holding ability: With the engine running and transaxle in NEUTRAL (N), slowly remove foot pressure from the regular brake pedal. Do this until the vehicle is held by the parking brake only.
- To check the PARK (P) mechanism's holding ability: With the engine running, shift to PARK (P). Then release the parking brake followed by the regular brake.

## Underbody Flushing Service

At least every spring, use plain water to flush any corrosive materials from the underbody. Take care to clean thoroughly any areas where mud and other debris can collect.

## **Part C: Periodic Maintenance Inspections**

Listed in this part are inspections and services which should be performed at least twice a year (for instance, each spring and fall). *You should let your dealer's service department or other qualified service center do these jobs. Make sure any necessary repairs are completed at once.*

Proper procedures to perform these services may be found in a service manual. See *Service Publications Ordering Information on page 7-10.*

### **Steering, Suspension and Front Drive Axle Boot and Seal Inspection**

Inspect the front and rear suspension and steering system for damaged, loose or missing parts, signs of wear or lack of lubrication. Inspect the power steering lines and hoses for proper hook-up, binding, leaks, cracks, chafing, etc. Clean and then inspect the drive axle boot seals for damage, tears or leakage. Replace seals if necessary.

### **Exhaust System Inspection**

Inspect the complete exhaust system. Inspect the body near the exhaust system. Look for broken, damaged, missing or out-of-position parts as well as open seams, holes, loose connections or other conditions which could cause a heat build-up in the floor pan or could let exhaust fumes into the vehicle. See *Engine Exhaust on page 2-31.*

### **Fuel System Inspection**

Inspect the complete fuel system for damage or leaks.

### **Engine Cooling System Inspection**

Inspect the hoses and have them replaced if they are cracked, swollen or deteriorated. Inspect all pipes, fittings and clamps; replace as needed. Clean the outside of the radiator and air conditioning condenser. To help ensure proper operation, a pressure test of the cooling system and pressure cap is recommended at least once a year.

## Throttle System Inspection

Inspect the throttle system for interference or binding, and for damaged or missing parts. Replace parts as needed. Replace any components that have high effort or excessive wear. Do not lubricate accelerator and cruise control cables.

## Brake System Inspection

Inspect the complete system. Inspect brake lines and hoses for proper hook-up, binding, leaks, cracks, chafing, etc. Inspect disc brake pads for wear and rotors for surface condition. Inspect other brake parts, including calipers, parking brake, etc. Check parking brake adjustment. You may need to have your brakes inspected more often if your driving habits or conditions result in frequent braking.

## Part D: Recommended Fluids and Lubricants

Fluids and lubricants identified below by name, part number or specification may be obtained from your dealer.

Usage	Fluid/Lubricant
Engine Oil	Engine oil with the American Petroleum Institute Certified for Gasoline Engines starburst symbol of the proper viscosity. To determine the preferred viscosity for your vehicle's engine, see <i>Engine Oil</i> on page 5-18.
Engine Coolant	50/50 mixture of clean, drinkable water and use only DEX-COOL Coolant. See <i>Engine Coolant</i> on page 5-30.
Hydraulic Brake System	Delco Supreme 11 Brake Fluid or equivalent DOT-3 brake fluid.
Windshield Washer Solvent	GM Optikleen Washer Solvent or equivalent.
Power Steering System	GM Power Steering Fluid (GM Part No. U.S. 1052884, in Canada 993294, or equivalent).

Usage	Fluid/Lubricant
Automatic Transaxle	DEXRON-III Automatic Transmission Fluid.
Key Lock Cylinders	Multi-Purpose Lubricant, Superlube (GM Part No. U.S. 12346241, in Canada 10953474, or equivalent).
Supercharger	Supercharger Oil (GM Part No. U.S. 12345982, in Canada 10953513). See <i>Supercharger Oil</i> on page 5-24.
Hood Latch Assembly, Secondary Latch, Pivots, Spring Anchor and Release Pawl	Lubriplate Lubricant Aerosol (GM Part No. U.S. 12346293, in Canada 992723, or equivalent) or lubricant meeting requirements of NLGI #2, Category LB or GC-LB.
Hood and Door Hinges	Multi-Purpose Lubricant, Superlube (GM Part No. U.S. 12346241, in Canada 10953474, or equivalent).
Weatherstrip Conditioning	Dielectric Silicone Grease (GM Part No. U.S. 12345579, in Canada 1974984, or equivalent).



# Part E: Maintenance Record

After the scheduled services are performed, record the date, odometer reading and who performed the service and any additional information from "Owner Checks and Services" or "Periodic Maintenance" on the following record pages. Also, you should retain all maintenance receipts.

## Maintenance Record

Date	Odometer Reading	Serviced By	Maintenance Record



### Maintenance Record (cont'd)

Date	Odometer Reading	Serviced By	Maintenance Record

## Section 7 Customer Assistance Information

---

<b>Customer Assistance Information</b> .....	7-2	Courtesy Transportation .....	7-6
Customer Satisfaction Procedure .....	7-2	Reporting Safety Defects to the United States Government .....	7-9
Customer Assistance for Text Telephone (TTY) Users .....	7-3	Reporting Safety Defects to the Canadian Government .....	7-9
Customer Assistance Offices .....	7-4	Reporting Safety Defects to General Motors .....	7-9
GM Mobility Program for Persons with Disabilities .....	7-5	Service Publications Ordering Information .....	7-10
Roadside Assistance Program .....	7-5		

# Customer Assistance Information

## Customer Satisfaction Procedure

Your satisfaction and goodwill are important to your dealer and to Pontiac. Normally, any concerns with the sales transaction or the operation of your vehicle will be resolved by your dealer's sales or service departments. Sometimes, however, despite the best intentions of all concerned, misunderstandings can occur. If your concern has not been resolved to your satisfaction, the following steps should be taken:

**STEP ONE:** Discuss your concern with a member of dealership management. Normally, concerns can be quickly resolved at that level. If the matter has already been reviewed with the sales, service or parts manager, contact the owner of the dealership or the general manager.

**STEP TWO:** If after contacting a member of dealership management, it appears your concern cannot be resolved by the dealership without further help, contact the Pontiac Customer Assistance Center by calling 1-800-762-2737. In Canada, contact GM of Canada Customer Communication Centre in Oshawa by calling 1-800-263-3777 (English) or 1-800-263-7854 (French).

We encourage you to call the toll-free number in order to give your inquiry prompt attention. Please have the following information available to give the Customer Assistance Representative:

- Vehicle Identification Number (This is available from the vehicle registration or title, or the plate at the top left of the instrument panel and visible through the windshield.)
- Dealership name and location
- Vehicle delivery date and present mileage

When contacting Pontiac, please remember that your concern will likely be resolved at a dealer's facility. That is why we suggest you follow Step One first if you have a concern.

**STEP THREE:** Both General Motors and your dealer are committed to making sure you are completely satisfied with your new vehicle. However, if you continue to remain unsatisfied after following the procedure outlined in Steps One and Two, you should file with the GM/BBB Auto Line Program to enforce any additional rights you may have. Canadian owners refer to your Warranty and Owner Assistance Information booklet for information on the Canadian Motor Vehicle Arbitration Plan (CAMVAP).

The BBB Auto Line Program is an out of court program administered by the Council of Better Business Bureaus to settle automotive disputes regarding vehicle repairs or the interpretation of the New Vehicle Limited Warranty. Although you may be required to resort to this informal dispute resolution program prior to filing a court action, use of the program is free of charge and your case will generally be heard within 40 days. If you do not agree with the decision given in your case, you may reject it and proceed with any other venue for relief available to you.

You may contact the BBB using the toll-free telephone number or write them at the following address:

BBB Auto Line  
Council of Better Business Bureaus, Inc.  
4200 Wilson Boulevard  
Suite 800  
Arlington, VA 22203-1804  
Telephone: 1-800-955-5100

This program is available in all 50 states and the District of Columbia. Eligibility is limited by vehicle age, mileage and other factors. General Motors reserves the right to change eligibility limitations and/or discontinue its participation in this program.

## **Customer Assistance for Text Telephone (TTY) Users**

To assist customers who are deaf, hard of hearing, or speech-impaired and who use Text Telephones (TTYs), Pontiac has TTY equipment available at its Customer Assistance Center. Any TTY user can communicate with Pontiac by dialing: 1-800-833-PONT (7668). (TTY users in Canada can dial 1-800-263-3830.)

## Customer Assistance Offices

Pontiac encourages customers to call the toll-free number for assistance. If a U.S. customer wishes to write to Pontiac, the letter should be addressed to Pontiac's Customer Assistance Center.

### United States

Pontiac-GMC Customer Assistance Center  
P.O. Box 33172  
Detroit, MI 48232-5172

1-800-762-2737 or  
1-800-833-7668 (For Text Telephone devices (TTYs))  
Roadside Assistance: 1-800-ROADSIDE (762-3743)  
Fax Number: 313-381-0022

From Puerto Rico:  
1-800-496-9992 (English)  
1-800-496-9993 (Spanish)  
Fax Number: 313-381-0022

From U.S. Virgin Islands:  
1-800-496-9994  
Fax Number: 313-381-0022

### Canada

General Motors of Canada Limited  
Customer Communication Centre, 163-005  
1908 Colonel Sam Drive  
Oshawa, Ontario L1H 8P7

1-800-263-3777 (English)  
1-800-263-7854 (French)  
1-800-263-3830 (For Text Telephone devices (TTYs))  
Roadside Assistance: 1-800-268-6800

### All Overseas Locations

Please contact the local General Motors Business Unit.

### Mexico, Central America and Caribbean Islands/Countries (Except Puerto Rico and U.S. Virgin Islands)

General Motors de Mexico, S. de R.L. de C.V.  
Customer Assistance Center  
Paseo de la Reforma # 2740  
Col. Lomas de Bezares  
C.P. 11910 Mexico, D.F.  
01-800-508-0000  
Long Distance: 011-52-53 29 0 800

## GM Mobility Program for Persons with Disabilities



This program, available to qualified applicants, can reimburse you up to \$1,000 toward aftermarket driver or passenger adaptive equipment you may require for your vehicle (hand controls, wheelchair/scooter lifts, etc.).

This program can also provide you with free resource information, such as area driver assessment centers and mobility equipment installers. The program is available for a limited period of time from the date of vehicle purchase/lease. See your dealer for more details or call the GM Mobility Assistance Center at 1-800-323-9935. Text telephone (TTY) users, call 1-800-833-9935.

GM of Canada also has a Mobility Program. Call 1-800-GM-DRIVE (463-7483) for details. All TTY users call 1-800-263-3830.

## Roadside Assistance Program Security While You Travel

*1-800-ROADSIDE (1-800-762-3743)*

As the proud owner of a new Pontiac vehicle, you are automatically enrolled in the Pontiac Roadside Assistance program. This value-added service is intended to provide you with peace of mind as you drive in the city or travel the open road.

Pontiac's Roadside Assistance toll-free number is staffed by a team of technically trained advisors, who are available 24 hours a day, 365 days a year.

We take anxiety out of uncertain situations by providing minor repair information over the phone or making arrangements to tow your vehicle to the nearest Pontiac dealer.

We will provide the following services for 3 years/36,000 miles (60 000 km), at no expense to you:

- Fuel delivery
- Lock-out service (identification required)
- Tow to nearest dealership for warranty service
- Change a flat tire
- Jump starts



We have quick, easy access to telephone numbers of the following additional services depending on your needs:

- Hotels
- Glass replacement
- Tire repair facilities
- Rental vehicle or taxis
- Airports or train stations
- Police, fire departments or hospitals

In many instances, mechanical failures are covered under Pontiac's comprehensive warranty. However, when other services are utilized, our advisors will explain any payment obligations you might incur.

For prompt and efficient assistance when calling, please provide the following information to give the advisor:

- Location of vehicle
- Telephone number of your location
- Vehicle model, year and color
- Mileage of vehicle
- Vehicle Identification Number (VIN)
- Vehicle license plate number

Pontiac reserves the right to limit services or reimbursement to an owner or driver when, in Pontiac's judgement, the claims become excessive in frequency or type of occurrence.

While we hope you never have the occasion to use our service, it is added security while traveling for you and your family. Remember, we're only a phone call away. Pontiac Roadside Assistance: 1-800-ROADSIDE or 1-800-762-3743, text telephone (TTY) users, call 1-888-889-2438.

## **Canadian Roadside Assistance**

Vehicles purchased in Canada have an extensive Roadside Assistance program accessible from anywhere in Canada or the United States. Please refer to the Warranty and Owner Assistance Information book.

## **Courtesy Transportation**

Pontiac has always exemplified quality and value in its offering of motor vehicles. To enhance your ownership experience, we and our participating dealers are proud to offer Courtesy Transportation, a customer support program for new vehicles.

The Courtesy Transportation program is offered to retail purchase/lease customers in conjunction with the Bumper-to-Bumper coverage provided by the New Vehicle Limited Warranty. Several transportation options are available when warranty repairs are required. This will reduce your inconvenience during warranty repairs.

## **Plan Ahead When Possible**

When your vehicle requires warranty service, you should contact your dealer and request an appointment. By scheduling a service appointment and advising your service consultant of your transportation needs, your dealer can help minimize your inconvenience.

If your vehicle cannot be scheduled into the service department immediately, keep driving it until it can be scheduled for service, unless, of course, the problem is safety-related. If it is, please call your dealership, let them know this, and ask for instructions.

If the dealer requests that you simply drop the vehicle off for service, you are urged to do so as early in the work day as possible to allow for same-day repair.

## **Transportation Options**

Warranty service can generally be completed while you wait. However, if you are unable to wait Pontiac helps minimize your inconvenience by providing several transportation options. Depending on the circumstances, your dealer can offer you one of the following:

### **Shuttle Service**

Participating dealers can provide you with shuttle service to get you to your destination with minimal interruption of your daily schedule. This includes a one-way shuttle ride to a destination up to 10 miles from the dealership.

### **Public Transportation or Fuel Reimbursement**

If your vehicle requires overnight warranty repairs, reimbursement up to \$30 per day (five days maximum) may be available for the use of public transportation such as taxi or bus. In addition, should you arrange transportation through a friend or relative, reimbursement for reasonable fuel expenses up to \$10 per day (five day maximum) may be available. Claim amounts should reflect actual costs and be supported by original receipts.

## Courtesy Rental Vehicle

When your vehicle is unavailable due to overnight warranty repairs, your dealer may arrange to provide you with a courtesy rental vehicle or reimburse you for a rental vehicle you obtained, at actual cost, up to a maximum of \$30.00 per day supported by receipts. This requires that you sign and complete a rental agreement and meet state, local and rental vehicle provider requirements. Requirements vary and may include minimum age requirements, insurance coverage, credit card, etc. You are responsible for fuel usage charges and may also be responsible for taxes, levies, usage fees, excessive mileage or rental usage beyond the completion of the repair.

Generally it is not possible to provide a like-vehicle as a courtesy rental.

## Additional Program Information

Courtesy Transportation is available during the Bumper-to-Bumper warranty coverage period, but it is *not* part of the New Vehicle Limited Warranty.

A separate booklet entitled *Warranty and Owner Assistance Information* furnished with each new vehicle provides detailed warranty coverage information.

Courtesy Transportation is available only at participating dealers and all program options, such as shuttle service, may not be available at every dealer. Please contact your dealer for specific information about availability. All Courtesy Transportation arrangements will be administered by appropriate dealer personnel.

**Canadian Vehicles:** For warranty repairs during the Complete Vehicle Coverage period of the General Motors of Canada New Vehicle Limited warranty, alternative transportation may be available under the Courtesy Transportation Program. Please consult your dealer for details.

*General Motors reserves the right to unilaterally modify, change or discontinue Courtesy Transportation at any time and to resolve all questions of claim eligibility pursuant to terms and conditions described herein at its sole discretion.*

## Reporting Safety Defects to the United States Government

If you believe that your vehicle has a defect which could cause a crash or could cause injury or death, you should immediately inform the National Highway Traffic Safety Administration (NHTSA), in addition to notifying General Motors.

If NHTSA receives similar complaints, it may open an investigation, and if it finds that a safety defect exists in a group of vehicles, it may order a recall and remedy campaign. However, NHTSA cannot become involved in individual problems between you, your dealer or General Motors.

To contact NHTSA, you may either call the Auto Safety Hotline toll-free at 1-800-424-9393 (or 366-0123 in the Washington, D.C. area) or write to:

NHTSA, U.S. Department of Transportation  
Washington, D.C. 20590

You can also obtain other information about motor vehicle safety from the hotline.

## Reporting Safety Defects to the Canadian Government

If you live in Canada, and you believe that your vehicle has a safety defect, you should immediately notify Transport Canada, in addition to notifying General Motors of Canada Limited. You may write to:

Transport Canada  
330 Sparks Street  
Tower C Ottawa Ontario K1A 0N5

## Reporting Safety Defects to General Motors

In addition to notifying NHTSA (or Transport Canada) in a situation like this, we certainly hope you'll notify us. Please call us at 1-800-762-2737, or write:

Pontiac-GMC Customer Assistance Center  
P.O. Box 33172  
Detroit, MI 48232-5172

In Canada, please call us at 1-800-263-3777 (English) or 1-800-263-7854 (French). Or, write:

General Motors of Canada Limited  
Customer Communication Centre, 163-005  
1908 Colonel Sam Drive  
Oshawa, Ontario L1H 8P7

## **Service Publications Ordering Information**

### **Service Manuals**

Service Manuals have the diagnosis and repair information on engines, transmission, axle, suspension, brakes, electrical, steering, body, etc.

RETAIL SELL PRICE: \$120.00

### **Transmission, Transaxle, Transfer Case Unit Repair Manual**

This manual provides information on unit repair service procedures, adjustments, and specifications for GM transmissions, transaxles, and transfer cases.

RETAIL SELL PRICE: \$50.00

### **Service Bulletins**

Service Bulletins give technical service information needed to knowledgeably service General Motors cars and trucks. Each bulletin contains instructions to assist in the diagnosis and service of your vehicle.

In Canada, information pertaining to Product Service Bulletins can be obtained by contacting your General Motors dealer or by calling 1-800-GM-DRIVE (1-800-463-7483).

### **Owner's Information**

Owner publications are written specifically for owners and intended to provide basic operational information about the vehicle. The owner's manual will include the Maintenance Schedule for all models.

In-Portfolio: Includes a Portfolio, Owner's Manual, and Warranty Booklet.

RETAIL SELL PRICE: \$35.00

Without Portfolio: Owner's Manual only.

RETAIL SELL PRICE: \$25.00

## **Current and Past Model Order Forms**

Service Publications are available for current and past model GM vehicles. To request an order form, please specify year and model name of the vehicle.

**ORDER TOLL FREE: 1-800-551-4123**  
**Monday-Friday 8:00 AM - 6:00 PM**  
**Eastern Time**

For Credit Card Orders Only  
(VISA-MasterCard-Discover), visit Helm, Inc. on the  
World Wide Web at: [www.helminc.com](http://www.helminc.com)

Or you can write to:

Helm, Incorporated  
P. O. Box 07130  
Detroit, MI 48207

Prices are subject to change without notice and without incurring obligation. Allow ample time for delivery.

Note to Canadian Customers: All listed prices are quoted in U.S. funds. Canadian residents are to make checks payable in U.S. funds.



# A

Accessory Power Outlets .....	3-18
Activating the Theft-Deterrent Feature .....	3-54
Adding Washer Fluid .....	5-48
Additional Program Information .....	7-8
Additives, Fuel .....	5-6
Add-On Electrical Equipment .....	5-97
Adjusting the Speakers (Balance/Fade) .....	3-46, 3-49, 3-52
Air Bag Readiness Light .....	3-26
Air Bag System, Supplemental Restraint System (SRS) .....	1-51
Air Cleaner/Filter, Engine .....	5-25
All Overseas Locations .....	7-4
Aluminum or Chrome Plated Wheels .....	5-93
AM .....	3-57
Antenna, Backglass .....	3-59
Anti-lock Brake System (ABS) .....	4-7
Anti-Lock Brake, System Warning Light .....	3-29
Appearance Care .....	5-88
Care of Safety Belts .....	5-91
Chemical Paint Spotting .....	5-94
Cleaning the Inside of Your Vehicle .....	5-88
Cleaning the Outside of Your Vehicle .....	5-91
Finish Damage .....	5-93
GM Vehicle Care/Appearance Materials .....	5-94
Sheet Metal Damage .....	5-93
Underbody Maintenance .....	5-93
Appearance Care (cont.) Weatherstrips .....	5-91
Arming and Disarming the Content Theft-Deterrent System .....	2-52
Arming Confirmation .....	2-16
Arming with the Power Lock Switch .....	2-15
Arming with the Remote Keyless Entry Transmitter .....	2-16
Ashtrays .....	3-19
Assist Handles .....	2-41
Audio System(s) .....	3-44
Audio Systems Audio Steering Wheel Controls .....	3-56
Backglass Antenna .....	3-59
Care of Your Cassette Tape Player .....	3-58
Care of Your CD Player .....	3-59
Care of Your CDs .....	3-59
Radio with Cassette .....	3-45
Radio with CD .....	3-48, 3-51
Setting the Time .....	3-44
Theft-Deterrent Feature .....	3-54
Understanding Radio Reception .....	3-57
Automatic Door Locks .....	2-45
Automatic Transaxle Fluid .....	5-27
Operation .....	2-24
Automatic Transaxle Check .....	6-10
Automatic Transaxle Shift Lock Control System Check .....	6-11
Auxiliary Power Connection (Power Drop) .....	3-19



## B

Backglass Antenna .....	3-59
Backing Up .....	4-41
Battery .....	5-52
Battery Replacement .....	2-6
Battery Run-Down Protection .....	3-15
Before Leaving on a Long Trip .....	4-24
Body Lubrication Service .....	6-10
Brake	
Parking .....	2-27
System Inspection .....	6-14
System Warning Light .....	3-28
Brake Fluid .....	5-49
Brake Wear .....	5-51
Brakes .....	5-49
Braking .....	4-6
Braking in Emergencies .....	4-9
Break-In, New Vehicle .....	2-19
Bulb Replacement .....	5-60
Center High-Mounted Stoplamp (CHMSL) .....	5-63
Front Turn Signal and Sidemarkers Lamps .....	5-62
Halogen Bulbs .....	5-60
Headlamp Aiming .....	5-59
Headlamps .....	5-60
Replacement Bulbs .....	5-66
Taillamps, Sidemarkers and Back-Up Lamps .....	5-64
Buying New Tires .....	5-71

## C

California Fuel .....	5-6
Canada .....	7-4
Canadian Owners .....	ii
Canadian Roadside Assistance .....	7-6
Capacities and Specifications .....	5-102
Carbon Monoxide .....	4-27, 4-37, 2-11, 2-31
Care of	
Safety Belts .....	5-91
Care of the HUD .....	3-17
Care of Your	
Cassette Tape Player .....	3-58
CD Player .....	3-59
CDs .....	3-59
Cassette Tape Messages .....	3-47
Cassette Tape Player Service .....	6-9
CD Adapter Kits .....	3-48
Center Console Storage Area .....	2-40
Center High-Mounted Stoplamp (CHMSL) .....	5-63
Center Passenger Position, Safety Belts .....	1-21
Chains, Tires .....	5-75
Charging System Light .....	3-27
Check	
Engine Light .....	3-32
Checking Coolant .....	5-31
Checking Engine Oil .....	5-18
Checking Things Under the Hood .....	5-10
Checking Your Restraint Systems .....	1-58
Chemical Paint Spotting .....	5-94

Child Restraints			
Child Restraint Systems .....	1-35	Compass Calibration .....	2-35
Infants and Young Children .....	1-32	Compass Operation .....	2-34
Lower Anchorages and Top Tethers for		Compass Variance .....	2-35
Children (LATCH System) .....	1-41	Compass Variation .....	2-35
Older Children .....	1-29	Content Theft-Deferrent .....	2-15
Securing a Child Restraint Designed for		Content Theft-Deterrent System .....	2-51
the LATCH System .....	1-43	Content Theft-Deterrent System, Arming and	
Securing a Child Restraint in a Center		Disarming .....	2-52
Rear Seat Position .....	1-46	Control of a Vehicle .....	4-6
Securing a Child Restraint in a Rear		Convenience Net .....	2-41
Outside Seat Position .....	1-43	Coolant	
Securing a Child Restraint in the Right		Engine Temperature Gage .....	3-31
Front Seat Position .....	1-48	Engine Temperature Warning Light .....	3-31
Top Strap .....	1-39	Heater, Engine .....	2-23
Top Strap Anchor Location .....	1-40	Cooling System .....	5-36
Where to Put the Restraint .....	1-38	Courtesy Lamps .....	3-13
Cigarette Lighter .....	3-19	Cruise Control .....	3-8
Cleaning		Current and Past Model Order Forms .....	7-11
Inside of Your Vehicle .....	5-88	Customer Assistance Information	
Outside of Your Vehicle .....	5-91	Courtesy Transportation .....	7-6
Underbody Maintenance .....	5-93	Customer Assistance for Text Telephone (TTY)	
Weatherstrips .....	5-91	Users .....	7-3
Cleaning Exterior Lamps/Lenses .....	5-92	Customer Assistance Offices .....	7-4
Climate Control System		Customer Satisfaction Procedure .....	7-2
Dual .....	3-20	GM Mobility Program for Persons with	
Outlet Adjustment .....	3-22	Disabilities .....	7-5
Compact Disc Messages .....	3-51, 3-54	Reporting Safety Defects to General Motors .....	7-9
Compact Spare Tire .....	5-86, 5-87	Reporting Safety Defects to the Canadian	
		Government .....	7-9

Customer Assistance Information (cont.)	
Reporting Safety Defects to the United States	
Government .....	7-9
Roadside Assistance Program .....	7-5
Service Publications Ordering Information .....	7-10

## D

Daytime Running Lamps (DRL) / Automatic	
Headlamp System .....	3-11
Defensive Driving .....	4-2
Defogging and Defrosting .....	3-21
Delayed Exit Lighting .....	3-14
Delayed Illumination and Exit Lighting .....	2-44
Delayed Lighting .....	3-13
Dinghy Towing .....	4-34
Disabling the Theft-Deterrent Feature .....	3-56
Disarming with the Remote Keyless Entry	
Transmitter .....	2-16
Disarming with Your Key .....	2-16
Doing Your Own Service Work .....	5-4
Dolly Towing .....	4-34
Door	
Last Door Closed Locking .....	2-9
Locks .....	2-8
Power Door Locks .....	2-9
Programmable Automatic Door Locks .....	2-10

Driver	
Position, Safety Belt .....	1-12
Six-Way Power Seat .....	1-3
Driver Information Center (DIC) .....	3-38
Driving	
At Night .....	4-18
City .....	4-22
Defensive .....	4-2
Drunken .....	4-3
Freeway .....	4-23
Hill and Mountain Roads .....	4-25
In Rain and on Wet Roads .....	4-19
Winter .....	4-27
Driving On Grades .....	4-42
Driving on Snow or Ice .....	4-28
Driving Through Deep Standing Water .....	4-21
Driving Through Flowing Water .....	4-21
Driving with a Trailer .....	4-41
Dual Climate Control System .....	3-20

## E

Electrical System	
Add-On Equipment .....	5-97
Fuses and Circuit Breakers .....	5-97
Headlamp Wiring .....	5-97
Power Windows and Other Power Options .....	5-97
Windshield Wiper Fuses .....	5-97
Emergency Trunk Release Handle .....	2-12

Emissions Inspection and Maintenance Programs .....	3-34
Engine	
Air Cleaner/Filter .....	5-25
Battery .....	5-52
Check and Service Engine Soon Light .....	3-32
Coolant .....	5-30
Coolant Heater .....	2-23
Coolant Temperature Gage .....	3-31
Coolant Temperature Warning Light .....	3-31
Cooling System Inspection .....	6-13
Engine Compartment Overview .....	5-12
Exhaust .....	2-31
Oil .....	5-18
Overheating .....	5-33
Starting .....	2-20
Supercharger Oil .....	5-24
Engine Coolant Level Check .....	6-9
Engine Cooling When Trailer Towing .....	4-43
Engine Oil Additives .....	5-22
Engine Oil Level Check .....	6-9
Engine Oil Scheduled Maintenance .....	6-5
Enhanced Traction System (ETS) .....	4-11
Warning Light .....	3-30
Entering Programming Mode .....	2-44
Entry Lighting .....	3-13
Exiting Programming Mode .....	2-53
Express-Down Window .....	2-14
Extender, Safety Belt .....	1-28
Exterior Lamps .....	3-10

## F

Fabric/Carpet .....	5-88
Filter	
Engine Air Cleaner .....	5-25
Finding a Station .....	3-45, 3-49, 3-52
Finish Care .....	5-92
Finish Damage .....	5-93
Flash-to-Pass .....	3-6
Flat Tire .....	5-76
Flat Tire, Changing .....	5-76
Fluid	
Automatic Transaxle .....	5-27
Power Steering .....	5-46
Windshield Washer .....	5-48
FM .....	3-57
Fog Lamps .....	3-12
Following Distance .....	4-41
Footnotes .....	6-5
Front Reading Lamps .....	3-14
Fuel	
Additives .....	5-6
California Fuel .....	5-6
Filling a Portable Fuel Container .....	5-9
Filling Your Tank .....	5-7
Fuels in Foreign Countries .....	5-7
Gage .....	3-37
Gasoline Octane .....	5-5

Fuel (cont.)	
Gasoline Specifications .....	5-5
Low Warning Light .....	3-37
System Inspection .....	6-13
Functions .....	3-39
Fuses	
Fuses and Circuit Breakers .....	5-97
Windshield Wiper .....	5-97

## G

Gage	
Engine Coolant Temperature .....	3-31
Fuel .....	3-37
Speedometer .....	3-25
Tachometer .....	3-25
Garage Door Opener Compartment .....	2-40
Gasoline	
Octane .....	5-5
Specifications .....	5-5
Glass Surfaces .....	5-90
Glove Box .....	2-40
GM Mobility Program for Persons with Disabilities .....	7-5

## H

Hazard Warning Flashers .....	3-3
Head Restraints .....	1-6

Headlamp	
Aiming .....	5-59
Headlamp High/Low-Beam Changer .....	3-6
Headlamp Wiring .....	5-97
Headlamps .....	5-60
Bulb Replacement .....	5-60
Front Turn Signal and Sidemarkers Lamps .....	5-62
Halogen Bulbs .....	5-60
Head-Up Display (HUD) .....	3-15
Heated Seats .....	1-4
Highway Hypnosis .....	4-25
Hill and Mountain Roads .....	4-25
Hitches .....	4-40
Hood	
Checking Things Under .....	5-10
Release .....	5-10
Horn .....	3-4
How to Add Coolant to the Coolant Recovery Tank .....	5-38
How to Add Coolant to the Radiator .....	5-41
How to Add Fluid .....	5-29
How to Check .....	5-27, 5-69
How to Check and Add Oil .....	5-25
How to Check Power Steering Fluid .....	5-47
How to Use This Manual .....	ii
How to Wear Safety Belts Properly .....	1-12
Hydroplaning .....	4-20

## I

If No Steam is Coming From Your Engine .....	5-35
If Steam Is Coming From Your Engine .....	5-34
If the HUD Image Is Not Clear .....	3-18
If the Light Is Flashing .....	3-33
If the Light Is On Steady .....	3-33
If You Are Stuck in Sand, Mud, Ice or Snow .....	4-32
If You Can't See the HUD Image When the Ignition Is On .....	3-18
If You Do Decide To Pull A Trailer .....	4-38
If You're Caught in a Blizzard .....	4-29
Ignition Positions .....	2-19
Ignition Transaxle Lock Check .....	6-12
Infants and Young Children, Restraints .....	1-32
Inflation -- Tire Pressure .....	5-68
Inspection	
Brake System .....	6-14
Engine Cooling System .....	6-13
Exhaust System .....	6-13
Fuel System .....	6-13
Part C - Periodic Maintenance .....	6-13
Steering, Suspension and Front Drive Axle Boot and Seal .....	6-13
Throttle System .....	6-14
Instrument Panel	
Cluster .....	3-24
Overview .....	3-2
Instrument Panel Brightness .....	3-12

Instrument Panel Fuse Block .....	5-98
Interior Lamps .....	3-12
Interior Plastic Components .....	5-90

## J

Jump Starting .....	5-53
---------------------	------

## K

Key Lock Cylinders Service .....	6-10
Keyless Entry System .....	2-4
Keys .....	2-3

## L

Lamps	
Exterior .....	3-10
Interior .....	3-12
Lap Belt .....	1-21
Lap-Shoulder Belt .....	1-12, 1-23
Last Door Closed Locking .....	2-9, 2-47
LATCH System	
Child Restraints .....	1-41
Securing a Child Restraint Designed for the LATCH System .....	1-43
Leather .....	5-90
Leaving Your Vehicle .....	2-11

Leaving Your Vehicle With the Engine Running	2-29
Light	
Air Bag Readiness	3-26
Anti-Lock Brake System Warning	3-29
Brake System Warning	3-28
Charging System	3-27
Engine Coolant Temperature Warning	3-31
Enhanced Traction System (ETS)	
Warning Light	3-30
Low Fuel Warning	3-37
Low Oil Level	3-36
Low Traction	3-30
Malfunction Indicator	3-32
Oil Pressure	3-35
Safety Belt Reminder	3-26
Security	3-36
TCS Warning Light	3-29
Traction Control System (TCS) Warning	3-29
Litter Bag or Purse Holder	2-41
Loading Your Vehicle	4-35
Lockout Protection	2-10, 2-47
Locks	
Automatic Door	2-45
Door	2-8
Last Door Closed Locking	2-9
Leaving Your Vehicle	2-11
Lockout Protection	2-10
Power Door	2-9
Programmable Automatic Door Locks	2-10

Loss of Control	4-16
Low Fuel Warning Light	3-37
Low Traction Light	3-30
Lumbar	
Power Controls	1-3

## M

Maintenance, Normal Replacement Parts	5-104
Maintenance Schedule	
At Each Fuel Fill	6-9
At Least Once a Month	6-9
At Least Once a Year	6-10
At Least Twice a Year	6-10
Brake System Inspection	6-14
Engine Cooling System Inspection	6-13
Exhaust System Inspection	6-13
Fuel System Inspection	6-13
How This Section is Organized	6-3
Introduction	6-2
Maintenance Requirements	6-2
Part A - Scheduled Maintenance Services	6-4
Part B - Owner Checks and Services	6-9
Part C - Periodic Maintenance Inspections	6-13
Part D - Recommended Fluids and	
Lubricants	6-15
Part E - Maintenance Record	6-16
Scheduled Maintenance	6-5

Maintenance Schedule (cont.)	
Steering, Suspension and Front Drive Axle	
Boot and Seal Inspection .....	6-13
Throttle System Inspection .....	6-14
Using Your .....	6-4
Your Vehicle and the Environment .....	6-2
Maintenance When Trailer Towing .....	4-43
Making Turns .....	4-41
Malfunction Indicator Light .....	3-32
Manual Seats .....	1-2
Matching Transmitter(s) to Your Vehicle .....	2-6
Mexico, Central America and Caribbean	
Islands/Countries	
(Except Puerto Rico and U.S. Virgin Islands) .....	7-4
Mirror Operation .....	2-33, 2-35
Mirrors	
Automatic Dimming Rearview with Compass	
and Temperature Display .....	2-34
Automatic Dimming Rearview with OnStar <sup>®</sup> ,	
Compass and Temperature Display .....	2-33
Manual Rearview Mirror .....	2-33
Outside Convex Mirror .....	2-37
Outside Power Mirrors .....	2-37

## N

New Vehicle Break-In .....	2-19
Normal Maintenance Replacement Parts .....	5-104

## O

Odometer .....	3-25
Off-Road Recovery .....	4-15
Oil	
Engine .....	5-18
Low Oil Level Light .....	3-36
Pressure Light .....	3-35
Supercharger, Engine .....	5-24
Older Children, Restraints .....	1-29
OnStar <sup>®</sup> Personal Calling .....	2-39
OnStar <sup>®</sup> Services .....	2-38
OnStar <sup>®</sup> System .....	2-38
OnStar <sup>®</sup> Virtual Advisor .....	2-39
Other Warning Devices .....	3-4
Outlet Adjustment .....	3-22
Outside	
Convex Mirror .....	2-37
Power Mirrors .....	2-37
Overhead Console .....	2-40
Overhead Console Reading Lamps .....	3-14
Overheated Engine Protection	
Operating Mode .....	5-33
Owners, Canadian .....	ii
Owner's Information .....	7-10



## P

Park (P)	
Shifting Into .....	2-28
Park (P)	
Shifting Out of .....	2-30
Parking	
Brake .....	2-27
Over Things That Burn .....	2-30
Parking Brake and Automatic Transaxle Park (P)	
Mechanism Check .....	6-12
Parking on Hills .....	4-42
Part A - Scheduled Maintenance Services .....	6-4
Part B - Owner Checks and Services .....	6-9
Part C - Periodic Maintenance Inspections .....	6-13
Part D - Recommended Fluids and Lubricants ....	6-15
Part E - Maintenance Record .....	6-16
Passing .....	4-15, 4-41
PASS-Key <sup>®</sup> III .....	2-16
PASS-Key <sup>®</sup> III Operation .....	2-17
Plan Ahead When Possible .....	7-7
Playing a Cassette Tape .....	3-46
Playing a Compact Disc .....	3-50, 3-53
Playing the Radio .....	3-45, 3-48, 3-51
Power .....	1-3
Accessory Outlets .....	3-18
Auxiliary Connection .....	3-19
Door Locks .....	2-9
Drop .....	3-19

Power (cont.)	
Electrical System .....	5-97
Lumbar Controls .....	1-3
Steering Fluid .....	5-46
Windows .....	2-14
Power Steering .....	4-13
Programmable Automatic Door Locks .....	2-10
Programmable Modes .....	2-44, 2-45, 2-47, 2-48, 2-49, 2-51, 2-52
Programming Mode	
Entering .....	2-44
Exiting .....	2-53
Purse or Litter Bag Holder .....	2-41

## Q

Questions and Answers About Safety Belts .....	1-11
--	------

## R

Radiator Pressure Cap .....	5-33
Radios .....	3-44
Care of Your Cassette Tape Player .....	3-58
Care of Your CD Player .....	3-59
Care of Your CDs .....	3-59
Radio with Cassette .....	3-45
Radio with CD .....	3-48, 3-51

Radios (cont.)	
Setting the Time .....	3-44
Theft-Deterrent .....	3-54
Understanding Reception .....	3-57
Rear Assist Handle Reading Lamps .....	3-14
Rear Safety Belt Comfort Guides .....	1-26
Rear Seat Outside Passenger Positions .....	1-23
Rear Seat Passengers, Safety Belts .....	1-22
Rear Storage Area .....	2-41
Rear Window Defogger .....	3-22
Rearview Mirror, Automatic Dimming with Compass and Temperature Display .....	2-34
Rearview Mirror, Automatic Dimming with OnStar <sup>®</sup> , Compass and Temperature Display .....	2-33
Rearview Mirrors .....	2-33
Reclining Seatbacks .....	1-4
Recreational Vehicle Towing .....	4-33
Remote Driver Unlock Control .....	2-48
Remote Keyless Entry System .....	2-4
Remote Keyless Entry System, Operation .....	2-5
Remote Lock and Unlock Confirmation .....	2-49
Remote Trunk Release .....	2-12
Removing the Flat Tire and Installing the Spare Tire .....	5-80
Removing the Spare Tire and Tools .....	5-77
Removing Wheel Covers and Wheel Nut Caps .....	5-79
Replacement Bulbs .....	5-66
Replacing Brake System Parts .....	5-52

Replacing Restraint System Parts After a Crash .....	1-58
Reporting Safety Defects	
Canadian Government .....	7-9
General Motors .....	7-9
United States Government .....	7-9
Restraint System Check .....	6-10
Checking Your Restraint Systems .....	1-58
Replacing Restraint System Parts After a Crash .....	1-58
Restraint Systems	
Checking .....	1-58
Replacing Parts .....	1-58
Restraints, Head .....	1-6
Retained Accessory Power (RAP) .....	2-20
Right Front Passenger Position, Safety Belts .....	1-20
Roadside	
Assistance Program .....	7-5
Rocking Your Vehicle To Get It Out .....	4-32
Running Your Engine While You Are Parked .....	2-32

## S

Safety Belt	
Reminder Light .....	3-26
Safety Belts	
Care of .....	5-91
Center Passenger Position .....	1-21
Driver Position .....	1-12

Safety Belts (cont.)	
How to Wear Safety Belts Properly .....	1-12
Questions and Answers About Safety Belts .....	1-11
Rear Safety Belt Comfort Guides for	
Children and Small Adults .....	1-26
Rear Seat Passengers .....	1-22
Right Front Passenger Position .....	1-20
Safety Belt Extender .....	1-28
Safety Belt Use During Pregnancy .....	1-20
Safety Belts Are for Everyone .....	1-7
Safety Chains .....	4-40
Safety Warnings and Symbols .....	iii
Scheduled Maintenance .....	6-5
Seats	
Head Restraints .....	1-6
Heated Seats .....	1-4
Manual .....	1-2
Power Lumbar .....	1-3
Reclining Seatbacks .....	1-4
Six-Way Power Driver .....	1-3
Securing a Child Restraint	
Center Rear Seat Position .....	1-46
Designed for the LATCH System .....	1-43
Rear Outside Seat Position .....	1-43
Right Front Seat Position .....	1-48
Security Light .....	3-36
Security While You Travel .....	7-5
Service .....	5-3
Adding Equipment to the Outside of	
Your Vehicle .....	5-4
Doing Your Own Work .....	5-4
Engine Soon Light .....	3-32
Publications Ordering Information .....	7-10
Service Bulletins .....	7-10
Service Engine Soon Light in the United States	
or Check Engine Light in Canada .....	3-32
Service Manuals .....	7-10
Setting Preset Stations .....	3-45, 3-49, 3-52
Setting the Time .....	3-44
Setting the Tone (Bass/Treble) .....	3-46, 3-49, 3-52
Sheet Metal Damage .....	5-93
Shift Lock Release .....	2-20
Shifting Into Park (P) .....	2-28
Shifting Out of Park (P) .....	2-30
Shoulder Belt Height Adjuster .....	1-14
Skidding .....	4-17
Some Other Rainy Weather Tips .....	4-21
Special Fabric Cleaning Problems .....	5-89
Specifications, Capacities .....	5-102
Speedometer .....	3-25
Starter Switch Check .....	6-11
Starting Your 3100 V6 Engine .....	2-21
Starting Your 3800 Series II V6 Engine .....	2-22
Starting Your Engine .....	2-20

Steering .....	4-13
Steering in Emergencies .....	4-14
Steering, Suspension and Front Drive Axle Boot and Seal Inspection .....	6-13
Steering Tips .....	4-13
Steering Wheel Controls, Audio .....	3-56
Storage Areas	
Center Console Storage Area .....	2-40
Convenience Net .....	2-41
Glove Box .....	2-40
Overhead Console .....	2-40
Purse or Litter Bag Holder .....	2-41
Rear Storage Area .....	2-41
Trunk Access Panel .....	2-41
Storing the Flat Tire and Tools .....	5-85
Storing the Spare Tire and Tools .....	5-86
Stuck in Sand, Mud, Ice or Snow .....	4-32
Sun Visors .....	2-14
Sunglasses Storage Compartment .....	2-40
Sunroof .....	2-42
Supplemental Restraint System (SRS) .....	1-51
How Does an Air Bag Restrain? .....	1-55
Servicing Your Air Bag-Equipped Vehicle .....	1-57
What Makes an Air Bag Inflate? .....	1-55
What Will You See After an Air Bag Inflates? .....	1-56
When Should an Air Bag Inflate? .....	1-55
Where Are the Air Bags? .....	1-53

## T

Tachometer .....	3-25
Taillamps	
Sidemarker and Back-Up Lamps .....	5-64
TCS Warning Light .....	3-29
Temperature Display .....	2-34, 2-35
Theft-Deterrent, Radio .....	3-54
Theft-Deterrent Systems .....	2-15
Content Theft-Deterrent .....	2-15
PASS-Key® III .....	2-16
PASS-Key® III Operation .....	2-17
Throttle System Inspection .....	6-14
Tilt Wheel .....	3-4
Tire Inflation Check .....	6-9
Tires .....	5-68, 5-93
Buying New Tires .....	5-71
Chains .....	5-75
Changing a Flat Tire .....	5-76
Compact Spare Tire .....	5-87
if a Tire Goes Flat .....	5-76
Inflation -- Tire Pressure .....	5-68
Inspection and Rotation .....	5-69
Uniform Tire Quality Grading .....	5-72
Wheel Alignment and Tire Balance .....	5-73
Wheel Replacement .....	5-73
When It Is Time for New Tires .....	5-70

To Use the Engine Coolant Heater .....	2-23
Top of the Instrument Panel .....	5-90
Top Strap .....	1-39
Top Strap Anchor Location .....	1-40
Torque Lock .....	2-29
Total Weight on Your Vehicle's Tires .....	4-39
Towing	
Recreational Vehicle .....	4-33
Towing a Trailer .....	4-37
Your Vehicle .....	4-33
Traction	
Control System (TCS) .....	4-10
Control System Warning Light .....	3-29
Enhanced Traction System (ETS) .....	4-11
Enhanced Traction System (ETS)	
Warning Light .....	3-30
Low Light .....	3-30
Trailer Brakes .....	4-40
Transaxle	
Fluid, Automatic .....	5-27
Transaxle Operation, Automatic .....	2-24
Transmission, Transaxle, Transfer Case Unit	
Repair Manual .....	7-10
Transportation Options .....	7-7
Trip Computer .....	3-40
Control Buttons .....	3-42
Functions .....	3-42
Trip Odometer .....	3-25

Trunk .....	2-11
Trunk Access Panel .....	2-41
Trunk Lock .....	2-11
Turn and Lane-Change Signals .....	3-5
Turn Signal/Multifunction Lever .....	3-5
Turn Signals When Towing a Trailer .....	4-42

## U

Underbody Flushing Service .....	6-12
Underhood Fuse Block .....	5-100
Understanding Radio Reception .....	3-57
Uniform Tire Quality Grading .....	5-72
United States .....	7-4
Unlocking the Theft-Deterrent Feature	
After a Power Loss .....	3-55
Used Replacement Wheels .....	5-74
Using Cleaner on Fabric .....	5-89

## V

Variable Effort Steering .....	4-13
Vehicle	
Control .....	4-6
Damage Warnings .....	iv
Loading .....	4-35
Symbols .....	iv

Vehicle Identification	
Number (VIN) .....	5-96
Service Parts Identification Label .....	5-96
Vehicle Personalization .....	2-43
Arming and Disarming the Content	
Theft-Deterrent System .....	2-52
Automatic Door Locks .....	2-45
Content Theft-Deterrent System .....	2-51
Delayed Illumination and Exit Lighting .....	2-44
Entering Programming Mode .....	2-44
Exiting Programming Mode .....	2-53
Last Door Closed Locking and Lockout	
Protection .....	2-47
Remote Driver Unlock Control .....	2-48
Remote Lock and Unlock Confirmation .....	2-49
Vehicle Storage .....	5-53
Ventilation Adjustment .....	3-22
Vinyl .....	5-90
Visor Vanity Mirror .....	2-14
Visors .....	2-14

## W

Warning Lights, Gages and Indicators .....	3-23
Warnings	
Hazard Warning Flashers .....	3-3
Other Warning Devices .....	3-4

Warnings (cont.)	
Safety and Symbols .....	iii
Vehicle Damage .....	iv
Washing Your Vehicle .....	5-91
Weatherstrip Lubrication .....	6-10
Weight of the Trailer .....	4-38
Weight of the Trailer Tongue .....	4-39
What Kind of Engine Oil to Use .....	5-20
What Kind of Oil to Use .....	5-24
What to Do with Used Oil .....	5-24
What to Use .....	5-30, 5-47, 5-48
Wheels	
Alignment and Tire Balance .....	5-73
Replacement .....	5-73
When to Add Engine Oil .....	5-19
When to Change Engine Oil	
(GM Oil Life System™) .....	5-23
When to Check .....	5-24, 5-69
When to Check and Change .....	5-27
When to Check Power Steering Fluid .....	5-47
When You Are Ready to Leave After	
Parking on a Hill .....	4-43
Where to Put the Restraint .....	1-38
Why Safety Belts Work .....	1-8
Window Lock-Out .....	2-14
Windows .....	2-13
Power .....	2-14
Windshield and Wiper Blades .....	5-92

Windshield Washer .....	3-7
Fluid .....	5-48
Windshield Washer Fluid Level Check .....	6-9
Windshield Wiper	
Blade Replacement .....	5-67
Fuses .....	5-97
Windshield Wipers .....	3-7

Winter Driving .....	4-27
Wiper Blade Check .....	6-10

## Y

Your Vehicle and the Environment .....	6-2
--	-----







