

2002



PONTIAC

GRAND PRIX



2002 Pontiac Grand Prix Owner's Manual

Litho in U.S.A.
Part Number 10315402 A First Edition

©Copyright General Motors Corporation 06/13/01
All Rights Reserved



GENERAL MOTORS, GM, the GM Emblem, PONTIAC, the PONTIAC Emblem and the name GRAND PRIX are registered trademarks of General Motors Corporation.

This manual includes the latest information at the time it was printed. We reserve the right to make changes after that time without further notice. For vehicles first sold in Canada, substitute the name “General Motors of Canada Limited” for Pontiac Division whenever it appears in this manual.

Please keep this manual in your vehicle, so it will be there if you ever need it when you’re on the road. If you sell the vehicle, please leave this manual in it so the new owner can use it.



We support voluntary technician certification.

For Canadian Owners Who Prefer a French Language Manual:

Aux propriétaires canadiens: Vous pouvez vous procurer un exemplaire de ce guide en français chez votre concessionnaire ou au:

Helm, Incorporated
P.O. Box 07130
Detroit, MI 48207

How to Use this Manual

Many people read their owner's manual from beginning to end when they first receive their new vehicle. If you do this, it will help you learn about the features and controls for your vehicle. In this manual, you'll find that pictures and words work together to explain things quickly.

Safety Warnings and Symbols

You will find a number of safety cautions in this book. We use a box and the word CAUTION to tell you about things that could hurt you if you were to ignore the warning.



These mean there is something that could hurt you or other people.

In the caution area, we tell you what the hazard is. Then we tell you what to do to help avoid or reduce the hazard. Please read these cautions. If you don't, you or others could be hurt.

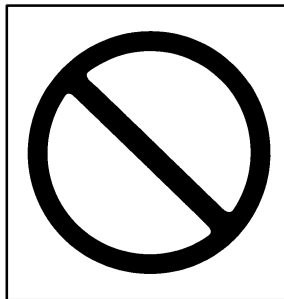

You will also find a circle with a slash through it in this book. This safety symbol means "Don't," "Don't do this" or "Don't let this happen."

Vehicle Damage Warnings

Also, in this book you will find these notices:

NOTICE:

These mean there is something that could damage your vehicle.

In the notice area, we tell you about something that can damage your vehicle. Many times, this damage would not be covered by your warranty, and it could be costly. But the notice will tell you what to do to help avoid the damage.

When you read other manuals, you might see CAUTION and NOTICE warnings in different colors or in different words.

You'll also see warning labels on your vehicle. They use the same words, CAUTION or NOTICE.

Vehicle Symbols

































Your vehicle may be equipped with components and labels that use symbols instead of text. Symbols, used on your vehicle, are shown along with the text describing the operation or information relating to a specific component, control, message, gage or indicator.

If you need help figuring out a specific name of a component, gage or indicator reference the following topics in the Index:

- “Engine Compartment Overview”
- “Instrument Panel”
- “Comfort Controls”
- “Audio Systems”

Also see “Warning Lights and Gages” in the Index.

These are some examples of vehicle symbols you may find on your vehicle:

CAUTION POSSIBLE INJURY		LATCH BOTH LAP AND SHOULDER BELTS TO PROTECT OCCUPANT DO NOT TWIST SAFETY BELT WHEN ATTACHING	 	MASTER LIGHTING SWITCH		ENGINE COOLANT TEMP		FUSE BOX ACCESS			
PROTECT EYES BY SHIELDING		FASTEN SEAT BELTS		AIR BAG		TURN SIGNALS		BATTERY CHARGING SYSTEM		ENGINE COOLANT FAN	
CAUSTIC BATTERY ACID COULD CAUSE BURNS		MOVE SEAT FULLY REARWARD SECURE CHILD SEAT		DO NOT INSTALL A REAR-FACING CHILD RESTRAINT IN THIS SEATING POSITION		PARKING LAMPS		BRAKE		FUEL	
AVOID SPARKS OR FLAMES		PULL BELT OUT COMPLETELY THEN SECURE CHILD SEAT		DO NOT INSTALL A FORWARD-FACING CHILD RESTRAINT IN THIS SEATING POSITION		HAZARD WARNING FLASHER		COOLANT		OWNER'S MANUAL	
SPARK OR FLAME COULD EXPLODE BATTERY		POWER WINDOW		DOOR LOCK UNLOCK		DAYTIME RUNNING LAMPS		ENGINE OIL PRESSURE		SERVICE	
						FOG LAMPS		ANTI-LOCK BRAKES		SERVICE MANUAL	



Section 1 Seats and Restraint Systems

Here you'll find information about the seats in your vehicle and how to use your safety belts properly. You can also learn about some things you should *not* do with air bags and safety belts.

1-2	Seats and Controls	1-31	Rear Safety Belt Comfort Guides for Children and Small Adults
1-7	Safety Belts: They're for Everyone	1-34	Center Passenger Position
1-12	Questions Many People Ask About Safety Belts -- and the Answers	1-35	Children
1-13	How to Wear Safety Belts Properly	1-39	Restraint Systems for Children
1-13	Driver Position	1-51	Older Children
1-20	Safety Belt Use During Pregnancy	1-54	Safety Belt Extender
1-21	Right Front Passenger Position	1-54	Checking Your Restraint Systems
1-21	Supplemental Restraint System (SRS)	1-54	Replacing Restraint System Parts After a Crash
1-28	Rear Seat Passengers		

Seats and Seat Controls

This section tells you how to adjust the seats and explains reclining seatbacks and head restraints.

Manual Front Seat

CAUTION:

You can lose control of the vehicle if you try to adjust a manual driver's seat while the vehicle is moving. The sudden movement could startle and confuse you, or make you push a pedal when you don't want to. Adjust the driver's seat only when the vehicle is not moving.



Lift the lever, located under the front of the seat, using a twisting motion. This will unlock the seat. Slide the seat to where you want it and release the lever. Try to move the seat back and forth to make sure the seat is locked in place.

Six-Way Power Driver's Seat (If Equipped)



If your vehicle has this feature, the control is located on the outboard side of the driver's seat cushion.

To adjust the seat cushion, do any of the following:

- Move the seat forward or rearward by sliding the control toward the front or the rear.
- Raise or lower the seat cushion by sliding the control up or down.
- Raise or lower the front portion of the seat cushion by sliding the front of the control up or down.
- Raise or lower the rear portion of the seat cushion by sliding the rear of the control up or down.

Four-Way Power Lumbar Driver's Seat (Option)



If your vehicle has this option, there will be a control located on the outboard side of the driver's seat cushion, in front of the reclining seatback lever. To increase or decrease lumbar support, push the control forward or rearward. To adjust the lumbar support up or down, push the control up or down.

Heated Driver's Seat (Option)



If your vehicle has this option, the heated seat switch is located on the center console, behind the open storage bin.

Press LO to warm the seat to a lower temperature. Press HI to warm the seat to a higher temperature. To turn this feature off, place the switch in the center position. This feature only works when the ignition is turned on.

Reclining Front Seatbacks

The recliner lever for the driver's and passenger's front seatback is located on the outboard side of each front seat cushion.



Lift the lever to release the seatback, then move the seatback to where you want it. Release the lever to lock the seatback in place. Pull up on the lever without pushing on the seatback and the seatback will move forward.



But don't have a seatback reclined if your vehicle is moving.

⚠ CAUTION:

Sitting in a reclined position when your vehicle is in motion can be dangerous. Even if you buckle up, your safety belts can't do their job when you're reclined like this.

The shoulder belt can't do its job because it won't be against your body. Instead, it will be in front of you. In a crash you could go into it, receiving neck or other injuries.

The lap belt can't do its job either. In a crash the belt could go up over your abdomen. The belt forces would be there, not at your pelvic bones. This could cause serious internal injuries.

For proper protection when the vehicle is in motion, have the seatback upright. Then sit well back in the seat and wear your safety belt properly.

Head Restraints



Slide the head restraint up or down so that the top of the restraint is closest to the top of your head. This position reduces the chance of a neck injury in a crash.

Seatback Latches (Two-Door Models)



On two-door models, the front passenger seat is designed to make it easy to get into and out of the rear seat. Tilt the passenger seatback fully forward. The whole seat will now slide forward. If the seatback will not tilt, lift the seatback latch located on the back of the seat to tilt the seatback forward. The whole seat will now slide forward.

After someone gets into the rear seat area, move the passenger front seatback to its original position. Then move the seat rearward until it locks.

To get out, tilt the seatback fully forward and slide the seat forward out of the way.

 **CAUTION:**

If the seatback isn't locked, it could move forward in a sudden stop or crash. That could cause injury to the person sitting there. Always press rearward on the seatback to be sure it is locked.

Safety Belts: They're for Everyone

This part of the manual tells you how to use safety belts properly. It also tells you some things you should not do with safety belts.

And it explains the Supplemental Restraint System (SRS), or air bag system.

 **CAUTION:**

Don't let anyone ride where he or she can't wear a safety belt properly. If you are in a crash and you're not wearing a safety belt, your injuries can be much worse. You can hit things inside the vehicle or be ejected from it. You can be seriously injured or killed. In the same crash, you might not be if you are buckled up. Always fasten your safety belt, and check that your passengers' belts are fastened properly too.

⚠ CAUTION:

It is extremely dangerous to ride in a cargo area, inside or outside of a vehicle. In a collision, people riding in these areas are more likely to be seriously injured or killed. Do not allow people to ride in any area of your vehicle that is not equipped with seats and safety belts. Be sure everyone in your vehicle is in a seat and using a safety belt properly.



Your vehicle has a light that comes on as a reminder to buckle up. See “Safety Belt Reminder Light” in the Index.

In most states and Canadian provinces, the law says to wear safety belts. Here’s why: *They work.*

You never know if you’ll be in a crash. If you do have a crash, you don’t know if it will be a bad one.

A few crashes are mild, and some crashes can be so serious that even buckled up a person wouldn’t survive. But most crashes are in between. In many of them, people who buckle up can survive and sometimes walk away. Without belts they could have been badly hurt or killed.

After more than 30 years of safety belts in vehicles, the facts are clear. In most crashes buckling up does matter ... a lot!

Why Safety Belts Work

When you ride in or on anything, you go as fast as it goes.

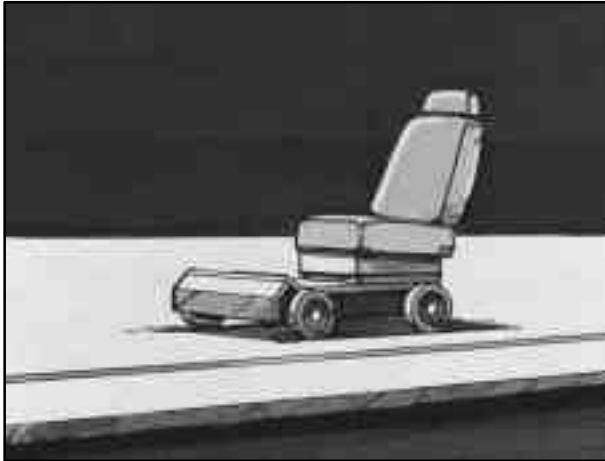

Take the simplest vehicle. Suppose it's just a seat on wheels.

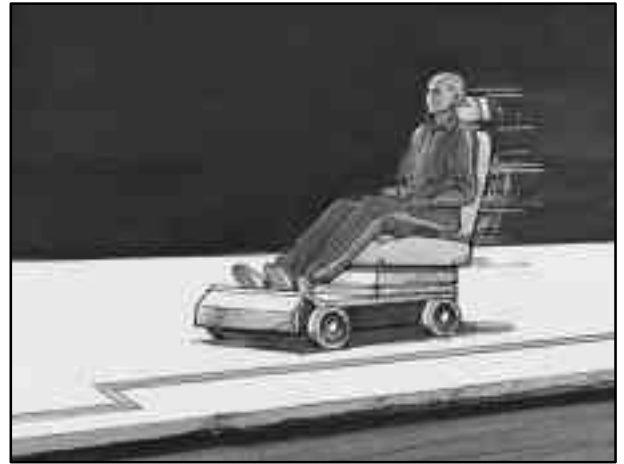

Put someone on it.

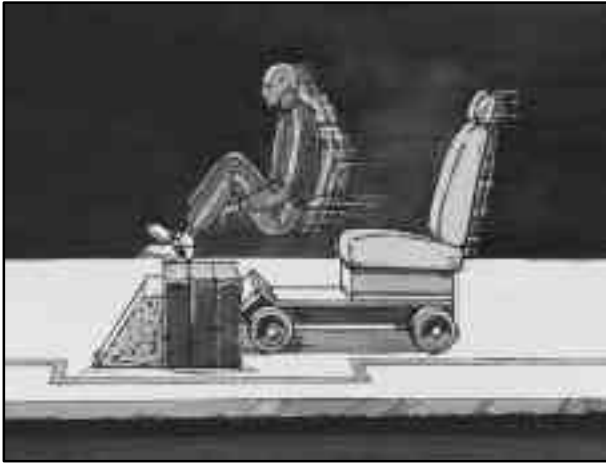

Get it up to speed. Then stop the vehicle. The rider doesn't stop.



The person keeps going until stopped by something. In a real vehicle, it could be the windshield ...



or the instrument panel ...

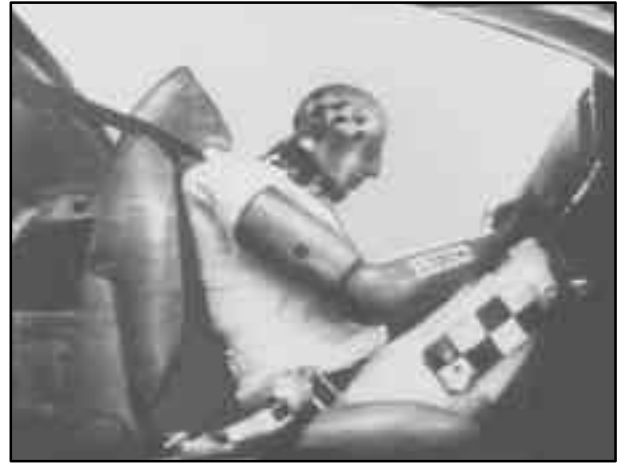

or the safety belts!

With safety belts, you slow down as the vehicle does. You get more time to stop. You stop over more distance, and your strongest bones take the forces. That's why safety belts make such good sense.

Here Are Questions Many People Ask About Safety Belts -- and the Answers

Q: Won't I be trapped in the vehicle after an accident if I'm wearing a safety belt?

A: You *could* be -- whether you're wearing a safety belt or not. But you can unbuckle a safety belt, even if you're upside down. And your chance of being conscious during and after an accident, so you *can* unbuckle and get out, is *much* greater if you are belted.

Q: If my vehicle has air bags, why should I have to wear safety belts?

A: Air bags are in many vehicles today and will be in most of them in the future. But they are supplemental systems only; so they work *with* safety belts -- not instead of them. Every air bag system ever offered for sale has required the use of safety belts. Even if you're in a vehicle that has air bags, you still have to buckle up to get the most protection. That's true not only in frontal collisions, but especially in side and other collisions.

Q: If I'm a good driver, and I never drive far from home, why should I wear safety belts?

A: You may be an excellent driver, but if you're in an accident -- even one that isn't your fault -- you and your passengers can be hurt. Being a good driver doesn't protect you from things beyond your control, such as bad drivers.

Most accidents occur within 25 miles (40 km) of home. And the greatest number of serious injuries and deaths occur at speeds of less than 40 mph (65 km/h).

Safety belts are for everyone.

How to Wear Safety Belts Properly

Adults

This part is only for people of adult size.

Be aware that there are special things to know about safety belts and children. And there are different rules for smaller children and babies. If a child will be riding in your vehicle, see the part of this manual called “Children”. Follow those rules for everyone’s protection.

First, you’ll want to know which restraint systems your vehicle has.

We’ll start with the driver position.

Driver Position

This part describes the driver’s restraint system.

Lap-Shoulder Belt

The driver has a lap-shoulder belt. Here’s how to wear it properly.

1. Close and lock the door.
2. Adjust the seat so you can sit up straight. To see how, see “Seats” in the Index.



3. Pick up the latch plate and pull the belt across you. Don’t let it get twisted.

The shoulder belt may lock if you pull the belt across you very quickly. If this happens, let the belt go back slightly to unlock it. Then pull the belt across you more slowly.

4. Push the latch plate into the buckle until it clicks.

Pull up on the latch plate to make sure it is secure. If the belt isn't long enough, see "Safety Belt Extender" at the end of this section.

Make sure the release button on the buckle is positioned so you would be able to unbuckle the safety belt quickly if you ever had to.



5. To make the lap part tight, pull down on the buckle end of the belt as you pull up on the shoulder belt.

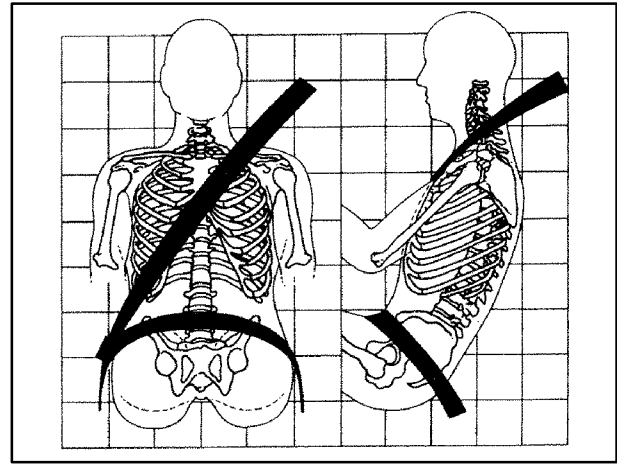

The lap part of the belt should be worn low and snug on the hips, just touching the thighs. In a crash, this applies force to the strong pelvic bones. And you'd be less likely to slide under the lap belt. If you slid under it, the belt would apply force at your abdomen. This could cause serious or even fatal injuries. The shoulder belt should go over the shoulder and across the chest. These parts of the body are best able to take belt restraining forces.

The safety belt locks if there's a sudden stop or crash, or if you pull the belt very quickly out of the retractor.

Shoulder Belt Height Adjuster (Four-Door Models)

Before you begin to drive, move the shoulder belt adjuster to the height that is right for you.



To move it down, squeeze the release lever and the shoulder belt guide as shown and move the height adjuster to the desired position. You can move the adjuster up just by pushing up on the shoulder belt guide. After you move the adjuster to where you want it, try to move it down without squeezing the release lever to make sure it has locked into position.

Adjust the height so that the shoulder portion of the belt is centered on your shoulder. The belt should be away from your face and neck, but not falling off your shoulder.

Q: What's wrong with this?

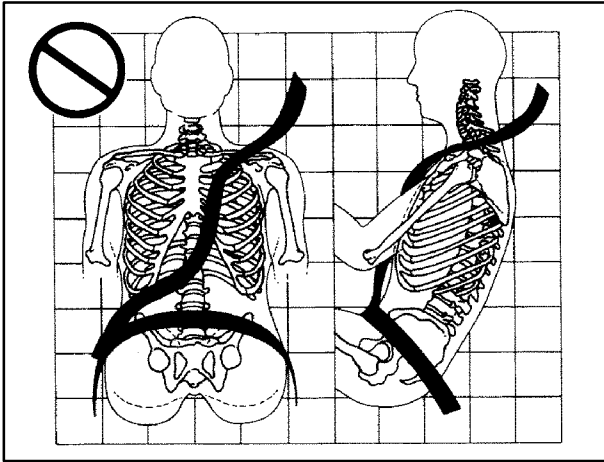

A: The shoulder belt is too loose. It won't give nearly as much protection this way.

⚠ CAUTION:

You can be seriously hurt if your shoulder belt is too loose. In a crash, you would move forward too much, which could increase injury. The shoulder belt should fit against your body.

Q: What's wrong with this?

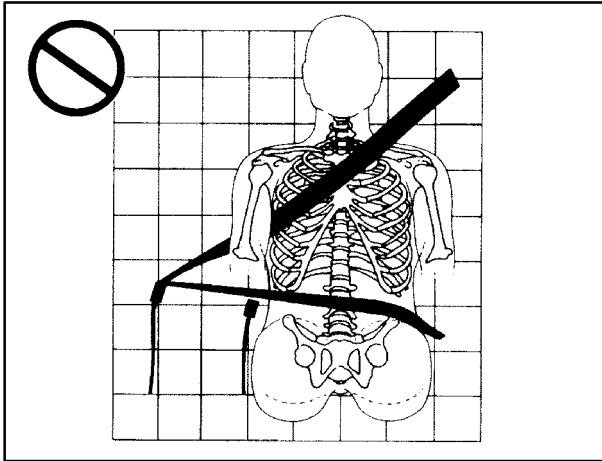

A: The belt is buckled in the wrong place.

⚠ CAUTION:

You can be seriously injured if your belt is buckled in the wrong place like this. In a crash, the belt would go up over your abdomen. The belt forces would be there, not at the pelvic bones. This could cause serious internal injuries. Always buckle your belt into the buckle nearest you.

Q: What's wrong with this?

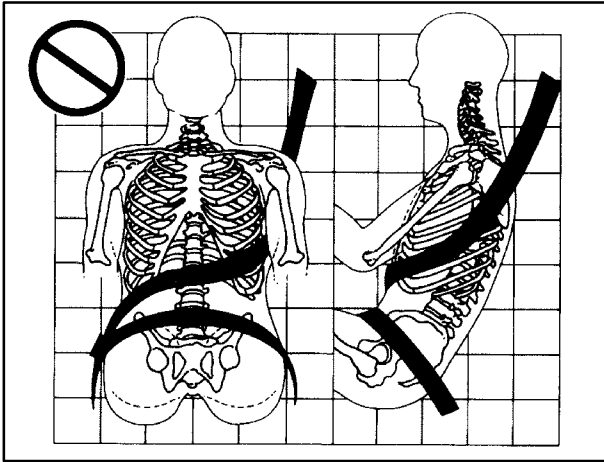

A: The shoulder belt is worn under the arm. It should be worn over the shoulder at all times.

⚠ CAUTION:

You can be seriously injured if you wear the shoulder belt under your arm. In a crash, your body would move too far forward, which would increase the chance of head and neck injury. Also, the belt would apply too much force to the ribs, which aren't as strong as shoulder bones. You could also severely injure internal organs like your liver or spleen.

Q: What's wrong with this?

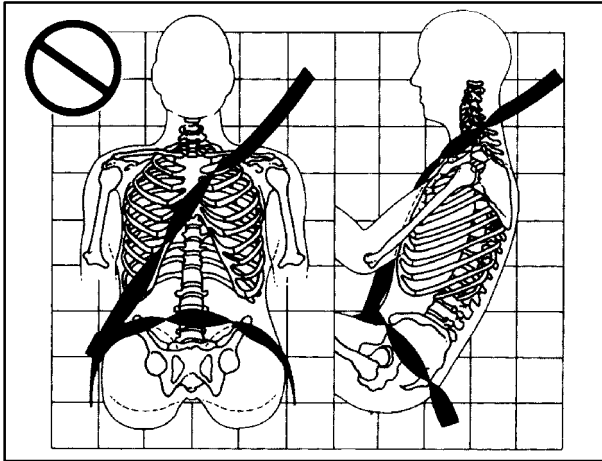

A: The belt is twisted across the body.

⚠ CAUTION:

You can be seriously injured by a twisted belt. In a crash, you wouldn't have the full width of the belt to spread impact forces. If a belt is twisted, make it straight so it can work properly, or ask your dealer to fix it.



To unlatch the belt, just push the button on the buckle. The belt should go back out of the way.

Before you close the door, be sure the belt is out of the way. If you slam the door on it, you can damage both the belt and your vehicle.

Safety Belt Use During Pregnancy

Safety belts work for everyone, including pregnant women. Like all occupants, they are more likely to be seriously injured if they don't wear safety belts.

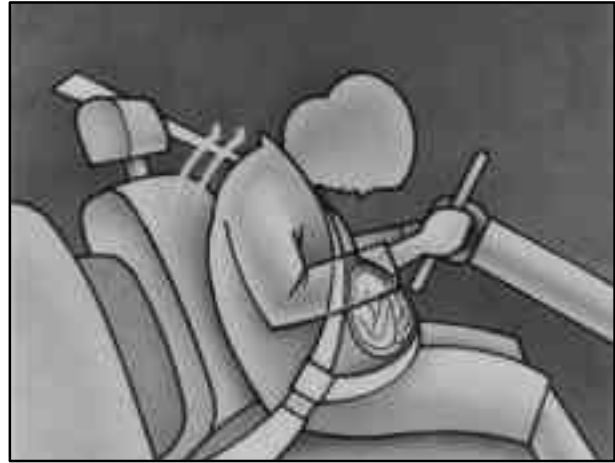

A pregnant woman should wear a lap-shoulder belt, and the lap portion should be worn as low as possible, below the rounding, throughout the pregnancy.

The best way to protect the fetus is to protect the mother. When a safety belt is worn properly, it's more likely that the fetus won't be hurt in a crash. For pregnant women, as for anyone, the key to making safety belts effective is wearing them properly.

Right Front Passenger Position

To learn how to wear the right front passenger's safety belt properly, see "Driver Position" earlier in this section.

The right front passenger's safety belt works the same way as the driver's safety belt -- except for one thing. If you ever pull the shoulder portion of the belt out all the way, you will engage the child restraint locking feature. If this happens, just let the belt go back all the way and start again.

Supplemental Restraint System (SRS)

This part explains the Supplemental Restraint System (SRS) or air bag system.

Your vehicle has air bags -- one air bag for the driver and another air bag for the right front passenger.

Frontal air bags are designed to help reduce the risk of injury from the force of an inflating air bag. But these air bags must inflate very quickly to do their job and comply with federal regulations.

Here are the most important things to know about the air bag system:

CAUTION:

You can be severely injured or killed in a crash if you aren't wearing your safety belt -- even if you have air bags. Wearing your safety belt during a crash helps reduce your chance of hitting things inside the vehicle or being ejected from it. Air bags are designed to work with safety belts, but don't replace them. Air bags are designed to work only in moderate to severe crashes where the front of your vehicle hits something. They aren't designed to inflate at all in rollover, rear or low-speed frontal crashes, or in many side crashes. And, for some unrestrained occupants, air bags may provide less protection in frontal crashes than more forceful air bags have provided in the past. Everyone in your vehicle should wear a safety belt properly -- whether or not there's an air bag for that person.

 **CAUTION:**

Air bags inflate with great force, faster than the blink of an eye. If you're too close to an inflating air bag, as you would be if you were leaning forward, it could seriously injure you. Safety belts help keep you in position before and during a crash. Always wear your safety belt, even with air bags. The driver should sit as far back as possible while still maintaining control of the vehicle.

 **CAUTION:**

Anyone who is up against, or very close to, any air bag when it inflates can be seriously injured or killed. Air bags plus lap-shoulder belts offer the best protection for adults, but not for young children and infants. Neither the vehicle's safety belt system nor its air bag system is designed for them. Young children and infants need the protection that a child restraint system can provide. Always secure children properly in your vehicle. To read how, see the part of this manual called "Children."



United States

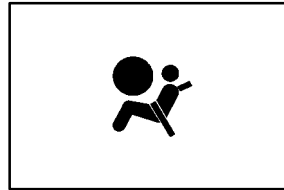

Canada

There is an air bag readiness light on the instrument panel, which shows SRS AIR BAG or the air bag symbol.

The system checks the air bag electrical system for malfunctions. The light tells you if there is an electrical problem. See “Air Bag Readiness Light” in the Index for more information.

How the Air Bag System Works



Where are the air bags?

The driver's air bag is in the middle of the steering wheel.



The right front passenger's air bag is in the instrument panel on the passenger's side.

⚠ CAUTION:

If something is between an occupant and an air bag, the bag might not inflate properly or it might force the object into that person causing severe injury or even death. The path of an inflating air bag must be kept clear. Don't put anything between an occupant and an air bag, and don't attach or put anything on the steering wheel hub or on or near any other air bag covering.

When should an air bag inflate?

An air bag is designed to inflate in a moderate to severe frontal or near-frontal crash. The air bag will inflate only if the impact speed is above the system's designed "threshold level." If your vehicle goes straight into a wall that doesn't move or deform, the threshold level is about 12 to 18 mph (19 to 29 km/h). The threshold level can vary, however, with specific vehicle design, so that it can be somewhat above or below this range. If your vehicle strikes something that will move or deform, such as a parked car, the threshold level will be higher. The air bag is not designed to inflate in rollovers, rear impacts, or in many side impacts because inflation would not help the occupant.

In any particular crash, no one can say whether an air bag should have inflated simply because of the damage to a vehicle or because of what the repair costs were. Inflation is determined by the angle of the impact and how quickly the vehicle slows down in frontal or near-frontal impacts.

What makes an air bag inflate?

In an impact of sufficient severity, the air bag sensing system detects that the vehicle is in a crash. The sensing system triggers a release of gas from the inflator, which inflates the air bag. The inflator, air bag and related hardware are all part of the air bag modules inside the steering wheel and in the instrument panel in front of the right front passenger.

How does an air bag restrain?

In moderate to severe frontal or near-frontal collisions, even belted occupants can contact the steering wheel or the instrument panel. Air bags supplement the protection provided by safety belts. Air bags distribute the force of the impact more evenly over the occupant's upper body, stopping the occupant more gradually. But air bags would not help you in many types of collisions, including rollovers, rear impacts and many side impacts, primarily because an occupant's motion is not toward those air bags. Air bags should never be regarded as anything more than a supplement to safety belts, and then only in moderate to severe frontal or near-frontal collisions.

What will you see after an air bag inflates?

After an air bag inflates, it quickly deflates, so quickly that some people may not even realize the air bag inflated. Some components of the air bag module -- the steering wheel hub for the driver's air bag, or the instrument panel for the right front passenger's bag -- will be hot for a short time. The parts of the bag that come into contact with you may be warm, but not too hot to touch. There will be some smoke and dust coming from vents in the deflated air bags. Air bag inflation doesn't prevent the driver from seeing or from being able to steer the vehicle, nor does it stop people from leaving the vehicle.

CAUTION:

When an air bag inflates, there is dust in the air. This dust could cause breathing problems for people with a history of asthma or other breathing trouble. To avoid this, everyone in the vehicle should get out as soon as it is safe to do so. If you have breathing problems but can't get out of the vehicle after an air bag inflates, then get fresh air by opening a window or door.

In many crashes severe enough to inflate an air bag, windshields are broken by vehicle deformation. Additional windshield breakage may also occur from the right front passenger air bag.

- Air bags are designed to inflate only once. After they inflate, you'll need some new parts for your air bag system. If you don't get them, the air bag system won't be there to help protect you in another crash. A new system will include air bag modules and possibly other parts. The service manual for your vehicle covers the need to replace other parts.
- Your vehicle is equipped with a crash sensing and diagnostic module, which records information about the air bag system. The module records information about the readiness of the system, when the system commands air bag inflation and driver's safety belt usage at deployment.
- Let only qualified technicians work on your air bag system. Improper service can mean that your air bag system won't work properly. See your dealer for service.

NOTICE:

If you damage the covering for the driver's or the right front passenger's air bag, the bag may not work properly. You may have to replace the air bag module in the steering wheel or both the air bag module and the instrument panel for the right front passenger's air bag. Do not open or break the air bag coverings.

Servicing Your Air Bag-Equipped Vehicle

Air bags affect how your vehicle should be serviced. There are parts of the air bag system in several places around your vehicle. You don't want the system to inflate while someone is working on your vehicle.

Your dealer and the service manual have information about servicing your vehicle and the air bag system. To purchase a service manual, see "Service and Owner Publications" in the Index.

CAUTION:

For up to 10 seconds after the ignition key is turned off and the battery is disconnected, an air bag can still inflate during improper service. You can be injured if you are close to an air bag when it inflates. Avoid yellow connectors. They are probably part of the air bag system. Be sure to follow proper service procedures, and make sure the person performing work for you is qualified to do so.

The air bag system does not need regular maintenance.

Rear Seat Passengers

It's very important for rear seat passengers to buckle up! Accident statistics show that unbelted people in the rear seat are hurt more often in crashes than those who are wearing safety belts.

Rear passengers who aren't safety belted can be thrown out of the vehicle in a crash. And they can strike others in the vehicle who are wearing safety belts.

Rear Seat Outside Passenger Positions

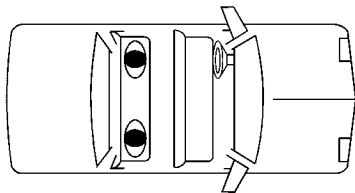

Lap-Shoulder Belt

The positions next to the windows have lap-shoulder belts. Here's how to wear one properly.



1. Pick up the latch plate and pull the belt across you. Don't let it get twisted.

The shoulder belt may lock if you pull the belt across you very quickly. If this happens, let the belt go back slightly to unlock it. Then pull the belt across you more slowly.

2. Push the latch plate into the buckle until it clicks.

Pull up on the latch plate to make sure it is secure.

When the shoulder belt is pulled out all the way, it will lock. If it does, let it go back all the way and start again. If the belt is not long enough, see “Safety Belt Extender” at the end of this section. Make sure the release button on the buckle is positioned so you would be able to unbuckle the safety belt quickly if you ever had to.



3. To make the lap part tight, pull down on the buckle end of the belt as you pull up on the shoulder part.

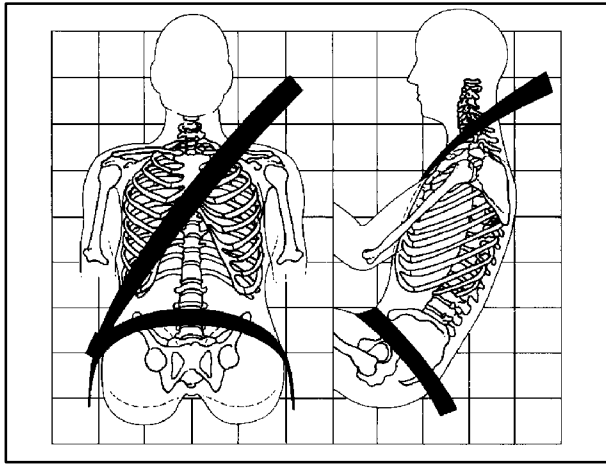

The lap part of the belt should be worn low and snug on the hips, just touching the thighs. In a crash, this applies force to the strong pelvic bones. And you'd be less likely to slide under the lap belt. If you slid under it, the belt would apply force at your abdomen. This could cause serious or even fatal injuries. The shoulder belt should go over the shoulder and across the chest. These parts of the body are best able to take belt restraining forces.

The safety belt locks if there's a sudden stop or a crash, or if you pull the belt very quickly out of the retractor.

⚠ CAUTION:

You can be seriously hurt if your shoulder belt is too loose. In a crash, you would move forward too much, which could increase injury. The shoulder belt should fit against your body.



To unlatch the belt, just push the button on the buckle.

Rear Safety Belt Comfort Guides for Children and Small Adults

Rear shoulder belt comfort guides will provide added safety belt comfort for older children who have outgrown booster seats and for small adults. When installed on a shoulder belt, the comfort guide better positions the belt away from the neck and head.

There is one guide for each outside passenger position in the rear seat. To provide added safety belt comfort for children who have outgrown child restraints and for smaller adults, the comfort guides may be installed on the shoulder belts.

Here's how to install a comfort guide and use the safety belt:



1. Pull the elastic cord out from between the edge of the seatback and the interior body to remove the guide from its storage clip.



2. Slide the guide under and past the belt. The elastic cord must be under the belt. Then, place the guide over the belt, and insert the two edges of the belt into the slots of the guide.

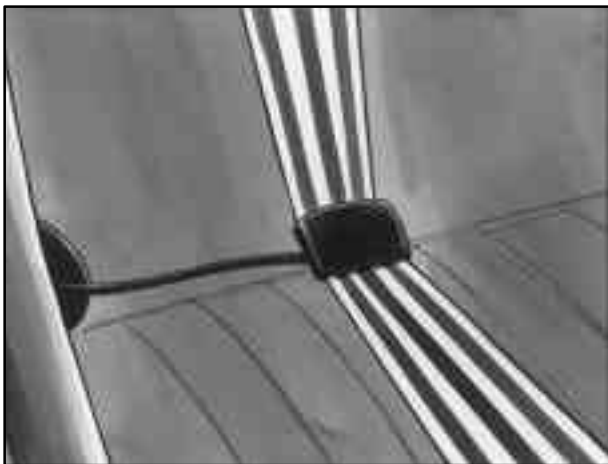

3. Be sure that the belt is not twisted and it lies flat. The elastic cord must be under the belt and the guide on top.



4. Buckle, position and release the safety belt as described in “Rear Seat Outside Passenger Positions” earlier in this section. Make sure that the shoulder belt crosses the shoulder.

To remove and store the comfort guides, squeeze the belt edges together so that you can take them out of the guides. Pull the guide upward to expose its storage clip, and then slide the guide onto the clip. Turn the guide and clip inward and place them in between the seatback and the interior body, leaving only the loop of elastic cord exposed.

Center Passenger Position

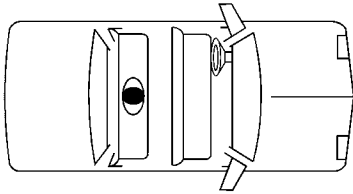

Lap Belt



When you sit in the center seating position, you have a lap safety belt, which has no retractor. To make the belt longer, tilt the latch plate and pull it along the belt.



To make the belt shorter, pull its free end as shown until the belt is snug.

Buckle, position and release it the same way as the lap part of a lap-shoulder belt. If the belt isn't long enough, see "Safety Belt Extender" at the end of this section.

Make sure the release button on the buckle is positioned so you would be able to unbuckle the safety belt quickly if you ever had to.

Children

Everyone in a vehicle needs protection! This includes infants and all other children. Neither the distance traveled nor the age and size of the traveler changes the need, for everyone, to use safety restraints. In fact, the law in every state in the United States and in every Canadian province says children up to some age must be restrained while in a vehicle.

Infants and Young Children

Every time infants and young children ride in vehicles, they should have the protection provided by the appropriate restraint. Young children should not use the vehicle's safety belts, unless there is no other choice.



CAUTION: (Continued)

For example, in a crash at only 25 mph (40 km/h), a 12-lb. (5.5 kg) baby will suddenly become a 240-lb. (110 kg) force on a person's arms. A baby should be secured in an appropriate restraint.



⚠ CAUTION:

People should never hold a baby in their arms while riding in a vehicle. A baby doesn't weigh much -- until a crash. During a crash a baby will become so heavy it is not possible to hold it.

CAUTION: (Continued)



CAUTION:

Children who are up against, or very close to, any air bag when it inflates can be seriously injured or killed. Air bags plus lap-shoulder belts offer outstanding protection for adults and older children, but not for young children and infants. Neither the vehicle's safety belt system nor its air bag system is designed for them. Young children and infants need the protection that a child restraint system can provide.

Q: What are the different types of add-on child restraints?

A: Add-on child restraints, which are purchased by the vehicle's owner, are available in four basic types. Selection of a particular restraint should take into consideration not only the child's weight, height and age but also whether or not the restraint will be compatible with the motor vehicle in which it will be used.

For most basic types of child restraints, there are many different models available. When purchasing a child restraint, be sure it is designed to be used in a motor vehicle. If it is, the restraint will have a label saying that it meets federal motor vehicle safety standards.

The restraint manufacturer's instructions that come with the restraint state the weight and height limitations for a particular child restraint. In addition, there are many kinds of restraints available for children with special needs.

 **CAUTION:**

Newborn infants need complete support, including support for the head and neck. This is necessary because a newborn infant's neck is weak and its head weighs so much compared with the rest of its body. In a crash, an infant in a rear-facing seat settles into the restraint, so the crash forces can be distributed across the strongest part of an infant's body, the back and shoulders. Infants always should be secured in appropriate infant restraints.

 **CAUTION:**

The body structure of a young child is quite unlike that of an adult or older child, for whom the safety belts are designed. A young child's hip bones are still so small that the vehicle's regular safety belt may not remain low on the hip bones, as it should. Instead, it may settle up around the child's abdomen. In a crash, the belt would apply force on a body area that's unprotected by any bony structure. This alone could cause serious or fatal injuries. Young children always should be secured in appropriate child restraints.

Restraint Systems for Children

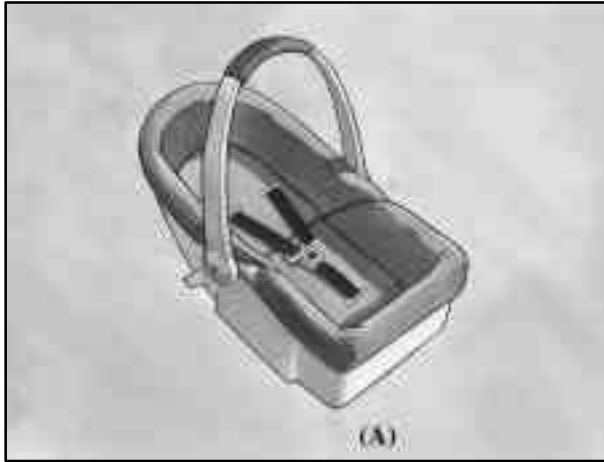

An infant car bed (A), a special bed made for use in a motor vehicle, is an infant restraint system designed to restrain or position a child on a continuous flat surface. Make sure that the infant's head rests toward the center of the vehicle.

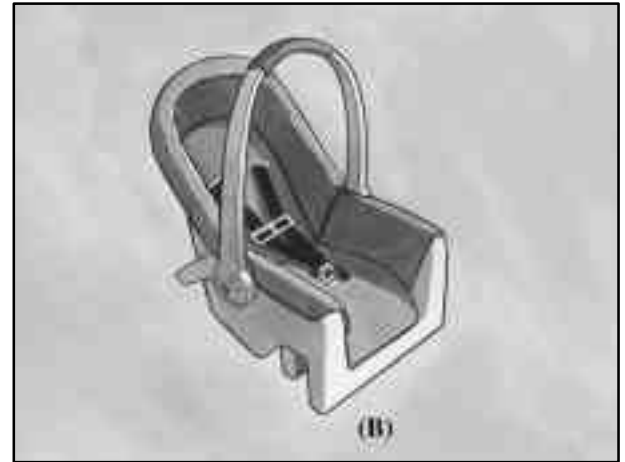

A rear-facing infant seat (B) provides restraint with the seating surface against the back of the infant. The harness system holds the infant in place and, in a crash, acts to keep the infant positioned in the restraint.

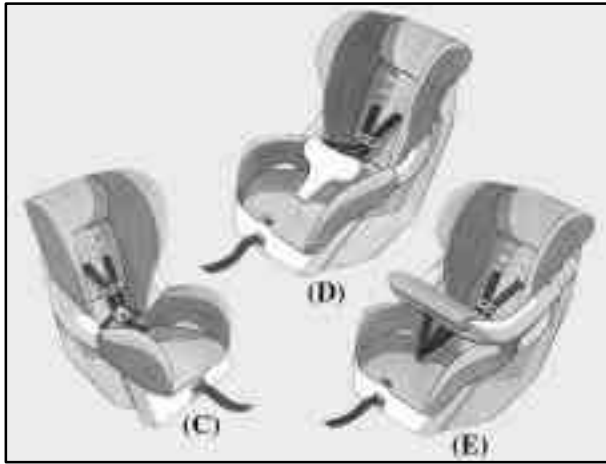

A forward-facing child seat (C-E) provides restraint for the child's body with the harness and also sometimes with surfaces such as T-shaped or shelf-like shields.

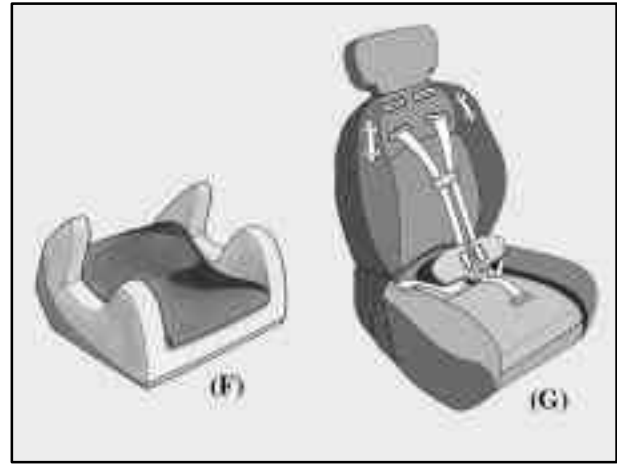

A booster seat (F-G) is a child restraint designed to improve the fit of the vehicle's safety belt system. Some booster seats have a shoulder belt positioner, and some high-back booster seats have a five-point harness. A booster seat can also help a child to see out the window.

Q: How do child restraints work?

A: A child restraint system is any device designed for use in a motor vehicle to restrain, seat, or position children. A built-in child restraint system is a permanent part of the motor vehicle. An add-on child restraint system is a portable one, which is purchased by the vehicle's owner.

For many years, add-on child restraints have used the adult belt system in the vehicle. To help reduce the chance of injury, the child also has to be secured within the restraint. The vehicle's belt system secures the add-on child restraint in the vehicle, and the add-on child restraint's harness system holds the child in place within the restraint.

One system, the three-point harness, has straps that come down over each of the infant's shoulders and buckle together at the crotch. The five-point harness system has two shoulder straps, two hip straps and a crotch strap. A shield may take the place of hip straps. A T-shaped shield has shoulder straps that are attached to a flat pad which rests low against the child's body. A shelf- or armrest-type shield has straps that are attached to a wide, shelf-like shield that swings up or to the side.

When choosing a child restraint, be sure the child restraint is designed to be used in a vehicle. If it is, it will have a label saying that it meets federal motor vehicle safety standards.

Then follow the instructions for the restraint. You may find these instructions on the restraint itself or in a booklet, or both. These restraints use the belt system in your vehicle, but the child also has to be secured within the restraint to help reduce the chance of personal injury. When securing an add-on child restraint, refer to the instructions that come with the restraint which may be on the restraint itself or in a booklet, or both, and to this manual. The child restraint instructions are important, so if they are not available, obtain a replacement copy from the manufacturer.

Where to Put the Restraint

Accident statistics show that children are safer if they are restrained in the rear rather than the front seat. General Motors, therefore, recommends that child restraints be secured in the rear seat including an infant riding in a rear-facing infant seat, a child riding in a forward-facing child seat and an older child riding in a booster seat. *Never* put a rear-facing child restraint in the front passenger seat. Here's why:

CAUTION:

A child in a rear-facing child restraint can be seriously injured or killed if the right front passenger's air bag inflates. This is because the back of the rear-facing child restraint would be very close to the inflating air bag. Always secure a rear-facing child restraint in a rear seat.

You may secure a forward-facing child restraint in the right front seat, but before you do, always move the front passenger seat as far back as it will go. It's better to secure the child restraint in a rear seat.

Wherever you install it, be sure to secure the child restraint properly.

Keep in mind that an unsecured child restraint can move around in a collision or sudden stop and injure people in the vehicle. Be sure to properly secure any child restraint in your vehicle -- even when no child is in it.

Top Strap

Some child restraints have a top strap, or "top tether." It can help restrain the child restraint during a collision. For it to work, a top strap must be properly anchored to the vehicle. Some top strap-equipped child restraints are designed for use with or without the top strap being anchored. Others require the top strap always to be anchored. Be sure to read and follow the instructions for your child restraint. If yours requires that the top strap be anchored, don't use the restraint unless it is anchored properly.

If the child restraint does not have a top strap, one can be obtained, in kit form, for many child restraints. Ask the child restraint manufacturer whether or not a kit is available.

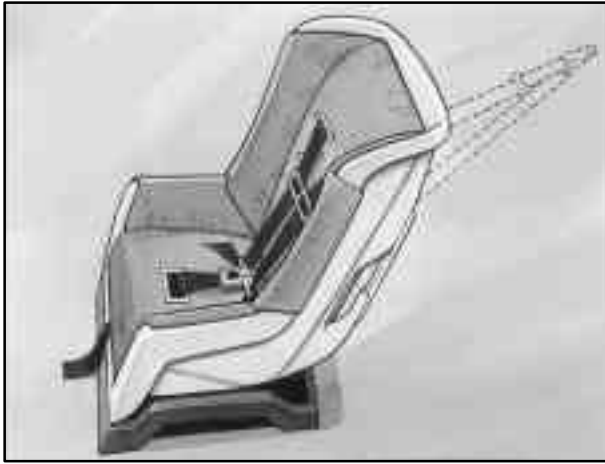

In Canada, the law requires that forward-facing child restraints have a top strap, and that the strap be anchored. In the United States, some child restraints also have a top strap. If your child restraint has a top strap, it should be anchored.

Anchor the top strap to one of the following anchor points. Be sure to use an anchor point located on the same side of the vehicle as the seating position where the child restraint will be placed.

Once you have the top strap anchored, you'll be ready to secure the child restraint itself. Tighten the top strap when and as the child restraint manufacturer's instructions say.

Your vehicle has top strap anchors already installed for the rear seating positions. You'll find them behind the rear seat on the filler panel.

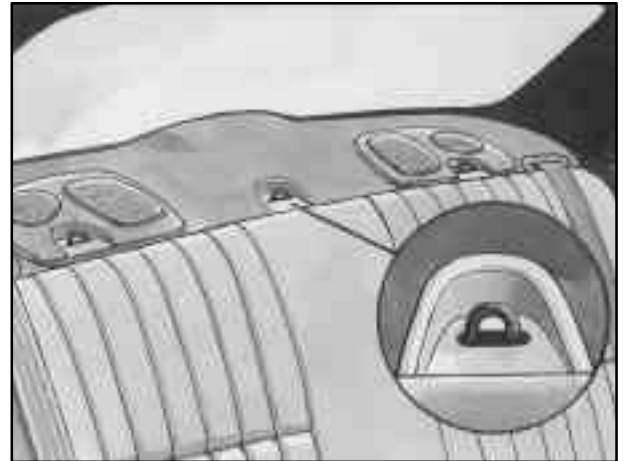

Securing a Child Restraint in a Rear Outside Seat Position

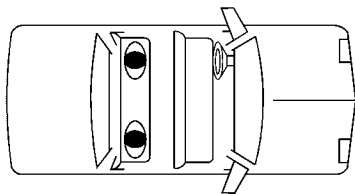

You'll be using the lap-shoulder belt. See the earlier part about the top strap if the child restraint has one. Be sure to follow the instructions that came with the child restraint. Secure the child in the child restraint when and as the instructions say.

1. Put the restraint on the seat.
2. Pick up the latch plate, and run the lap and shoulder portions of the vehicle's safety belt through or around the restraint. The child restraint instructions will show you how.

If the shoulder belt goes in front of the child's face or neck, put it behind the child restraint.



3. Buckle the belt. Make sure the release button is positioned so you would be able to unbuckle the safety belt quickly if you ever had to.



4. Pull the rest of the shoulder belt all the way out of the retractor to set the lock.



5. To tighten the belt, feed the shoulder belt back into the retractor while you push down on the child restraint. If you're using a forward-facing child restraint, you may find it helpful to use your knee to push down on the child restraint as you tighten the belt.
6. Push and pull the child restraint in different directions to be sure it is secure.

To remove the child restraint, just unbuckle the vehicle's safety belt and let it go back all the way. The safety belt will move freely again and be ready to work for an adult or larger child passenger.

Securing a Child Restraint in the Center Rear Seat Position

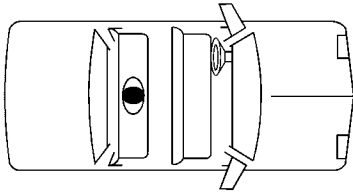

You'll be using the lap belt. Be sure to follow the instructions that came with the child restraint. Secure the child in the child restraint when and as the instructions say.

See the earlier part about the top strap if the child restraint has one.



1. Make the belt as long as possible by tilting the latch plate and pulling it along the belt.
2. Put the restraint on the seat.
3. Run the vehicle's safety belt through or around the restraint. The child restraint instructions will show you how.



4. Buckle the belt. Make sure the release button is positioned so you would be able to unbuckle the safety belt quickly if you ever had to.
 5. To tighten the belt, pull its free end while you push down on the child restraint. If you're using a forward-facing child restraint, you may find it helpful to use your knee to push down on the child restraint as you tighten the belt.
 6. Push and pull the child restraint in different directions to be sure it is secure.
- To remove the child restraint, just unbuckle the vehicle's safety belt. It will be ready to work for an adult or larger child passenger.

Securing a Child Restraint in the Right Front Seat Position

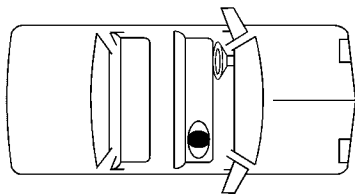

Your vehicle has a right front passenger air bag. *Never* put a rear-facing child restraint in this seat. Here's why:

CAUTION:

A child in a rear-facing child restraint can be seriously injured or killed if the right front passenger's air bag inflates. This is because the back of the rear-facing child restraint would be very close to the inflating air bag. Always secure a rear-facing child restraint in the rear seat.

Although a rear seat is a safer place, you can secure a forward-facing child restraint in the right front seat.

You'll be using the lap-shoulder belt. See the earlier part about the top strap if the child restraint has one. Be sure to follow the instructions that came with the child restraint. Secure the child in the child restraint when and as the instructions say.

1. Because your vehicle has a right front passenger air bag, always move the seat as far back as it will go before securing a forward-facing child restraint. See "Seats" in the Index.
2. Put the restraint on the seat.
3. Pick up the latch plate, and run the lap and shoulder portions of the vehicle's safety belt through or around the restraint. The child restraint instructions will show you how.

If the shoulder belt goes in front of the child's face or neck, put it behind the child restraint.



4. Buckle the belt. Make sure the release button is positioned so you would be able to unbuckle the safety belt quickly if you ever had to.



5. Pull the rest of the shoulder belt all the way out of the retractor to set the lock.



6. To tighten the belt, feed the shoulder belt back into the retractor while you push down on the child restraint. You may find it helpful to use your knee to push down on the child restraint as you tighten the belt.

7. Push and pull the child restraint in different directions to be sure it is secure.

To remove the child restraint, just unbuckle the vehicle's safety belt and let it go back all the way. The safety belt will move freely again and be ready to work for an adult or larger child passenger.

Older Children



Older children who have outgrown booster seats should wear the vehicle's safety belts.

If you have the choice, a child should sit next to a window so the child can wear a lap-shoulder belt and get the additional restraint a shoulder belt can provide.

Q: What is the proper way to wear safety belts?

A: If possible, an older child should wear a lap-shoulder belt and get the additional restraint a shoulder belt can provide. The shoulder belt should not cross the face or neck. The lap belt should fit snugly below the hips, just touching the top of the thighs. It should never be worn over the abdomen, which could cause severe or even fatal internal injuries in a crash.

Accident statistics show that children are safer if they are restrained in the rear seat.

In a crash, children who are not buckled up can strike other people who are buckled up, or can be thrown out of the vehicle. Older children need to use safety belts properly.



⚠ CAUTION:

Never do this.

Here two children are wearing the same belt. The belt can't properly spread the impact forces. In a crash, the two children can be crushed together and seriously injured. A belt must be used by only one person at a time.

- Q:** What if a child is wearing a lap-shoulder belt, but the child is so small that the shoulder belt is very close to the child's face or neck?
- A:** Move the child toward the center of the vehicle, but be sure that the shoulder belt still is on the child's shoulder, so that in a crash the child's upper body would have the restraint that belts provide. If the child is sitting in a rear seat outside position, see "Rear Safety Belt Comfort Guides" in the Index. If the child is so small that the shoulder belt is still very close to the child's face or neck, you might want to place the child in the center seat position, the one that has only a lap belt.



⚠ CAUTION:

Never do this.

Here a child is sitting in a seat that has a lap-shoulder belt, but the shoulder part is behind the child. If the child wears the belt in this way, in a crash the child might slide under the belt. The belt's force would then be applied right on the child's abdomen. That could cause serious or fatal injuries.

Wherever the child sits, the lap portion of the belt should be worn low and snug on the hips, just touching the child's thighs. This applies belt force to the child's pelvic bones in a crash.

Safety Belt Extender

If the vehicle's safety belt will fasten around you, you should use it.

But if a safety belt isn't long enough to fasten, your dealer will order you an extender. It's free. When you go in to order it, take the heaviest coat you will wear, so the extender will be long enough for you. The extender will be just for you, and just for the seat in your vehicle that you choose. Don't let someone else use it, and use it only for the seat it is made to fit. To wear it, just attach it to the regular safety belt.

Checking Your Restraint Systems

Now and then, make sure the safety belt reminder light and all your belts, buckles, latch plates, retractors and anchorages are working properly. Look for any other loose or damaged safety belt system parts. If you see anything that might keep a safety belt system from doing its job, have it repaired.

Torn or frayed safety belts may not protect you in a crash. They can rip apart under impact forces. If a belt is torn or frayed, get a new one right away.

Also look for any opened or broken air bag covers, and have them repaired or replaced. (The air bag system does not need regular maintenance.)

Replacing Restraint System Parts After a Crash

If you've had a crash, do you need new belts?

After a very minor collision, nothing may be necessary. But if the belts were stretched, as they would be if worn during a more severe crash, then you need new parts.

If belts are cut or damaged, replace them. Collision damage also may mean you will need to have safety belt or seat parts repaired or replaced. New parts and repairs may be necessary even if the belt wasn't being used at the time of the collision.

If an air bag inflates, you'll need to replace air bag system parts. See the part on the air bag system earlier in this section.



Section 2 Features and Controls

Here you can learn about the many standard and optional features on your vehicle, and information on starting, shifting and braking. Also explained are the instrument panel and the warning systems that tell you if everything is working properly -- and what to do if you have a problem.

2-2	Windows	2-47	Engine Exhaust
2-4	Keys	2-48	Running Your Engine While You're Parked
2-6	Door Locks	2-49	Tilt Wheel
2-10	Remote Keyless Entry System (If Equipped)	2-49	Turn Signal/Multifunction Lever
2-14	Multifunction Alarm Locks and Lighting Choices	2-55	Exterior Lamps
2-25	Trunk	2-57	Interior Lamps
2-27	Theft	2-60	Mirrors
2-28	Content Theft-Deterrent System (If Equipped)	2-64	Storage Compartments
2-30	PASS-Key [®] III	2-68	Accessory Power Outlet
2-32	New Vehicle "Break-In"	2-69	Auxiliary Power Connection (Power Drop)
2-33	Ignition Positions	2-69	OnStar [®] System (If Equipped)
2-34	Starting Your Engine	2-73	Power Sunroof (Option)
2-38	Engine Coolant Heater (Option)	2-74	The Instrument Panel -- Your Information System
2-39	Automatic Transaxle Operation	2-78	Warning Lights, Gages and Indicators
2-43	Parking Brake	2-91	Driver Information Center (DIC)
2-44	Shifting Into PARK (P)	2-93	Trip Computer (If Equipped)
2-46	Shifting Out of PARK (P)	2-96	Head-Up Display (HUD) (Option)
2-47	Parking Over Things That Burn		

Windows

CAUTION:

Leaving children in a vehicle with the windows closed is dangerous. A child can be overcome by the extreme heat and can suffer permanent injuries or even death from heat stroke. Never leave a child alone in a vehicle, especially with the windows closed in warm or hot weather.



Power Windows



Two-Door Version Shown

Use the switches on the driver's door armrest to operate each of the windows when the ignition is on or when Retained Accessory Power (RAP) is active. See "Retained Accessory Power (RAP)" in the Index. In addition, each passenger door has a window switch.

Express-Down Window

The driver's window switch has an auto-down feature. This switch is labeled AUTO. Tap the rear of the switch, and the driver's window will open a small amount. If the rear of the switch is fully pressed and released, the window will go all the way down.

To stop the window while it is lowering, press the front of the switch. To raise the window, press and hold the front of the switch.

Lock-Out Switch (Four-Door Models)

On four-door models, the driver's window switch includes a lock-out feature. Push LOCK OUT to stop front and rear passengers from using their window switches. The driver can still control all the windows with the lock on. Push LOCK OUT again to return to normal window operation. When the colored band on the switch is showing, the passengers can operate their windows.

Keys

CAUTION:

Leaving children in a vehicle with the ignition key is dangerous for many reasons. A child or others could be badly injured or even killed.

They could operate the power windows or other controls or even make the vehicle move. Don't leave the keys in a vehicle with children.





This key can be used for the ignition, as well as all door locks and storage compartments.

When a new key is delivered, it will come with a bar coded tag attached to the key ring. Keep the bar code tag that came with the original keys. Give this tag to your dealer if you need a new key made.

Your vehicle has the PASS-Key[®] III vehicle theft system. The key has a transponder in the key head that matches a decoder in the vehicle's steering column. If a replacement key or an additional key is needed, it must be purchased from your dealer. The key will have PK3 stamped on it.

Any new PASS-Key[®] III key must be programmed before it will start your vehicle. See "PASS-Key[®] III" in the Index for more information on programming your new key.

In an emergency, contact Pontiac Roadside Assistance. See "Roadside Assistance" in the Index for more information.

NOTICE:

Your vehicle has a number of features that can help prevent theft. But you can have a lot of trouble getting into your vehicle if you ever lock your key inside. You may even have to damage your vehicle to get in. So be sure you have an extra key.

If your vehicle is equipped with the OnStar system with an active subscription and you lock your keys inside the vehicle, OnStar may be able to send a command to unlock your vehicle. See "OnStar" in the Index for more information.

Door Locks

CAUTION:

Unlocked doors can be dangerous.

- Passengers -- especially children -- can easily open the doors and fall out of a moving vehicle. When a door is locked, the handle won't open it. You increase the chance of being thrown out of the vehicle in a crash if the doors aren't locked. So, wear safety belts properly and lock the doors whenever you drive.
- Young children who get into unlocked vehicles may be unable to get out. A child can be overcome by extreme heat and can suffer permanent injuries or even death from heat stroke. Always lock your vehicle whenever you leave it.
- Outsiders can easily enter through an unlocked door when you slow down or stop your vehicle. Locking your doors can help prevent this from happening.

There are several ways to lock and unlock your vehicle.

To lock or unlock your vehicle from the outside, use your key or remote keyless entry transmitter (if equipped).



To unlock or lock your doors from inside the vehicle, push the manual lever rearward or forward.

Power Door Locks



To unlock all doors from inside the vehicle, press the front of the power door lock switch on either front door. If your vehicle is equipped with a content theft-deterrent system and it is armed, the power door lock switch will not unlock the doors until the system is disarmed. See “Content Theft-Deterrent” in the Index for more information on disarming the system.

You can lock all doors from inside the vehicle by pressing the rear of the power lock switch on either front door. If your vehicle is equipped with the content theft-deterrent system, it may be programmed to arm the system when the rear of the power lock switch is pressed. See “Content Theft-Deterrent System” in the Index for more details.

Last Door Closed Locking

The last door closed locking feature makes it more convenient for you to use your power door locks to lock all the doors when leaving your vehicle. When a door is open, three chimes will sound the first time you attempt to lock the doors using the power door lock switch or the keyless entry transmitter (if equipped). The chimes indicate that the last door closed locking is being used. All doors can be opened for five seconds from the time the last door has been closed. Five seconds after the last door is closed, all doors will lock. You can lock the doors immediately by using the power door lock switch or the remote keyless entry transmitter (if equipped).

The last door closed locking feature will activate when the ignition is in RUN or ACCESSORY.

To turn the last door closed locking feature on or off, see “Locks and Lighting Choices” in the Index.

Automatic Door Locks

All of the doors will lock automatically when you move your shift lever out of PARK (P). All doors will unlock automatically when the ignition is turned off while the shift lever is in PARK (P). If you prefer to have your doors unlocked automatically at any time, see “Locks and Lighting Choices” in the Index.

If someone needs to get in or out of the vehicle after the doors have been automatically locked, place the shift lever into PARK (P). Unlock all doors using the power door lock switch or unlock the door you want using the inside manual lever. If you have programmed the Automatic Door Locks (see “Locks and Lighting Choices” in the Index) to unlock the doors when the shift lever is shifted into PARK (P), then the doors will automatically unlock for you. Also, the doors will automatically lock when you move your shift lever out of PARK (P) with the ignition on.

If you don't want the doors to unlock automatically when you turn the ignition off, see “Locks and Lighting Choices” in the Index.

Rear Door Security Locks (Four-Door Models)

Four-door vehicles are equipped with rear door security locks that help prevent passengers from opening the rear doors of your vehicle from the inside. To use one of these locks do the following:

1. Open one of the rear doors.

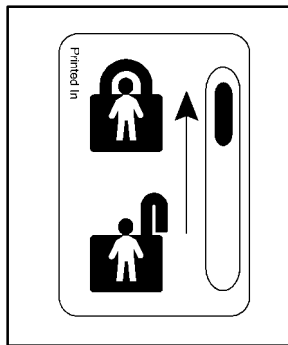

2. On the inside of the rear door will be a lock with this label. Slide the lever located next to the label upward to engage the lock.

3. Close the door.
4. Repeat the procedure on the other rear door lock.

To disengage the lock(s), reverse the steps.

The rear doors of your vehicle cannot be opened from inside the vehicle when this feature is in use. If you want to open a rear door when the security lock is on, unlock the door from the inside and then open the door from the outside.

Lockout Prevention

The lockout deterrent feature makes it difficult for you to lock your keys in the vehicle. If the driver's door is open while the keys are in the ignition, you will not be able to use your power door lock switch.

This feature cannot guarantee that you'll never be locked out of your vehicle. If you don't leave the keys in the ignition, or if you use the manual door lock, you could still lock your keys inside your vehicle. Always remember to take your keys with you.

To turn this feature on or off, see "Locks and Lighting Choices" in the Index.

Leaving Your Vehicle

If you are leaving the vehicle, take your keys, open your door and set the locks from inside. Then get out and close the door.

Remote Keyless Entry System (If Equipped)

If your vehicle has this feature, you can lock and unlock your doors or unlock your trunk from about 3 feet (1 m) up to 30 feet (9 m) away using the remote keyless entry transmitter supplied with your vehicle.

Your keyless entry system operates on a radio frequency subject to Federal Communications Commission (FCC) Rules and with Industry Canada.

This device complies with Part 15 of the FCC Rules. Operation is subject to the following two conditions: (1) this device may not cause harmful interference, and (2) this device must accept any interference received, including interference that may cause undesired operation.

This device complies with RSS-210 of Industry Canada. Operation is subject to the following two conditions: (1) this device may not cause interference, and (2) this device must accept any interference received, including interference that may cause undesired operation of the device.

Changes or modifications to this system by other than an authorized service facility could void authorization to use this equipment.

At times you may notice a decrease in range. This is normal for any remote keyless entry system. If the transmitter does not work or if you have to stand closer to your vehicle for the transmitter to work, try this:

- Check the distance. You may be too far from your vehicle. You may need to stand closer during rainy or snowy weather.
- Check the location. Other vehicles or objects may be blocking the signal. Take a few steps to the left or right, hold the transmitter higher, and try again.
- Check to determine if battery replacement is necessary. See the instructions that follow.
- If you're still having trouble, see your dealer or a qualified technician for service.

Operation

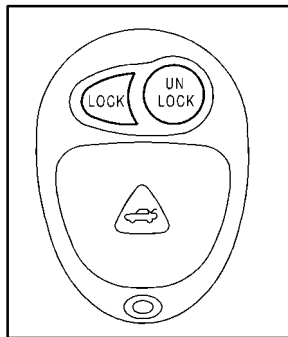

Three-Button Key Fob

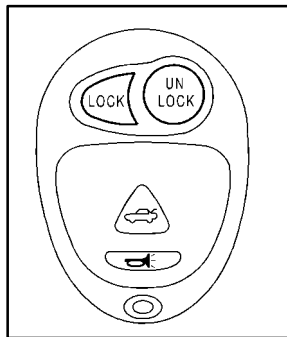

Four-Button Key Fob

Remote All Door Lock

LOCK: To lock all the doors, press LOCK on the remote keyless entry transmitter. See “Power Door Locks” in the Index for more details on power door lock features. If your vehicle is equipped with the content theft-deterrent system, the LOCK button may arm the system. See “Content Theft-Deterrent” in the Index for more details.

Remote Driver’s Door and All Door Unlock

UNLOCK: When you press UNLOCK on the remote keyless entry transmitter, only the driver’s door will unlock. If you press UNLOCK again within five seconds, all the doors will unlock. If you would like all the doors to unlock the first time you press UNLOCK, see “Locks and Lighting Choices” in the Index. If your vehicle is equipped with the content theft-deterrent system, the UNLOCK button on the remote keyless entry transmitter will disarm the system. See “Content Theft-Deterrent” in the Index for more details.

Remote Trunk Release

 **(Open Trunk):** Press the button with the trunk symbol on your remote keyless entry transmitter to open your trunk. The transaxle must be in PARK (P) for this feature to operate.

Remote Panic Alarm (If Equipped)

 **(Panic Alarm):** When you press the panic alarm button with the horn symbol on the four-button remote keyless entry transmitter, the headlamps will flash and the horn will sound. This will allow you to attract attention if needed.

Remote Lock/Unlock Confirmation (If Equipped)

(Remote Lock/Unlock Confirmation): Press this button to use this feature, if equipped, this feature provides feedback to the holder of the remote keyless entry transmitter that a command has been received by the keyless entry receiver. To signal that a command has been received, the headlamps will flash and the horn may sound briefly. To program the various modes available, see “Locks and Lighting Choices” in the Index.

Matching Transmitter(s) to Your Vehicle

Each remote keyless entry transmitter is coded to prevent another transmitter from unlocking your vehicle. If a transmitter is lost or stolen, a replacement can be purchased through your dealer. Remember to bring any remaining transmitters with you when you go to your dealer. When the dealer matches the replacement transmitter to your vehicle, any remaining transmitters must also be matched. Once your dealer has coded the new transmitter, the lost transmitter will not unlock your vehicle. Each vehicle can have a maximum of four transmitters matched to it.

Battery Replacement

Under normal use, the battery in your remote keyless entry transmitter should last about three years.

You can tell the battery is weak if the transmitter won't work at the normal range in any location. If you have to get close to your vehicle before the transmitter works, it's probably time to change the battery.

NOTICE:

When replacing the battery, use care not to touch any of the circuitry. Static from your body transferred to these surfaces may damage the transmitter.



To replace the battery do the following:

1. Insert a flat object like a coin into the slot on the side of the transmitter and twist to separate the halves.
2. Gently pry the battery out of the transmitter. Do not use the metal flanges to “pop out” the battery.
3. Put the new battery into the transmitter as shown on the transmitter. Use a type CR2032 battery, or equivalent type.
4. Reassemble the transmitter. Make sure the halves are snapped together tightly so water will not get in.
5. Check the transmitter operation.

Multifunction Alarm Locks and Lighting Choices

Your vehicle's locks and lighting systems can be programmed with several different features. The features you can program depend on the options that came with your vehicle. The following chart shows the features that can be programmed. To determine which features your vehicle is equipped with, follow the steps listed for entering the programming mode.

Feature							
Number of Chimes Sounded	Delayed Illumination/Exit Lighting	Automatic Door Locks	Last Door Closed Locking/Lockout Deterrent	Remote Driver's Door Unlock Control	Remote Lock/Unlock Confirmation	Content Theft	Content Theft Arming/Disarming
2	X	X	X				
3	X	X	X	X			
4	X	X	X	X	X	X	X

Entering Programming Mode

To program features, your vehicle must be in this programming mode. Follow these steps:

1. Turn the ignition key to LOCK or OFF.
2. Remove the MALL PGM fuse from the instrument panel fuse block. See “Fuses and Circuit Breakers” in the Index.
3. Turn the ignition key to ACCESSORY.
4. Count the number of chimes you hear. You will hear up to four chimes, depending on vehicle content. See “Multifunction Alarm Locks and Lighting Choices” earlier in this section.

You can now program your choices. After programming a feature, you can exit the programming mode at any time.

Exiting Programming Mode

To exit programming mode, turn the key from ACCESSORY to OFF and put the MALL PGM fuse back into the instrument panel fuse block.

Delayed Illumination and Exit Lighting

With delayed illumination, the interior lamps will stay on for about 25 seconds after all doors are closed.

With exit lighting, the interior lamps will come on and stay on for about 25 seconds whenever you remove the key from the ignition.

Programmable Modes

Mode 1: Both Features Off – The interior lamps will turn on or off at the same instant that a door is opened or closed.

Mode 2: Delayed Illumination Only – The interior lamps will stay on for about 25 seconds after all the doors are closed, or until you lock the doors.

Mode 3: Exit Lighting Only – The interior lamps will come on whenever you remove the key from the ignition and stay on for about 25 seconds, or until you lock the doors.

Mode 4: Both Features On – This combines Modes 2 and 3.

Before your vehicle was shipped from the factory, it was programmed to Mode 4. The mode to which your vehicle was programmed may have been changed since it left the factory. To determine the mode to which your vehicle is programmed or to program your vehicle to a different mode, do the following:

1. Follow the instructions for “Entering Programming Mode” listed previously.
2. Turn the interior lamps thumbwheel all the way to the right and then back slightly to the left.
3. Count the number of chimes you hear. The number of chimes tells you which mode your vehicle is set for. If you do not wish to change the current mode, you can either exit the programming mode by following the instructions earlier in this section or program the next feature available on your vehicle.
4. Turn the interior lamps thumbwheel all the way to the right and then back slightly to the left again to change the current mode.
5. Repeat Step 4 until you hear the number of chimes that matches the number of the mode you want.

The mode you selected is now set. You can either exit the programming mode by following the instructions earlier in this section or program the next feature available on your vehicle.

Automatic Door Locks

With automatic door locks, all doors will automatically lock when you shift out of PARK (P) and automatically unlock when the ignition is turned to OFF.

Programmable Modes

Mode 1: Both Features Off – Automatic door locking and unlocking are disabled. You will always need to lock your doors manually before driving to increase occupant safety.

- All doors will lock when you press the power door lock switch rearward or when you press the LOCK on the remote keyless entry transmitter (if equipped).
- All doors will unlock when you press the power door lock switch forward or when you press UNLOCK on the remote keyless entry transmitter (if equipped).

Mode 2: Automatic Door Locking Only

- Automatic Door Unlocking: The automatic door unlock feature is turned off.
- Automatic Door Locking: Shift out of PARK (P) with the ignition on and the driver’s door closed, all doors will lock automatically.

Mode 3: Automatic Unlocking with the Ignition Off

- Automatic Door Unlocking: Turn off the ignition with the transaxle in PARK (P) and all doors will unlock automatically.
- Automatic Door Locking: Shift out of PARK (P) with the ignition on and the driver's door closed and all doors will lock automatically.

Mode 4: Automatic Unlocking and Locking with Transaxle in PARK (P)

- Automatic Door Unlocking: Shift into PARK (P) with the ignition on and all doors will unlock automatically.
- Automatic Door Locking: Shift out of PARK (P) with the ignition on and the driver's door closed and all doors will lock automatically.

Before your vehicle was shipped from the factory, it was programmed to Mode 3. The mode to which your vehicle was programmed may have been changed since it left the factory. To determine the mode to which your vehicle is programmed or to program your vehicle to a different mode, do the following:

1. Follow the instructions for "Entering Programming Mode" listed previously.
2. Press LOCK on the power door lock switch.
3. Count the number of chimes you hear. The number of chimes tells you which mode your vehicle is set for. If you do not wish to change the current mode, you can either exit the programming mode by following the instructions earlier in this section or program the next feature available on your vehicle.
4. Press LOCK on the power door lock switch again to change the current mode.
5. Repeat Step 4 until you hear the number of chimes that matches the mode you want.

The mode you selected is now set. You can either exit the programming mode by following the instructions earlier in this section or program the next feature available on your vehicle.

Last Door Closed Locking and Lockout Prevention

With the last door closed locking and lockout prevention features, your vehicle will do the following:

- If you leave your key in the ignition and leave the driver's door open, you won't be able to use the power door lock switches to lock the doors.
- The doors will not lock when you press LOCK on the driver's door arm rest or the lock button on the remote keyless entry transmitter (if equipped) while any door is open. Instead, you will hear three chimes which let you know that the last door closed locking feature is in operation. Five seconds after all the doors are closed, all the doors will automatically lock.

Programmable Modes

Mode 1: Both Features Off – Doors will always lock immediately when you press LOCK on the driver's door armrest or the remote keyless entry transmitter, if equipped.

Mode 2: Lockout Prevention Only – If you leave your key in the ignition with the driver's door open, you will not be able to lock the doors using your power locks.

Mode 3: Last Door Closed Locking Only – If the power door lock switch or remote keyless entry transmitter, if equipped, is used to lock the vehicle while any door is open and the key is out of the ignition, you will hear three chimes. The doors will not lock. Five seconds after the last door is closed, all doors will lock.

Mode 4: Both Features On – This combines Modes 2 and 3.

Before your vehicle was shipped from the factory, it was programmed to Mode 4. The mode to which your vehicle was programmed may have changed since it left the factory. To determine the mode to which your vehicle is programmed or to program your vehicle to a different mode, do the following:

1. Follow the instructions for “Entering Programming Mode” listed previously.
2. Press UNLOCK on the driver's door armrest or the unlock button on the remote keyless entry transmitter.
3. Count the number of chimes you hear. The number of chimes tells you which mode your vehicle is set for. If you do not wish to change the current mode, you can either exit the programming mode by following the instructions earlier in this section or program the next feature available on your vehicle.

4. Press UNLOCK again to change the current mode.
5. Repeat Step 4 until you hear the number of chimes that matches the mode you want.

The mode you selected is now set. You can either exit the programming mode by following the instructions earlier in this section or program the next feature available on your vehicle.

Remote Driver's Unlock Control (If Equipped)

With the remote driver's unlock control feature, you can program your vehicle to do the following:

- When you press UNLOCK on your remote keyless entry transmitter, the driver's door will unlock, and
- when you press UNLOCK on your remote keyless entry transmitter again within five seconds, all doors will unlock.

Programmable Modes

Mode 1: Remote All Doors Unlock – When you press UNLOCK on the remote keyless entry transmitter once, all doors will unlock.

Mode 2: Remote Driver's Door and All Doors Unlock – When you press UNLOCK on the remote keyless entry transmitter once, the driver's door will unlock. If you press UNLOCK again within five seconds, all doors will unlock.

Before your vehicle was shipped from the factory, it was programmed to Mode 2. The mode to which your vehicle was programmed may have been changed since it left the factory. To determine the mode to which your vehicle is programmed or to program your vehicle to a different mode, do the following:

1. Follow the instructions for "Entering Programming Mode" listed previously.
2. Press UNLOCK on the remote keyless entry transmitter.
3. Count the number of chimes you hear. The number of chimes tells you which mode the vehicle is set for. If you do not wish to change the current mode, you can either exit the programming mode by following the instructions earlier in this section or program the next feature available on your vehicle.
4. Press UNLOCK on the remote keyless entry transmitter again to change the current mode.
5. Repeat Step 4 until you hear the number of chimes that matches the mode you want.

The mode you selected is now set. You can either exit the programming mode by following the instructions earlier in this section or program the next feature available on your vehicle.

Remote Lock and Unlock Confirmation (If Equipped)

With the remote lock and unlock confirmation feature, you can program your vehicle to do the following:

- When you use the remote keyless entry transmitter to unlock your vehicle, your headlamps will flash to let you know the command has been received. If you press LOCK on the remote keyless entry transmitter again within five seconds, the horn will sound briefly and the headlamps will flash to let you know your vehicle is locked.
- When you use the remote keyless entry transmitter to unlock your vehicle, your headlamps will flash to let you know the command has been received.

Programmable Modes

Mode 1: Both Features Off – Remote lock and unlock confirmation are disabled.

Mode 2: Exterior Lamps Flash Only

- Remote Lock Confirmation: When you use the remote keyless entry transmitter to lock the vehicle, the headlamps will flash to let you know the command is received.

- Remote Unlock Confirmation: When you use the remote keyless entry transmitter to unlock the vehicle or open the trunk, the headlamps will flash to let you know when the command is received.

Mode 3: Exterior Lamps Flash and Horn Sound

- Remote Lock Confirmation: When you use the remote keyless entry transmitter to lock the vehicle, the horn will sound briefly and the headlamps will flash to let you know the command is received.
- Remote Unlock Confirmation: When you use the remote keyless entry transmitter to unlock the vehicle or open the trunk, the headlamps will flash to let you know the command is received.

Mode 4: Exterior Lamps and Horn Sound – on second LOCK press only.

- Remote Lock Confirmation: When you use the remote keyless entry transmitter to lock the vehicle, the headlamps will flash to let you know the command is received. The horn will sound briefly and the headlamps will flash if you press the LOCK button again within five seconds.
- Remote Unlock Confirmation: When you use the remote keyless entry transmitter to unlock the vehicle or open the trunk, the headlamps will flash to let you know the command is received.

Before your vehicle was shipped from the factory, it was programmed to Mode 4. The mode to which your vehicle was programmed may have been changed since it left the factory. To determine the mode to which your vehicle is programmed or to program your vehicle to a different mode, do the following:

1. Follow the instructions for “Entering Programming Mode” listed previously.
2. Press the LOCK button on the remote keyless entry transmitter.
3. Count the number of chimes you hear. The number of chimes tells you which mode the vehicle is set for. If you do not wish to change the current mode, you can either exit the programming mode by following the instructions earlier in this section or program the next feature available on your vehicle.
4. Press LOCK on the remote keyless entry transmitter again to change the current mode.
5. Repeat Step 4 until you hear the number of chimes that matches the number of the mode you want.

The mode you selected is now set. You can either exit the programming mode by following the instructions earlier in this section or program the next feature available on your vehicle.

Content Theft-Deterrent System (If Equipped)

Your vehicle may be equipped with a content theft-deterrent alarm system. Once armed, the system will go off if someone tries to enter the vehicle without using the remote keyless entry transmitter or the correct key, or when someone turns the ignition on with an incorrect key. The horn will sound, and your vehicle’s headlamps will flash for about two minutes.

Programmable Modes

Mode 1: Not Used

Mode 2: Content Theft On – If anyone tampers with the trunk lock or opens a door while the content theft-deterrent system is armed, an alarm will sound and the headlamps will flash for up to two minutes.

Mode 3: Content Theft Off – The content theft-deterrent system is always disarmed.

Mode 4: Not Used

Before your vehicle was shipped from the factory, it was programmed to Mode 2. The mode to which your vehicle was programmed may have been changed since it left the factory. To determine the mode to which your vehicle is programmed or to program your vehicle to a different mode, do the following:

1. Follow the instructions for “Entering Programming Mode” listed previously.
2. Turn the parking lamps on, then off.
3. Count the number of chimes you hear. The number of chimes tells you which mode the vehicle is set for. If you do not wish to change the current mode, you can either exit the programming mode by following the instructions earlier in this section or program the next feature available on your vehicle.
4. Turn the parking lamps on, then off again to change the current mode.
5. Repeat Step 4 until you hear the number of chimes that matches the number of the mode you want.

The mode you selected is now set. You can either exit the programming mode by following the instructions earlier in this section or program the next feature available on your vehicle.

Arming and Disarming the Content Theft-Deterrent System (If Equipped)

To arm and disarm the content theft-deterrent system, the system must be turned on by using Mode 2 listed previously in this section under “Content Theft-Deterrent System.”

With the arming and disarming feature, you can do the following:

- Arm the system when you lock the doors using either power door lock switch while any door is open and the key is removed from the ignition.
- Arm the system when you lock the doors with your remote keyless entry transmitter and the key is removed from the ignition.
- Disarm the system when you unlock the doors with your key or remote keyless entry transmitter.

Programmable Modes

Mode 1: Power Door Lock Switch Arming Off

- The content theft-deterrent system will arm when you lock the doors with the remote keyless entry transmitter. The key must be removed from the ignition when you lock the doors or the content theft-deterrent system will not arm.
- The content theft-deterrent system will disarm when you unlock the doors with the keys or the remote keyless entry transmitter.

Mode 2: Remote Keyless Entry Transmitter Arm/Disarm Only

- The content theft-deterrent system will arm when you lock the doors with the remote keyless entry transmitter. The key must be removed from the ignition when you lock the doors or the content theft-deterrent system will not arm.
- The content theft-deterrent system will disarm when you unlock the doors with the remote keyless entry transmitter.

While this mode provides increased security, it can be a problem if the remote keyless entry transmitter is damaged, lost or if it fails to operate for any reason while the content theft-deterrent system is armed. The content theft-deterrent system must be disarmed for the engine to run and while in Mode 2, the key can no longer disarm the system.

If your vehicle is equipped with the OnStar[®] system, OnStar will not be able to remotely unlock your vehicle if it has been programmed to Mode 2.

Mode 3: Standard Arming and Disarming

- The content theft-deterrent system will arm when you lock the doors using either power door lock switch while any door is open and the key is removed from the ignition.
- The content theft-deterrent system will arm when you lock the doors with your remote keyless entry transmitter. The key must be removed from the ignition when you lock the doors or the content theft-deterrent system will not arm.
- The content theft-deterrent system will disarm when you unlock the doors with the key or the remote keyless entry transmitter.

Before your vehicle was shipped from the factory, it was programmed to Mode 1. The mode to which your vehicle was programmed may have been changed since it left the factory. To determine the mode to which your vehicle is programmed or to program your vehicle to a different mode, do the following:

1. Follow the instructions for “Entering Programming Mode” listed previously.
2. Insert a second ignition key fully into any door key cylinder and turn it to the unlock position.

This step is necessary to prevent accidental programming of this feature to Mode 2. Do not program this feature to Mode 2 without first reading the note contained in the description for that mode. The door key lock cylinder must remain in the unlock position during Steps 2 through 4.

3. Press the horn symbol on the remote keyless entry transmitter.

4. Count the number of chimes you hear. The number of chimes tells you which mode the vehicle is set for. If you do not wish to change the current mode, you can either exit the programming mode by following the instructions earlier in this section or program the next feature available on your vehicle.
5. Press the horn symbol on the remote keyless entry transmitter again to change the current mode.
6. Repeat Step 5 until you hear the number of chimes that matches the mode you want.
7. Remove the key from the door key cylinder.

The mode you selected is now set. You can either exit the programming mode by following the instructions earlier in this section or program the next feature available on your vehicle.

Trunk

CAUTION:

It can be dangerous to drive with the trunk lid open because carbon monoxide (CO) gas can come into your vehicle. You can't see or smell CO. It can cause unconsciousness and even death.

If you must drive with the trunk open or if electrical wiring or other cable connections must pass through the seal between the body and the trunk:

- **Make sure all other windows are shut.**
- **Turn the fan on your heating or cooling system to its highest speed with the setting on VENT. That will force outside air into your vehicle. See “Comfort Controls” in the Index.**
- **If you have air outlets on or under the instrument panel, open them all the way. See “Engine Exhaust” in the Index.**

Trunk Lock

To unlock the trunk from the outside, insert the key and turn it clockwise. You can also press the trunk symbol on the remote keyless entry transmitter (if equipped).

Remote Trunk Release

This feature is used to unlock the trunk from inside the vehicle.



Press the TRUNK button located behind the glove box door.

The shift lever must be in PARK (P) for the remote trunk release button to work.

Trunk Release Handle

NOTICE:

The trunk release handle was not designed to be used to tie down the trunk lid or as an anchor point when securing items in the trunk. Improper use of the trunk release handle could damage it.

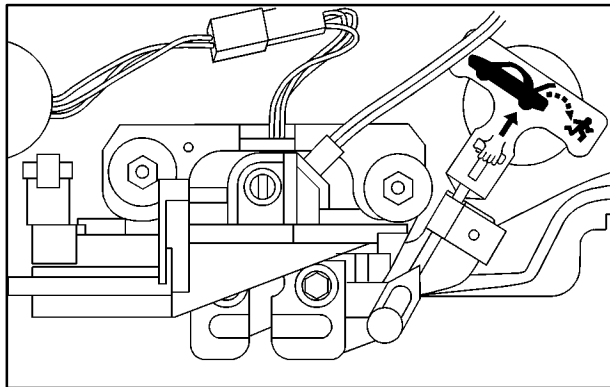

There is a glow-in-the-dark trunk release handle located inside the trunk on the latch. This handle will glow following exposure to light. Pull the release handle to open the trunk from the inside.

Trap-Resistant Trunk Kit

To help prevent a child from becoming trapped in your trunk, you can order a trap-resistant trunk kit from your dealer. This kit includes:

- a modified trunk latch,
- a lighted release handle, and
- seatback tethers (for vehicles with folding rear seatbacks).

See your dealer for additional information.

Theft

Vehicle theft is big business, especially in some cities. Although your vehicle has a number of theft-deterrent features, we know that nothing we put on it can make it impossible to steal. However, there are ways you can help.

Key in the Ignition

If you leave your vehicle with the keys inside, it's an easy target for joy riders or professional thieves -- so don't do it.

When you park your vehicle and open the driver's door, you'll hear a chime reminding you to remove your key from the ignition and take it with you. Always do this. Your steering wheel will be locked, and so will your ignition and transaxle. And remember to lock the doors.

Parking at Night

Park in a lighted spot, close all windows and lock your vehicle. Remember to keep your valuables out of sight. Put them in a storage area, or take them with you.

Parking Lots

Even if you park in a lot where someone will be watching your vehicle, it's still best to lock it up and take your keys. But what if you have to leave your key?

- If possible, park in a busy, well-lit area.
- Put your valuables in a storage area, like your trunk or glove box.
- Be sure to close and lock the storage area.
- Close all windows.
- Lock the glove box.
- Lock all the doors except the driver's.
- If your vehicle has a remote keyless entry system, take the transmitter with you.

Content Theft-Deterrent (If Equipped)

The vehicle may have a theft-deterrent alarm system.



A red light located on top of the instrument panel (toward the center of the vehicle, near the windshield) will flash slowly when the system is armed.

While armed, the doors will not unlock with the power door lock switch. The alarm will sound if someone tampers with the trunk lock, enters the vehicle (without using the remote keyless entry transmitter or key to unlock the doors), or turns the ignition on. The horn will sound and the headlamps will flash for up to two minutes. The system will also cut off the fuel supply, preventing the vehicle from being driven.

Arming with the Power Lock Switch

Your alarm system can be programmed to arm when you use either power lock switch to lock the doors while any door is open and the key is removed from the ignition. If you would like to arm the system with the power lock switch see “Multifunction Alarm Locks and Lighting Choices” in the Index. When programmed, the red light will flash quickly to let you know that the system is ready to arm with the power lock switches. When you press the rear of a power door lock switch, the red light will stop flashing and stay on to let you know that the system is arming. After all the doors are closed and locked, the red light will begin flashing at a very slow rate to let you know the system is armed.

Arming with the Remote Keyless Entry Transmitter

The alarm system will arm when you use the remote keyless entry transmitter to lock the doors after the key is removed from the ignition. The red light will turn on to let you know the system is arming. After all doors are closed and locked, the red light will begin flashing at a very slow rate to let you know the system is armed.

Arming Confirmation

If the remote unlock confirmation is on, (see “Locks and Lighting Choices” in the Index), the headlamps will flash briefly to let you know when the alarm system has armed.

Disarming with the Remote Keyless Entry Transmitter

The alarm system will disarm when you use your remote keyless entry transmitter to unlock the doors. The red light will go off to let you know the system is disarmed.

Disarming with the Key

The alarm system will disarm when you use the key to unlock the doors. The red light will stop flashing when the system is disarmed. If you would like the key to disarm the alarm system, see “Locks and Lighting Choices” in the Index.

PASS-Key® III



Your vehicle is equipped with the PASS-Key III (Personalized Automotive Security System) theft-deterrent system. PASS-Key III is a passive theft-deterrent system. This means you don't have to do anything different to arm or disarm the system. It works when you insert or remove the key from the ignition.

Your PASS-Key III system operates on a radio frequency subject to Federal Communications Commission (FCC) Rules and with Industry Canada.

This device complies with Part 15 of the FCC Rules. Operation is subject to the following two conditions: (1) this device may not cause harmful interference, and (2) this device must accept any interference received, including interference that may cause undesired operation.

This device complies with RSS-210 of Industry Canada. Operation is subject to the following two conditions: (1) this device may not cause interference, and (2) this device must accept any interference received, including interference that may cause undesired operation of the device.

Changes or modifications to this system by other than an authorized service facility could void authorization to use this equipment.

PASS-Key III uses a radio frequency transponder in the key that matches a decoder in your vehicle.

When the PASS-Key III system senses that someone is using the wrong key, it shuts down the vehicle's starter and fuel systems. The starter will not work and fuel will stop being delivered to the engine. Anyone using a trial-and-error method to start the vehicle will be discouraged because of the high number of electrical key codes.

When trying to start the vehicle if the engine does not start and the SECURITY light comes on, the key may have a damaged transponder. Turn the ignition off and try again.

If the engine still does not start, and the key appears to be undamaged, try another ignition key. At this time, you may also want to check the fuse (see “Fuses and Circuit Breakers” in the Index). If the engine still does not start with the other key, your vehicle needs service. If your vehicle does start, the first key may be faulty. See your dealer who can service the PASS-Key III to have a new key made. In an emergency, contact Pontiac Roadside Assistance. See “Roadside Assistance” in the Index for more information.

It is possible for the PASS-Key III decoder to learn the transponder value of a new or replacement key. Up to 10 additional keys may be programmed for the vehicle. This procedure is for learning additional keys only. If all the currently programmed keys are lost or do not operate, you must see your dealer or a locksmith who can service PASS-Key III to have keys made and programmed to the system.

See your dealer or a locksmith who can service PASS-Key III to get a new key blank that is cut exactly as the ignition key that operates the system.

Canadian Owners: If you lose or damage your keys, only a GM dealer can service PASS-KEY III to have new keys made. To program additional keys, you will need two current driver’s keys, (black in color). You must add a step to the procedure, “To program the new key.” After Step 2, repeat Steps 1 and 2 with the second current driver’s key, (black in color). Then continue with Step 3.

To program the new key do the following:

1. Verify that the new key has “PK3” stamped on it.
2. Insert the master key in the ignition and start the engine. If the engine will not start, see your dealer for service.
3. After the engine has started, turn the key to OFF, and remove the key.
4. Insert the key to be programmed and turn it to RUN within five seconds of removing the original key.
5. The SECURITY light will turn off once the key has been programmed. It may not be apparent that the SECURITY light went on due to how quickly the key is programmed.
6. Repeat Steps 1 through 5 if additional keys are to be programmed.

If you are ever driving and the SECURITY light comes on and stays on, you will be able to restart your engine if you turn it off. Your PASS-Key III system, however, is not working properly and must be serviced by your dealer. Your vehicle is not protected by the PASS-Key III system at this time.

If you lose or damage your PASS-Key III key, see your dealer or a locksmith who can service PASS-Key III to have a new key made.

New Vehicle “Break-In”

NOTICE:

Your vehicle doesn’t need an elaborate “break-in.” But it will perform better in the long run if you follow these guidelines:

- **Don’t drive at any one speed -- fast or slow -- for the first 500 miles (805 km). Don’t make full-throttle starts.**
- **Avoid making hard stops for the first 200 miles (322 km) or so. During this time your new brake linings aren’t yet broken in. Hard stops with new linings can mean premature wear and earlier replacement. Follow this breaking-in guideline every time you get new brake linings.**
- **Don’t tow a trailer during break-in. See “Towing a Trailer” in the Index for more information.**

NOTICE:

If your key seems stuck in **LOCK** and you can't turn it, be sure you are using the correct key; if so, is it all the way in? If it is, then turn the steering wheel left and right while you turn the key hard. Turn the key only with your hand. Using a tool to force it could break the key or the ignition switch. If none of this works, then your vehicle needs service.

Ignition Positions

With the key in the ignition switch, you can turn it to five different positions. The ignition switch is located on the right side of the steering column.

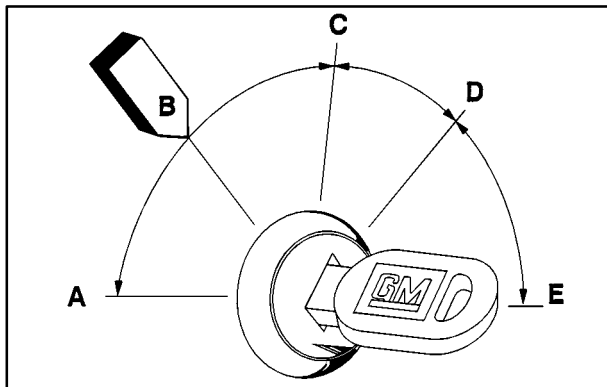

A (ACCESSORY): This position lets you use things like the radio and windshield wipers when the engine is off. To use accessory, push in the key and turn it toward you. The steering wheel will stay locked.

B (LOCK): This position locks the ignition, steering wheel and transaxle. It's a theft-deterrent feature. It's also the only position from which you can remove the key.

C (OFF): This position lets you turn off the engine but still turn the steering wheel. It doesn't lock the steering wheel like **LOCK**. Use off if you must have the vehicle pushed or towed.

D (RUN): This position is where the key returns to after you start the vehicle. With the engine off, you can use run to display some of the warning and indicator lights.

E (START): This position starts the engine.

A warning chime will sound if you open the driver's door when the ignition is in OFF, LOCK or ACCESSORY and the key is in the ignition.

Retained Accessory Power (RAP)

With Retained Accessory Power, (RAP), the power windows, audio system and sunroof will continue to work up to 10 minutes after the ignition key is turned to off and none of the doors are opened.

Starting Your Engine

Move your shift lever to PARK (P) or NEUTRAL (N). Your engine won't start in any other position -- that's a safety feature. To restart when you're already moving, use NEUTRAL (N) only.

NOTICE:

Don't try to shift to PARK (P) if your vehicle is moving. If you do, you could damage the transaxle. Shift to PARK (P) only when your vehicle is stopped.

Shift Lock Release

This vehicle is equipped with an electric shift lock release system. The shift lock release is designed to do the following:

- Prevent ignition key removal unless the shift lever is in PARK (P) (with the shift lever button fully released).
- Prevent movement of the shift lever out of PARK (P) unless the ignition is in a position other than OFF or LOCK. The shift lock release is always functional except in the case of a dead or low voltage (less than 9 V) battery.

If your vehicle has a dead battery or a battery with low voltage, there is an override access slot that will allow you to override the shift lock release.

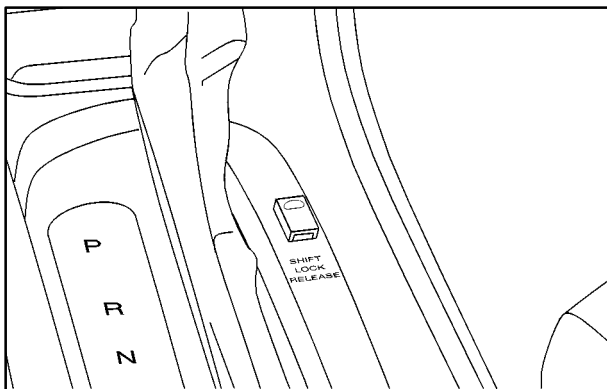

The override access slot is located on the upper right side of the console shift panel.

To use the slot, do the following:

1. Verify that the shift lever is in PARK (P) and that the shift lever button is fully released.
2. Locate the override access slot on the upper right side of the shift panel.
3. Remove the override access slot cap.
4. Insert a key into the access slot, press in and hold.
5. Press the shift lever button in and hold.
6. Remove the key from the slot.
7. Pull the shift lever into the desired gear position.
8. Reinstall the override access slot cap.

You will not be able to remove the key from the ignition unless the shift lever is in the PARK (P) position (with the shift lever button fully released).

Starting Your 3100 V6 Engine

1. With your foot off the accelerator pedal, turn your ignition key to **START**. When the engine starts, let go of the key. The idle speed will go down as your engine gets warm.

NOTICE:

Holding your key in START for longer than 15 seconds at a time will cause your battery to be drained much sooner. And the excessive heat can damage your starter motor. Wait about 15 seconds between each try to help avoid draining your battery or damaging your starter.

2. If your engine won't start (or starts but then stops), it could be flooded with too much gasoline. Try pushing your accelerator pedal all the way to the floor and holding it there as you hold the key in **START** for not more than 15 seconds at a time. This clears the extra gasoline from the engine.

NOTICE:

Your engine is designed to work with the electronics in your vehicle. If you add electrical parts or accessories, you could change the way the engine operates. Before adding electrical equipment, check with your dealer. If you don't, your engine might not perform properly.

Starting Your 3800 Series II Engine

1. With your foot off the accelerator pedal, turn your ignition key to START. When the engine starts, let go of the key. The idle speed will go down as your engine gets warm.

NOTICE:

Holding your key in START for longer than 15 seconds at a time will cause your battery to be drained much sooner. And the excessive heat can damage your starter motor. Wait about 15 seconds between each try to help avoid draining your battery or damaging your starter.

2. If it doesn't start within 10 seconds, hold your key in START for about 10 seconds at a time until your engine starts. Wait about 15 seconds between each try.

3. If your engine still won't start (or starts but then stops), it could be flooded with too much gasoline. Try pushing your accelerator pedal all the way to the floor and holding it there as you hold the key in START for about three seconds. If the vehicle starts briefly but then stops again, do the same thing. This time keep the pedal down for five or six seconds to clear the extra gasoline from the engine. After waiting about 15 seconds, repeat the normal starting procedure.

NOTICE:

Your engine is designed to work with the electronics in your vehicle. If you add electrical parts or accessories, you could change the way the engine operates. Before adding electrical equipment, check with your dealer. If you don't, your engine might not perform properly.

Engine Coolant Heater (Option)

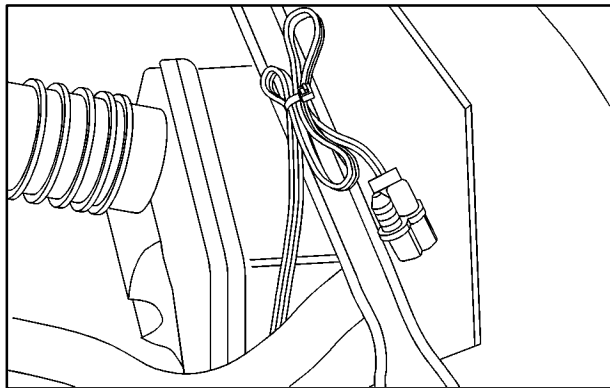

In very cold weather, 0°F (-18°C) or colder, the engine coolant heater can help. You'll get easier starting and better fuel economy during engine warm-up. Usually, the coolant heater should be plugged in a minimum of four hours prior to starting your vehicle. At temperatures above 32°F (0°C), use of the coolant heater is not required.

To Use the Engine Coolant Heater

1. Turn off the engine.
2. Open the hood and unwrap the electrical cord. The cord is located below the engine air cleaner/filter near the coolant reservoir bottle. See "Engine Compartment Overview" in the Index for more information on location.
3. Plug it into a normal, grounded 110-volt AC outlet.

CAUTION:

Plugging the cord into an ungrounded outlet could cause an electrical shock. Also, the wrong kind of extension cord could overheat and cause a fire. You could be seriously injured. Plug the cord into a properly grounded three-prong 110-volt AC outlet. If the cord won't reach, use a heavy-duty three-prong extension cord rated for at least 15 amps.

4. Before starting the engine, be sure to unplug and store the cord as it was before to keep it away from moving engine parts. If you don't, it could be damaged.

How long should you keep the coolant heater plugged in? The answer depends on the outside temperature, the kind of oil you have, and some other things. Instead of trying to list everything here, we ask that you contact your dealer in the area where you'll be parking your vehicle. The dealer can give you the best advice for that particular area.

Automatic Transaxle Operation



The automatic transaxle has a shift lever on the console between the seats. There is also a display of the gear positions on the instrument panel cluster near the speedometer and tachometer.

Maximum engine speed is limited when your vehicle is in PARK (P) or NEUTRAL (N) to protect driveline components from improper operation.

There are several different positions for the shift lever.

PARK (P): This position locks the front wheels. It's the best position to use when you start the engine because the vehicle can't move easily.

 **CAUTION:**

It is dangerous to get out of your vehicle if the shift lever is not fully in PARK (P) with the parking brake firmly set. Your vehicle can roll.

Don't leave your vehicle when the engine is running unless you have to. If you have left the engine running, the vehicle can move suddenly. You or others could be injured. To be sure your vehicle won't move, even when you're on fairly level ground, always set your parking brake and move the shift lever to PARK (P).

See "Shifting Into PARK (P)" in the Index.

If you're pulling a trailer, see "Towing a Trailer" in the Index.

Make sure the shift lever is fully in PARK (P) before starting the engine. The vehicle has an automatic transaxle shift lock control system. You must fully apply the regular brakes and press the shift control button located on the front of the shift lever, before you can shift from PARK (P) when the ignition is in RUN. If you cannot shift out of PARK (P), ease pressure on the shift lever by pushing it all the way into PARK (P) while keeping the brake pedal pushed down. Release the shift lever button. Then move the shift lever out of PARK (P), being sure to press the shift lever button. See "Shifting Out of PARK (P)" in the Index.

REVERSE (R): Use this gear to back up.

NOTICE:

Shifting to REVERSE (R) while the vehicle is moving forward could damage the transaxle. Shift to REVERSE (R) only after the vehicle is stopped.

To rock the vehicle back and forth to get out of snow, ice or sand without damaging the transaxle, see "Stuck: In Sand, Mud, Ice or Snow" in the Index.

NEUTRAL (N): In this position, the engine doesn't connect with the wheels. To restart when you're already moving, use NEUTRAL (N) only. Also, use NEUTRAL (N) when the vehicle is being towed.

 **CAUTION:**

Shifting out of PARK (P) or NEUTRAL (N) while your engine is “racing” (running at high speed) is dangerous. Unless your foot is firmly on the brake pedal, your vehicle could move very rapidly. You could lose control and hit people or objects. Don't shift out of PARK (P) or NEUTRAL (N) while your engine is racing.

NOTICE:

Damage to your transaxle caused by shifting out of PARK (P) or NEUTRAL (N) with the engine racing isn't covered by your warranty.

AUTOMATIC OVERDRIVE (D): This position is for normal driving. If you need more power for passing, and you're:

- Going less than 35 mph (55 km/h), push your accelerator pedal about halfway down.
- Going about 35 mph (55 km/h) or more, push the accelerator pedal all the way down.

You'll shift down to the next gear and have more power.

NOTICE:

If the vehicle seems to start up rather slowly, or if it seems not to shift gears as you go faster, something may be wrong with a transaxle system sensor. If you drive very far that way, your vehicle can be damaged. So, if this happens, have your vehicle serviced right away. Until then, you can use SECOND (2) when you are driving less than 35 mph (55 km/h) and AUTOMATIC OVERDRIVE (D) for higher speeds.

THIRD (3): This position is also used for normal driving, but it offers more power and lower fuel economy than AUTOMATIC OVERDRIVE (D).

Here are some times you might choose THIRD (3) instead of AUTOMATIC OVERDRIVE (D):

- When driving on hilly, winding roads.
- When towing a trailer, so there is less shifting between gears.
- When going down a steep hill.
- When driving in non-highway scenarios (i.e. city streets, etc.).

SECOND (2): This position gives you more power but lower fuel economy. You can use SECOND (2) on hills. It can help control your speed as you go down steep mountain roads, but then you would also want to use your brakes off and on.

NOTICE:

Don't drive in SECOND (2) for more than 25 miles (40 km), or at speeds over 55 mph (90 km/h), or you can damage your transaxle. Use AUTOMATIC OVERDRIVE (D) or THIRD (3) as much as possible.

Don't shift into SECOND (2) unless you are going slower than 65 mph (105 km/h), or you can damage your engine.

FIRST (1): This position gives you even more power (but lower fuel economy) than SECOND (2). You can use it on very steep hills, or in deep snow or mud. If the shift lever is in FIRST (1), the transaxle won't shift into first gear until the vehicle is going slowly enough.

NOTICE:

If your front wheels can't turn, don't try to drive. This might happen if you were stuck in very deep sand or mud or were up against a solid object. You could damage your transaxle.

Also, if you stop when going uphill, don't hold your vehicle there with only the accelerator pedal. This could overheat and damage the transaxle. Use your brakes or shift into PARK (P) to hold your vehicle in position on a hill.

Parking Brake



The parking brake is located to the left of the brake pedal near the driver's door. To set the parking brake, hold the regular brake pedal down with the right foot. Push down on the parking brake pedal, with the left foot.

To release the parking brake, hold the regular brake pedal down with the right foot and push the parking brake pedal with the left foot. When you lift the left foot, the parking brake pedal will follow it to the released position.

A warning chime will sound if the parking brake is set, the ignition is on and the shift lever is not in PARK (P) or NEUTRAL (N).

NOTICE:

Driving with the parking brake on can cause the rear brakes to overheat. You may have to replace them, and you could also damage other parts of the vehicle.

If you are towing a trailer and parking on a hill, see “Towing a Trailer” in the Index. That section shows what to do first to keep the trailer from moving.

Shifting Into PARK (P)

CAUTION:

It can be dangerous to get out of your vehicle if the shift lever is not fully in PARK (P) with the parking brake firmly set. Your vehicle can roll. If you have left the engine running, the vehicle can move suddenly. You or others could be injured. To be sure your vehicle won't move, even when you're on fairly level ground, use the steps that follow. If you're pulling a trailer, see “Towing a Trailer” in the Index.

1. Hold the brake pedal down with your right foot and set the parking brake.

2. Move the shift lever into PARK (P) like this:

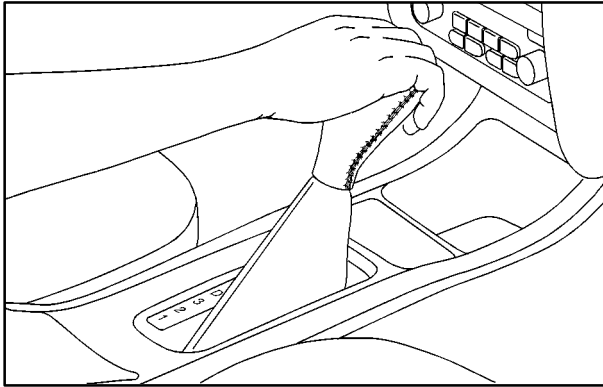

- Press in and hold the shift lever button, located on the front of the shift lever.
 - Push the lever all the way toward the front of the vehicle.
3. Turn the ignition key to LOCK.
 4. Remove the key and take it with you. If you can leave your vehicle with the ignition key in your hand, your vehicle is in PARK (P).

Leaving Your Vehicle With the Engine Running

CAUTION:

It can be dangerous to leave your vehicle with the engine running. Your vehicle could move suddenly if the shift lever is not fully in PARK (P) with the parking brake firmly set. And, if you leave the vehicle with the engine running, it could overheat and even catch fire. You or others could be injured. Don't leave your vehicle with the engine running unless you have to.

If you have to leave your vehicle with the engine running, be sure the vehicle is in PARK (P) and the parking brake is firmly set before you leave it. After you've moved the shift lever into PARK (P), hold the regular brake pedal down. Then, see if you can move the shift lever away from PARK (P) (without first pushing the shift lever button). If you can, it means that the shift lever wasn't fully locked into PARK (P).

Torque Lock

If you are parking on a hill and you don't shift your transaxle into PARK (P) properly, the weight of the vehicle may put too much force on the parking pawl in the transaxle. You may find it difficult to pull the shift lever out of PARK (P). This is called "torque lock." To prevent torque lock, set the parking brake and then shift into PARK (P) properly before you leave the driver's seat. To find out how, see "Shifting Into PARK (P)" in the Index.

When you are ready to drive, move the shift lever out of PARK (P) *before* you release the parking brake.

If torque lock does occur, you may need to have another vehicle push yours a little uphill to take some of the pressure from the parking pawl in the transaxle, so you can pull the shift lever out of PARK (P).

Shifting Out of PARK (P)

Your vehicle has an automatic transaxle shift lock control system. You must fully apply your regular brakes before you can shift from PARK (P) when the ignition is in RUN. See "Automatic Transaxle Operation" in the Index.

If you cannot shift out of PARK (P), ease pressure on the shift lever by pushing it all the way into PARK (P) while keeping the brake pedal down. Release the shift lever button. Then move the shift lever out of PARK (P), being sure to press the shift lever button.

Parking Over Things That Burn

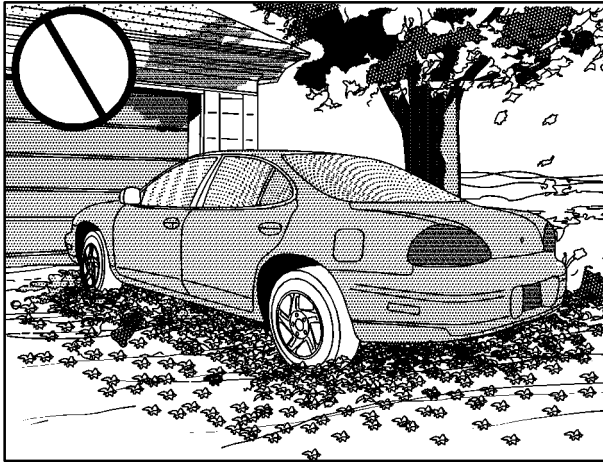

CAUTION:

Things that can burn could touch hot exhaust parts under your vehicle and ignite. Don't park over papers, leaves, dry grass or other things that can burn.

Engine Exhaust

CAUTION:

Engine exhaust can kill. It contains the gas carbon monoxide (CO), which you can't see or smell. It can cause unconsciousness and death.

You might have exhaust coming in if:

- Your exhaust system sounds strange or different.
- Your vehicle gets rusty underneath.
- Your vehicle was damaged in a collision.
- Your vehicle was damaged when driving over high points on the road or over road debris.
- Repairs weren't done correctly.
- Your vehicle or exhaust system had been modified improperly.

If you ever suspect exhaust is coming into your vehicle:

- Drive it only with all the windows down to blow out any CO; and
- Have your vehicle fixed immediately.

Running Your Engine While You're Parked

It's better not to park with the engine running. But if you ever have to, here are some things to know.

CAUTION:

Idling the engine with the climate control system off could allow dangerous exhaust into your vehicle. See the earlier Caution under "Engine Exhaust."

Also, idling in a closed-in place can let deadly carbon monoxide (CO) into your vehicle even if the fan is at the highest setting. One place this can happen is a garage. Exhaust -- with CO -- can come in easily. **NEVER** park in a garage with the engine running.

Another closed-in place can be a blizzard. See "Blizzard" in the Index.

CAUTION:

It can be dangerous to get out of your vehicle if the shift lever is not fully in PARK (P) with the parking brake firmly set. Your vehicle can roll. Don't leave your vehicle when the engine is running unless you have to. If you've left the engine running, the vehicle can move suddenly. You or others could be injured. To be sure your vehicle won't move, even when you're on fairly level ground, always set your parking brake and move the shift lever to PARK (P).

Follow the proper steps to be sure your vehicle won't move. See "Shifting Into PARK (P)" in the Index.

If you are parking on a hill and if you're pulling a trailer, also see "Towing a Trailer" in the Index.

Horn

Press at or near the horn symbols located on the steering wheel pad to sound the horn.

Tilt Wheel

A tilt steering wheel allows you to adjust the steering wheel before you drive. You can raise it to the highest level to give your legs more room when you exit and enter the vehicle, or you can lower it so that you're more comfortable while driving.

The lever to adjust it is located on the left side of the steering column, below the turn signal/multifunction lever.



To tilt the wheel, hold the steering wheel and pull the lever. Move the steering wheel to a comfortable level, then release the lever to lock the wheel in place.

Turn Signal/Multifunction Lever

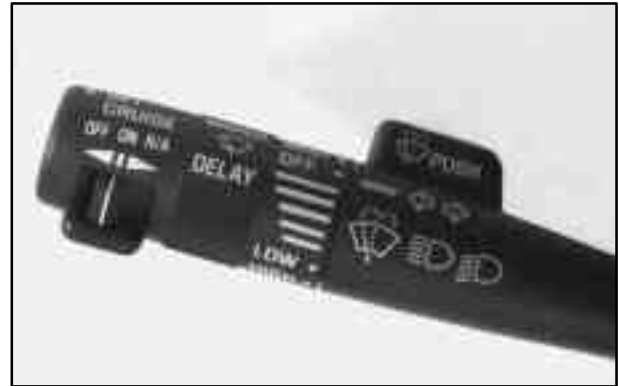

The lever on the left side of the steering column includes the following:

- Turn and Lane Change Signals
- Headlamp High/Low-Beam Changer
- Flash-to-Pass Feature
- Windshield Wipers
- Windshield Washer
- Cruise Control

For information on the exterior lamps, see “Exterior Lamps” later in this section.

Turn and Lane Change Signals

The turn signal has two upward (for right) and two downward (for left) positions. These positions allow you to signal a turn or a lane change.

To signal a turn, move the lever all the way up or down. When the turn is finished, the lever will return to its original position automatically.

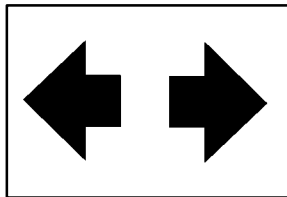

An arrow on the instrument panel cluster will flash in the direction of the turn or lane change.

To signal a lane change, just raise or lower the lever until the arrow starts to flash. Hold it there until you complete your lane change. The lever will return to its original position when you release it.

As you signal a turn or a lane change, if the arrow flashes faster than normal, a signal bulb may be burned out and other drivers won't see your turn signal.

If a bulb is burned out, replace it to help avoid an accident. If the arrows don't go on at all when you signal a turn, check for burned-out bulbs and then check the fuse. See "Fuses and Circuit Breakers" in the Index.

A chime will sound if you leave the turn signal on for more than 3/4 mile (1.2 km).

Headlamp High/Low-Beam Changer

To change the headlamps from low beam to high beam, or high to low, pull the multifunction lever all the way toward you. Then release it.

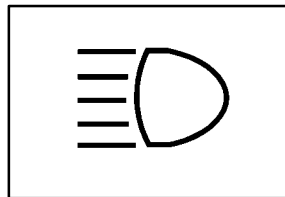

When the high beams are on, this light on the instrument panel cluster will appear. While the high-beam headlamps are on, the fog lamps will not illuminate.

If your vehicle is equipped with the Head-Up-Display (HUD), an arrow will appear in the display area to indicate that the high beams are on. See "Head-Up-Display (HUD)" in the Index for more information.

Flash-to-Pass Feature

This feature lets you use the high-beam headlamps to signal a driver in front of you that you want to pass. It works even if your headlamps are in the automatic or off position.

To use it, pull the turn signal lever toward you, then release it.

If the headlamps are in the automatic position or on low beam, the high-beam headlamps will turn on and the high-beam indicator on the instrument panel cluster will come on. They will stay on as long as you hold the lever toward you. Release the lever to return to the initial position.

If your vehicle is equipped with the Head-Up-Display (HUD), an arrow will appear in the display area to indicate that the high beams are on.

Windshield Wipers

To operate the windshield wipers, turn the band marked WIPER located on the multifunction lever, upward or downward.

MIST: Turn the band to MIST for a single wiping cycle. Hold it there until the windshield wipers start, then let it go. The windshield wipers will stop after one cycle. For more cycles, hold the band on MIST longer.

OFF: Turn the band to OFF to turn to windshield wipers off.

DELAY (Delayed Wiping): Turn the band upward to choose one of the five delay settings. For longer periods of time between wiper blade cycles, select a low setting. For shorter periods of time between wiper blade cycles, select a higher setting. The further the band is turned upward, the longer the delay between wiper cycles.

LOW: Turn the band to LOW for steady wiping at a low speed.

HIGH: Turn the band to HIGH for steady wiping at a high speed.

Be sure to clear ice and snow from the wiper blades before using them. If they're frozen to the windshield, carefully loosen or thaw them. If the blades do become damaged, get new blades or blade inserts.

Heavy snow or ice can overload the wipers. A circuit breaker will stop them until the motor cools. Clear away snow or ice to prevent an overload.

Windshield Washer



PUSH: Press the paddle with the the word PUSH and the washer symbol on it, located on top of the multifunction lever, to spray washer fluid on the windshield. The wipers will clear the windshield and then either stop or return to the set speed.

CAUTION:

In freezing weather, don't use your washer until the windshield is warmed. Otherwise the washer fluid can form ice on the windshield, blocking your vision.

Cruise Control

With cruise control, you can maintain a speed of about 25 mph (40 km/h) or more without keeping your foot on the accelerator. This can really help on long trips. Cruise control does not work at speeds below approximately 25 mph (40 km/h).

When you apply the brakes, the cruise control shuts off.

CAUTION:

- **Cruise control can be dangerous where you can't drive safely at a steady speed. So, don't use your cruise control on winding roads or in heavy traffic.**
- **Cruise control can be dangerous on slippery roads. On such roads, fast changes in tire traction can cause needless wheel spinning, and you could lose control. Don't use cruise control on slippery roads.**

If your vehicle is in cruise control when the traction control system on the 3800 Supercharged V6 engine or the enhanced traction system on the 3100 V6 and 3800 V6 engine begins to limit wheel spin, the cruise control will automatically disengage. See "Traction Control System" or "Enhanced Traction System" in the Index. When road conditions allow you to safely use it again, you may turn the cruise control back on.

Setting Cruise Control

CAUTION:

If you leave your cruise control switch on when you're not using cruise, you might hit a button and go into cruise when you don't want to. You could be startled and even lose control. Keep the cruise control switch off until you want to use cruise control.

1. Move the cruise control switch to ON.
2. Get up to the speed you want.
3. Push in the SET button at the end of the multifunction lever and release it.
4. Take your foot off the accelerator pedal.

Resuming a Set Speed

Suppose you set the cruise control at a desired speed and then you apply the brake. This, of course, shuts off the cruise control. But you don't need to reset it.

Once you're going about 25 mph (40 km/h) or more again, you can move the cruise control switch from ON to R/A (Resume/Accelerate) briefly. You'll go right back up to your chosen speed and stay there.

Increasing Speed While Using Cruise Control

There are two ways to go to a higher speed:

- Use the accelerator pedal to get to the higher speed. Push in the SET button, then release the button and the accelerator pedal. You'll now cruise at the higher speed.
- Move the cruise switch from ON to R/A. Hold it there until you get up to the speed you want, and then release the switch. To increase your speed in very small amounts, move the switch to R/A briefly and then release it. Each time you do this, your vehicle will go about 1 mph (1.6 km/h) faster.

The accelerate feature will only work after you set the cruise control speed by pushing the SET button.

Reducing Speed While Using Cruise Control

There are two ways to reduce your speed while using cruise control:

- Push in the SET button until you reach the lower speed you want, then release it.
- To slow down in very small amounts, push the SET button briefly. Each time you do this, you'll go about 1 mph (1.6 km/h) slower.

Passing Another Vehicle While Using Cruise Control

Use the accelerator pedal to increase your speed. When you take your foot off the pedal, the vehicle will slow down to the cruise control speed you set earlier.

Using Cruise Control on Hills

How well the cruise control will work on hills depends upon your speed, load and the steepness of the hills. When going up steep hills, you may have to step on the accelerator pedal to maintain your speed. When going downhill, you may have to brake or shift to a lower gear to keep your speed down. Of course, applying the brake takes you out of cruise control. Many drivers find this to be too much trouble and don't use cruise control on steep hills.

Ending Cruise Control

There are two ways to turn off the cruise control:

- Step lightly on the brake pedal,
- or move the cruise switch to OFF.

Erasing Cruise Speed Memory

When you turn off the cruise control or the ignition, or shift into PARK (P) or NEUTRAL (N), the cruise control set speed memory is erased.

Exterior Lamps

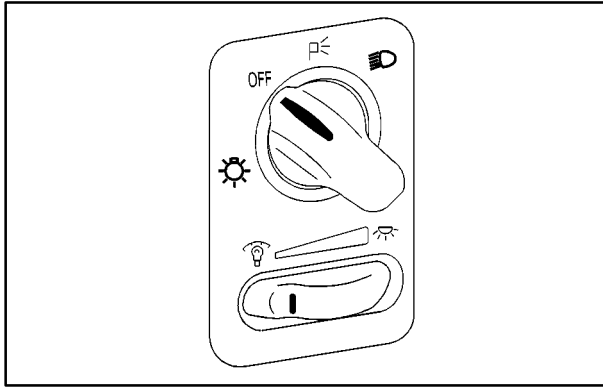

The exterior lamp control is located on the lower left side of the instrument panel, to the left of the steering wheel.

The exterior lamp has three positions.

OFF: Turning the control to this position, turns off all lamps, except the Daytime Running Lamps (DRL).

P (Parking Lamps): Turning the control to this position turns on the parking lamps, together with the following:

- Sidemarker Lamps
- Taillamps
- License Plate Lamp
- Instrument Panel Lights

H (Headlamps): Turning the control to this position turns on the headlamps, together with the previously listed lamps and lights.

A warning chime will sound if you open the driver's door when you turn the ignition switch to LOCK or ACCESSORY with the lamps on.

Daytime Running Lamps (DRL) / Automatic Headlamp Control

Daytime Running Lamps (DRL) can make it easier for others to see the front of your vehicle during the day. DRL can be helpful in many different driving conditions, but they can be especially helpful in the short periods after dawn and before sunset. Fully functional daytime running lamps are required on all vehicles first sold in Canada.

A light sensor on top of the instrument panel makes the DRL work, so be sure it isn't covered.

The DRL system will make your low-beam headlamps come on at a reduced brightness when the following conditions are met:

- The ignition is on,
- the exterior lamps control is off,
- the transaxle is not in PARK (P) and
- the parking brake is released.

When the DRL are on, only your low-beam headlamps, at a reduced brightness, will be on. The taillamps, sidemarker and other lamps won't be on. Your instrument panel won't be lit up either.

When it's dark enough outside, your headlamps will change to full brightness. The other lamps that come on with your headlamps will also come on.

When it's bright enough outside, the headlamps will go out, and your low-beam headlamps will change to the reduced brightness of DRL.

To idle your vehicle with the DRL off, set the parking brake while the ignition is in OFF or LOCK. Then start your vehicle. The DRL will stay off until you shift out of PARK (P) and release the parking brake.

As with any vehicle, you should turn on the regular headlamp system when you need it.

Fog Lamps



The fog lamps switch is located on the upper corner of the instrument panel, to the left of the instrument panel cluster.

For this feature to work the exterior lamps control must be on. To turn the fog lamps on, press the right side of the fog lamp switch. A light will glow in the switch to let you know that they are on. Press the left side of the switch to turn the fog lamps off.

Interior Lamps

Instrument Panel Brightness Control

This feature controls the brightness of the instrument panel lights.



The thumbwheel for this feature is located on the instrument panel, to the left of the steering wheel.

Turn the thumbwheel to the right to increase the brightness of the instrument panel lights and to the left to decrease the brightness. Turn the thumbwheel completely to the left to turn them off.

Courtesy Lamps

When a door is open, the courtesy lamps will automatically come on. They make it easy for you to enter and leave the vehicle at night. You can also turn these lamps on by manually turning the interior lamps thumbwheel all the way to the right.

Illuminated Entry

The illuminated entry feature will light the interior of the vehicle so that you can see the inside of the vehicle before you enter at night. The interior lamps will come on for 40 seconds when you unlock the doors using the remote keyless entry transmitter (if equipped) and the ignition is in LOCK or OFF. After 40 seconds have elapsed, the interior lamps will slowly fade out. The lamps will fade out before 40 seconds have elapsed if you do the following:

- Lock all doors using the remote keyless entry transmitter (if equipped).
- Lock the doors using the power door lock switch.

When any door is opened, illuminated entry is canceled. The interior lamps will stay on while any door is opened and slowly fade out when all doors are closed. The interior lamps may stay on for up to 25 seconds after all doors have been closed if they have not been locked. See “Delayed Illumination” later in this section.

Delayed Illumination

The delayed illumination feature will continue to light the interior of the vehicle for 25 seconds after all the doors have been closed so that you can find the ignition and buckle the seat belt at night. Delayed illumination will not occur while the ignition is in RUN or ACCESSORY. After 25 seconds have elapsed, the interior lamps will slowly fade out. The lamps will fade out before the 25 seconds have elapsed if you do any of the following:

- Turn the ignition to RUN or ACCESSORY.
- Lock all doors using the remote keyless entry transmitter (if equipped).
- Lock the doors using the power door lock switch.

To turn delayed illumination feature off or on, see “Locks and Lighting Choices” in the Index.

Delayed Exit Lighting

For exiting the vehicle at night, the vehicle is equipped with the delayed exit lighting feature. The interior lamps will illuminate for up to 25 seconds when you remove the key from the ignition. After 25 seconds have elapsed, the interior lamps will slowly fade out. The lamps will fade out before the 25 seconds have elapsed if you do any of the following:

- Insert the key and turn the ignition to RUN or ACCESSORY.
- Lock all doors using the remote keyless entry transmitter (if equipped).
- Lock the doors using the power door lock switch.

When any door is opened, delayed exit lighting is canceled. The interior lamps will stay on while any door is opened and will slowly fade out when all the doors are closed. The interior lamps may stay on for up to 25 seconds after all the doors have been closed if they have not been locked. See “Delayed Illumination” earlier in this section.

To turn the delayed exit lighting feature off or on, see “Locks and Lighting Choices” in the Index.

Overhead Console Reading Lamps (Option)

These lamps are part of the overhead console. They will go on when you open the doors. When the doors are closed, push the button next to each lamp to turn them on and off. The console also contains an open storage bin.

Front Reading Lamps (Option)

If the vehicle has the optional sunroof, you will have reading lamps in front of the sunroof switch located on the headliner. These lamps will come on when you open the doors. The lamps can be turned on and off manually by pressing the button behind each reading lamp when the doors are closed.

Rear Assist Handle Reading Lamps (Option)

There is a reading lamp provided in each rear assist handle. Use the button next to each lamp to turn it on and off.

Battery Saver

Your vehicle has a feature to help prevent you from draining the battery in case you accidentally leave the interior, trunk or underhood lamps on. If you leave any of these lamps on while the ignition is in LOCK or OFF, they will automatically turn off after 10 minutes. The lamps won't come back on again until you do one of the following:

- Turn the ignition to RUN or ACCESSORY.
- Turn the interior lamp thumbwheel completely to the right, then back slightly to the left.
- Open (or close and reopen) a door that is closed.

If the vehicle has less than 15 miles (25 km) on the odometer, the battery saver will turn off the lamps after only three minutes.

Mirrors

Adjust all the mirrors so you can see clearly when you are sitting in a comfortable driving position.

Inside Day/Night Rearview Mirror

To reduce glare from lamps behind you, pull the lever located in the center of the bottom of the mirror toward you to the night position. To return the mirror back to the day position, push the lever away from you.

Electrochromic Day/Night Rearview Mirror with Compass and Temperature Display (Option)

Your vehicle may have an automatic-dimming rearview mirror with a compass and temperature display.

When turned on, an electrochromic mirror automatically dims to the proper level to minimize glare from headlamps behind your after dark.

The mirror has an eight-point compass and temperature display in the upper right corner of the mirror face. The display shows the current outside temperature and the vehicle's current direction.

Automatic Dimming Feature



The automatic dimming feature is turned on or off by briefly pressing the COMP button located on the bottom of the mirror face. A light on the mirror will be lit when the feature is turned on. It will go out when the feature is turned off.

Temperature Display

The TEMP button located on the bottom of the mirror face changes the temperature display. You can select °F, °C, or turn the display off.

Compass Operation

Press the COMP button once briefly to turn the compass on or off. When on, the display will show the compass direction, with a maximum of two characters. For example, NE is displayed for north-east.

Compass Calibration

Press and hold the COMP button down for six seconds to activate the compass calibration mode. If your vehicle has the optional mirror with the compass, temperature display and OnStar system, press the on/off button for nine seconds.

CAL will be displayed in the compass/temperature window on the mirror.

The mirror can be calibrated in one of two ways:

- Drive the vehicle in circles at 5 mph (8 km/h) or less until CAL is no longer displayed in the compass window.
- Drive the vehicle on your everyday routine. (This method may take longer to calibrate).

Compass Variance

Compass variance is the difference between earth's magnetic north and true geographic north. If not adjusted to account for compass variance, your compass could give false readings. The mirror is set to zone eight upon leaving the factory. It will be necessary to adjust the compass to compensate for compass variance if you live outside zone eight. Under certain circumstances, such as during a long distance cross-country trip, it will be necessary to adjust for compass variance.

To adjust for compass variance, do the following:

1. Find your current location and variance zone number on the map.

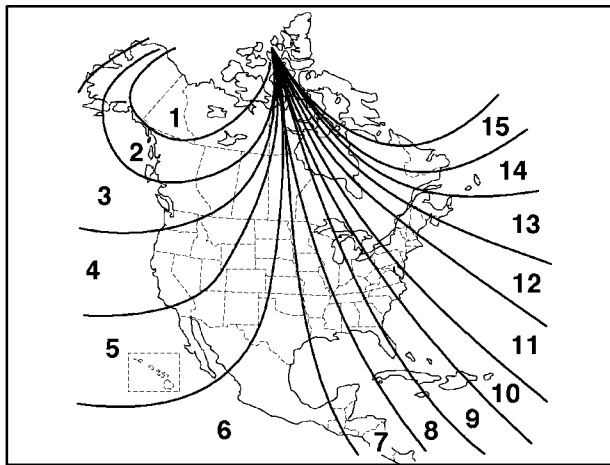

2. Press and hold the COMP button for three seconds. If your vehicle has the optional mirror with the compass, temperature display and OnStar system, press the on/off button for six seconds. Release the button when “ZONE” is displayed. The number shown is the current zone number.

3. Scroll through the zone numbers that appear in the compass/temperature window on the mirror by pressing the COMP button or the on/off button. Once you find your zone number, release the button. After about four seconds, the mirror will return to the compass and temperature display, and the new zone number will be set.

Electrochromic Day/Night Rearview Mirror with Compass, Temperature Display, and OnStar® (Option)

Your vehicle may have an automatic-dimming rearview mirror with a compass and temperature display and the OnStar system.

When turned on, this mirror functions exactly like the electrochromic mirror described previously. See “Mirrors, Electrochromic Rearview” in the Index for more information.

The mirror also has an eight-point compass and temperature display in the upper right corner on the mirror face and a three-button OnStar system.

 : The button with this symbol is the on/off button for the mirror functions such as automatic dimming and temperature display. It is the far left button located on the lower part of the mirror face.

Automatic Dimming Feature

The automatic dimming feature is turned on and off by pressing the far left button, located on the lower part of the mirror face, for up to three seconds. A light on the mirror will be lit when the feature is turned on. It will go out when the feature is turned off.

Temperature Display

The ON/OFF button located on far left on the bottom of the mirror face changes the temperature display. You can select °F, °C, or turn the display off.

Compass Operation

There is a compass display in the window in the upper right corner of the mirror face. The compass displays a maximum of two characters. For example, NE is displayed for north-east.

The compass may need to be calibrated. See “Compass Calibration” in the Index for more information.



The other three buttons are for the OnStar system. See your dealer for more information on the system and how to subscribe to OnStar. See “OnStar® System” in the Index for more information about the services OnStar provides.

Power Outside Rearview Mirrors



The power mirror control is located near the driver’s window, on the armrest.

Turn the control counterclockwise to adjust the left mirror or clockwise to adjust the right mirror. Then move the control in the direction you want the mirror to go.

Convex Outside Mirror

Your passenger's side mirror is convex. A convex mirror's surface is curved so you can see more from the driver's seat.

CAUTION:

A convex mirror can make things (like other vehicles) look farther away than they really are. If you cut too sharply into the right lane, you could hit a vehicle on your right. Check your inside mirror or glance over your shoulder before changing lanes.

Storage Compartments

Glove Box

Use your key to lock and unlock the glove box. To open, lift the right side of the latch.

Overhead Console (If Equipped)



The optional overhead console has reading lamps and storage compartments (including one for your garage door opener and one for sunglasses). These features are explained on the following pages.

Reading Lamps

To turn either reading lamp on or off, press the switch next to it.

Garage Door Opener

You can store your garage door opener in the rear compartment of the overhead console, and operate it from this position. To install your garage door opener, follow these instructions:

1. Open the compartment by pressing the latch forward. Remove the hook and loop patch.
2. Peel the protective backing from the hook and loop patch and press it firmly to the back of your garage door opener.
3. Be sure that the button on your garage door opener is centered above the area with raised lines on the compartment door. Make sure the button is facing down and press the opener firmly into place.
4. Add one peg at a time until your garage door opener operates with the compartment door closed while pressing the button.

Sunglasses Storage Compartment

The sunglasses storage compartment is the second compartment from the rear on the overhead console. To open the sunglasses storage compartment, press the release latch forward and pull the compartment down to the full open position.

Center Console Storage

To open the armrest storage area, pull up on the front edge of the latch. The console has cassette and CD storage and a coinholder.

The center console also contains two cupholders. To access the cupholders, pull the cupholder door, located behind the console shift lever. The two cupholders will pop up into an upright position.

Below the center ashtray is an open storage compartment. In front of this, you may have a smaller compartment for storing smaller items.

Rear Armrest Storage (If Equipped)

If you have a trunk access panel, you will also have a pull down armrest that contains an open storage bin and two cupholders.

Trunk Access Panel (If Equipped)

If the vehicle has rear seat armrests, you will also have a trunk access panel.



This feature allows items in the trunk to pass through the rear seat. To use the trunk access panel, pull the rear armrest down, unlock the access panel with the ignition key and pull it down.

Convenience Net (If Equipped)

The vehicle may have a convenience net. You'll see it on the back wall of the trunk.

Put small loads, like grocery bags, in the net. It can help keep them from falling over during sharp turns or quick starts and stops.

The net isn't for larger, heavier loads. Store them in the trunk as far forward as you can.

You can unhook the net so that it will lie flat when you're not using it.

Ashtray and Cigarette Lighter

The center front ashtray is on the instrument panel. To open it, pull at the bottom of the ashtray until it is fully open. To remove the ashtray cup, lift the tabs on the sides and pull out. On four-door models an ashtray is located on each of the rear doors.

NOTICE:

Don't put papers and other things that burn into the ashtrays. If you do, cigarettes or other smoking materials could set them on fire, causing damage.

To use the lighter, located inside the center front ashtray, push it in all the way and let go. When it's ready, it will pop back out by itself.

NOTICE:

Don't hold a cigarette lighter in with your hand while it is heating. If you do, it won't be able to back away from the heating element when it's ready. That can make it overheat, damaging the lighter and the heating element.

Sun Visors

To block out glare, you can swing down the visors. You can also swing them from front to side.

Visor Vanity Mirrors

Open the cover to expose the vanity mirror. If the vehicle has the optional lighted vanity mirrors, the lamps come on when you open the cover.

Accessory Power Outlet

Your vehicle has a 12-volt outlet which can be used to plug in electrical equipment such as a cellular telephone, a compact disc player, etc. It is located on the passenger's side, near the floor.

Remove the tethered cap to use the outlet. When not using the outlet, be sure to cover it with the protective cap.

The accessory power outlet will only operate while the ignition is on and for a few minutes after turning the ignition off. If you would like to operate an accessory for an extended period of time, see your dealer for more information.

NOTICE:

When using accessory power outlets:

- **Maximum load of any outlet should not exceed the fuse rating.**
- **Be sure to turn off electrical equipment when not in use. Leaving electrical equipment on for extended periods can drain the battery.**

Certain electrical accessories may not be compatible with the accessory power outlet and could result in blown vehicle or adapter fuses. If you experience a problem, see your dealer for additional information on the accessory power plugs.

NOTICE:

Adding some electrical equipment to your vehicle can damage it or keep other things from working as they should. This wouldn't be covered by your warranty. Check with your dealer before adding electrical equipment, and never use anything that exceeds the fuse rating.

When adding electrical equipment, be sure to follow the proper installation instructions included with the equipment.

NOTICE:

Power outlets are designed for accessory plugs only. Do not hang any type of accessory or accessory bracket from the plug. Improper use of the power outlet can cause damage not covered by your warranty.

Auxiliary Power Connection (Power Drop)

The vehicle is equipped with an auxiliary power connection. This feature provides power ground and accessing wires which can be used to add aftermarket electrical equipment to the vehicle. The connection is located on the passenger's side of the vehicle, below the glove box on the right side of the console.

OnStar[®] System (If Equipped)

OnStar is a vehicle communications system that offers a variety of services and provides a one touch hands-free communication link between you and the OnStar Center. To receive OnStar services, a service subscription agreement is required and an additional fee may be required. Services are available 24 hours a day, 7 days a week. For more information, call 1-888-ONSTAR-7 (1-888-667-8277).



OnStar Services Button: Press this button once to contact an advisor who will be able to assist you with these services. If you are not quickly connected, the system will automatically reset and redial. This ensures connection to the center; there is no additional action required. Press the Communication button to cancel the automatic redial.

Emergency Button: In an emergency situation, press the emergency service button. Upon receiving the call, an advisor at the center will locate your vehicle and assess the situation. If necessary, the advisor will alert the nearest emergency service provider.

 **(Communication Button):** Press this button at the end of a call. Also press this button to answer a call from the center, or cancel a call if one of the other buttons is accidentally pressed. This button is also used to access OnStar Personal Calling and Virtual Advisor services. See the OnStar owner package for more information.

Volume Control: You can control the volume of the OnStar system using either the volume knob on the radio or if equipped, the steering wheel volume controls.

 **(Telltale Light):** This light will indicate the status of the system. A solid green light will come on when you start the vehicle to let you know that the system is on and is ready to make or receive calls.

If the light blinks green it means that an incoming or outgoing call is in progress. Press the Communications button if you notice the light blinking and you are not on a call.

The light will be red in the event of an OnStar system malfunction. If this occurs press the OnStar Services button to attempt to contact an advisor. If the connection is made, the advisor will assist you with steps to take to make sure that the system is functioning properly. If you cannot contact the advisor, take your vehicle to your dealership as soon as possible for assistance.

OnStar Services

The following services are available within OnStar service plans. Your vehicle comes with a specific one-year service plan that allows use of some or all of the following services.

- **Automatic Notification of Air Bag Deployment:** If an air bag deploys, a priority emergency signal is automatically sent to the center. An advisor will locate your vehicle's position, try to contact you and assist you in the situation. If the center is unable to contact you, an emergency service provider will be contacted.
- **Stolen Vehicle Tracking:** Call the center at 1-888-4-ONSTAR (1-888-466-7827) to report your vehicle stolen. The system can then attempt to locate and track your vehicle and the advisor will assist the proper authorities.
- **Roadside Assistance with Location:** For vehicle breakdowns, press the OnStar Services button. An advisor will contact the appropriate help.

- **Remote Diagnostics:** If an instrument panel light comes on, press the OnStar Services button. An advisor can perform a check of the engine on-board computer and recommend what action needs to be taken.
- **OnStar MED-NET:** Med-Net can store your personal medical history and provide it to emergency personnel if necessary. (Requires activation and additional fee).
- **Accident Assist:** An advisor can provide step-by-step guidance following an accident.
- **Remote Door Unlock:** To contact the center, call 1-888-4-ONSTAR. You will be required to provide your security information. An advisor will send a command to your vehicle to unlock itself. The advisor can delay unlocking your vehicle. Remote Door Unlock is disabled 48 hours after the vehicle is parked to maintain the battery charge.
- **Vehicle Locator Service:** To contact the center, call 1-888-4-ONSTAR. You will be required to provide your security information. An advisor will send a command to your vehicle to sound the horn and/or flash the lamps.
- **Route Support:** An advisor can provide directions or guidance to most places you want to go. In addition, they can help you locate gas stations, rest areas, ATMs, hospitals, hotels, stores, eateries and more.
- **Ride Assist:** An advisor can locate transportation in the event that you are unable to drive.
- **Concierge Services:** The concierge advisor can obtain tickets, reservations, or help with vacation/trip planning and other unique items and services.

OnStar System Limitations

Complete limitations can be found on the Subscriber Services Agreement.

In order to provide you with excellent service, calls with the OnStar Center may be monitored or recorded.

OnStar Service is:

- available in the 48 contiguous United States, Alaska, Hawaii and Canada;
- available when the vehicle is within the operating range of a cellular provider;
- subject to limitations caused by atmospheric conditions, such as severe weather or topographical conditions, such as mountainous terrain;
- subject to cellular carrier equipment limitations.

Global positioning locating capabilities will not be available if satellite signals are obstructed.

OnStar will not function if the vehicle's battery is discharged or disconnected. It may also be inoperative if the vehicle is in an accident and the OnStar or vehicle electrical system components are damaged.

OnStar is the communications link between you and existing governmental emergency and roadside service providers. OnStar will receive your call and use reasonable effort to contact an appropriate provider. OnStar cannot promise that the providers will respond in a timely manner or at all.

Purse or Litter Bag Holder

On the front of the center console, to the right of the accessory power outlet, there is a hook that can be used to hold a purse or litter bag.

Power Sunroof (Option)



Base Version Shown

The sunroof includes a sliding glass panel and a one-piece sunshade. The switch to control the sunroof is located in the headliner on the roof panel. The switch works only when the ignition is on or RAP is active. See “Retained Accessory Power (RAP)” in the Index.

Push the rear of the switch once and the sunroof will open to the vent position only. You will need to open the sunshade by hand.

Push the rear of the switch a second time and the sunroof will open the remainder of the way by itself. This is the express-open feature.

To close the sunroof, push and hold the front of the switch until the sunroof motor stops. The sunshade must be closed by hand.

The Instrument Panel -- Your Information System

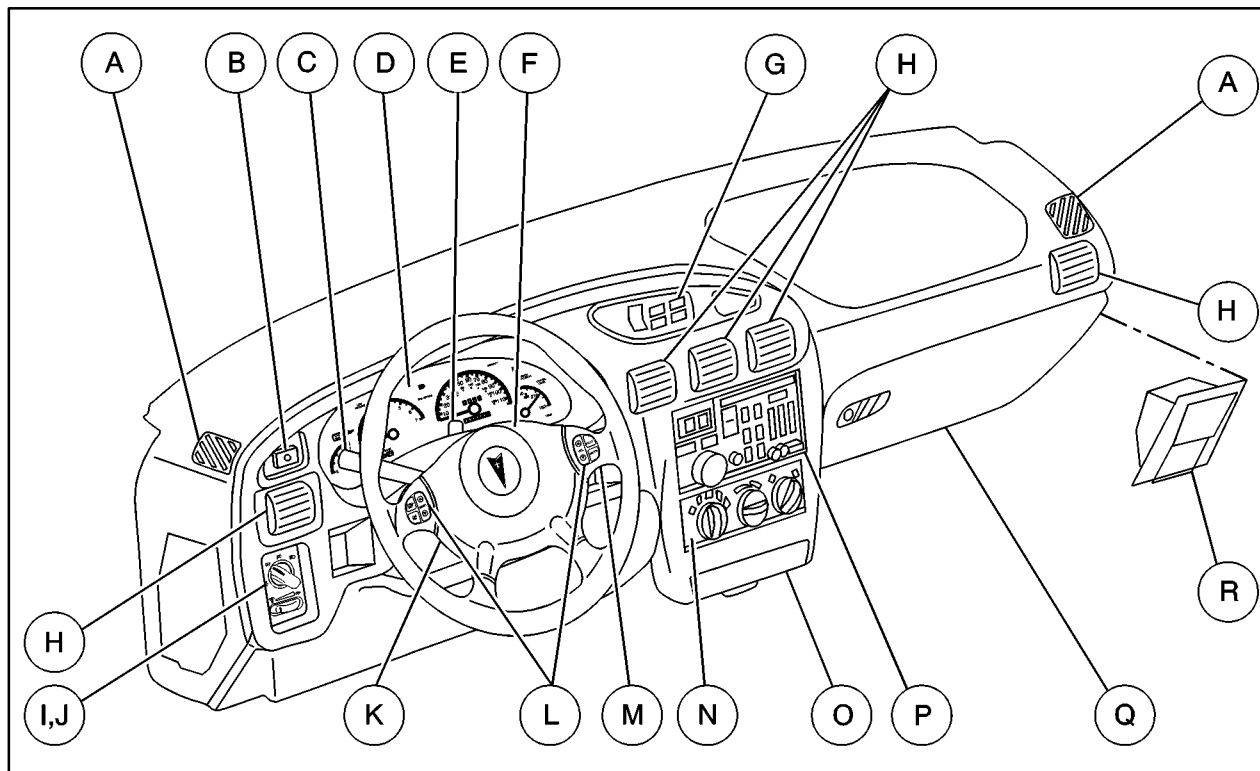

The main components of the instrument panel are the following:

- A. Side Window Defogger Vents
- B. Fog Lamp Switch
- C. Multifunction Lever
- D. Instrument Panel Cluster
- E. Hazard Warning Button
- F. Horn
- G. Trip Computer (If Equipped) and/or Driver Information Center (DIC)
- H. Instrument Panel Vents
- I. Interior Lamps Control
- J. Exterior Lamps Control
- K. Tilt Steering Wheel Control
- L. Audio Steering Controls (If Equipped)
- M. Head Up Display (HUD) Controls (Option)
- N. Comfort Controls
- O. Ashtray and Cigarette Lighter
- P. Audio System
- Q. Glove Box
- R. Instrument Panel Fuse Block

Instrument Panel Cluster

Your instrument panel cluster is designed to let you know at a glance how your vehicle is running. You'll know how fast you're going, about how much fuel is in your tank and many other things you need to drive safely and economically.

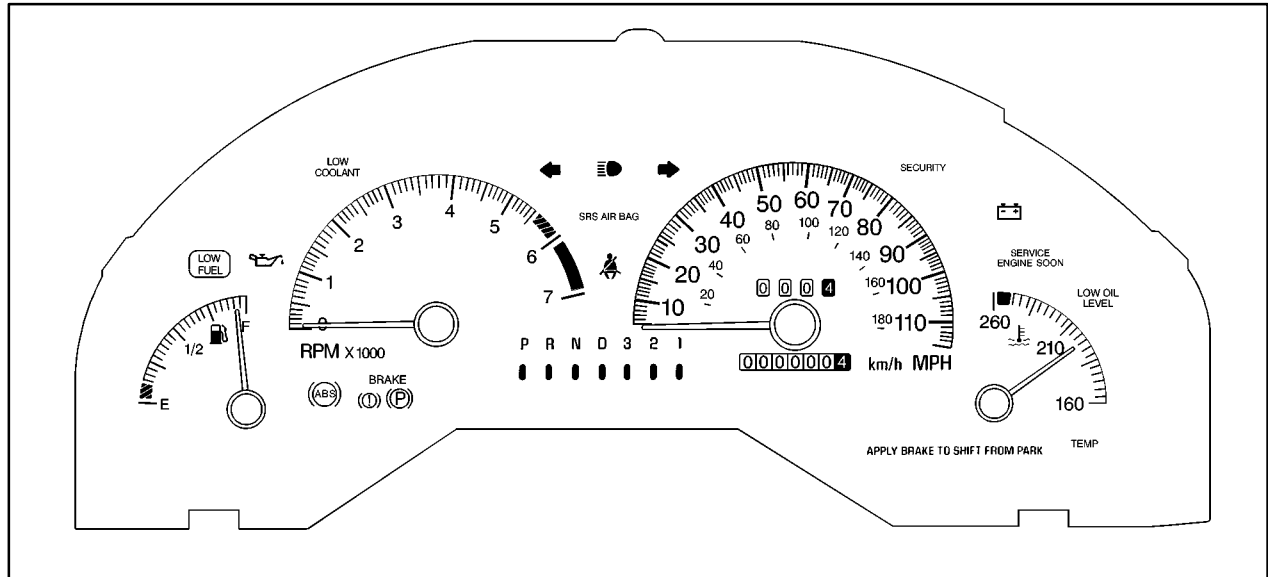

United States Version Shown, Canada Similar

Your vehicle is equipped with this cluster or one very similar to it. It includes indicator warning lights and gages that are explained on the following pages. Be sure to read about them.

Speedometer and Odometer

The speedometer lets you see your speed in both miles per hour (mph) and kilometers per hour (km/h). The odometer shows how far the vehicle has been driven in either miles (used in the United States) or in kilometers (used in Canada).

The vehicle has a tamper-resistant odometer. If you see silver lines between the numbers, you'll know someone has probably tampered with it and the numbers may not be correct.

You may wonder what happens if the vehicle needs a new odometer installed. If the new one can be set to the mileage total of the old odometer, then that will be done. If it can't, then it will be set at zero and a label must be put on the driver's door to show the old mileage reading when the new odometer was installed.

Trip Odometer

The trip odometer tells how far you have driven since you last reset it. To set it to zero, press the reset button located to the right of the instrument panel cluster.

Tachometer

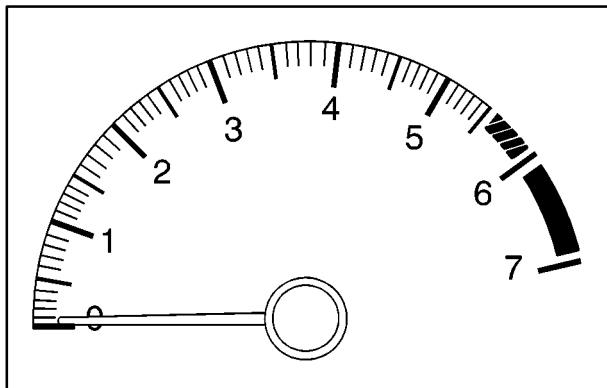

The tachometer displays the engine speed in thousands of revolutions per minute (rpm).

NOTICE:

Do not operate the engine with the tachometer in the shaded area, or engine damage may occur.

Warning Lights, Gages and Indicators

This part describes the warning lights and gages that may be on your vehicle. The pictures will help you locate them.

Warning lights and gages can signal that something is wrong before it becomes serious enough to cause an expensive repair or replacement. Paying attention to your warning lights and gages could also save you or others from injury.

Warning lights come on when there may be or is a problem with one of your vehicle's functions. As you will see in the details on the next few pages, some warning lights come on briefly when you start the engine just to let you know they're working. If you are familiar with this section, you should not be alarmed when this happens.

Gages can indicate when there may be or is a problem with one of your vehicle's functions. Often gages and warning lights work together to let you know when there's a problem with your vehicle.

When one of the warning lights comes on and stays on when you are driving, or when one of the gages shows there may be a problem, check the section that tells you what to do about it. Please follow this manual's advice. Waiting to do repairs can be costly -- and even dangerous. So please get to know your warning lights and gages. They're a big help.

Your vehicle may also have a driver information center that works along with the warning lights and gages. See "Driver Information Center (DIC)" in the Index.

Safety Belt Reminder Light

When the key is turned to RUN, a chime will come on for about eight seconds to remind people to fasten their safety belts, unless the driver's safety belt is already buckled.



The safety belt light will also come on and stay on for about 20 seconds, then it will flash for about 55 seconds.

If the driver's belt is already buckled, neither the chime nor the light will come on.

Air Bag Readiness Light

There is an air bag readiness light on the instrument panel, which shows the words SRS AIR BAG or the air bag symbol. The system checks the air bag's electrical system for malfunctions. The light tells you if there is an electrical problem. The system check includes the air bag sensors, the air bag modules, the wiring and the crash sensing and diagnostic module. For more information on the air bag system, see "Air Bag" in the Index.

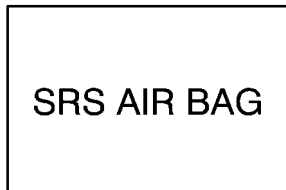

United States

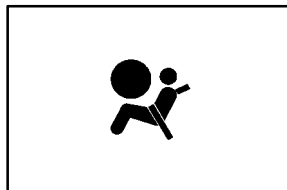

Canada

This light will come on when you start your vehicle, and it will flash for a few seconds. Then the light should go out. This means the system is ready.

If the air bag readiness light stays on after you start the vehicle or comes on when you are driving, your air bag system may not work properly. Have your vehicle serviced right away.

CAUTION:

If the air bag readiness light stays on after you start your vehicle, it means the air bag system may not be working properly. The air bags in your vehicle may not inflate in a crash, or they could even inflate without a crash. To help avoid injury to yourself or others, have your vehicle serviced right away if the air bag readiness light stays on after you start your vehicle.

The air bag readiness light should flash for a few seconds when you turn the ignition key to RUN. If the light doesn't come on then, have it fixed so it will be ready to warn you if there is a problem.

Charging System Indicator Light

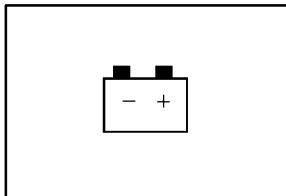

The charging system light will come on briefly when you turn on the ignition, as a check to show you it's working. Then it will go out.

If it stays on, or comes on while you are driving, you may have a problem with the electrical charging system. It could indicate that you have a loose drive belt or another electrical problem. Have it checked right away. Driving while this light is on could drain your battery.

If you must drive a short distance with the light on, be certain to turn off all your accessories, such as the radio and air conditioner.

Brake System Warning Light

Your vehicle's hydraulic brake system is divided into two parts. If one part isn't working, the other part can still work and stop you. For good braking, though, you need both parts working well.

If the warning light comes on, there is a brake problem. Have your brake system inspected right away.

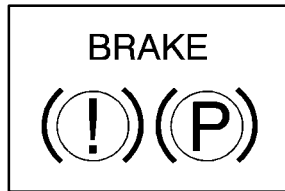

United States

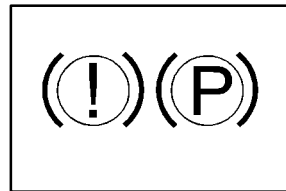

Canada

This light should come on when you turn the key to RUN. If it doesn't come on then, have it fixed so it will be ready to warn you if there's a problem.

If the light comes on while you are driving, pull off the road and stop carefully. You may notice that the pedal is harder to push. Or, the pedal may go closer to the floor. It may take longer to stop. If the light is still on, have the vehicle towed for service. See “Towing Your Vehicle” in the Index.

 **CAUTION:**

Your brake system may not be working properly if the brake system warning light is on. Driving with the brake system warning light on can lead to an accident. If the light is still on after you’ve pulled off the road and stopped carefully, have the vehicle towed for service.

When the ignition is on, the brake system warning light will also come on when you set your parking brake. The light will stay on if your parking brake doesn’t release fully. If it stays on after your parking brake is fully released, it means you have a brake problem.

Anti-Lock Brake System Warning Light

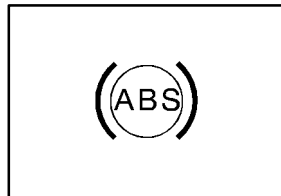

With the anti-lock brake system, the light will come on when your engine is started and may stay on for three seconds. That’s normal.

If the anti-lock brake system warning light stays on longer than normal after you’ve started your engine, turn the ignition off. Or, if the light comes on and stays on when you’re driving, stop as soon as possible and turn the ignition off. Then start the engine again to reset the system. If the light still stays on, or comes on again while you’re driving, your vehicle needs service. If the light is on and the regular brake system warning light isn’t on, you still have brakes, but you don’t have anti-lock brakes.

The anti-lock brake system warning light should come on briefly when you turn the ignition key to RUN. If the light doesn’t come on then, have it fixed so it will be ready to warn you if there is a problem.

Traction Control System Warning Light (3800 Supercharged V6 Engine Only)

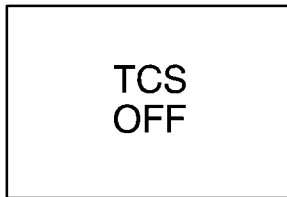

The traction control system warning light may come on for the following reasons:

- If you turn the system off by pressing the TCS button located on the far right side of the trip computer, the warning light will come on and stay on. To turn the system back on, press the button again. The warning light should go off. See “Traction Control System” in the Index for more information.
- If there’s a brake system problem that is specifically related to traction control, the traction control system will turn off and the warning light will come on. If your brakes begin to overheat, the traction control system will turn off and the warning light will come on until your brakes cool down.

If the traction control system warning light comes on and stays on for an extended period of time when the system is turned on, your vehicle needs service.

Enhanced Traction System Warning Light (3100 V6 or 3800 V6 Engine)

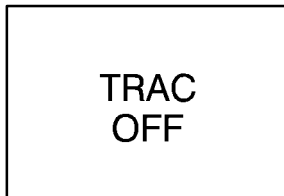

The Enhanced Traction System warning light may come on for the following reasons:

- If you turn the system off by pressing the TRAC button on the far right side of the Driver Information Center or trip computer (if equipped), the warning light will come on and stay on. To turn the system back on, press the button again. The warning light should go off. See “Enhanced Traction System” in the Index for more information.
- If the Enhanced Traction System warning light comes on and stays on for an extended period of time when the system is turned on, your vehicle needs service. Adjust your driving accordingly.
- If the traction control system is affected by an engine-related problem, the system will turn off and the warning light will come on.

When this warning light is on, the system will not limit wheel spin. Adjust your driving accordingly.

Low Traction Light

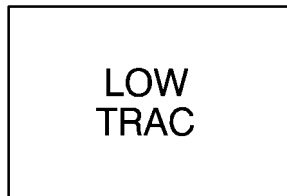

If you have the Enhanced Traction System or the Traction Control System, this light will also come on when the system is limiting wheel spin.

You may feel or hear the system working, but this is normal. Slippery road conditions may exist if the low traction light comes on, so adjust your driving accordingly. The light will stay on for a few seconds after the Enhanced Traction System or the Traction Control System stops limiting wheel spin. See “Enhanced Traction System” or “Traction Control System” in the Index.

The low traction light also comes on briefly when you turn the ignition key to RUN. If the light doesn't come on then, have it fixed so it will be there to tell you when the Traction Control System or Enhanced Traction System is active.

Engine Coolant Temperature Light

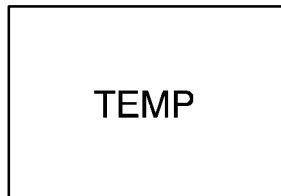

This light tells you that the engine coolant has overheated or the radiator cooling fan is not working.

If you have been operating the vehicle under normal driving conditions, you should pull off the road, stop the vehicle and turn off the engine as soon as possible.

See “Engine Overheating” in the Index.

Engine Coolant Temperature Gage

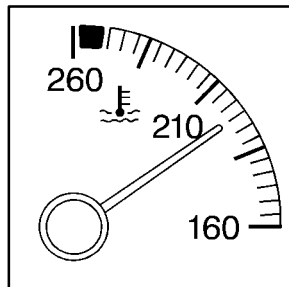

United States

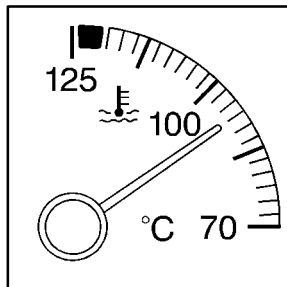

Canada

Your vehicle has a gage that shows the engine coolant temperature. If the gage pointer moves into the shaded area, the engine is too hot.

That reading means the same thing as the warning light. It means that the engine coolant has overheated. If you have been operating the vehicle under normal conditions, you should pull off the road, stop the vehicle, and turn off the engine as soon as possible.

See “Engine Overheating” in the Index.

Low Coolant Warning Light

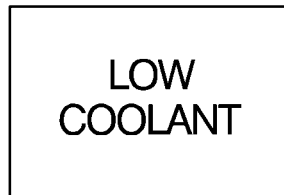

If this light comes on, the system is low on coolant and the engine may overheat.

See “Engine Coolant” in the Index and have the vehicle serviced as soon as possible.

Malfunction Indicator Lamp (Service Engine Soon Light in the United States or Check Engine Light in Canada)



United States

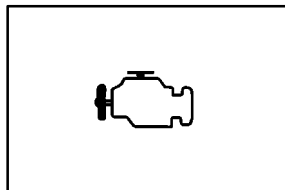

Canada

Your vehicle is equipped with a computer which monitors operation of the fuel, ignition and emission control systems.

This system is called OBD II (On-Board Diagnostics-Second Generation) and is intended to assure that emissions are at acceptable levels for the life of the vehicle, helping to produce a cleaner environment. The SERVICE ENGINE SOON or CHECK ENGINE light comes on to indicate that there is a problem and service is required. Malfunctions often will be indicated by the system before any problem is apparent. This may prevent more serious damage to your vehicle. This system is also designed to assist your service technician in correctly diagnosing any malfunction.

NOTICE:

If you keep driving your vehicle with this light on, after a while, your emission controls may not work as well, your fuel economy may not be as good and your engine may not run as smoothly. This could lead to costly repairs that may not be covered by your warranty.

NOTICE:

Modifications made to the engine, transaxle, exhaust, intake or fuel system of your vehicle or the replacement of the original tires with other than those of the same Tire Performance Criteria (TPC) can affect your vehicle's emission controls and may cause the SERVICE ENGINE SOON or CHECK ENGINE light to come on. Modifications to these systems could lead to costly repairs not covered by your warranty. This may also result in a failure to pass a required Emission Inspection/Maintenance test.

This light should come on, as a check to show you it is working, when the ignition is on and the engine is not running. If the light doesn't come on, have it repaired. This light will also come on during a malfunction in one of two ways:

- **Light Flashing** -- A misfire condition has been detected. A misfire increases vehicle emissions and may damage the emission control system on your vehicle. Dealer or qualified service center diagnosis and service may be required.
- **Light On Steady** -- An emission control system malfunction has been detected on your vehicle. Dealer or qualified service center diagnosis and service may be required.

If the Light Is Flashing

The following may prevent more serious damage to your vehicle:

- Reducing vehicle speed.
- Avoiding hard accelerations.
- Avoiding steep uphill grades.
- If you are towing a trailer, reduce the amount of cargo being hauled as soon as it is possible.

If the light stops flashing and remains on steady, see “If the Light Is On Steady” following.

If the light continues to flash, when it is safe to do so, *stop the vehicle*. Find a safe place to park your vehicle. Turn the key off, wait at least 10 seconds and restart the engine. If the light remains on steady, see “If the Light Is On Steady” following. If the light is still flashing, follow the previous steps, and drive the vehicle to your dealer or qualified service center for service.

If the Light Is On Steady

You may be able to correct the emission system malfunction by considering the following:

Did you recently put fuel into your vehicle?

If so, reinstall the fuel cap, making sure to fully install the cap. See “Filling Your Tank” in the Index. The diagnostic system can determine if the fuel cap has been left off or improperly installed. A loose or missing fuel cap will allow fuel to evaporate into the atmosphere. A few driving trips with the cap properly installed should turn the light off.

Did you just drive through a deep puddle of water?

If so, your electrical system may be wet. The condition will usually be corrected when the electrical system dries out. A few driving trips should turn the light off.

Are you low on fuel?

As your engine starts to run out of fuel, your engine may not run as efficiently as designed since small amounts of air are sucked into the fuel line causing a misfire. The system can detect this. Adding fuel should correct this condition. Make sure to install the fuel cap properly. See “Filling Your Tank” in the Index. It will take a few driving trips to turn the light off.

Have you recently changed brands of fuel?

If so, be sure to fuel your vehicle with quality fuel. See “Fuel” in the Index. Poor fuel quality will cause your engine not to run as efficiently as designed. You may notice this as stalling after start-up, stalling when you put the vehicle into gear, misfiring, hesitation on acceleration or stumbling on acceleration. (These conditions may go away once the engine is warmed up.) This will be detected by the system and cause the light to turn on.

If you experience one or more of these conditions, change the fuel brand you use. It will require at least one full tank of the proper fuel to turn the light off.

If none of the above steps have made the light turn off, have your dealer or qualified service center check the vehicle. Your dealer has the proper test equipment and diagnostic tools to fix any mechanical or electrical problems that may have developed.

Emissions Inspection and Maintenance Programs

Some state/provincial and local governments have or may begin programs to inspect the emission control equipment on your vehicle. Failure to pass this inspection could prevent you from getting a vehicle registration.

Here are some things you need to know in order to help your vehicle pass an inspection:

Your vehicle will not pass this inspection if the SERVICE ENGINE SOON or CHECK ENGINE light is on or not working properly.

Your vehicle will not pass this inspection if the OBD (on-board diagnostic) system determines that critical emission control systems have not been completely diagnosed by the system. The vehicle would be considered not ready for inspection. This can happen if you have recently replaced your battery or if your battery has run down. The diagnostic system is designed to evaluate critical emission control systems during normal driving. This may take several days of routine driving. If you have done this and your vehicle still does not pass the inspection for lack of OBD system readiness, see your dealer or qualified service center to prepare the vehicle for inspection.

Oil Pressure Light

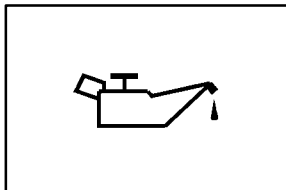

United States

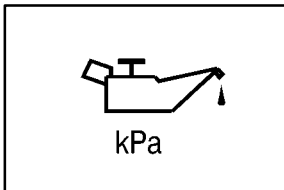

Canada

If you have a problem with your oil pressure, this light may stay on after you start your engine, or come on when you are driving.

This indicates that oil is not going through your engine quickly enough to keep it lubricated. The engine could be low on oil or could have some other oil problem. Have it fixed right away.

The oil light could also come on in two other situations:

- When the ignition is on but the engine is not running, the light will come on as a test to show you it's working. The light will go out when you turn the ignition to RUN. If it doesn't come on with the ignition on, you may have a problem with the fuse or bulb. Have it fixed right away.

- If you make a hard stop, the light may come on for a moment. This is normal.

CAUTION:

Don't keep driving if the oil pressure is low. If you do, your engine can become so hot that it catches fire. You or others could be burned. Check your oil as soon as possible and have your vehicle serviced.

NOTICE:

Damage to your engine from neglected oil problems can be costly and is not covered by your warranty.

Low Oil Level Light

A rectangular box with a black border containing the text "LOW OIL LEVEL" in bold, black, uppercase letters, centered.

**LOW OIL
LEVEL**

The engine is equipped with an oil level monitoring system. When the ignition key is turned to RUN, the LOW OIL LEVEL light will briefly flash.

If the light does not flash, have it fixed so it will be ready to warn you if there is a problem.

If the light stays on, stop the vehicle on a level surface and turn the engine off. Check the oil level using the engine oil dipstick. See “Engine Oil” in the Index.

The oil level monitoring system only checks the oil level during the brief period when the ignition key is between RUN and START. It does not monitor engine oil level when the engine is running. Additionally, an oil level check is only performed if the engine has been turned off for a considerable period of time, allowing the oil normally in circulation to drain back into the oil pan.

Security Light

A rectangular box with a black border containing the text "SECURITY" in bold, black, uppercase letters, centered.

SECURITY

This message is displayed to monitor the Pass-Key[®] III system.

If the SECURITY message is displayed continuously while driving, there may be a problem with the Pass-Key III system. Your vehicle will not be protected by Pass-Key III, and you should see your dealer for service. For more information see “PASS-Key III[®] System” in the Index.

Fuel Gage

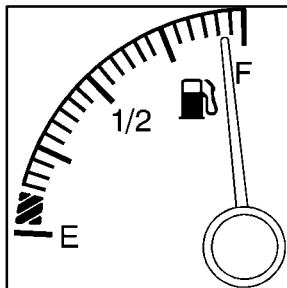

United States

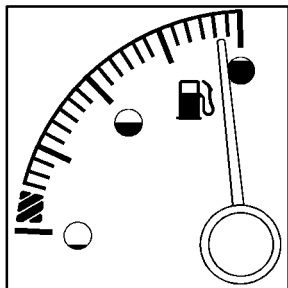

Canada

The fuel gage tells you about how much fuel you have left when the ignition is on. When the indicator nears empty, you still have a little fuel left, but you should get more soon.

Here are four things owners usually ask about the fuel gage. All these situations are normal and do not indicate a problem with the fuel gage:

- At the gas station, the pump shuts off before the gage reads full.

- It takes more (or less) fuel to fill up than the gage indicates. For example, the gage reads half full, but it took more (or less) than half the tank's capacity to fill it.
- The gage pointer may move while cornering, braking or speeding up.
- The gage may not indicate full when the ignition is turned off.

Low Fuel Warning Light

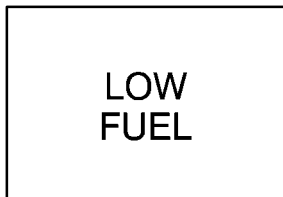

If your fuel is low, the warning light near the fuel gage will go on.

It will also come on for a few seconds when you first turn on the ignition as a check to show you it's working properly. If it doesn't come on then, see your dealer for service.

Driver Information Center (DIC)

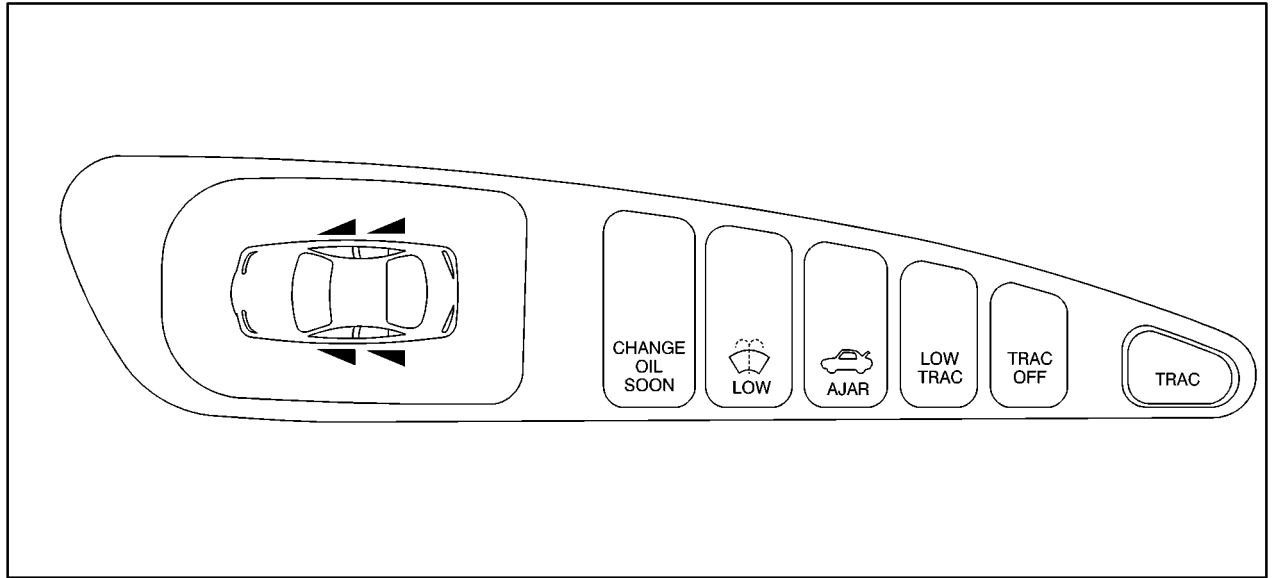

3100 V6 or 3800 V6 Engine Only

The Driver Information Center (DIC) gives you important safety and maintenance facts. When you turn the ignition on, all of the DIC lights illuminate for a few seconds. After this, the DIC will begin working.

Functions



(Door Ajar): If one of the doors is ajar, this light will appear next to that door on the vehicle outline.

CHANGE OIL SOON: This light will appear when the system indicates that it's time for an oil change. The system predicts remaining oil life using data from length of drives, coolant temperature, engine rpm and vehicle speed. It alerts you to change the oil on a schedule consistent with the vehicle's driving conditions. After changing the oil, the system must be reset. See "How to Reset the GM Oil Life System™" in the Index.



LOW: This light will come on when the ignition is on and the fluid in the washer fluid container is low.



AJAR: This light alerts you that the trunk is not fully closed.

LOW TRAC (Low Traction): This light will come on when the enhanced traction system is limiting wheel spin. See "Enhanced Traction System" or "Low Traction Light" in the Index.

TRAC OFF (Traction Off): This light lets you know that the enhanced traction system has been disabled and will not limit wheel spin. See "Enhanced Traction System Warning Light" or "Low Traction Light" in the Index.

TRAC (Traction): If the vehicle has the enhanced traction system, you will have a disable button on the far right side of the DIC. The enhanced traction system is automatically activated when you turn the ignition on. This button will activate/deactivate the system. If you need to disable the system, such as when you are stuck and are rocking the vehicle back and forth, push this button. See "Stuck: In Sand, Mud, Ice or Snow" in the Index.

Trip Computer (If Equipped)

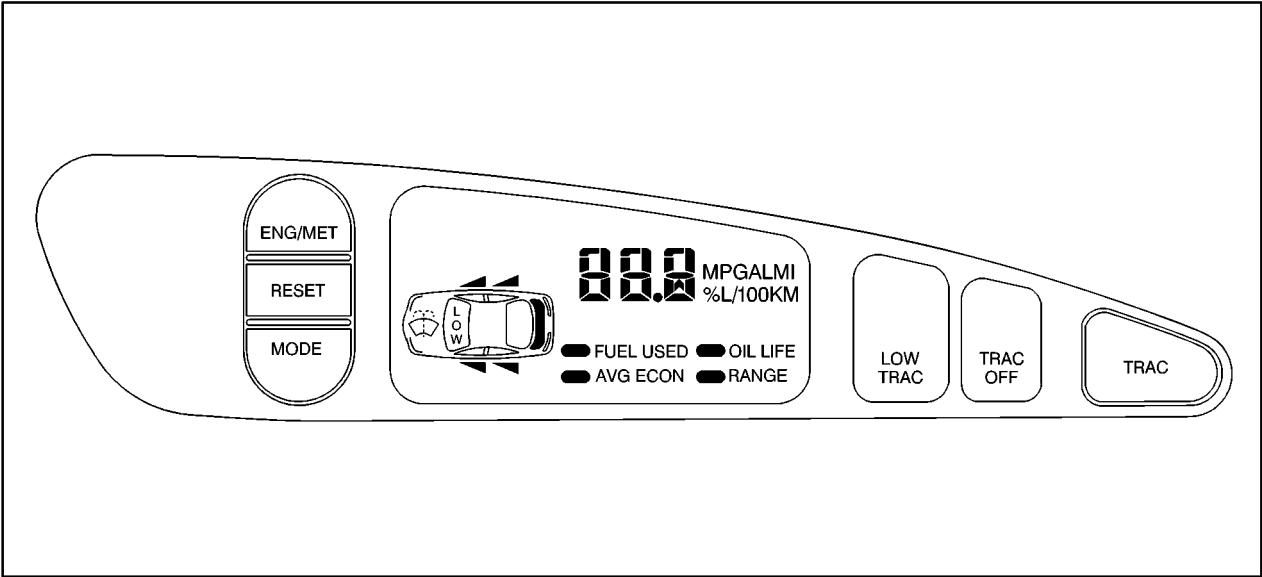

3100 V6 and 3800 V6 Engines

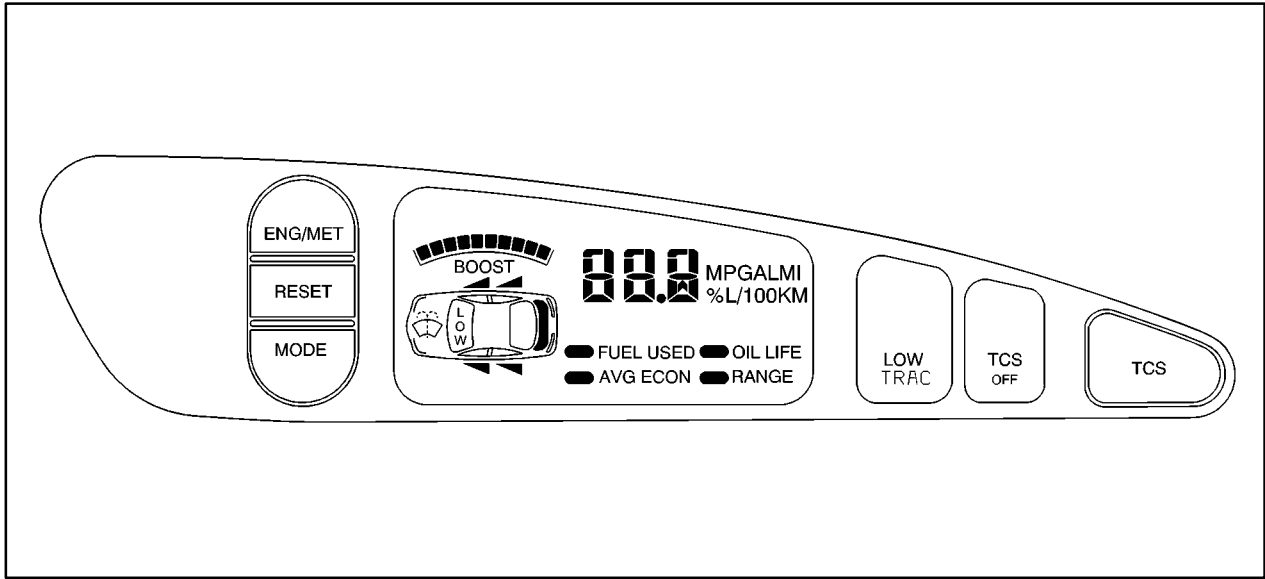

3800 V6 Supercharged Engine

When you start the engine, the trip computer will display a mode. A lighted oval will appear to the left of the mode currently being used.

Control Buttons

The trip computer has three buttons that control its functions.

ENG/MET (English/Metric): Press this button to change the display from English to metric units or metric to English.

RESET: Press this button for two seconds to reset the mode displayed.

MODE: Press this button to change the mode being displayed.

Functions

FUEL USED: Shows the total amount of fuel used since you last reset this mode. The amount can be displayed in gallons or liters.

AVG ECON (Average Economy): Shows the average fuel economy since you last reset this mode.

OIL LIFE: Shows a percentage of the oil's remaining useful life. The system predicts remaining oil life using data from length of drives, coolant temperature, engine rpm and vehicle speed. Each time you get an oil change, be sure to reset this function so that it will give you an accurate percentage. See "How to Reset the GM Oil Life System™" in the Index.

RANGE: Shows how much farther you can travel with the fuel you have remaining in the gas tank before refueling. When the range displays L, for 40 to 50 miles (64.36 to 80.45 km), the display will flash LOW continuously. The range is calculated from the AVG ECON value multiplied by the fuel remaining in the tank.

LOW: This light will come on the vehicle outline when the ignition is on and the fluid in the washer fluid container is low.

DOOR AJAR: If one of the doors is left ajar, a light will appear next to that door on the vehicle outline.

BOOST GAGE: If you have the 3800 V6 supercharged engine, this gage will show the amount of boost the engine is receiving.

TRUNK AJAR: If the trunk is not fully closed, the trunk area will light up on the vehicle outline.

LOW TRAC (Low Traction): This light will come on when the enhanced traction system (3100 or 3800 V6 engine) or the traction control system (3800 supercharged V6 engine) is limiting wheel spin. See "Traction Control System" "Enhanced Traction System" and "Low Traction Light" in the Index.

TRAC OFF (Traction Off) or TCS OFF (Traction Control System Off): This light lets you know that the enhanced traction system (3100 or 3800 V6 engine) or the traction control system (3800 supercharged V6 engine) has been disabled and will not limit wheel spin. See “Traction Control System Warning Light,” “Enhanced Traction System Warning Light” and “Low Traction Light” in the Index.

TRAC (Traction) or TCS (Traction Control System): If the vehicle has the enhanced traction system (3100 or 3800 V6 engine) or the traction control system (3800 supercharged V6 engine), you will have a disable button on the far right side of the trip computer. The enhanced traction system and traction control system are automatically activated when you turn the ignition on. This button will activate/deactivate the system. If you need to disable the system, such as when you are stuck and are rocking the vehicle back and forth, push this button. See “Stuck: In Sand, Mud, Ice or Snow” in the Index.

Head-Up Display (HUD) (Option)

CAUTION:

If the HUD image is too bright, or too high in your field of view, it may take you more time to see things you need to see when it's dark outside. Be sure to keep the HUD image dim and placed low in your field of view.



If you have the Head-Up Display (HUD), you can see the speedometer reading (in English or metric units) and a brief display of the current radio station or CD track, displayed “through” the windshield.

When you sit up straight in your seat, the HUD image will appear straight ahead near the front bumper.

The HUD also shows the following lights when they are lit on the instrument panel cluster:

- Turn Signal Indicators
- High-Beam Indicator Symbol
- Low Fuel Symbol

The HUD will display CHECK GAGES when the following items are lit on the instrument panel cluster:

- Oil Warning Symbol
- Coolant Temperature Symbol
- Charging System Symbol

When the ignition key is turned to RUN, the entire HUD image will come on. Then the Head-Up Display will operate normally.

NOTICE:

Although the HUD image appears to be near the front of the vehicle, do not use it as a parking aid. The HUD was not designed for that purpose. If you try to use it that way, such as in a parking lot, you may misjudge distance and run into something.

When the HUD is on, the speedometer reading will be displayed continually. The current radio station or CD track number will only be displayed for three seconds after the radio or CD track status changes. This will happen whenever one of the radio controls is pressed, either on the radio itself or on the optional steering wheel controls.

To adjust the HUD so you can see it properly do the following:



1. Adjust your seat, if necessary, to a comfortable position.
2. Start the engine and adjust the HUD controls located on the instrument panel, to the right of the steering wheel. Move the DIM thumbwheel up or down to adjust brightness.

3. Press the top of the UP/DN switch until the HUD image stops moving. Then press the bottom of the switch until the image is as low as possible but in full view.
4. Move the DIM thumbwheel down until the HUD image is no brighter than necessary. To turn the HUD off, move the DIM thumbwheel all the way down.

If the sun comes out, it becomes cloudy, or if you turn on your headlamps, you may need to adjust the HUD brightness again. Polarized sunglasses could make the HUD image harder to see.



Push the ENG/MET button on the trip calculator, located above the audio controls on the trip computer (if equipped) on the instrument panel, to switch the HUD display from English to metric or metric to English.

If your vehicle is not equipped with the trip calculator, you cannot change the display.

Care of the Head-Up Display



Clean the inside of the windshield as needed to remove any dirt or film that reduces the sharpness or clarity of the HUD image.

To clean the HUD, spray household glass cleaner on a soft, clean cloth. Wipe the HUD lens gently, then dry it. Do not spray cleaner directly on the lens because the cleaner could leak into the unit.

If You Can't See the HUD Image When the Ignition Is On

- Is anything covering the HUD unit?
- Is the HUD dimmer setting bright enough?
- Is the HUD image adjusted to the proper height?
- Still no HUD image? Check the fuse in the instrument panel fuse block. See “Fuses and Circuit Breakers” in the Index.

If the HUD Image Is Not Clear

- Is the HUD image too bright?
- Are the windshield and HUD lens clean?

The windshield is part of the HUD system. If you ever need a new windshield, be sure to get one designed for HUD. If you don't, the HUD image may look blurred and out of focus.



Section 3 Comfort Controls and Audio Systems

In this section, you'll find out how to operate the comfort control and audio systems offered with your vehicle. Be sure to read about the particular systems supplied with your vehicle.

3-2	Comfort Controls	3-13	AM-FM Stereo with Compact Disc Player and Equalizer (If Equipped)
3-2	Dual Climate Control System	3-15	Theft-Deterrent Feature
3-4	Rear Window Defogger	3-18	Audio Steering Wheel Controls (If Equipped)
3-5	Ventilation System	3-19	Understanding Radio Reception
3-5	Audio Systems	3-19	Tips About Your Audio System
3-6	Setting the Clock	3-20	Care of Your Cassette Tape Player
3-6	AM-FM Stereo with Cassette Tape Player	3-21	Care of Your Compact Discs
3-10	AM-FM Stereo with Compact Disc Player (Option)	3-21	Care of Your Compact Disc Player
		3-21	Backglass Antenna

Comfort Controls

Dual Climate Control System



This system allows the driver and passenger to maintain separate temperature settings. The system works best if you keep the windows closed while using it.

Fan Knob

The knob on the left side of the climate control panel regulates the fan speed. To turn the fan off, turn the knob to OFF. The fan must be on for the air conditioning compressor to operate.

Driver's Temperature Lever

The lever on the left adjusts the air temperature on the driver's side of the vehicle only. The passenger's side has its own lever for temperature control. Slide the lever upward to raise the temperature. Slide the lever downward to lower the temperature.

Passenger's Temperature Lever

The lever on the right adjusts the air temperature on the passenger's side of the vehicle only. The driver's side has its own lever for temperature control. Slide the lever upward to raise the temperature. Slide the lever downward to lower the temperature.

Mode Knob

The knob on the right side of the climate control panel has several settings to adjust the direction of the airflow:



MAX (Maximum): This setting recirculates much of the air inside your vehicle and sends it through the instrument panel outlets. The air conditioning compressor will run automatically in this setting unless the outside temperature is below 38°F (3.3°C). (Even when the compressor is running, you can control the temperature.)



(Vent): This setting brings in outside air and directs it through the instrument panel outlets.



(Bi-Level): This setting brings in outside air and directs it two ways. Half of the air is directed through the vent outlets. Most of the remaining air is directed through the floor ducts and a small amount to the defrost and side window vents.



(Floor): This setting sends most of the air through the ducts near the floor. The remaining airflow comes out of the defroster and side window vents.



(Defogger): This setting allows half of the air to go to the floor ducts and half to the defroster and side window vents.



FRONT (Defroster): This setting directs most of the air through the defroster. Some of the air goes to the floor ducts and the side window vent. The air conditioning compressor will run automatically in this setting unless the outside temperature is below 38°F (3.3°C).

Air Conditioning Compressor Button

Press the A/C button to operate the air conditioning compressor. The indicator light above the button will glow when the button is pressed. You don't have to

press the button to run the compressor in MAX or defrost because it will already be running in these modes.

Air Conditioning

On very hot days, open the windows long enough to let hot, inside air escape. This reduces the time it takes for the vehicle to cool down.

For quick cool down on very hot days, turn the fan on and use MAX with the temperature levers all the way in the blue area. If this setting is used for long periods of time, the air in your vehicle may become too dry.

For normal cooling on hot days, turn the fan on and use vent with the temperature levers in the blue area and the A/C button pressed in. The system will bring in outside air and cool it.

On cool, but sunny days, the sun may warm your upper body, but your lower body may not be warm enough. To remedy this, you can use bi-level with the temperature levers in the middle and the A/C button pushed in. The system will bring in outside air and direct it to your upper body, while sending slightly warmed air to your lower body.

Heating

On cold days select a fan setting and use floor with the temperature levers all the way in the red area. The system will bring in outside air, heat it and send it to the floor ducts.

If your vehicle has an engine coolant heater, you can use it to help your system provide warm air faster when it's cold outside 0°F (-18°C) or lower. An engine coolant heater warms the coolant your engine and heating system use to provide heat. See “Engine Coolant Heater” in the Index.

Ventilation

For mild outside temperatures when little heating or cooling is needed, use a fan setting and vent with the A/C button off, to direct outside air through your vehicle.

Defogging and Defrosting

Your system has two settings for clearing the front and side windows. To defrost the windows quickly, turn the fan to a high setting and use defroster with the temperature levers all the way in the red area. To warm passengers while keeping the windows clear, use defogger.

Rear Window Defogger

The rear window defogger uses a warming grid to remove fog from the rear window.



The comfort control system has a button to operate your vehicle's rear window defogger. It is marked REAR.

Press the button to turn the rear window defogger on or off. When the rear window defogger is operating, an indicator above this button will light. The rear warming grid will turn off after about 15 minutes.

If you turn the rear window defogger on again, it will operate for about seven and one half minutes before turning off. The system will turn off when the ignition is turned off.

Do not attach anything like a temporary vehicle license or decal across the rear window defogger grid.

NOTICE:

Don't use a razor blade or anything else sharp on the inside of the rear window. If you do, you could cut or damage the warming grid, and the repairs wouldn't be covered by your warranty.

Ventilation System



Change the direction of airflow by adjusting the louvered vents.

Your vehicle's flow-through ventilation system supplies outside air into the vehicle when it is moving. Outside air will also enter the vehicle when the air conditioning compressor is running.

Ventilation Tips

- Keep the hood and front air inlet free of ice, snow or any other obstruction, such as leaves. The heater and defroster will work far better, reducing the chance of fogging the inside of your windows.
- When you enter a vehicle in cold weather, adjust the mode knob to floor and the fan to the highest speed for a few seconds before driving off. This helps clear the intake ducts of snow and moisture and reduces the chance of fogging the inside of your windows.
- Keep the air path under the front seats clear of objects. This helps air to circulate throughout your vehicle.

Audio Systems

Your audio system has been designed to operate easily and give years of listening pleasure. You will get the most enjoyment out of it if you acquaint yourself with it first. Find out what your audio system can do and how to operate all of its controls, to be sure you're getting the most out of the advanced engineering that went into it.

Your vehicle has a feature called Retained Accessory Power (RAP). With RAP, you can play your audio system even after the ignition is turned off. See "Retained Accessory Power (RAP)" in the Index.

Setting the Clock

Press **RECALL**, then press and hold **HR** or **MIN** for two seconds. Then press and hold **HR** until the correct hour appears. **AM** or **PM** will appear on the display. Press and hold **MIN** until the correct minute appears. The clock can only be set with the ignition off.

AM-FM Stereo with Cassette Tape Player



Playing the Radio

POWER: Push this knob to turn the system on and off.

VOL (Volume): Turn this knob clockwise to increase volume. Turn it counterclockwise to decrease volume.

RECALL: Press this button to display the time with the ignition on or off. When the radio is playing, press this knob to display the station frequency.

Finding a Station

AM/FM: Press this button to switch between AM, FM1 and FM2. The display shows your selection.

TUNE: Press this knob lightly so it extends. Turn it to choose radio stations. Press the knob back into its stored position when you're not using it.

▲SEEK▼: Press the up or down arrow to go to the next or previous station and stay there.

Setting Preset Stations

The six numbered pushbuttons let you return to your favorite stations. You can set up to 18 stations (six AM, six FM1 and six FM2) by performing the following steps:

1. Turn the radio on.
2. Press **AM/FM** to select the band.

3. Tune in the desired station.
4. Press and hold one of the six numbered pushbuttons until SET appears on the display. Whenever you press that numbered pushbutton, the station you set will return.
5. Repeat the steps for each pushbutton.

Setting the Tone (Bass/Treble)

BASS: Slide the lever to the right or left to increase or decrease bass.

TREBLE: Slide the lever to the right or left to increase or decrease treble. If a station is weak or noisy, you may want to decrease the treble.

Adjusting the Speakers (Balance/Fade)

BAL (Balance): Press this knob lightly so it extends. Turn this knob to move the sound to the left or right speakers. The middle position balances the sound between the speakers.

FADE: Press this knob lightly so it extends. Turn this knob to move the sound to the front or rear speakers. The middle position balances the sound between the speakers.

Press these knobs back into their stored positions when you're not using them.

Playing a Cassette Tape

Your tape player is built to work best with tapes that are up to 30 to 45 minutes long on each side. Tapes longer than that are so thin they may not work well in this player.

While the tape is playing, use the VOL, FADE, BAL, BASS and TREBLE controls just as you do for the radio. The display will show an arrow to show which side of the tape is playing. When the down indicator arrow is lit, selections listed on the bottom side of the cassette are playing. When the up arrow is lit, selections listed on the top side of the cassette are playing. The tape player automatically begins playing the other side when it reaches the end of the tape.

If an error appears on the display, see “Cassette Tape Messages” later in this section.

1 PREV (Previous): Press this pushbutton or the SEEK down arrow to search for the previous selection on the tape. Your tape must have at least three seconds of silence between each selection for previous or seek to work. Press PREV or the SEEK down arrow to stop searching. The tape direction arrow blinks and the sound will mute during previous or seek operation.

2 NEXT: Press this pushbutton or the SEEK up arrow to search for the next selection on the tape. If you hold the pushbutton, the player will continue moving forward through the tape. Your tape must have at least three seconds of silence between each selection for next or seek to work. Press NEXT or the SEEK up arrow to stop searching. The tape direction arrow blinks and the sound will mute during next or seek operation.

3 PROG (Program): Press this pushbutton to play the other side of the tape.

4  (Dolby): Press this pushbutton to reduce background noise. The double-D symbol will appear on the display.

Dolby Noise Reduction is manufactured under a license from Dolby Laboratories Licensing Corporation. Dolby and the double-D symbol are trademarks of Dolby Laboratories Licensing Corporation.

5 REV (Reverse): Press this pushbutton to reverse the tape rapidly. Press it again to return to playing speed. The radio will play the last selected station while the tape reverses. You may select stations during reverse operation by using SEEK or TUNE.

6 FWD (Forward): Press this pushbutton to advance quickly to another part of the tape. Press the pushbutton again to return to playing speed. The radio will play the last selected station while the tape advances. You may select stations during forward operation by using SEEK or TUNE.

AM/FM: Press this button to listen to the radio when a tape is playing.

TAPE/PLAY: Press this button to change to playing a tape when listening to the radio. The tape symbol with an arrow will appear on the display when the tape is active.

 EJECT: Press this button to stop a tape when it is playing and to remove a tape when it is not playing. The eject button may be activated with either the ignition or radio off. Cassettes may be loaded with the radio and ignition off if this button is pressed first.

Cassette Tape Messages

E (Error): If this message and a number appears while trying to play a cassette tape, it could be one of the following:

- **E10:** The tape is tight and the player can't turn the tape hubs. Remove the tape. Hold the tape with the open end down and try to turn the right hub counterclockwise with a pencil. Turn the tape over and repeat. If the hubs do not turn easily, your tape may be damaged and should not be used in the player. Try a new tape to make sure your player is working properly.
- **E11:** The tape is broken. Try a new tape.
- **E14:** Wrapped tape. Try a new tape.

CLN (Clean): If this message appears on the display, the cassette tape player needs to be cleaned. It will still play tapes, but you should clean it as soon as possible to prevent damage to the tapes and player. See "Care of Your Cassette Tape Player" in the Index.

If any error occurs repeatedly or if an error can't be corrected, contact your dealer. If your radio displays an error number, write it down and provide it to your dealer when reporting the problem.

CD Adapter Kits

It is possible to use a portable CD player adapter kit with your cassette tape player after activating the bypass feature on your tape player.

To activate the bypass feature, use the following steps:

1. Turn the ignition to RUN or ACCESSORY.
2. Turn the radio off.
3. Press and hold TAPE/PLAY for three seconds. The tape symbol on the display will flash for two seconds, indicating the feature is active.
4. Insert the adapter into the cassette slot. It will power up the radio and begin playing.

This override routine will remain active until EJECT is pressed.

AM-FM Stereo with Compact Disc Player (Option)



Playing the Radio

POWER: Push this knob to turn the system on and off.

VOL (Volume): Turn the knob clockwise to increase volume. Turn it counterclockwise to decrease volume.

RECALL: Press this button to display the time with the ignition on or off. When the radio is playing, press this button to display the station frequency.

Finding a Station

AM/FM: Press this button to switch between AM, FM1 and FM2. The display shows your selection.

TUNE: Press this knob lightly so it extends. Turn it to choose radio stations. Press the knob back into its stored position when you're not using it.

▲ SEEK ▼: Press the up or down arrow to go to the next or previous station and stay there.

Setting Preset Stations

The six numbered pushbuttons let you return to your favorite stations. You can set up to 18 stations (six AM, six FM1 and six FM2) by performing the following steps:

1. Turn the radio on.
2. Press AM/FM to select the band.
3. Tune in the desired station.
4. Press and hold one of the six numbered pushbuttons until SET appears on the display. Whenever you press that numbered pushbutton, the station you set will return.
5. Repeat the steps for each pushbutton.

Setting the Tone (Bass/Treble)

BASS: Slide the lever to the right or left to increase or decrease bass.

TREBLE: Slide the lever to the right or left to increase or decrease treble. If a station is weak or noisy, you may want to decrease the treble.

Adjusting the Speakers (Balance/Fade)

BAL (Balance): Press this knob lightly so it extends. Turn it to move the sound to the left or right speakers. The middle position balances the sound between the speakers.

FADE: Press this knob lightly so it extends. Turn it to move the sound to the front or rear speakers. The middle position balances the sound between the speakers.

Press these knobs back into their stored positions when you're not using them.

Playing a Compact Disc

Insert a disc partway into the slot, label side up. The player will pull it in. The compact disc symbol will appear on the display. If the ignition and the radio are on, the disc will begin playing. CD will appear on the display next to the compact disc symbol. If you want to insert a disc when the ignition is off, first press the EJECT button.

The integral CD player can play the smaller 8 cm single discs with an adapter ring. Full-size compact discs and the smaller discs are loaded in the same manner.

If an error appears on the display, see “Compact Disc Messages” later in this section.

1 PREV (Previous): Press this pushbutton or the SEEK down arrow to go to the start of the current track if more than eight seconds have played. If you hold the pushbutton or press it more than once, the player will continue moving back through the disc.

2 NEXT: Press this pushbutton or the SEEK up arrow to go to the start of the next track. If you hold the pushbutton or press it more than once, the player will continue moving forward through the disc.

3 RDM (Random): Press this pushbutton to hear the tracks in random, rather than sequential, order. The display will show RDM. Press RDM again to turn off random play.

5 REV (Reverse): Press and hold this pushbutton to quickly reverse within a track. You will hear sound at a reduced volume. The display will show elapsed time.

6 FWD (Forward): Press and hold this pushbutton to quickly advance within a track. You will hear sound at a reduced volume. The display will show elapsed time.

RECALL: Press this button to see what track is currently playing. Press it again within five seconds to see how long the track has been playing. When a new track starts to play, the track number will also appear. Press it a third time and the time of day will be displayed.

AM/FM: Press this button to listen to the radio when a CD is playing. The CD will stop but remain in the player.

CD/PLAY: Press this button to play a CD when listening to the radio.

▲ EJECT: Press this button to stop a CD when it is playing or to remove a CD when it is not playing. The EJECT button will work with the radio off.

Compact Disc Messages

E (Error): If this message and a number appears on the radio display or if the disc comes out, it could be for one of the following reasons:

- You're driving on a very rough road.
- It's very hot.
- The disc is upside down.
- It is dirty, scratched or wet.
- The air is very humid. (If so, wait about an hour and try again.)
- If the CD is not playing correctly, for any other reason, try a known good CD.

If any error occurs repeatedly or if an error can't be corrected, contact your dealer. If your radio displays an error number, write it down and provide it to your dealer when reporting the problem.

AM-FM Stereo with Compact Disc Player and Equalizer (If Equipped)



Playing the Radio

POWER: Push this knob to turn the system on and off.

VOL (Volume): Turn the knob clockwise to increase volume. Turn it counterclockwise to decrease volume.

RECALL: Press this button to display the station being played or to display the clock. Pressing this button with the ignition off will display the clock.

Finding a Station

AM/FM: Press this button to switch between AM, FM1 and FM2. The display shows your selection.

TUNE: Press this knob lightly so it extends. Turn it to choose radio stations. Press the knob back into its stored position when you're not using it.

▲ SEEK ▼: Press the up or down arrow to go to the next or previous station and stay there.

Setting Preset Stations

The six numbered pushbuttons let you return to your favorite stations. You can set up to 18 stations (six AM, six FM1 and six FM2) by performing the following steps:

1. Turn the radio on.
2. Press AM/FM to select the band.
3. Tune in the desired station.
4. Press and hold one of the six numbered pushbuttons until SET appears on the display. Whenever you press that numbered pushbutton, the station you set will return.
5. Repeat the steps for each pushbutton.

Setting the Tone (Bass/Treble)

Equalizer: A seven-band equalizer is part of your audio system. Slide the levers up to boost or down to reduce frequency range.

Adjusting the Speakers (Balance/Fade)

BAL (Balance): Press this knob lightly so it extends. Turn it to move the sound to the left or right speakers. The middle position balances the sound between the speakers.

FADE: Press this knob lightly so it extends. Turn it to move the sound to the front or rear speakers. The middle position balances the sound between the speakers.

Press these knobs back into their stored positions when you're not using them.

Playing a Compact Disc

Insert a disc partway into the slot, label side up. The player will pull it in. The compact disc symbol will appear on the display. If the ignition and the radio are on, the disc will begin playing. CD will appear on the display next to the compact disc symbol. If you want to insert a disc when the ignition is off, first press the EJECT button.

The integral CD player can play the smaller 8 cm single discs. Full-size compact discs and the smaller discs are loaded in the same manner.

If an error appears on the display, see "Compact Disc Messages" later in this section.

1 PREV (Previous): Press this pushbutton or the SEEK down arrow to go to the start of the current track if more than eight seconds have played. If you hold the pushbutton or press it more than once, the player will continue moving back through the disc.

2 NEXT: Press this pushbutton or the SEEK up arrow to go to the start of the next track. If you hold the pushbutton or press it more than once, the player will continue moving forward through the disc.

3 RDM (Random): Press this pushbutton to hear the tracks in random, rather than sequential, order. The display will show RDM. Press RDM again to turn off random play.

5 REV (Reverse): Press and hold this pushbutton to quickly reverse within a track. You will hear sound at a reduced volume. The display will show elapsed time.

6 FWD (Forward): Press and hold this pushbutton to quickly advance forward within a track. You will hear sound at a reduced volume. The display will show elapsed time.

RECALL: Press this button to see what track is currently playing. Press it again within five seconds to see how long the track has been playing. When a new track starts to play, the track number will also appear. Press it a third time and the time of day will be displayed.

AM/FM: Press this button to listen to the radio when a disc is playing. The disc will stop but remain in the player.

CD/PLAY: Press this button to play a CD when listening to the radio.

▲ EJECT: Press this button to stop a CD when it is playing or to remove a CD when it is not playing. The EJECT button will work with the radio off.

Compact Disc Messages

E (Error): If this message and a number appears on the radio display or if the disc comes out, it could be for one of the following reasons:

- You're driving on a very rough road.
- It's very hot.
- The disc is upside down.

- It is dirty, scratched or wet.
- The air is very humid. (If so, wait about an hour and try again.)
- If the CD is not playing correctly, for any other reason, try a known good CD.

If any error occurs repeatedly or if an error can't be corrected, contact your dealer. If your radio displays an error number, write it down and provide it to your dealer when reporting the problem.

Theft-Deterrent Feature

THEFTLOCK[®] is designed to discourage theft of your radio. It works by using a secret code to disable all radio functions whenever battery power is removed.

The THEFTLOCK feature for the radio may be used or ignored. If ignored, the system plays normally and the radio is not protected by the feature. If THEFTLOCK is activated, your radio will not operate if stolen.

When THEFTLOCK is activated, the radio will display LOC to indicate a locked condition anytime battery power is removed. If your battery loses power for any reason, you must unlock the radio with the secret code before it will operate.

Activating the Theft-Deterrent Feature

The instructions which follow explain how to enter your secret code to activate the THEFTLOCK system. It is recommended that you read through all nine steps before starting the procedure.

If you allow more than 15 seconds to elapse between any steps, the radio automatically reverts to time and you must start the procedure over at Step 4.

1. Write down any three or four-digit number from 000 to 1999 and keep it in a safe place separate from the vehicle.
2. Turn the ignition to ACCESSORY or RUN.
3. Turn the radio off.
4. Press the 1 and 4 pushbuttons at the same time. Hold them down until --- shows on the display. Next you will use the secret code number which you have written down.
5. Press MIN and 000 will appear on the display.
6. Press MIN again to make the last two digits agree with your code.
7. Press HR to make the first one or two digits agree with your code.

8. Press AM/FM after you have confirmed that the code matches the secret code you have written down. The display will show REP to let you know that you need to repeat Steps 5 through 7 to confirm your secret code.
9. Press AM/FM and this time the display will show SEC to let you know that your radio is secure.

With the ignition off, the THEFTLOCK LED indicator will flash, indicating a secured radio.

Unlocking the Theft-Deterrent Feature After a Power Loss

Enter your secret code as follows; pause no more than 15 seconds between steps:

1. Turn the ignition on. LOC will appear on the display.
2. Press MIN and 000 will appear on the display.
3. Press MIN again to make the last two digits agree with your code.
4. Press HR to make the first one or two digits agree with your code.
5. Press AM/FM after you have confirmed that the code matches the secret code you have written down. The display will show SEC, indicating the radio is now operable and secure.

If you enter the wrong code eight times, INOP will appear on the display. You will have to wait an hour with the ignition on before you can try again. When you try again, you will only have three more chances (eight tries per chance) to enter the correct code before INOP appears.

If you lose or forget your code, contact your dealer.

Disabling the Theft-Deterrent Feature

Enter your secret code as follows; pause no more than 15 seconds between steps:

1. Turn the ignition to ACCESSORY or RUN.
2. Turn the radio off.
3. Press the 1 and 4 pushbuttons at the same time. Hold them down until SEC shows on the display.
4. Press MIN and 000 will appear on the display.

5. Press MIN again to make the last two digits agree with your code.
6. Press HR to make the first one or two digits agree with your code.
7. Press AM/FM after you have confirmed that the code matches the secret code you have written down. The display will show ---, indicating that the radio is no longer secured.

If the code entered is incorrect, SEC will appear on the display. The radio will remain secured until the correct code is entered.

When battery power is removed and later applied to a secured radio, the radio won't turn on and LOC will appear on the display.

To unlock a secured radio, see "Unlocking the Theft-Deterrent Feature After a Power Loss" earlier in this section.

Audio Steering Wheel Controls (If Equipped)

If your vehicle has this feature, you can control certain radio functions using the buttons on your steering wheel.



PRESET: Press this button to hear the radio stations that are set on your pushbuttons. The radio will go to a preset station, play for a few seconds, then go to the next station. Press this button again to stop scanning the preset stations. When a cassette tape is playing, press this button to change tape sides.

AM FM: Press this button to select AM, FM1 or FM2. The band you select will be displayed. The frequency will also be displayed and, if the station is in stereo, the stereo indicator will also be displayed. If a cassette tape or compact disc is playing, it will stop and the radio will play.

▲ SEEK ▼: Press the up or down arrow to go to the next or previous radio station and stay there.

If a cassette tape is playing, press the up arrow to search for the next selection on the tape. Press the down arrow to search for the previous selection on the tape. Your tape must have at least three seconds of silence between each selection for SEEK to work. If a compact disc is playing, press the up arrow to go to the start of the next track. Press the down arrow to go to the start of the current track if more than eight seconds have played. If less than eight seconds have played, press the down arrow to go to the previous track.

▲ VOL (Volume) ▼: Press the up or down arrow to increase or decrease volume.

PLAY: Press this button to play a cassette tape or compact disc when listening to the radio.

MUTE: Press this button to silence the system. Press it again, or any other radio button, to turn on the sound.

Understanding Radio Reception

AM

The range for most AM stations is greater than for FM, especially at night. The longer range, however, can cause stations to interfere with each other. AM can pick up noise from things like storms and power lines. Try reducing the treble to reduce this noise if you ever get it.

FM Stereo

FM stereo will give you the best sound, but FM signals will reach only about 10 to 40 miles (16 to 65 km). Tall buildings or hills can interfere with FM signals, causing the sound to come and go.

Tips About Your Audio System

Hearing damage from loud noise is almost undetectable until it is too late. Your hearing can adapt to higher volumes of sound. Sound that seems normal can be loud and harmful to your hearing. Take precautions by adjusting the volume control on your radio to a safe sound level before your hearing adapts to it.

To help avoid hearing loss or damage do the following:

- Adjust the volume control to the lowest setting.
- Increase volume slowly until you hear comfortably and clearly.

NOTICE:

Before you add any sound equipment to your vehicle -- like a tape player, CB radio, mobile telephone or two-way radio -- be sure you can add what you want. If you can, it's very important to do it properly. Added sound equipment may interfere with the operation of your vehicle's engine, Delphi Electronics radio or other systems, and even damage them. Your vehicle's systems may interfere with the operation of sound equipment that has been added improperly.

So, before adding sound equipment, check with your dealer and be sure to check federal rules covering mobile radio and telephone units.

Care of Your Cassette Tape Player

A tape player that is not cleaned regularly can cause reduced sound quality, ruined cassettes or a damaged mechanism. Cassette tapes should be stored in their cases away from contaminants, direct sunlight and extreme heat. If they aren't, they may not operate properly or may cause failure of the tape player.

Your tape player should be cleaned regularly after every 50 hours of use. Your radio may display CLN to indicate that you have used your tape player for 50 hours without resetting the tape clean timer. If this message appears on the display, your cassette tape player needs to be cleaned. It will still play tapes, but you should clean it as soon as possible to prevent damage to your tapes and player. If you notice a reduction in sound quality, try a known good cassette to see if it is the tape or the tape player at fault. If this other cassette has no improvement in sound quality, clean the tape player.

The recommended cleaning method for your cassette tape player is the use of a scrubbing action, non-abrasive cleaning cassette with pads which scrub the tape head as the hubs of the cleaner cassette turn. The recommended cleaning cassette is available through your dealer (GM Part No. 12344789).

When cleaning the cassette tape player with the recommended non-abrasive cleaning cassette, it is possible that the cassette may eject because the cut tape detection feature on your radio may recognize it as a broken tape. To prevent the cleaning cassette from being ejected, use the following steps:

1. Turn the ignition to RUN or ACCESSORY.
2. Turn the radio off.
3. Press and hold the TAPE/PLAY button for five seconds. The tape symbol on the display will flash for two seconds.
4. Insert the scrubbing action cleaning cassette.
5. Eject the cleaning cassette after the manufacturer's recommended cleaning time.

When the cleaning cassette has been ejected, the cut tape detection feature is active again.

You may also choose a non-scrubbing action, wet-type cleaner which uses a cassette with a fabric belt to clean the tape head. This type of cleaning cassette will not eject on its own. A non-scrubbing action cleaner may not clean as thoroughly as the scrubbing type cleaner. The use of a non-scrubbing action, dry-type cleaning cassette is not recommended.

After you clean the player, press and hold EJECT for five seconds to reset the CLN indicator. The radio will display --- to show the indicator was reset.

Cassettes are subject to wear and the sound quality may degrade over time. Always make sure the cassette tape is in good condition before you have your tape player serviced.

Care of Your Compact Discs

Handle discs carefully. Store them in their original cases or other protective cases and away from direct sunlight and dust. If the surface of a disc is soiled, dampen a clean, soft cloth in a mild, neutral detergent solution and clean it, wiping from the center to the edge.

Be sure never to touch the side without writing when handling discs. Pick up discs by grasping the outer edges or the edge of the hole and the outer edge.

Care of Your Compact Disc Player

The use of CD lens cleaner discs is not advised, due to the risk of contaminating the lens of the CD optics with lubricants internal to the CD mechanism.

Backglass Antenna

Your AM-FM antenna is integrated with your rear window defogger, located in the rear window.

Be sure that the inside surface of the rear window is not scratched and that the lines on the glass are not damaged. If the inside surface is damaged, it could interfere with radio reception.

NOTICE:

Do not try to clear frost or other material from the inside of the rear window with a razor blade or anything else that is sharp. This may damage the rear defogger grid and affect your radio's ability to pick up stations clearly. The repairs wouldn't be covered by your warranty.

Because this antenna is built into your rear window, there is a reduced risk of damage caused by car washes and vandals.

If you choose to add a cellular telephone to your vehicle, and the antenna needs to be attached to the glass, be sure that you do not damage the grid lines for the AM-FM antenna. There is enough space between the lines to attach a cellular telephone antenna without interfering with radio reception.



Section 4 Your Driving and the Road

Here you'll find information about driving on different kinds of roads and in varying weather conditions. We've also included many other useful tips on driving.

4-2	Defensive Driving	4-18	Driving at Night
4-3	Drunken Driving	4-20	Driving in Rain and on Wet Roads
4-6	Control of a Vehicle	4-24	City Driving
4-6	Braking	4-25	Freeway Driving
4-9	Traction Control System (With 3800 Supercharged V6 Engine)	4-26	Before Leaving on a Long Trip
4-11	Enhanced Traction System (ETS) (3100 V6 or 3800 V6 Engine)	4-27	Highway Hypnosis
4-12	Steering	4-28	Hill and Mountain Roads
4-15	Off-Road Recovery	4-29	Winter Driving
4-15	Passing	4-34	Recreational Vehicle Towing
4-17	Loss of Control	4-35	Loading Your Vehicle
		4-37	Towing a Trailer



Defensive Driving

The best advice anyone can give about driving is:
Drive defensively.

Please start with a very important safety device in your vehicle: Buckle up. See “Safety Belts” in the Index.

Defensive driving really means “be ready for anything.” On city streets, rural roads or freeways, it means “always expect the unexpected.”

Assume that pedestrians or other drivers are going to be careless and make mistakes. Anticipate what they might do. Be ready for their mistakes.

Rear-end collisions are about the most preventable of accidents. Yet they are common. Allow enough following distance. It’s the best defensive driving maneuver, in both city and rural driving. You never know when the vehicle in front of you is going to brake or turn suddenly.

Defensive driving requires that a driver concentrate on the driving task. Anything that distracts from the driving task -- such as concentrating on a cellular telephone call, reading, or reaching for something on the floor -- makes proper defensive driving more difficult and can even cause a collision, with resulting injury. Ask a passenger to help do things like this, or pull off the road in a safe place to do them yourself. These simple defensive driving techniques could save your life.

Drunken Driving

Death and injury associated with drinking and driving is a national tragedy. It's the number one contributor to the highway death toll, claiming thousands of victims every year.

Alcohol affects four things that anyone needs to drive a vehicle:

- Judgment
- Muscular Coordination
- Vision
- Attentiveness.

Police records show that almost half of all motor vehicle-related deaths involve alcohol. In most cases, these deaths are the result of someone who was drinking and driving. In recent years, about 16,000 annual motor vehicle-related deaths have been associated with the use of alcohol, with more than 300,000 people injured.

Many adults -- by some estimates, nearly half the adult population -- choose never to drink alcohol, so they never drive after drinking. For persons under 21, it's against the law in every U.S. state to drink alcohol. There are good medical, psychological and developmental reasons for these laws.

The obvious way to solve the leading highway safety problem is for people never to drink alcohol and then drive. But what if people do? How much is "too much" if the driver plans to drive? It's a lot less than many might think. Although it depends on each person and situation, here is some general information on the problem.

The Blood Alcohol Concentration (BAC) of someone who is drinking depends upon four things:

- The amount of alcohol consumed
- The drinker's body weight
- The amount of food that is consumed before and during drinking
- The length of time it has taken the drinker to consume the alcohol.

According to the American Medical Association, a 180-lb. (82 kg) person who drinks three 12-ounce (355 ml) bottles of beer in an hour will end up with a BAC of about 0.06 percent. The person would reach the same BAC by drinking three 4-ounce (120 ml) glasses of wine or three mixed drinks if each had 1-1/2 ounces (45 ml) of a liquor like whiskey, gin or vodka.



It's the amount of alcohol that counts. For example, if the same person drank three double martinis (3 ounces or 90 ml of liquor each) within an hour, the person's BAC would be close to 0.12 percent. A person who consumes food just before or during drinking will have a somewhat lower BAC level.

There is a gender difference, too. Women generally have a lower relative percentage of body water than men.

Since alcohol is carried in body water, this means that a woman generally will reach a higher BAC level than a man of her same body weight when each has the same number of drinks.

The law in an increasing number of U.S. states, and throughout Canada, sets the legal limit at 0.08 percent. In some other countries, the limit is even lower. For example, it is 0.05 percent in both France and Germany. The BAC limit for all commercial drivers in the United States is 0.04 percent.

The BAC will be over 0.10 percent after three to six drinks (in one hour). Of course, as we've seen, it depends on how much alcohol is in the drinks, and how quickly the person drinks them.

But the ability to drive is affected well below a BAC of 0.10 percent. Research shows that the driving skills of many people are impaired at a BAC approaching 0.05 percent, and that the effects are worse at night. All drivers are impaired at BAC levels above 0.05 percent. Statistics show that the chance of being in a collision increases sharply for drivers who have a BAC of 0.05 percent or above. A driver with a BAC level of 0.06 percent has doubled his or her chance of having a collision. At a BAC level of 0.10 percent, the chance of this driver having a collision is 12 times greater; at a level of 0.15 percent, the chance is 25 times greater!

The body takes about an hour to rid itself of the alcohol in one drink. No amount of coffee or number of cold showers will speed that up. "I'll be careful" isn't the right answer. What if there's an emergency, a need to take sudden action, as when a child darts into the street? A person with even a moderate BAC might not be able to react quickly enough to avoid the collision.

There's something else about drinking and driving that many people don't know. Medical research shows that alcohol in a person's system can make crash injuries worse, especially injuries to the brain, spinal cord or heart. This means that when anyone who has been drinking -- driver or passenger -- is in a crash, that person's chance of being killed or permanently disabled is higher than if the person had not been drinking.

**CAUTION:**

Drinking and then driving is very dangerous. Your reflexes, perceptions, attentiveness and judgment can be affected by even a small amount of alcohol. You can have a serious -- or even fatal -- collision if you drive after drinking. Please don't drink and drive or ride with a driver who has been drinking. Ride home in a cab; or if you're with a group, designate a driver who will not drink.

Control of a Vehicle

You have three systems that make your vehicle go where you want it to go. They are the brakes, the steering and the accelerator. All three systems have to do their work at the places where the tires meet the road.

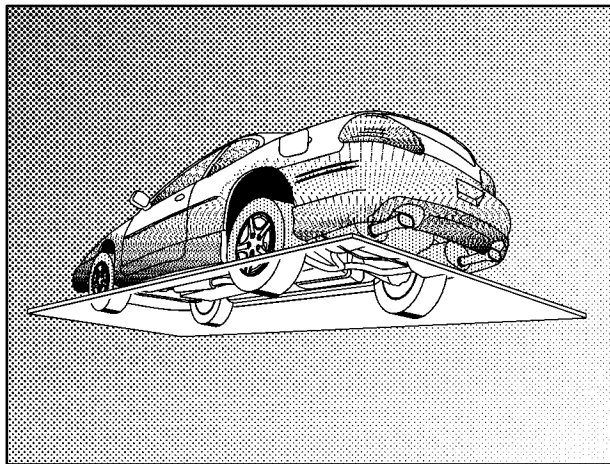

Sometimes, as when you're driving on snow or ice, it's easy to ask more of those control systems than the tires and road can provide. That means you can lose control of your vehicle. Also see "Traction Control System" and "Enhanced Traction System" in the Index.

Braking

Braking action involves *perception time* and *reaction time*.

First, you have to decide to push on the brake pedal. That's *perception time*. Then you have to bring up your foot and do it. That's *reaction time*.

Average *reaction time* is about 3/4 of a second. But that's only an average. It might be less with one driver and as long as two or three seconds or more with another. Age, physical condition, alertness, coordination and eyesight all play a part. So do alcohol, drugs and frustration. But even in 3/4 of a second, a vehicle moving at 60 mph (100 km/h) travels 66 feet (20 m). That could be a lot of distance in an emergency, so keeping enough space between your vehicle and others is important.

And, of course, actual stopping distances vary greatly with the surface of the road (whether it's pavement or gravel); the condition of the road (wet, dry, icy); tire tread; the condition of your brakes; the weight of the vehicle and the amount of brake force applied.

Avoid needless heavy braking. Some people drive in spurts -- heavy acceleration followed by heavy braking -- rather than keeping pace with traffic. This is a mistake. Your brakes may not have time to cool between hard stops. Your brakes will wear out much faster if you do a lot of heavy braking. If you keep pace with the traffic and allow realistic following distances, you will eliminate a lot of unnecessary braking. That means better braking and longer brake life.

If your engine ever stops while you're driving, brake normally but don't pump your brakes. If you do, the pedal may get harder to push down. If your engine stops, you will still have some power brake assist. But you will use it when you brake. Once the power assist is used up, it may take longer to stop and the brake pedal will be harder to push.

Anti-Lock Brake System (ABS)

Your vehicle has anti-lock brakes. ABS is an advanced electronic braking system that will help prevent a braking skid.

When you start your engine, or when you begin to drive away, your anti-lock brake system will check itself. You may hear a momentary motor or clicking noise while this test is going on, and you may even notice that your brake pedal moves or pulses a little. This is normal.

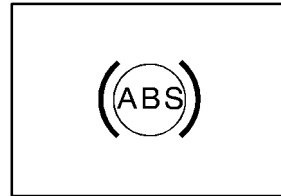

If there's a problem with the anti-lock brake system, this warning light will stay on. See "Anti-Lock Brake System Warning Light" in the Index.



Let's say the road is wet and you're driving safely. Suddenly, an animal jumps out in front of you. You slam on the brakes and continue braking. Here's what happens with ABS:

A computer senses that wheels are slowing down. If one of the wheels is about to stop rolling, the computer will separately work the brakes at each front wheel and at both rear wheels.

The anti-lock system can change the brake pressure faster than any driver could. The computer is programmed to make the most of available tire and road conditions. This can help you steer around the obstacle while braking hard.



As you brake, your computer keeps receiving updates on wheel speed and controls braking pressure accordingly.

Remember: Anti-lock doesn't change the time you need to get your foot up to the brake pedal or always decrease stopping distance. If you get too close to the vehicle in front of you, you won't have time to apply your brakes if that vehicle suddenly slows or stops. Always leave enough room up ahead to stop, even though you have anti-lock brakes.

Using Anti-Lock

Don't pump the brakes. Just hold the brake pedal down firmly and let anti-lock work for you. You may feel a slight brake pedal pulsation or notice some noise, but this is normal.

Braking in Emergencies

With anti-lock, you can steer and brake at the same time. In many emergencies, steering can help you more than even the very best braking.

Traction Control System (With 3800 Supercharged V6 Engine)

Your vehicle has a traction control system that limits wheel spin. This is especially useful in slippery road conditions. The system operates only if it senses that one or both of the front wheels are spinning or beginning to lose traction. When this happens, the system works the front brakes and reduces engine power to limit wheel spin.

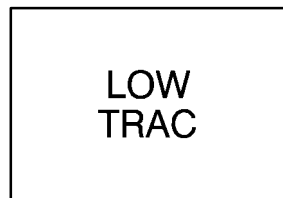

This light will come on when your traction control system is limiting wheel spin. See “Traction Control Warning Light” in the Index.

You may feel or hear the system working, but this is normal.

If your vehicle is in cruise control when the traction control system begins to limit wheel spin, the cruise control will automatically disengage. When road conditions allow you to safely use it again, you may reengage the cruise control. See “Cruise Control” in the Index.

A rectangular box containing the text "TCS OFF" in a bold, sans-serif font.

TCS
OFF

This light should come on briefly when you start the engine. If it stays on or comes on while you are driving, there is a problem with your traction control system.

See “Traction Control System Warning Light” in the Index. When this warning light is on, the system will not limit wheel spin. Adjust your driving accordingly.

The traction control system automatically comes on whenever you start your vehicle. To limit wheel spin, especially in slippery road conditions, you should always leave the system on. But you can turn the traction control system off if you ever need to. You should turn the system off if your vehicle ever gets stuck in sand, mud or snow and rocking the vehicle is required. See “Rocking Your Vehicle” in the Index.

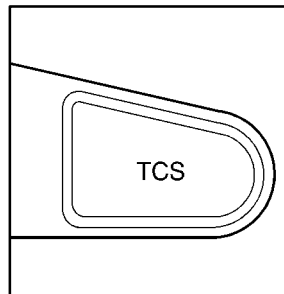

To turn the system off, press the button.

The traction control system warning light will come on and stay on. If the system is limiting wheel spin when you press the button, the warning light will come on and the system will turn off instantly.

You can turn the system back on at any time by pressing the button again. The traction control system warning light should go off.

Enhanced Traction System (ETS) (3100 V6 or 3800 V6 Engine)

Your vehicle may have an Enhanced Traction System (ETS) that limits wheel spin. This is especially useful in slippery road conditions. The system operates only if it senses that one or both of the front wheels are spinning or beginning to lose traction. When this happens, the system reduces engine power and may also upshift the transaxle to limit wheel spin.



**LOW
TRAC**

This light will come on when your Enhanced Traction System is limiting wheel spin. See “Enhanced Traction System Warning Light” in the Index.

If your vehicle is in cruise control when the enhanced traction system begins to limit wheel spin, the cruise control will automatically disengage. When road conditions allow you to safely use it again, you may re-engage the cruise control. See “Cruise Control” in the Index.

The Enhanced Traction System operates in all transaxle shift lever positions. But the system can upshift the transaxle only as high as the shift lever position you’ve chosen, so you should use the lower gears only when necessary. See “Automatic Transaxle” in the Index.



**TRAC
OFF**

This TRAC OFF warning light will come on to let you know if there’s a problem.

See “Enhanced Traction System Warning Light” in the Index. When this warning light is on, the system will not limit wheel spin. Adjust your driving accordingly.

To limit wheel spin, especially in slippery road conditions, you should always leave the Enhanced Traction System on. But you can turn the system off if you ever need to. You should turn the system off if your vehicle ever gets stuck in sand, mud or snow and rocking the vehicle is required. See “Rocking Your Vehicle” in the Index.

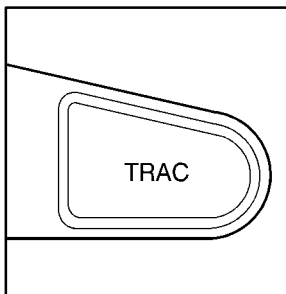

To turn the system on or off, press the TRAC button on the far right end of the Driver Information Center (DIC) or the trip computer (if equipped).

When you turn the system off, the Enhanced Traction System warning light will come on and stay on. If the Enhanced Traction System is limiting wheel spin when you press the button to turn the system off, the warning light will come on and the system will turn off right away.

You can turn the system back on at any time by pressing the button again. The Enhanced Traction System warning light should go off.

Steering

Power Steering

If you lose power steering assist because the engine stops or the system is not functioning, you can steer but it will take much more effort.

Variable Effort Steering (Option)

This steering system provides less steering effort for parking and when driving at speeds below 20 mph (32 km/h). Steering effort will increase at higher speeds for improved road feel.

Steering Tips

Driving on Curves

It's important to take curves at a reasonable speed.

A lot of the “driver lost control” accidents mentioned on the news happen on curves. Here's why:

Experienced driver or beginner, each of us is subject to the same laws of physics when driving on curves. The traction of the tires against the road surface makes it possible for the vehicle to change its path when you turn the front wheels. If there's no traction, inertia will keep the vehicle going in the same direction. If you've ever tried to steer a vehicle on wet ice, you'll understand this.

The traction you can get in a curve depends on the condition of your tires and the road surface, the angle at which the curve is banked, and your speed. While you're in a curve, speed is the one factor you can control.

Suppose you're steering through a sharp curve. Then you suddenly accelerate. Both control systems -- steering and acceleration -- have to do their work where the tires meet the road. Adding the sudden acceleration can demand too much of those places. You can lose control. Refer to “Traction Control System” or “Enhanced Traction System” in the Index.

What should you do if this ever happens? Ease up on the accelerator pedal, steer the vehicle the way you want it to go, and slow down.

Speed limit signs near curves warn that you should adjust your speed. Of course, the posted speeds are based on good weather and road conditions. Under less favorable conditions you'll want to go slower.

If you need to reduce your speed as you approach a curve, do it before you enter the curve, while your front wheels are straight ahead.

Try to adjust your speed so you can “drive” through the curve. Maintain a reasonable, steady speed. Wait to accelerate until you are out of the curve, and then accelerate gently into the straightaway.

Steering in Emergencies

There are times when steering can be more effective than braking. For example, you come over a hill and find a truck stopped in your lane, or a car suddenly pulls out from nowhere, or a child darts out from between parked cars and stops right in front of you. You can avoid these problems by braking -- if you can stop in time. But sometimes you can't; there isn't room. That's the time for evasive action -- steering around the problem.

Your vehicle can perform very well in emergencies like these. First apply your brakes. See "Braking in Emergencies" earlier in this section. It is better to remove as much speed as you can from a possible collision. Then steer around the problem, to the left or right depending on the space available.

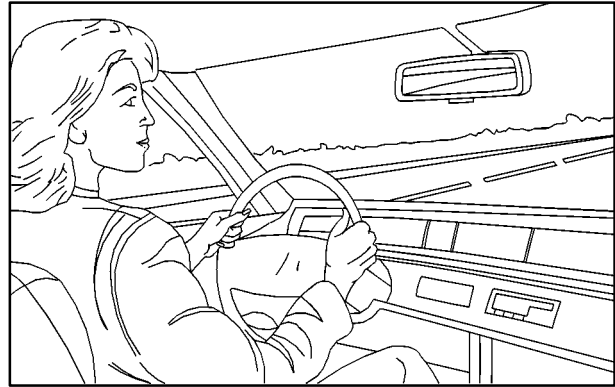

An emergency like this requires close attention and a quick decision. If you are holding the steering wheel at the recommended 9 and 3 o'clock positions, you can turn it a full 180 degrees very quickly without removing either hand. But you have to act fast, steer quickly, and just as quickly straighten the wheel once you have avoided the object.

The fact that such emergency situations are always possible is a good reason to practice defensive driving at all times and wear safety belts properly.

Off-Road Recovery

You may find that your right wheels have dropped off the edge of a road onto the shoulder while you're driving.

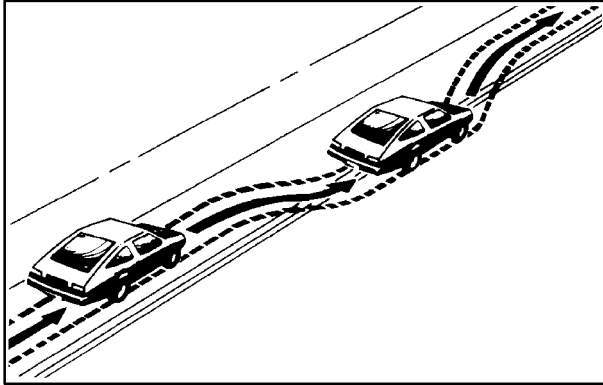

If the level of the shoulder is only slightly below the pavement, recovery should be fairly easy. Ease off the accelerator and then, if there is nothing in the way, steer so that your vehicle straddles the edge of the pavement. You can turn the steering wheel up to one-quarter turn until the right front tire contacts the pavement edge. Then turn your steering wheel to go straight down the roadway.

Passing

The driver of a vehicle about to pass another on a two-lane highway waits for just the right moment, accelerates, moves around the vehicle ahead, then goes back into the right lane again. A simple maneuver?

Not necessarily! Passing another vehicle on a two-lane highway is a potentially dangerous move, since the passing vehicle occupies the same lane as oncoming traffic for several seconds. A miscalculation, an error in judgment, or a brief surrender to frustration or anger can suddenly put the passing driver face to face with the worst of all traffic accidents -- the head-on collision.

So here are some tips for passing:

- “Drive ahead.” Look down the road, to the sides and to crossroads for situations that might affect your passing patterns. If you have any doubt whatsoever about making a successful pass, wait for a better time.
- Watch for traffic signs, pavement markings and lines. If you can see a sign up ahead that might indicate a turn or an intersection, delay your pass. A broken center line usually indicates it's all right to pass (providing the road ahead is clear). Never cross a solid line on your side of the lane or a double solid line, even if the road seems empty of approaching traffic.

- Do not get too close to the vehicle you want to pass while you're awaiting an opportunity. For one thing, following too closely reduces your area of vision, especially if you're following a larger vehicle. Also, you won't have adequate space if the vehicle ahead suddenly slows or stops. Keep back a reasonable distance.
- When it looks like a chance to pass is coming up, start to accelerate but stay in the right lane and don't get too close. Time your move so you will be increasing speed as the time comes to move into the other lane. If the way is clear to pass, you will have a "running start" that more than makes up for the distance you would lose by dropping back. And if something happens to cause you to cancel your pass, you need only slow down and drop back again and wait for another opportunity.
- If other cars are lined up to pass a slow vehicle, wait your turn. But take care that someone isn't trying to pass you as you pull out to pass the slow vehicle. Remember to glance over your shoulder and check the blind spot.
- Check your mirrors, glance over your shoulder, and start your left lane change signal before moving out of the right lane to pass. When you are far enough ahead of the passed vehicle to see its front in your inside mirror, activate your right lane change signal and move back into the right lane. (Remember that your right outside mirror is convex. The vehicle you just passed may seem to be farther away from you than it really is.)
- Try not to pass more than one vehicle at a time on two-lane roads. Reconsider before passing the next vehicle.
- Don't overtake a slowly moving vehicle too rapidly. Even though the brake lamps are not flashing, it may be slowing down or starting to turn.
- If you're being passed, make it easy for the following driver to get ahead of you. Perhaps you can ease a little to the right.

Loss of Control

Let's review what driving experts say about what happens when the three control systems (brakes, steering and acceleration) don't have enough friction where the tires meet the road to do what the driver has asked.

In any emergency, don't give up. Keep trying to steer and constantly seek an escape route or area of less danger.

Skidding

In a skid, a driver can lose control of the vehicle. Defensive drivers avoid most skids by taking reasonable care suited to existing conditions, and by not "overdriving" those conditions. But skids are always possible.

The three types of skids correspond to your vehicle's three control systems. In the braking skid, your wheels aren't rolling. In the steering or cornering skid, too much speed or steering in a curve causes tires to slip and lose cornering force. And in the acceleration skid, too much throttle causes the driving wheels to spin.

A cornering skid is best handled by easing your foot off the accelerator pedal.

If you do not have the Enhanced Traction System or the Traction Control System, or if the system is off, then an acceleration skid is also best handled by easing your foot off the accelerator pedal.

If your vehicle starts to slide, ease your foot off the accelerator pedal and quickly steer the way you want the vehicle to go. If you start steering quickly enough, your vehicle may straighten out. Always be ready for a second skid if it occurs.

Of course, traction is reduced when water, snow, ice, gravel or other material is on the road. For safety, you'll want to slow down and adjust your driving to these conditions. It is important to slow down on slippery surfaces because stopping distance will be longer and vehicle control more limited.

While driving on a surface with reduced traction, try your best to avoid sudden steering, acceleration or braking (including engine braking by shifting to a lower gear). Any sudden changes could cause the tires to slide. You may not realize the surface is slippery until your vehicle is skidding. Learn to recognize warning clues -- such as enough water, ice or packed snow on the road to make a "mirrored surface" -- and slow down when you have any doubt.

Remember: Any anti-lock brake system (ABS) helps avoid only the braking skid.

Driving at Night

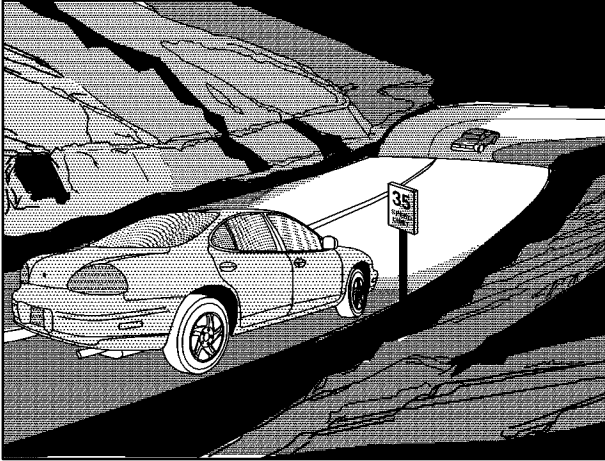

Night driving is more dangerous than day driving. One reason is that some drivers are likely to be impaired -- by alcohol or drugs, with night vision problems, or by fatigue.

Here are some tips on night driving.

- Drive defensively.
- Don't drink and drive.
- Adjust your inside rearview mirror to reduce the glare from headlamps behind you.
- Since you can't see as well, you may need to slow down and keep more space between you and other vehicles.
- Slow down, especially on higher speed roads. Your headlamps can light up only so much road ahead.
- In remote areas, watch for animals.
- If you're tired, pull off the road in a safe place and rest.

No one can see as well at night as in the daytime. But as we get older these differences increase. A 50-year-old driver may require at least twice as much light to see the same thing at night as a 20-year-old.

What you do in the daytime can also affect your night vision. For example, if you spend the day in bright sunshine you are wise to wear sunglasses. Your eyes will have less trouble adjusting to night. But if you're driving, don't wear sunglasses at night. They may cut down on glare from headlamps, but they also make a lot of things invisible.

You can be temporarily blinded by approaching headlamps. It can take a second or two, or even several seconds, for your eyes to readjust to the dark. When you are faced with severe glare (as from a driver who doesn't lower the high beams, or a vehicle with misaimed headlamps), slow down a little. Avoid staring directly into the approaching headlamps.

Keep your windshield and all the glass on your vehicle clean -- inside and out. Glare at night is made much worse by dirt on the glass. Even the inside of the glass can build up a film caused by dust. Dirty glass makes lights dazzle and flash more than clean glass would, making the pupils of your eyes contract repeatedly.

Remember that your headlamps light up far less of a roadway when you are in a turn or curve. Keep your eyes moving; that way, it's easier to pick out dimly lighted objects. Just as your headlamps should be checked regularly for proper aim, so should your eyes be examined regularly. Some drivers suffer from night blindness -- the inability to see in dim light -- and aren't even aware of it.

Driving in Rain and on Wet Roads

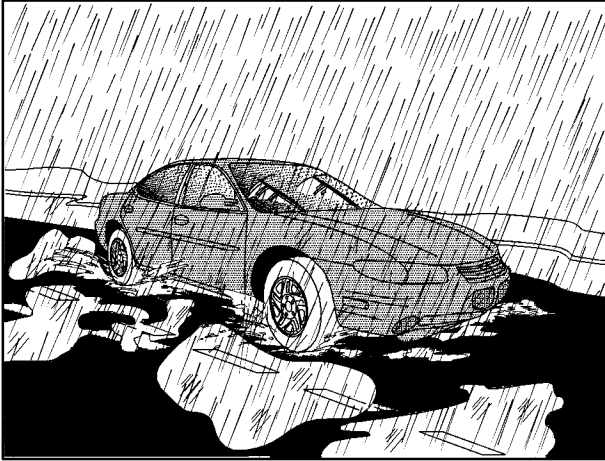

Rain and wet roads can mean driving trouble. On a wet road, you can't stop, accelerate or turn as well because your tire-to-road traction isn't as good as on dry roads. And, if your tires don't have much tread left, you'll get even less traction. It's always wise to go slower and be cautious if rain starts to fall while you are driving. The surface may get wet suddenly when your reflexes are tuned for driving on dry pavement.

The heavier the rain, the harder it is to see. Even if your windshield wiper blades are in good shape, a heavy rain can make it harder to see road signs and traffic signals, pavement markings, the edge of the road and even people walking.

It's wise to keep your windshield wiping equipment in good shape and keep your windshield washer tank filled with washer fluid. Replace your windshield wiper inserts when they show signs of streaking or missing areas on the windshield, or when strips of rubber start to separate from the inserts.

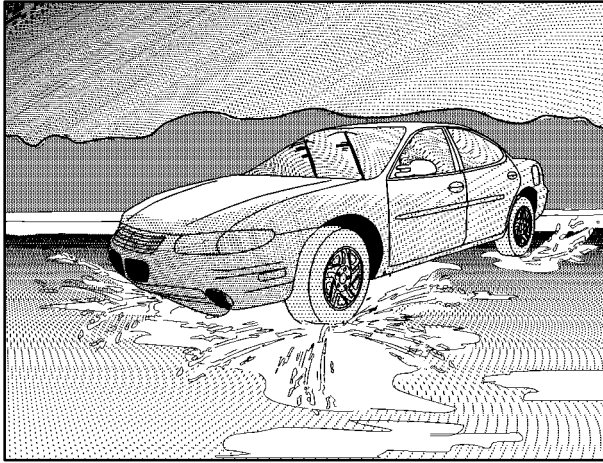

Driving too fast through large water puddles or even going through some car washes can cause problems, too. The water may affect your brakes. Try to avoid puddles. But if you can't, try to slow down before you hit them.

⚠ CAUTION:

Wet brakes can cause accidents. They won't work as well in a quick stop and may cause pulling to one side. You could lose control of the vehicle.

After driving through a large puddle of water or a car wash, apply your brake pedal lightly until your brakes work normally.

Hydroplaning

Hydroplaning is dangerous. So much water can build up under your tires that they can actually ride on the water. This can happen if the road is wet enough and you're going fast enough. When your vehicle is hydroplaning, it has little or no contact with the road.

Hydroplaning doesn't happen often. But it can if your tires do not have much tread or if the pressure in one or more is low. It can happen if a lot of water is standing on the road. If you can see reflections from trees, telephone poles or other vehicles, and raindrops "dimple" the water's surface, there could be hydroplaning.

Hydroplaning usually happens at higher speeds. There just isn't a hard and fast rule about hydroplaning. The best advice is to slow down when it is raining.

Driving Through Deep Standing Water

NOTICE:

If you drive too quickly through deep puddles or standing water, water can come in through your engine's air intake and badly damage your engine. Never drive through water that is slightly lower than the underbody of your vehicle. If you can't avoid deep puddles or standing water, drive through them very slowly.

Driving Through Flowing Water

CAUTION:

Flowing or rushing water creates strong forces. If you try to drive through flowing water, as you might at a low water crossing, your vehicle can be carried away. As little as six inches of flowing water can carry away a smaller vehicle. If this happens, you and other vehicle occupants could drown. Don't ignore police warning signs, and otherwise be very cautious about trying to drive through flowing water.

Some Other Rainy Weather Tips

- Besides slowing down, allow some extra following distance. And be especially careful when you pass another vehicle. Allow yourself more clear room ahead, and be prepared to have your view restricted by road spray.
- Have good tires with proper tread depth. See “Tires” in the Index.

City Driving



One of the biggest problems with city streets is the amount of traffic on them. You'll want to watch out for what the other drivers are doing and pay attention to traffic signals.

Here are ways to increase your safety in city driving:

- Know the best way to get to where you are going. Get a city map and plan your trip into an unknown part of the city just as you would for a cross-country trip.
- Try to use the freeways that rim and crisscross most large cities. You'll save time and energy. See the next part, "Freeway Driving."
- Treat a green light as a warning signal. A traffic light is there because the corner is busy enough to need it. When a light turns green, and just before you start to move, check both ways for vehicles that have not cleared the intersection or may be running the red light.

Freeway Driving



Mile for mile, freeways (also called thruways, parkways, expressways, turnpikes or superhighways) are the safest of all roads. But they have their own special rules.

The most important advice on freeway driving is: Keep up with traffic and keep to the right. Drive at the same speed most of the other drivers are driving. Too-fast or too-slow driving breaks a smooth traffic flow. Treat the left lane on a freeway as a passing lane.

At the entrance, there is usually a ramp that leads to the freeway. If you have a clear view of the freeway as you drive along the entrance ramp, you should begin to check traffic. Try to determine where you expect to blend with the flow. Try to merge into the gap at close to the prevailing speed. Switch on your turn signal, check your mirrors and glance over your shoulder as often as necessary. Try to blend smoothly with the traffic flow.

Once you are on the freeway, adjust your speed to the posted limit or to the prevailing rate if it's slower. Stay in the right lane unless you want to pass.

Before changing lanes, check your mirrors. Then use your turn signal.

Just before you leave the lane, glance quickly over your shoulder to make sure there isn't another vehicle in your "blind" spot.

Once you are moving on the freeway, make certain you allow a reasonable following distance. Expect to move slightly slower at night.

When you want to leave the freeway, move to the proper lane well in advance. If you miss your exit, do not, under any circumstances, stop and back up. Drive on to the next exit.

The exit ramp can be curved, sometimes quite sharply.

The exit speed is usually posted.

Reduce your speed according to your speedometer, not to your sense of motion. After driving for any distance at higher speeds, you may tend to think you are going slower than you actually are.

Before Leaving on a Long Trip

Make sure you're ready. Try to be well rested. If you must start when you're not fresh -- such as after a day's work -- don't plan to make too many miles that first part of the journey. Wear comfortable clothing and shoes you can easily drive in.

Is your vehicle ready for a long trip? If you keep it serviced and maintained, it's ready to go. If it needs service, have it done before starting out. Of course, you'll find experienced and able service experts in Pontiac dealerships all across North America. They'll be ready and willing to help if you need it.

Here are some things you can check before a trip:

- *Windshield Washer Fluid:* Is the reservoir full? Are all windows clean inside and outside?
- *Wiper Blades:* Are they in good shape?
- *Fuel, Engine Oil, Other Fluids:* Have you checked all levels?
- *Lamps:* Are they all working? Are the lenses clean?
- *Tires:* They are vitally important to a safe, trouble-free trip. Is the tread good enough for long-distance driving? Are the tires all inflated to the recommended pressure?
- *Weather Forecasts:* What's the weather outlook along your route? Should you delay your trip a short time to avoid a major storm system?
- *Maps:* Do you have up-to-date maps?

Highway Hypnosis

Is there actually such a condition as “highway hypnosis”? Or is it just plain falling asleep at the wheel? Call it highway hypnosis, lack of awareness, or whatever.

There is something about an easy stretch of road with the same scenery, along with the hum of the tires on the road, the drone of the engine, and the rush of the wind against the vehicle that can make you sleepy. Don't let it happen to you! If it does, your vehicle can leave the road in *less than a second*, and you could crash and be injured.

What can you do about highway hypnosis? First, be aware that it can happen.

Then here are some tips:

- Make sure your vehicle is well ventilated, with a comfortably cool interior.
- Keep your eyes moving. Scan the road ahead and to the sides. Check your rearview mirrors and your instruments frequently.
- If you get sleepy, pull off the road into a rest, service or parking area and take a nap, get some exercise, or both. For safety, treat drowsiness on the highway as an emergency.

Hill and Mountain Roads



Driving on steep hills or mountains is different from driving in flat or rolling terrain.

If you drive regularly in steep country, or if you're planning to visit there, here are some tips that can make your trips safer and more enjoyable.

- Keep your vehicle in good shape. Check all fluid levels and also the brakes, tires, cooling system and transaxle. These parts can work hard on mountain roads.
- Know how to go down hills. The most important thing to know is this: let your engine do some of the slowing down. Shift to a lower gear when you go down a steep or long hill.

CAUTION:

If you don't shift down, your brakes could get so hot that they wouldn't work well. You would then have poor braking or even none going down a hill. You could crash. Shift down to let your engine assist your brakes on a steep downhill slope.

CAUTION:

Coasting downhill in NEUTRAL (N) or with the ignition off is dangerous. Your brakes will have to do all the work of slowing down. They could get so hot that they wouldn't work well. You would then have poor braking or even none going down a hill. You could crash. Always have your engine running and your vehicle in gear when you go downhill.

- Know how to go uphill. You may want to shift down to a lower gear. The lower gears help cool your engine and transaxle, and you can climb the hill better.
- Stay in your own lane when driving on two-lane roads in hills or mountains. Don't swing wide or cut across the center of the road. Drive at speeds that let you stay in your own lane.
- As you go over the top of a hill, be alert. There could be something in your lane, like a stalled car or an accident.
- You may see highway signs on mountains that warn of special problems. Examples are long grades, passing or no-passing zones, a falling rocks area or winding roads. Be alert to these and take appropriate action.

Winter Driving



Here are some tips for winter driving:

- Have your vehicle in good shape for winter.
- You may want to put winter emergency supplies in your trunk.



Include an ice scraper, a small brush or broom, a supply of windshield washer fluid, a rag, some winter outer clothing, a small shovel, a flashlight, a red cloth and a couple of reflective warning triangles. And, if you will be driving under severe conditions, include a small bag of sand, a piece of old carpet or a couple of burlap bags to help provide traction. Be sure you properly secure these items in your vehicle.

Driving on Snow or Ice

Most of the time, those places where your tires meet the road probably have good traction.

However, if there is snow or ice between your tires and the road, you can have a very slippery situation. You'll have a lot less traction or "grip" and will need to be very careful.

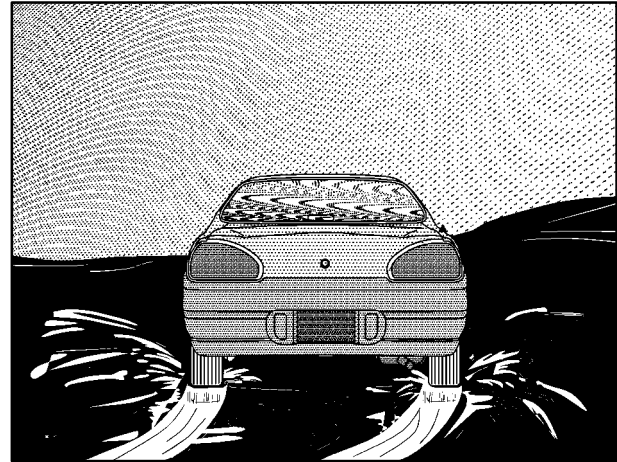

What's the worst time for this? "Wet ice." Very cold snow or ice can be slick and hard to drive on. But wet ice can be even more trouble because it may offer the least traction of all. You can get wet ice when it's about freezing (32°F; 0°C) and freezing rain begins to fall. Try to avoid driving on wet ice until salt and sand crews can get there.

Whatever the condition -- smooth ice, packed, blowing or loose snow -- drive with caution.

If you have traction control, keep the system on. It will improve your ability to accelerate when driving on a slippery road. Even though your vehicle has a traction control system, you'll want to slow down and adjust your driving to the road conditions. See "Traction Control System" in the Index.

If you don't have the traction control system, accelerate gently. Try not to break the fragile traction. If you accelerate too fast, the drive wheels will spin and polish the surface under the tires even more.

Your anti-lock brakes improve your vehicle's stability when you make a hard stop on a slippery road. Even though you have the anti-lock braking system, you'll want to begin stopping sooner than you would on dry pavement. See "Anti-Lock" in the Index.

- Allow greater following distance on any slippery road.
- Watch for slippery spots. The road might be fine until you hit a spot that's covered with ice. On an otherwise clear road, ice patches may appear in shaded areas where the sun can't reach: around clumps of trees, behind buildings or under bridges. Sometimes the surface of a curve or an overpass may remain icy when the surrounding roads are clear. If you see a patch of ice ahead of you, brake before you are on it. Try not to brake while you're actually on the ice, and avoid sudden steering maneuvers.

If You're Caught in a Blizzard

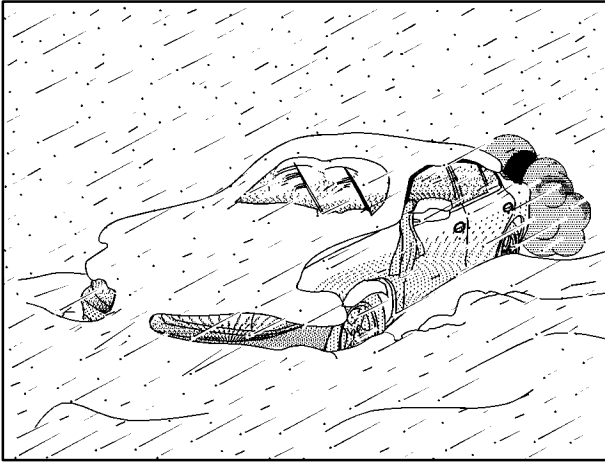

If you are stopped by heavy snow, you could be in a serious situation. You should probably stay with your vehicle unless you know for sure that you are near help and you can hike through the snow. Here are some things to do to summon help and keep yourself and your passengers safe:

- Turn on your hazard flashers.

- Tie a red cloth to your vehicle to alert police that you've been stopped by the snow.
- Put on extra clothing or wrap a blanket around you. If you have no blankets or extra clothing, make body insulators from newspapers, burlap bags, rags, floor mats -- anything you can wrap around yourself or tuck under your clothing to keep warm.

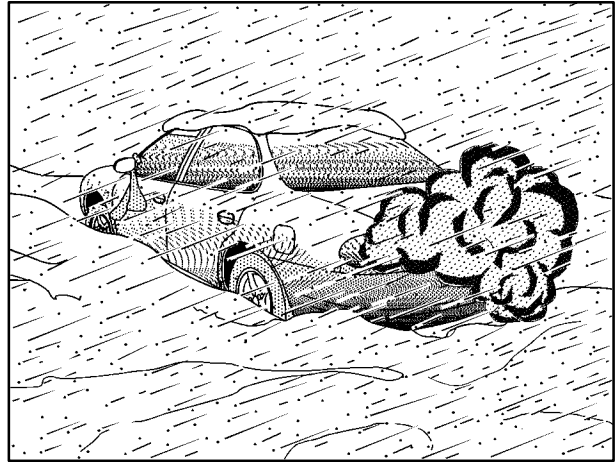

You can run the engine to keep warm, but be careful.



CAUTION:

Snow can trap exhaust gases under your vehicle. This can cause deadly CO (carbon monoxide) gas to get inside. CO could overcome you and kill you. You can't see it or smell it, so you might not know it is in your vehicle. Clear away snow from around the base of your vehicle, especially any that is blocking your exhaust pipe. And check around again from time to time to be sure snow doesn't collect there.

Open a window just a little on the side of the vehicle that's away from the wind. This will help keep CO out.

Run your engine only as long as you must. This saves fuel. When you run the engine, make it go a little faster than just idle. That is, push the accelerator slightly. This uses less fuel for the heat that you get and it keeps the battery charged. You will need a well-charged battery to restart the vehicle, and possibly for signaling later on with your headlamps. Let the heater run for a while.

Then, shut the engine off and close the window almost all the way to preserve the heat. Start the engine again and repeat this only when you feel really uncomfortable from the cold. But do it as little as possible. Preserve the fuel as long as you can. To help keep warm, you can get out of the vehicle and do some fairly vigorous exercises every half hour or so until help comes.

Recreational Vehicle Towing

Recreational vehicle towing means towing your vehicle behind another vehicle -- such as behind a motorhome. The two most common types of recreational vehicle towing are known as “dinghy towing” (towing your vehicle with all four wheels on the ground) and “dolly towing” (towing your vehicle with two wheels on the ground and two wheels up on a device known as a “dolly”).

With the proper preparation and equipment, many vehicles can be towed in these ways. See “Dinghy Towing” and “Dolly Towing,” following.

Here are some important things to consider before you do recreational vehicle towing:

- What’s the towing capacity of the towing vehicle? Be sure you read the tow vehicle manufacturer’s recommendations.
- How far will you tow? Some vehicles have restrictions on how far and how long they can tow.

- Do you have the proper towing equipment? See your dealer or trailering professional for additional advice and equipment recommendations.
- Is your vehicle ready to be towed? Just as you would prepare your vehicle for a long trip, you’ll want to make sure your vehicle is prepared to be towed. See “Before Leaving on a Long Trip” in the Index.

Dinghy Towing

NOTICE:

Towing your vehicle with all four wheels on the ground will damage drivetrain components.

Your vehicle was not designed to be towed with all four wheels on the ground. If your vehicle must be towed, you should use a dolly. See “Dolly Towing” later in this section for more information.

Dolly Towing

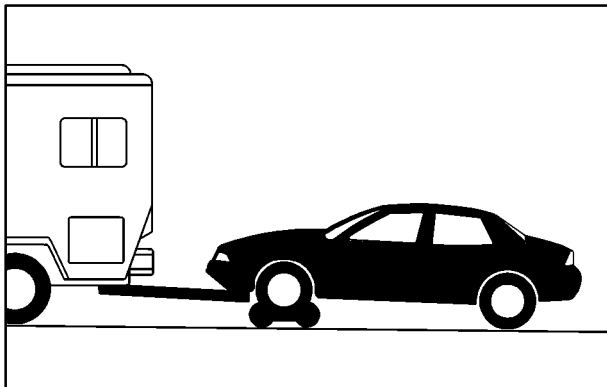

Your vehicle can be towed using a dolly. To tow your vehicle using a dolly, follow these steps:

1. Put the front wheels on the dolly.
2. Put the vehicle in PARK (P).
3. Set the parking brake and then remove the key.
4. Clamp the steering wheel in a straight-ahead position.
5. Release the parking brake.

Loading Your Vehicle

GM TIRE-LOADING INFORMATION

OCCUPANTS				VEHICLE CAP. WT.	
FRT.	CTR.	RR.	TOTAL	KG	LB
<input type="checkbox"/>	<input type="checkbox"/>	<input type="checkbox"/>	<input type="checkbox"/>	<input type="checkbox"/>	<input type="checkbox"/>
MAX. LOADING @ GVWR SAME AS VEHICLE CAP. WT.					
200 <input type="checkbox"/>					
MODEL: <input type="text"/>					
TIRE SIZE <input type="text"/> SPEED <input type="text"/> COLD TIRE PRESSURE					
FRT	<input type="text"/>	<input type="text"/>	<input type="text"/>	<input type="text"/>	<input type="text"/>
RR	<input type="text"/>	<input type="text"/>	<input type="text"/>	<input type="text"/>	<input type="text"/>
PA	<input type="text"/>	<input type="text"/>	<input type="text"/>	<input type="text"/>	<input type="text"/>
TIRES ARE HOT, ADD 28KPA(4PSI)					
SEE OWNER'S MANUAL FOR MORE INFORMATION					

EXAMPLE

Two labels on your vehicle show how much weight it may properly carry. The Tire-Loading Information label is inside the trunk lid. The label tells you the proper size, speed rating and recommended inflation pressures for the tires on your vehicle. It also gives you important information about the number of people that can be in your vehicle and the total weight you can carry. This includes the weight of all occupants, cargo and all nonfactory-installed options.

 MFD BY GENERAL MOTORS CORP
 DATE GVWR GAWR FRT GAWR RR
 THIS VEHICLE CONFORMS TO ALL APPLICABLE U.S. FEDERAL MOTOR VEHICLE SAFETY, BUMPER, AND TRAFFIC PREVENTION STANDARDS IN EFFECT ON THE DATE OF MANUFACTURE SHOWN ABOVE.
 200 PASS CAR

EXAMPLE

The other label is the Certification label, found on the rear edge of the driver's door. It tells you the gross weight capacity of your vehicle, called the Gross Vehicle Weight Rating (GVWR). The GVWR includes the weight of the vehicle, all occupants, fuel and cargo. Never exceed the GVWR for your vehicle or the Gross Axle Weight Rating (GAWR) for either the front or rear axle.

If you do have a heavy load, spread it out. Don't carry more than 167 lbs. (75 kg) in your trunk.

CAUTION:

Do not load your vehicle any heavier than the GVWR, or either the maximum front or rear GAWR. If you do, parts on your vehicle can break, and it can change the way your vehicle handles. These could cause you to lose control and crash. Also, overloading can shorten the life of your vehicle.

NOTICE:

Your warranty does not cover parts or components that fail because of overloading.

If you put things inside your vehicle -- like suitcases, tools, packages or anything else -- they will go as fast as the vehicle goes. If you have to stop or turn quickly, or if there is a crash, they'll keep going.

CAUTION:

Things you put inside your vehicle can strike and injure people in a sudden stop or turn, or in a crash.

- Put things in the trunk of your vehicle. In a trunk, put them as far forward as you can. Try to spread the weight evenly.
- Never stack heavier things, like suitcases, inside the vehicle so that some of them are above the tops of the seats.
- Don't leave an unsecured child restraint in your vehicle.
- When you carry something inside the vehicle, secure it whenever you can.
- Don't leave a seat folded down unless you need to.

Towing a Trailer

CAUTION:

If you don't use the correct equipment and drive properly, you can lose control when you pull a trailer. For example, if the trailer is too heavy, the brakes may not work well -- or even at all. You and your passengers could be seriously injured. You may also damage your vehicle; the resulting repairs would not be covered by your warranty. Pull a trailer only if you have followed all the steps in this section. Ask your dealer for advice and information about towing a trailer with your vehicle.

Your vehicle can tow a trailer if it is equipped with the proper trailer towing equipment. To identify what the vehicle trailering capacity is for your vehicle, you should read the information in "Weight of the Trailer" that appears later in this section. But trailering is different than just driving your vehicle by itself. Trailering means changes in handling, durability and fuel economy. Successful, safe trailering takes correct equipment, and it has to be used properly.

That's the reason for this part. In it are many time-tested, important trailering tips and safety rules. Many of these are important for your safety and that of your passengers. So please read this section carefully before you pull a trailer.

Load-pulling components such as the engine, transaxle, wheel assemblies and tires are forced to work harder against the drag of the added weight. The engine is required to operate at relatively higher speeds and under greater loads, generating extra heat. What's more, the trailer adds considerably to wind resistance, increasing the pulling requirements.

If You Do Decide To Pull A Trailer

If you do, here are some important points:

- There are many different laws, including speed limit restrictions, having to do with trailering. Make sure your rig will be legal, not only where you live but also where you'll be driving. A good source for this information can be state or provincial police.
- Consider using a sway control. You can ask a hitch dealer about sway controls.
- Don't tow a trailer at all during the first 1,000 miles (1 600 km) your new vehicle is driven. Your engine, axle or other parts could be damaged.
- Then, during the first 500 miles (800 km) that you tow a trailer, don't drive over 50 mph (80 km/h) and don't make starts at full throttle. This helps your engine and other parts of your vehicle wear in at the heavier loads.
- Obey speed limit restrictions when towing a trailer. Don't drive faster than the maximum posted speed for trailers, or no more than 55 mph (90 km/h), to save wear on your vehicle's parts.

Three important considerations have to do with weight:

- the weight of the trailer,
- the weight of the trailer tongue
- and the total weight on your vehicle's tires.

Weight of the Trailer

How heavy can a trailer safely be?

It should never weigh more than 1000 lbs. (454 kg).

But even that can be too heavy.

It depends on how you plan to use your rig. For example, speed, altitude, road grades, outside temperature and how much your vehicle is used to pull a trailer are all important. And, it can also depend on any special equipment that you have on your vehicle.

You can ask your dealer for our trailering information or advice, or you can write us at:

Pontiac–GMC Customer Assistance
P.O. Box 33172
Detroit, MI 48232–5172

In Canada, write to:

General Motors of Canada Limited
Customer Communication Centre, 163-005
1908 Colonel Sam Drive
Oshawa, Ontario L1H 8P7

Weight of the Trailer Tongue

The tongue load (A) of any trailer is an important weight to measure because it affects the total or gross weight of your vehicle. The Gross Vehicle Weight (GVW) includes the curb weight of the vehicle, any cargo you may carry in it, and the people who will be riding in the vehicle. And if you tow a trailer, you must add the tongue load to the GVW because your vehicle will be carrying that weight, too. See “Loading Your Vehicle” in the Index for more information about your vehicle’s maximum load capacity.

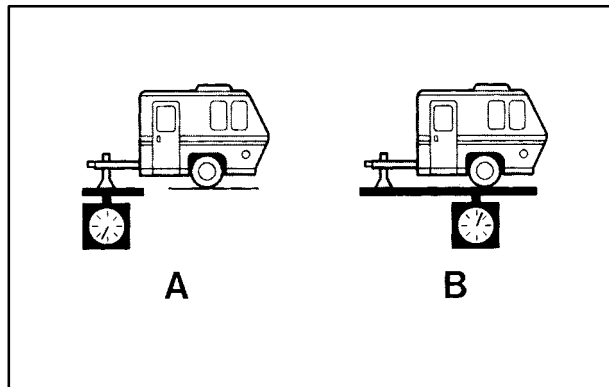

If you're using a weight-carrying hitch or a weight-distributing hitch, the trailer tongue (A) should weigh 10-15 percent of the total loaded trailer weight (B).

After you've loaded your trailer, weigh the trailer and then the tongue, separately, to see if the weights are proper. If they aren't, you may be able to get them right simply by moving some items around in the trailer.

Total Weight on Your Vehicle's Tires

Be sure your vehicle's tires are inflated to the upper limit for cold tires. You'll find these numbers on the Tire Loading Information label, found on the inside of the trunk lid, or see "Loading Your Vehicle" in the Index. Then be sure you don't go over the GVW limit for your vehicle, including the weight of the trailer tongue.

Hitches

It's important to have the correct hitch equipment. Crosswinds, large trucks going by and rough roads are a few reasons why you'll need the right hitch. Here are some rules to follow:

- The rear bumper on your vehicle is not intended for hitches. Do not attach rental hitches or other bumper-type hitches to it. Use only a frame-mounted hitch that does not attach to the bumper.
- Will you have to make any holes in the body of your vehicle when you install a trailer hitch? If you do, then be sure to seal the holes later when you remove the hitch. If you don't seal them, deadly carbon monoxide (CO) from your exhaust can get into your vehicle. See "Carbon Monoxide" in the Index. Dirt and water can, too.

Safety Chains

You should always attach chains between your vehicle and your trailer. Cross the safety chains under the tongue of the trailer so that the tongue will not drop to the road if it becomes separated from the hitch. Instructions about safety chains may be provided by the hitch manufacturer or by the trailer manufacturer. Follow the manufacturer's recommendation for attaching safety chains and do not attach them to the bumper. Always leave just enough slack so you can turn with your rig. And, never allow safety chains to drag on the ground.

Trailer Brakes

Because you have anti-lock brakes, do not try to tap into your vehicle's brake system. If you do, both brake systems won't work well, or at all.

Driving with a Trailer

Towing a trailer requires a certain amount of experience. Before setting out for the open road, you'll want to get to know your rig. Acquaint yourself with the feel of handling and braking with the added weight of the trailer. And always keep in mind that the vehicle you are driving is now a good deal longer and not nearly as responsive as your vehicle is by itself.

Before you start, check the trailer hitch and platform (and attachments), safety chains, electrical connector, lamps, tires and mirror adjustment. If the trailer has electric brakes, start your vehicle and trailer moving and then apply the trailer brake controller by hand to be sure the brakes are working. This lets you check your electrical connection at the same time.

During your trip, check occasionally to be sure that the load is secure, and that the lamps and any trailer brakes are still working.

Following Distance

Stay at least twice as far behind the vehicle ahead as you would when driving your vehicle without a trailer. This can help you avoid situations that require heavy braking and sudden turns.

Passing

You'll need more passing distance up ahead when you're towing a trailer. And, because you're a good deal longer, you'll need to go much farther beyond the passed vehicle before you can return to your lane.

Backing Up

Hold the bottom of the steering wheel with one hand. Then, to move the trailer to the left, just move that hand to the left. To move the trailer to the right, move your hand to the right. Always back up slowly and, if possible, have someone guide you.

Making Turns

NOTICE:

Making very sharp turns while trailering could cause the trailer to come in contact with the vehicle. Your vehicle could be damaged. Avoid making very sharp turns while trailering.

When you're turning with a trailer, make wider turns than normal. Do this so your trailer won't strike soft shoulders, curbs, road signs, trees or other objects. Avoid jerky or sudden maneuvers. Signal well in advance.

Turn Signals When Towing a Trailer

When you tow a trailer, your vehicle may need a different turn signal flasher and/or extra wiring. Check with your dealer. The arrows on your instrument panel will flash whenever you signal a turn or lane change. Properly hooked up, the trailer lamps will also flash, telling other drivers you're about to turn, change lanes or stop.

When towing a trailer, the arrows on your instrument panel will flash for turns even if the bulbs on the trailer are burned out. Thus, you may think drivers behind you are seeing your signal when they are not. It's important to check occasionally to be sure the trailer bulbs are still working.

Your vehicle has bulb warning lights. When you plug a trailer lighting system into your vehicle's lighting system, its bulb warning lights may not let you know if one of your lamps goes out. So, when you have a trailer lighting system plugged in, be sure to check your vehicle and trailer lamps from time to time to be sure they're all working. Once you disconnect the trailer lamps, the bulb warning lights again can tell you if one of your vehicle lamps is out.

Driving On Grades

Reduce speed and shift to a lower gear *before* you start down a long or steep downgrade. If you don't shift down, you might have to use your brakes so much that they would get hot and no longer work well.

On a long uphill grade, shift down and reduce your speed to around 45 mph (70 km/h) to reduce the possibility of engine and transaxle overheating.

If you have overdrive, you may have to drive in THIRD (3) instead of AUTOMATIC OVERDRIVE (D).

Parking on Hills

CAUTION:

You really should not park your vehicle, with a trailer attached, on a hill. If something goes wrong, your rig could start to move. People can be injured, and both your vehicle and the trailer can be damaged.

But if you ever have to park your rig on a hill, here's how to do it:

1. Apply your regular brakes, but don't shift into PARK (P) yet.
2. Have someone place chocks under the trailer wheels.
3. When the wheel chocks are in place, release the regular brakes until the chocks absorb the load.
4. Reapply the regular brakes. Then apply your parking brake, and then shift to PARK (P).
5. Release the regular brakes.

When You Are Ready to Leave After Parking on a Hill

1. Apply your regular brakes and hold the pedal down while you:
 - start your engine,
 - shift into a gear, and
 - release the parking brake.
2. Let up on the brake pedal.
3. Drive slowly until the trailer is clear of the chocks.
4. Stop and have someone pick up and store the chocks.

Maintenance When Trailer Towing

Your vehicle will need service more often when you're pulling a trailer. See the Maintenance Schedule for more on this. Things that are especially important in trailer operation are automatic transaxle fluid (don't overfill), engine oil, drive belts, cooling system and brake system. Each of these is covered in this manual, and the Index will help you find them quickly. If you're trailering, it's a good idea to review this information before you start your trip.

Check periodically to see that all hitch nuts and bolts are tight.

Engine Cooling When Trailer Towing

Your cooling system may temporarily overheat during severe operating conditions. See "Engine Overheating" in the Index.



Section 5 Problems on the Road

Here you'll find what to do about some problems that can occur on the road.

5-2 Hazard Warning Flashers
5-3 Other Warning Devices
5-3 Jump Starting
5-10 Towing Your Vehicle
5-11 Engine Overheating

5-14 Cooling System
5-25 If A Tire Goes Flat
5-26 Changing a Flat Tire
5-37 Compact Spare Tire
5-38 If Your Stuck: In Sand, Mud, Ice or Snow

Hazard Warning Flashers

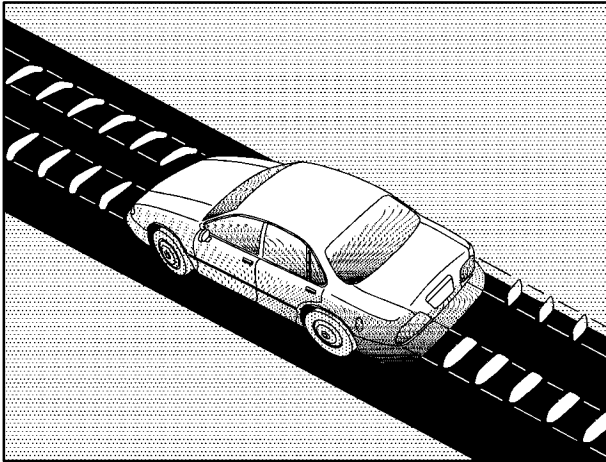

Your hazard warning flashers let you warn others. They also let police know you have a problem. Your front and rear turn signal lamps will flash on and off.



The hazard warning flasher button is located on top of the steering column.

The hazard warning flashers work no matter what position your key is in, and even if the key isn't in.

Press the button to make your front and rear turn signal lamps flash on and off. Press the button again to turn the flashers off.

When the hazard warning flashers are on, your turn signals and brake lamps won't work.

Other Warning Devices

If you carry reflective triangles, you can set one up at the side of the road about 300 feet (100 m) behind your vehicle.

Jump Starting

If your battery has run down, you may want to use another vehicle and some jumper cables to start your vehicle. Be sure to follow the steps listed below to do it safely.

CAUTION:

Batteries can hurt you. They can be dangerous because:

- They contain acid that can burn you.
- They contain gas that can explode or ignite.
- They contain enough electricity to burn you.

If you don't follow these steps exactly, some or all of these things can hurt you.

NOTICE:

Ignoring these steps could result in costly damage to your vehicle that wouldn't be covered by your warranty.

The ACDelco[®] battery in your vehicle has a built-in hydrometer. Do not charge, test or jump start the battery if the hydrometer looks clear or light yellow. Replace the battery when there is a clear or light yellow hydrometer and a cranking complaint.

Trying to start your vehicle by pushing or pulling it won't work, and it could damage your vehicle.

NOTICE:

If the other system isn't a 12-volt system with a negative ground, both vehicles can be damaged.

1. Check the other vehicle. It must have a 12-volt battery with a negative ground system.
2. Get the vehicles close enough so the jumper cables can reach, but be sure the vehicles aren't touching each other. If they are, it could cause a ground connection you don't want. You wouldn't be able to start your vehicle, and the bad grounding could damage the electrical systems.

To avoid the possibility of the vehicles rolling, set the parking brake firmly on both vehicles involved in the jump start procedure. Put an automatic transaxle in PARK (P) or a manual transaxle in NEUTRAL before setting the parking brake.

NOTICE:

If you leave your radio on, it could be badly damaged. The repairs wouldn't be covered by your warranty.

3. Turn off the ignition on both vehicles. Unplug unnecessary accessories plugged into the cigarette lighter or in the accessory power outlets. Turn off the radio and all lamps that aren't needed. This will avoid sparks and help save both batteries. And it could save your radio!

4. Open the hoods and locate the batteries. Find the positive (+) and negative (-) terminal locations on each vehicle. You will not need to access your battery for jump starting. Your vehicle has a remote positive (+) jump starting terminal for that purpose. The terminal is located in the engine compartment on the passenger's side of the vehicle, near the diagonal cross brace. See "Engine Compartment Overview" in the Index for more information on location.



To uncover the remote positive (+) terminal, squeeze the sides of the plastic cap and slide the cap off. You should always use the remote positive (+) terminal instead of the positive (+) terminal on the battery.

 **CAUTION:**

An electric fan can start up even when the engine is not running and can injure you. Keep hands, clothing and tools away from any underhood electric fan.

 **CAUTION:**

Using a match near a battery can cause battery gas to explode. People have been hurt doing this, and some have been blinded. Use a flashlight if you need more light.

Be sure the battery has enough water. You don't need to add water to the ACDelco[®] battery installed in every new GM vehicle. But if a battery has filler caps, be sure the right amount of fluid is there. If it is low, add water to take care of that first. If you don't, explosive gas could be present.

CAUTION: (Continued)

CAUTION: (Continued)

Battery fluid contains acid that can burn you. Don't get it on you. If you accidentally get it in your eyes or on your skin, flush the place with water and get medical help immediately.

 **CAUTION:**

Fans or other moving engine parts can injure you badly. Keep your hands away from moving parts once the engine is running.

5. Check that the jumper cables don't have loose or missing insulation. If they do, you could get a shock. The vehicles could be damaged too.



Before you connect the cables, here are some basic things you should know. Positive (+) will go to positive (+) or to a remote positive (+) terminal if the vehicle has one. Negative will go to a heavy, unpainted metal engine part or to a remote negative (-) terminal if the vehicle has one.

Don't connect positive (+) to negative (-), or you'll get a short that would damage the battery and maybe other parts, too. And don't connect the negative (-) cable to the negative (-) terminal on the dead battery because this can cause sparks.



6. Connect the red positive (+) cable to the positive (+) terminal location on the vehicle with the dead battery. Use a remote positive (+) terminal if the vehicle has one.



7. Don't let the other end touch metal. Connect it to the positive (+) terminal location on the vehicle with the good battery. Use a remote positive (+) terminal if the vehicle has one.



8. Now connect the black negative (-) cable to the negative (-) terminal location on the vehicle with the good battery. Use a remote negative (-) terminal if the vehicle has one.

Don't let the other end touch anything until the next step. The other end of the negative (-) cable *doesn't* go to the dead battery. It goes to a heavy, unpainted metal part or to a remote negative (-) terminal on the vehicle with the dead battery.

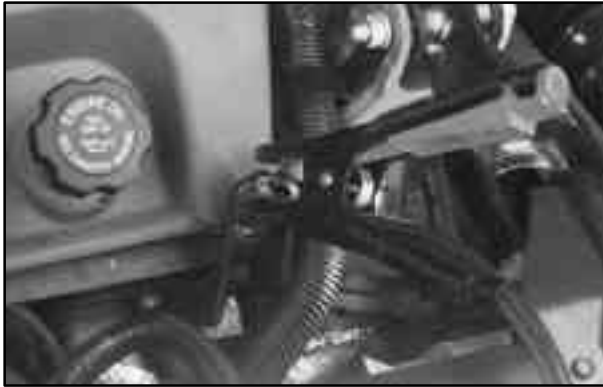

NOTICE:

Damage to your vehicle may result from electrical shorting if jumper cables are removed incorrectly. To prevent electrical shorting, take care that the cables don't touch each other or any other metal. The repairs wouldn't be covered by your warranty.

9. Connect the other end of the negative (-) cable at least 18 inches (45 cm) away from the dead battery, but not near engine parts that move. The electrical connection is just as good there, and the chance of sparks getting back to the battery is much less.
10. Now start the vehicle with the good battery and run the engine for a while.
11. Try to start the vehicle that had the dead battery. If it won't start after a few tries, it probably needs service.

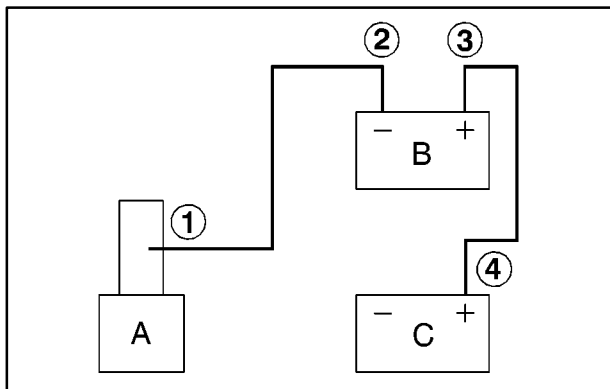

Jumper Cable Removal

- A. Heavy, Unpainted Metal Engine Part
- B. Good Battery or Remote Positive (+) Terminal
- C. Dead Battery or Remote Positive (+) Terminal

To disconnect the jumper cables from both vehicles, do the following:

1. Disconnect the black negative (-) cable from the vehicle that had the dead battery.
2. Disconnect the black negative (-) cable from the vehicle with the good battery.
3. Disconnect the red positive (+) cable from vehicle from the vehicle with the good battery.
4. Disconnect the red positive (+) cable from the other vehicle.
5. Return the remote positive (+) terminal cover to its original position.

Towing Your Vehicle

Consult your dealer or a professional towing service if you need to have your disabled vehicle towed. See “Roadside Assistance” in the Index. If you want to tow your vehicle behind another vehicle for recreational purposes (such as behind a motorhome), see “Recreational Vehicle Towing” in the Index.

Engine Overheating

You will find a coolant temperature gage and a warning light concerning an overheated engine condition on the instrument panel cluster. See “Engine Coolant Temperature Gage” and “Engine Coolant Temperature Light” in the Index. You also have a low coolant light on your instrument panel cluster. See “Low Coolant Light” in the Index.

Overheated Engine Protection Operating Mode

This emergency operating mode allows your vehicle to be driven to a safe place in an emergency situation. If an overheated engine condition exists, an overheat protection mode which alternates firing groups of cylinders helps prevent engine damage. In this mode, you will notice a significant loss in power and engine performance. The low coolant light may come on and the temperature gage will indicate an overheat condition exists. Driving extended miles (km) and/or towing a trailer in the overheat protection mode should be avoided.

NOTICE:

After driving in the overheated engine protection operating mode, to avoid engine damage, allow the engine to cool before attempting any repair. The engine oil will be severely degraded. Repair the cause of coolant loss, change the oil and reset the oil life system. See “Engine Oil” in the Index.

If Steam Is Coming From Your Engine



⚠ CAUTION:

Steam from an overheated engine can burn you badly, even if you just open the hood. Stay away from the engine if you see or hear steam coming from it. Just turn it off and get everyone away from the vehicle until it cools down. Wait until there is no sign of steam or coolant before you open the hood.

If you keep driving when your engine is overheated, the liquids in it can catch fire. You or others could be badly burned. Stop your engine if it overheats, and get out of the vehicle until the engine is cool. See “Overheated Engine Protection Operating Mode” in the Index.

NOTICE:

If your engine catches fire because you keep driving with no coolant, your vehicle can be badly damaged. The costly repairs would not be covered by your warranty. See “Overheated Engine Protection Operating Mode” in the Index.

If No Steam Is Coming From Your Engine

An overheat warning, along with a low coolant light, can indicate a serious problem. See “Low Coolant Light” in the Index.

If you get an engine overheat warning with no low coolant light, but see or hear no steam, the problem may not be too serious. Sometimes the engine can get a little too hot when you:

- Climb a long hill on a hot day.
- Stop after high-speed driving.
- Idle for long periods in traffic.
- Tow a trailer.

If you get the overheat warning with no sign of steam, try this for a minute or so:

1. If your air conditioner is on, turn it off.
2. Turn on your heater to full hot at the highest fan speed and open the window as necessary.
3. If you’re in a traffic jam, shift to NEUTRAL (N); otherwise, shift to the highest gear while driving -- AUTOMATIC OVERDRIVE (D) or THIRD (3).

If you no longer have the overheat warning, you can drive. Just to be safe, drive slower for about 10 minutes. If the warning doesn’t come back on, you can drive normally.

If the warning continues, pull over, stop, and park your vehicle right away.

If there’s still no sign of steam, idle the engine for three minutes while you’re parked. If you still have the warning, *turn off the engine and get everyone out of the vehicle* until it cools down. Also, see “Overheated Engine Protection Operating Mode” listed previously in this section.

You may decide not to lift the hood but to get service help right away.

Cooling System

When you decide it's safe to lift the hood, here's what you'll see:



3100 V6 Engine

- A. Electric Engine Cooling Fans
- B. Radiator Pressure Cap
- C. Coolant Recovery Tank



3800 V6 and 3800 V6 Supercharged Engines

- A. Electric Engine Cooling Fans
- B. Radiator Pressure Cap
- C. Coolant Recovery Tank



CAUTION:

An electric engine cooling fan under the hood can start up even when the engine is not running and can injure you. Keep hands, clothing and tools away from any underhood electric fan.

If the coolant inside the coolant recovery tank is boiling, don't do anything else until it cools down. The vehicle should be parked on a level surface.



When the engine is cold, the coolant level should be at or above the COLD mark on the coolant recovery tank. If it isn't, you may have a leak at the pressure cap or in the radiator hoses, heater hoses, radiator, water pump or somewhere else in the cooling system.

 **CAUTION:**

Heater and radiator hoses, and other engine parts, can be very hot. Don't touch them. If you do, you can be burned.

Don't run the engine if there is a leak. If you run the engine, it could lose all coolant. That could cause an engine fire, and you could be burned. Get any leak fixed before you drive the vehicle.

If there seems to be no leak, with the engine on, check to see if the electric engine cooling fans are running. If the engine is overheating, both fans should be running. If they aren't, your vehicle needs service.

NOTICE:

Engine damage from running your engine without coolant isn't covered by your warranty. See "Overheated Engine Protection Operating Mode" in the Index.

NOTICE:

When adding coolant, it is important that you use only DEX-COOL[®] (silicate-free) coolant.

If coolant other than DEX-COOL is added to the system, premature engine, heater core or radiator corrosion may result. In addition, the engine coolant will require change sooner -- at 30,000 miles (50 000 km) or 24 months, whichever occurs first. Damage caused by the use of coolant other than DEX-COOL[®] is not covered by your new vehicle warranty.

How to Add Coolant to the Coolant Recovery Tank

If you haven't found a problem yet, but the coolant level isn't at the COLD mark, add a 50/50 mixture of *clean, drinkable water* and DEX-COOL[®] engine coolant at the coolant recovery tank. See "Engine Coolant" in the Index for more information.

⚠ CAUTION:

Adding only plain water to your cooling system can be dangerous. Plain water, or some other liquid such as alcohol, can boil before the proper coolant mixture will. Your vehicle's coolant warning system is set for the proper coolant mixture. With plain water or the wrong mixture, your engine could get too hot but you wouldn't get the overheat warning. Your engine could catch fire and you or others could be burned. Use a 50/50 mixture of clean, drinkable water and DEX-COOL[®] coolant.

NOTICE:

In cold weather, water can freeze and crack the engine, radiator, heater core and other parts. Use the recommended coolant and the proper coolant mixture.



⚠ CAUTION:

You can be burned if you spill coolant on hot engine parts. Coolant contains ethylene glycol and it will burn if the engine parts are hot enough. Don't spill coolant on a hot engine.

When the coolant in the coolant recovery tank is at the COLD mark, start your vehicle.

If the overheat warning continues, there's one more thing you can try. You can add the proper coolant mixture directly to the radiator, but be sure the cooling system is cool before you do it.

⚠ CAUTION:

Steam and scalding liquids from a hot cooling system can blow out and burn you badly. They are under pressure, and if you turn the pressure cap -- even a little -- they can come out at high speed. Never turn the cap when the cooling system, including the radiator pressure cap, is hot. Wait for the cooling system and radiator pressure cap to cool if you ever have to turn the pressure cap.



How to Add Coolant to the Radiator

NOTICE:

Your engine has a specific radiator fill procedure. Failure to follow this procedure could cause your engine to overheat and be severely damaged.



The radiator pressure cap is located on the passenger's side of the vehicle in the front of the engine compartment, near the battery and the diagonal cross brace. See "Engine Compartment Overview" in the Index for more information on location.

You can remove the radiator pressure cap when the cooling system, including the radiator pressure cap and upper radiator hose, is no longer hot.

1. Turn the pressure cap slowly counterclockwise until it first stops. (Don't press down while turning the pressure cap).

If you hear a hiss, wait for that to stop. A hiss means there is still some pressure left.



2. Then keep turning the pressure cap, but now push down as you turn it. Remove the pressure cap.

⚠ CAUTION:

You can be burned if you spill coolant on hot engine parts. Coolant contains ethylene glycol and it will burn if the engine parts are hot enough. Don't spill coolant on a hot engine.

3. If you have the 3800 V6 engine, remove the 3800 Series II V6 engine cover shield to access the bleed valve.

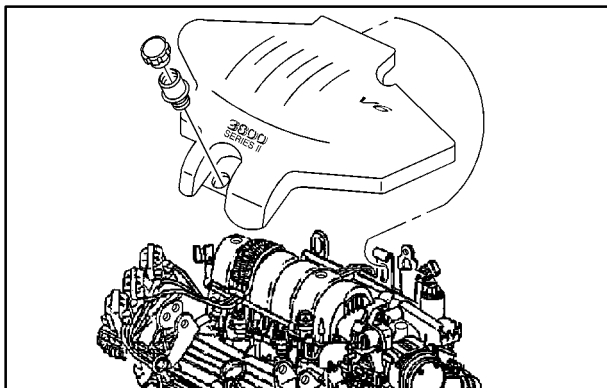

- A. Clean the area around the engine oil fill tube and cap before removing. Twist the oil fill tube, with cap attached, counterclockwise and remove it.
- B. If you have the supercharged engine, remove the nut in the center of the cover shield.
- C. Lift the engine cover shield at the front, slide the catch tab out of the engine bracket and remove the cover shield.
- D. Put the oil fill tube, with cap attached, in the valve cover oil fill hole until you're ready to replace the cover shield.

4. After the engine cools, open the coolant air bleed valve or valves.



**Thermostat Housing
(3100 V6)**



**Thermostat Bypass
Tube (3100 V6)**

3100 V6 engine: There are two bleed valves. One is located on the thermostat housing. The other is located on the thermostat bypass tube.



**Thermostat Housing
(3800 V6)**

3800 V6 engine: There is one bleed valve. It is located on the thermostat housing.



5. Fill the radiator with the proper DEX-COOL[®] coolant mixture, up to the base of the filler neck. See “Engine Coolant” in the Index for more information about the proper coolant mixture.

If you see a stream of coolant coming from an air bleed valve, close the valve. Otherwise, close the valves after the radiator is filled.

6. Rinse or wipe any spilled coolant from the engine and the compartment.
7. If you have the 3800 V6 engine, replace the 3800 Series II V6 engine cover shield.
 - A. Remove the oil fill tube, with cap attached, from the valve cover.
 - B. Insert the catch tab on the cover shield under the bracket on the engine.
 - C. Place the hole in the cover shield over the hole in the valve cover. Install oil fill tube and cap by twisting clockwise.
 - D. If you have the supercharged engine, install the nut in the center of the cover shield.



8. Then fill the coolant recovery tank to COLD mark.
9. Put the cap back on the coolant recovery tank, but leave the pressure cap off.



10. Start the engine and let it run until you can feel the upper radiator hose getting hot. Watch out for the engine cooling fans.
11. By this time, the coolant level inside the radiator filler neck may be lower. If the level is lower, add more of the proper DEX-COOL[®] coolant mixture through the filler neck until the level reaches the base of the filler neck.



12. Then replace the pressure cap. At any time during this procedure if coolant begins to flow out of the filler neck, reinstall the pressure cap. Be sure the arrow on the pressure cap lines up like this.
13. Check the coolant in the recovery tank. The level in the coolant recovery tank should be at the HOT mark when the engine is hot or at the COLD mark when the engine is cold.

If a Tire Goes Flat

It's unusual for a tire to "blow out" while you're driving, especially if you maintain your tires properly. If air goes out of a tire, it's much more likely to leak out slowly. But if you should ever have a "blowout," here are a few tips about what to expect and what to do:

If a front tire fails, the flat tire will create a drag that pulls the vehicle toward that side. Take your foot off the accelerator pedal and grip the steering wheel firmly. Steer to maintain lane position, and then gently brake to a stop well out of the traffic lane.

A rear blowout, particularly on a curve, acts much like a skid and may require the same correction you'd use in a skid. In any rear blowout, remove your foot from the accelerator pedal. Get the vehicle under control by steering the way you want the vehicle to go. It may be very bumpy and noisy, but you can still steer. Gently brake to a stop -- well off the road if possible.

If a tire goes flat, the next part shows how to use your jacking equipment to change a flat tire safely.

Changing a Flat Tire

If a tire goes flat, avoid further tire and wheel damage by driving slowly to a level place. Turn on your hazard warning flashers.

CAUTION:

Changing a tire can cause an injury. The vehicle can slip off the jack and roll over you or other people. You and they could be badly injured. Find a level place to change your tire. To help prevent the vehicle from moving:

1. Set the parking brake firmly.
2. Put the shift lever in PARK (P).
3. Turn off the engine.

To be even more certain the vehicle won't move, you can put blocks at the front and rear of the tire farthest away from the one being changed. That would be the tire on the other side of the vehicle, at the opposite end.

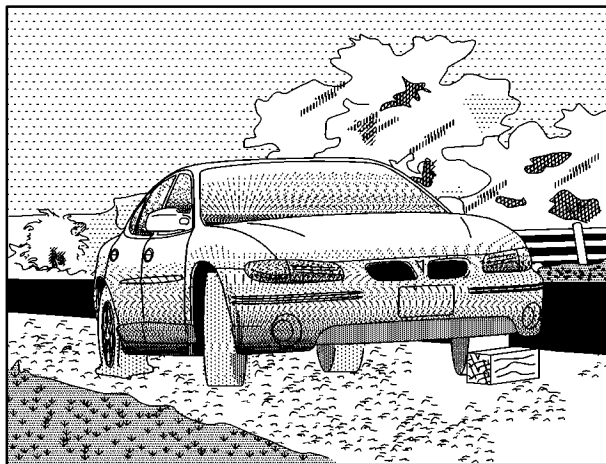

The following steps will tell you how to use the jack and change a tire.

Removing the Spare Tire and Tools

The equipment you'll need is in the trunk.

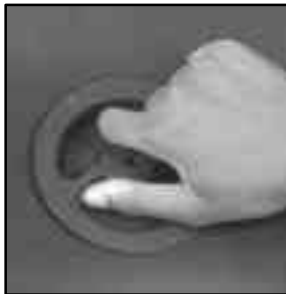

Turn the center nut on the compact spare tire cover counterclockwise to remove it.



Remove the compact spare tire. See “Compact Spare Tire” in the Index for more information about the compact spare tire.



Turn the nut holding the jack counterclockwise and remove it. Then remove the jack and wrench.



The tools you'll be using include the jack (A) extension and protector/guide (B) and the wheel wrench (C).

Removing Wheel Covers and Wheel Nut Caps

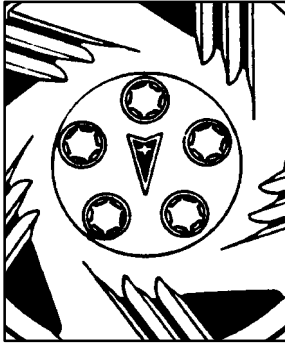

If there is a wheel cover, loosen the plastic nut caps with the wheel wrench. They won't come off. Then, using the flat end of the wheel wrench, pry along the edge of the cover until it comes off.

Removing the Flat Tire and Installing the Spare Tire



1. Using the wheel wrench, loosen all the wheel nuts. Don't remove them yet.
2. Turn the jack handle clockwise to raise the vehicle. Raise the vehicle far enough off the ground for the spare tire to fit underneath the wheel well.

⚠ CAUTION:

Getting under a vehicle when it is jacked up is dangerous. If the vehicle slips off the jack, you could be badly injured or killed. Never get under a vehicle when it is supported only by a jack.

⚠ CAUTION:

Raising your vehicle with the jack improperly positioned can damage the vehicle and even make the vehicle fall. To help avoid personal injury and vehicle damage, be sure to fit the jack lift head into the proper location before raising the vehicle.

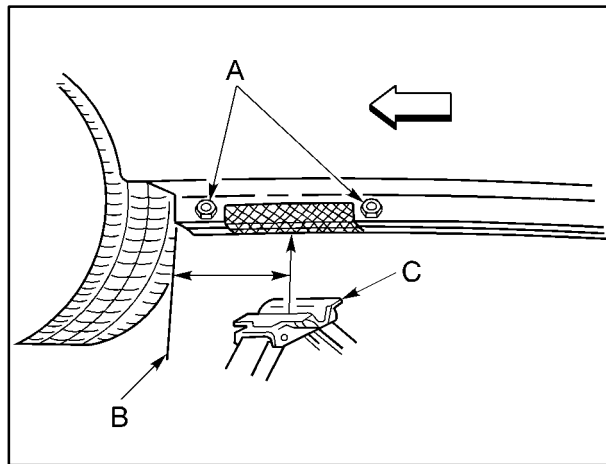

For jacking at the vehicle's front location, put the jack lift head (C) about 6 inches (15 cm) from the rear edge of the front wheel opening (B) or between the two bolts (A) as shown.

Put the compact spare tire near you.

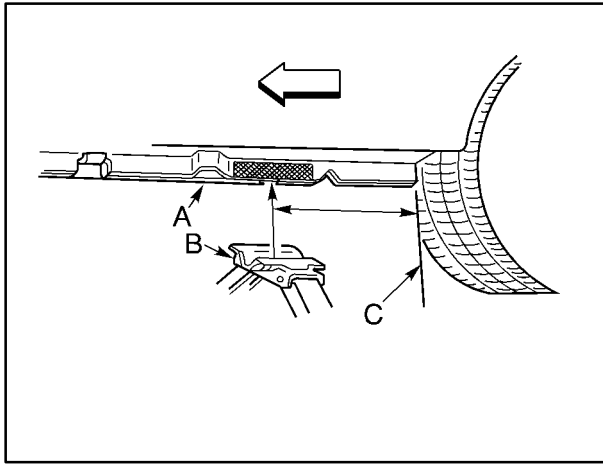

For jacking at the vehicle's rear location, put the jack lift head (B) about 5.5 inches (14 cm) from the front edge of the rear wheel opening (C) or just behind the off-set (A) as shown.

Put the compact spare tire near you.

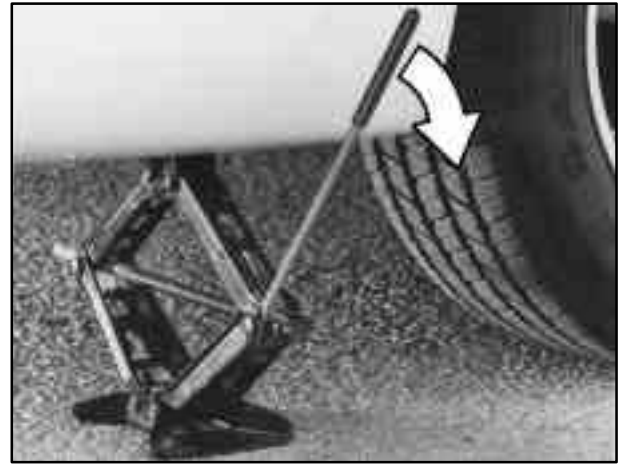

3. Raise the vehicle by turning the jack handle clockwise. Raise the vehicle far enough off the ground for the spare tire to fit underneath the wheel well. Remove all wheel nuts and take off the flat tire.

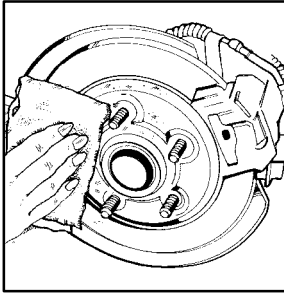

4. Remove any rust or dirt from the wheel bolts, mounting surfaces and spare wheel.

⚠ CAUTION:

Never use oil or grease on studs or nuts. If you do, the nuts might come loose. Your wheel could fall off, causing a serious accident.

5. Place the spare on the wheel mounting surface.



6. Reinstall the wheel nuts with the rounded end of the nuts toward the wheel. Tighten each nut by hand until the wheel is held against the hub.

⚠ CAUTION:

Rust or dirt on the wheel, or on the parts to which it is fastened, can make the wheel nuts become loose after a time. The wheel could come off and cause an accident. When you change a wheel, remove any rust or dirt from the places where the wheel attaches to the vehicle. In an emergency, you can use a cloth or a paper towel to do this; but be sure to use a scraper or wire brush later, if you need to, to get all the rust or dirt off.

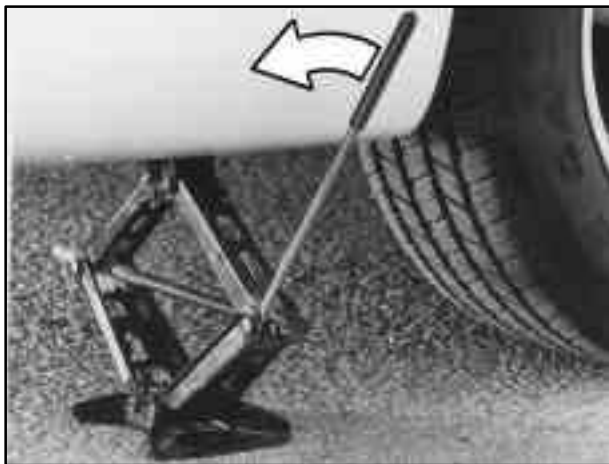

7. Lower the vehicle by turning the jack handle counterclockwise. Lower the jack completely.

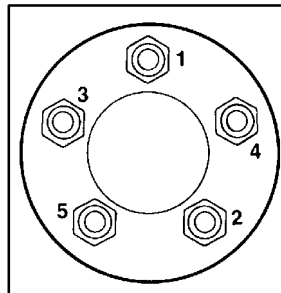

8. Tighten the wheel nuts firmly in a crisscross sequence as shown.
9. Reinstall the wheel trim. If the vehicle has plastic caps tighten them by hand. With a wheel wrench, tighten the plastic caps an additional quarter turn clockwise.

 **CAUTION:**

Incorrect wheel nuts or improperly tightened wheel nuts can cause the wheel to become loose and even come off. This could lead to an accident. Be sure to use the correct wheel nuts. If you have to replace them, be sure to get new GM original equipment wheel nuts.

Stop somewhere as soon as you can and have the nuts tightened with a torque wrench to 100 lb-ft. (140 N-m).

NOTICE:

Improperly tightened wheel nuts can lead to brake pulsation and rotor damage. To avoid expensive brake repairs, evenly tighten the wheel nuts in the proper sequence and to the proper torque specification.

10. Don't try to put the wheel cover on your compact spare tire. It won't fit. Store the wheel cover in the trunk until you have the flat tire repaired or replaced.

NOTICE:

Wheel covers won't fit on your compact spare tire. If you try to put a wheel cover on your compact spare tire you could damage the cover or the compact spare tire.

Storing the Flat Tire and Tools

CAUTION:

Storing a jack, a tire or other equipment in the passenger compartment of the vehicle could cause injury. In a sudden stop or collision, loose equipment could strike someone. Store all these in the proper place.

After you've put the compact spare tire on your vehicle, you'll need to store the flat tire in the trunk. Use the following procedure to secure the flat tire in the trunk.



When storing a full-size tire, you must use the extension to help avoid wheel surface damage. Use the extension and protector/guide located in the foam holder. To store a full-size tire, place the tire in the trunk valve stem facing down, with the protector/guide placed through a wheel bolt hole. Remove the protector and attach the retainer securely. When putting the compact spare back in the trunk, place the protector/guide back in the foam holder. Store the cover as far forward as possible.

Storing the Spare Tire and Tools

CAUTION:

Storing a jack, a tire or other equipment in the passenger compartment of the vehicle could cause injury. In a sudden stop or collision, loose equipment could strike someone. Store all these in the proper place.

Compact Spare Tire

The compact spare tire is for temporary use only. Replace the compact spare tire with a full-size tire as soon as you can. See “Compact Spare Tire” in the Index. See the storage instructions label on the trunk lid to properly position your compact spare tire in the trunk.

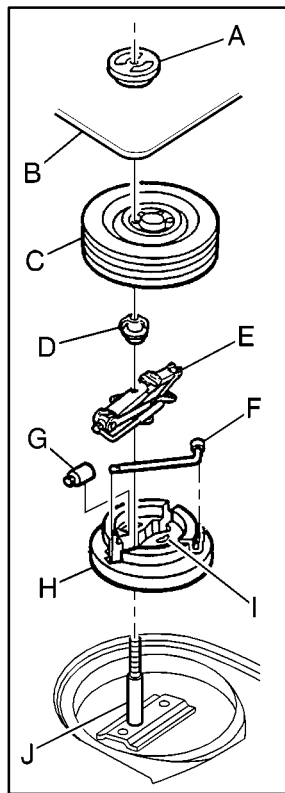

- A. Retainer
- B. Cover
- C. Compact Spare Tire
- D. Nut
- E. Jack
- F. Wrench
- G. Lock Nut Tool
- H. Foam Holder
- I. Extension and Protective Guide
- J. Bolt Screw

Compact Spare Tire

Although the compact spare tire was fully inflated when your vehicle was new, it can lose air after a time. Check the inflation pressure regularly. It should be 60 psi (420 kPa).

After installing the compact spare on your vehicle, you should stop as soon as possible and make sure your spare tire is correctly inflated. The compact spare is made to perform well at speeds up to 65 mph (105 km/h) for distances up to 3,000 miles (5 000 km), so you can finish your trip and have your full-size tire repaired or replaced where you want. Of course, it's best to replace your spare with a full-size tire as soon as you can. Your spare will last longer and be in good shape in case you need it again.

NOTICE:

When the compact spare is installed, don't take your vehicle through an automatic car wash with guide rails. The compact spare can get caught on the rails. That can damage the tire and wheel, and maybe other parts of your vehicle.

Don't use your compact spare on other vehicles.

And don't mix your compact spare tire or wheel with other wheels or tires. They won't fit. Keep your spare tire and its wheel together.

NOTICE:

Tire chains won't fit your compact spare. Using them can damage your vehicle and can damage the chains too. Don't use tire chains on your compact spare.

If You're Stuck: In Sand, Mud, Ice or Snow

In order to free your vehicle when it is stuck, you will need to spin the wheels, but you don't want to spin your wheels too fast. The method known as "rocking" can help you get out when you're stuck, but you must use caution.

CAUTION:

If you let your tires spin at high speed, they can explode, and you or others could be injured. And, the transaxle or other parts of the vehicle can overheat. That could cause an engine compartment fire or other damage. When you're stuck, spin the wheels as little as possible. Don't spin the wheels above 35 mph (55 km/h) as shown on the speedometer.

NOTICE:

Spinning your wheels can destroy parts of your vehicle as well as the tires. If you spin the wheels too fast while shifting your transaxle back and forth, you can destroy your transaxle.

For information about using tire chains on your vehicle, see "Tire Chains" in the Index.

Rocking Your Vehicle To Get It Out

First, turn your steering wheel left and right. That will clear the area around your front wheels. If your vehicle has traction control, you should turn the system off. See "Traction Control System" in the Index. Then shift back and forth between REVERSE (R) and a forward gear, spinning the wheels as little as possible. Release the accelerator pedal while you shift, and press lightly on the accelerator pedal when the transaxle is in gear. By slowly spinning your wheels in the forward and reverse directions, you will cause a rocking motion that may free your vehicle. If that doesn't get you out after a few tries, you may need to be towed out. If you do need to be towed out, see "Towing Your Vehicle" in the Index.



Section 6 Service and Appearance Care

Here you will find information about the care of your vehicle. This section begins with service and fuel information, and then it shows how to check important fluid and lubricant levels. There is also technical information about your vehicle, and a part devoted to its appearance care.

6-2	Service	6-58	Appearance Care
6-3	Fuel	6-58	Cleaning the Inside of Your Vehicle
6-5	Fuels in Foreign Countries	6-61	Care of Safety Belts
6-6	Filling Your Tank	6-62	Cleaning the Outside of Your Vehicle
6-8	Filling a Portable Fuel Container	6-64	Cleaning Aluminum or Chrome-Plated Wheels (If Equipped)
6-8	Checking Things Under the Hood	6-64	Cleaning Tires
6-13	Engine Oil	6-64	Sheet Metal Damage
6-20	Engine Air Cleaner/Filter	6-65	Finish Damage
6-21	Supercharger Oil	6-65	Underbody Maintenance
6-22	Automatic Transaxle Fluid	6-65	Chemical Paint Spotting
6-27	Engine Coolant	6-66	GM Vehicle Care/Appearance Materials
6-31	Radiator Pressure Cap	6-67	Vehicle Identification Number (VIN)
6-31	Power Steering Fluid	6-67	Service Parts Identification Label
6-33	Windshield Washer Fluid	6-68	Electrical System
6-35	Brakes	6-74	Replacement Bulbs
6-39	Battery	6-74	Capacities and Specifications
6-40	Bulb Replacement	6-75	Air Conditioning Refrigerant Capacity
6-48	Windshield Wiper Blade Replacement	6-76	Normal Maintenance Replacement Parts
6-49	Tires		

Service

Your dealer knows your vehicle best and wants you to be happy with it. We hope you'll go to your dealer for all your service needs. You'll get genuine GM parts and GM-trained and supported service people.

We hope you'll want to keep your GM vehicle all GM. Genuine GM parts have one of these marks:



Doing Your Own Service Work

If you want to do some of your own service work, you'll want to use the proper service manual. It tells you much more about how to service your vehicle than this manual can. To order the proper service manual, see "Service and Owner Publications" in the Index.

Your vehicle has an air bag system. Before attempting to do your own service work, see "Servicing Your Air Bag-Equipped Vehicle" in the Index.

You should keep a record with all parts receipts and list the mileage and the date of any service work you perform. See "Maintenance Record" in the Index.



CAUTION:

You can be injured and your vehicle could be damaged if you try to do service work on a vehicle without knowing enough about it.

- **Be sure you have sufficient knowledge, experience, the proper replacement parts and tools before you attempt any vehicle maintenance task.**
- **Be sure to use the proper nuts, bolts and other fasteners. “English” and “metric” fasteners can be easily confused. If you use the wrong fasteners, parts can later break or fall off. You could be hurt.**

Adding Equipment to the Outside of Your Vehicle

Things you might add to the outside of your vehicle can affect the airflow around it. This may cause wind noise and affect windshield washer performance. Check with your dealer before adding equipment to the outside of your vehicle.

Fuel

The 8th digit of your vehicle identification number (VIN) shows the code letter or number that identifies your engine. You will find the VIN at the top left of the instrument panel. See “Vehicle Identification Number” in the Index.

Gasoline Octane

If your vehicle has the 3100 V6 engine (VIN Code J) or 3800 V6 engine (VIN Code K), use regular unleaded gasoline with a posted octane of 87 or higher. If the octane is less than 87, you may get a heavy knocking noise when you drive. If it is bad enough, it can damage your engine. A little pinging noise when you accelerate or drive uphill is considered normal. This does not indicate a problem exists or that a higher-octane fuel is necessary.

If your vehicle has the 3800 Supercharged V6 engine (VIN Code1), use only premium unleaded gasoline with a posted octane of 91 or higher. In an emergency, you may be able to use a lower octane -- as low as 87 -- if heavy knocking does not occur. Refill your tank with premium fuel as soon as possible. If you are using 91 octane or higher-octane fuel and you hear heavy knocking, your engine needs service.

Gasoline Specifications

It is recommended that gasoline meet specifications which were developed by the American Automobile Manufacturers Association and endorsed by the Canadian Vehicle Manufacturers' Association for better vehicle performance and engine protection. Gasolines meeting these specifications could provide improved driveability and emission control system performance compared to other gasolines.



Canada Only

In Canada, look for the “Auto Makers’ Choice” label on the pump.

California Fuel

If your vehicle is certified to meet California Emission Standards (see the underhood emission control label), it is designed to operate on fuels that meet California specifications. If this fuel is not available in states adopting California emissions standards, your vehicle will operate satisfactorily on fuels meeting federal specifications, but emission control system performance may be affected. The malfunction indicator lamp may turn on (see “Malfunction Indicator Lamp” in the Index) and your vehicle may fail a smog-check test. If this occurs, return to your authorized GM dealer for diagnosis. If it is determined that the condition is caused by the type of fuel used, repairs may not be covered by your warranty.

Additives

Some gasolines that are not reformulated for low emissions may contain an octane-enhancing additive called methylcyclopentadienyl manganese tricarbonyl (MMT); ask the attendant where you buy gasoline whether the fuel contains MMT. General Motors does not recommend the use of such gasolines. Fuels containing MMT can reduce the life of spark plugs and the performance of the emission control system may be affected. The malfunction indicator lamp may turn on. If this occurs, return to your authorized GM dealer for service.

To provide cleaner air, all gasolines in the United States are now required to contain additives that will help prevent engine and fuel system deposits from forming, allowing your emission control system to work properly. You should not have to add anything to your fuel. Gasolines containing oxygenates, such as ethers and ethanol, and reformulated gasolines may be available in your area to contribute to clean air. General Motors recommends that you use these gasolines, particularly if they comply with the specifications described earlier.

NOTICE:

Your vehicle was not designed for fuel that contains methanol. Don't use fuel containing methanol. It can corrode metal parts in your fuel system and also damage plastic and rubber parts. That damage wouldn't be covered under your warranty.

Fuels in Foreign Countries

If you plan on driving in another country outside the United States or Canada, the proper fuel may be hard to find. Never use leaded gasoline or any other fuel not recommended in the previous text on fuel. Costly repairs caused by use of improper fuel wouldn't be covered by your warranty.

To check on fuel availability, ask an auto club, or contact a major oil company that does business in the country where you'll be driving.

Filling Your Tank

CAUTION:

Gasoline vapor is highly flammable. It burns violently, and that can cause very bad injuries. Don't smoke if you're near gasoline or refueling your vehicle. Keep sparks, flames and smoking materials away from gasoline.

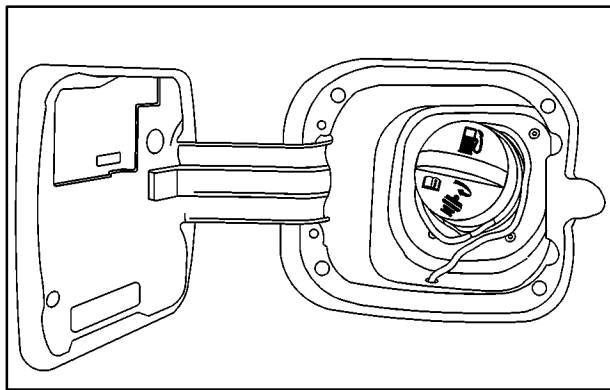

The tethered fuel cap is behind the hinged fuel door on the driver's side of your vehicle.

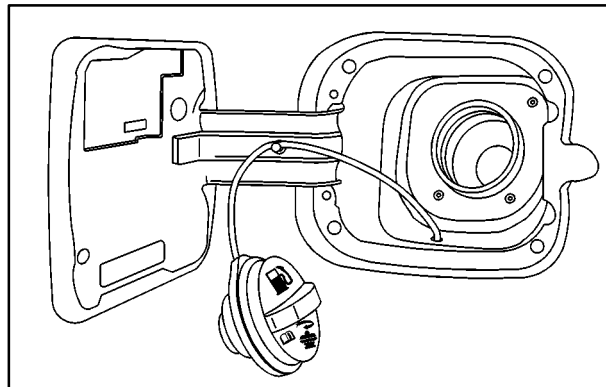

While refueling, let the fuel cap hang by the tether below the fuel fill opening.

To remove the fuel cap, turn it slowly to the left (counterclockwise). The fuel cap has a spring in it; if you let go of the cap too soon, it will spring back to the right.



CAUTION:

If you get gasoline on yourself and then something ignites it, you could be badly burned. Gasoline can spray out on you if you open the fuel cap too quickly. This spray can happen if your tank is nearly full, and is more likely in hot weather. Open the fuel cap slowly and wait for any “hiss” noise to stop. Then unscrew the cap all the way.

Be careful not to spill gasoline. Clean gasoline from painted surfaces as soon as possible. See “Cleaning the Outside of Your Vehicle” in the Index.

When you put the fuel cap back on, turn it to the right (clockwise) until you hear a clicking sound. Make sure you fully install the cap. The diagnostic system can determine if the fuel cap has been left off or improperly installed. This would allow fuel to evaporate into the atmosphere. See “Malfunction Indicator Lamp” in the Index.

NOTICE:

If you need a new fuel cap, be sure to get the right type. Your dealer can get one for you. If you get the wrong type, it may not fit properly. This may cause your malfunction indicator lamp to light and may damage your fuel tank and emissions system. See “Malfunction Indicator Lamp” in the Index.

Filling a Portable Fuel Container

CAUTION:

Never fill a portable fuel container while it is in your vehicle. Static electricity discharge from the container can ignite the gasoline vapor. You can be badly burned and your vehicle damaged if this occurs. To help avoid injury to you and others:

- Dispense gasoline only into approved containers.
- Do not fill a container while it is inside a vehicle, in a vehicle's trunk, pickup bed or on any surface other than the ground.
- Bring the fill nozzle in contact with the inside of the fill opening before operating the nozzle. Contact should be maintained until the filling is complete.
- Don't smoke while pumping gasoline.

Checking Things Under the Hood

CAUTION:

An electric fan under the hood can start up and injure you even when the engine is not running. Keep hands, clothing and tools away from any underhood electric fan.

CAUTION:

Things that burn can get on hot engine parts and start a fire. These include liquids like gasoline, oil, coolant, brake fluid, windshield washer and other fluids, and plastic or rubber. You or others could be burned. Be careful not to drop or spill things that will burn onto a hot engine.

Hood Release

To open the hood do the following:



1. Pull the handle located inside the vehicle near the parking brake.



2. Next, go to the front of the vehicle and release the secondary hood latch.
3. Lift the hood.

Engine Compartment Overview

When you open the hood of a vehicle with a 3100 V6 (Code J) engine, you'll see:

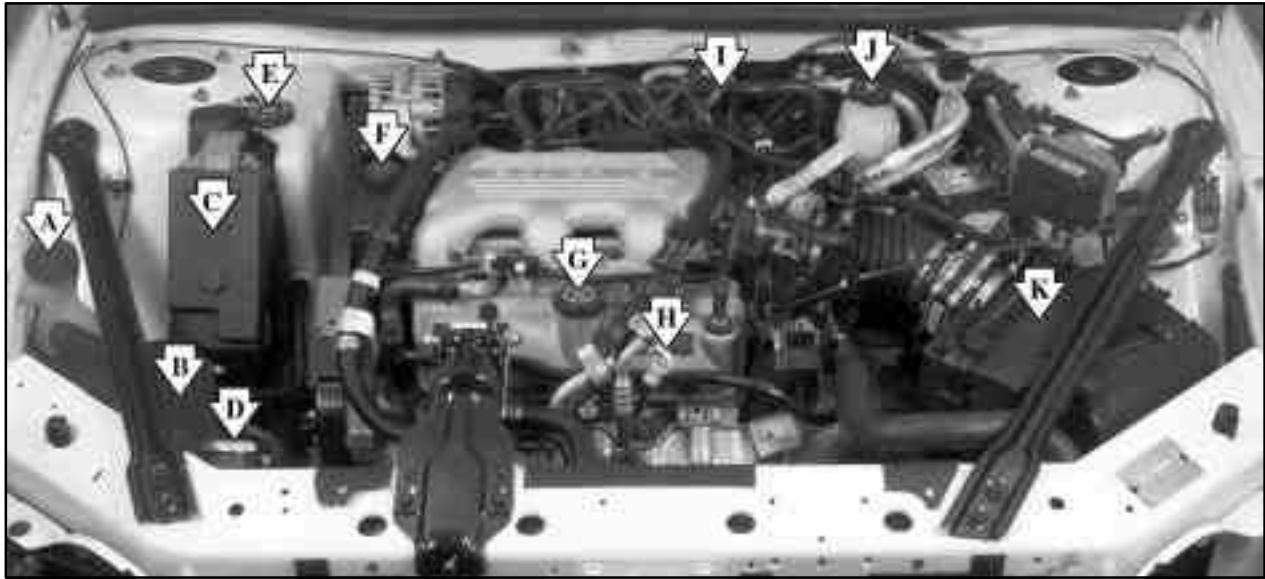

- A. Windshield Washer Fluid
- B. Battery
- C. Underhood Fuse Block
- D. Radiator Fill Cap

- E. Engine Coolant Recovery Tank
- F. Power Steering Fluid Reservoir
- G. Engine Oil Fill Cap
- H. Engine Oil Dipstick

- I. Automatic Transaxle Fluid Dipstick
- J. Brake Fluid Reservoir
- K. Engine Air Cleaner/Filter

When you open the hood of a vehicle with a the 3800 V6 (Code K) engine, you'll see:



- A. Windshield Washer Fluid
- B. Battery
- C. Underhood Fuse Block
- D. Radiator Fill Cap
- E. Engine Coolant Recovery Tank

- F. Power Steering Fluid Reservoir
(low in engine compartment)
- G. Engine Oil Dipstick
- H. Engine Oil Fill Cap

- I. Automatic Transaxle
Fluid Dipstick
- J. Brake Fluid Reservoir
- K. Engine Air Cleaner/Filter

When you open the hood of a vehicle with a 3800 V6 Supercharged (Code 1) engine, you'll see:

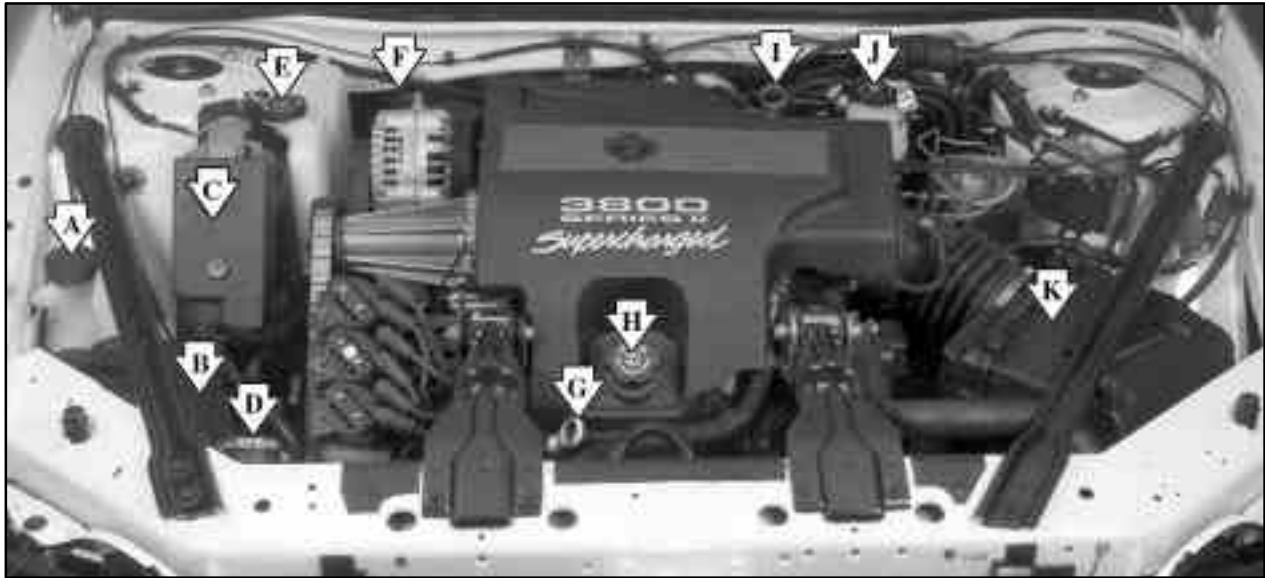

A. Windshield Washer Fluid

B. Battery

C. Underhood Fuse Block

D. Radiator Fill Cap

E. Engine Coolant Recovery Tank

F. Power Steering Fluid Reservoir
(low in engine compartment)

G. Engine Oil Dipstick

H. Engine Oil Fill Cap

I. Automatic Transaxle
Fluid Dipstick

J. Brake Fluid Reservoir

K. Engine Air Cleaner/Filter

Before closing the hood of your vehicle, be sure all the filler caps are on properly. Then pull the hood down and close it firmly.

Engine Oil

**LOW OIL
LEVEL**

If the **LOW OIL LEVEL** light appears on the instrument cluster, it means you need to check your engine oil level right away.

For more information, see “Low Oil Level Light” in the Index.

You should check your engine oil level regularly; this is an added reminder.

Checking Engine Oil

It's a good idea to check your engine oil every time you get fuel. In order to get an accurate reading, the oil must be warm and the vehicle must be on level ground.



3100 V6 Engine



**3800 V6 or 3800 V6
Supercharged Engine**

The engine oil dipstick handle is the yellow loop located near the front of the engine. See “Engine Compartment Overview” in the Index for more information on location.

Turn off the engine and give the oil several minutes to drain back into the oil pan. If you don't, the oil dipstick might not show the actual level.

Pull out the dipstick and clean it with a paper towel or cloth, then push it back in all the way. Remove it again, keeping the tip down, and check the level.

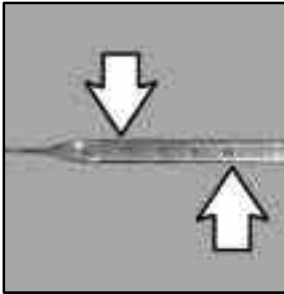

3100 V6 Engine



3800 V6 Engine or 3800 V6 Supercharged Engine

When to Add Engine Oil

If the oil is at or below the ADD mark, then you'll need to add at least one quart of oil. But you must use the right kind. This part explains what kind of oil to use. For engine oil crankcase capacity, see "Capacities and Specifications" in the Index.

NOTICE:

Don't add too much oil. If your engine has so much oil that the oil level gets above the cross-hatched area that shows the proper operating range, your engine could be damaged.



3100 V6 Engine



**3800 V6 or 3800 V6
Supercharged Engine**

The engine oil fill cap is located on the front of the engine, near the center of the engine compartment and the yellow-looped engine oil dipstick. See "Engine Compartment Overview" in the Index for more information on location.

Be sure to fill it enough to put the level somewhere in the proper operating range. Push the dipstick all the way back in when you're through.

What Kind of Engine Oil to Use

Oils recommended for your vehicle can be identified by looking for the starburst symbol.

This symbol indicates that the oil has been certified by the American Petroleum Institute (API). Do not use any oil which does not carry this starburst symbol.



If you change your own oil, be sure you use oil that has the starburst symbol on the front of the oil container. If you have your oil changed for you, be sure the oil put into your engine is American Petroleum Institute certified for gasoline engines.

You should also use the proper viscosity oil for your vehicle, as shown in the following chart:

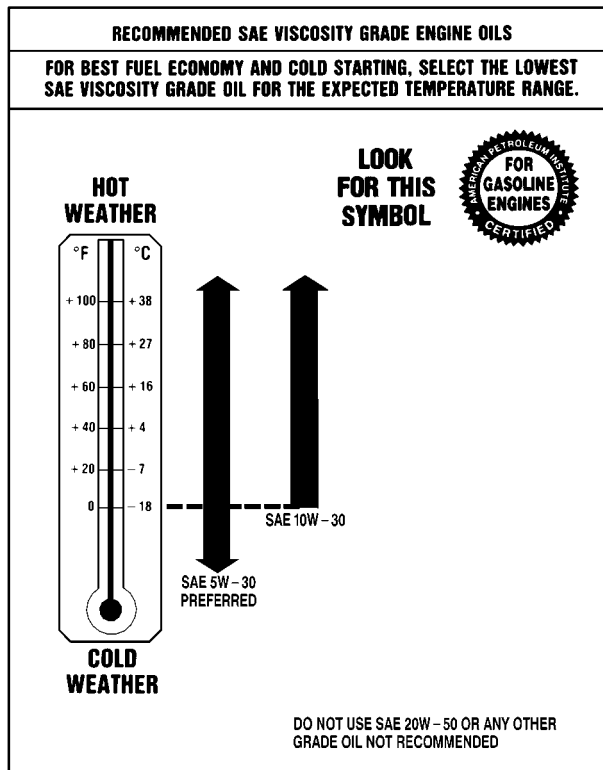

As in the chart shown previously, if you have the 3100 V6 engine, SAE 5W-30 is best for your vehicle. However, you can use SAE 10W-30 if it's going to be 0°F (-18°C) or above. These numbers on an oil container show its viscosity, or thickness. Do not use other viscosity oils, such as SAE 20W-50.

As shown in the following chart, if you have the 3800 V6 engine, SAE 10W-30 is best for your vehicle. However, you can use SAE 5W-30 if it's going to be colder than 60°F (16°C) before your next oil change. When it's very cold, you should use SAE 5W-30. These numbers on an oil container show its viscosity, or thickness. Do not use other viscosity oils, such as SAE 20W-50.

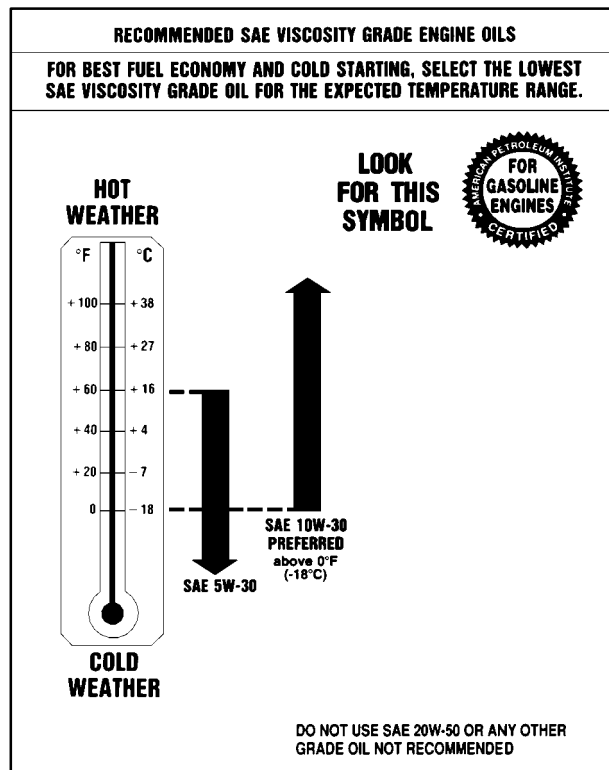

3800 V6 or 3800 V6 Supercharged Engine

NOTICE:

Use only engine oil with the American Petroleum Institute Certified For Gasoline Engines starburst symbol. Failure to use the recommended oil can result in engine damage not covered by your warranty.

GM Goodwrench[®] oil meets all the requirements for your vehicle.

If you are in an area where the temperature falls below -20°F (-29°C), consider using either an SAE 5W-30 synthetic oil or an SAE 0W-30 oil. Both will provide easier cold starting and better protection for your engine at extremely low temperatures.

Engine Oil Additives

Don't add anything to your oil. The recommended oils with the starburst symbol are all you will need for good performance and engine protection.

When to Change Engine Oil (GM Oil Life System™)

Your vehicle has a computer system that lets you know when to change the engine oil and filter. This is based on engine revolutions and engine temperature, and not on mileage. Based on driving conditions, the mileage at which an oil change will be indicated can vary considerably. For the oil life system to work properly, you must reset the system every time the oil is changed.

When the system has calculated that oil life has been diminished, it will indicate that an oil change is necessary. A CHANGE OIL SOON light will come on. Change your oil as soon as possible within the next two times you stop for fuel. It is possible that, if you are driving under the best conditions, the oil life system may not indicate that an oil change is necessary for over a year. However, your engine oil and filter must be changed at least once a year and at this time the system must be reset. It is also important to check your oil regularly and keep it at the proper level.

If the system is ever reset accidentally, you must change your oil at 3,000 miles (5 000 km) since your last oil change. Remember to reset the oil life system whenever the oil is changed.

How to Reset the GM Oil Life System™

The GM Oil Life System™ calculates when to change your engine oil and filter based on vehicle use. Anytime your oil is changed, reset the system so it can calculate when the next oil change is required. If a situation occurs where you change your oil prior to a CHANGE OIL SOON light being turned on, reset the system.

To reset the GM Oil Life System™ after the oil has been changed, use one of the following two procedures:

Using the Driver Information Center (DIC)

1. With the ignition key in RUN but the engine off, fully push and release the accelerator pedal slowly three times within five seconds.
2. If the CHANGE OIL SOON light flashes, the system is resetting.
3. Turn the key to OFF after the light stops flashing, then start the vehicle.

If the CHANGE OIL SOON light comes back on, the engine oil life monitor has not reset. Repeat the procedure.

Using the Trip Computer (If Equipped)

1. Press the MODE button until the light appears lit next to OIL LIFE.
2. Press and hold the RESET button for three seconds. The oil life percentage should change to 100%

What to Do with Used Oil

Used engine oil contains certain elements that may be unhealthy for your skin and could even cause cancer. Don't let used oil stay on your skin for very long. Clean your skin and nails with soap and water, or a good hand cleaner. Wash or properly throw away clothing or rags containing used engine oil. See the manufacturer's warnings about the use and disposal of oil products.

Used oil can be a threat to the environment. If you change your own oil, be sure to drain all the oil from the filter before disposal. Never dispose of oil by putting it in the trash, pouring it on the ground, into sewers, or into streams or bodies of water. Instead, recycle it by taking it to a place that collects used oil. If you have a problem properly disposing of your used oil, ask your dealer, a service station or a local recycling center for help.

Engine Air Cleaner/Filter

The engine air cleaner/filter is located in the front of the engine compartment on the driver's side. See "Engine Compartment Overview" in the Index for more information on location.

To check or replace the engine air cleaner/filter do the following:



1. Loosen the two clips located on the top of the engine air cleaner/filter housing and lift the filter cover tabs out of the housing.
2. Push the filter cover housing toward the engine.
3. Pull out the old filter.
4. Check or install a new engine air cleaner/filter. See "Normal Maintenance Replacement Parts" in the Index.
5. To reinstall the cover, position the tabs through the slots on the housing. A notch on the sides of the filter cover will indicate the correct placement. Reinstall the two clips on the top of the engine air cleaner/filter housing when you are finished.

Refer to the Maintenance Schedule to determine when to replace the air filter.

See "Scheduled Maintenance Services" in the Index.

⚠ CAUTION:

Operating the engine with the air cleaner/filter off can cause you or others to be burned. The air cleaner not only cleans the air, it stops flame if the engine backfires. If it isn't there, and the engine backfires, you could be burned. Don't drive with it off, and be careful working on the engine with the air cleaner/filter off.

NOTICE:

If the air cleaner/filter is off, a backfire can cause a damaging engine fire. And, dirt can easily get into your engine, which will damage it. Always have the air cleaner/filter in place when you're driving.

Supercharger Oil



The supercharger engine oil fill plug is located in the engine compartment on the front of the supercharger, on the passenger side of the vehicle.

Unless you are technically qualified and have the proper tools, you should let your dealer or a qualified service center perform this maintenance.

When to Check

Check oil level every 30,000 miles (50 000 km) or every 36 months, whichever occurs first.

What Kind of Oil to Use

Use only the recommended supercharger oil. See “Recommended Fluids and Lubricants” in the Index.

How to Check and Add Oil

Park the vehicle on a level surface. Check oil only when the engine is cold. Allow the engine to cool two to three hours after running.

CAUTION:

If you remove the supercharger oil fill plug while the engine is hot, pressure may cause hot oil to blow out of the oil fill hole. You may be burned. Do not remove the plug until the engine cools.

1. Clean the area around the oil fill plug before removing it.
2. Remove the oil fill plug using a 3/16 inch Allen wrench.
3. The oil level is correct when it just reaches the bottom of the threads of the inspection hole.
4. Replace the oil plug with the O-ring in place. Tighten to 88 lb-in (10 N·m).

Automatic Transaxle Fluid

When to Check and Change

A good time to check your automatic transaxle fluid level is when the engine oil is changed.

Change both the fluid and filter every 50,000 miles (83 000 km) if the vehicle is mainly driven under one or more of these conditions:

- In heavy city traffic where the outside temperature regularly reaches 90°F (32°C) or higher.
- In hilly or mountainous terrain.
- When doing frequent trailer towing.
- Uses such as found in taxi, police or delivery service.

If you do not use your vehicle under any of these conditions, change the fluid and filter at 100,000 miles (166 000 km).

See “Scheduled Maintenance Services” in the Index.

How to Check

Because this operation can be a little difficult, you may choose to have this done at the dealership service department.

If you do it yourself, be sure to follow all the instructions here, or you could get a false reading on the dipstick.

NOTICE:

Too much or too little fluid can damage your transaxle. Too much can mean that some of the fluid could come out and fall on hot engine parts or exhaust system parts, starting a fire. Too little fluid could cause the transaxle to overheat. Be sure to get an accurate reading if you check your transaxle fluid.

Wait at least 30 minutes before checking the transaxle fluid level if you have been driving:

- When outside temperatures are above 90°F (32°C).
- At high speed for quite a while.
- In heavy traffic -- especially in hot weather.
- While pulling a trailer.

To get the right reading, the fluid should be at normal operating temperature, which is 180°F to 200°F (82°C to 93°C).

Get the vehicle warmed up by driving about 15 miles (24 km) when outside temperatures are above 50°F (10°C). If it's colder than 50°F (10°C), you may have to drive longer.

Checking the Fluid Level

Prepare your vehicle as follows:

- Park your vehicle on a level place. Keep the engine running.
- With the parking brake applied, place the shift lever in PARK (P).
- With your foot on the brake pedal, move the shift lever through each gear range, pausing for about three seconds in each range. Then, position the shift lever in PARK (P).
- Let the engine run at idle for three to five minutes.

Then, without shutting off the engine, follow these steps:



3100 V6 Engine



**3800 V6 or 3800 V6
Supercharged Engine**

The transaxle fluid dipstick handle is the red loop located near the rear of the engine. See “Engine Compartment Overview” in the Index for more information on location.

1. Pull out the dipstick and wipe it with a clean rag or paper towel.
2. Push it back in all the way, wait three seconds and then pull it back out again.



3100 V6 Engine

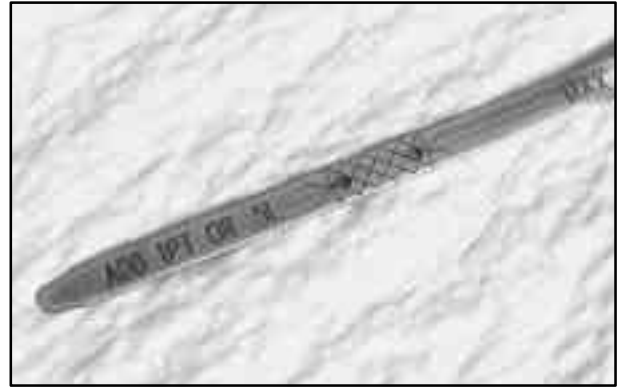

3800 V6 or 3800 V6 Supercharged Engine

3. Check both sides of the dipstick, and read the lower level. The fluid level must be in the cross-hatched area.
4. If the fluid level is in the acceptable range, push the dipstick back in all the way.

How to Add Fluid

Refer to the Maintenance Schedule to determine what kind of transaxle fluid to use. See “Recommended Fluids and Lubricants” in the Index.

If the fluid level is low, add only enough of the proper fluid to bring the level into the cross-hatched area on the dipstick.

1. Pull out the dipstick.
2. Using a long-neck funnel, add enough fluid at the dipstick hole to bring it to the proper level.

It doesn't take much fluid, generally less than one pint (0.5 L). *Don't overfill.*

NOTICE:

We recommend you use only fluid labeled DEXRON® -III, because fluid with that label is made especially for your automatic transaxle. Damage caused by fluid other than DEXRON® -III is not covered by your new vehicle warranty.

3. After adding fluid, recheck the fluid level as described under “How to Check.”
4. When the correct fluid level is obtained, push the dipstick back in all the way.

Engine Coolant

The cooling system in your vehicle is filled with DEX-COOL[®] engine coolant. This coolant is designed to remain in your vehicle for 5 years or 150,000 miles (240 000 km), whichever occurs first, if you add only DEX-COOL[®] extended life coolant.

The following explains your cooling system and how to add coolant when it is low. If you have a problem with engine overheating or if you need to add coolant to your radiator, see “Engine Overheating” in the Index.

A 50/50 mixture of clean, drinkable water and DEX-COOL[®] coolant will:

- Give freezing protection down to -34°F (-37°C).
- Give boiling protection up to 265°F (129°C).
- Protect against rust and corrosion.
- Help keep the proper engine temperature.
- Let the warning lights and gages work as they should.

NOTICE:

When adding coolant, it is important that you use only DEX-COOL[®] (silicate-free) coolant. If coolant other than DEX-COOL is added to the system, premature engine, heater core or radiator corrosion may result. In addition, the engine coolant will require change sooner -- at 30,000 miles (50 000 km) or 24 months, whichever occurs first. Damage caused by the use of coolant other than DEX-COOL[®] is not covered by your new vehicle warranty.

What to Use

Use a mixture of one-half *clean, drinkable water* and one-half DEX-COOL[®] coolant which won't damage aluminum parts. If you use this coolant mixture, you don't need to add anything else.

CAUTION:

Adding only plain water to your cooling system can be dangerous. Plain water, or some other liquid such as alcohol, can boil before the proper coolant mixture will. Your vehicle's coolant warning system is set for the proper coolant mixture. With plain water or the wrong mixture, your engine could get too hot but you wouldn't get the overheat warning. Your engine could catch fire and you or others could be burned. Use a 50/50 mixture of clean, drinkable water and DEX-COOL[®] coolant.

NOTICE:

If you use an improper coolant mixture, your engine could overheat and be badly damaged. The repair cost wouldn't be covered by your warranty. Too much water in the mixture can freeze and crack the engine, radiator, heater core and other parts.

If you have to add coolant more than four times a year, have your dealer check your cooling system.

NOTICE:

If you use the proper coolant, you don't have to add extra inhibitors or additives which claim to improve the system. These can be harmful.

Checking Coolant



The coolant recovery tank is located in the engine compartment toward the rear of the engine on the passenger's side of the vehicle. See "Engine Compartment Overview" in the Index for more information on location.

The vehicle must be on a level surface. When your engine is cold, the coolant level should be at the COLD mark or a little higher. When your engine is warm, the level should be up to the HOT mark or a little higher.

**LOW
COOLANT**

If this LOW COOLANT light comes on and stays on, it means you're low on engine coolant.

Adding Coolant

If you need more coolant, add the proper DEX-COOL[®] coolant mixture *at the coolant recovery tank*, but be careful not to spill it.

If the coolant recovery tank is completely empty, add coolant to the radiator. See “Engine Overheating” in the Index.

CAUTION:

Turning the radiator pressure cap when the engine and radiator are hot can allow steam and scalding liquids to blow out and burn you badly. With the coolant recovery tank, you will almost never have to add coolant at the radiator. Never turn the radiator pressure cap -- even a little -- when the engine and radiator are hot.

CAUTION:

You can be burned if you spill coolant on hot engine parts. Coolant contains ethylene glycol, and it will burn if the engine parts are hot enough. Don't spill coolant on a hot engine.

Occasionally check the coolant level in the radiator. For information on how to add coolant to the radiator, see “Cooling System” in the Index.

Radiator Pressure Cap

The radiator pressure cap is located in the front of the engine compartment on the passenger's side, near the diagonal cross brace and the battery. See "Engine Compartment Overview" in the Index for more information on location.

NOTICE:

Your radiator cap is a 15 psi (105 kPa) pressure-type cap and must be tightly installed to prevent coolant loss and possible engine damage from overheating. Be sure the arrows on the cap line up with the overflow tube on the radiator filler neck.

Power Steering Fluid

The power steering fluid reservoir is located in the engine compartment next to the engine coolant recovery tank. In the 3800 V6 (Code K) engine and the 3800 V6 Supercharged (Code I) engine, the power steering fluid reservoir sits low in the engine compartment. See "Engine Compartment Overview" in the Index.



3100 V6 Engine



3800 V6 or 3800 V6 Supercharged Engine

When to Check Power Steering Fluid

It is not necessary to regularly check power steering fluid unless you suspect there is a leak in the system or you hear an unusual noise. A fluid loss in this system could indicate a problem. Have the system inspected and repaired. See “Engine Compartment Overview” in the Index for reservoir location.

How to Check Power Steering Fluid

Turn the key off, let the engine compartment cool down, wipe the cap and the top of the reservoir clean, then unscrew the cap and wipe the dipstick with a clean rag. Replace the cap and completely tighten it. Then remove the cap again and look at the fluid level on the dipstick.

The level should be at the C (3100 V6 engine) or COLD (3800 V6 and 3800 V6 Supercharged engines) mark. If necessary, add only enough fluid to bring the level up to the mark.



3100 V6 Engine



3800 V6 or 3800 V6 Supercharged Engine

When the engine compartment is hot, the level should be at the H (3100 V6 engine) or HOT (3800 V6 and 3800 V6 Supercharged engines) mark. If the fluid is at the ADD mark, you should add fluid.

What to Use

To determine what kind of fluid to use, see “Recommended Fluids and Lubricants” in the Index. Always use the proper fluid. Failure to use the proper fluid can cause leaks and damage hoses and seals.

Windshield Washer Fluid

What to Use

When you need windshield washer fluid, be sure to read the manufacturer’s instructions before use. If you will be operating your vehicle in an area where the temperature may fall below freezing, use a fluid that has sufficient protection against freezing. See “Engine Compartment Overview” in the Index for reservoir location.

Adding Washer Fluid

The windshield washer fluid reservoir is located in the engine compartment on the passenger's side of the vehicle near the diagonal cross brace.

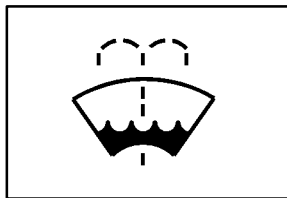

Open the cap with the washer symbol on it. Add washer fluid until the tank is full.

NOTICE:

- **When using concentrated washer fluid, follow the manufacturer's instructions for adding water.**
- **Don't mix water with ready-to-use washer fluid. Water can cause the solution to freeze and damage your washer fluid tank and other parts of the washer system. Also, water doesn't clean as well as washer fluid.**
- **Fill your washer fluid tank only three-quarters full when it's very cold. This allows for expansion if freezing occurs, which could damage the tank if it is completely full.**
- **Don't use engine coolant (antifreeze) in your windshield washer. It can damage your washer system and paint.**

Brakes

Brake Fluid



Your brake master cylinder reservoir is on the driver's side of the engine compartment. It is filled with DOT-3 brake fluid. See "Engine Compartment Overview" in the Index.

There are only two reasons why the brake fluid level in the reservoir might go down. The first is that the brake fluid goes down to an acceptable level during normal brake lining wear. When new linings are put in, the fluid level

goes back up. The other reason is that fluid is leaking out of the brake system. If it is, you should have your brake system fixed, since a leak means that sooner or later your brakes won't work well, or won't work at all.

So, it isn't a good idea to "top off" your brake fluid. Adding brake fluid won't correct a leak. If you add fluid when your linings are worn, then you'll have too much fluid when you get new brake linings. You should add (or remove) brake fluid, as necessary, only when work is done on the brake hydraulic system.

CAUTION:

If you have too much brake fluid, it can spill on the engine. The fluid will burn if the engine is hot enough. You or others could be burned, and your vehicle could be damaged. Add brake fluid only when work is done on the brake hydraulic system.

When your brake fluid falls to a low level, your brake warning light will come on. See "Brake System Warning Light" in the Index.

What to Add

When you do need brake fluid, use only DOT-3 brake fluid. Use new brake fluid from a sealed container only. See “Recommended Fluids and Lubricants” in the Index.

Always clean the brake fluid reservoir cap and the area around the cap before removing it. This will help keep dirt from entering the reservoir.

CAUTION:

With the wrong kind of fluid in your brake system, your brakes may not work well, or they may not even work at all. This could cause a crash. Always use the proper brake fluid.

NOTICE:

- **Using the wrong fluid can badly damage brake system parts. For example, just a few drops of mineral-based oil, such as engine oil, in your brake system can damage brake system parts so badly that they’ll have to be replaced. Don’t let someone put in the wrong kind of fluid.**
- **If you spill brake fluid on your vehicle’s painted surfaces, the paint finish can be damaged. Be careful not to spill brake fluid on your vehicle. If you do, wash it off immediately. See “Appearance Care” in the Index.**

Brake Wear

Your vehicle has four-wheel disc brakes.

Disc brake pads have built-in wear indicators that make a high-pitched warning sound when the brake pads are worn and new pads are needed. The sound may come and go or be heard all the time your vehicle is moving (except when you are pushing on the brake pedal firmly).

CAUTION:

The brake wear warning sound means that soon your brakes won't work well. That could lead to an accident. When you hear the brake wear warning sound, have your vehicle serviced.

NOTICE:

Continuing to drive with worn-out brake pads could result in costly brake repair.

Some driving conditions or climates may cause a brake squeal when the brakes are first applied or lightly applied. This does not mean something is wrong with your brakes.

Properly torqued wheel nuts are necessary to help prevent brake pulsation. When tires are rotated, inspect brake pads for wear and evenly tighten wheel nuts in the proper sequence to GM torque specifications.

Brake linings should always be replaced as complete axle sets.

See “Brake System Inspection” in Section 7 of this manual under Part C “Periodic Maintenance Inspections.”

Brake Pedal Travel

See your dealer if the brake pedal does not return to normal height, or if there is a rapid increase in pedal travel. This could be a sign of brake trouble.

Brake Adjustment

Every time you apply the brakes, with or without the vehicle moving, your brakes adjust for wear.

Replacing Brake System Parts

The braking system on a vehicle is complex. Its many parts have to be of top quality and work well together if the vehicle is to have really good braking. Your vehicle was designed and tested with top-quality GM brake parts. When you replace parts of your braking system -- for example, when your brake linings wear down and you need new ones put in -- be sure you get new approved GM replacement parts. If you don't, your brakes may no longer work properly. For example, if someone puts in brake linings that are wrong for your vehicle, the balance between your front and rear brakes can change -- for the worse. The braking performance you've come to expect can change in many other ways if someone puts in the wrong replacement brake parts.

Battery

Your new vehicle comes with a maintenance free ACDelco® battery. When it's time for a new battery, get one that has the replacement number shown on the original battery's label. We recommend an ACDelco battery. See "Engine Compartment Overview" in the Index for battery location.

WARNING: Battery posts, terminals and related accessories contain lead and lead compounds, chemicals known to the State of California to cause cancer and reproductive harm. Wash hands after handling.

If your battery has a very low charge or is dead, you may not be able to remove the ignition key from the ignition switch or shift out of PARK (P). Refer to "Shifting Out of PARK(P)" in the Index.

Vehicle Storage

If you're not going to drive your vehicle for 25 days or more, remove the black, negative (-) cable from the battery. This will help keep your battery from running down.



CAUTION:

Batteries have acid that can burn you and gas that can explode. You can be badly hurt if you aren't careful. See "Jump Starting" in the Index for tips on working around a battery without getting hurt.

Contact your dealer to learn how to prepare your vehicle for longer storage periods.

Also, for your audio system, see "Theft-Deterrent Feature" in the Index.

Bulb Replacement

For the proper type of replacement bulb, see “Replacement Bulbs” in the Index.

For any bulb changing procedure not listed in this section, contact your dealer.

Halogen Bulbs

CAUTION:

Halogen bulbs have pressurized gas inside and can burst if you drop or scratch the bulb. You or others could be injured. Be sure to read and follow the instructions on the bulb package.

Headlamps

1. Open the hood.



2. Remove the two bolts from the top of the headlamp assembly.



3. Carefully remove the headlamp assembly from the vehicle. Be careful to avoid scratching or chipping the paint on the vehicle while removing.
4. Lift the plastic tab on the electrical connector and pull the connector out.



5. Turn the lamp socket ring a quarter turn counterclockwise to remove it from the headlamp assembly.



6. Pull the old bulb from the socket.
7. Place the new bulb into the socket.
8. Turn the lamp socket ring a quarter turn clockwise to place it back into the headlamp assembly.
9. Lift the plastic tab on the electrical connector and reinstall the connector.
10. Carefully reinstall the headlamp assembly. Be careful to avoid scratching or chipping the paint on the vehicle while reinstalling the assembly.
11. Reinstall the two bolts on the top of the headlamp assembly.
12. Close the hood.

Headlamp Aiming

The aim of your vehicle's headlamps can be adjusted by using aim tips located on the outer surface of the lens. The aim has been pre-set at the factory and should need no further adjustment.

If your vehicle is damaged in an accident, the headlamp aim may be affected. Aim adjustment to the low beam may be necessary if it is difficult to see lane markers (for horizontal aim), or if oncoming drivers flash their high beams at you (for vertical aim). If you believe your headlamps need to be re-aimed, it is recommended that you take your vehicle to the dealer for assistance.

Front Turn Signal and Front Sidemarker

1. Open the hood.



2. Remove the two bolts from the top of the headlamp assembly.
3. Remove the headlamp assembly from the vehicle. Be careful to avoid scratching or chipping the paint on the vehicle while removing it.
4. Turn the front sidemarker bulb socket a quarter turn counterclockwise to remove.



5. Remove the old bulb from the socket.
6. Place the new bulb into the socket.
7. Turn the bulb socket a quarter turn clockwise to reinstall it.
8. Carefully reinstall the headlamp assembly.
Be careful to avoid scratching or chipping the paint on the vehicle.
9. Reinstall the two bolts on the top of the headlamp assembly.
10. Close the hood.

Center High-Mounted Stoplamp (CHMSL)

1. Open the trunk.



2. Reach through the access opening in the trunk and remove the slotted vent by squeezing the ends and pulling down.



3. Remove old the bulb by turning it a quarter turn counterclockwise.
4. Place the new bulb into the bulb socket.
5. Turn the bulb a quarter turn clockwise. Reinstall the vent.
6. Close the trunk.

Back-Up, Tail Lamp and Rear Sidemarker

1. Open the trunk.
2. Unhook the convenience net (if equipped) and remove it.



3. Unscrew the upper convenience net hook attachment.
4. Pull the trunk trim carpeting away from the rear of the trunk.
5. Remove the upper trunk trim hook and the two plastic wing nuts from the taillamp.



6. Carefully remove the taillamp assembly. Be careful to avoid scratching or chipping the paint on the vehicle.



7. Turn the lamp socket a quarter turn counterclockwise to remove.



8. Remove the old bulb.
9. Place the new bulb into the socket.
10. Turn the lamp socket a quarter turn clockwise to reinstall it.
11. Carefully reinstall the taillamp assembly by reversing Steps 1 through 5. Be careful to avoid scratching or chipping the vehicle's paint.
12. Close the rear compartment.

Windshield Wiper Blade Replacement

Windshield wiper blades should be inspected at least twice a year for wear or cracking. See “Windshield Wipers, Blade Check” in the Index for more information.

Replacement blades come in different types and are removed in different ways. For the proper type and length, see “Normal Maintenance and Replacement Parts” in the Index.

To remove the wiper blade do the following:



1. Pull the windshield wiper arm away from the windshield.
2. Push the release lever and slide the wiper assembly toward the driver's side of the vehicle.
3. Install a new blade by reversing Steps 1 and 2.

Tires

Your new vehicle comes with high-quality tires made by a leading tire manufacturer. If you ever have questions about your tire warranty and where to obtain service, see your Pontiac Warranty booklet for details.



CAUTION:

Poorly maintained and improperly used tires are dangerous.

- **Overloading your tires can cause overheating as a result of too much friction. You could have an air-out and a serious accident. See “Loading Your Vehicle” in the Index.**

CAUTION: (Continued)

CAUTION: (Continued)

- **Underinflated tires pose the same danger as overloaded tires. The resulting accident could cause serious injury. Check all tires frequently to maintain the recommended pressure. Tire pressure should be checked when your tires are cold.**
- **Overinflated tires are more likely to be cut, punctured or broken by a sudden impact -- such as when you hit a pothole. Keep tires at the recommended pressure.**
- **Worn, old tires can cause accidents. If your tread is badly worn, or if your tires have been damaged, replace them.**

Inflation -- Tire Pressure

The Tire-Loading Information label, which is on the inside of the trunk lid, shows the correct inflation pressures for your tires when they're cold. "Cold" means your vehicle has been sitting for at least three hours or driven no more than 1 mile (1.6 km).

NOTICE:

Don't let anyone tell you that underinflation or overinflation is all right. It's not. If your tires don't have enough air (underinflation), you can get the following:

- Too much flexing
- Too much heat
- Tire overloading
- Bad wear
- Bad handling
- Bad fuel economy

NOTICE: (Continued)

NOTICE: (Continued)

If your tires have too much air (overinflation), you can get the following:

- Unusual wear
- Bad handling
- Rough ride
- Needless damage from road hazards

When to Check

Check your tires once a month or more.

Don't forget your compact spare tire. It should be at 60 psi (420 kPa).

How to Check

Use a good quality pocket-type gage to check tire pressure. You can't tell if your tires are properly inflated simply by looking at them. Radial tires may look properly inflated even when they're underinflated.

Be sure to put the valve caps back on the valve stems. They help prevent leaks by keeping out dirt and moisture.

Tire Inspection and Rotation

Tires should be rotated every 6,000 to 8,000 miles (10 000 to 13 000 km). Any time you notice unusual wear, rotate your tires as soon as possible and check wheel alignment. Also check for damaged tires or wheels. See “When It’s Time for New Tires” and “Wheel Replacement” later in this section for more information.

The purpose of regular rotation is to achieve more uniform wear for all tires on the vehicle. The first rotation is the most important. See “Scheduled Maintenance Services” in the Index for scheduled rotation intervals.

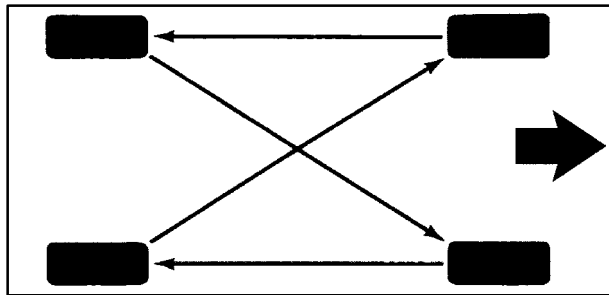

When rotating your tires, always use the correct rotation pattern shown here.

Don't include the compact spare tire in your tire rotation.

After the tires have been rotated, adjust the front and rear inflation pressures as shown on the Tire-Loading Information label. Make certain that all wheel nuts are properly tightened. See “Wheel Nut Torque” in the Index.

CAUTION:

Rust or dirt on a wheel, or on the parts to which it is fastened, can make wheel nuts become loose after a time. The wheel could come off and cause an accident. When you change a wheel, remove any rust or dirt from places where the wheel attaches to the vehicle. In an emergency, you can use a cloth or a paper towel to do this; but be sure to use a scraper or wire brush later, if you need to, to get all the rust or dirt off. See “Changing a Flat Tire” in the Index.

When It's Time for New Tires

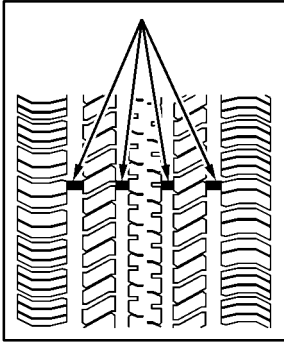

One way to tell when it's time for new tires is to check the treadwear indicators, which will appear when your tires have only 1/16 inch (1.6 mm) or less of tread remaining.

You need a new tire if any of the following statements are true:

- You can see the indicators at three or more places around the tire.
- You can see cord or fabric showing through the tire's rubber.
- The tread or sidewall is cracked, cut or snagged deep enough to show cord or fabric.
- The tire has a bump, bulge or split.
- The tire has a puncture, cut or other damage that can't be repaired well because of the size or location of the damage.

Buying New Tires

To find out what kind and size of tires you need, look at the Tire-Loading Information label.

The tires installed on your vehicle when it was new had a Tire Performance Criteria Specification (TPC Spec) number on each tire's sidewall. When you get new tires, get ones with that same TPC Spec number. That way your vehicle will continue to have tires that are designed to give proper endurance, handling, speed rating, traction, ride and other things during normal service on your vehicle. If your tires have an all-season tread design, the TPC number will be followed by an "MS" (for mud and snow).

If you ever replace your tires with those not having a TPC Spec number, make sure they are the same size, load range, speed rating and construction type (bias, bias-belted or radial) as your original tires.

CAUTION:

Mixing tires could cause you to lose control while driving. If you mix tires of different sizes or types (radial and bias-belted tires), the vehicle may not handle properly, and you could have a crash.

Using tires of different sizes may also cause damage to your vehicle. Be sure to use the same size and type tires on all wheels.

It's all right to drive with your compact spare, though. It was developed for use on your vehicle.

CAUTION:

If you use bias-ply tires on your vehicle, the wheel rim flanges could develop cracks after many miles of driving. A tire and/or wheel could fail suddenly, causing a crash. Use only radial-ply tires with the wheels on your vehicle.

Uniform Tire Quality Grading

Quality grades can be found where applicable on the tire sidewall between tread shoulder and maximum section width. For example:

Treadwear 200 Traction AA Temperature A

The following information relates to the system developed by the United States National Highway Traffic Safety Administration, which grades tires by treadwear, traction and temperature performance.

(This applies only to vehicles sold in the United States.)

The grades are molded on the sidewalls of most passenger car tires. The Uniform Tire Quality Grading system does not apply to deep tread, winter-type snow tires, space-saver or temporary use spare tires, tires with nominal rim diameters of 10 to 12 inches (25 to 30 cm), or to some limited-production tires.

While the tires available on General Motors passenger cars and light trucks may vary with respect to these grades, they must also conform to federal safety requirements and additional General Motors Tire Performance Criteria (TPC) standards.

Treadwear

The treadwear grade is a comparative rating based on the wear rate of the tire when tested under controlled conditions on a specified government test course. For example, a tire graded 150 would wear one and a half (1 1/2) times as well on the government course as a tire graded 100. The relative performance of tires depends upon the actual conditions of their use, however, and may depart significantly from the norm due to variations in driving habits, service practices and differences in road characteristics and climate.

Traction -- AA, A, B, C

The traction grades, from highest to lowest, are AA, A, B, and C. Those grades represent the tire's ability to stop on wet pavement as measured under controlled conditions on specified government test surfaces of asphalt and concrete. A tire marked C may have poor traction performance. Warning: The traction grade assigned to this tire is based on straight-ahead braking traction tests, and does not include acceleration, cornering, hydroplaning, or peak traction characteristics.

Temperature -- A, B, C

The temperature grades are A (the highest), B, and C, representing the tire's resistance to the generation of heat and its ability to dissipate heat when tested under controlled conditions on a specified indoor laboratory test wheel. Sustained high temperature can cause the material of the tire to degenerate and reduce tire life, and excessive temperature can lead to sudden tire failure. The grade C corresponds to a level of performance which all passenger car tires must meet under the Federal Motor Vehicle Safety Standard No. 109. Grades B and A represent higher levels of performance on the laboratory test wheel than the minimum required by law.

Warning: The temperature grade for this tire is established for a tire that is properly inflated and not overloaded. Excessive speed, underinflation, or excessive loading, either separately or in combination, can cause heat buildup and possible tire failure.

Wheel Alignment and Tire Balance

The wheels on your vehicle were aligned and balanced carefully at the factory to give you the longest tire life and best overall performance.

Scheduled wheel alignment and wheel balancing are not needed. However, if you notice unusual tire wear or your vehicle pulling one way or the other, the alignment may need to be reset. If you notice your vehicle vibrating when driving on a smooth road, your wheels may need to be rebalanced.

Wheel Replacement

Replace any wheel that is bent, cracked, or badly rusted or corroded. If wheel nuts keep coming loose, the wheel, wheel bolts and wheel nuts should be replaced. If the wheel leaks air, replace it (except some aluminum wheels, which can sometimes be repaired). See your dealer if any of these conditions exist.

Your dealer will know the kind of wheel you need.

Each new wheel should have the same load-carrying capacity, diameter, width, offset and be mounted the same way as the one it replaces.

If you need to replace any of your wheels, wheel bolts or wheel nuts, replace them only with new GM original equipment parts. This way, you will be sure to have the right wheel, wheel bolts and wheel nuts for your vehicle.

 **CAUTION:**

Using the wrong replacement wheels, wheel bolts or wheel nuts on your vehicle can be dangerous. It could affect the braking and handling of your vehicle, make your tires lose air and make you lose control. You could have a collision in which you or others could be injured. Always use the correct wheel, wheel bolts and wheel nuts for replacement.

NOTICE:

The wrong wheel can also cause problems with bearing life, brake cooling, speedometer or odometer calibration, headlamp aim, bumper height, vehicle ground clearance and tire or tire chain clearance to the body and chassis.

See “Changing a Flat Tire” in the Index for more information.

Used Replacement Wheels

 **CAUTION:**

Putting a used wheel on your vehicle is dangerous. You can't know how it's been used or how far it's been driven. It could fail suddenly and cause a crash. If you have to replace a wheel, use a new GM original equipment wheel.

Tire Chains

CAUTION:

If your vehicle is an SE model with P225/60R16 size tires, don't use tire chains, there's not enough clearance.

Tire chains used on a vehicle without the proper amount of clearance can cause damage to the brakes, suspension or other vehicle parts. The area damaged by the tire chains could cause you to lose control of your vehicle and you or others may be injured in a crash.

Use another type of traction device only if its manufacturer recommends it for use on your vehicle and tire size combination and road conditions. Follow that manufacturer's instructions. To help avoid damage to your vehicle, drive slowly, readjust or remove the device if it's contacting your vehicle, and don't spin your wheels.

If you do find traction devices that will fit, install them on the front tires.

NOTICE:

If your vehicle is a GT model, a GTP model or if you have an SE model without P225/60R16 size tires, use tire chains only where legal and only when you must. Use only SAE Class "S" type chains that are the proper size for your tires. Install them on the front tires and tighten them as tightly as possible with the ends securely fastened. Drive slowly and follow the chain manufacturer's instructions. If you can hear the chains contacting your vehicle, stop and retighten them. If the contact continues, slow down until it stops. Driving too fast or spinning the wheels with chains on will damage your vehicle.

Appearance Care

Remember, cleaning products can be hazardous. Some are toxic. Others can burst into flame if you strike a match or get them on a hot part of the vehicle. Some are dangerous if you breathe their fumes in a closed space. When you use anything from a container to clean your vehicle, be sure to follow the manufacturer's warnings and instructions. And always open your doors or windows when you're cleaning the inside.

Never use these to clean your vehicle:

- Gasoline
- Benzene
- Naphtha
- Carbon Tetrachloride
- Acetone
- Paint Thinner
- Turpentine
- Lacquer Thinner
- Nail Polish Remover

They can all be hazardous -- some more than others -- and they can all damage your vehicle, too.

Don't use any of these unless this manual says you can. In many uses, these will damage your vehicle:

- Alcohol
- Laundry Soap
- Bleach
- Reducing Agents

Cleaning the Inside of Your Vehicle

Use a vacuum cleaner often to get rid of dust and loose dirt. Wipe vinyl, leather, plastic and painted surfaces with a clean, damp cloth.

Cleaning of Fabric/Carpet

Your dealer has cleaners for the cleaning of fabric and carpet. They will clean normal spots and stains very well. You can get GM-approved cleaning products from your dealer. See “Appearance Care and Materials” in the Index.

Here are some cleaning tips:

- Always read the instructions on the cleaner label.
- Clean up stains as soon as you can -- before they set.
- Carefully scrape off any excess stain.
- Use a clean cloth or sponge, and change to a clean area often. A soft brush may be used if stains are stubborn.
- If a ring forms on fabric after spot cleaning, clean the entire area immediately or it will set.

Using Cleaner on Fabric

1. Vacuum and brush the area to remove any loose dirt.
2. Always clean a whole trim panel or section. Mask surrounding trim along stitch or welt lines.
3. Follow the directions on the container label.
4. Apply cleaner with a clean sponge. Don't saturate the material and don't rub it roughly.
5. As soon as you've cleaned the section, use a sponge to remove any excess cleaner.
6. Wipe cleaned area with a clean, water-dampened towel or cloth.
7. Wipe with a clean cloth and let dry.

Special Fabric Cleaning Problems

Stains caused by such things as catsup, coffee (black), egg, fruit, fruit juice, milk, soft drinks, vomit, urine and blood can be removed as follows:

1. Carefully scrape off excess stain, then sponge the soiled area with cool water.
2. If a stain remains, follow the cleaner instructions described earlier.
3. If an odor lingers after cleaning vomit or urine, treat the area with a water/baking soda solution: 1 teaspoon (5 ml) of baking soda to 1 cup (250 ml) of lukewarm water.
4. Let dry.

Stains caused by candy, ice cream, mayonnaise, chili sauce and unknown stains can be removed as follows:

1. Carefully scrape off excess stain.
2. First, clean with cool water and allow to dry completely.
3. If a stain remains, follow the cleaner instructions described earlier.

Cleaning Vinyl

Use warm water and a clean cloth.

- Rub with a clean, damp cloth to remove dirt. You may have to do it more than once.
- Things like tar, asphalt and shoe polish will stain if you don't get them off quickly. Use a clean cloth and a vinyl/leather cleaner. See your dealer for this product.

Cleaning Leather

Use a soft cloth with lukewarm water and a mild soap or saddle soap and wipe dry with a soft cloth. Then, let the leather dry naturally. Do not use heat to dry.

- For stubborn stains, use a leather cleaner. See your dealer for this product.
- *Never* use oils, varnishes, solvent-based or abrasive cleaners, furniture polish or shoe polish on leather.
- Soiled or stained leather should be cleaned immediately. If dirt is allowed to work into the finish, it can harm the leather.

Cleaning the Top of the Instrument Panel

Use only mild soap and water to clean the top surfaces of the instrument panel. Sprays containing silicones or waxes may cause annoying reflections in the windshield and even make it difficult to see through the windshield under certain conditions.

Cleaning Interior Plastic Components

Use only a mild soap and water solution on a soft cloth or sponge. Commercial cleaners may affect the surface finish.

Care of Safety Belts

Keep belts clean and dry.

CAUTION:

Do not bleach or dye safety belts. If you do, it may severely weaken them. In a crash, they might not be able to provide adequate protection. Clean safety belts only with mild soap and lukewarm water.

Cleaning Glass Surfaces

Glass should be cleaned often. GM Glass Cleaner or a liquid household glass cleaner will remove normal tobacco smoke and dust films on interior glass. See “Appearance Care and Materials” in the Index.

NOTICE:

Don't use abrasive cleaners on glass, because they may cause scratches. Avoid placing decals on the inside rear window, since they may have to be scraped off later. If abrasive cleaners are used on the inside of the rear window, an electric defogger element may be damaged. Any temporary license should not be attached across the defogger grid.

Cleaning the Outside of the Windshield and Wiper Blades

If the windshield is not clear after using the windshield washer, or if the wiper blade chatters when running, wax, sap or other material may be on the blade or windshield.

Clean the outside of the windshield with a full-strength glass cleaning liquid. The windshield is clean if beads do not form when you rinse it with water.

Grime from the windshield will stick to the wiper blades and affect their performance. Clean the blade by wiping vigorously with a cloth soaked in full-strength windshield washer solvent. Then rinse the blade with water.

Check the wiper blades and clean them as necessary; replace blades that look worn.

Weatherstrips

Silicone grease on weatherstrips will make them last longer, seal better, and not stick or squeak. Apply silicone grease with a clean cloth at least every six months. During very cold, damp weather more frequent application may be required. See “Recommended Fluids and Lubricants” in the Index.

Cleaning the Outside of Your Vehicle

The paint finish on your vehicle provides beauty, depth of color, gloss retention and durability.

Washing Your Vehicle

The best way to preserve your vehicle’s finish is to keep it clean by washing it often with lukewarm or cold water.

Don’t wash your vehicle in the direct rays of the sun. Use a car washing soap. Don’t use strong soaps or chemical detergents. Be sure to rinse the vehicle well, removing all soap residue completely. You can get GM-approved cleaning products from your dealer. See “Appearance Care and Materials” in the Index. Don’t use cleaning agents that are petroleum based, or that contain acid or abrasives. All cleaning agents should be flushed promptly and not allowed to dry on the surface, or they could stain. Dry the finish with a soft, clean chamois or an all-cotton towel to avoid surface scratches and water spotting.

High pressure car washes may cause water to enter your vehicle.

Cleaning Exterior Lamps/Lenses

Use only lukewarm or cold water, a soft cloth and a car washing soap to clean exterior lamps and lenses. Follow instructions under “Washing Your Vehicle.”

Finish Care

Occasional waxing or mild polishing of your vehicle by hand may be necessary to remove residue from the paint finish. You can get GM-approved cleaning products from your dealer. See “Appearance Care and Materials” in the Index.

Your vehicle has a “basecoat/clearcoat” paint finish. The clearcoat gives more depth and gloss to the colored basecoat. Always use waxes and polishes that are non-abrasive and made for a basecoat/clearcoat paint finish.

NOTICE:

Machine compounding or aggressive polishing on a basecoat/clearcoat paint finish may dull the finish or leave swirl marks.

Foreign materials such as calcium chloride and other salts, ice melting agents, road oil and tar, tree sap, bird droppings, chemicals from industrial chimneys, etc., can damage your vehicle’s finish if they remain on painted surfaces. Wash the vehicle as soon as possible. If necessary, use non-abrasive cleaners that are marked safe for painted surfaces to remove foreign matter.

Exterior painted surfaces are subject to aging, weather and chemical fallout that can take their toll over a period of years. You can help to keep the paint finish looking new by keeping your vehicle garaged or covered whenever possible.

Cleaning Aluminum Wheels Chrome-Plated Wheels (If Equipped)

Keep your wheels clean using a soft clean cloth with mild soap and water. Rinse with clean water. After rinsing thoroughly, dry with a soft clean towel. A wax may then be applied.

The surface of these wheels is similar to the painted surface of your vehicle. Don't use strong soaps, chemicals, abrasive polishes, abrasive cleaners, cleaners with acid or abrasive cleaning brushes on them because you could damage the surface. Do not use chrome polish on aluminum wheels.

Use chrome polish only on chrome-plated wheels, but avoid any painted surface of the wheel, and buff off immediately after application.

Don't take your vehicle through an automatic car wash that has silicon carbide tire cleaning brushes. These brushes can also damage the surface of these wheels.

Cleaning Tires

To clean your tires, use a stiff brush with a tire cleaner.

NOTICE:

When applying a tire dressing always take care to wipe off any overspray or splash from all painted surfaces on the body or wheels of the vehicle. Petroleum-based products may damage the paint finish and tires.

Sheet Metal Damage

If your vehicle is damaged and requires sheet metal repair or replacement, make sure the body repair shop applies anti-corrosion material to the parts repaired or replaced to restore corrosion protection.

Original manufacturer replacement parts will provide the corrosion protection while maintaining the warranty.

Finish Damage

Any stone chips, fractures or deep scratches in the finish should be repaired right away. Bare metal will corrode quickly and may develop into a major repair expense.

Minor chips and scratches can be repaired with touch-up materials available from your dealer or other service outlets. Larger areas of finish damage can be corrected in your dealer's body and paint shop.

Underbody Maintenance

Chemicals used for ice and snow removal and dust control can collect on the underbody. If these are not removed, accelerated corrosion (rust) can occur on the underbody parts such as fuel lines, frame, floor pan and exhaust system even though they have corrosion protection.

At least every spring, flush these materials from the underbody with plain water. Clean any areas where mud and other debris can collect. Dirt packed in closed areas of the frame should be loosened before being flushed. Your dealer or an underbody car washing system can do this for you.

Chemical Paint Spotting

Some weather and atmospheric conditions can create a chemical fallout. Airborne pollutants can fall upon and attack painted surfaces on your vehicle. This damage can take two forms: blotchy, ringlet-shaped discolorations, and small irregular dark spots etched into the paint surface.

Although no defect in the paint job causes this, Pontiac will repair, at no charge to the owner, the surfaces of new vehicles damaged by this fallout condition within 12 months or 12,000 miles (20 000 km) of purchase, whichever occurs first.

GM Vehicle Care/Appearance Materials

PART NUMBER	SIZE	DESCRIPTION	USAGE
994954	23 in. x 25 in.	Polishing Cloth – Wax Treated	Exterior polishing cloth.
1050172	16 oz. (0.473 L)	Tar and Road Oil Remover	Removes tar, road oil and asphalt.
1050173	16 oz. (0.473 L)	Chrome Cleaner and Polish	Use on chrome or stainless steel.
1050174	16 oz. (0.473 L)	White Sidewall Tire Cleaner	Removes soil and black marks from whitewalls.
1050214	32 oz. (0.946 L)	Vinyl Cleaner	Cleans vinyl tops, upholstery and convertible tops.
1050427	23 oz. (0.680 L)	Glass Cleaner	Removes dirt, grime, smoke and fingerprints.
1052929	16 oz. (0.473 L)	Chrome and Wire Wheel Cleaner	Removes dirt and grime from chrome wheels and wire wheel covers.
12377964	16 oz. (0.473 L)	Finish Enhancer	Removes dust, fingerprints and surface contaminants. Spray on wipe off.
12377965	16 oz. (0.473 L)	Swirl Remover Polish	Removes swirl marks, fine scratches and other light surface contamination.
12377966	16 oz. (0.473 L)	Cleaner Wax	Removes light scratches and oxidation and protects finish.
12378188	15 oz. (0.443 L)	Foaming Tire Shine–Low Gloss	Cleans, shines and protects in one easy step. No wiping necessary.
12378401	16 oz. (0.473 L)	Wash Wax Concentrate	Medium foaming shampoo. Cleans and lightly waxes. Biodegradable and phosphate free.
12378488	8 oz. (0.237 L)	Spot Lifter	Quickly and easily removes spots and stains from carpets, vinyl and cloth upholstery.
<p>See your General Motors parts department for these products. See "Recommended Fluids and Lubricants" in the Index.</p>			

Vehicle Identification Number (VIN)



This is the legal identifier for your vehicle. It appears on a plate in the front corner of the instrument panel, on the driver's side. You can see it if you look through the windshield from outside your vehicle. The VIN also appears on the Vehicle Certification and Service Parts labels and the certificates of title and registration.

Engine Identification

The 8th character in your VIN is the engine code. This code will help you identify your engine, specifications and replacement parts.

Service Parts Identification Label

You'll find this label on the underside of your trunk lid. It's very helpful if you ever need to order parts. On this label is:

- your VIN,
- the model designation,
- paint information and
- a list of all production options and special equipment.

Be sure that this label is not removed from the vehicle.

Electrical System

Add-On Electrical Equipment

NOTICE:

Don't add anything electrical to your vehicle unless you check with your dealer first. Some electrical equipment can damage your vehicle and the damage wouldn't be covered by your warranty. Some add-on electrical equipment can keep other components from working as they should.

Your vehicle has an air bag system. Before attempting to add anything electrical to your vehicle, see “Servicing Your Air Bag-Equipped Vehicle” in the Index.

Headlamp Wiring

The headlamp wiring is protected by a circuit breaker in the instrument panel fuse block. An electrical overload will cause the lamps to go on and off, or in some cases to remain off. If this happens, have your headlamp system checked right away.

Windshield Wipers

The windshield wiper motor is protected by a circuit breaker and a fuse. If the motor overheats due to heavy snow, etc., the wiper will stop until the motor cools. If the overload is caused by some electrical problem, have it fixed.

Power Windows and Other Power Options

Circuit breakers in the fuse panel protect the power windows and other power accessories. When the current load is too heavy, the circuit breaker opens and closes, protecting the circuit until the problem is fixed.

Fuses and Circuit Breakers

The wiring circuits in your vehicle are protected from short circuits by a combination of fuses, circuit breakers and fusible thermal links in the wiring itself. This greatly reduces the chance of fires caused by electrical problems.

Look at the silver-colored band inside the fuse. If the band is broken or melted, replace the fuse. Be sure you replace a bad fuse with a new one of the identical size and rating. Spare fuses are located in the instrument panel. See “Underhood Fuse Block” in the Index.

Instrument Panel Fuse Block



Some fuses are in a fuse block located inside of the glove box behind a small bin on the right side. To open, pull the cover out. The fuse block is inside. On the back edge of this cover is a fuse puller and a fuse usage chart. To use the fuse puller, place the wide end of the fuse puller over the plastic end of the fuse. Squeeze the ends over the fuse and pull it out.

To reinstall the bin, position the lower end and turn the top into position. Press on the sides until it snaps into place.

FUSE USAGE CHART		See Underhood Electrical Center For Spare Fuses			
CIRCUIT BREAKERS			MALL PGM	MALL	WIPER
HEADLAMP	STR WHL ILLUM		STR WHL CTRL	SUNROOF	RADIO
SEAT		RADIO AMP	PWR LOCK	HSEAT/LUM	R DEFOG
	PASSKEY III	RAP	HAZARD	PWR MIR	HVAC HI
	CIG LTR	INT LAMP	STOP LAMP	ONSTAR	
	ECM	CRUISE	I/P-IGN	SIR	TURN
PWR WDO					BTSI
				HVAC CTRL	DIC/HVAC
			PWR DROP	CANISTER VENT	DRL
For More Information, See Owner's Manual					

Circuit Breaker Description

HEADLAMP	Headlamps
SEAT	Power Seat, Power Lumbar
BLANK	Blank
PWR WDO	Power Windows
BLANK	Blank

Fuse	Description
BLANK	Blank
BLANK	Blank
MALL PGM	Mall Module -- Program
MALL	Mall Module
WIPER	Wipers
STR WHL ILLUM	Steering Wheel Illumination
BLANK	Blank
STR WHL CTRL	Steering Wheel Control
SUNROOF	Sunroof
RADIO	Radio
BLANK	Blank
RADIO AMP	Bose Amplifier
PWR LOCK	Mall Module -- Power Locks
HSEAT/LUM	Heated Seats, Power Lumbar
R DEFOG	Rear Defog
PASSKEY III	PASS-Key [®] III Security System

Fuse	Description	Fuse	Description
RAP	Retained Accessory Power	BLANK	Blank
HAZARD	Hazard Flashers	BLANK	Blank
PWR MIR	Power Mirrors	BLANK	Blank
HVAC HI	HVAC Blower -- Hi	BLANK	Blank
CIG LTR	Cigarette Lighter, ALDL, Floor Console Accessory Outlet	BTSI	Automatic Transaxle Shift Lock Control
INT LAMP	Mall Module -- Interior lamps	BLANK	Blank
STOP LAMP	Stoplamp	BLANK	Blank
ONSTAR	OnStar [®] System	BLANK	Blank
BLANK	Blank	HVAC CTRL	Blower Control, HVAC
ECM	Electronic Control Module	DIC/HVAC	Rear Defog, HVAC, Driver Information Center, Daytime Running Lamps, Heated Seats
CRUISE	Cruise Control		
I/P-IGN	Chime/Mall Module, Cluster, Trip Computer, Head-Up Display, Automatic Transaxle Shift Lock Control	BLANK	Blank
		BLANK	Blank
SIR	Supplemental Inflatable Restraint (Air Bag)	PWR DROP	Power Drop Ignition
		CANISTER VENT	Canister Vent Solenoid
TURN	Turn Signal	DRL	Daytime Running Lamps

Underhood Fuse Block



Some fuses are located in a fuse block in the engine compartment on the passenger's side. Pull off the cover labeled FUSES to expose the fuses.

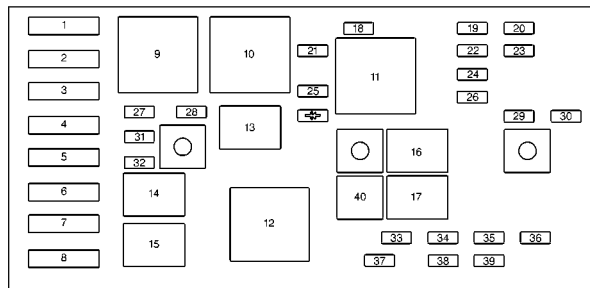

Fuse	Description
1	Cooling Fan 2
2	Spare
3	Headlamps
4	Battery Main 2
5	Ignition Main 1

Fuse	Description	Fuse	Description
6	Cooling Fan 1	29	Remote Keyless Entry, Theft-Deterrent, Trip Computer, HVAC Module, Security LED
7	Battery Main 1		
8	Ignition Main 2	30	Alt Sense
18	Fuel Injections	31	Torque Converter Clutch (TCC)
19	Spare	32	Fuel Pump
20	Spare	33	Electronic Control Module/Powertrain Control Module
21	Mass Air Flow (MAF), Heated Sensors, Canister Purge, Boost Solenoid	34	Spare
22	Spare	35	Fog Lamps
23	Spare	36	Horn
24	Spare	37	Chime/Mall Module, Taillamps, Parking Lamps, Sidemarkers Lamps, Dimmable Lamps
25	Ignition Module		
26	Spare	38	Spare Fuse
27	Trunk Release, Back-Up Lamps	39	Air Pump
28	AC Clutch, ABS Ignition	40	Mini Fuse Puller

Diode	Description
--------------	--------------------



Air Conditioning Clutch Diode

Relay	Description
--------------	--------------------

- | | |
|----|-------------------------|
| 9 | Cooling Fan |
| 10 | Cooling Fan 2 |
| 11 | Ignition Main |
| 12 | Cooling Fan 1 |
| 13 | Air Conditioning Clutch |
| 14 | Fuel Pump |
| 15 | Spare |
| 16 | Horn |
| 17 | Fog Lamp |

Replacement Bulbs

For any bulb not listed here, contact your dealer.

Lamps	Bulb Number
Back-Up	3057
Center High-Mounted Stop (CHMSL)	1141
Front Parking/Turn Signal	3357A
Headlamps High/Low Beam	9007
Tail/Stop Turn Signal	3057
Sidemarkers (Front and Rear)	194

Capacities and Specifications

Please refer to “Recommended Fluids and Lubricants” in the Index for more information.

Automatic Transaxle with Overdrive

Pan Removal and Replacement . . . 7.4 quarts (7.0 L)
 After Complete Overhaul 10.0 quarts (9.5 L)
 When draining/replacing converter or auxiliary cooler, more fluid may be needed.

Cooling System Including Reservoir

3100 V6 (Code J) 11.0 quarts (10.4 L)
 3800 V6 (Code K) 11.2 quarts (10.6 L)
 3800 V6 Supercharged (Code 1) . 11.2 quarts (10.6 L)

Engine Oil with Filter

3100 V6 (Code J) 4.3 quarts (4.1 L)
 3800 V6 (Code K) 4.3 quarts (4.1 L)
 3800 V6 Supercharged (Code 1) . . 4.3 quarts (4.1 L)

Fuel Tank 17.5 U.S. gallons (66.2 L)

Wheel Nut Torque 100 ft-lb (140 N·m)

All capacities are approximate. When adding fluid, be sure to fill to the appropriate level, as recommended in this manual. Recheck fluid level after filling. See “Recommended Fluids and Lubricants” in the Index for more information.

3100 V6 (Code J) Engine Specifications

Type V6
Displacement 191 CID (3.1L LG8)
Firing Order 1-2-3-4-5-6

3800 V6 (Code K) Engine Specifications

Type V6
Displacement 231 CID (3.8L L36)
Firing Order 1-6-5-4-3-2

3800 V6 Supercharged (Code 1) Engine Specifications

Type V6
Displacement 231 CID (3.8L L67)
Firing Order 1-6-5-4-3-2

Air Conditioning Refrigerant Capacity

If you do your own service work, you'll need the proper service manual. See "Doing Your Own Service Work" in the Index for additional information. It is recommended that service work on your air conditioning system be performed by a qualified technician.

Air Conditioning

Refrigerant R-134a 2.25 lbs. (1.09 kg)

Use Refrigerant Oil, R134a Systems.

Normal Maintenance Replacement Parts

Engine Air Cleaner/Filter

All Engines GM Part No. 24508572, A1614C*

Engine Oil Filter

All Engines PF47*

Automatic Transmission Filter 24206433*

Spark Plugs

3100 V6 (Code J) 41-940*

3800 V6 (Code K) 41-921*

3800 V6 Supercharged (Code 1) NGK Type PTR4B-15*

Spark Plug Gap .060 inch (1.52 mm)

Windshield Wiper Blade Replacement

Type Shepherd's Hook

Length 22 inches (56 cm)

*AC Delco[®] part number.



Section 7 Maintenance Schedule

This section covers the maintenance required for your vehicle. Your vehicle needs these services to retain its safety, dependability and emission control performance.

7-2	Introduction	7-19	Part C: Periodic Maintenance Inspections
7-4	Part A: Scheduled Maintenance Services	7-21	Part D: Recommended Fluids and Lubricants
7-5	Scheduled Maintenance	7-23	Part E: Maintenance Record
7-15	Part B: Owner Checks and Services		

IMPORTANT:
KEEP ENGINE OIL
AT THE PROPER
LEVEL AND CHANGE AS
RECOMMENDED



***Protection
Plan***

Have you purchased the GM Protection Plan? The Plan supplements your new vehicle warranties. See your Warranty and Owner Assistance booklet or your dealer for details.

Introduction

Your Vehicle and the Environment

Proper vehicle maintenance not only helps to keep your vehicle in good working condition, but also helps the environment. All recommended maintenance procedures are important. Improper vehicle maintenance can even affect the quality of the air we breathe. Improper fluid levels or the wrong tire inflation can increase the level of emissions from your vehicle. To help protect our environment, and to keep your vehicle in good condition, please maintain your vehicle properly.

Maintenance Requirements

Maintenance intervals, checks, inspections and recommended fluids and lubricants as prescribed in this manual are necessary to keep your vehicle in good working condition. Any damage caused by failure to follow recommended maintenance may not be covered by warranty.

How This Section is Organized

This maintenance schedule is divided into five parts:

“Part A: Scheduled Maintenance Services” explains what to have done and how often. Some of these services can be complex, so unless you are technically qualified and have the necessary equipment, you should let your dealer’s service department or another qualified service center do these jobs.

CAUTION:

Performing maintenance work on a vehicle can be dangerous. In trying to do some jobs, you can be seriously injured. Do your own maintenance work only if you have the required know-how and the proper tools and equipment for the job. If you have any doubt, have a qualified technician do the work.

If you want to get the service information, see “Service and Owner Publications” in the Index.

“Part B: Owner Checks and Services” tells you what should be checked and when. It also explains what you can easily do to help keep your vehicle in good condition.

“Part C: Periodic Maintenance Inspections” explains important inspections that your dealer’s service department or another qualified service center should perform.

“Part D: Recommended Fluids and Lubricants” lists some recommended products necessary to help keep your vehicle properly maintained. These products, or their equivalents, should be used whether you do the work yourself or have it done.

“Part E: Maintenance Record” is a place for you to record and keep track of the maintenance performed on your vehicle. Keep your maintenance receipts. They may be needed to qualify your vehicle for warranty repairs.

Part A: Scheduled Maintenance Services

Using Your Maintenance Schedule

We at General Motors want to help you keep your vehicle in good working condition. But we don't know exactly how you'll drive it. You may drive very short distances only a few times a week. Or you may drive long distances all the time in very hot, dusty weather. You may use your vehicle in making deliveries. Or you may drive it to work, to do errands or in many other ways.

Because of all the different ways people use their vehicles, maintenance needs vary. You may need more frequent checks and replacements. So please read the following and note how you drive. If you have any questions on how to keep your vehicle in good condition, see your dealer.

This part tells you the maintenance services you should have done and when you should schedule them. If you go to your dealer for your service needs, you'll know that GM-trained and supported service people will perform the work using genuine GM parts.

The proper fluids and lubricants to use are listed in Part D. Make sure whoever services your vehicle uses these. All parts should be replaced and all necessary repairs done before you or anyone else drives the vehicle.

This schedule is for vehicles that:

- carry passengers and cargo within recommended limits. You will find these limits on your vehicle's Tire-Loading Information label. See "Loading Your Vehicle" in the Index.
- are driven on reasonable road surfaces within legal driving limits.
- use the recommended fuel. See "Fuel" in the Index.

Scheduled Maintenance

The services shown in this schedule up to 100,000 miles (166 000 km) should be repeated after 100,000 miles (166 000 km) at the same intervals for the life of this vehicle. The services shown at 150,000 miles (240 000 km) should be repeated at the same interval after 150,000 miles (240 000 km) for the life of this vehicle.

See “Owner Checks and Services” and “Periodic Maintenance Inspections” following.

Footnotes

† *The U.S. Environmental Protection Agency or the California Air Resources Board has determined that the failure to perform this maintenance item will not nullify the emission warranty or limit recall liability prior to the completion of the vehicle’s useful life. We, however, urge that all recommended maintenance services be performed at the indicated intervals and the maintenance be recorded.*

+ *A good time to check your brakes is during tire rotation. See “Brake System Inspection” under “Periodic Maintenance Inspections” in Part C of this schedule.*

Scheduled Maintenance

Engine Oil Scheduled Maintenance

Change engine oil and filter as indicated by the GM Oil Life System™ (or every 12 months, whichever occurs first). Reset the system.

Your vehicle has a computer system that lets you know when to change the engine oil and filter. This is based on engine revolutions and engine temperature, and not on mileage. Based on driving conditions, the mileage at which an oil change will be indicated can vary considerably. For the oil life system to work properly, you must reset the system every time the oil is changed.

When the system has calculated that oil life has been diminished, it will indicate that an oil change is necessary. A CHANGE OIL SOON light will come on. Change your oil as soon as possible within the next two times you stop for fuel. It is possible that, if you are driving under the best conditions, the oil life system may not indicate that an oil change is necessary for over a year. However, your engine oil and filter must be changed at least once a year and at this time the system must be reset. It is also important to check your oil regularly and keep it at the proper level.

If the system is ever reset accidentally, you must change your oil at 3,000 miles (5 000 km) since your last oil change. Remember to reset the oil life system whenever the oil is changed. See “Oil Life System” in the Index for information on resetting the system.

An Emission Control Service.

Scheduled Maintenance

ENGINE OIL CHANGE		
DATE	ACTUAL MILEAGE	SERVICED BY:

ENGINE OIL CHANGE		
DATE	ACTUAL MILEAGE	SERVICED BY:

Scheduled Maintenance

ENGINE OIL CHANGE		
DATE	ACTUAL MILEAGE	SERVICED BY:

ENGINE OIL CHANGE		
DATE	ACTUAL MILEAGE	SERVICED BY:

Scheduled Maintenance

7,500 Miles (12 500 km)

- Rotate tires. See “Tire Inspection and Rotation” in the Index for proper rotation pattern and additional information. (See footnote +).

15,000 Miles (25 000 km)

- Inspect engine air cleaner filter if you are driving in dusty conditions. Replace filter if necessary.
An Emission Control Service. (See footnote †).
- Rotate tires. See “Tire Inspection and Rotation” in the Index for proper rotation pattern and additional information. (See footnote +).

22,500 Miles (37 500 km)

- Rotate tires. See “Tire Inspection and Rotation” in the Index for proper rotation pattern and additional information. (See footnote +).

DATE	
ACTUAL MILEAGE	SERVICED BY:

DATE	
ACTUAL MILEAGE	SERVICED BY:

DATE	
ACTUAL MILEAGE	SERVICED BY:

Scheduled Maintenance

30,000 Miles (50 000 km)

- Rotate tires. See “Tire Inspection and Rotation” in the Index for proper rotation pattern and additional information. (See footnote +).
- Replace engine air cleaner filter.
An Emission Control Service.
- For supercharged engines only: Check the supercharger oil level and add the proper supercharger oil as needed (or every 36 months, whichever occurs first). See “Recommended Fluids and Lubricants” in this section.
An Emission Control Service. (See footnote †).

DATE	
ACTUAL MILEAGE	SERVICED BY:

37,500 Miles (62 500 km)

- Rotate tires. See “Tire Inspection and Rotation” in the Index for proper rotation pattern and additional information. (See footnote +).

DATE	
ACTUAL MILEAGE	SERVICED BY:

45,000 Miles (75 000 km)

- Inspect engine air cleaner filter if you are driving in dusty conditions. Replace filter if necessary.
An Emission Control Service. (See footnote †).
- Rotate tires. See “Tire Inspection and Rotation” in the Index for proper rotation pattern and additional information. (See footnote +).

DATE	
ACTUAL MILEAGE	SERVICED BY:

Scheduled Maintenance

50,000 Miles (83 000 km)

- Change automatic transaxle fluid and filter if the vehicle is mainly driven under one or more of these conditions:
 - In heavy city traffic where the outside temperature regularly reaches 90°F (32°C) or higher.
 - In hilly or mountainous terrain.
 - When doing frequent trailer towing.
 - Uses such as found in taxi, police or delivery service.

If you do not use your vehicle under any of these conditions, change the fluid and filter at 100,000 miles (166 000 km).

DATE	
ACTUAL MILEAGE	SERVICED BY:

52,500 Miles (87 500 km)

- Rotate tires. See “Tire Inspection and Rotation” in the Index for proper rotation pattern and additional information. *(See footnote +).*

DATE	
ACTUAL MILEAGE	SERVICED BY:

Scheduled Maintenance

60,000 Miles (100 000 km)

- For supercharged engines only: Check the supercharger oil level and add the proper supercharger oil as needed (or every 36 months, whichever occurs first). See “Recommended Fluids and Lubricants” in this section.
An Emission Control Service. (See footnote †).
- Rotate tires. See “Tire Inspection and Rotation” in the Index for proper rotation pattern and additional information. *(See footnote +).*
- Inspect engine accessory drive belt.
An Emission Control Service.
- Replace engine air cleaner filter.
An Emission Control Service.

67,500 Miles (112 500 km)

- Rotate tires. See “Tire Inspection and Rotation” in the Index for proper rotation pattern and additional information. *(See footnote +).*

75,000 Miles (125 000 km)

- Inspect engine air cleaner filter if you are driving in dusty conditions. Replace filter if necessary.
An Emission Control Service. (See footnote †).
- Rotate tires. See “Tire Inspection and Rotation” in the Index for proper rotation pattern and additional information. *(See footnote +).*

DATE	
ACTUAL MILEAGE	SERVICED BY:

DATE	
ACTUAL MILEAGE	SERVICED BY:

DATE	
ACTUAL MILEAGE	SERVICED BY:

Scheduled Maintenance

82,500 Miles (137 500 km)

- Rotate tires. See “Tire Inspection and Rotation” in the Index for proper rotation pattern and additional information. (*See footnote +*).

DATE	
ACTUAL MILEAGE	SERVICED BY:

90,000 Miles (150 000 km)

- Replace engine air cleaner filter.
An Emission Control Service.
- For supercharged engines only: Check the supercharger oil level and add the proper supercharger oil as needed (or every 36 months, whichever occurs first). See “Recommended Fluids and Lubricants” in this section.
An Emission Control Service. (See footnote †).
- Rotate tires. See “Tire Inspection and Rotation” in the Index for proper rotation pattern and additional information. (*See footnote +*).

DATE	
ACTUAL MILEAGE	SERVICED BY:

97,500 Miles (162 500 km)

- Rotate tires. See “Tire Inspection and Rotation” in the Index for proper rotation pattern and additional information. (*See footnote +*).

DATE	
ACTUAL MILEAGE	SERVICED BY:

Scheduled Maintenance

100,000 Miles (166 000 km)

- Inspect spark plug wires.
An Emission Control Service.
- Replace spark plugs.
An Emission Control Service.
- Change automatic transaxle fluid and filter if the vehicle is mainly driven under one or more of these conditions:
 - In heavy city traffic where the outside temperature regularly reaches 90°F (32°C) or higher.
 - In hilly or mountainous terrain.
 - When doing frequent trailer towing.
 - Uses such as found in taxi, police or delivery service.
- If you haven't used your vehicle under severe service conditions listed previously and, therefore, haven't changed your automatic transaxle fluid, change both the fluid and filter.

150,000 Miles (240 000 km)

- Drain, flush and refill cooling system (or every 60 months since last service, whichever occurs first). See “Engine Coolant” in the Index for what to use. Inspect hoses. Clean radiator, condenser, pressure cap and neck. Pressure test the cooling system and pressure cap.
An Emission Control Service.

DATE	
ACTUAL MILEAGE	SERVICED BY:

DATE	
ACTUAL MILEAGE	SERVICED BY:

Part B: Owner Checks and Services

Listed in this part are owner checks and services which should be performed at the intervals specified to help ensure the safety, dependability and emission control performance of your vehicle.

Be sure any necessary repairs are completed at once. Whenever any fluids or lubricants are added to your vehicle, make sure they are the proper ones, as shown in Part D.

At Each Fuel Fill

It is important for you or a service station attendant to perform these underhood checks at each fuel fill.

Engine Oil Level Check

Check the engine oil level and add the proper oil if necessary. See “Engine Oil” in the Index for further details.

Engine Coolant Level Check

Check the engine coolant level and add DEX-COOL[®] coolant mixture if necessary. See “Engine Coolant” in the Index for further details.

Windshield Washer Fluid Level Check

Check the windshield washer fluid level in the windshield washer tank and add the proper fluid if necessary. See “Windshield Washer Fluid” in the Index for further details.

At Least Once a Month

Tire Inflation Check

Make sure tires are inflated to the correct pressures. Don't forget to check your spare tire. See “Tires” in the Index for further details.

Cassette Deck Service

Clean cassette deck. Cleaning should be done every 50 hours of tape play. See “Audio Systems” in the Index for further details.

At Least Twice a Year

Restraint System Check

Make sure the safety belt reminder light and all your belts, buckles, latch plates, retractors and anchorages are working properly. Look for any other loose or damaged safety belt system parts. If you see anything that might keep a safety belt system from doing its job, have it repaired. Have any torn or frayed safety belts replaced.

Also look for any opened or broken air bag coverings, and have them repaired or replaced. (The air bag system does not need regular maintenance.)

Wiper Blade Check

Inspect wiper blades for wear or cracking. Replace blade inserts that appear worn or damaged or that streak or miss areas of the windshield. Also see “Wiper Blades, Cleaning” in the Index.

Weatherstrip Lubrication

Silicone grease on weatherstrips will make them last longer, seal better, and not stick or squeak. Apply silicone grease with a clean cloth. During very cold, damp weather more frequent application may be required. See “Recommended Fluids and Lubricants” in the Index.

Automatic Transaxle Check

Check the transaxle fluid level; add if needed. See “Automatic Transaxle Fluid” in the Index. A fluid loss may indicate a problem. Check the system and repair if needed.

At Least Once a Year

Key Lock Cylinders Service

Lubricate the key lock cylinders with the lubricant specified in Part D.

Body Lubrication Service

Lubricate all hood hinges, hood latch assembly, secondary latch, pivots, spring anchor, release pawl, door hinges, rear compartment, glove box door, console door and any folding seat hardware. Part D tells you what to use. More frequent lubrication may be required when exposed to a corrosive environment.

Starter Switch Check

CAUTION:

When you are doing this check, the vehicle could move suddenly. If it does, you or others could be injured. Follow the steps below.

1. Before you start, be sure you have enough room around the vehicle.
2. Firmly apply both the parking brake and the regular brake. See “Parking Brake” in the Index if necessary.

Do not use the accelerator pedal, and be ready to turn off the engine immediately if it starts.
3. Try to start the engine in each gear. The starter should work only in PARK (P) or NEUTRAL (N). If the starter works in any other position, your vehicle needs service.

Automatic Transaxle Shift Lock Control System Check

CAUTION:

When you are doing this check, the vehicle could move suddenly. If it does, you or others could be injured. Follow the steps below.

1. Before you start, be sure you have enough room around the vehicle. It should be parked on a level surface.
2. Firmly apply the parking brake. See “Parking Brake” in the Index if necessary.

Be ready to apply the regular brake immediately if the vehicle begins to move.
3. With the engine off, turn the key to the RUN position, but don’t start the engine. Without applying the regular brake, try to move the shift lever out of PARK (P) with normal effort. If the shift lever moves out of PARK (P), your vehicle needs service.

Ignition Transaxle Lock Check

While parked, and with the parking brake set, try to turn the ignition key to LOCK in each shift lever position.

- The key should turn to LOCK only when the shift lever is in PARK (P).
- The key should come out only in LOCK.

Parking Brake and Automatic Transaxle PARK (P) Mechanism Check

CAUTION:

When you are doing this check, your vehicle could begin to move. You or others could be injured and property could be damaged. Make sure there is room in front of your vehicle in case it begins to roll. Be ready to apply the regular brake at once should the vehicle begin to move.

Park on a fairly steep hill, with the vehicle facing downhill. Keeping your foot on the regular brake, set the parking brake.

- To check the parking brake's holding ability: With the engine running and transaxle in NEUTRAL (N), slowly remove foot pressure from the regular brake pedal. Do this until the vehicle is held by the parking brake only.
- To check the PARK (P) mechanism's holding ability: With the engine running, shift to PARK (P). Then release the parking brake followed by the regular brake.

Underbody Flushing Service

At least every spring, use plain water to flush any corrosive materials from the underbody. Take care to clean thoroughly any areas where mud and other debris can collect.

Part C: Periodic Maintenance Inspections

Listed in this part are inspections and services which should be performed at least twice a year (for instance, each spring and fall). *You should let your dealer's service department or other qualified service center do these jobs. Make sure any necessary repairs are completed at once.*

Proper procedures to perform these services may be found in a service manual. See "Service and Owner Publications" in the Index.

Steering, Suspension and Front Drive Axle Boot and Seal Inspection

Inspect the front and rear suspension and steering system for damaged, loose or missing parts, signs of wear or lack of lubrication. Inspect the power steering lines and hoses for proper hook-up, binding, leaks, cracks, chafing, etc. Clean and then inspect the drive axle boot seals for damage, tears or leakage. Replace seals if necessary.

Exhaust System Inspection

Inspect the complete exhaust system. Inspect the body near the exhaust system. Look for broken, damaged, missing or out-of-position parts as well as open seams, holes, loose connections or other conditions which could cause a heat build-up in the floor pan or could let exhaust fumes into the vehicle. See "Engine Exhaust" in the Index.

Fuel System Inspection

Inspect the complete fuel system for damage or leaks.

Engine Cooling System Inspection

Inspect the hoses and have them replaced if they are cracked, swollen or deteriorated. Inspect all pipes, fittings and clamps; replace as needed. Clean the outside of the radiator and air conditioning condenser. To help ensure proper operation, a pressure test of the cooling system and pressure cap is recommended at least once a year.

Throttle System Inspection

Inspect the throttle system for interference or binding, and for damaged or missing parts. Replace parts as needed. Replace any components that have high effort or excessive wear. Do not lubricate accelerator and cruise control cables.

Brake System Inspection

Inspect the complete system. Inspect brake lines and hoses for proper hook-up, binding, leaks, cracks, chafing, etc. Inspect disc brake pads for wear and rotors for surface condition. Inspect other brake parts, including calipers, parking brake, etc. Check parking brake adjustment. You may need to have your brakes inspected more often if your driving habits or conditions result in frequent braking.

Part D: Recommended Fluids and Lubricants

Fluids and lubricants identified below by name, part number or specification may be obtained from your dealer.

USAGE	FLUID/LUBRICANT
Engine Oil	Engine oil with the American Petroleum Institute Certified for Gasoline Engines starburst symbol of the proper viscosity. To determine the preferred viscosity for your vehicle's engine, see "Engine Oil" in the Index.
Engine Coolant	50/50 mixture of clean, drinkable water and use only GM Goodwrench [®] DEX-COOL [®] or Havoline [®] DEX-COOL [®] Coolant. See "Engine Coolant" in the Index.

USAGE	FLUID/LUBRICANT
Hydraulic Brake System	Delco Supreme 11 [®] Brake Fluid (GM Part No. 12377967 or equivalent DOT-3 brake fluid).
Windshield Washer Solvent	GM Optikleen [®] Washer Solvent (GM Part No. 1051515) or equivalent.
Power Steering System	GM Power Steering Fluid (GM Part No. 1052884 - 1 pint, 1050017 - 1 quart, or equivalent).
Automatic Transaxle	DEXRON [®] -III Automatic Transmission Fluid.

USAGE	FLUID/LUBRICANT
Key Lock Cylinders	Multi-Purpose Lubricant, Superlube [®] (GM Part No. 12346241 or equivalent).
Supercharger	Supercharger Oil (GM Part No. 12345982). See “Supercharger Oil” in the Index.

USAGE	FLUID/LUBRICANT
Hood Latch Assembly, Secondary Latch, Pivots, Spring Anchor and Release Pawl	Lubriplate [®] Lubricant Aerosol (GM Part No. 12346293 or equivalent) or lubricant meeting requirements of NLGI # 2, Category LB or GC-LB.
Hood and Door Hinges	Multi-Purpose Lubricant, Superlube [®] (GM Part No. 12346241 or equivalent).
Weatherstrip Conditioning	Dielectric Silicone Grease (GM Part No. 12345579 or equivalent).

Part E: Maintenance Record

After the scheduled services are performed, record the date, odometer reading and who performed the service in the boxes provided after the maintenance interval. Any additional information from “Owner Checks and Services” or “Periodic Maintenance” can be added on the following record pages. Also, you should retain all maintenance receipts. Your owner information portfolio is a convenient place to store them.

Maintenance Record			
DATE	ODOMETER READING	SERVICED BY	MAINTENANCE PERFORMED

Maintenance Record

DATE	ODOMETER READING	SERVICED BY	MAINTENANCE PERFORMED



Section 8 Customer Assistance Information

Here you will find out how to contact Pontiac if you need assistance. This section also tells you how to obtain service publications and how to report any safety defects.

8-2	Pontiac Cares	8-8	Canadian Roadside Assistance
8-2	What Makes Up Pontiac Cares?	8-8	Courtesy Transportation
8-3	Customer Satisfaction Procedure	8-10	Warranty Information
8-5	Customer Assistance for Text Telephone (TTY) Users	8-10	Reporting Safety Defects to the United States Government
8-5	Customer Assistance Offices	8-11	Reporting Safety Defects to the Canadian Government
8-6	GM Mobility Program for Persons with Disabilities	8-11	Reporting Safety Defects to General Motors
8-6	Pontiac Roadside Assistance Program		

Pontiac Cares



With PONTIAC CARES, you are never more than a phone call away from having your concern taken care of.

The PONTIAC CARES philosophy and elements are designed to make you realize that Pontiac recognizes you as a valuable customer, appreciates your purchase decision, and is dedicated to taking care of the most important person ... YOU! PONTIAC CARES is: A valuable feature that comes with every Pontiac, a feature that offers a multitude of benefits that can give you safety, security, comfort and convenience.

What Makes Up Pontiac Cares?

- A 3 year/36,000 mile (60 000 km) Bumper-to-Bumper Warranty
- Customer Assistance
- Roadside Assistance
- Courtesy Transportation

All of these elements combine to make your driving experience an enjoyable one and are discussed in greater detail in your owner's manual. Pontiac is focusing on the changing needs of our customers and is committed to giving you an exceptional level of customer care throughout your ownership experience. Our goal is to create total customer enthusiasm in our product and our services and make you the most satisfied customer in the world.

Customer Satisfaction Procedure



Your satisfaction and goodwill are important to your dealer and to Pontiac. Normally, any concerns with the sales transaction or the operation of your vehicle will be resolved by your dealer's sales or service departments. Sometimes, however, despite the best intentions of all concerned, misunderstandings can occur. If your concern has not been resolved to your satisfaction, the following steps should be taken:

STEP ONE -- Discuss your concern with a member of dealership management. Normally, concerns can be quickly resolved at that level. If the matter has already been reviewed with the sales, service or parts manager, contact the owner of the dealership or the general manager.

STEP TWO -- If after contacting a member of dealership management, it appears your concern cannot be resolved by the dealership without further help, contact the Pontiac Customer Assistance Center by calling 1-800-762-2737. In Canada, contact GM of Canada Customer Communication Centre in Oshawa by calling 1-800-263-3777 (English) or 1-800-263-7854 (French).

We encourage you to call the toll-free number in order to give your inquiry prompt attention. Please have the following information available to give the Customer Assistance Representative:

- Vehicle Identification Number (This is available from the vehicle registration or title, or the plate at the top left of the instrument panel and visible through the windshield.)
- Dealership name and location
- Vehicle delivery date and present mileage

When contacting Pontiac, please remember that your concern will likely be resolved at a dealer's facility. That is why we suggest you follow Step One first if you have a concern.

STEP THREE -- Both General Motors and your dealer are committed to making sure you are completely satisfied with your new vehicle. However, if you continue to remain unsatisfied after following the procedure outlined in Steps One and Two, you should file with the GM/BBB Auto Line Program to enforce any additional rights you may have. Canadian owners refer to your Warranty and Owner Assistance Information booklet for information on the Canadian Motor Vehicle Arbitration Plan (CAMVAP).

The BBB Auto Line Program is an out of court program administered by the Council of Better Business Bureaus to settle automotive disputes regarding vehicle repairs or the interpretation of the New Vehicle Limited Warranty. Although you may be required to resort to this informal dispute resolution program prior to filing a court action, use of the program is free of charge and your case will generally be heard within 40 days. If you do not agree with the decision given in your case, you may reject it and proceed with any other venue for relief available to you.

You may contact the BBB using the toll-free telephone number or write them at the following address:

BBB Auto Line
Council of Better Business Bureaus, Inc.
4200 Wilson Boulevard
Suite 800
Arlington, VA 22203-1804
Telephone: 1-800-955-5100

This program is available in all 50 states and the District of Columbia. Eligibility is limited by vehicle age, mileage and other factors. General Motors reserves the right to change eligibility limitations and/or discontinue its participation in this program.

Customer Assistance for Text Telephone (TTY) Users

To assist customers who are deaf, hard of hearing, or speech-impaired and who use Text Telephones (TTYs), Pontiac has TTY equipment available at its Customer Assistance Center. Any TTY user can communicate with Pontiac by dialing: 1-800-833-PONT (7668). (TTY users in Canada can dial 1-800-263-3830.)

Customer Assistance Offices

Pontiac encourages customers to call the toll-free number for assistance. If a U.S. customer wishes to write to Pontiac, the letter should be addressed to Pontiac's Customer Assistance Center.

United States

Pontiac-GMC Customer Assistance Center
P.O. Box 33172
Detroit, MI 48232-5172

1-800-762-2737 or
1-800-833-7668 (For Text Telephone devices (TTYs))
Roadside Assistance: 1-800-ROADSIDE (762-3743)

From:

Puerto Rico: 1-800-496-9992 (English)
1-800-496-9993 (Spanish)

U.S. Virgin Islands: 1-800-496-9994
Fax Number: 313-381-0022

Canada

General Motors of Canada Limited
Customer Communication Centre, 163-005
1908 Colonel Sam Drive
Oshawa, Ontario L1H 8P7

1-800-263-3777 (English)
1-800-263-7854 (French)
1-800-263-3830 (For Text Telephone devices (TTYs))
Roadside Assistance: 1-800-268-6800

All Overseas Locations

Please contact the local General Motors Business Unit.

Mexico, Central America and Caribbean Islands/Countries (Except Puerto Rico and U.S. Virgin Islands)

General Motors de Mexico, S. de R.L. de C.V.
Customer Assistance Center
Paseo de la Reforma # 2740
Col. Lomas de Bezares
C.P. 11910, Mexico, D.F.

01-800-508-0000
Long Distance: 011-52 - 53 29 0 800

GM Mobility Program for Persons with Disabilities



This program, available to qualified applicants, can reimburse you up to \$1,000 toward aftermarket driver or passenger adaptive equipment you may require for your vehicle (hand controls, wheelchair/scooter lifts, etc.).

This program can also provide you with free resource information, such as area driver assessment centers and mobility equipment installers. The program is available for a limited period of time from the date of vehicle purchase/lease. See your dealer for more details or call the GM Mobility Assistance Center at 1-800-323-9935. Text telephone (TTY) users, call 1-800-833-9935.

GM of Canada also has a Mobility Program. Call 1-800-GM-DRIVE (463-7483) for details. When calling from outside Canada, please dial 1-905-644-3063. All TTY users call 1-800-263-3830.

Pontiac Roadside Assistance Program

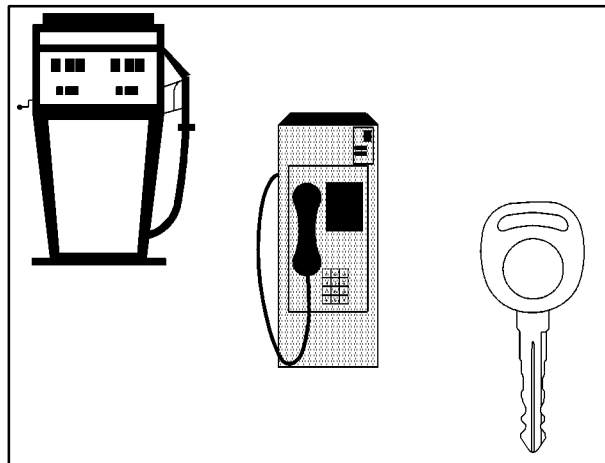

Security While You Travel

1-800-ROADSIDE (1-800-762-3743)

As the proud owner of a new Pontiac vehicle, you are automatically enrolled in the Pontiac Roadside Assistance program. This value-added service is intended to provide you with peace of mind as you drive in the city or travel the open road.

Pontiac's Roadside Assistance toll-free number is staffed by a team of technically trained advisors, who are available 24 hours a day, 365 days a year.

We take anxiety out of uncertain situations by providing minor repair information over the phone or making arrangements to tow your vehicle to the nearest Pontiac dealer.

We will provide the following services for 3 years/36,000 miles (60 000 km), at no expense to you:

- Fuel delivery
- Lock-out service (identification required)
- Tow to nearest dealership for warranty service
- Change a flat tire
- Jump starts

We have quick, easy access to telephone numbers of the following additional services depending on your needs:

- Hotels
- Glass replacement
- Tire repair facilities

- Rental vehicle or taxis
- Airports or train stations
- Police, fire department or hospitals

In many instances, mechanical failures are covered under Pontiac's comprehensive warranty. However, when other services are utilized, our advisors will explain any payment obligations you might incur.

For prompt and efficient assistance when calling, please provide the following information to give the advisor:

- Location of vehicle
- Telephone number of your location
- Vehicle model, year and color
- Mileage of vehicle
- Vehicle Identification Number (VIN)
- Vehicle license plate number

Pontiac reserves the right to limit services or reimbursement to an owner or driver when, in Pontiac's judgement, the claims become excessive in frequency or type of occurrence.

While we hope you never have the occasion to use our service, it is added security while traveling for you and your family. Remember, we're only a phone call away. Pontiac Roadside Assistance -- 1-800-ROADSIDE or 1-800-762-3743, text telephone (TTY) users, call 1-888-889-2438.

Canadian Roadside Assistance

Vehicles purchased in Canada have an extensive Roadside Assistance program accessible from anywhere in Canada or the United States. Please refer to the Warranty and Owner Assistance Information book or call 1-800-268-6800 for emergency services.

Courtesy Transportation

Pontiac has always exemplified quality and value in its offering of motor vehicles. To enhance your ownership experience, we and our participating dealers are proud to offer Courtesy Transportation, a customer support program for new vehicles.

The Courtesy Transportation program is offered to retail purchase/lease customers in conjunction with the Bumper-to-Bumper coverage provided by the New Vehicle Limited Warranty. Several transportation options are available when warranty repairs are required. This will reduce your inconvenience during warranty repairs.

Plan Ahead When Possible

When your vehicle requires warranty service, you should contact your dealer and request an appointment. By scheduling a service appointment and advising your service consultant of your transportation needs, your dealer can help minimize your inconvenience. If your vehicle cannot be scheduled into the service department immediately, keep driving it until it can be scheduled for service, unless, of course, the problem is safety-related. If it is, please call your dealership, let them know this, and ask for instructions.

If the dealer requests that you simply drop the vehicle off for service, you are urged to do so as early in the work day as possible to allow for same day repair.

Transportation Options

Warranty service can generally be completed while you wait. However, if you are unable to wait Pontiac helps minimize your inconvenience by providing several transportation options. Depending on the circumstances, your dealer can offer you one of the following:

Shuttle Service

Participating dealers can provide you with shuttle service to get you to your destination with minimal interruption of your daily schedule. This includes a one way shuttle ride to a destination up to 10 miles from the dealership.

Public Transportation or Fuel Reimbursement

If your vehicle requires overnight warranty repairs, reimbursement up to \$30 per day (five days maximum) may be available for the use of public transportation such as taxi or bus. In addition, should you arrange transportation through a friend or relative, reimbursement for reasonable fuel expenses up to \$10 per day (five day maximum) may be available. Claim amounts should reflect actual costs and be supported by original receipts.

Courtesy Rental Vehicle

When your vehicle is unavailable due to overnight warranty repairs, your dealer may arrange to provide you with a courtesy rental vehicle or reimburse you for a rental vehicle you obtained, at actual cost, up to a maximum of \$30.00 per day supported by receipts. This requires that you sign and complete a rental agreement and meet state, local and rental vehicle provider requirements. Requirements vary and may include minimum age requirements, insurance coverage, credit card, etc. You are responsible for fuel usage charges and may also be responsible for taxes, levies, usage fees, excessive mileage or rental usage beyond the completion of the repair.

Generally it is not possible to provide a like-vehicle as a courtesy rental.

Additional Program Information

Courtesy Transportation is available during the Bumper-to-Bumper warranty coverage period, but it *is not* part of the New Vehicle Limited Warranty. A separate booklet entitled “Warranty and Owner Assistance Information” furnished with each new vehicle provides detailed warranty coverage information.

Courtesy Transportation is available only at participating dealers and all program options, such as shuttle service, may not be available at every dealer. Please contact your dealer for specific information about availability. All Courtesy Transportation arrangements will be administered by appropriate dealer personnel.

Canadian Vehicles: For warranty repairs during the Complete Vehicle Coverage period of the General Motors of Canada New Vehicle Limited Warranty, alternative transportation may be available under the Courtesy Transportation Program. Please consult your dealer for details.

General Motors reserves the right to unilaterally modify, change or discontinue Courtesy Transportation at any time and to resolve all questions of claim eligibility pursuant to the terms and conditions described herein at its sole discretion.

Warranty Information

Your vehicle comes with a separate warranty booklet that contains detailed warranty information.

REPORTING SAFETY DEFECTS TO THE UNITED STATES GOVERNMENT

If you believe that your vehicle has a defect which could cause a crash or could cause injury or death, you should immediately inform the National Highway Traffic Safety Administration (NHTSA), in addition to notifying General Motors.

If NHTSA receives similar complaints, it may open an investigation, and if it finds that a safety defect exists in a group of vehicles, it may order a recall and remedy campaign. However, NHTSA cannot become involved in individual problems between you, your dealer or General Motors.

To contact NHTSA, you may either call the Auto Safety Hotline toll-free at 1-800-424-9393 (or 366-0123 in the Washington, D.C. area) or write to:

NHTSA, U.S. Department of Transportation
Washington, D.C. 20590

You can also obtain other information about motor vehicle safety from the hotline.

REPORTING SAFETY DEFECTS TO THE CANADIAN GOVERNMENT

If you live in Canada, and you believe that your vehicle has a safety defect, you should immediately notify Transport Canada, in addition to notifying General Motors of Canada Limited. You may write to:

Transport Canada
330 Sparks Street
Tower C
Ottawa, Ontario K1A 0N5

REPORTING SAFETY DEFECTS TO GENERAL MOTORS

In addition to notifying NHTSA (or Transport Canada) in a situation like this, we certainly hope you'll notify us. Please call us at 1-800-762-2737, or write:

Pontiac-GMC Customer Assistance Center
P.O. Box 33172
Detroit, MI 48232-5172

In Canada, please call us at 1-800-263-3777 (English) or 1-800-263-7854 (French). Or, write:

General Motors of Canada Limited
Customer Communication Centre, 163-005
1908 Colonel Sam Drive
Oshawa, Ontario L1H 8P7

SERVICE PUBLICATIONS ORDERING INFORMATION

Service Manuals

Service Manuals have the diagnosis and repair information on engines, transmission, axle, suspension, brakes, electrical, steering, body, etc.

RETAIL SELL PRICE: \$120.00

Transmission, Transaxle, Transfer Case Unit Repair Manual

This manual provides information on unit repair service procedures, adjustments and specifications for GM transmissions, transaxles and transfer cases.

RETAIL SELL PRICE: \$50.00

Service Bulletins

Service Bulletins give technical service information needed to knowledgeable service General Motors cars and trucks. Each bulletin contains instructions to assist in the diagnosis and service of your vehicle.

Owner's Information

Owner publications are written specifically for owners and intended to provide basic operational information about the vehicle. The owner's manual will include the Maintenance Schedule for all models.

In-Portfolio: Includes a Portfolio, Owner's Manual and Warranty Booklet.

RETAIL SELL PRICE: \$35.00

Without Portfolio: Owner's Manual only.

RETAIL SELL PRICE: \$25.00

Current and Past Model Order Forms

Service Publications are available for current and past model GM vehicles. To request an order form, please specify year and model name of the vehicle.

ORDER TOLL FREE: 1-800-551-4123 – Monday-Friday 8:00 AM – 6:00 PM Eastern Time

Visit Helm, Inc. on the World Wide Web at: www.helminc.com

For Credit Card Orders Only (VISA-MasterCard-Discover)

Helm, Incorporated • P.O. Box 07130 • Detroit, MI 48207

Prices are subject to change without notice and without incurring obligation. Allow ample time for delivery.

Note to Canadian Customers: All listed prices are quoted in U.S. funds. Canadian residents are to make checks payable in U.S. funds.