



1996

PONTIAC

GRAND PRIX



The 1996 Pontiac Grand Prix Owner's Manual

Seats and Restraint Systems	1-1
This section tells you how to use your seats and safety belts properly. It also explains the "SRS" system.	
Features and Controls	2-1
This section explains how to start and operate your Pontiac.	
Comfort Controls and Audio Systems	3-1
This section tells you how to adjust the ventilation and comfort controls and how to operate your audio system.	
Your Driving and the Road	4-1
Here you'll find helpful information and tips about the road and how to drive under different conditions.	
Problems on the Road	5-1
This section tells you what to do if you have a problem while driving, such as a flat tire or overheated engine, etc.	
Service and Appearance Care	6-1
Here the manual tells you how to keep your Pontiac running properly and looking good.	
Maintenance Schedule	7-1
This section tells you when to perform vehicle maintenance and what fluids and lubricants to use.	
Customer Assistance Information	8-1
This section tells you how to contact Pontiac for assistance and how to get service and owner publications. It also gives you information on "Reporting Safety Defects" on page 8-9.	
Index	9-1
Here's an alphabetical listing of almost every subject in this manual. You can use it to quickly find something you want to read.	



GENERAL MOTORS, GM, the GM Emblem, PONTIAC, the PONTIAC Emblem and the name GRAND PRIX are registered trademarks of General Motors Corporation.

This manual includes the latest information at the time it was printed. We reserve the right to make changes in the product after that time without further notice. For vehicles first sold in Canada, substitute the name "General Motors of Canada Limited" for Pontiac Division whenever it appears in this manual.

Please keep this manual in your Pontiac, so it will be there if you ever need it when you're on the road. If you sell the vehicle, please leave this manual in it so the new owner can use it.

Litho in U.S.A.
Part No. 10273393 B • First Edition



We support voluntary technician certification.

For Canadian Owners Who Prefer a French Language Manual:

Aux propriétaires canadiens: Vous pouvez vous procurer un exemplaire de ce guide en français chez votre concessionnaire ou au:

DGN Marketing Services Ltd.
1500 Bonhill Rd.
Mississauga, Ontario L5T 1C7

© Copyright General Motors Corporation 1995
All Rights Reserved

How to Use This Manual

Many people read their owner's manual from beginning to end when they first receive their new vehicle. If you do this, it will help you learn about the features and controls for your vehicle. In this manual, you'll find that pictures and words work together to explain things quickly.

Index

A good place to look for what you need is the Index in the back of the manual. It's an alphabetical list of all that's in the manual, and the page number where you'll find it.

Safety Warnings and Symbols

You will find a number of safety cautions in this book. We use a box and the word CAUTION to tell you about things that could hurt you if you were to ignore the warning.



CAUTION:

These mean there is something that could hurt you or other people.

In the caution area, we tell you what the hazard is. Then we tell you what to do to help avoid or reduce the hazard. Please read these cautions. If you don't, you or others could be hurt.

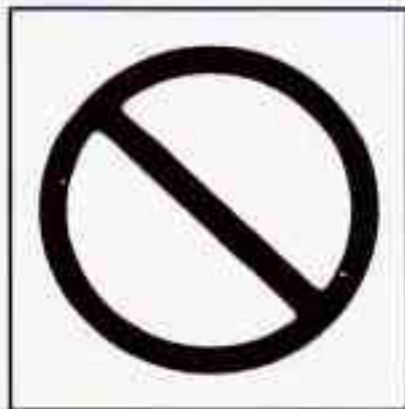

You will also find a circle with a slash through it in this book. This safety symbol means "Don't," "Don't do this," or "Don't let this happen."

Vehicle Damage Warnings

Also, in this book you will find these notices:

NOTICE:

These mean there is something that could damage your vehicle.

In the notice area, we tell you about something that *can* damage your vehicle. Many times, this damage would not be covered by your warranty, and it could be costly. But the notice will tell you what to do to help avoid the damage.

When you read other manuals, you might see CAUTION and NOTICE warnings in different colors or in different words.

You'll also see warning labels on your vehicle. They use the same words, CAUTION or NOTICE.

Vehicle Symbols

These are some of the symbols you may find on your vehicle.

For example, these symbols are used on an original battery:

CAUTION
POSSIBLE
INJURY



PROTECT
EYES BY
SHIELDING



CAUSTIC
BATTERY
ACID COULD
CAUSE
BURNS



AVOID
SPARKS OR
FLAMES



SPARK OR
FLAME
COULD
EXPLODE
BATTERY



These symbols are important for you and your passengers whenever your vehicle is driven:

DOOR LOCK
UNLOCK



FASTEN
SEAT
BELTS



POWER
WINDOW



AIR BAG



These symbols have to do with your lights:

MASTER
LIGHTING
SWITCH



TURN
SIGNALS



PARKING
LAMPS



HAZARD
WARNING
FLASHER



DAYTIME
RUNNING
LAMPS



FOG LAMPS

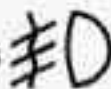

These symbols are on some of your controls:

WINDSHIELD
WIPER



WINDSHIELD
WASHER



WINDSHIELD
DEFROSTER



REAR
WINDOW
DEFOGGER



VENTILATING
FAN



These symbols are used on warning and indicator lights:

ENGINE
COOLANT
TEMP



BATTERY
CHARGING
SYSTEM



BRAKE



COOLANT



ENGINE OIL
PRESSURE



ANTI-LOCK
BRAKES



Here are some other symbols you may see:

FUSE



LIGHTER



HORN



SPEAKER



FUEL



NOTES



Section 1 Seats and Restraint Systems

Here you'll find information about the seats in your Pontiac and how to use your safety belts properly. You can also learn about some things you should *not* do with air bags and safety belts.

Seats and Seat Controls

This section tells you how to adjust the seats and explains reclining seatbacks and head restraints.

Manual Front Seat



CAUTION:

You can lose control of the vehicle if you try to adjust a manual driver's seat while the vehicle is moving. The sudden movement could startle and confuse you, or make you push a pedal when you don't want to. Adjust the driver's seat only when the vehicle is not moving.

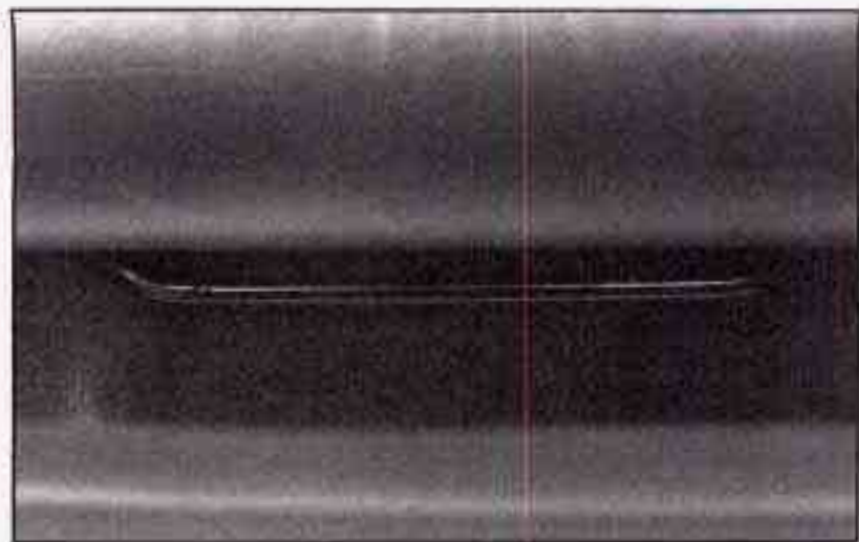

Lift the bar under the front of the seat to unlock it. Slide the seat to where you want it and release the bar. Try to move the seat with your body to be sure the seat is locked in place.

Power Seat (Option)

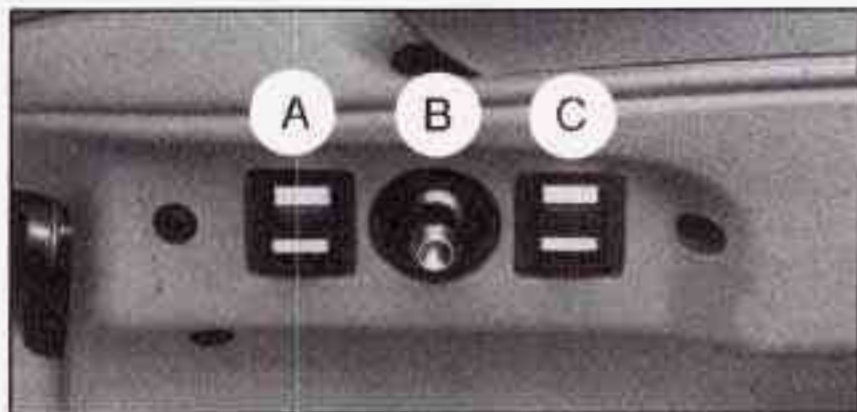

FRONT (A): Raise the front of the seat by holding the switch up. Hold the switch down to lower the front of the seat.

CENTER (B): Move the seat forward or backward by holding the control to the front or back. Raise or lower the seat by holding the control up or down.

REAR (C): Raise the rear of the seat by holding the switch up. Hold the switch down to lower the rear of the seat.

Reclining Front Seatbacks



Lift the lever to release the seatback, then move the seatback to where you want it. Release the lever to lock the seatback in place. Pull up on the lever without pushing on the seatback, and the seatback will move forward.



2-Door Models



4-Door Models

But don't have a seatback reclined if your vehicle is moving.

CAUTION:

Sitting in a reclined position when your vehicle is in motion can be dangerous. Even if you buckle up, your safety belts can't do their job when you're reclined like this.

The shoulder belt can't do its job because it won't be against your body. Instead, it will be in front of you. In a crash you could go into it, receiving neck or other injuries.

The lap belt can't do its job either. In a crash the belt could go up over your abdomen. The belt forces would be there, not at your pelvic bones. This could cause serious internal injuries.

For proper protection when the vehicle is in motion, have the seatback upright. Then sit well back in the seat and wear your safety belt properly.

Head Restraints

Slide the head restraint up or down so that the top of the restraint is closest to the top of your ears. This position reduces the chance of a neck injury in a crash.

Seatback Latches (2-Door Models)



The front seat folds forward to let people get into the back seat. Your seatback will move back and forth freely, unless you come to a sudden stop. Then it will lock in place.

If your vehicle is parked going down a fairly steep hill, the seatback may not fold without some help from you. To fold the locked seatback forward, push the seatback toward the rear as you lift this latch. Then the seatback will fold forward. The latch must be down for the seat to work properly.

Safety Belts: They're for Everyone

This part of the manual tells you how to use safety belts properly. It also tells you some things you should not do with safety belts.

And it explains the Supplemental Restraint System (SRS), or air bag system.

CAUTION:

Don't let anyone ride where he or she can't wear a safety belt properly. If you are in a crash and you're not wearing a safety belt, your injuries can be much worse. You can hit things inside the vehicle or be ejected from it. You can be seriously injured or killed. In the same crash, you might not be if you are buckled up. Always fasten your safety belt, and check that your passengers' belts are fastened properly too.



Your vehicle has a light that comes on as a reminder to buckle up. (See "Safety Belt Reminder Light" in the Index.)

In most states and Canadian provinces, the law says to wear safety belts. Here's why: *They work.*

You never know if you'll be in a crash. If you do have a crash, you don't know if it will be a bad one.

A few crashes are mild, and some crashes can be so serious that even buckled up a person wouldn't survive. But most crashes are in between. In many of them, people who buckle up can survive and sometimes walk away. Without belts they could have been badly hurt or killed.

After more than 25 years of safety belts in vehicles, the facts are clear. In most crashes buckling up does matter ... a lot!

Why Safety Belts Work

When you ride in or on anything, you go as fast as it goes.

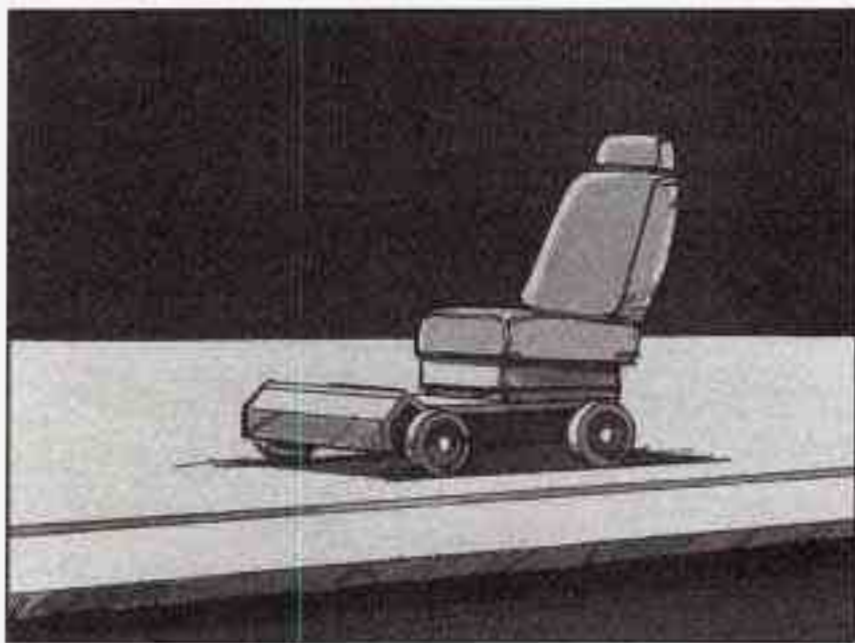

Take the simplest vehicle. Suppose it's just a seat on wheels.

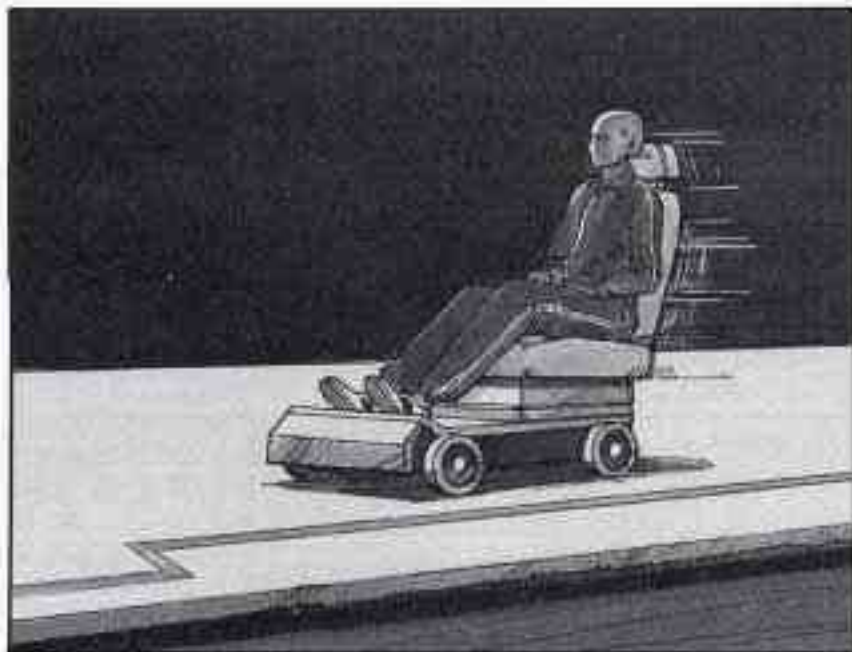

Put someone on it.

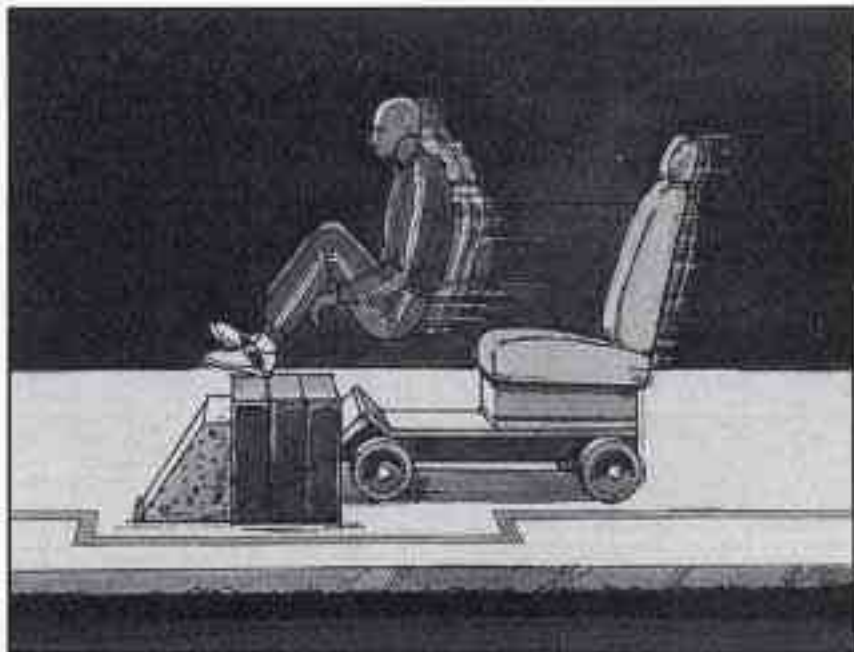

Get it up to speed. Then stop the vehicle. The rider doesn't stop.



The person keeps going until stopped by something.
In a real vehicle, it could be the windshield ...



or the instrument panel ...

Here Are Questions Many People Ask About Safety Belts -- and the Answers

Q: Won't I be trapped in the vehicle after an accident if I'm wearing a safety belt?

A: You *could* be -- whether you're wearing a safety belt or not. But you can unbuckle a safety belt, even if you're upside down. And your chance of being conscious during and after an accident, so you *can* unbuckle and get out, is *much* greater if you are belted.

Q: If my vehicle has air bags, why should I have to wear safety belts?

A: Air bags are in many vehicles today and will be in most of them in the future. But they are supplemental systems only; so they work *with* safety belts -- not instead of them. Every air bag system ever offered for sale has required the use of safety belts. Even if you're in a vehicle that has air bags, you still have to buckle up to get the most protection. That's true not only in frontal collisions, but especially in side and other collisions.



or the safety belts!

With safety belts, you slow down as the vehicle does. You get more time to stop. You stop over more distance, and your strongest bones take the forces. That's why safety belts make such good sense.

Q: If I'm a good driver, and I never drive far from home, why should I wear safety belts?

A: You may be an excellent driver, but if you're in an accident -- even one that isn't your fault -- you and your passengers can be hurt. Being a good driver doesn't protect you from things beyond your control, such as bad drivers.

Most accidents occur within 25 miles (40 km) of home. And the greatest number of serious injuries and deaths occur at speeds of less than 40 mph (65 km/h).

Safety belts are for everyone.

How to Wear Safety Belts Properly

Adults

This part is only for people of adult size.

Be aware that there are special things to know about safety belts and children. And there are different rules for smaller children and babies. If a child will be riding in your Pontiac, see the part of this manual called "Children." Follow those rules for everyone's protection.

First, you'll want to know which restraint systems your vehicle has.

We'll start with the driver position.

Driver Position (2-Door Models)

This part describes the driver's restraint system. If you have a four-door model, see "Driver Position (4-Door Models)" later in this section.

Lap-Shoulder Belt (2-Door Models)

The driver has a lap-shoulder belt. Here's how to wear it properly.

1. Close and lock the door.
2. Adjust the seat (to see how, see "Seats" in the Index) so you can sit up straight.



3. Pick up the latch plate and pull the belt across you. Don't let it get twisted.
4. Push the latch plate into the buckle until it clicks.

Pull up on the latch plate to make sure it is secure. If the belt isn't long enough, see "Safety Belt Extender" at the end of this section.

Make sure the release button on the buckle is positioned so you would be able to unbuckle the safety belt quickly if you ever had to.

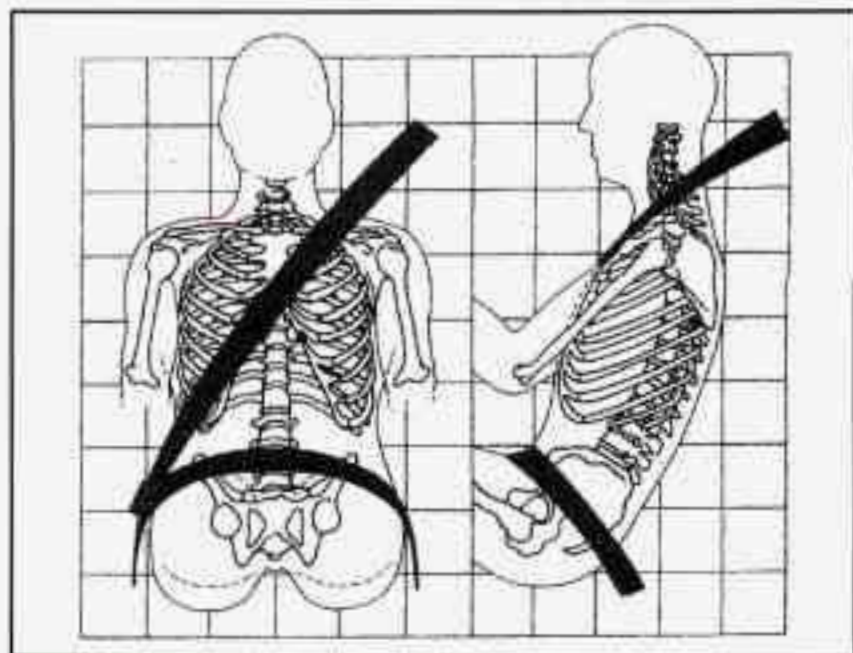

The lap part of the belt should be worn low and snug on the hips, just touching the thighs. In a crash, this applies force to the strong pelvic bones. And you'd be less likely to slide under the lap belt. If you slid under it, the belt would apply force at your abdomen. This could cause serious or even fatal injuries. The shoulder belt should go over the shoulder and across the chest. These parts of the body are best able to take belt restraining forces.

The safety belt locks if there's a sudden stop or crash.

Q: What's wrong with this?

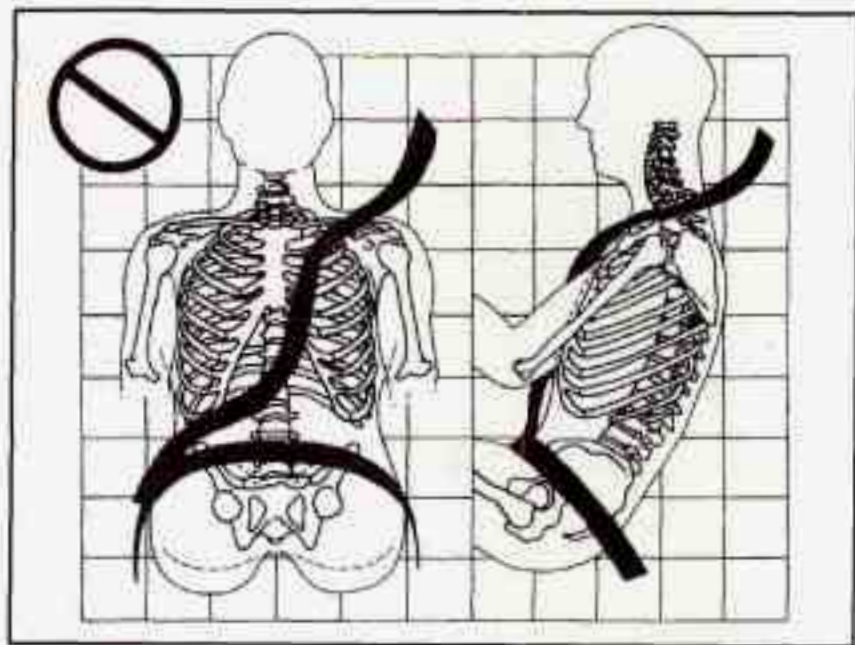

A: The shoulder belt is too loose. It won't give nearly as much protection this way.



CAUTION:

You can be seriously hurt if your shoulder belt is too loose. In a crash, you would move forward too much, which could increase injury. The shoulder belt should fit against your body.

Q: What's wrong with this?

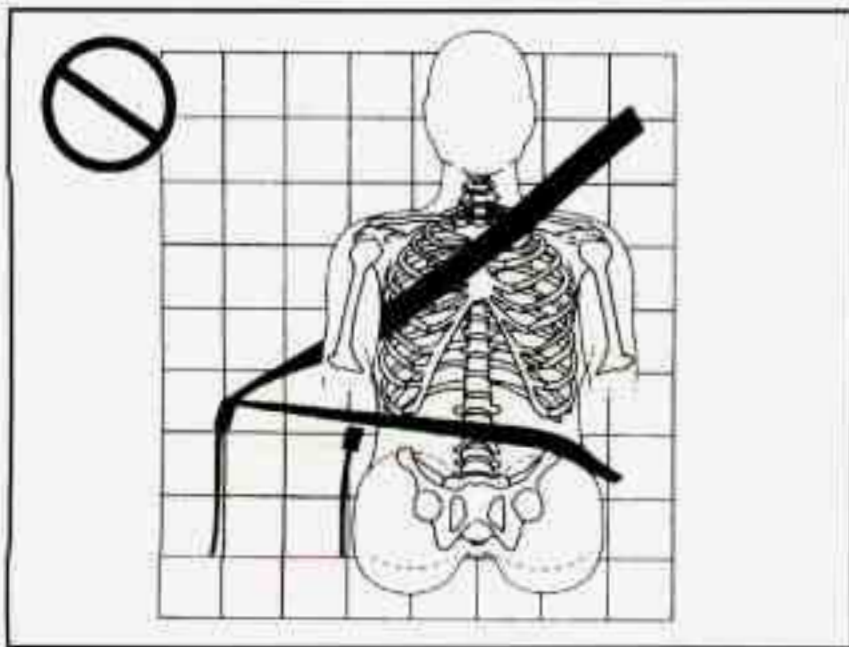

A: The belt is buckled in the wrong place.

⚠ CAUTION:

You can be seriously injured if your belt is buckled in the wrong place like this. In a crash, the belt would go up over your abdomen. The belt forces would be there, not at the pelvic bones. This could cause serious internal injuries. Always buckle your belt into the buckle nearest you.

Q: What's wrong with this?

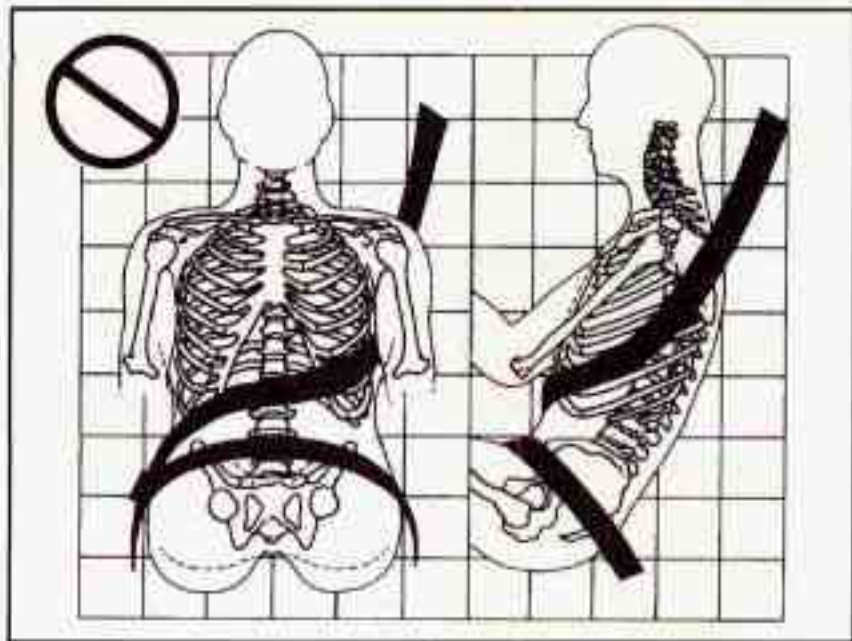

A: The shoulder belt is worn under the arm. It should be worn over the shoulder at all times.

⚠ CAUTION:

You can be seriously injured if you wear the shoulder belt under your arm. In a crash, your body would move too far forward, which would increase the chance of head and neck injury. Also, the belt would apply too much force to the ribs, which aren't as strong as shoulder bones. You could also severely injure internal organs like your liver or spleen.

Q: What's wrong with this?

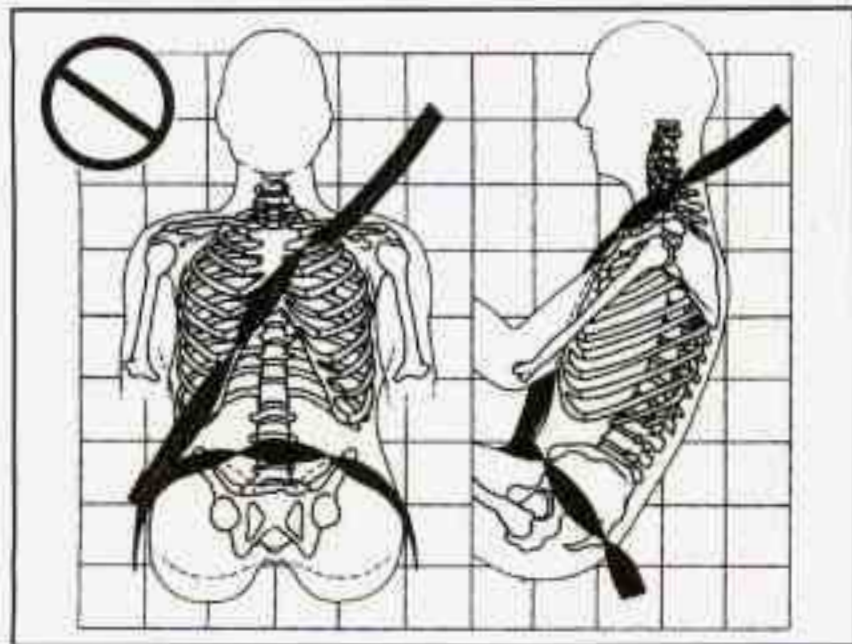

A: The belt is twisted across the body.

⚠ CAUTION:

You can be seriously injured by a twisted belt. In a crash, you wouldn't have the full width of the belt to spread impact forces. If a belt is twisted, make it straight so it can work properly, or ask your dealer to fix it.

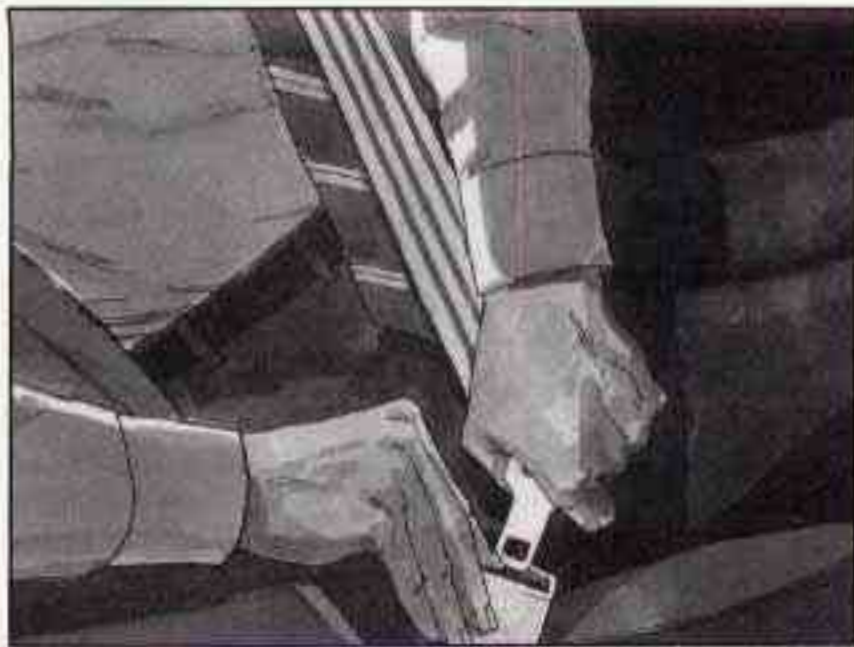

Driver Position (4-Door Models)

This part describes the driver's restraint system. If you have a two-door model, see "Driver Position (2-Door Models)" earlier in this section.

Lap-Shoulder Belt (4-Door Models)

The driver has a lap-shoulder belt. Here's how to wear it properly.

1. Close and lock the door.
2. Adjust the seat (to see how, see "Seats" in the Index) so you can sit up straight.

To unlatch the belt, just push the button on the buckle. The belt should go back out of the way.

Before you close the door, be sure the belt is out of the way. If you slam the door on it, you can damage both the belt and your vehicle.



3. Pick up the latch plate and pull the belt across you. Don't let it get twisted.

The shoulder belt may lock if you pull the belt across you very quickly. If this happens, let the belt go back slightly to unlock it. Then pull the belt across you more slowly.

4. Push the latch plate into the buckle until it clicks.

Pull up on the latch plate to make sure it is secure. If the belt isn't long enough, see "Safety Belt Extender" at the end of this section.

Make sure the release button on the buckle is positioned so you would be able to unbuckle the safety belt quickly if you ever had to.



5. To make the lap part tight, pull down on the buckle end of the belt as you pull up on the shoulder belt.

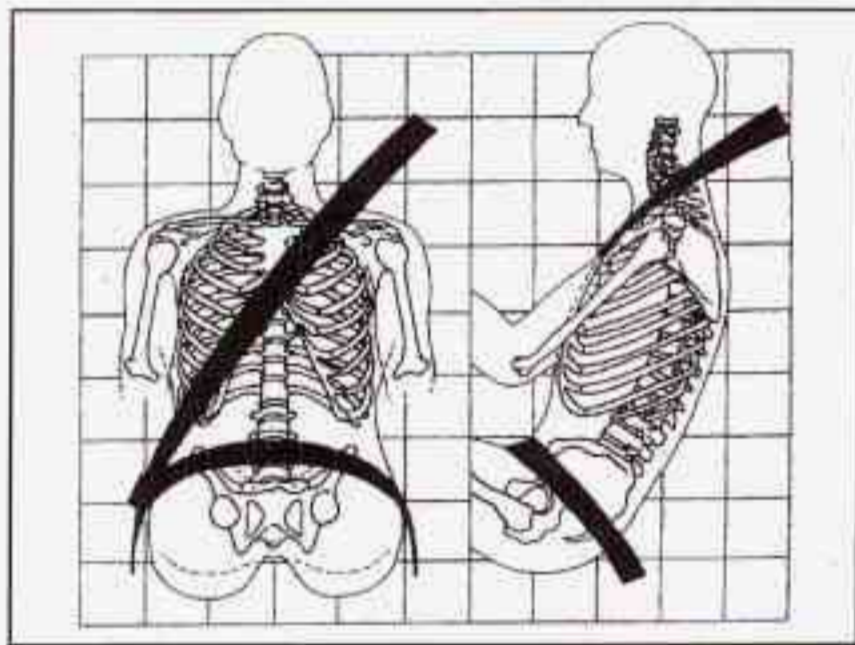

The lap part of the belt should be worn low and snug on the hips, just touching the thighs. In a crash, this applies force to the strong pelvic bones. And you'd be less likely to slide under the lap belt. If you slid under it, the belt would apply force at your abdomen. This could cause serious or even fatal injuries. The shoulder belt should go over the shoulder and across the chest. These parts of the body are best able to take belt restraining forces.

The safety belt locks if there's a sudden stop or crash, or if you pull the belt very quickly out of the retractor.

Q: What's wrong with this?

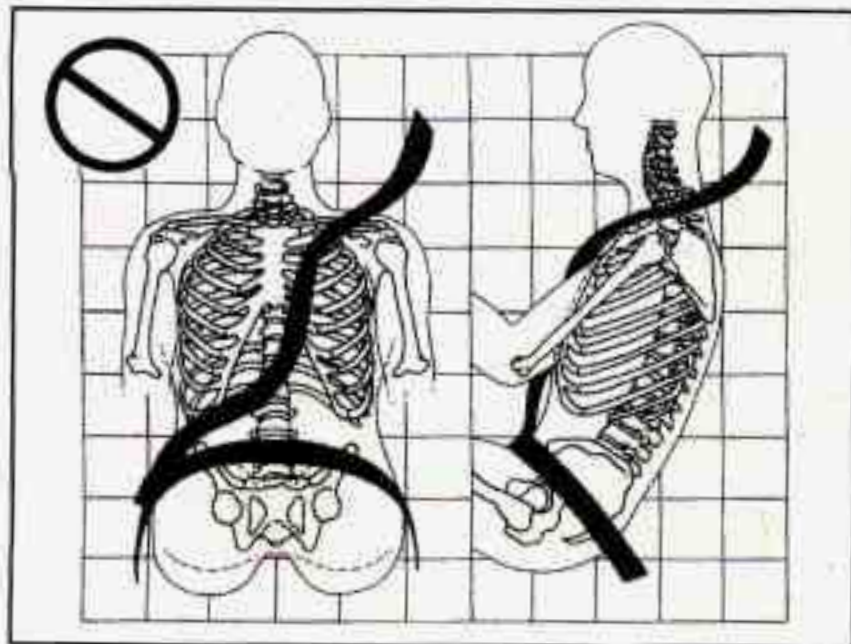

⚠ CAUTION:

You can be seriously hurt if your shoulder belt is too loose. In a crash, you would move forward too much, which could increase injury. The shoulder belt should fit against your body.

A: The shoulder belt is too loose. It won't give nearly as much protection this way.

Q: What's wrong with this?

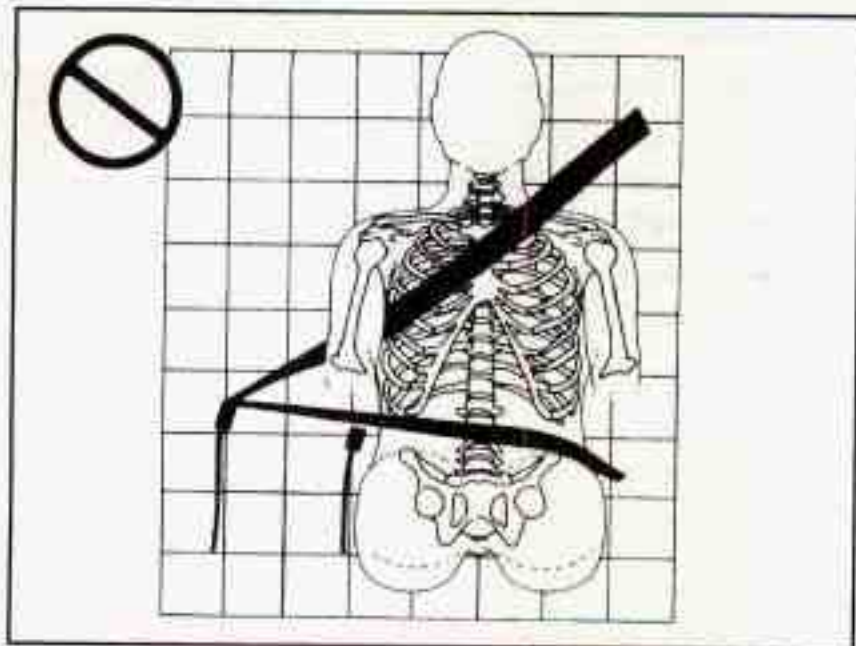

⚠ CAUTION:

You can be seriously injured if your belt is buckled in the wrong place like this. In a crash, the belt would go up over your abdomen. The belt forces would be there, not at the pelvic bones. This could cause serious internal injuries. Always buckle your belt into the buckle nearest you.

A: The belt is buckled in the wrong place.

Q: What's wrong with this?

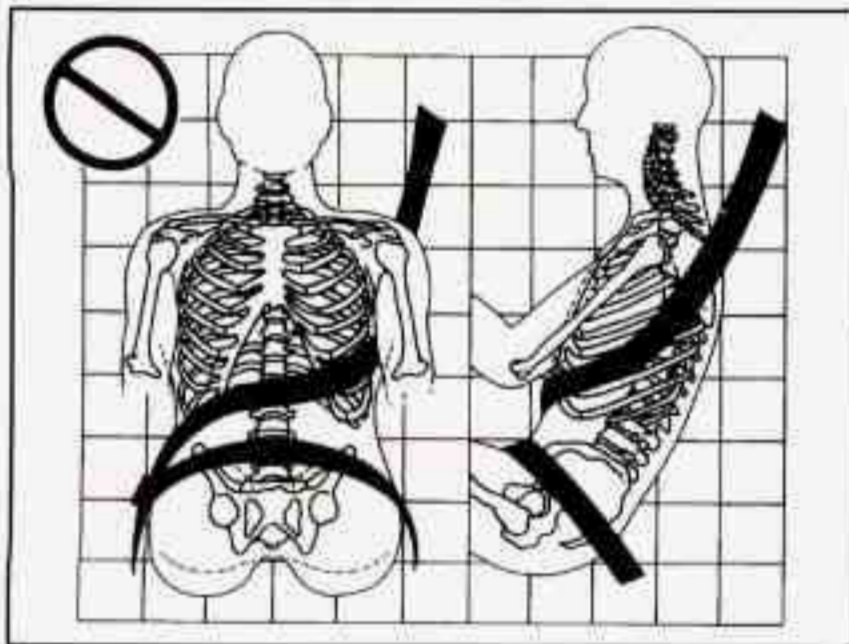

⚠ CAUTION:

You can be seriously injured if you wear the shoulder belt under your arm. In a crash, your body would move too far forward, which would increase the chance of head and neck injury. Also, the belt would apply too much force to the ribs, which aren't as strong as shoulder bones. You could also severely injure internal organs like your liver or spleen.

A: The shoulder belt is worn under the arm. It should be worn over the shoulder at all times.

Q: What's wrong with this?

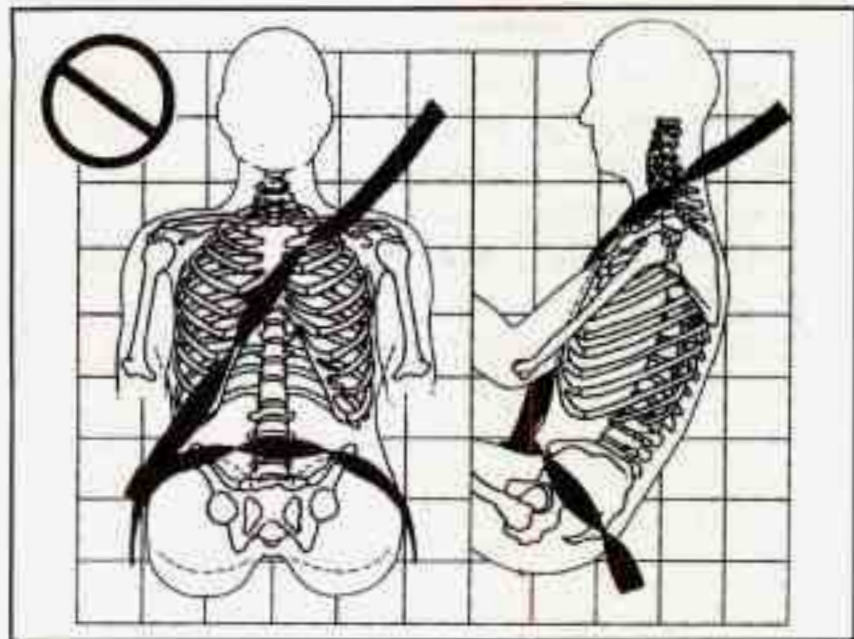

A: The belt is twisted across the body.

⚠ CAUTION:

You can be seriously injured by a twisted belt. In a crash, you wouldn't have the full width of the belt to spread impact forces. If a belt is twisted, make it straight so it can work properly, or ask your dealer to fix it.



Supplemental Restraint System (SRS)

This part explains the Supplemental Restraint System (SRS) or air bag system.

Your Pontiac has two air bags -- one air bag for the driver and another air bag for the right front passenger.

Here are the most important things to know about the air bag system:

To unlatch the belt, just push the button on the buckle. The belt should go back out of the way.

Before you close the door, be sure the belt is out of the way. If you slam the door on it, you can damage both the belt and your vehicle.

 **CAUTION:**

You can be severely injured or killed in a crash if you aren't wearing your safety belt -- even if you have an air bag. Wearing your safety belt during a crash helps reduce your chance of hitting things inside the vehicle or being ejected from it. The air bag is only a "supplemental restraint." That is, it works with safety belts but doesn't replace them. Air bags are designed to work **only** in moderate to severe crashes where the front of your vehicle hits something. They aren't designed to inflate at all in rollover, rear, side or low-speed frontal crashes. Everyone in your vehicle, including the driver, should wear a safety belt properly -- whether or not there's an air bag for that person.

 **CAUTION:**

Air bags inflate with great force, faster than the blink of an eye. If you're too close to an inflating air bag, it could seriously injure you. Safety belts help keep you in position for an air bag inflation in a crash. Always wear your safety belt, even with an air bag. The driver should sit as far back as possible while still maintaining control of the vehicle.

 **CAUTION:**

An inflating air bag can seriously injure small children. Always secure children properly in your vehicle. To read how, see the part of this manual called "Children" and the caution label on the right front passenger's safety belt.

SRS AIR BAG

There is an air bag readiness light on the instrument panel, which shows SRS AIR BAG or the air bag symbol.

The system checks the air bag's electrical system for malfunctions. The light tells you if there is an electrical problem. See "Air Bag Readiness Light" in the Index for more information.

How the Air Bag System Works



Where is the air bag?

The driver's air bag is in the middle of the steering wheel.

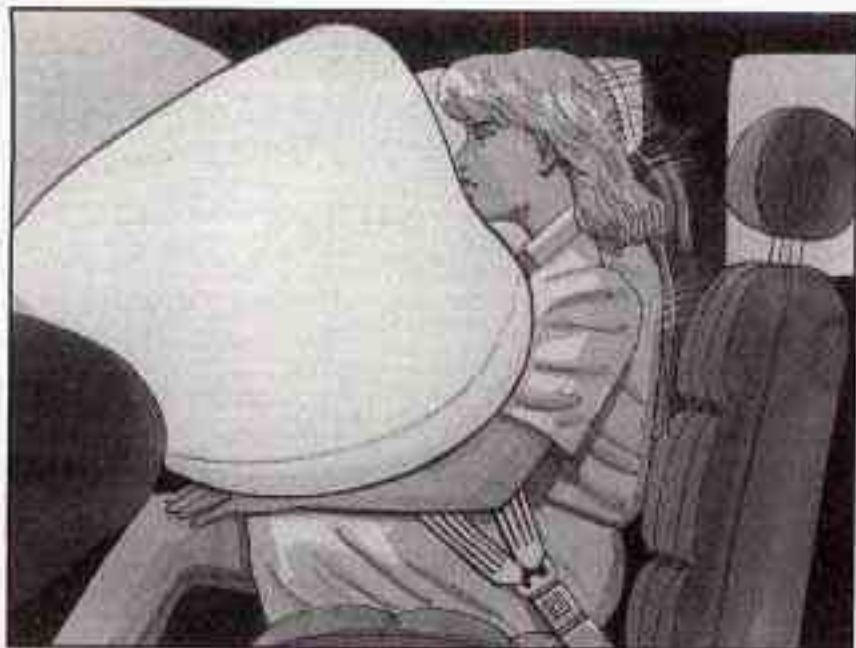

The right front passenger's air bag is in the instrument panel on the passenger's side.

⚠ CAUTION:

Don't put anything on, or attach anything to, the steering wheel or instrument panel. Also, don't put anything (such as pets or objects) between any occupant and the steering wheel or instrument panel. If something is between an occupant and an air bag, it could affect the performance of the air bag -- or worse, it could cause injury.

When should an air bag inflate?

The air bag is designed to inflate in moderate to severe frontal or near-frontal crashes. The air bag will inflate only if the impact speed is above the system's designed "threshold level." If your vehicle goes straight into a wall that doesn't move or deform, the threshold level is about 9 to 15 mph (14 to 24 km/h). The threshold level can vary, however, with specific vehicle design, so that it can be somewhat above or below this range. If your vehicle strikes something that will move or deform, such as a parked car, the threshold level will be higher. The air bag is not designed to inflate in rollovers, side impacts or rear impacts, because inflation would not help the occupant.

In any particular crash, no one can say whether an air bag should have inflated simply because of the damage to a vehicle or because of what the repair costs were. Inflation is determined by the angle of the impact and the vehicle's deceleration. Vehicle damage is only one indication of this.

What makes an air bag inflate?

In a frontal or near-frontal impact of sufficient severity, the air bag sensing system detects that the vehicle is suddenly stopping as a result of a crash. The sensing system triggers a chemical reaction of the sodium azide sealed in the inflator. The reaction produces nitrogen gas, which inflates the air bag. The inflator, air bag and related hardware are all part of the air bag modules packed inside the steering wheel and in the instrument panel in front of the right front passenger.

How does an air bag restrain?

In moderate to severe frontal or near-frontal collisions, even belted occupants can contact the steering wheel or the instrument panel. The air bag supplements the protection provided by safety belts. Air bags distribute the force of the impact more evenly over the occupant's upper body, stopping the occupant more gradually. But air bags would not help you in many types of collisions, including rollovers, rear impacts and side impacts, primarily because an occupant's motion is not toward the air bag. Air bags should never be regarded as anything more than a supplement to safety belts, and then only in moderate to severe frontal or near-frontal collisions.

What will you see after an air bag inflates?

After the air bag inflates, it quickly deflates. This occurs so quickly that some people may not even realize the air bag inflated. Some components of the air bag module in the steering wheel hub for the driver's air bag, or the instrument panel for the right front passenger's bag, will be hot for a short time. The part of the bag that comes into contact with you may be warm, but it will never be too hot to touch. There will be some smoke and dust coming from vents in the deflated air bags. Air bag inflation will not prevent the driver from seeing or from being able to steer the vehicle, nor will it stop people from leaving the vehicle.



CAUTION:

When an air bag inflates, there is dust in the air. This dust could cause breathing problems for people with a history of asthma or other breathing trouble. To avoid this, everyone in the vehicle should get out as soon as it is safe to do so. If you have breathing problems but can't get out of the vehicle after an air bag inflates, then get fresh air by opening a window or door.

In many crashes severe enough to inflate an air bag, windshields are broken by vehicle deformation. Additional windshield breakage may also occur from the right front passenger's air bag.

- The air bags are designed to inflate only once. After they inflate, you'll need some new parts for your air bag system. If you don't get them, the air bag system won't be there to help protect you in another crash. A new system will include air bag modules and possibly other parts. The service manual for your vehicle covers the need to replace other parts.

- Your vehicle is equipped with a crash sensing and diagnostic module, which records information about the air bag system. The module records information about the readiness of the system, when the sensors are activated and driver's safety belt usage at deployment.
- Let only qualified technicians work on your air bag system. Improper service can mean that your air bag system won't work properly. See your dealer for service.

NOTICE:

If you damage the cover for the driver's or the right front passenger's air bag, they may not work properly. You may have to replace the air bag module in the steering wheel or both the air bag module and the instrument panel for the right front passenger's air bag. Do not open or break the air bag covers.

Servicing Your Air Bag-Equipped Pontiac

Air bags affect how your Pontiac should be serviced. There are parts of the air bag system in several places around your vehicle. You don't want the system to inflate while someone is working on your vehicle. Your Pontiac dealer and the Grand Prix Service Manual have information about servicing your vehicle and the air bag system. To purchase a service manual, see "Service and Owner Publications" in the Index.



CAUTION:

For up to 10 seconds after the ignition key is turned off and the battery is disconnected, an air bag can still inflate during improper service. You can be injured if you are close to an air bag when it inflates. Avoid wires wrapped with yellow tape or yellow connectors. They are probably part of the air bag system. Be sure to follow proper service procedures, and make sure the person performing work for you is qualified to do so.

The air bag system does not need regular maintenance.

Safety Belt Use During Pregnancy

Safety belts work for everyone, including pregnant women. Like all occupants, they are more likely to be seriously injured if they don't wear safety belts.

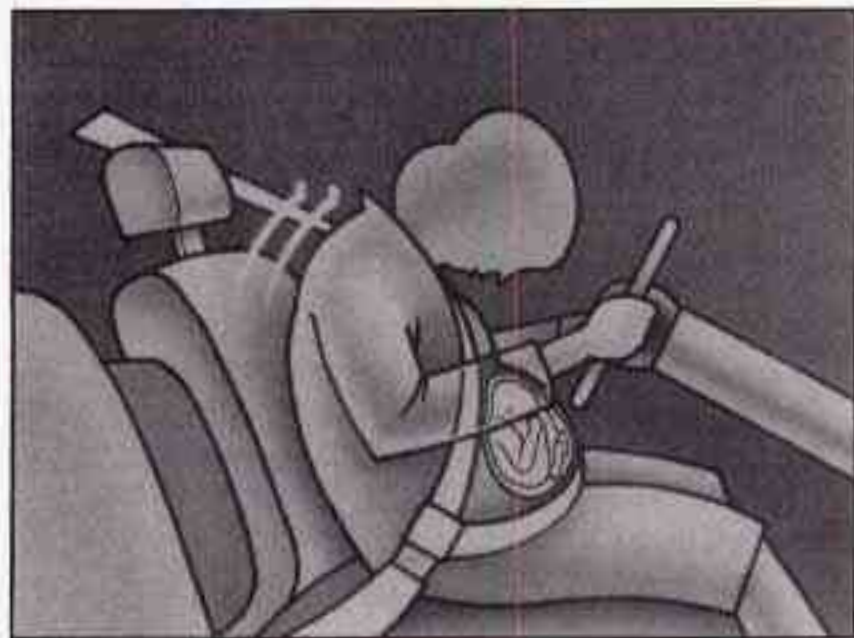

A pregnant woman should wear a lap-shoulder belt, and the lap portion should be worn as low as possible, below the rounding, throughout the pregnancy.

The best way to protect the fetus is to protect the mother. When a safety belt is worn properly, it's more likely that the fetus won't be hurt in a crash. For pregnant women, as for anyone, the key to making safety belts effective is wearing them properly.

Right Front Passenger Position (2-Door Models)

This part describes the right front passenger's restraint system. If you have a four-door model, see "Right Front Passenger Position (4-Door Models)" later in this section.

Was your two-door Pontiac first sold, when new, in Canada? (If it was, a sticker on the driver's door will say "conforms to all applicable Canada motor vehicle . . ." etc.) If so, then this "Right Front Passenger Position (2-Door Models)" part doesn't apply to your vehicle. In two-door models first sold in Canada, the right front passenger's safety belt works the same way as the driver's safety belt. See "Driver Position (2-Door Models)" earlier in this section.

Automatic Lap-Shoulder Belt (2-Door Models)



This safety belt is called "automatic" because you don't have to buckle up when you get into your vehicle.

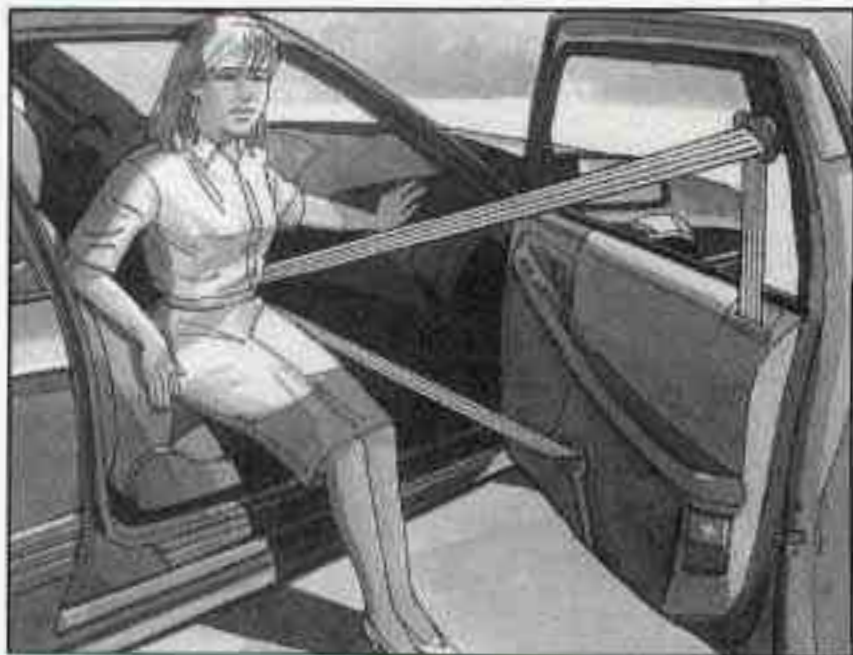

And you don't have to unbuckle when you get out. Just get into your vehicle. Then close and lock the door. Adjust the seat (to see how, see "Seats" in the Index) so you can sit up straight.

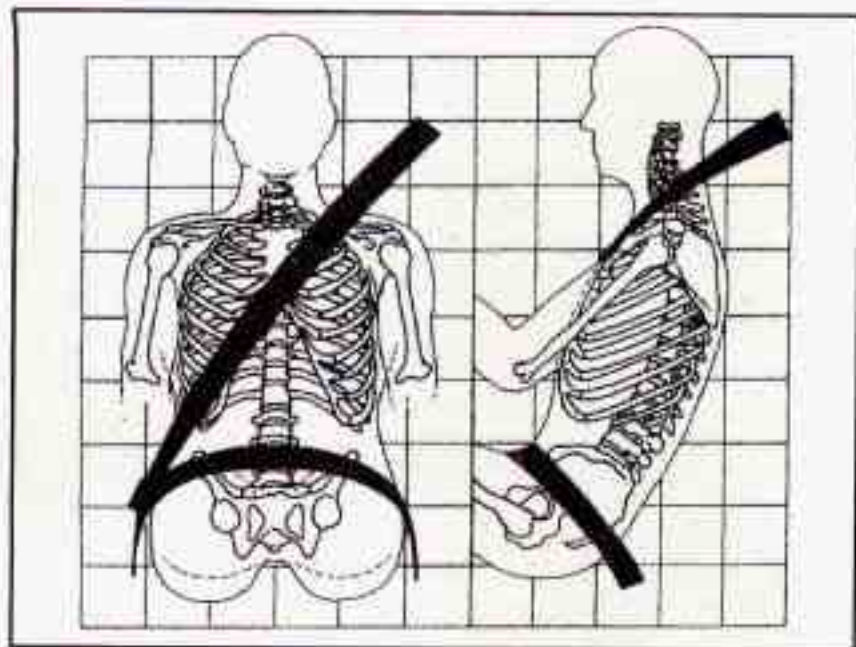

The lap belt should be worn as low on the hips as possible. In a crash, this applies force to the strong pelvic bones. And you'd be less likely to slide under the lap belt. If you slid under it, the belt would apply force at your abdomen. This could cause serious or even fatal injuries. The shoulder belt should go over the shoulder and across the chest. These parts of the body are best able to take belt restraining forces.

The safety belt locks if there's a sudden stop or a crash.

It's possible that an automatic belt could keep you from fully opening a door. That can happen if the door was slammed shut very hard. Just close the door all the way, then slowly open it. If that doesn't fix it, then your Pontiac needs service.

We hope you'll always keep your automatic belt buckled. However, you may need to unbuckle it in an emergency. And you would need to unbuckle it to let someone get into the center front seat position, if your vehicle has one.



To unbuckle the automatic belt, just push the button on the buckle.

To reattach the automatic belt:

1. Close and lock the door.
2. Adjust the seat (to see how, see "Seats" in the Index) so you can sit up straight.

3. Pick up the latch plate and pull the belt across you. Don't let it get twisted.
4. Push the latch plate into the buckle until it clicks. Pull up on the latch plate to make sure it is secure.

Right Front Passenger Position (4-Door Models)

If you have a two-door model, see “Right Front Passenger Position (2-Door Models)” earlier in this section.

Lap-Shoulder Belt (4-Door Models)

The right front passenger’s safety belt works the same way as the driver’s safety belt. See “Driver Position (4-Door Models),” earlier in this section. When the shoulder belt is pulled out all the way, it will lock. If it does, let it go back all the way and start again.

Center Passenger Position

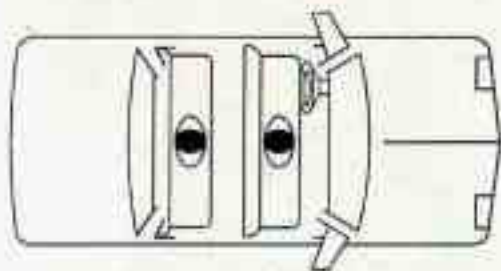

Lap Belt

If your vehicle has a bench seat, someone can sit in the center position.



When you sit in a center seating position, you have a lap safety belt, which has no retractor. To make the belt longer, tilt the latch plate and pull it along the belt.



To make the belt shorter, pull its free end as shown until the belt is snug.

Buckle, position and release it the same way as the lap part of a lap-shoulder belt. If the belt isn't long enough, see "Safety Belt Extender" at the end of this section.

Make sure the release button on the buckle is positioned so you would be able to unbuckle the safety belt quickly if you ever had to.

Rear Seat Passengers

It's very important for rear seat passengers to buckle up! Accident statistics show that unbelted people in the rear seat are hurt more often in crashes than those who are wearing safety belts.

Rear passengers who aren't safety belted can be thrown out of the vehicle in a crash. And they can strike others in the vehicle who are wearing safety belts.

Rear Seat Outside Passenger Positions

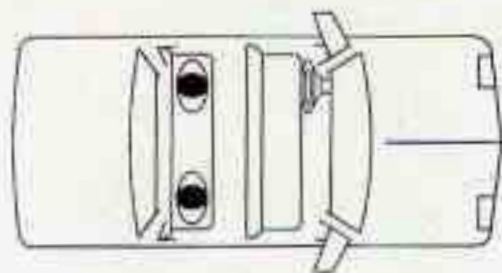

Lap-Shoulder Belt

The positions next to the windows have lap-shoulder belts. Here's how to wear one properly.

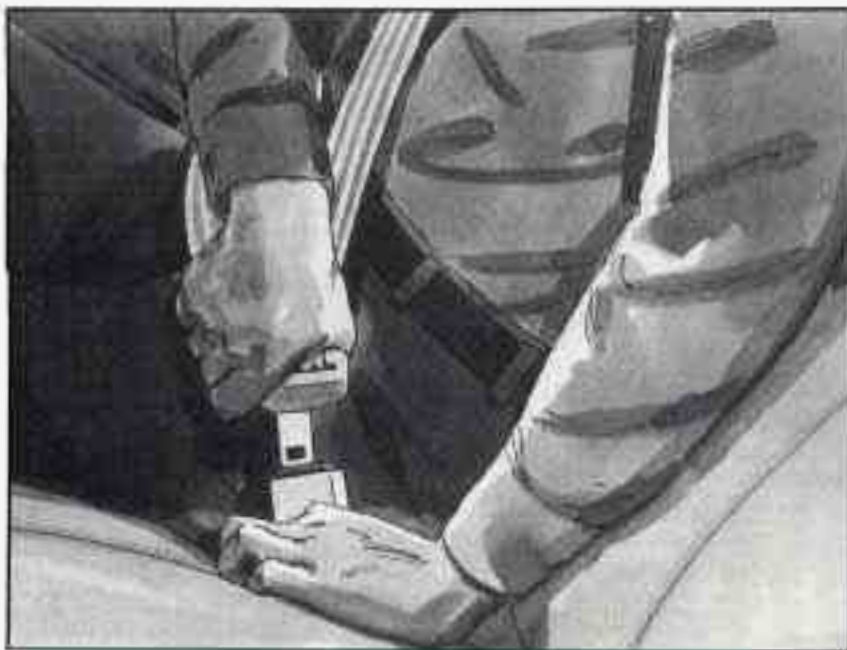

When the shoulder belt is pulled out all the way, it will lock. If it does, let it go back all the way and start again. If the belt is not long enough, see "Safety Belt Extender" at the end of this section. Make sure the release button on the buckle is positioned so you would be able to unbuckle the safety belt quickly if you ever had to.



1. Pick up the latch plate and pull the belt across you. Don't let it get twisted.

The shoulder belt may lock if you pull the belt across you very quickly. If this happens, let the belt go back slightly to unlock it. Then pull the belt across you more slowly.

2. Push the latch plate into the buckle until it clicks.
Pull up on the latch plate to make sure it is secure.

3. To make the lap part tight, pull down on the buckle end of the belt as you pull up on the shoulder part.

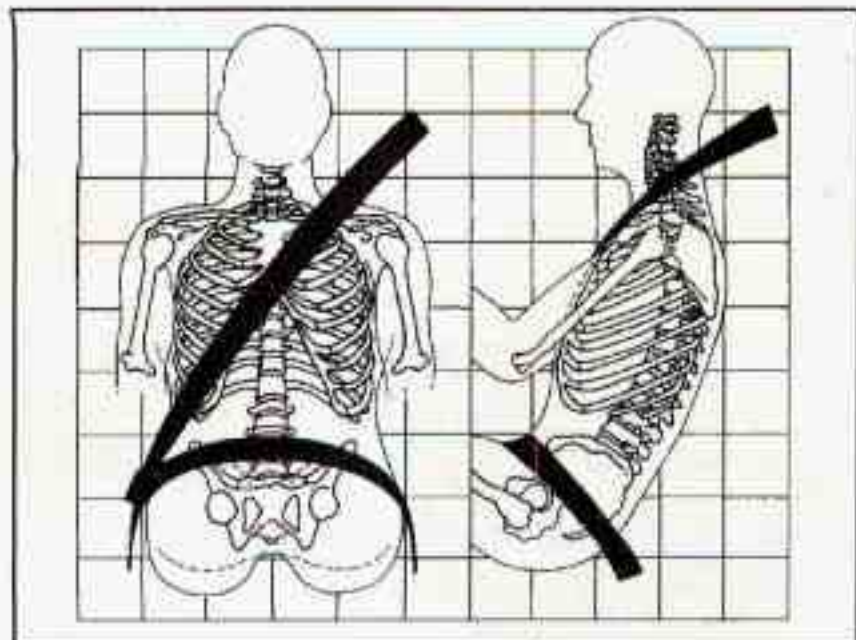

The lap part of the belt should be worn low and snug on the hips, just touching the thighs. In a crash, this applies force to the strong pelvic bones. And you'd be less likely to slide under the lap belt. If you slid under it, the belt would apply force at your abdomen. This could cause serious or even fatal injuries. The shoulder belt should go over the shoulder and across the chest. These parts of the body are best able to take belt restraining forces.

The safety belt locks if there's a sudden stop or a crash, or if you pull the belt very quickly out of the retractor.

⚠ CAUTION:

You can be seriously hurt if your shoulder belt is too loose. In a crash, you would move forward too much, which could increase injury. The shoulder belt should fit against your body.



To unlatch the belt, just push the button on the buckle.

Rear Safety Belt Comfort Guides for Children and Small Adults (4-Door Models)

Four-door models may have rear shoulder belt comfort guides. This feature will provide added safety belt comfort for children who have outgrown child restraints and for small adults. When installed on a shoulder belt, the comfort guide pulls the belt away from the neck and head.

There is one guide for each outside passenger position in the rear seat. To provide added safety belt comfort for children who have outgrown child restraints and for smaller adults, the comfort guides may be installed on the shoulder belts. Here's how to install a comfort guide and use the safety belt:

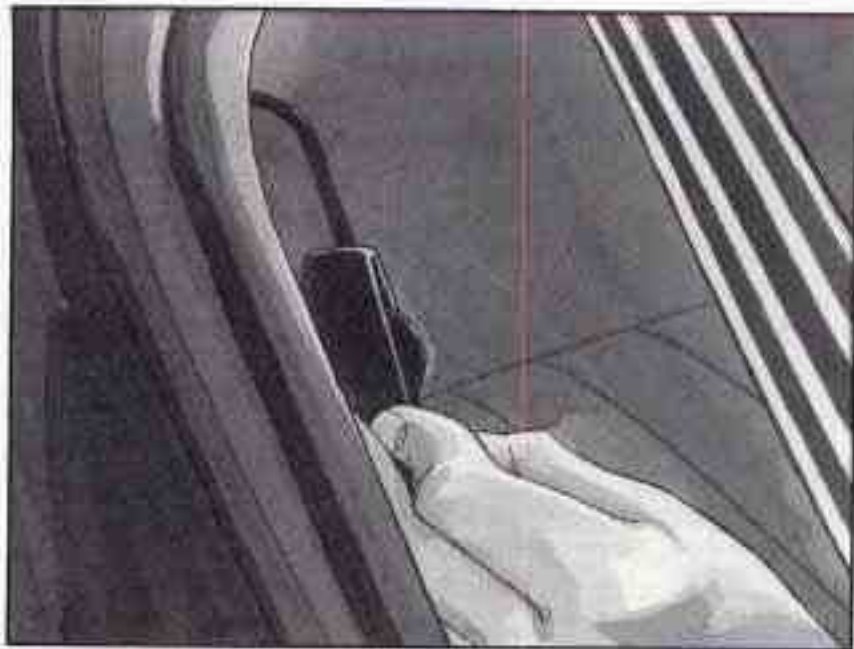

1. Pull the elastic cord out from between the edge of the seatback and the interior body to remove the guide from its storage clip.

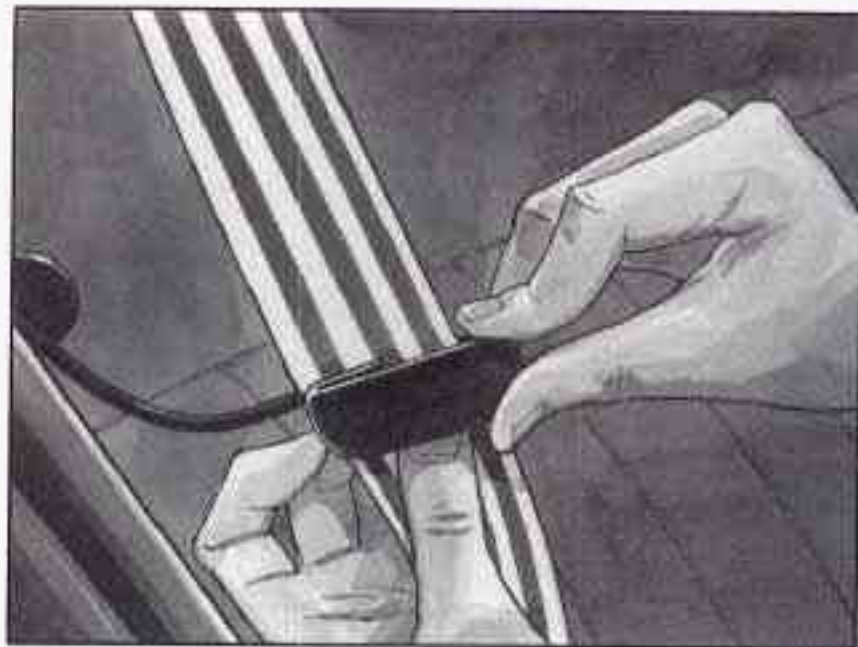

2. Slide the guide under and past the belt. The elastic cord must be under the belt. Then, place the guide over the belt, and insert the two edges of the belt into the slots of the guide.

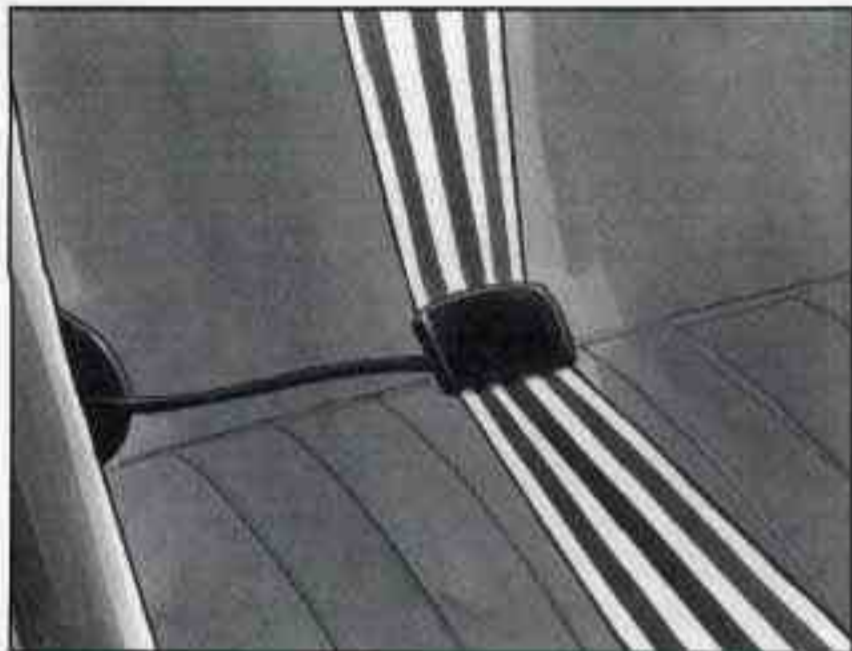

3. Be sure that the belt is not twisted and it lies flat. The elastic cord must be under the belt and the guide on top.



4. Buckle, position and release the safety belt as described in "Rear Seat Outside Passenger Positions (4-Door Models)" earlier in this section. Make sure that the shoulder belt crosses the shoulder.

To remove and store the comfort guides, just perform these steps in reverse order. Squeeze the belt edges together so that you can take them out from the guides. Pull the guide upward to expose its storage clip, and then slide the guide onto the clip. Rotate the guide and clip inward and in between the seatback and the interior body, leaving only the loop of elastic cord exposed.

Children

Everyone in a vehicle needs protection! That includes infants and all children smaller than adult size. In fact, the law in every state in the United States and in every Canadian province says children up to some age must be restrained while in a vehicle.

Smaller Children and Babies



CAUTION:

Smaller children and babies should always be restrained in a child or infant restraint. The instructions for the restraint will say whether it is the right type and size for your child. A very young child's hip bones are so small that a regular belt might not stay low on the hips, as it should. Instead, the belt will likely be over the child's abdomen. In a crash, the belt would apply force right on the child's abdomen, which could cause serious or fatal injuries. So, be sure that any child small enough for one is always properly restrained in a child or infant restraint.



CAUTION: (Continued)

at only 25 mph (40 km/h), a 12-lb. (5.5 kg) baby will suddenly become a 240-lb. (110 kg) force on your arms. The baby would be almost impossible to hold.

Secure the baby in an infant restraint.

⚠ CAUTION:

Never hold a baby in your arms while riding in a vehicle. A baby doesn't weigh much -- until a crash. During a crash a baby will become so heavy you can't hold it. For example, in a crash

CAUTION: (Continued)



Child Restraints

Be sure the child restraint is designed to be used in a vehicle. If it is, it will have a label saying that it meets Federal Motor Vehicle Safety Standards.

Then follow the instructions for the restraint. You may find these instructions on the restraint itself or in a booklet, or both. These restraints use the belt system in your vehicle, but the child also has to be secured within the restraint to help reduce the chance of personal injury. The instructions that come with the infant or child restraint will show you how to do that.

Where to Put the Restraint

Accident statistics show that children are safer if they are restrained in the rear rather than the front seat. We at General Motors therefore recommend that you put your child restraint in the rear seat. *Never* put a rear-facing child restraint in the front passenger seat. Here's why:

CAUTION:

A child in a rear-facing child restraint can be seriously injured if the right front passenger's air bag inflates. This is because the back of a rear-facing child restraint would be very close to the inflating air bag. Always secure a rear-facing child restraint in the rear seat.

You may, however, secure a forward-facing child restraint in the right front seat. Before you secure a forward-facing child restraint, always move the front passenger seat as far back as it will go. Or, secure the child restraint in the rear seat.

⚠ CAUTION:

A child in a child restraint in the center front seat can be badly injured by the right front passenger air bag if it inflates. Never secure a child restraint in the center front seat. It's always better to secure a child restraint in the rear seat. You may, however, secure a forward-facing child restraint in the right front passenger seat, but only with the seat moved all the way back.

Wherever you install it, be sure to secure the child restraint properly.

Keep in mind that an unsecured child restraint can move around in a collision or sudden stop and injure people in the vehicle. Be sure to properly secure any child restraint in your vehicle -- even when no child is in it.

Top Strap

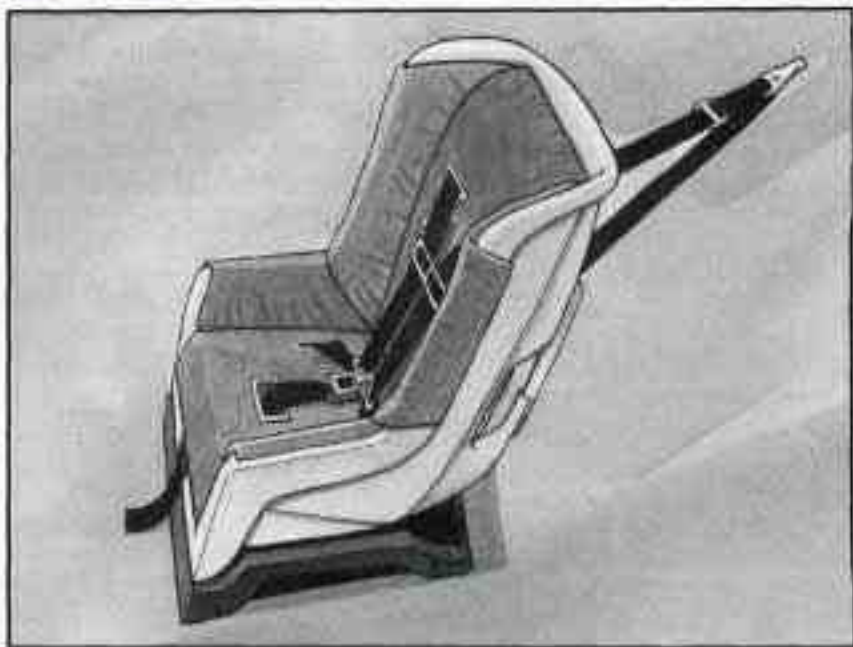

If your child restraint has a top strap, it should be anchored. If you need to have an anchor installed, you can ask your Pontiac dealer to put it in for you. If you want to install an anchor yourself, your dealer can tell you how to do it.

For cars first sold in Canada, child restraints with a top strap must be anchored according to Canadian law.

Your dealer can obtain the hardware kit and install it for you, or you may install it yourself using the instructions provided in the kit.

Use the tether hardware kit available from the dealer. The hardware and installation instructions were specifically designed for this vehicle.

Securing a Child Restraint in a Rear Outside Seat Position

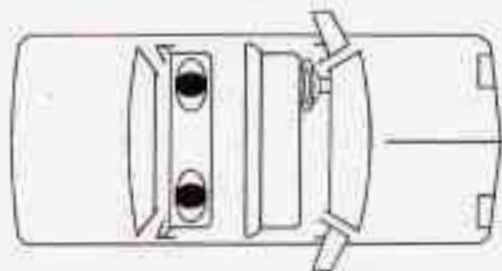

You'll be using the lap-shoulder belt. See the earlier part about the top strap if the child restraint has one.

1. Put the restraint on the seat. Follow the instructions for the child restraint.
2. Secure the child in the child restraint as the instructions say.
3. Pick up the latch plate, and run the lap and shoulder portions of the vehicle's safety belt through or around the restraint. The child restraint instructions will show you how.

If the shoulder belt goes in front of the child's face or neck, put it behind the child restraint.



4. Buckle the belt. Make sure the release button is positioned so you would be able to unbuckle the safety belt quickly if you ever had to.



5. Pull the rest of the shoulder belt all the way out of the retractor to set the lock.

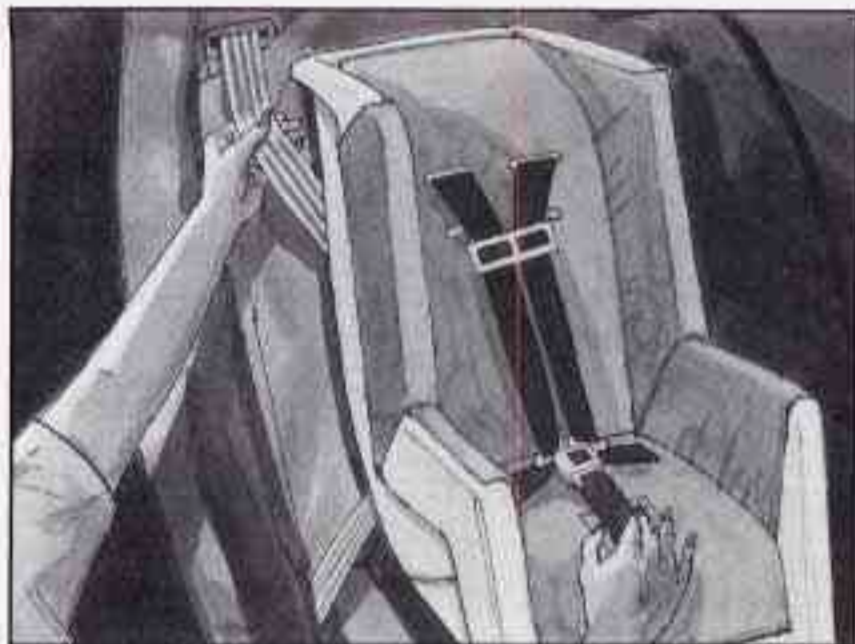

6. To tighten the belt, feed the shoulder belt back into the retractor while you push down on the child restraint.
7. Push and pull the child restraint in different directions to be sure it is secure.

To remove the child restraint, just unbuckle the vehicle's safety belt and let it go back all the way. The safety belt will move freely again and be ready to work for an adult or larger child passenger.

Securing a Child Restraint in the Center Rear Seat Position

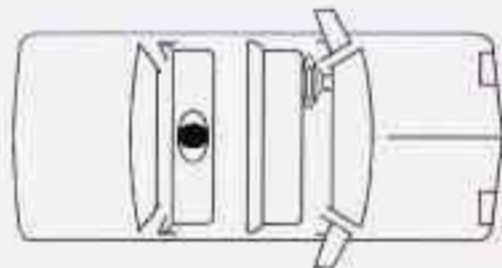

You'll be using the lap belt.

CAUTION:

A child in a child restraint in the center front seat can be badly injured by the right front passenger air bag if it inflates. Never secure a child restraint in the center front seat. It's always better to secure a child restraint in the rear seat. You may, however, secure a forward-facing child restraint in the right front passenger seat, but only with the seat moved all the way back.

See the earlier part about the top strap if the child restraint has one.



1. Make the belt as long as possible by tilting the latch plate and pulling it along the belt.
2. Put the restraint on the seat. Follow the instructions for the child restraint.
3. Secure the child in the child restraint as the instructions say.
4. Run the vehicle's safety belt through or around the restraint. The child restraint instructions will show you how.
5. Buckle the belt. Make sure the release button is positioned so you would be able to unbuckle the safety belt quickly if you ever had to.
6. To tighten the belt, pull its free end while you push down on the child restraint.
7. Push and pull the child restraint in different directions to be sure it is secure. If it isn't, secure the restraint in a different place in the vehicle and contact the child restraint maker for their advice about how to attach the child restraint properly.

To remove the child restraint, just unbuckle the vehicle's safety belt. It will be ready to work for an adult or larger child passenger.

Securing a Child Restraint in the Right Front Seat Position (4-Door Models)

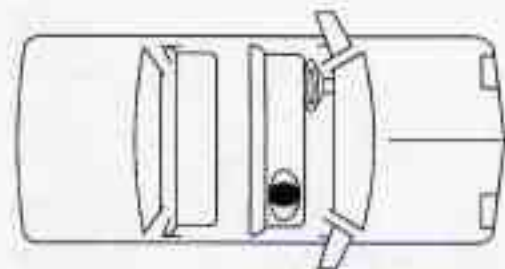

If you have a two-door model, see "Securing a Child Restraint in the Right Front Seat Position (2-Door Models)" later in this section.

Your vehicle has a right front passenger air bag. *Never* put a rear-facing child restraint in this seat. Here's why:

CAUTION:

A child in a rear-facing child restraint can be seriously injured if the right front passenger's air bag inflates. This is because the back of a rear-facing child restraint would be very close to the inflating air bag. Always secure a rear-facing child restraint in the rear seat.

You'll be using the lap-shoulder belt. See the earlier part about the top strap if the child restraint has one.

1. Because your vehicle has a right front passenger air bag, always move the seat as far back as it will go before securing a forward-facing child restraint. (See "Seats" in the Index.)
2. Put the restraint on the seat. Follow the instructions for the child restraint.
3. Secure the child in the child restraint as the instructions say.
4. Pick up the latch plate, and run the lap and shoulder portions of the vehicle's safety belt through or around the restraint. The child restraint instructions will show you how.

If the shoulder belt goes in front of the child's face or neck, put it behind the child restraint.



5. Buckle the belt. Make sure the release button is positioned so you would be able to unbuckle the safety belt quickly if you ever had to.



6. Pull the rest of the shoulder belt all the way out of the retractor to set the lock.

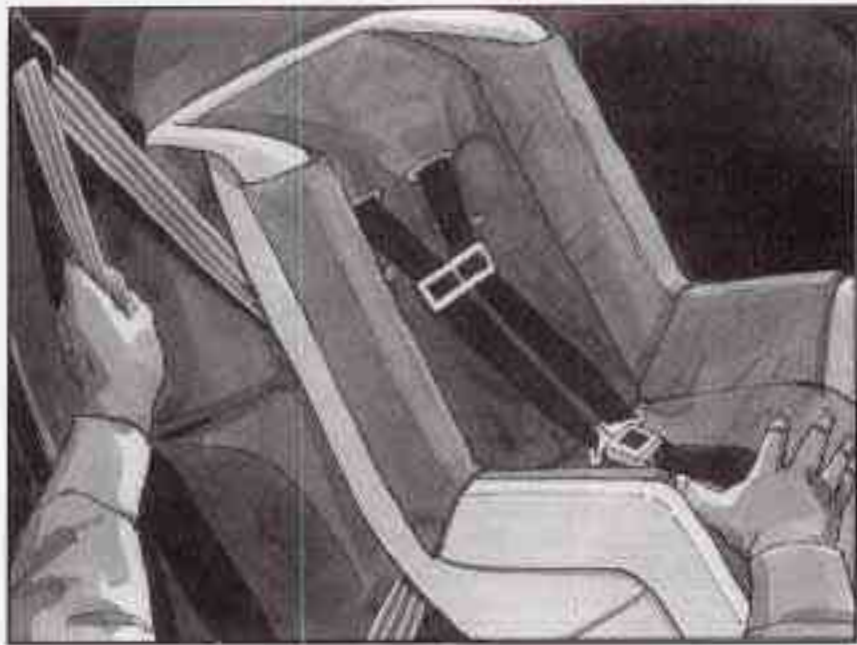

7. To tighten the belt, feed the shoulder belt back into the retractor while you push down on the child restraint.
8. Push and pull the child restraint in different directions to be sure it is secure.

To remove the child restraint, just unbuckle the vehicle's safety belt and let it go back all the way. The safety belt will move freely again and be ready to work for an adult or larger child-passenger.

Securing a Child Restraint in the Right Front Seat Position (2-Door Models)

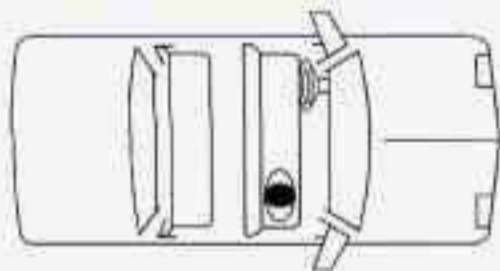

If you have a four-door model, see "Securing a Child Restraint in the Right Front Seat Position (4-Door Models)" earlier in this section.

Was your two-door Pontiac first sold, when new, in Canada? (If it was, a sticker on the driver's door will say "conforms to all applicable Canada motor vehicle . . ." etc.) If so, then this "Securing a Child Restraint in the Right Front Seat Position (2-Door Models)" part doesn't apply to your vehicle. To learn how to secure a child restraint in the right front seat, read the *Canadian Owner's Manual Safety Belt Supplement*. It comes with every new vehicle first sold in Canada.

Your vehicle has a right front passenger air bag. *Never* put a rear-facing child restraint in this seat. Here's why:

CAUTION:

A child in a rear-facing child restraint can be seriously injured if the right front passenger's air bag inflates. This is because the back of a rear-facing child restraint would be very close to the inflating air bag. Always secure a rear-facing child restraint in the rear seat.

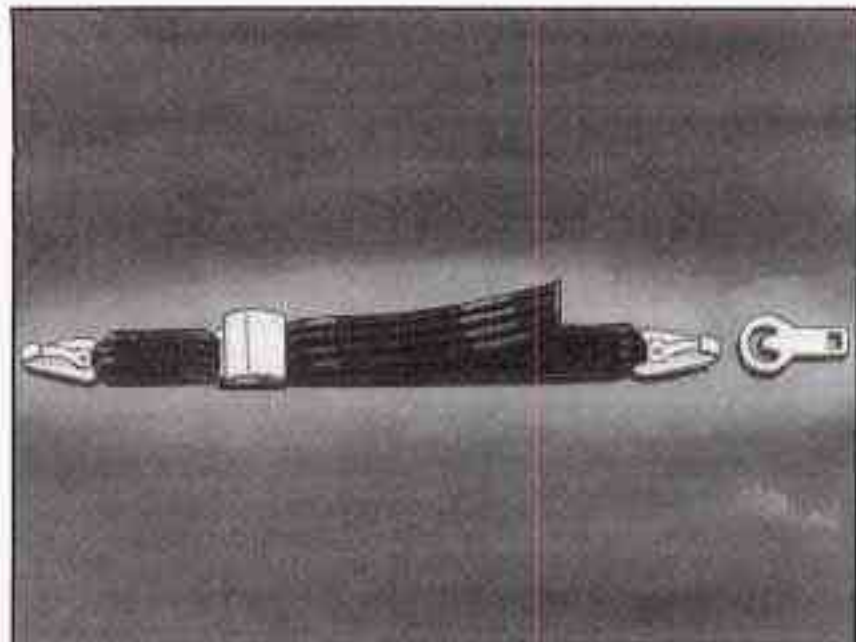

To use a child restraint here, you will need a special infant/child seat attaching belt and the hardware that goes with it. See the earlier part about the top strap if the child restraint has one.

Your dealer can order the belt and attaching hardware and install the hardware for you. It's free. The special belt is GM Part No. 12340286. Your dealer can find the part number for the correct attaching hardware in the accessory section of the GM Parts Catalog.

CAUTION:

Don't use the special infant/child seat attaching hardware in another vehicle. If you do, it may not work well and the child may not be protected properly in a crash. The special hardware is for your vehicle only.

Also, don't use the special belt for anything but securing a child restraint in the right front seat. If an adult or older child uses it, the belt won't provide protection and may even increase injury in a crash.

Once the special hardware is installed, please follow the instructions with it and these steps:



1. Unbuckle the automatic lap-shoulder belt by pushing the button on the buckle. It will stay on the door, ready to be rebuckled for use by adults or older children.
2. Because your vehicle has a right front passenger air bag, always move the seat as far back as it will go before securing a forward-facing child restraint. (See "Seats" in the Index.)
3. Snap one hook of the infant/child seat attaching belt near the floor at the door side of the seat.



4. Put the belt's special latch plate into the vehicle's safety belt buckle.

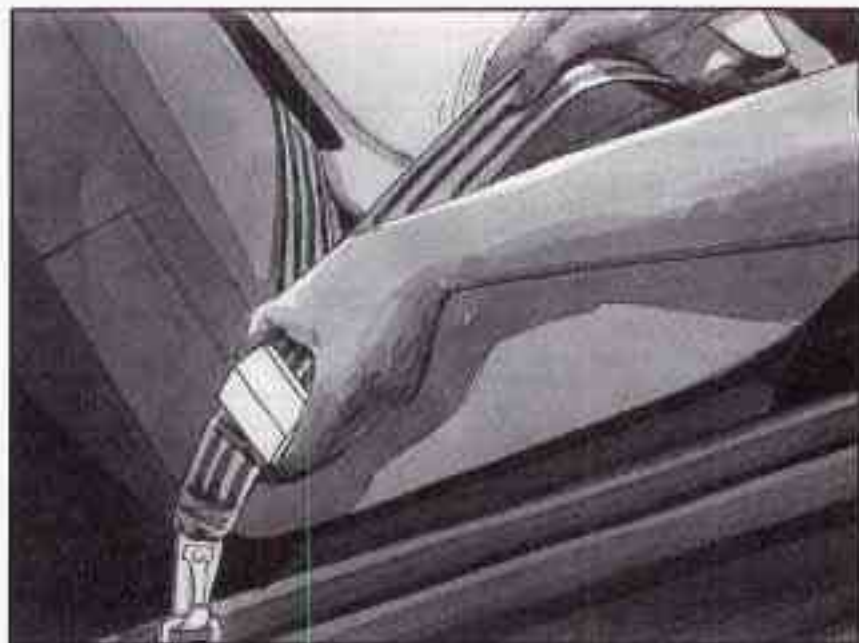

5. You can make the belt longer by tilting the buckle and pulling it along the belt.
6. Put the restraint on the seat. Follow the instructions for the child restraint.
7. Secure the child in the child restraint as the instructions say.
8. Run the belt through or around the child restraint. The child restraint instructions will show you how.



9. Put the hook on the free end through the slot in the latch plate.

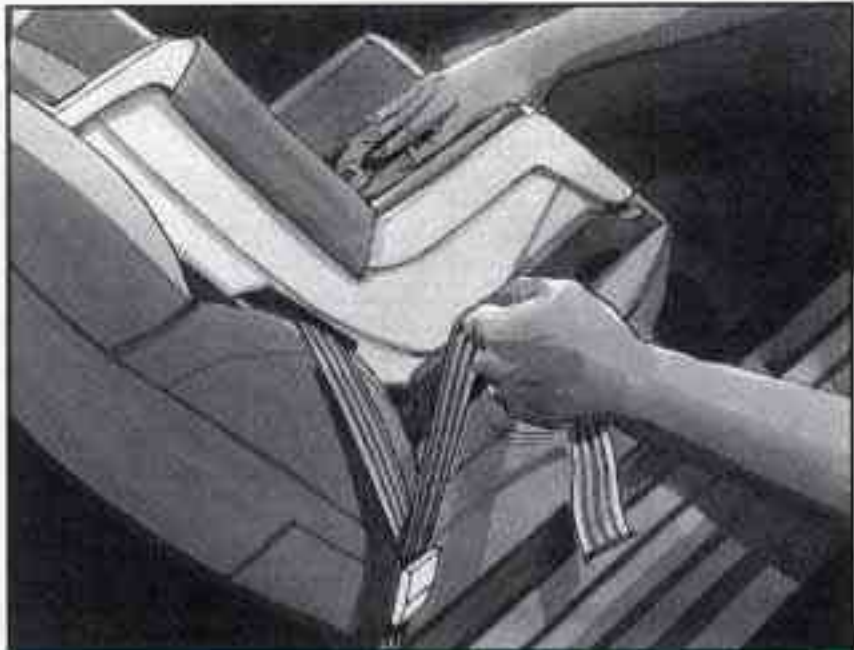

10. To make it tight, pull the belt while you push down on the child restraint. If the belt won't stay tight, switch it end for end.
11. Push and pull the child restraint in different directions to be sure it is secure.

Removing the Child Seat Restraint

1. Push the button on the safety belt buckle and remove the special latch plate. Leave the latch plate on the special belt.

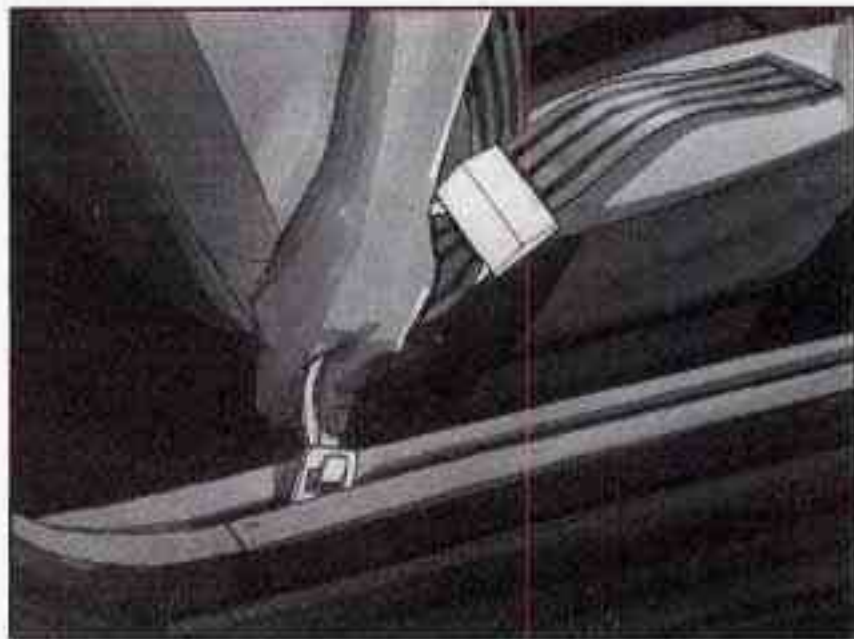

2. Push the spring on the hook near the door and remove the special belt.

3. Put the belt away in a safe place in your vehicle, so it won't fly around in a crash and injure someone.
4. Remember to reattach the automatic belt again, once the child restraint is removed. Be sure it isn't twisted.

Larger Children

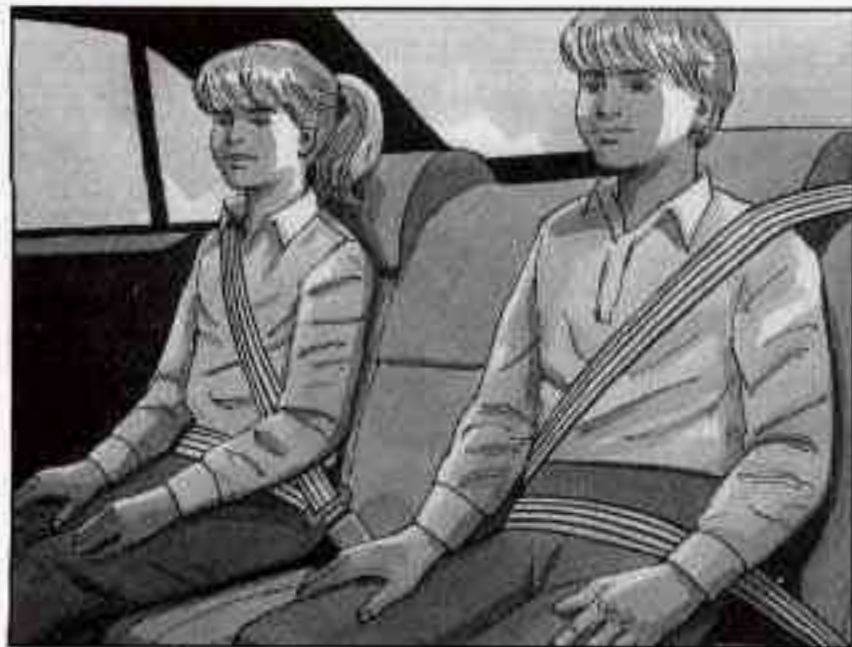

Children who have outgrown child restraints should wear the vehicle's safety belts.

If you have the choice, a child should sit next to a window so the child can wear a lap-shoulder belt and get the additional restraint a shoulder belt can provide.

Accident statistics show that children are safer if they are restrained in the rear seat. But they need to use the safety belts properly.

- Children who aren't buckled up can be thrown out in a crash.
- Children who aren't buckled up can strike other people who are.

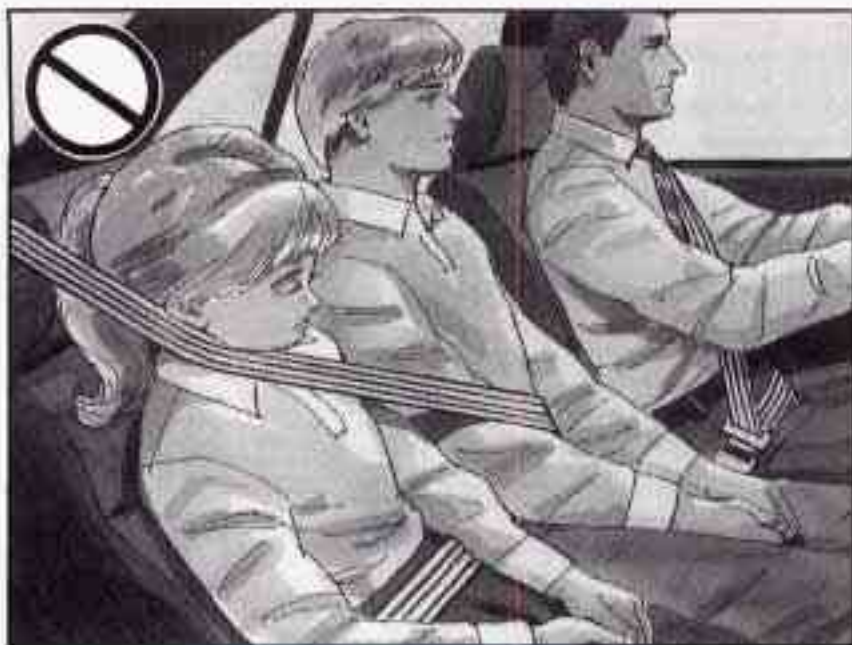

⚠ CAUTION:

Never do this.

Here two children are wearing the same belt. The belt can't properly spread the impact forces. In a crash, the two children can be crushed together and seriously injured. A belt must be used by only one person at a time.

- Q:** What if a child is wearing a lap-shoulder belt, but the child is so small that the shoulder belt is very close to the child's face or neck?
- A:** Move the child toward the center of the vehicle, but be sure that the shoulder belt still is on the child's shoulder, so that in a crash the child's upper body would have the restraint that belts provide. If the child is sitting in a rear outside position of a four-door model, see "Rear Safety Belt Comfort Guides" in the Index. If the child is so small that the shoulder belt is still very close to the child's face or neck, you might want to place the child in the center seat position, the one that has only a lap belt.



⚠ CAUTION:

Never do this.

Here a child is sitting in a seat that has a lap-shoulder belt, but the shoulder part is behind the child. If the child wears the belt in this way, in a crash the child might slide under the belt. The belt's force would then be applied right on the child's abdomen. That could cause serious or fatal injuries.

Wherever the child sits, the lap portion of the belt should be worn low and snug on the hips, just touching the child's thighs. This applies belt force to the child's pelvic bones in a crash.

Safety Belt Extender

If the vehicle's safety belt will fasten around you, you should use it.

But if a safety belt isn't long enough to fasten, your dealer will order you an extender. It's free. When you go in to order it, take the heaviest coat you will wear, so the extender will be long enough for you. The extender will be just for you, and just for the seat in your vehicle that you choose. Don't let someone else use it, and use it only for the seat it is made to fit. To wear it, just attach it to the regular safety belt.

Checking Your Restraint Systems

Now and then, make sure the safety belt reminder light and all your belts, buckles, latch plates, retractors and anchorages are working properly. Look for any other loose or damaged safety belt system parts. If you see anything that might keep a safety belt system from doing its job, have it repaired.

Torn or frayed safety belts may not protect you in a crash. They can rip apart under impact forces. If a belt is torn or frayed, get a new one right away.

Also look for any opened or broken air bag covers, and have them repaired or replaced. (The air bag system does not need regular maintenance.)

Replacing Restraint System Parts After a Crash

If you've had a crash, do you need new belts?

After a very minor collision, nothing may be necessary. But if the belts were stretched, as they would be if worn during a more severe crash, then you need new belts.

If belts are cut or damaged, replace them. Collision damage also may mean you will need to have safety belt or seat parts repaired or replaced. New parts and repairs may be necessary even if the belt wasn't being used at the time of the collision.

If an air bag inflates, you'll need to replace air bag system parts. See the part on the air bag system earlier in this section.



Section 2 Features and Controls

Here you can learn about the many standard and optional features on your Pontiac, and information on starting, shifting and braking. Also explained are the instrument panel and the warning systems that tell you if everything is working properly -- and what to do if you have a problem.

Keys

CAUTION:

Leaving young children in a vehicle with the ignition key is dangerous for many reasons. A child or others could be badly injured or even killed.

They could operate power windows or other controls or even make the vehicle move. Don't leave the keys in a vehicle with young children.





The ignition keys are for the ignition only.



The door keys are for the doors and all other locks.

When a new Pontiac is delivered, the dealer removes the plugs from the door keys and gives them to the first owner.

The ignition keys don't have plugs. Your Pontiac dealer or Roadside Assistance has the code for your keys.

Each plug has a code on it that tells your dealer or a qualified locksmith how to make extra door keys. Keep the plugs in a safe place. If you lose your door keys, you'll be able to have new ones made easily using these plugs.

If you need a new key, contact your Pontiac dealer who can obtain the correct key code. Remember to carry the pre-cut emergency key which Pontiac sends after delivery. In an emergency, call Pontiac Roadside Assistance at 1-800-ROADSIDE or 1-800-762-3743.

NOTICE:

Your Pontiac has a number of features that can help prevent theft. But you can have a lot of trouble getting into your vehicle if you ever lock your keys inside. You may even have to damage your vehicle to get in. So be sure you have extra keys.

Door Locks

CAUTION:

Unlocked doors can be dangerous.

Passengers -- especially children -- can easily open the doors and fall out. When a door is locked, the inside handle won't open it.

Outsiders can easily enter through an unlocked door when you slow down or stop your vehicle.

This may not be so obvious: You increase the chance of being thrown out of the vehicle in a crash if the doors aren't locked. Wear safety belts properly, lock your doors, and you will be far better off whenever you drive your vehicle.

There are several ways to lock and unlock your vehicle.

From the outside, use your door key or Remote Lock Control transmitter, if your vehicle has this option.

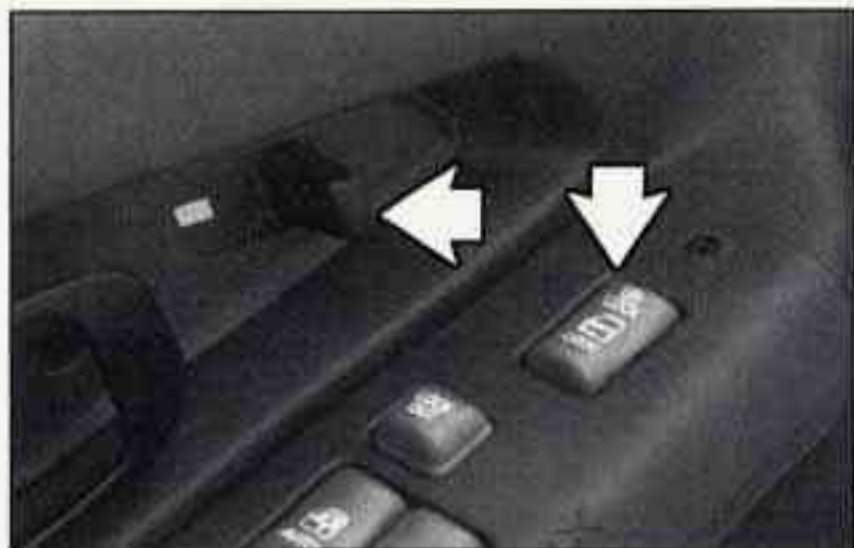

From the inside, slide the lever back to lock the door. To unlock the door, slide the lever forward.

Power Door Locks

Press the power door lock switch to lock or unlock all doors.

On four-door models, the rear doors do not have power door lock switches. The lever on each rear door works only that door's lock. It won't lock or unlock all the doors.

Automatic Door Locks

Just close your doors and turn on the ignition. All of the doors will lock when you move your shift lever out of PARK (P) or NEUTRAL (N). All doors will unlock automatically when the ignition is turned off.

If someone needs to get out while the vehicle is running, have that person use the manual or power lock. When the door is closed again, it will lock automatically as long as the shift lever is out of PARK (P) or NEUTRAL (N) and the ignition is on. Note that the door must be opened, then closed, or the door will not automatically relock.

If you don't want the doors to unlock automatically when you turn the ignition off, you can remove the Lock Control fuse in the instrument panel fuse block. See "Fuses and Circuit Breakers" in the Index.

Leaving Your Vehicle

If you are leaving the vehicle, take your keys, open your door and set the locks from inside. Then get out and close the door.

Remote Lock Control (Option)

If your Pontiac has this option, you can lock and unlock your doors or unlock your trunk from up to 30 feet (9 m) away using the key chain transmitter supplied with your vehicle.

Your Remote Lock Control transmitter operates on a radio frequency subject to Federal Communications Commission (FCC) Rules.

This device complies with Part 15 of the FCC Rules. Operation is subject to the following two conditions: (1) This device may not cause harmful interference, and (2) This device must accept any interference received, including interference that may cause undesired operation.

Should interference to this system occur, try this:

- Check to determine if battery replacement is necessary. See the instructions on battery replacement.
- Check the distance. You may be too far from your vehicle. This product has a maximum range.
- Check the location. Other vehicles or objects may be blocking the signal.
- See your Pontiac dealer or a qualified technician for service.

Changes or modifications to this system by other than an authorized service facility could void authorization to use this equipment.

Operation



Press UNLOCK once to unlock the driver's door. Press UNLOCK again within five seconds to unlock all the doors. The interior lamps will come on (see "Sustained Interior Illumination" in the Index for more details).

To lock all of the doors, press DOOR. To unlock the trunk, press the vehicle symbol on the transmitter. The trunk will only unlock if your transaxle is in PARK (P).

Matching Transmitter(s) To Your Vehicle

Each key chain transmitter is coded to prevent another transmitter from unlocking your vehicle. If a transmitter is lost or stolen, a replacement can be purchased through your dealer. Remember to bring any remaining transmitters with you when you go to your dealer. When the dealer matches the replacement transmitter to your vehicle, any remaining transmitters must also be matched. Once the new transmitter is coded, the lost transmitter will not unlock your vehicle. Each vehicle can have only two transmitters matched to it.

Battery Replacement

Under normal use, the batteries in your key chain transmitter should last about two years.

You can tell the batteries are weak if the transmitter won't work at the normal range in any location. If you have to get close to your vehicle before the transmitter works, it's probably time to change the batteries.



To replace your batteries:

1. Insert a flat object like a dime into the slot on the back of the transmitter. Gently pry apart the front and back.
2. Gently pry the batteries out of the transmitter.
3. Put the new batteries into the transmitter as shown on the transmitter. Use Duracell[®] batteries, type DL2016, or equivalent.
4. Put the two halves back together. Make sure the halves are together tightly so water won't get in.
5. Test the transmitter.

Trunk

CAUTION:

It can be dangerous to drive with the trunk open because carbon monoxide (CO) gas can come into your vehicle. You can't see or smell CO. It can cause unconsciousness and even death.

If you must drive with the trunk open or if electrical wiring or other cable connections must pass through the seal between the body and the trunk:

- Make sure all windows are shut.
- Turn the fan on your heating or cooling system to its highest speed with the setting on VENT. That will force outside air into your vehicle. See "Comfort Controls" in the Index.
- If you have air outlets on or under the instrument panel, open them all the way.

See "Engine Exhaust" in the Index.

Trunk Lock



To unlock the trunk from the outside, insert the door key into the lock and turn it. You can also use the Remote Lock Control transmitter, if your vehicle has this option.

Remote Trunk Release (Option)



Press the button behind the glove box door to unlock the trunk from inside your vehicle. Your transaxle shift lever must be in PARK (P). Remember that your trunk can be opened at any time using this lock release.

Theft

Vehicle theft is big business, especially in some cities. Although your Pontiac has a number of theft-deterrent features, we know that nothing we put on it can make it impossible to steal. However, there are ways you can help.

Key in the Ignition

If you leave your vehicle with the keys inside, it's an easy target for joy riders or professional thieves -- so don't do it.

When you park your Pontiac and open the driver's door, you'll hear a chime reminding you to remove your key from the ignition and take it with you. Always do this. Your steering wheel will be locked, and so will your ignition and transaxle. And remember to lock the doors.

Parking at Night

Park in a lighted spot, close all windows and lock your vehicle. Remember to keep your valuables out of sight. Put them in a storage area, or take them with you.

Parking Lots

If you park in a lot where someone will be watching your vehicle, it's best to lock it up and take your keys. But what if you have to leave your ignition key? What if you have to leave something valuable in your vehicle?

- Put your valuables in a storage area, like your trunk or glove box.
- Lock the glove box.
- Lock all the doors except the driver's.
- Then take the door key with you.

PASS-Key[®] II



Your vehicle is equipped with the PASS-Key II (Personalized Automotive Security System) theft-deterrent system. PASS-Key II is a passive theft-deterrent system. It works when you insert or remove the key from the ignition.

PASS-Key II uses a resistor pellet in the ignition key that matches a decoder in your vehicle.

When the PASS-Key II system senses that someone is using the wrong key, it shuts down the vehicle's starter and fuel systems. For about three minutes, the starter won't work and fuel won't go to the engine. If someone tries to start your vehicle again or uses another key during this time, the vehicle will not start. This discourages someone from randomly trying different keys with different resistor pellets in an attempt to make a match.

The ignition key must be clean and dry before it's inserted in the ignition or the engine may not start. If the engine does not start and the SECURITY light is on, the key may be dirty or wet. Turn the ignition off.

Clean and dry the key. Wait about three minutes and try again. The SECURITY light may remain on during this time. If the starter still won't work, and the key appears to be clean and dry, wait about three minutes and try another ignition key. At this time, you may also want to check the fuse (see "Fuses and Circuit Breakers" in the Index). If the starter won't work with the other key, your vehicle needs service. If your vehicle does start, the first ignition key may be faulty. See your Pontiac dealer or a locksmith who can service the PASS-Key II.

If you accidentally use a key that has a damaged or missing resistor pellet, the starter won't work and the SECURITY light will flash. But you don't have to wait three minutes before trying another ignition key.

See your Pontiac dealer or a locksmith who can service the PASS-Key II to have a new key made.

If you're ever driving and the SECURITY light comes on, you will be able to restart your engine if you turn it off. Your PASS-Key II system, however, is not working properly and must be serviced by your Pontiac dealer. Your vehicle is not protected by the PASS-Key II system.

If you lose or damage a PASS-Key II ignition key, see your Pontiac dealer or a locksmith who can service PASS-Key II to have a new key made. In an emergency, call the Pontiac Roadside Assistance Program at 1-800-ROADSIDE or 1-800-762-3743.

New Vehicle "Break-In"

NOTICE:

Your modern Pontiac doesn't need an elaborate "break-in." But it will perform better in the long run if you follow these guidelines:

- Don't drive at any one speed -- fast or slow -- for the first 500 miles (804 km). Don't make full-throttle starts.
- Avoid making hard stops for the first 200 miles (322 km) or so. During this time your new brake linings aren't yet broken in. Hard stops with new linings can mean premature wear and earlier replacement. Follow this breaking-in guideline every time you get new brake linings.
- Don't tow a trailer during break-in. See "Towing a Trailer" in the Index for more information.

Ignition Positions

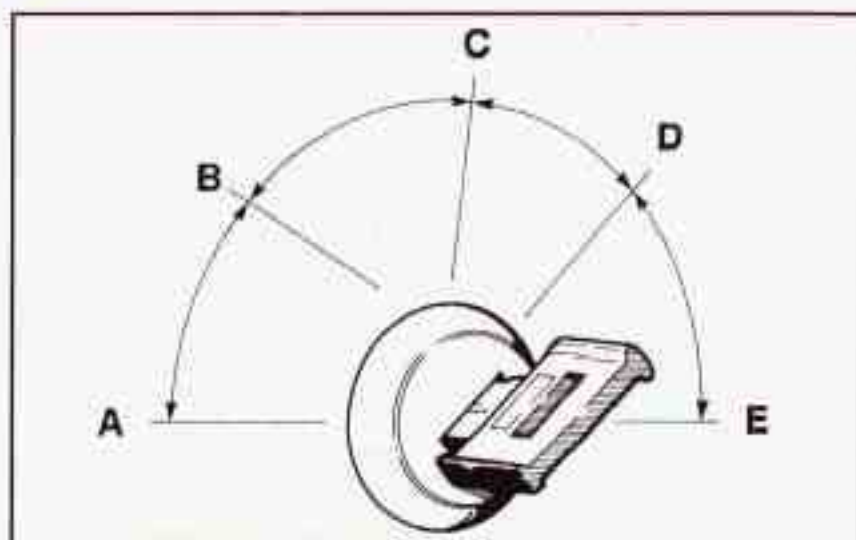

With the ignition key in the ignition switch, you can turn the switch to five positions.

ACC (A): This position lets you use things like the radio and windshield wipers when the engine is off. To use ACC (Accessory), push in the key and turn it toward you. Your steering wheel will stay locked.

LOCK (B): Before you put the key into the ignition switch, the switch is in the LOCK position. It's also the only position in which you can remove your key. This position locks your ignition, steering wheel and transaxle. It's a theft-deterrent feature.

OFF (C): This position lets you turn off the engine but still turn the steering wheel. It doesn't lock the steering wheel like LOCK. Use OFF if you must have your vehicle pushed or towed.

RUN (D): This position is where the key returns after you start your vehicle. With the engine off, you can use RUN to display some of your warning and indicator lights.

START (E): This position starts your engine.

A warning chime will sound if you open the driver's door when the ignition is in the OFF, LOCK or ACC position and the key is in the ignition.

NOTICE:

If your key seems stuck in LOCK and you can't turn it, be sure it is all the way in. If it is, then turn the steering wheel left and right while you turn the key hard. But turn the key only with your hand. Using a tool to force it could break the key or the ignition switch. If none of this works, then your vehicle needs service.

Starting Your Engine

Move your shift lever to PARK (P) or NEUTRAL (N). Your engine won't start in any other position -- that's a safety feature. To restart when you're already moving, use NEUTRAL (N) only.

NOTICE:

Don't try to shift to PARK (P) if your Pontiac is moving. If you do, you could damage the transaxle. Shift to PARK (P) only when your vehicle is stopped.

1. Without pushing the accelerator pedal, turn your ignition key to START. When the engine starts, let go of the key. The idle speed will go down as your engine gets warm.

NOTICE:

Holding your key in START for longer than 15 seconds at a time will cause your battery to be drained much sooner. And the excessive heat can damage your starter motor.

2. If your engine won't start (or starts but then stops), it could be flooded with too much gasoline. Try pushing your accelerator pedal all the way to the floor and holding it there as you hold the key in START for up to 15 seconds. This clears the extra gasoline from the engine.

NOTICE:

Your engine is designed to work with the electronics in your vehicle. If you add electrical parts or accessories, you could change the way the engine operates. Before adding electrical equipment, check with your dealer. If you don't, your engine might not perform properly.

If you ever have to have your vehicle towed, see the part of this manual that tells how to do it without damaging your vehicle. See "Towing Your Vehicle" in the Index.

Engine Coolant Heater (Option)

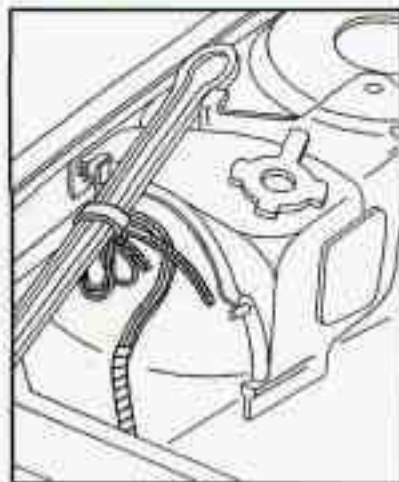

In very cold weather, 0°F (-18°C) or colder, the engine coolant heater can help. You'll get easier starting and better fuel economy during engine warm-up.

Usually, the coolant heater should be plugged in a minimum of four hours prior to starting your vehicle.

To Use the Coolant Heater

1. Turn off the engine.
2. Open the hood and unwrap the electrical cord.
3. Plug it into a normal, grounded 110-volt AC outlet.



CAUTION:

Plugging the cord into an ungrounded outlet could cause an electrical shock. Also, the wrong kind of extension cord could overheat and cause a fire. You could be seriously injured. Plug the cord into a properly grounded three-prong 110-volt AC outlet. If the cord won't reach, use a heavy-duty three-prong extension cord rated for at least 15 amps.

4. After you've used the coolant heater, be sure to store the cord as it was before to keep it away from moving engine parts. If you don't, it could be damaged.

How long should you keep the coolant heater plugged in? The answer depends on the outside temperature, the kind of oil you have, and some other things. Instead of trying to list everything here, we ask that you contact your Pontiac dealer in the area where you'll be parking your vehicle. The dealer can give you the best advice for that particular area.

Automatic Transaxle Operation



Your automatic transaxle may have a shift lever on the steering column or on the console between the seats.

Maximum engine speed is limited on automatic transaxle vehicles, when you're in PARK (P) or NEUTRAL (N), to protect driveline components from improper operation.

There are several different positions for your shift lever.

PARK (P): This locks your front wheels. It's the best position to use when you start your engine because your vehicle can't move easily.

CAUTION:

It is dangerous to get out of your vehicle if the shift lever is not fully in PARK (P) with the parking brake firmly set. Your vehicle can roll. Don't leave your vehicle when the engine is running unless you have to. If you have left the engine running, the vehicle can move suddenly. You or others could be injured. To be sure your vehicle won't move, even when you're on fairly level ground, always set your parking brake and move the shift lever to PARK (P).

See "Shifting Into PARK (P)" in the Index. If you're pulling a trailer, see "Towing a Trailer" in the Index.

Make sure the shift lever is fully into PARK (P) range before starting the engine. Your Pontiac has a brake-transaxle shift interlock. You must fully apply your regular brakes before you can shift from PARK (P) when the ignition is in the RUN position. If you cannot shift out of PARK (P), ease pressure on the shift lever by pushing it all the way into PARK (P) while keeping the brake pedal pushed down. Release the shift lever button if you have a console shift. Then move the shift lever out of PARK (P), being sure to press the shift lever button if you have a console shift. See "Shifting Out of PARK (P)" in the Index.

REVERSE (R): Use this gear to back up.

NOTICE:

Shifting to REVERSE (R) while your vehicle is moving forward could damage your transaxle. Shift to REVERSE (R) only after your vehicle is stopped.

To rock your vehicle back and forth to get out of snow, ice or sand without damaging your transaxle, see "Stuck: In Sand, Mud, Ice or Snow" in the Index.

NEUTRAL (N): In this position, your engine doesn't connect with the wheels. To restart when you're already moving, use NEUTRAL (N) only. Also, use NEUTRAL (N) when your vehicle is being towed.



CAUTION:

Shifting out of PARK (P) or NEUTRAL (N) while your engine is "racing" (running at high speed) is dangerous. Unless your foot is firmly on the brake pedal, your vehicle could move very rapidly. You could lose control and hit people or objects. Don't shift out of PARK (P) or NEUTRAL (N) while your engine is racing.

NOTICE:

Damage to your transaxle caused by shifting out of PARK (P) or NEUTRAL (N) with the engine racing isn't covered by your warranty.

DRIVE (D): This position is for normal driving.

If your vehicle has overdrive, DRIVE (D) is the overdrive position. If you need more power for passing, and you're:

- Going less than 35 mph (55 km/h), push your accelerator pedal about halfway down.
- Going about 35 mph (55 km/h) or more, push the accelerator pedal all the way down.

You'll shift down to the next gear and have more power.

THIRD (3): This position is also used for normal driving, but it offers more power and lower fuel economy than DRIVE (D).

Here are some times you might choose THIRD (3) instead of DRIVE (D):

- When driving on hilly, winding roads.
- When towing a trailer, so there is less shifting between gears.
- When going down a steep hill.

NOTICE:

If your vehicle seems to start up rather slowly, or if it seems not to shift gears as you go faster, something may be wrong with a transaxle system sensor. If you drive very far that way, your vehicle can be damaged. So, if this happens, have your vehicle serviced right away. Until then, you can use SECOND (2) when you are driving less than 35 mph (55 km/h) and DRIVE (D) for higher speeds.

SECOND (2): This position gives you more power, but lower fuel economy. You can use **SECOND (2)** on hills. It can help control your speed as you go down steep mountain roads, but then you would also want to use your brakes off and on.

NOTICE:

Don't drive in **SECOND (2)** for more than 25 miles (41 km) at speeds over 55 mph (88 km/h), or you can damage your transaxle. Use **DRIVE (D)** or **THIRD (3)** as much as possible.

Don't shift into **SECOND (2)** unless you are going slower than 65 mph (105 km/h), or you can damage your engine.

FIRST (1): This position gives you even more power, but lower fuel economy than **SECOND (2)**. You can use it on very steep hills, or in deep snow or mud. If the shift lever is put in **FIRST (1)**, the transaxle won't shift into first gear until the vehicle is going slowly enough.

NOTICE:

If your front wheels can't rotate, don't try to drive. This might happen if you were stuck in very deep sand or mud or were up against a solid object. You could damage your transaxle.

Also, if you stop when going uphill, don't hold your vehicle there with only the accelerator pedal. This could overheat and damage the transaxle. Use your brakes or shift into **PARK (P)** to hold your vehicle in position on a hill.

Second-Gear Start (Option)



Your vehicle may be equipped with a second-gear start feature. Press 2ND GEAR START to provide more traction when you are starting on ice or other slippery surfaces.

The transaxle will be in second gear when the vehicle begins to move. After starting in second gear, the vehicle will upshift normally.

SECOND GEAR START

This feature is only for improved traction only when the road surface is slippery and is not intended for continuous use or when the vehicle is stuck in sand, mud, ice, snow or gravel. Press the switch to turn off the feature. Leave the switch off for normal road conditions.

Parking Brake



To set the parking brake, hold the regular brake pedal down with your right foot. Push down the parking brake pedal with your left foot.

To release the parking brake, hold the regular brake pedal down with your right foot and push the parking brake pedal with your left foot. When you lift your left foot, the parking brake pedal will follow it to the released position.

NOTICE:

Driving with the parking brake on can cause your rear brakes to overheat. You may have to replace them, and you could also damage other parts of your vehicle.

If you are towing a trailer and are parking on any hill, see “Towing a Trailer” in the Index. That section shows what to do first to keep the trailer from moving.

Shifting Into PARK (P)

CAUTION:

It can be dangerous to get out of your vehicle if the shift lever is not fully in PARK (P) with the parking brake firmly set. Your vehicle can roll. If you have left the engine running, the vehicle can move suddenly. You or others could be injured. To be sure your vehicle won't move, even when you're on fairly level ground, use the steps that follow. If you're pulling a trailer, see “Towing a Trailer” in the Index.

Column Shift

1. Hold the brake pedal down with your right foot and set the parking brake.

2. Move the shift lever into the PARK (P) position like this:

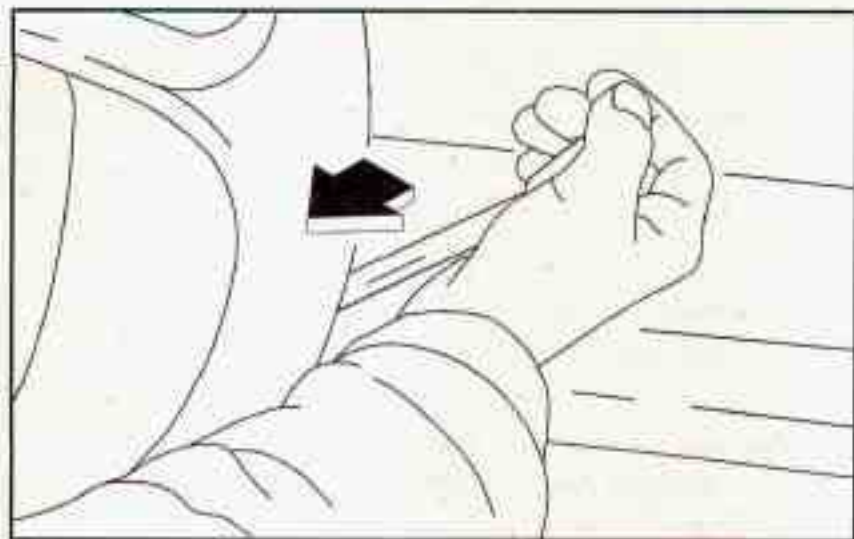

- Pull the lever toward you.

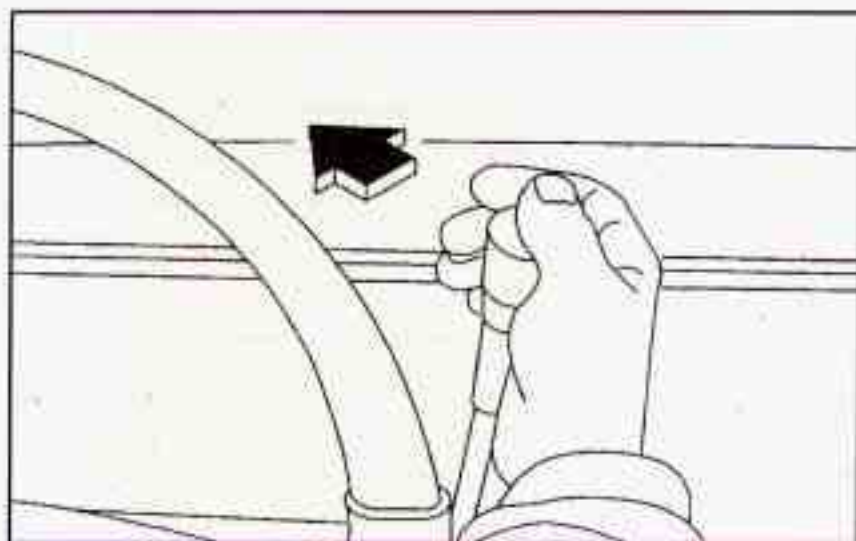

- Move the lever up as far as it will go.
3. Move the ignition key to the LOCK position.
 4. Remove the key and take it with you. If you can leave your vehicle with the ignition key in your hand, your vehicle is in PARK (P).

Console Shift

1. Hold the brake pedal down with your right foot and set the parking brake.
2. Move the shift lever into the PARK (P) position like this:



Hold in the button on the lever, and push the lever all the way toward the front of your vehicle.

3. Move the ignition key to the LOCK position.
4. Remove the key and take it with you. If you can leave your vehicle with the ignition key in your hand, your vehicle is in PARK (P).

Leaving Your Vehicle With the Engine Running

CAUTION:

It can be dangerous to leave your vehicle with the engine running. Your vehicle could move suddenly if the shift lever is not fully in PARK (P) with the parking brake firmly set. And, if you leave the vehicle with the engine running, it could overheat and even catch fire. You or others could be injured. Don't leave your vehicle with the engine running unless you have to.

If you have to leave your vehicle with the engine running, be sure your vehicle is in PARK (P) and your parking brake is firmly set before you leave it. After you've moved the shift lever into the PARK (P) position, hold the regular brake pedal down. Then, see if you can move the shift lever away from PARK (P) without first pulling it toward you (or, if you have a console shift lever, without first pushing the button). If you can, it means that the *shift lever wasn't fully locked into PARK (P)*.

Torque Lock

If you are parking on a hill and you don't shift your transaxle into PARK (P) properly, the weight of the vehicle may put too much force on the parking pawl in the transaxle. You may find it difficult to pull the shift lever out of PARK (P). This is called "torque lock." To prevent torque lock, set the parking brake and then shift into PARK (P) properly before you leave the driver's seat. To find out how, see "Shifting Into PARK (P)" in the Index.

When you are ready to drive, move the shift lever out of PARK (P) *before* you release the parking brake.

If torque lock does occur, you may need to have another vehicle push yours a little uphill to take some of the pressure from the transaxle, so you can pull the shift lever out of PARK (P).

Shifting Out of PARK (P)

Your Pontiac has a brake-transaxle shift interlock. You must fully apply your regular brakes before you can shift from PARK (P) when the ignition is in the RUN position. See "Automatic Transaxle Operation" in the Index.

If you cannot shift out of PARK (P), ease pressure on the shift lever by pushing it all the way into PARK (P), while keeping the brake pedal pushed down. Release the shift lever button if you have a console shift. Then move the shift lever out of PARK (P), being sure to press the shift lever button if you have a console shift.

If you ever hold the brake pedal down but still can't shift out of PARK (P), try this:

1. Turn the key to the OFF position.
2. Apply and hold the brake until the end of Step 4.
3. Shift to NEUTRAL (N).
4. Start the engine and shift to the drive gear you want.
5. Have the vehicle fixed as soon as you can.

Parking Over Things That Burn



CAUTION:

Things that can burn could touch hot exhaust parts under your vehicle and ignite. Don't park over papers, leaves, dry grass or other things that can burn.

Engine Exhaust

CAUTION:

Engine exhaust can kill. It contains the gas carbon monoxide (CO), which you can't see or smell. It can cause unconsciousness and death.

You might have exhaust coming in if:

- Your exhaust system sounds strange or different.
- Your vehicle gets rusty underneath.
- Your vehicle was damaged in a collision.
- Your vehicle was damaged when driving over high points on the road or over road debris.
- Repairs weren't done correctly.
- Your vehicle or exhaust system had been modified improperly.

If you ever suspect exhaust is coming into your vehicle:

- Drive it only with all the windows down to blow out any CO; and
- Have your vehicle fixed *immediately*.

Running Your Engine While You're Parked

It's better not to park with the engine running. But if you ever have to, here are some things to know.

CAUTION:

Idling the engine with the air system control off could allow dangerous exhaust into your vehicle (see the earlier Caution under "Engine Exhaust").

Also, idling in a closed-in place can let deadly carbon monoxide (CO) into your vehicle even if the fan switch is at the highest setting. One place this can happen is a garage. Exhaust -- with CO -- can come in easily. NEVER park in a garage with the engine running.

Another closed-in place can be a blizzard. (See "Blizzard" in the Index.)

CAUTION:

It can be dangerous to get out of your vehicle if the shift lever is not fully in PARK (P) with the parking brake firmly set. Your vehicle can roll. Don't leave your vehicle when the engine is running unless you have to. If you've left the engine running, the vehicle can move suddenly. You or others could be injured. To be sure your vehicle won't move, even when you're on fairly level ground, always set your parking brake and move the shift lever to PARK (P).

Follow the proper steps to be sure your vehicle won't move. See "Shifting Into PARK (P)" in the Index.

If you are parking on a hill and if you're pulling a trailer, also see "Towing a Trailer" in the Index.

Power Windows



Switches on the driver's door armrest control each of the windows when the ignition is on. In addition, each passenger's door has a switch for its own window.

The driver's window switch has an auto-down feature. This switch is labeled AUTO. Tap the rear of the switch, and the driver's window will open a small amount. If the rear of the switch is pressed all the way down and released, the window will go all the way down.

To stop the window while it is lowering, press the front of the switch. To raise the window, press and hold the front of the switch.

On four-door models, the driver's window controls also include a lock-out switch. Press LOCK OUT to stop front and rear passengers from using their window switches. The driver can still control all the windows with the lock on. Push LOCK OUT again for normal window operation. When the orange band on the switch is showing, the passengers can operate their windows.

Horn

Press either horn symbol on your steering wheel to sound the horn.

Tilt Steering Wheel



A tilt steering wheel allows you to adjust the steering wheel before you drive. You can also raise it to the highest level to give your legs more room when you exit and enter the vehicle.

To tilt the wheel, hold the steering wheel and pull the lever. Move the steering wheel to a comfortable level, then release the lever to lock the wheel in place.

Turn Signal/Multifunction Lever



The lever on the left side of the steering column includes your:

- Turn Signal and Lane Change Indicator
- Headlamp High/Low Beam Changer
- Windshield Wipers
- Windshield Washer
- Cruise Control (Option)

Turn Signal and Lane Change Indicator

The turn signal has two upward (for right) and two downward (for left) positions. These positions allow you to signal a turn or a lane change.

To signal a turn, move the lever all the way up or down. When the turn is finished, the lever will return automatically.

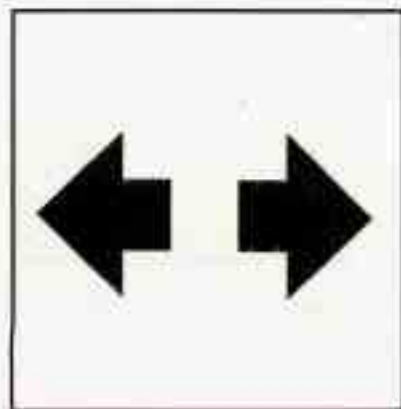

An arrow on the instrument panel will flash in the direction of the turn or lane change.

To signal a lane change, just raise or lower the lever until the arrow starts to flash. Hold it there until you complete your lane change. The lever will return by itself when you release it.

As you signal a turn or a lane change, if the arrows don't flash but just stay on, a signal bulb may be burned out and other drivers won't see your turn signal.

If a bulb is burned out, replace it to help avoid an accident. If the arrows don't go on at all when you signal a turn, check for burned-out bulbs and then check the fuse (see "Fuses and Circuit Breakers" in the Index).

A chime will sound if you leave your turn signal on for more than 1/2 mile (0.8 km).

Headlamp High/Low Beam Changer

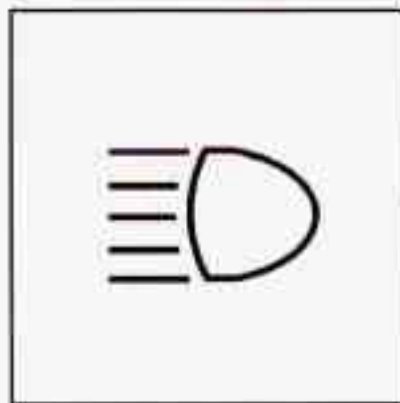

To change your headlamps from low beam to high beam, or high to low, pull the multifunction lever all the way toward you. Then release it. When the high beams are on, a light on the instrument panel also will be on.

Windshield Wipers



You control the windshield wipers by turning the band marked WIPER. For a single wiping cycle, turn the band to MIST. Hold it there until the wipers start, then let go. The wipers will stop after one cycle. If you want more cycles, hold the band on MIST longer.

For steady wiping at low speed, turn the band to LO. For high-speed wiping, turn the band further, to HI. To stop the wipers, turn the band to OFF.

You can set the wiper speed for a long or short delay between wipes. This can be very useful in light rain or snow. Turn the band to choose the delay time. The closer to LO, the shorter the delay.

Be sure to clear ice and snow from the wiper blades before using them. If they're frozen to the windshield, carefully loosen or thaw them. If your blades do become damaged, get new blades or blade inserts.

Heavy snow or ice can overload your wipers. A circuit breaker will stop them until the motor cools. Clear away snow or ice to prevent an overload.

Windshield Washer

At the top of the multifunction lever, there's a paddle with the word PUSH on it. To spray washer fluid on the windshield, push the paddle. The wipers will run for several sweeps and then either stop or return to your preset speed.

CAUTION:

In freezing weather, don't use your washer until the windshield is warmed. Otherwise the washer fluid can form ice on the windshield, blocking your vision.

Cruise Control (Option)

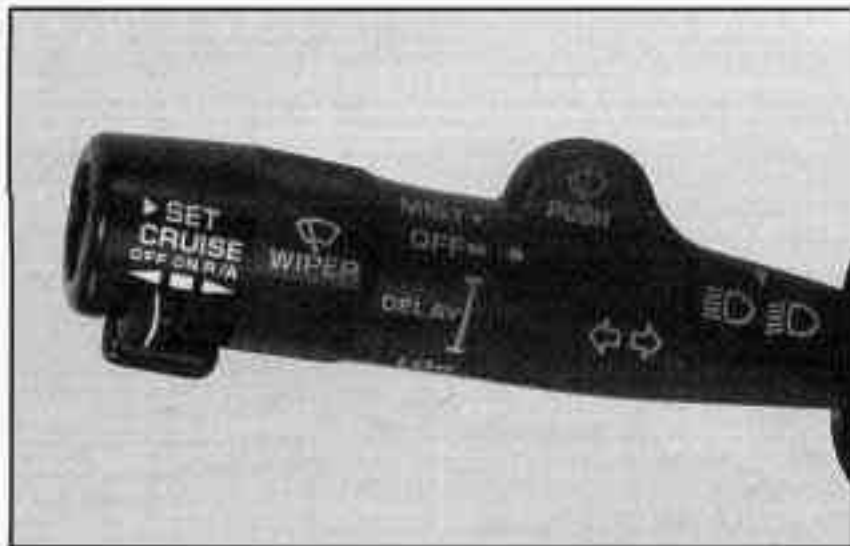

With cruise control, you can maintain a speed of about 25 mph (40km/h) or more without keeping your foot on the accelerator. This can really help on long trips. Cruise control does not work at speeds below about 25 mph (40 km/h).

When you apply your brakes, the cruise control shuts off.

CAUTION:

- Cruise control can be dangerous where you can't drive safely at a steady speed. So, don't use your cruise control on winding roads or in heavy traffic.
- Cruise control can be dangerous on slippery roads. On such roads, fast changes in tire traction can cause needless wheel spinning, and you could lose control. Don't use cruise control on slippery roads.

Setting Cruise Control

CAUTION:

If you leave your cruise control switch on when you're not using cruise, you might hit a button and go into cruise when you don't want to. You could be startled and even lose control. Keep the cruise control switch OFF until you want to use it.

1. Move the cruise control switch to ON.
2. Get up to the speed you want.



3. Push in the SET button at the end of the lever and release it.
4. Take your foot off the accelerator pedal.

Resuming a Set Speed

Suppose you set your cruise control at a desired speed and then you apply the brake. This, of course, shuts off the cruise control. But you don't need to reset it.



Once you're going about 25 mph (40 km/h) or more, you can move the cruise control switch from ON to R/A (Resume/Accelerate) for about half a second. You'll go right back up to your chosen speed and stay there.

Increasing Speed While Using Cruise Control

There are two ways to go to a higher speed:

- Use the accelerator pedal to get to the higher speed. Push in the SET button, then release the button and the accelerator pedal. You'll now cruise at the higher speed.
- Move the cruise switch from ON to R/A. Hold it there until you get up to the speed you want, and then release the switch. (To increase your speed in very small amounts, move the switch to R/A for less than half a second and then release it. Each time you do this, your vehicle will go 1 mph (1.6 km/h) faster.)

The accelerate feature will only work after you set the cruise control speed by pushing the SET button.

Reducing Speed While Using Cruise Control

There are two ways to reduce your speed while using cruise control:

- Push in the SET button until you reach the lower speed you want, then release it.
- To slow down in very small amounts, push the SET button for less than half a second. Each time you do this, you'll go 1 mph (1.6 km/h) slower.

Passing Another Vehicle While Using Cruise Control

Use the accelerator pedal to increase your speed. When you take your foot off the pedal, your vehicle will slow down to the cruise control speed you set earlier.

Using Cruise Control on Hills

How well your cruise control will work on hills depends upon your speed, load and the steepness of the hills. When going up steep hills, you may have to step on the accelerator pedal to maintain your speed. When going downhill, you may have to brake or shift to a lower gear to keep your speed down. Of course, applying the brake takes you out of cruise control. Many drivers find this to be too much trouble and don't use cruise control on steep hills.

Ending Cruise Control

There are two ways to turn off the cruise control:

- Step lightly on the brake pedal; OR
- Move the cruise switch to OFF.

Erasing Cruise Speed Memory

When you turn off the cruise control or the ignition, or shift into PARK (P) or NEUTRAL (N), your cruise control set speed memory is erased.

Lamps

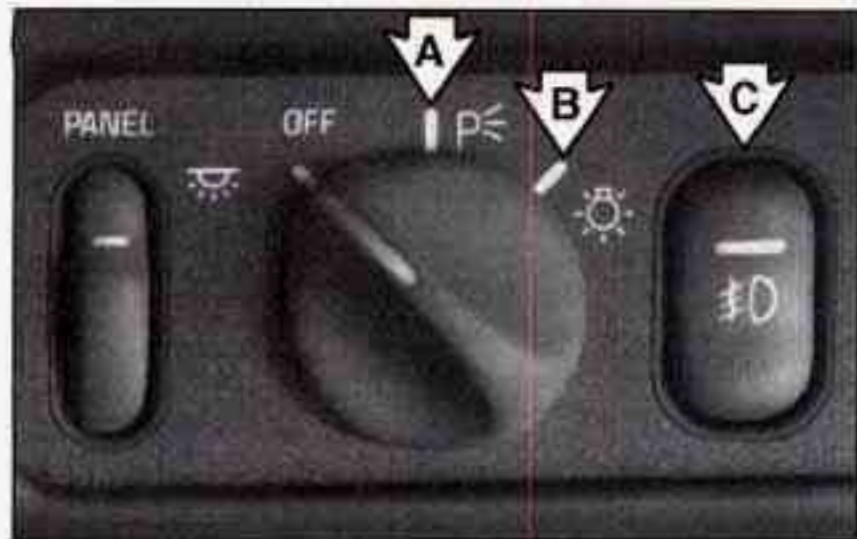

The lamp controls are on the instrument panel. They control these systems:

- Headlamps
- Taillamps

- Parking Lamps
- License Lamps
- Sidemarker Lamps
- Instrument Panel Lights
- Courtesy Lamps
- Fog Lamps

 Turn the knob to this symbol (B) to turn on the headlamps and other operating lamps.

 Turn the knob to this symbol (A) to turn on the parking and other operating lamps without the headlamps.

Turn the knob to OFF to turn off the lamps.

A warning chime will sound when you turn the ignition switch to the OFF, LOCK or ACC position with the lamps on.

Daytime Running Lamps (Option)

Daytime Running Lamps (DRL) can make it easier for others to see the front of your vehicle during the day. DRL can be helpful in many different driving conditions, but they can be especially helpful in the short periods after dawn and before sunset.

A light sensor on top of the instrument panel makes the DRL work, so be sure it isn't covered.

The DRL system will make your low-beam headlamps come on at a reduced brightness when:

- The ignition is on,
- The headlamp switch is off, and
- The parking brake is released.

When the DRL are on, only your low-beam headlamps will be on. The taillamps, sidemarker and other lamps won't be on. Your instrument panel won't be lit up either.

When it's dark enough outside, your low-beam headlamps will change to full brightness. The other lamps that come on with your headlamps will also come on.

When it's bright enough outside, the regular lamps will go out, and your low-beam headlamps will change to the reduced brightness of DRL.

To idle your vehicle with the DRL off, set the parking brake while the ignition is in the OFF or LOCK position. Then start your vehicle. The DRL will stay off until you release the parking brake.

As with any vehicle, you should turn on the regular headlamp system when you need it.

Fog Lamps

To turn the fog lamps on, press the top of the fog lamp switch (C). Press the bottom of the switch to turn the fog lamps off. Your parking lamps must be on, or your fog lamps won't come on.

The fog lamps will go off whenever you change to high-beam headlamps. When you return to low beams, the fog lamps will come on again.

Interior Lamps

Instrument Panel Brightness Control

You can brighten or dim the instrument panel lights by moving the PANEL dial. If you turn the dial all the way up, your courtesy or interior lamps will come on.

Courtesy Lamps

When any door is opened, several lamps come on. These lamps are courtesy lamps. They make it easy for you to enter and leave your vehicle. You can also turn these lamps on by moving the PANEL dial all the way up.

Some of the lamps have switches so you can turn them on, even when the doors are closed. These lamps are reading lamps. To avoid draining your battery, be sure to turn off all reading lamps when leaving your vehicle.

Sustained Interior Illumination

Your courtesy lamps will come on and stay on for a set time whenever you:

- Open a door.
- Press UNLOCK on the Remote Lock Control transmitter (if equipped).
- Press DOOR on the Remote Lock Control transmitter (if equipped).

If you open a door, the lamps will stay on while it's open and then turn off automatically about 18 seconds after you close it. If you don't open a door, the lamps will turn off after about 18 seconds, unless you pressed UNLOCK on the Remote Lock Control transmitter. If you pressed UNLOCK and don't open a door, the lamps will turn off after about 55 seconds.

Sustained interior illumination includes a feature called theater dimming. With theater dimming, the lamps don't just turn off at the end of the delay time. Instead, they slowly dim during the delay time until they go out. The delay time is cancelled if you turn the ignition key to the RUN or START position, so the lamps will go out right away.

When the ignition is on, sustained interior illumination is inactive, which means the courtesy lamps won't come on.

Rearview Mirror Reading Lamps

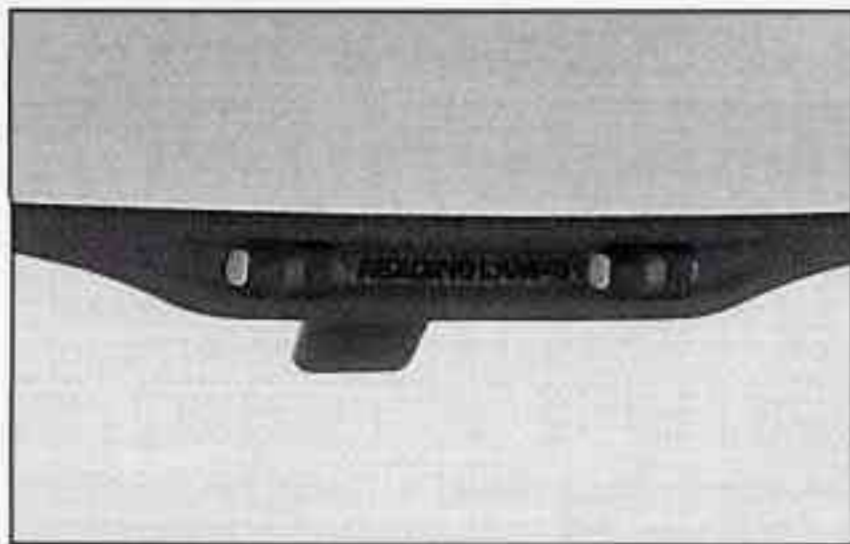

These lamps go on when you open the doors. When the doors are closed, turn them on and off with the switches.

Roof Console Reading Lamps (Option)

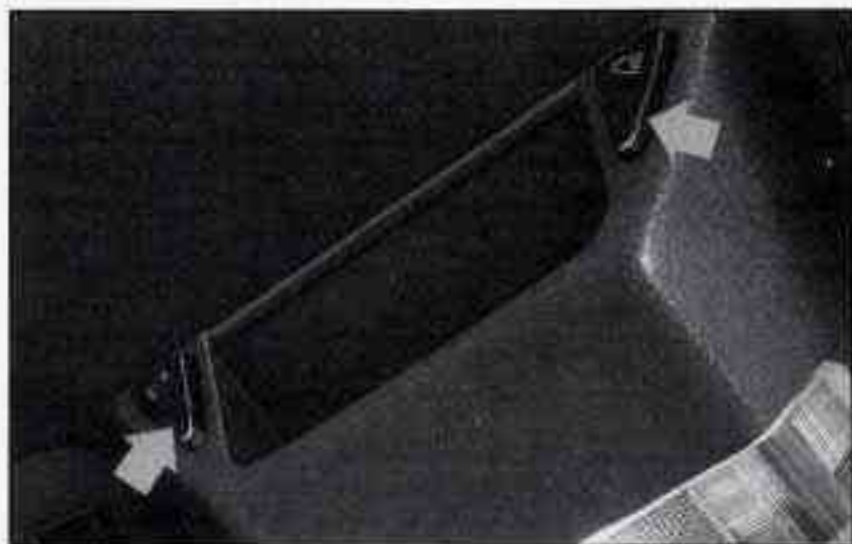

These lamps are part of the optional roof console. They will go on when you open the doors. When the doors are closed, push the button to turn the lamp on and off.

Dome Lamp

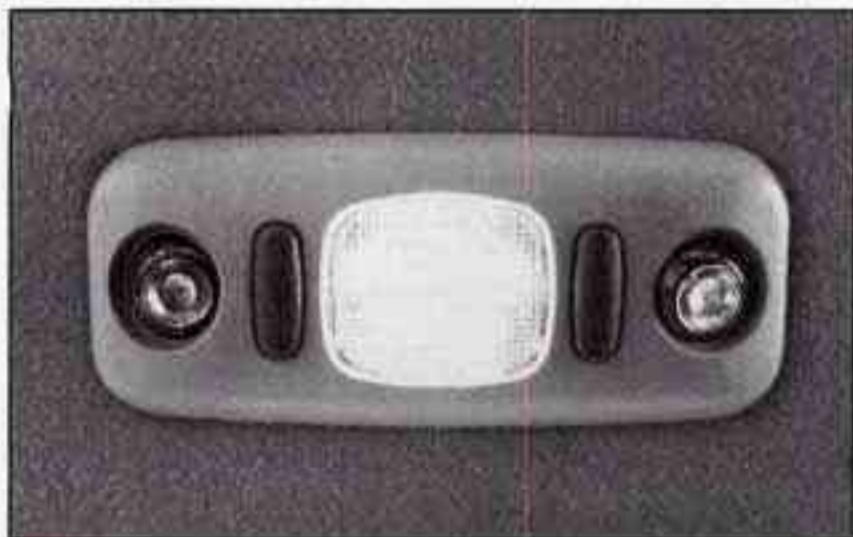

The dome lamp will go on when you open the doors. Next to the dome lamp are two reading lamps. Push the button next to each lamp to turn them on and off.

Rear Reading Lamps

These lamps are near each passenger's door. They will go on when you open the doors. When the doors are closed, move the switch to turn the lamp on and off.

Battery Saver

Your vehicle has a feature to help prevent you from draining the battery, in case you accidentally leave the courtesy lamps on. If you leave the PANEL dial turned all the way up or if you leave a door open, the lamps will automatically turn off after 10 minutes (if the ignition is off).

This feature will not turn off the reading lamps, only the lamps controlled by the PANEL dial. Be sure to turn off any reading lamps using the switch before you leave the vehicle.

Mirrors

Adjust all the mirrors so you can see clearly when you are sitting in a comfortable driving position.

Inside Day/Night Rearview Mirror



To reduce glare from headlamps behind you, push the lever away from you (to the night position). To return the mirror back to the day position, pull the lever toward you.

Manual Outside Mirrors

Adjust the right mirror by hand. To adjust the left mirror, move the knob in the direction you want to move the mirror.

Power Outside Mirrors (Option)



The power mirror control is near the driver's window. Turn the control to the left to adjust the left mirror or to the right to adjust the right mirror. Then move the control in the direction you want to move the mirror.

Convex Outside Mirror

Your passenger's side mirror is convex. A convex mirror's surface is curved so you can see more from the driver's seat.



CAUTION:

A convex mirror can make things (like other vehicles) look farther away than they really are. If you cut too sharply into the right lane, you could hit a vehicle on your right. Check your inside mirror or glance over your shoulder before changing lanes.

Storage and Compartments

Glove Box

Use the door key to lock and unlock the glove box. To open it, lift the latch.

Storage Armrest

To use the storage area, fold down the armrest. Press the latch on the front edge and pull up. To use the cupholder, flip it forward.

You may also have an armrest in the rear. It has a storage area for small items.

Center Console

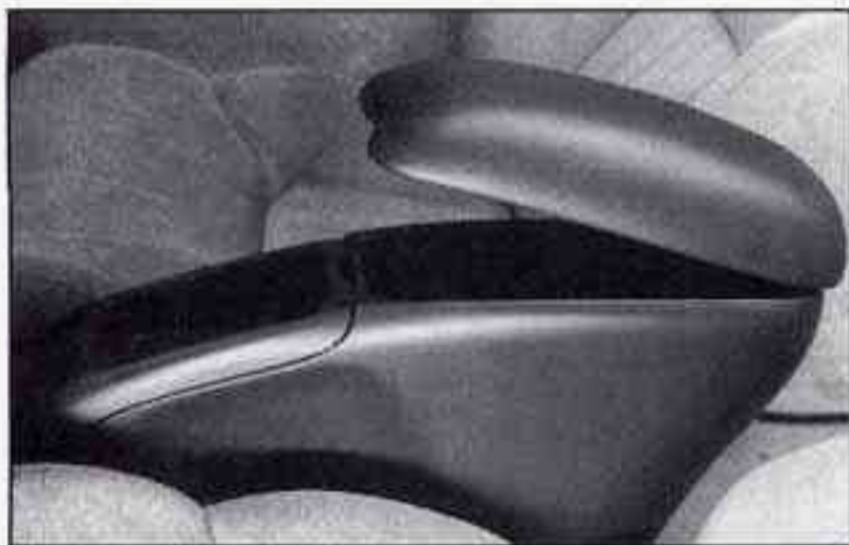

To open the storage area, press the latch on the front edge and pull up. The console has a cupholder, cassette tape storage and a coinholder.

Trunk Access Panel (Option)



If you have split rear seats, you may have a trunk access panel. To open, pull your rear armrest down, then pull the *latch on the trunk access panel*.

Convenience Net (Option)



Your vehicle may have a convenience net. You'll see it on the back wall of the trunk.

Put small loads, like grocery bags, in the net. It can help keep them from falling over during sharp turns or quick starts and stops.

The net isn't for larger, heavier loads. Store them in the trunk as far forward as you can.

You can unhook the net so that it will lie flat when you're not using it.

Ashtrays and Lighter

The center front ashtray may be on the instrument panel or on the console. To remove the console ashtray, open the lid and lift out the ashtray using the snuffer.

For the instrument panel ashtray, open it, push down on the locking tab and pull out the ashtray.

To remove the rear console ashtray, open it, push down on the snuffer and pull the ashtray out of the console. To remove the rear door ashtray, open and pull up on the ashtray door.

NOTICE:

Don't put papers and other things that burn into your ashtrays. If you do, cigarettes or other smoking materials could set them on fire, causing damage.

To use the lighter, just push it in all the way and let go. When it's ready, it will pop back by itself.

NOTICE:

Don't hold a cigarette lighter in with your hand while it is heating. If you do, it won't be able to back away from the heating element when it's ready. That can make it overheat, damaging the lighter and the heating element.

Sun Visors

To block out glare, you can swing down the visors. You can also move them from side to side.

Visor Vanity Mirrors

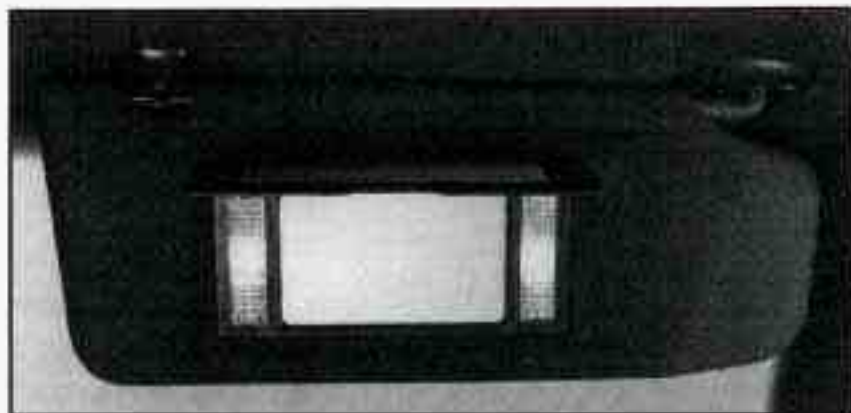

Open the cover to expose the vanity mirror. If your vehicle has the optional lighted vanity mirrors, the lamps come on when you open the cover.

Accessory Outlet

If your vehicle has a center console, you have a 12-volt outlet. It is on the passenger's side, near the floor. Open the cover to use the outlet.

NOTICE:

Adding some electrical equipment to your vehicle can damage it or keep other things from working as they should. This wouldn't be covered by your warranty. Check with your dealer before adding electrical equipment and never use anything requiring more than 20 amps.

Sunroof (Option)

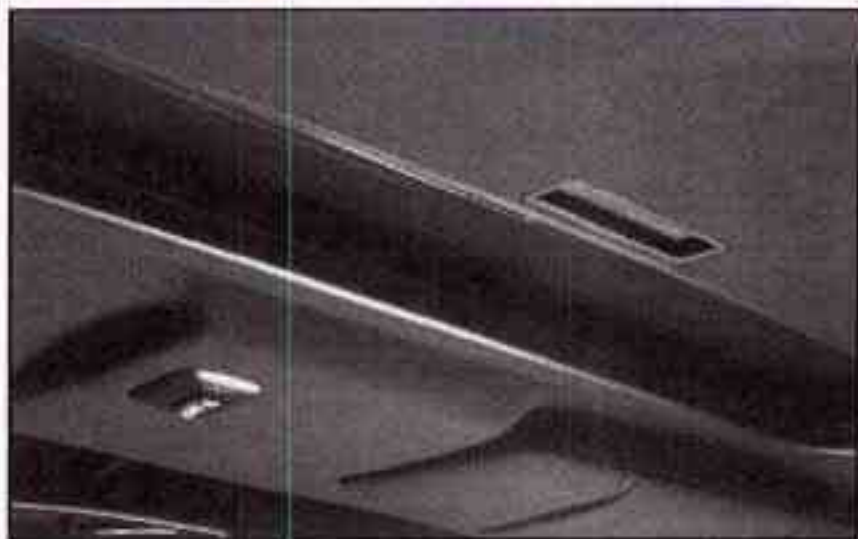

Your sunroof includes a sliding glass panel and a sliding sunshade. The switch works only when the ignition is on.

To open the glass panel and sunshade, press the rear of the switch. Let go of the switch to stop the panel in any position. Press the front of the switch to close the glass panel. The sunshade can only be closed by hand.

To open the rear vent, press the front of the switch when the sunroof is closed. Open the sunshade by hand. Press the rear of the switch to close the vent.

The sunroof glass panel cannot be opened or closed if your vehicle has an electrical failure.

Instrument Panel -- Your Information System

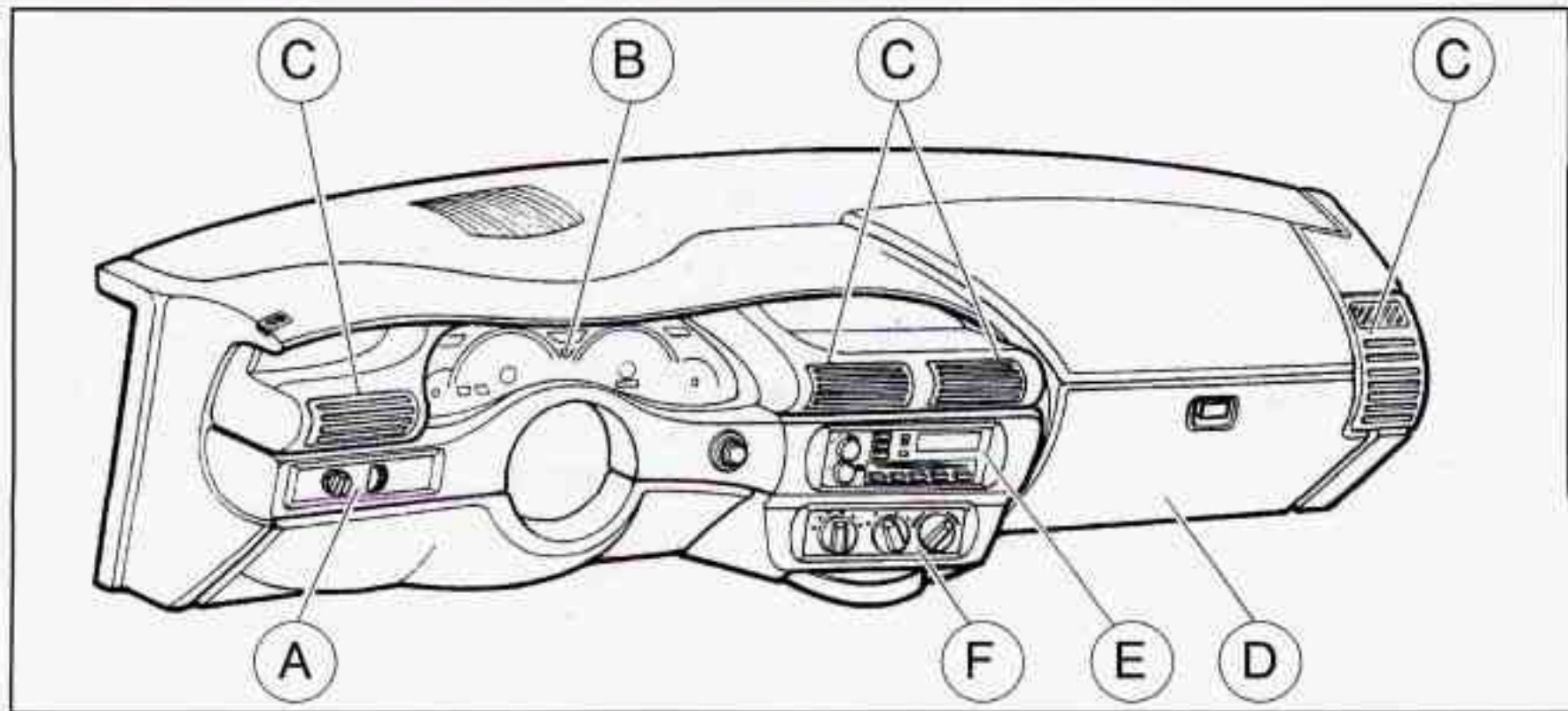

- A. Lamp Controls
- B. Instrument Cluster
- C. Vents

- D. Glove Box
- E. Audio System
- F. Climate Control System

Instrument Panel Cluster

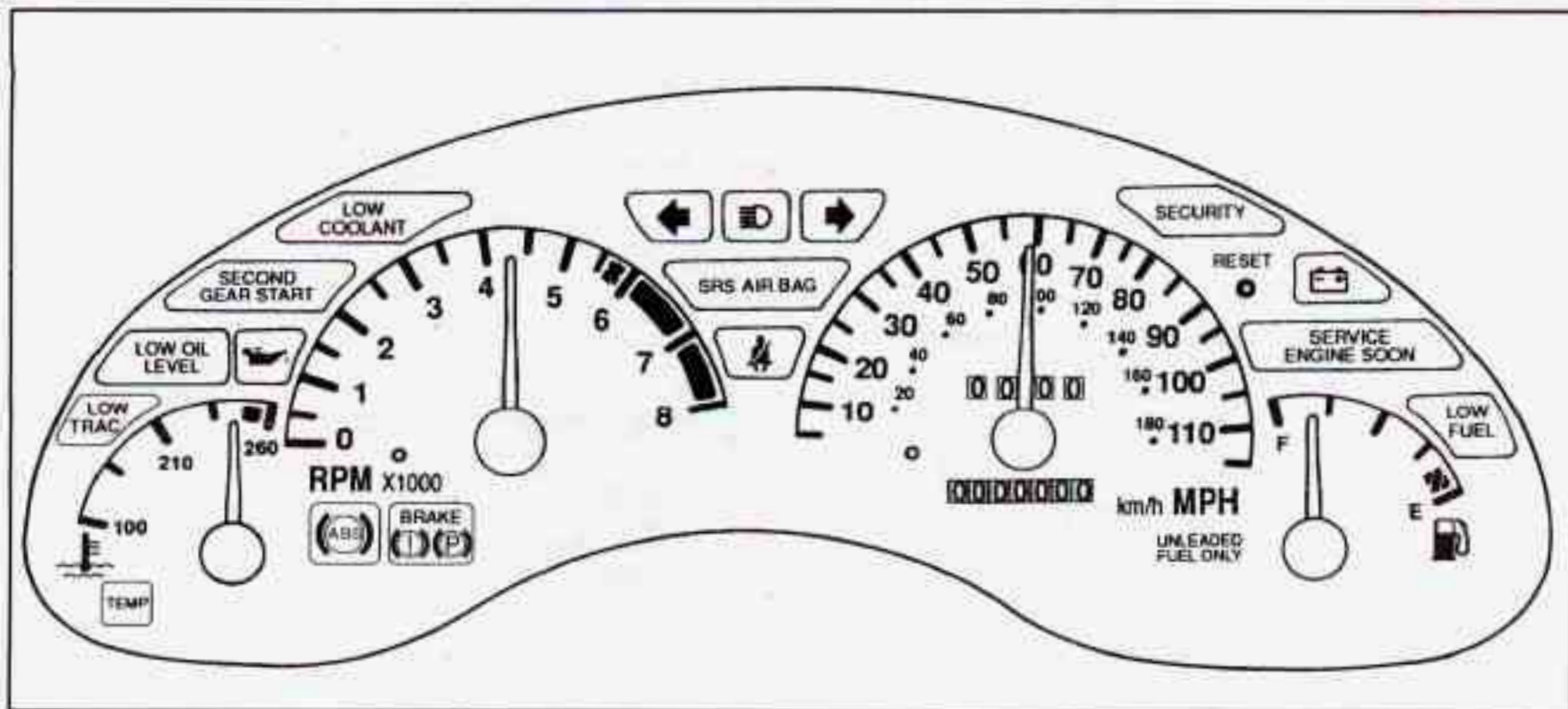

3.1L United States Version Shown, Others Similar

Your instrument cluster is designed to let you know at a glance how your vehicle is running. You'll know how fast you're going, about how much fuel is in your tank and many other things you need to drive safely and economically.

Speedometer/Odometer

Your speedometer lets you see your speed in both miles per hour (mph) and kilometers per hour (km/h). Your odometer shows how far your vehicle has been driven in either miles (used in the United States) or in kilometers (used in Canada).

Your Pontiac has a tamper-resistant odometer. If you see silver lines between the numbers, you'll know someone has probably tampered with it and the numbers may not be correct.

You may wonder what happens if your vehicle needs a new odometer installed. If the new one can be set to the mileage total of the old odometer, then that will be done. If it can't, then it will be set at zero and a label must be put on the driver's door to show the old mileage reading when the new odometer was installed.

Trip Odometer

Your trip odometer tells how far you have driven since you last reset it. To set it to zero, press the RESET button on the right side of the instrument cluster.

Tachometer

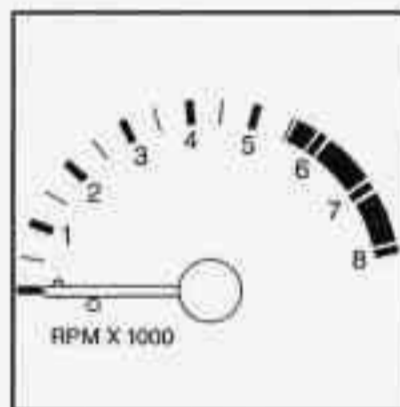

The tachometer displays the engine speed in thousands of revolutions per minute (rpm).

NOTICE:

Do not operate the engine with the tachometer in the red area, or engine damage may occur.

Warning Lights, Gages and Indicators

This part describes the warning lights and gages that may be on your vehicle. The pictures will help you locate them.

Warning lights and gages can signal that something is wrong before it becomes serious enough to cause an expensive repair or replacement. Paying attention to your warning lights and gages could also save you or others from injury.

Warning lights come on when there may be or is a problem with one of your vehicle's functions. As you will see in the details on the next few pages, some warning lights come on briefly when you start the engine just to let you know they're working. If you are familiar with this section, you should not be alarmed when this happens.

Gages can indicate when there may be or is a problem with one of your vehicle's functions. Often gages and warning lights work together to let you know when there's a problem with your vehicle.

When one of the warning lights comes on and stays on when you are driving, or when one of the gages shows there may be a problem, check the section that tells you what to do about it. Please follow this manual's advice. Waiting to do repairs can be costly -- and even dangerous. So please get to know your warning lights and gages. They're a big help.

Safety Belt Reminder Light

When the key is turned to RUN or START, a chime will come on for about eight seconds to remind people to fasten their safety belts, unless the driver's safety belt is already buckled.



The safety belt light will also come on and stay on until the driver's belt is buckled.

Air Bag Readiness Light

There is an air bag readiness light on the instrument panel, which shows SRS AIR BAG or the air bag symbol. The system checks the air bag's electrical system for malfunctions. The light tells you if there is an electrical problem. The system check includes the air bag sensors, the air bag modules, the wiring and the crash sensing and diagnostic module. For more information on the air bag system, see "Air Bag" in the Index.



SRS AIR BAG

You will see this light flash for a few seconds when you turn your ignition to RUN or START. Then the light should go out. This means the system is ready.

If the air bag readiness light doesn't come on when you start your vehicle, or stays on, or comes on when you are driving, your air bag system may not work properly. Have your vehicle serviced right away.

Charging System Light

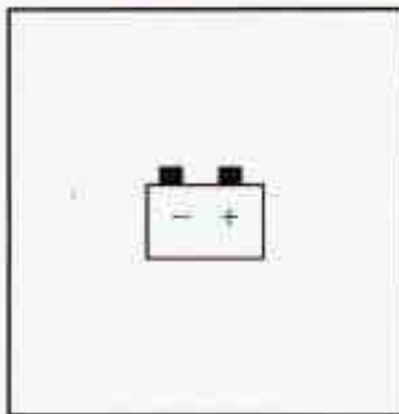

The charging system light will come on briefly when you turn on the ignition, as a check to show you it's working. Then it *should* go out.

If it stays on, or comes on while you are driving, you may have a problem with the charging system. It could indicate that you have a loose drive belt or another electrical problem. Have it checked right away. Driving while this light is on could drain your battery.

If you must drive a short distance with the light on, be certain to turn off all your accessories, such as the radio and air conditioner.

Brake System Warning Light

Your Pontiac's hydraulic brake system is divided into two parts. If one part isn't working, the other part can still work and stop you. For good braking, though, you need both parts working well.

If the warning light comes on, there could be a brake problem. Have your brake system inspected right away.

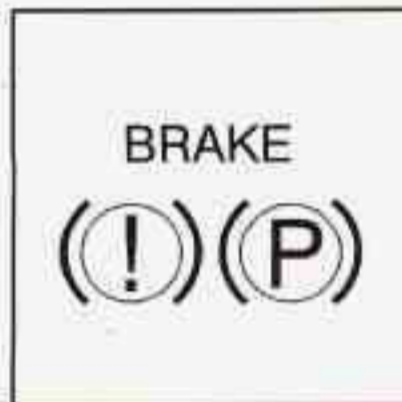

This light should come on briefly when you turn the ignition key to RUN. If it doesn't come on then, have it fixed so it will be ready to warn you if there's a problem.

If the light comes on while you are driving, pull off the road and stop carefully. You may notice that the pedal is harder to push. Or, the pedal may go closer to the floor. It may take longer to stop. If the light is still on, or if the

anti-lock brake system warning light is flashing, have the vehicle towed for service. (See "Anti-Lock Brake System Warning Light" and "Towing Your Vehicle" in the Index.)

CAUTION:

Your brake system may not be working properly if the brake system warning light is on. Driving with the brake system warning light on can lead to an accident. If the light is still on or if the anti-lock brake system warning light is flashing after you've pulled off the road and stopped carefully, have the vehicle towed for service.

When the ignition is on, the brake system warning light will also come on when you set your parking brake. The light will stay on if your parking brake doesn't release fully. If it stays on after your parking brake is fully released, it means you have a brake problem.

Anti-Lock Brake System Warning Light (Option)

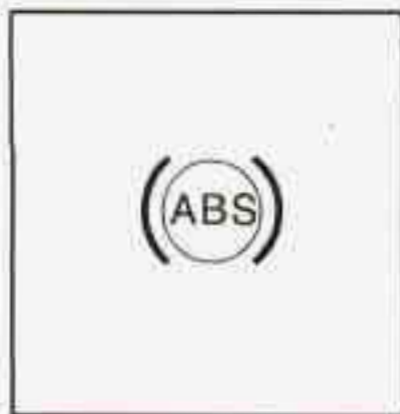

With the anti-lock brake system, this light will come on when you start your engine and it will stay on for three seconds. That's normal.

If the light flashes when you're driving, you don't have anti-lock brakes and there could be a problem with your regular brakes. Pull off the road and stop carefully. You may notice that the pedal is harder to push. Or, the pedal may go closer to the floor. It may take longer to stop. Have the vehicle towed for service. (See "Towing Your Vehicle" in the Index.)

CAUTION:

Your regular brake system may not be working properly if the anti-lock brake system warning light is flashing. Driving with the anti-lock brake system warning light flashing can lead to an accident. After you've pulled off the road and stopped carefully, have the vehicle towed for service.

If the anti-lock brake system warning light stays on longer than normal after you've started your engine, turn the ignition off. Or, if the light comes on and stays on when you're driving, stop as soon as possible and turn the ignition off. Then start the engine again to reset the system. If the light still stays on, or comes on again while you're driving, your Pontiac needs service. If the light is on but not flashing and the regular brake system warning light isn't on, you still have brakes, but you don't have anti-lock brakes.

The anti-lock brake system warning light should come on briefly when you turn the ignition key to RUN. If the light doesn't come on then, have it fixed so it will be ready to warn you if there is a problem.

Anti-Lock Brake System Active Light (Option)



When your anti-lock system is adjusting brake pressure to help avoid a braking skid, the anti-lock brake system active light will come on.

Slippery road conditions may exist if this light comes on, so adjust your driving accordingly. The light will stay on for a few seconds after the system stops adjusting brake pressure.

The anti-lock brake system active light also comes on briefly when you turn the ignition key to RUN. If the light doesn't come on then, have it fixed so it will be there to tell you when the system is active.

Engine Coolant Temperature Light

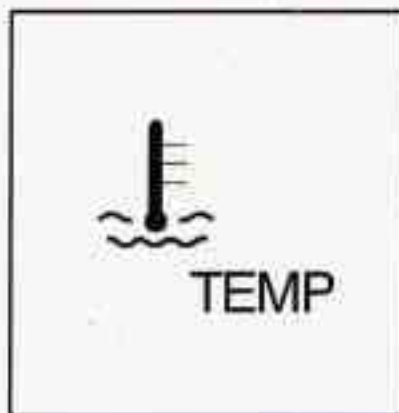

This light tells you that your engine coolant has overheated or your radiator cooling fan is not working.

If you have been operating your vehicle under normal driving conditions, you should pull off the road, stop your vehicle and turn off the engine as soon as possible.

In "Problems on the Road," this manual shows what to do. See "Engine Overheating" in the Index.

Engine Coolant Temperature Gage

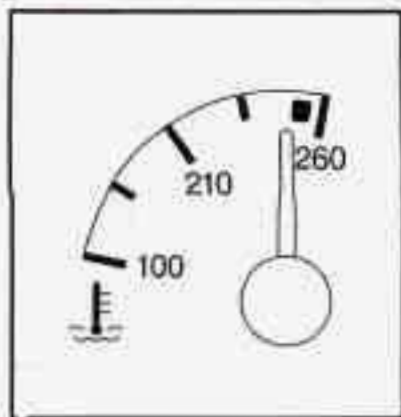

You have a gage that shows the engine coolant temperature. If the gage pointer moves into the red area, your engine is too hot!

That reading means the same thing as the warning light. It means that your engine coolant has overheated. If you have been operating your vehicle under normal driving conditions, you should pull off the road, stop your vehicle and turn off the engine as soon as possible.

In "Problems on the Road," this manual shows what to do. See "Engine Overheating" in the Index.

Low Coolant Warning Light

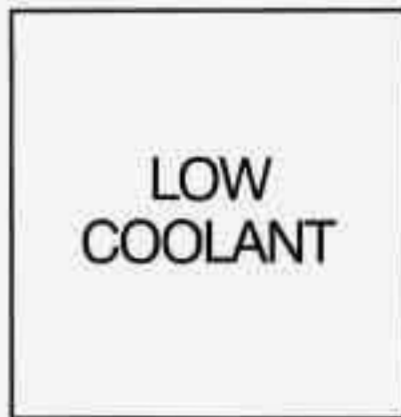

If this light comes on, your system is low on coolant and the engine may overheat. See "Engine Coolant" in the Index and have your vehicle serviced as soon as you can.

Malfunction Indicator Lamp (Service Engine Soon Light)



Your Pontiac is equipped with a computer which monitors operation of the fuel, ignition and emission control systems.

This system is called OBD II (On-Board Diagnostics-Second Generation) and is intended to assure that emissions are at acceptable levels for the life of the vehicle, helping to produce a cleaner environment. (In Canada, OBD II is replaced by Enhanced Diagnostics.) The SERVICE ENGINE SOON light comes on to indicate that there is a problem and service is required. Malfunctions often will be indicated by the system before any problem is apparent, which may prevent more serious damage to your vehicle. This system is also designed to assist your service technician in correctly diagnosing any malfunction.

NOTICE:

If you keep driving your vehicle with this light on, after a while, your emission controls may not work as well, your fuel economy may not be as good and your engine may not run as smoothly. This could lead to costly repairs that may not be covered by your warranty.

This light should come on, as a check to show you it is working, when the ignition is on and the engine is not running. If the light doesn't come on, have it repaired. This light will also come on during a malfunction in one of two ways:

- **Light Flashing** -- A misfire condition has been detected. A misfire increases vehicle emissions and may damage the emission control system on your vehicle. Dealer or qualified service center diagnosis and service is required.
- **Light On Steady** -- An emission control system malfunction has been detected on your vehicle. Dealer or qualified service center diagnosis and service may be required.

If the Light Is Flashing

The following may prevent more serious damage to your vehicle:

- Reduce vehicle speed.
- Avoid hard accelerations.
- Avoid steep uphill grades.
- If towing a trailer, reduce the amount of cargo being hauled as soon as it is possible.

If the light stops flashing and remains on steady, see "If the Light Is On Steady" following.

If the light continues to flash, when it is safe to do so, *stop the vehicle*. Put your vehicle in PARK (P). Turn the key off, wait at least 10 seconds and restart the engine. If the light remains on steady, see "If the Light Is On Steady" following. If the light is still flashing, follow the previous steps, and drive the vehicle to your dealer or qualified service center for service.

If the Light Is On Steady

You may be able to correct the emission system malfunction by considering the following:

Did you just put fuel into your vehicle?

If so, reinstall the fuel cap, making sure to fully install the cap. The diagnostic system can determine if the fuel cap has been left off or improperly installed. This will allow fuel to evaporate into the atmosphere. A few driving trips should turn the light off.

Did you just drive through a deep puddle of water?

If so, your electrical system may be wet. The condition will usually be corrected when the electrical system dries out. A few driving trips should turn the light off.

Are you low on fuel?

As your engine starts to run out of fuel, your engine may not run as efficiently as designed since small amounts of air are sucked into the fuel line causing a misfire. The system can detect this. Adding fuel should correct this condition. Make sure to install the fuel cap properly. It will take a few driving trips to turn the light off.

Have you recently changed brands of fuel?

If so, be sure to fuel your vehicle with quality fuel (see “Fuel” in the Index). Poor fuel quality will cause your engine not to run as efficiently as designed. You may notice this as stalling after start-up, stalling when you put the vehicle into gear, misfiring, hesitation on acceleration or stumbling on acceleration. (These conditions may go away once the engine is warmed up.) This will be detected by the system and cause the light to turn on.

If you experience this condition, change the fuel brand you use. It will require at least one full tank of the proper fuel to turn the light off.

If none of the above steps have made the light turn off, have your dealer or qualified service center check the vehicle. Your dealer has the proper test equipment and diagnostic tools to fix any mechanical or electrical problems that may have developed.

Oil Warning Light

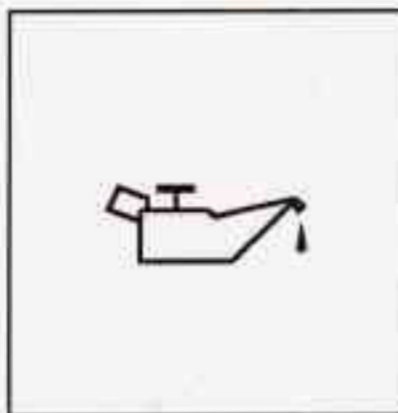

If you have a problem with your oil, this light may stay on after you start your engine, or come on when you are driving.

This indicates that oil is not going through your engine quickly enough to keep it lubricated. The engine could be low on oil or could have some other oil problem. Have it fixed right away.

The oil light could also come on in two other situations:

- When the ignition is on but the engine is not running, the light will come on as a test to show you it is working, but the light will go out when you turn the ignition to START. If it doesn't come on with the ignition on, you may have a problem with the fuse or bulb. Have it fixed right away.

- If you make a hard stop, the light may come on for a moment. This is normal.

⚠ CAUTION:

Don't keep driving if the oil pressure is low. If you do, your engine can become so hot that it catches fire. You or others could be burned. Check your oil as soon as possible and have your vehicle serviced.

NOTICE:

Damage to your engine from neglected oil problems can be costly and is not covered by your warranty.

Low Oil Level Light

**LOW OIL
LEVEL**

Your engine is equipped with an oil level monitoring system. When the ignition key is turned on, the **LOW OIL LEVEL** light will briefly flash. If the light does not flash, have it fixed so it will be ready to warn you if there's a problem.

If the light stays on, stop the vehicle on a level surface and turn the engine off. Check the oil level using the engine oil dipstick. (See "Engine Oil" in the Index.) If the light does not flash, have the low oil level sensor system repaired so it will be ready to warn you if there's a problem.

The oil level monitoring system only checks oil level during the brief period between key on and engine crank. It does not monitor engine oil level when the engine is running. Additionally, an oil level check is only performed if the engine has been turned off for a considerable period of time, allowing the oil normally in circulation to drain back into the oil pan.

Security Light



SECURITY

This light will come on when you turn the key to START and stay on until the vehicle starts. It will also come on and stay on if your key is too dirty or wet for the PASS-Key® II system to read the resistor pellet.

If the resistor pellet is damaged or missing, the light will flash.

If you're driving and the light comes on and remains on, your PASS-Key II system is not working properly. Your vehicle is not protected by PASS-Key II, and you should see your dealer.

Fuel Gage

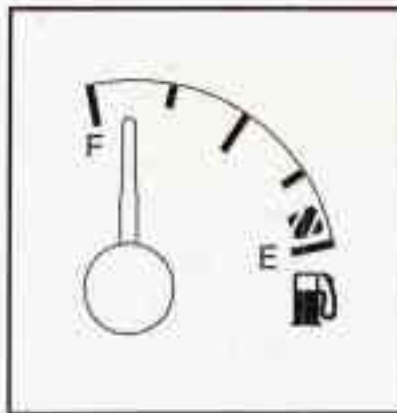

Your fuel gage tells you about how much fuel you have left when the ignition is on. When the indicator nears EMPTY (E), you still have a little fuel left, but you should get more soon.

Here are some things owners ask about. All these situations are normal and do not show a problem with your fuel gage:

- At the service station, the pump shuts off before the gage reads FULL (F).
- It takes a little more or less fuel to fill up than the gage indicated. For example, the gage may have indicated the tank was half full, but it actually took a little more or less than half the tank's capacity to fill it.
- The gage moves a little when you turn a corner or speed up.

Low Fuel Light

LOW
FUEL

If your fuel is low, a light will come on and stay on until you add fuel. It will also come on for a few seconds when you first turn on the ignition as a check to show you it's working. If it doesn't come on then, have it fixed.

When you start your engine, the trip calculator will display a mode. A lighted arrow shows which mode is displayed.

INST ECON: Shows your fuel economy when you select this mode. This display will update every second and cannot be reset.

AVG ECON: Shows your average fuel economy since you last reset this mode.

AVG SPEED: Shows your average speed since you last reset this mode. It counts only the time the engine is running. The display will be updated every three seconds until you select another mode.

FUEL USED: Shows the total amount of fuel used since you last reset this mode. The amount can be displayed in gallons or liters.

RANGE: Shows how much farther you can travel with the fuel you have before refueling. If there is less than one-eighth of a tank, LOFUEL will be displayed. If the fuel level is low enough, LOFUEL will show on the display in all modes. The message will flash for 60 seconds and then stay on until you add more fuel. You can't reset RANGE mode. Range is updated automatically when you reset AVG ECON.

Trip Calculator (Option)

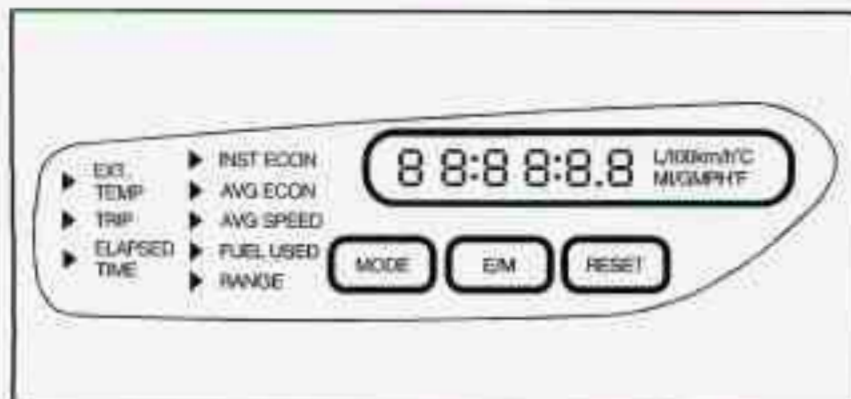

EXT. TEMP: Shows the temperature outside your vehicle. Temperature can be displayed in Fahrenheit or Celsius. This mode can't be reset.

TRIP: Shows how far you've driven since you last reset this mode.

ELAPSED TIME: Shows how much time has passed with the engine running since you last reset this mode.

Control Buttons

The trip calculator has three buttons that control its functions.

MODE: Press this button to change the mode being displayed.

E/M: Press this button to change the display from English to metric units or metric to English.

RESET: Press this button for one second to reset the mode displayed. If you push and hold RESET for more than five seconds, all the modes will reset. You can't reset INST ECON, RANGE or EXT. TEMP.

Head-Up Display (Option)



If you have the Head-Up Display (HUD), you can see the speedometer reading, in English or metric units, displayed "through" the windshield.

The HUD also shows these lights when they are lit on the instrument panel:

- Turn Signal Indicators
- High-Beam Indicator Symbol
- Low Fuel Symbol
- Oil Warning Symbol
- Coolant Temperature Symbol
- Charging System Symbol

When you sit straight in your seat, the HUD image will appear straight ahead near the front bumper.

When the ignition key is turned to RUN, all possible HUD images will come on. Then the Head-Up Display will operate normally.

NOTICE:

Although the HUD image appears to be near the front of the vehicle, do not use it as a parking aid. The HUD was not designed for that purpose. If you try to use it that way, such as in a parking lot, you may misjudge distance and run into something.

To adjust the HUD so you can see it properly:

1. Start your engine and turn the HUD dial all the way up.
 - When the headlamps are off, the HUD image will be at a preset daytime brightness.
 - When the headlamps are on, the HUD image brightness is controlled by the dimmer control.
2. Adjust your seat, if necessary, to a comfortable position.
3. Press the top of the IMAGE switch until the HUD image stops moving. Then press the bottom of the switch until the image is as low as possible, but in full view.
4. Turn the HUD dial down until the HUD image is no brighter than necessary. To turn the HUD off, turn the HUD dial all the way down.

If the sun comes out, it becomes cloudy, or if you turn on your headlamps, you may need to adjust the HUD brightness again. Polarizing sunglasses could make the HUD image harder to see.

⚠ CAUTION:

If the HUD image is too bright, or too high in your field of view, it may take you more time to see things you need to see when it's dark outside. Be sure to keep the HUD image dim and placed low in your field of view.



Push the E/M button on the trip calculator to switch the speedometer from English to metric or metric to English. If you don't have the trip calculator, you can't change the display.

Care of the Head-Up Display

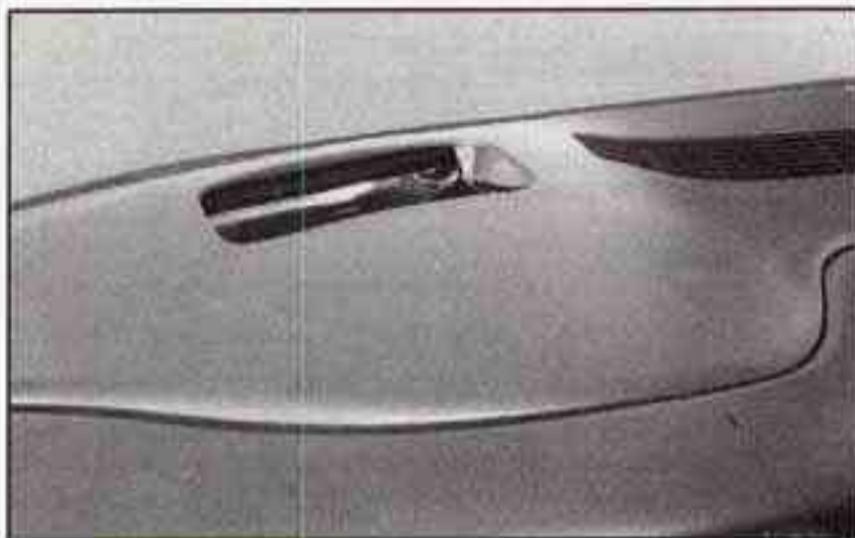

Clean the inside of the windshield as needed to remove any dirt or film that reduces the sharpness or clarity of the HUD image.

To clean the HUD, spray household glass cleaner on a soft, clean cloth. Wipe the HUD lens gently, then dry it. Do not spray cleaner directly on the lens because the cleaner could leak into the unit.

If You Can't See the HUD Image When the Ignition Is On

- Is anything covering the HUD unit?
- Is the HUD dimmer setting bright enough?
- Is the HUD image adjusted to the proper height?
- Still no HUD image? Check the fuse in the I/P Electronics position in the instrument panel fuse block. See "Fuses and Circuit Breakers" in the Index.

If the HUD Image Is Not Clear

- Is the HUD image too bright?
- Are the windshield and HUD lens clean?

Your windshield is part of the HUD system. If you ever have to have a new windshield, be sure to get one designed for HUD. If you don't, the HUD image may look blurred and out of focus.



Section 3 Comfort Controls and Audio Systems

In this section you'll find out how to operate the comfort control and audio systems offered with your Pontiac. Be sure to read about the particular systems supplied with your vehicle.

Comfort Controls

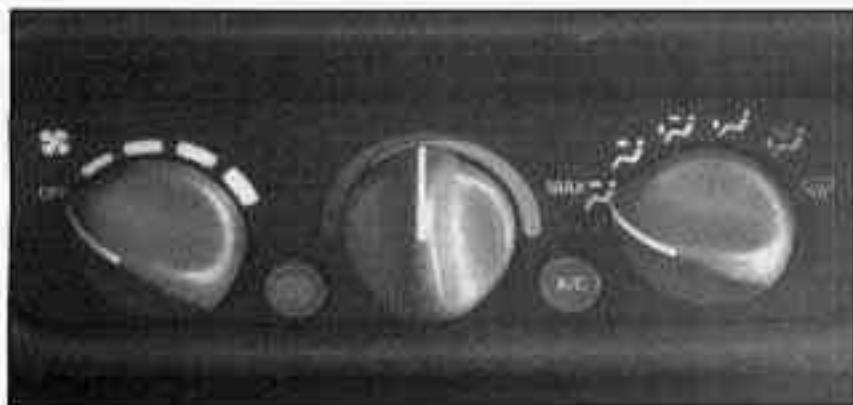

With this system, you can control the heating, cooling and ventilation in your vehicle. The system works best if you keep your windows closed while using it.

Fan Knob

The left knob selects the force of air you want. To turn the fan off, turn the knob to OFF. The fan must be on to run the air conditioning compressor.

Temperature Knob

The center knob changes the temperature of the air coming through the system. Turn this knob toward red (clockwise) for warmer air. Turn it toward blue (counterclockwise) for cooler air.

Mode Knob

The right knob has several settings to control the direction of airflow. For each setting, set the temperature to a comfortable setting.

MAX: This setting recirculates much of the air inside your vehicle and sends it through the instrument panel outlets. The air conditioning compressor will run automatically in this setting unless the outside temperature is below 40°F (4.5°C). (Even when the compressor is running, you can control the temperature.)



VENT: This setting brings in outside air and directs it through the instrument panel outlets.



BI-LEVEL: This setting brings in outside air and directs it two ways. Half of the air is directed through the instrument panel outlets. Most of the remaining air is directed through the floor ducts and a little to the defrost and side window vents.



FLOOR: This setting sends most of the air through the ducts near the floor. The rest comes out of the defroster and side window vents.



DEFOG: This setting allows half of the air to go to the floor ducts and half to the defroster and side window vents.



DEFROST: This setting directs most of the air through the defroster and side window vents. Some of the air goes to the floor ducts. The air conditioning compressor will run automatically in this setting unless the outside temperature is below 40°F (4.5°C). (Even when the compressor is running, you can control the temperature.)

Air Conditioning Compressor Button

Press the A/C button to operate the air conditioning compressor. The indicator light above the button will glow when the button is pressed. You don't have to press the button to run the compressor in MAX or DEFROST.

Air Conditioning

On very hot days, open the windows long enough to let hot, inside air escape. This reduces the time the compressor has to run, which should help fuel economy.

For quick cool-down on very hot days, use MAX with the temperature knob all the way in the blue area. If this setting is used for long periods of time, the air in your vehicle may become too dry.

For normal cooling on hot days, turn the control knob to the VENT position, with the temperature knob in the blue area and press the A/C button once (the indicator

light will come on). The system will bring in outside air and cool it. To turn off the air conditioning, press the A/C button again (the indicator light will go off).

On cool but sunny days, the sun may warm your upper body, but your lower body may not be warm enough. Turn the control knob to the BI-LEVEL position, with the temperature knob set for comfort and press the A/C button once (the indicator light will come on). The system will bring in outside air and direct it to your upper body, while sending slightly warmed air to your lower body. You may notice this temperature difference more at some times than others. To turn off the air conditioning, press the A/C button again (the indicator light will go off).

Heating

On cold days, use FLOOR with the temperature knob all the way in the red area. The system will bring in outside air, heat it and send it to the floor ducts.

If your vehicle has an engine coolant heater, you can use it to help your system provide warm air faster when it's cold outside (0°F (-18°C) or lower). An engine coolant heater warms the coolant your engine and heating system use to provide heat. See "Engine Coolant Heater" in the Index.

Ventilation System



Adjust the direction of airflow by moving the louvered vents.

Your vehicle's flow-through ventilation system supplies outside air into the vehicle when it is moving. Outside air will also enter the vehicle when the air conditioning fan is running.

For mild outside temperatures when little heating or cooling is needed, use VENT to direct outside air through your vehicle.

Ventilation Tips

- Keep the hood and front air inlet free of ice, snow or any other obstruction, such as leaves. The heater and defroster will work far better, reducing the chance of fogging the inside of your windows.
- When you enter a vehicle in cold weather, adjust the mode knob to FLOOR and the fan to the highest speed for a few moments before driving off. This helps clear the intake ducts of snow and moisture and reduces the chance of fogging the inside of your windows.
- Keep the air path under the front seats clear of objects. This helps air to circulate throughout your vehicle.

Defogging and Defrosting

Your system has two settings for clearing the front and side windows. To defrost the windows quickly, use DEFROST with the temperature knob all the way in the red area. To warm passengers while keeping the windows clean, use DEFOG.

Rear Window Defogger



The rear window defogger uses a warming grid to remove fog from the rear window. Press the button to turn the defogger on. It will turn itself off after about 10 minutes.

If you turn it on again, the defogger will only run for about five minutes before turning off. You can also turn it off by turning off the ignition or pressing the button again.

Do not attach anything like a temporary vehicle license or decal across the defogger grid.

NOTICE:

Don't use a razor blade or anything else sharp on the inside of the rear window. If you do, you could cut or damage the warming grid, and the repairs wouldn't be covered by your warranty.

Audio Systems

Your Delco® audio system has been designed to operate easily and give years of listening pleasure. You will get the most enjoyment out of it if you acquaint yourself with it first. Find out what your Delco system can do and how to operate all its controls, to be sure you're getting the most out of the advanced engineering that went into it.

Setting the Clock for AM-FM Stereo

Press SET. Within five seconds, press and hold the SEEK down arrow until the correct hour appears on the display. Press and hold the SEEK up arrow until the correct minute appears on the display.

Setting the Clock for All Systems Except AM-FM Stereo

Press and hold HR until the correct hour appears. Press and hold MIN until the correct minute appears. There will be a two-second delay before the clock goes into time-set mode, and the colon on the display will blink while in this mode.

AM-FM Stereo

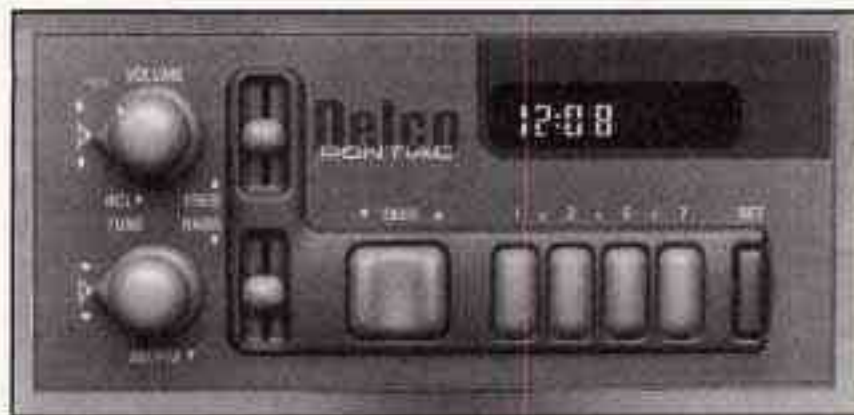

Playing the Radio

VOLUME: Turn this knob to turn the system on or off. Turn the knob clockwise to increase volume. Turn it counterclockwise to decrease volume.

RCL: Press the upper knob briefly to recall the station being played or to display the clock.

Finding a Station

AM-FM: Press the lower knob to get AM or FM. The display shows your selection.

TUNE: Turn the lower knob to choose radio stations.

SEEK: Press the up or down arrow to go to the next higher or lower station.

PUSHBUTTONS: The four numbered pushbuttons let you return to your favorite stations. You can set up to 14 stations (seven AM and seven FM).

1. Press AM-FM to select the band.
2. Tune in the desired station.
3. Press SET.
4. Within five seconds, press one of the four numbered pushbuttons. Whenever you press that numbered pushbutton, the station you set will return.
5. Repeat the steps for each pushbutton.

In addition to the four stations set as above, up to three additional stations may be preset on each band by pressing two adjoining buttons at the same time. Just:

1. Tune in the desired station.
2. Press SET.
3. Press any two adjoining pushbuttons at the same time (within five seconds).
4. Whenever you press the same buttons, the station you set will return.

Setting the Tone

BASS: Slide the lever up or down to increase or decrease bass.

TREB: Slide the lever up or down to increase or decrease treble. If a station is weak or noisy, slide the lever down to reduce the noise.

Adjusting the Speakers

BALANCE: Turn the control behind the upper knob to move the sound to the left or right speakers. Use the middle position to balance these speakers.

FADE: Turn the control behind the lower knob to move the sound to the front or rear speakers. Use the middle position to balance these speakers.

AM-FM Stereo with Cassette Tape Player (Option)



Playing the Radio

VOL: Push this knob to turn the system on or off. Turn it clockwise to increase volume and counterclockwise to decrease volume.

RECALL: Press this button briefly to recall the station being played or to display the clock. If you press the knob when the ignition is off, the clock will show for a few seconds.

Finding a Station

AM-FM: Press this button to get AM, FM1 or FM2. The display shows your selection. If a cassette tape is *playing*, press this button to play the radio.

TUNE: Press this knob lightly so it extends. Turn it to choose radio stations. Push the knob back in when you're not using it.

SEEK: Press the up or down arrow to go to the next higher or lower station.

PUSHBUTTONS: The six numbered pushbuttons let you return to your favorite stations. You can set up to 18 stations (six AM, six FM1 and six FM2).

1. Press AM-FM to select the band.
2. Find the station you want by using TUNE or SEEK.
3. Press and hold one of the six numbered buttons until SET appears on the display. Whenever you press that numbered button, the station you set will return.
4. Repeat the steps for each pushbutton.

Setting the Tone

BASS: Slide the lever to the right or left to increase or decrease bass.

TREBLE: Slide the lever to the right or left to increase or decrease treble. If a station is weak or noisy, slide the lever down to reduce the noise.

Adjusting the Speakers

BAL: Press this knob lightly so it extends. Turn this knob to move the sound to the left or right speakers. Use the middle position to balance these speakers. Push the knob back in when you're not using it.

FADE: Press this knob lightly so it extends. Turn this knob to move the sound to the front or rear speakers. Use the middle position to balance these speakers. Push the knob back in when you're not using it.

Playing a Cassette Tape

Your tape player is built to work best with tapes that are 30 to 45 minutes long on each side. Tapes longer than that are so thin they may not work well in this player.

While the tape is playing, use the VOL, FADE, BAL, TREBLE and BASS controls just as you do for the radio. The display will show an arrow to show which side of the tape is playing. When the down indicator arrow is lit, selections listed on the bottom side of the cassette are playing. When the up arrow is lit, selections listed on the top side of the cassette are playing. The tape player automatically begins playing the other side when it reaches the end of the tape.

If E and a number appear on the radio display, the tape won't play because of an error.

- **E10:** The tape is tight and the player can't turn the tape hubs. Remove the tape. Hold the tape with the open end down and try to turn the right hub counterclockwise with a pencil. Turn the tape over and repeat. If the hubs do not turn easily, your tape may be damaged and should not be used in the player. Try a new tape to make sure your player is working properly.
- **E11:** The tape is broken. Try a new tape.

If any error occurs repeatedly or if an error can't be corrected, please contact your dealer. If your radio displays an error number, write it down and provide it to your dealer when reporting the problem.

PREV (1): Press this button or the SEEK down arrow to search for the previous selection on the tape. Your tape must have at least three seconds of silence between each selection for PREV or SEEK to work. The tape direction arrow blinks during PREV or SEEK operation. Press PREV or the SEEK down arrow to stop searching. The sound is muted during PREV or SEEK operation.

NEXT (2): Press this button or the SEEK up arrow to search for the next selection on the tape. If you hold the button or press it more than once, the player will continue moving forward through the tape. Your tape must have at least three seconds of silence between each selection for NEXT or SEEK to work. The tape direction arrow blinks during NEXT or SEEK operation. Press PREV or the SEEK up arrow to stop searching. The sound is muted during NEXT or SEEK operation.

PROG (3): Press this button to play the other side of the tape.

DD (4): Press this button to reduce background noise. Note that the double-D symbol will appear on the display.

Dolby[®] Noise Reduction is manufactured under a license from Dolby Laboratories Licensing Corporation. Dolby and the double-D symbol are trademarks of Dolby Laboratories Licensing Corporation.

REV (5): Press this button to reverse the tape rapidly. Press it again to return to playing speed. The radio will play the last-selected station while the tape reverses. You may select stations during REV operation by using SEEK or TUNE.

FWD (6): Press this button to advance quickly to another part of the tape. Press the button again to return to playing speed. The radio will play the last-selected station while the tape advances. You may select stations during FWD operation by using SEEK or TUNE.

AM-FM: Press this button to play the radio when a tape is in the player.

TAPE/PLAY: Press this button to change to the tape function when the radio is on. The tape symbol with an arrow will appear on the display when the tape is active. To return to playing the radio, press the AM-FM button.

EJECT: Press this button to remove the tape. The radio will play. EJECT may be activated with either the ignition or radio off. Cassettes may be loaded with the radio and ignition off if this button is pressed first.

CLN: This message may appear on the display. If it does, your cassette tape player needs to be cleaned. It will still play tapes, but you should clean it as soon as possible to prevent damage to your tapes and player. See "Care of Your Cassette Tape Player" in the Index. After you clean the player, press and hold EJECT for five seconds to reset the CLN indicator. The radio will display --- to show the indicator was reset.

AM-FM Stereo with Cassette Tape Player and Equalizer (Option)



Playing the Radio

VOL: Push this knob to turn the system on or off. Turn it clockwise to increase volume and counterclockwise to decrease volume.

RECALL: Press this button briefly to recall the station being played or to display the clock. If you press the knob when the ignition is off, the clock will show for a few seconds.

Finding a Station

AM-FM: Press this button to get AM, FM1 or FM2. The display shows your selection. If a cassette tape is playing, press this button to play the radio.

TUNE: Press this knob lightly so it extends. Turn it to choose radio stations. Push the knob back in when you're not using it.

SEEK: Press the up or down arrow to go to the next higher or lower station.

PUSHBUTTONS: The six numbered pushbuttons let you return to your favorite stations. You can set up to 18 stations (six AM, six FM1 and six FM2).

1. Press AM-FM to select the band.
2. Find the station you want by using TUNE or SEEK.
3. Press and hold one of the six numbered buttons until SET appears on the display. Whenever you press that numbered button, the station you set will return.
4. Repeat the steps for each pushbutton.

Setting the Tone

EQUALIZER: A seven band equalizer is part of your audio system. Slide the levers up to boost or down to reduce frequency range.

Adjusting the Speakers

BAL: Press this knob lightly so it extends. Turn it to move the sound to the left or right speakers. Use the middle position to balance these speakers. Push the knob back in when you're not using it.

FADE: Press this knob lightly so it extends. Turn it to move the sound to the front or rear speakers. Use the middle position to balance these speakers. Push the knob back in when you're not using it.

Playing a Cassette Tape

Your tape player is built to work best with tapes that are 30 to 45 minutes long on each side. Tapes longer than that are so thin they may not work well in this player.

While the tape is playing, use the VOL, FADE and BAL controls just as you do for the radio. The display will show an arrow to show which side of the tape is playing. When the down indicator arrow is lit, selections listed on the bottom side of the cassette are playing. When the up arrow is lit, selections listed on the top side of the cassette are

playing. The tape player automatically begins playing the other side when it reaches the end of the tape.

If E and a number appear on the radio display, the tape won't play because of an error.

- **E10:** The tape is tight and the player can't turn the tape hubs. Remove the tape. Hold the tape with the open end down and try to turn the right hub counterclockwise with a pencil. Turn the tape over and repeat. If the hubs do not turn easily, your tape may be damaged and should not be used in the player. Try a new tape to make sure your player is working properly.
- **E11:** The tape is broken. Try a new tape.

If any error occurs repeatedly or if an error can't be corrected, please contact your dealer. If your radio displays an error number, write it down and provide it to your dealer when reporting the problem.

PREV (I): Press this button or the SEEK down arrow to search for the previous selection on the tape. Your tape must have at least three seconds of silence between each selection for PREV or SEEK to work. The tape direction arrow blinks during PREV or SEEK operation. Press PREV or the SEEK down arrow to stop searching. The sound is muted during PREV or SEEK operation.

NEXT (2): Press this button or the SEEK up arrow to search for the next selection on the tape. If you hold the button or press it more than once, the player will continue moving forward through the tape. Your tape must have at least three seconds of silence between each selection for NEXT or SEEK to work. The tape direction arrow blinks during NEXT or SEEK operation. Press PREV or the SEEK up arrow to stop searching. The sound is muted during NEXT or SEEK operation.

PROG (3): Press this button to play the other side of the tape.

DD (4): Press this button to reduce background noise. Note that the double-D symbol will appear on the display.

Dolby Noise Reduction is manufactured under a license from Dolby Laboratories Licensing Corporation. Dolby and the double-D symbol are trademarks of Dolby Laboratories Licensing Corporation.

REV (5): Press this button to reverse the tape rapidly. Press it again to return to playing speed. The radio will play the last-selected station while the tape reverses. You may select stations during REV operation by using SEEK or TUNE.

FWD (6): Press this button to advance quickly to another part of the tape. Press the button again to return

to playing speed. The radio will play the last-selected station while the tape advances. You may select stations during FWD operation by using SEEK or TUNE.

AM-FM: Press this button to play the radio when a tape is in the player.

TAPE/PLAY: Press this button to change to the tape function when the radio is on. The tape symbol with an arrow will appear on the display when the tape is active. To return to playing the radio, press the AM-FM button.

EJECT: Press this button to remove the tape. The radio will play. EJECT may be activated with either the ignition or radio off. Cassettes may be loaded with the radio off if this button is pressed first.

CLN: This message may appear on the display. If it does, your cassette tape player needs to be cleaned. It will still play tapes, but you should clean it as soon as possible to prevent damage to your tapes and player. See "Care of Your Cassette Tape Player" in the Index. After you clean the player, press and hold EJECT for five seconds to reset the CLN indicator. The radio will display --- to show the indicator was reset.

AM-FM Stereo with Compact Disc Player (Option)



Playing the Radio

VOL: Push this knob to turn the system on or off. Turn it clockwise to increase volume and counterclockwise to decrease volume.

RECALL: Press this button briefly to recall the station being played or to display the clock. If you press the knob when the ignition is off, the clock will show for a few seconds.

Finding a Station

AM-FM: Press this button to get AM, FM1 or FM2. The display shows your selection.

TUNE: Press this knob lightly so it extends. Turn it to choose radio stations. Push the knob back in when you're not using it.

SEEK: Press the up or down arrow to go to the next higher or lower station.

PUSHBUTTONS: The six numbered pushbuttons let you return to your favorite stations. You can set up to 18 stations (six AM, six FM1 and six FM2).

1. Press AM-FM to select the band.
2. Find the station you want by using TUNE or SEEK.
3. Press and hold one of the six numbered buttons until SET appears on the display. Whenever you press that numbered button, the station you set will return.
4. Repeat the steps for each pushbutton.

Setting the Tone

BASS: Slide the lever to the right or left to increase or decrease bass.

TREBLE: Slide the lever to the right or left to increase or decrease treble. If a station is weak or noisy, slide the lever down to reduce the noise.

Adjusting the Speakers

BAL: Press this knob lightly so it extends. Turn it to move the sound to the left or right speakers. Use the middle position to balance these speakers. Push the knob back in when you're not using it.

FADE: Press this knob lightly so it extends. Turn it to move the sound to the front or rear speakers. Use the middle position to balance these speakers. Push the knob back in when you're not using it.

Playing a Compact Disc

The integral CD player can play 8 cm "single" mini-discs. Full-size compact discs and mini-discs are loaded in the same manner.

Insert a disc partway into the slot, label side up. The player will pull it in. The compact disc symbol will appear on the display. If the ignition is on, but the radio is off, the disc will begin playing. CD will appear on the

display. If you want to insert a disc when the ignition is off, first press EJECT.

If you're driving on a very rough road or if it's very hot, the disc may not play and E (error) and a number may appear on the radio display. If the disc comes out, it could be that:

- The disc is upside down.
- It is dirty, scratched or wet.
- The air is very humid. (If so, wait about an hour and try again.)

If any error occurs repeatedly or if an error can't be corrected, please contact your dealer. If your radio displays an error number, write it down and provide it to your dealer when reporting the problem.

RECALL: Press this button to see what track is playing. Press it again within five seconds to see how long it has been playing (elapsed time). The track number also appears when the disc is inserted, you change the volume or when a new track starts playing.

PREV (1): Press this button or the SEEK down arrow to go to the start of the current track if more than eight seconds have played. If you hold the button or press it more than once, the player will continue moving back through the disc.

NEXT (2): Press this button or the SEEK up arrow to go to the start of the next track if more than eight seconds have played. If you hold the button or press it more than once, the player will continue moving forward through the disc.

RDM (3): Press this button to hear the tracks in a random order. It will change tracks in a random, rather than sequential order. Press RDM again to turn off random play.

REV (5): Press and hold this button to quickly reverse within a track (song). Release it to play the passage. You will hear sound at a reduced volume. The display will show elapsed time.

FWD (6): Press and hold this button to quickly advance within a track (song). You will hear sound at a reduced volume. The display will show elapsed time.

AM-FM: Press this button to play the radio when a disc is playing. The disc will stop but remain in the player.

CD/PLAY: Press this button to change to the disc function when the radio is on.

EJECT: Press this button to remove the disc or stop the disc and switch to the radio. EJECT will work with the radio off.

AM-FM Stereo with Compact Disc Player and Equalizer (Option)



Playing the Radio

VOL: Push this knob to turn the system on or off. Turn it clockwise to increase volume and counterclockwise to decrease volume.

RECALL: Press this button briefly to recall the station being played or to display the clock. If you press the knob when the ignition is off, the clock will show for a few seconds.

Finding a Station

AM-FM: Press this button to get AM, FM1 or FM2. The display shows your selection.

TUNE: Press this knob lightly so it extends. Turn it to choose radio stations. Push the knob back in when you're not using it.

SEEK: Press the up or down arrow to go to the next higher or lower station.

PUSHBUTTONS: The six numbered pushbuttons let you return to your favorite stations. You can set up to 18 stations (six AM, six FM1 and six FM2).

1. Press AM-FM to select the band.
2. Find the station you want by using TUNE or SEEK.
3. Press and hold one of the six numbered buttons until SET appears on the display. Whenever you press that numbered button, the station you set will return.
4. Repeat the steps for each pushbutton.

Setting the Tone

EQUALIZER: A seven band equalizer is part of your audio system. Slide the levers up to boost or down to reduce frequency range.

Adjusting the Speakers

BAL: Press this knob lightly so it extends. Turn it to move the sound to the left or right speakers. Use the middle position to balance these speakers. Push the knob back in when you're not using it.

FADE: Press this knob lightly so it extends. Turn it to move the sound to the front or rear speakers. Use the middle position to balance these speakers. Push the knob back in when you're not using it.

Playing a Compact Disc

The integral CD player can play 8 cm "single" mini-discs. Full-size compact discs and mini-discs are loaded in the same manner.

Insert a disc partway into the slot, label side up. The player will pull it in. If the ignition is on, but the radio is off, the disc will begin playing. If you want to insert a disc when the ignition is off, first press EJECT.

If you're driving on a very rough road or if it's very hot, the disc may not play and E (error) and a number may appear on the radio display. If the disc comes out, it *could be that*:

- The disc is upside down.
- It is dirty, scratched or wet.
- The air is very humid. (If so, wait about an hour and try again.)

If any error occurs repeatedly or if an error can't be corrected, please contact your dealer. If your radio displays an error number, write it down and provide it to your dealer when reporting the problem.

RECALL: Press this button to see what track is playing. Press it again within five seconds to see how long it has been playing (elapsed time). The track number also appears when the disc is inserted, the volume is changed or when a new track starts playing.

PREV (1): Press this button or the SEEK down arrow to go to the start of the current track if more than eight seconds have played. If you hold the button or press it more than once, the player will continue moving back through the disc.

NEXT (2): Press this button or the SEEK up arrow to go to the start of the next track if more than eight seconds have played. If you hold the button or press it more than once, the player will continue moving forward through the disc.

RDM (3): Press this button to hear the tracks in a random order. It will change discs and tracks in a random, rather than sequential order. Press RDM again to turn off random play. The radio will play during this operation.

REV (5): Press and hold this button to quickly reverse within a track (song). Release it to play the passage. You will hear sound at a reduced volume. The display will show elapsed time.

FWD (6): Press and hold this button to quickly advance within a track (song). You will hear sound at a reduced volume. The display will show elapsed time.

AM-FM: Press this button to play the radio when a disc is playing. The disc will stop but remain in the player.

CD/PLAY: Press this button to change to the disc function when the radio is on.

EJECT: Press this button to remove the disc or stop the disc and switch to the radio. EJECT will work with the radio off.

Theft-Deterrent Feature

THEFTLOCK™ is designed to discourage theft of your radio. It works by using a secret code to disable all radio functions whenever battery power is removed.

The THEFTLOCK feature for the radio may be used or ignored. If ignored, the system plays normally and the radio is not protected by the feature. If THEFTLOCK is activated, your radio will not operate if stolen.

When THEFTLOCK is activated, the radio will display LOC to indicate a locked condition anytime battery power is removed. If your battery loses power for any reason, you must unlock the radio with the secret code before it will operate.

Activating the Theft-Deterrent Feature

The instructions which follow explain how to enter your secret code to activate the THEFTLOCK system. It is recommended that you read through all nine steps before starting the procedure.

NOTE: If you allow more than 15 seconds to elapse between any steps, the radio automatically reverts to time and you must start the procedure over at Step 4.

1. Write down any three or four-digit number from 000 to 1999 and keep it in a safe place separate from the vehicle.
2. Turn the ignition to the ACC or RUN position.
3. Turn the radio off.
4. Press the 1 and 4 buttons together. Hold them down until --- shows on the display. Next you will use the secret code number which you have written down.
5. Press MIN and 000 will appear on the display.
6. Press MIN again to make the last two digits agree with your code.
7. Press HR to make the first one or two digits agree with your code.
8. Press AM-FM after you have confirmed that the code matches the secret code you have written down. The display will show REP to let you know that you need to repeat Steps 5 through 7 to confirm your secret code.
9. Press AM-FM and this time the display will show SEC to let you know that your radio is secure.

Unlocking the Theft-Deterrent Feature After a Power Loss

Enter your secret code as follows; pause no more than 15 seconds between steps:

1. LOC appears when the ignition is on.
2. Press MIN and 000 will appear on the display.
3. Press MIN again to make the last two digits agree with your code.
4. Press HR to make the first one or two digits agree with your code.
5. Press AM-FM after you have confirmed that the code matches the secret code you have written down. The display will show SEC, indicating the radio is now operable and secure.

If you enter the wrong code eight times, INOP will appear on the display. You will have to wait an hour with the ignition on before you can try again. When you try again, you will only have three chances to enter the correct code before INOP appears.

If you lose or forget your code, contact your dealer.

Disabling the Theft-Deterrent Feature

Enter your secret code as follows; pause no more than 15 seconds between steps:

1. Turn the ignition to the ACC or RUN position.
2. Turn the radio off.
3. Press the 1 and 4 buttons together. Hold them down until SEC shows on the display.
4. Press MIN and 000 will appear on the display.
5. Press MIN again to make the last two digits agree with your code.
6. Press HR to make the first one or two digits agree with your code.
7. Press AM-FM after you have confirmed that the code matches the secret code you have written down. The display will show ---, indicating that the radio is no longer secured.

If the code entered is incorrect, SEC will appear on the display. The radio will remain secured until the correct code is entered.

When battery power is given to a secured radio, the radio won't turn on and LOC will appear on the display.

Steering Wheel Controls (Option)



If your vehicle has this feature, you can control certain radio functions using the buttons on your steering wheel.

VOLUME: Press the up arrow to increase the volume and the down arrow to decrease volume.

PLAY: Press this button to play a cassette tape or compact disc when the radio is playing.

MUTE: Press this button to silence the system. Press it again, or any other radio button, to turn on the sound.

SEEK: Press the up arrow to tune to the next radio station and the down arrow to tune to the previous radio station. If a cassette tape or compact disc is playing, the player will advance with the up arrow and rewind with the down arrow.

PRESET: Press this button to play a station you have programmed on the radio preset buttons.

AM-FM: Press this button to choose AM, FM1 or FM2. If a cassette tape or compact disc is playing, it will stop and the radio will play.

Understanding Radio Reception

FM Stereo

FM stereo will give you the best sound. But FM signals will reach only about 10 to 40 miles (16 to 65 km). Tall buildings or hills can interfere with FM signals, causing the sound to come and go.

AM

The range for most AM stations is greater than for FM, especially at night. The longer range, however, can cause stations to interfere with each other. AM can pick up noise from things like storms and power lines. Try reducing the treble to reduce this noise if you ever get it.

Tips About Your Audio System

Hearing damage from loud noise is almost undetectable until it is too late. Your hearing can adapt to higher volumes of sound. Sound that seems normal can be loud and harmful to your hearing. Take precautions by adjusting the volume control on your radio to a safe sound level before your hearing adapts to it.

To help avoid hearing loss or damage:

- Adjust the volume control to the lowest setting.
- Increase volume slowly until you hear comfortably and clearly.

NOTICE:

Before you add any sound equipment to your vehicle -- like a tape player, CB radio, mobile telephone or two-way radio -- be sure you can add what you want. If you can, it's very important to do it properly. Added sound equipment may interfere with the operation of your vehicle's engine, Delco radio or other systems, and even damage them. Your vehicle's systems may interfere with the operation of sound equipment that has been added improperly.

So, before adding sound equipment, check with your dealer and be sure to check Federal rules covering mobile radio and telephone units.

Care of Your Cassette Tape Player

A tape player that is not cleaned regularly can cause reduced sound quality, ruined cassettes or a damaged mechanism. Cassette tapes should be stored in their cases away from contaminants, direct sunlight and extreme heat. If they aren't, they may not operate properly or may cause failure of the tape player.

Your tape player should be cleaned regularly after every 50 hours of use. Your radio may display CLN to indicate that you have used your tape player for 50 hours without resetting the tape clean timer. If you notice a reduction in sound quality, try a known good cassette to see if the tape or the tape player is at fault. If this other cassette has no improvement in sound quality, clean the tape player.

Cleaning may be done with a scrubbing action, non-abrasive cleaning cassette with pads which scrub the tape head as the hubs of the cleaner cassette turn. It is normal for the cassette to eject while cleaning. Insert the cassette at least three times to ensure thorough cleaning. A scrubbing action cleaning cassette is available through your Pontiac dealer.

You may also choose a non-scrubbing action, wet-type cleaner which uses a cassette with a fabric belt to clean the tape head. This type of cleaning cassette will not

eject. It may not clean as thoroughly as the scrubbing type cleaner.

Cassettes are subject to wear and the sound quality may degrade over time. Always make sure that the cassette tape is in good condition before you have your tape player serviced.

Care of Your Compact Discs

Handle discs carefully. Store them in their original cases or other protective cases and away from direct sunlight and dust. If the surface of a disc is soiled, dampen a clean, soft cloth in a mild, neutral detergent solution and clean it, wiping from the center to the edge.

Be sure never to touch the signal surface when handling discs. Pick up discs by grasping the outer edges or the edge of the hole and the outer edge.

Fixed Mast Antenna

The fixed mast antenna can withstand most car washes without being damaged. If the mast should ever become slightly bent, you can straighten it out by hand. If the mast is badly bent, as it might be by vandals, you should replace it.

Check every once in a while to be sure the mast is still tightened to the fender.

Power Antenna Mast Care

Your power antenna will look its best and work well if it's cleaned from time to time. To clean the antenna mast:

1. Turn on the ignition and radio to raise the antenna.
2. Dampen a clean cloth with mineral spirits or an equivalent solvent.
3. Wipe the cloth over the mast sections, removing any dirt.
4. Wipe dry with a clean cloth.
5. Make the antenna go up and down by turning the radio or ignition off and on.
6. Repeat if necessary.

NOTICE:

Don't lubricate the power antenna. Lubrication could damage it.

NOTICE:

Before entering an automatic car wash, turn off your radio to make the power antenna go down. This will prevent the mast from possibly getting damaged. If the antenna does not go down when you turn the radio off, it may be damaged or need to be cleaned. In either case, lower the antenna by hand by carefully pressing the antenna down.

If the mast portion of your antenna is damaged, you can easily replace it. See your dealer for a replacement kit and follow the instructions in the kit.



Section 4 Your Driving and the Road



Here you'll find information about driving on different kinds of roads and in varying weather conditions. We've also included many other useful tips on driving.

Defensive Driving

The best advice anyone can give about driving is: Drive defensively.

Please start with a very important safety device in your Pontiac: Buckle up. (See "Safety Belts" in the Index.)

Defensive driving really means "be ready for anything." On city streets, rural roads or freeways, it means "always expect the unexpected."

Assume that pedestrians or other drivers are going to be careless and make mistakes. Anticipate what they might do. Be ready for their mistakes.

Rear-end collisions are about the most preventable of accidents. Yet they are common. Allow enough following distance. It's the best defensive driving maneuver, in both city and rural driving. You never know when the vehicle in front of you is going to brake or turn suddenly.

Drunken Driving

Death and injury associated with drinking and driving is a national tragedy. It's the number one contributor to the highway death toll, claiming thousands of victims every year.

Alcohol affects four things that anyone needs to drive a vehicle:

- Judgment
- Muscular Coordination
- Vision
- Attentiveness.

Police records show that almost half of all motor vehicle-related deaths involve alcohol. In most cases, these deaths are the result of someone who was drinking and driving. In recent years, some 18,000 annual motor vehicle-related deaths have been associated with the use of alcohol, with more than 300,000 people injured.

Many adults -- by some estimates, nearly half the adult population -- choose never to drink alcohol, so they never drive after drinking. For persons under 21, it's against the law in every U.S. state to drink alcohol. There are good medical, psychological and developmental reasons for these laws.

The obvious way to solve this highway safety problem is for people never to drink alcohol and then drive. But what if people do? How much is "too much" if the driver plans to drive? It's a lot less than many might think. Although it depends on each person and situation, here is some general information on the problem.

The Blood Alcohol Concentration (BAC) of someone who is drinking depends upon four things:

- The amount of alcohol consumed
- The drinker's body weight
- The amount of food that is consumed before and during drinking
- The length of time it has taken the drinker to consume the alcohol.

According to the American Medical Association, a 180-lb. (82 kg) person who drinks three 12-ounce (355 ml) bottles of beer in an hour will end up with a BAC of about 0.06 percent. The person would reach the same BAC by drinking three 4-ounce (120 ml) glasses of wine or three mixed drinks if each had 1-1/2 ounces (45 ml) of a liquor like whiskey, gin or vodka.

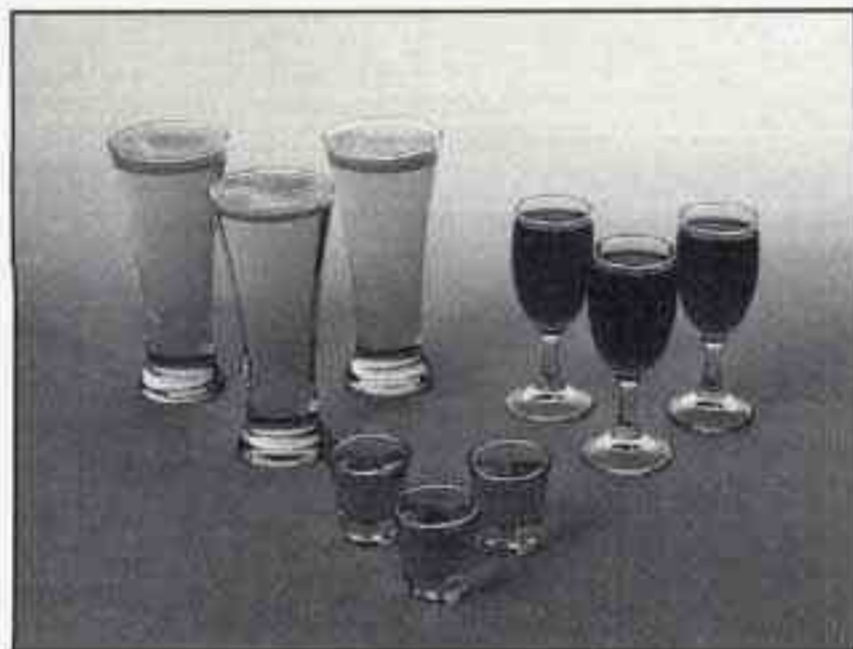

It's the amount of alcohol that counts. For example, if the same person drank three double martinis (3 ounces or 90 ml of liquor each) within an hour, the person's BAC would be close to 0.12 percent. A person who consumes food just before or during drinking will have a somewhat lower BAC level.

There is a gender difference, too. Women generally have a lower relative percentage of body water than men.

Since alcohol is carried in body water, this means that a woman generally will reach a higher BAC level than a man of her same body weight when each has the same number of drinks.

The law in many U.S. states sets the legal limit at a BAC of 0.10 percent. In a growing number of U.S. states, and throughout Canada, the limit is 0.08 percent. In some other countries, it's even lower. The BAC limit for all commercial drivers in the United States is 0.04 percent.

The BAC will be over 0.10 percent after three to six drinks (in one hour). Of course, as we've seen, it depends on how much alcohol is in the drinks, and how quickly the person drinks them.

But the ability to drive is affected well below a BAC of 0.10 percent. Research shows that the driving skills of many people are impaired at a BAC approaching 0.05 percent, and that the effects are worse at night. All drivers are impaired at BAC levels above 0.05 percent. Statistics show that the chance of being in a collision increases sharply for drivers who have a BAC of 0.05 percent or above. A driver with a BAC level of 0.06 percent has doubled his or her chance of having a collision. At a BAC level of 0.10 percent, the chance of this driver having a collision is 12 times greater; at a level of 0.15 percent, the chance is 25 times greater!

The body takes about an hour to rid itself of the alcohol in one drink. No amount of coffee or number of cold showers will speed that up. "I'll be careful" isn't the *right answer*. What if there's an emergency, a need to take sudden action, as when a child darts into the street? A person with even a moderate BAC might not be able to react quickly enough to avoid the collision.

There's something else about drinking and driving that many people don't know. Medical research shows that alcohol in a person's system can make crash injuries worse, especially injuries to the brain, spinal cord or heart. This means that when anyone who has been drinking — driver or passenger -- is in a crash, that person's chance of being killed or permanently disabled is higher than if the person had not been drinking.

 **CAUTION:**

Drinking and then driving is very dangerous. Your reflexes, perceptions, attentiveness and judgment can be affected by even a small amount of alcohol. You can have a serious -- or even fatal -- collision if you drive after drinking. Please don't drink and drive or ride with a driver who has been drinking. Ride home in a cab; or if you're with a group, designate a driver who will not drink.

Control of a Vehicle

You have three systems that make your vehicle go where you want it to go. They are the brakes, the steering and the accelerator. All three systems have to do their work at the places where the tires meet the road.



Sometimes, as when you're driving on snow or ice, it's easy to ask more of those control systems than the tires and road can provide. That means you can lose control of your vehicle.

Braking

Braking action involves *perception time* and *reaction time*.

First, you have to decide to push on the brake pedal. That's *perception time*. Then you have to bring up your foot and do it. That's *reaction time*.

Average *reaction time* is about $3/4$ of a second. But that's only an average. It might be less with one driver and as long as two or three seconds or more with another. Age, physical condition, alertness, coordination and eyesight all play a part. So do alcohol, drugs and frustration. But even in $3/4$ of a second, a vehicle moving at 60 mph (100 km/h) travels 66 feet (20 m). That could be a lot of distance in an emergency, so keeping enough space between your vehicle and others is important.

And, of course, actual stopping distances vary greatly with the surface of the road (whether it's pavement or gravel); the condition of the road (wet, dry, icy); tire tread; and the condition of your brakes.

Avoid needless heavy braking. Some people drive in spurts -- heavy acceleration followed by heavy braking -- rather than keeping pace with traffic. This is a mistake. Your brakes may not have time to cool between hard stops. Your brakes will wear out much faster if you do a lot of heavy braking. If you keep pace with the traffic and allow realistic following distances, you will eliminate a lot of unnecessary braking. That means better braking and longer brake life.

If your engine ever stops while you're driving, brake normally but don't pump your brakes. If you do, the pedal may get harder to push down. If your engine stops, you will still have some power brake assist. But you will use it when you brake. Once the power assist is used up, it may take longer to stop and the brake pedal will be harder to push.

Anti-Lock Brakes (Option)

Your vehicle may have anti-lock brakes (ABS). ABS is an advanced electronic braking system that will help prevent a braking skid.

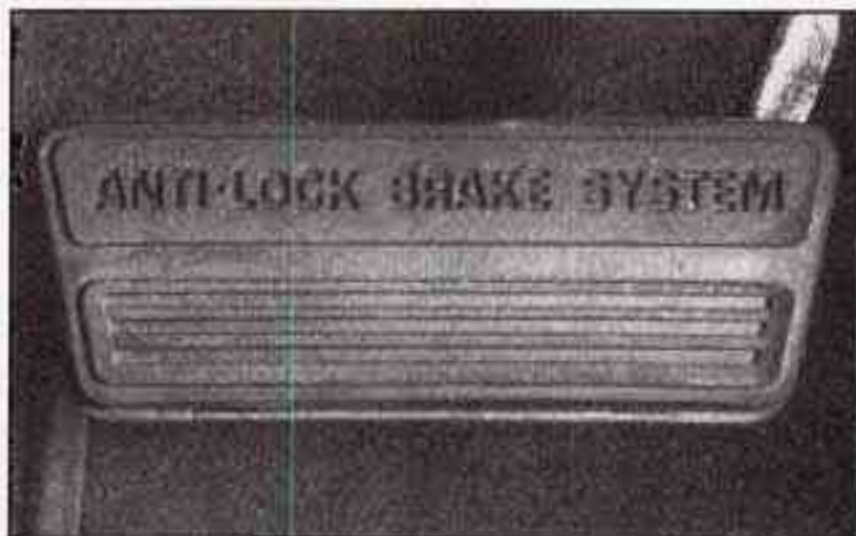

If your vehicle has anti-lock brakes, the brake pedal will say so.



And this warning light on the instrument panel will come on briefly when you start your vehicle.

When you start your engine, or when you begin to drive away, your anti-lock brake system will check itself. You may hear a momentary motor or clicking noise while this test is going on, and you may even notice that your brake pedal moves a little. This is normal.

If there's a problem with the anti-lock brake system, the anti-lock brake system warning light will stay on or flash. See "Anti-Lock Brake System Warning Light" in the Index.



Here's how anti-lock works. Let's say the road is wet. You're driving safely. Suddenly an animal jumps out in front of you.

You slam on the brakes. Here's what happens with ABS.

A computer senses that wheels are slowing down. If one of the wheels is about to stop rolling, the computer will separately work the brakes at each front wheel and at the rear wheels.

The anti-lock system can change the brake pressure faster than any driver could. The computer is programmed to make the most of available tire and road conditions.



You can steer around the obstacle while braking hard. As you brake, your computer keeps receiving updates on wheel speed and controls braking pressure accordingly.

Remember: Anti-lock doesn't change the time you need to get your foot up to the brake pedal or always decrease stopping distance. If you get too close to the vehicle in front of you, you won't have time to apply your brakes if that vehicle suddenly slows or stops. Always leave enough room up ahead to stop, even though you have anti-lock brakes.

Using Anti-Lock

Don't pump the brakes. Just hold the brake pedal down and let anti-lock work for you. You may feel the system working, or you may notice some noise, but this is normal.

LOW
TRAC

When your anti-lock system is adjusting brake pressure to help avoid a braking skid, this light will come on. See "Anti-Lock Brake System Active Light" in the Index.

Braking in Emergencies

At some time, nearly every driver gets into a situation that requires hard braking.

If you have anti-lock, you can steer and brake at the same time. However, if you don't have anti-lock, your first reaction -- to hit the brake pedal hard and hold it down -- may be the wrong thing to do. Your wheels can stop rolling. Once they do, the vehicle can't respond to your steering. Momentum will carry it in whatever direction it was headed when the wheels stopped rolling. That could be off the road, into the very thing you were trying to avoid, or into traffic.

If you don't have anti-lock, use a "squeeze" braking technique. This will give you maximum braking while maintaining steering control. You do this by pushing on the brake pedal with steadily increasing pressure.

In an emergency, you will probably want to squeeze the brakes hard without locking the wheels. If you hear or feel the wheels sliding, ease off the brake pedal. This will help you retain steering control. (If you *do* have anti-lock, it's different: see "Anti-Lock Brakes" in the Index.)

In many emergencies, steering can help you more than even the very best braking.

Steering

Power Steering

If you lose power steering assist because the engine stops or the system is not functioning, you can steer but it will take much more effort.

Variable Assist Steering

This steering system provides lighter steering effort for parking and when driving at low speeds. Steering effort will increase at higher speeds for improved road feel.

Steering Tips

Driving on Curves

It's important to take curves at a reasonable speed.

A lot of the "driver lost control" accidents mentioned on the news happen on curves. Here's why:

Experienced driver or beginner, each of us is subject to the same laws of physics when driving on curves. The traction of the tires against the road surface makes it possible for the vehicle to change its path when you turn the front wheels. If there's no traction, inertia will keep the vehicle going in the same direction. If you've ever tried to steer a vehicle on wet ice, you'll understand this.

The traction you can get in a curve depends on the condition of your tires and the road surface, the angle at which the curve is banked, and your speed. While you're in a curve, speed is the one factor you can control.

Suppose you're steering through a sharp curve. Then you suddenly apply the brakes. Both control systems -- steering and braking -- have to do their work where the tires meet the road. Unless you have four-wheel anti-lock brakes, adding the hard braking can demand too much of those places. You can lose control.

The same thing can happen if you're steering through a sharp curve and you suddenly accelerate. Those two control systems -- steering and acceleration -- can overwhelm those places where the tires meet the road and make you lose control.

What should you do if this ever happens? Ease up on the brake or accelerator pedal, steer the vehicle the way you want it to go, and slow down.

Speed limit signs near curves warn that you should adjust your speed. Of course, the posted speeds are based on good weather and road conditions. Under less favorable conditions you'll want to go slower.

If you need to reduce your speed as you approach a curve, do it before you enter the curve, while your front wheels are straight ahead.

Try to adjust your speed so you can "drive" through the curve. Maintain a reasonable, steady speed. Wait to accelerate until you are out of the curve, and then accelerate gently into the straightaway.

Steering in Emergencies

There are times when steering can be more effective than braking. For example, you come over a hill and find a truck stopped in your lane, or a car suddenly pulls out from nowhere, or a child darts out from between parked cars and stops right in front of you. You can avoid these problems by braking -- if you can stop in time. But sometimes you can't; there isn't room. That's the time for evasive action -- steering around the problem.

Your Pontiac can perform very well in emergencies like these. First apply your brakes -- but, unless you have anti-lock, not enough to lock your wheels. (See "Braking in Emergencies" earlier in this section.) It is better to remove as much speed as you can from a possible collision. Then steer around the problem, to the left or right depending on the space available.



An emergency like this requires close attention and a quick decision. If you are holding the steering wheel at the recommended 9 and 3 o'clock positions, you can turn it a full 180 degrees very quickly without removing either hand. But you have to act fast, steer quickly, and just as quickly straighten the wheel once you have avoided the object.

The fact that such emergency situations are always possible is a good reason to practice defensive driving at all times and wear safety belts properly.

Off-Road Recovery

You may find sometime that your right wheels have dropped off the edge of a road onto the shoulder while you're driving.

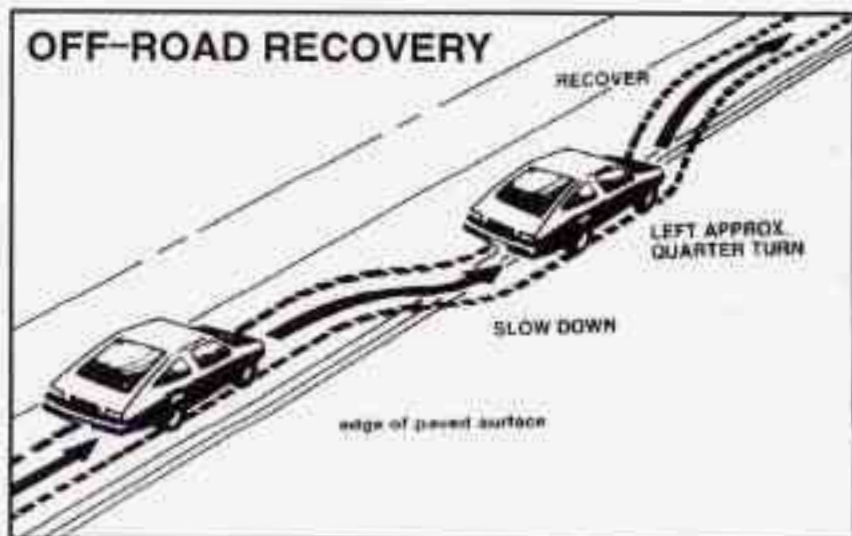

If the level of the shoulder is only slightly below the pavement, recovery should be fairly easy. Ease off the accelerator and then, if there is nothing in the way, steer so that your vehicle straddles the edge of the pavement. You can turn the steering wheel up to one-quarter turn until the right front tire contacts the pavement edge. Then turn your steering wheel to go straight down the roadway.

Passing

The driver of a vehicle about to pass another on a two-lane highway waits for just the right moment, *accelerates*, *moves* around the vehicle ahead, then goes back into the right lane again. A simple maneuver?

Not necessarily! Passing another vehicle on a two-lane highway is a potentially dangerous move, since the passing vehicle occupies the same lane as oncoming traffic for several seconds. A miscalculation, an error in judgment, or a brief surrender to frustration or anger can suddenly put the passing driver face to face with the worst of all traffic accidents -- the head-on collision.

So here are some tips for passing:

- "Drive ahead." Look down the road, to the sides and to crossroads for situations that might affect your passing patterns. If you have any doubt whatsoever about making a successful pass, wait for a better time.
- Watch for traffic signs, pavement markings and lines. If you can see a sign up ahead that might indicate a turn or an intersection, delay your pass. A broken center line usually indicates it's all right to pass (providing the road ahead is clear). Never cross a solid line on your side of the lane or a double solid line, even if the road seems empty of approaching traffic.

- Do not get too close to the vehicle you want to pass while you're awaiting an opportunity. For one thing, following too closely reduces your area of vision, especially if you're following a larger vehicle. Also, you won't have adequate space if the vehicle ahead suddenly slows or stops. Keep back a reasonable distance.
- When it looks like a chance to pass is coming up, start to accelerate but stay in the right lane and don't get too close. Time your move so you will be increasing speed as the time comes to move into the other lane. If the way is clear to pass, you will have a "running start" that more than makes up for the distance you would lose by dropping back. And if something happens to cause you to cancel your pass, you need only slow down and drop back again and wait for another opportunity.
- If other cars are lined up to pass a slow vehicle, wait your turn. But take care that someone isn't trying to pass you as you pull out to pass the slow vehicle. Remember to glance over your shoulder and check the blind spot.

- Check your mirrors, glance over your shoulder, and start your left lane change signal before moving out of the right lane to pass. When you are far enough ahead of the passed vehicle to see its front in your inside mirror, activate your right lane change signal and move back into the right lane. (Remember that your right outside mirror is convex. The vehicle you just passed may seem to be farther away from you than it really is.)
- Try not to pass more than one vehicle at a time on two-lane roads. Reconsider before passing the next vehicle.
- Don't overtake a slowly moving vehicle too rapidly. Even though the brake lamps are not flashing, it may be slowing down or starting to turn.
- If you're being passed, make it easy for the following driver to get ahead of you. Perhaps you can ease a little to the right.

Loss of Control

Let's review what driving experts say about what happens when the three control systems (brakes, steering and acceleration) don't have enough friction where the tires meet the road to do what the driver has asked.

In any emergency, don't give up. Keep trying to steer and constantly seek an escape route or area of less danger.

Skidding

In a skid, a driver can lose control of the vehicle. Defensive drivers avoid most skids by taking *reasonable* care suited to existing conditions, and by not "overdriving" those conditions. But skids are always possible.

The three types of skids correspond to your Pontiac's three control systems. In the braking skid, your wheels aren't rolling. In the steering or cornering skid, too much speed or steering in a curve causes tires to slip and lose cornering force. And in the acceleration skid, too much throttle causes the driving wheels to spin.

A cornering skid and an acceleration skid are best handled by easing your foot off the accelerator pedal.

If your vehicle starts to slide, ease your foot off the accelerator pedal and quickly steer the way you want the vehicle to go. If you start steering quickly enough, your vehicle may straighten out. Always be ready for a second skid if it occurs.

Of course, traction is reduced when water, snow, ice, gravel or other material is on the road. For safety, you'll want to slow down and adjust your driving to these conditions. It is important to slow down on slippery surfaces because stopping distance will be longer and vehicle control more limited.

While driving on a surface with reduced traction, try your best to avoid sudden steering, acceleration or braking (including engine braking by shifting to a lower gear). Any sudden changes could cause the tires to slide. You may not realize the surface is slippery until your vehicle is skidding. Learn to recognize warning clues -- such as enough water, ice or packed snow on the road to make a "mirrored surface" -- and slow down when you have any doubt.

If you have the anti-lock braking system, remember: It helps avoid only the braking skid. If you do not have anti-lock, then in a braking skid (where the wheels are no longer rolling), release enough pressure on the brakes to get the wheels rolling again. This restores steering control. Push the brake pedal down steadily when you have to stop suddenly. As long as the wheels are rolling, you will have steering control.

Driving at Night

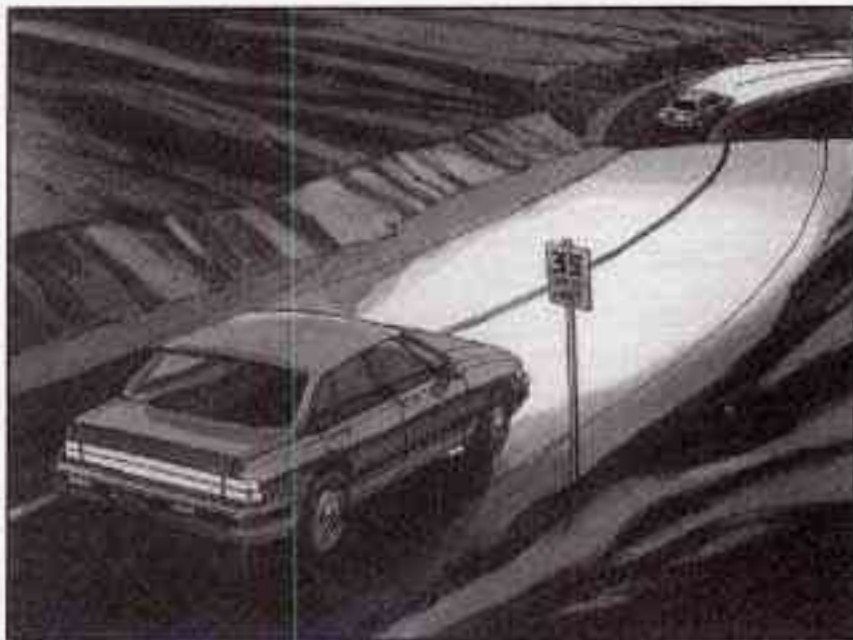

Night driving is more dangerous than day driving. One reason is that some drivers are likely to be impaired -- by alcohol or drugs, with night vision problems, or by fatigue.

Here are some tips on night driving:

- Drive defensively.
- Don't drink and drive.
- Adjust your inside rearview mirror to reduce the glare from headlamps behind you.
- Since you can't see as well, you may need to slow down and keep more space between you and other vehicles.
- Slow down, especially on higher speed roads. Your headlamps can light up only so much road ahead.
- In remote areas, watch for animals.
- If you're tired, pull off the road in a safe place and rest.

Night Vision

No one can see as well at night as in the daytime. But as we get older these differences increase. A 50-year-old driver may require at least twice as much light to see the same thing at night as a 20-year-old.

What you do in the daytime can also affect your night vision. For example, if you spend the day in bright sunshine you are wise to wear sunglasses. Your eyes will

have less trouble adjusting to night. But if you're driving, don't wear sunglasses at night. They may cut down on glare from headlamps, but they also make a lot of things invisible.

You can be temporarily blinded by approaching headlamps. It can take a second or two, or even several seconds, for your eyes to readjust to the dark. When you are faced with severe glare (as from a driver who doesn't lower the high beams, or a vehicle with misaimed headlamps), slow down a little. Avoid staring directly into the approaching headlamps.

Keep your windshield and all the glass on your vehicle clean -- inside and out. Glare at night is made much worse by dirt on the glass. Even the inside of the glass can build up a film caused by dust. Dirty glass makes lights dazzle and flash more than clean glass would, making the pupils of your eyes contract repeatedly.

Remember that your headlamps light up far less of a roadway when you are in a turn or curve. Keep your eyes moving; that way, it's easier to pick out dimly lighted objects. Just as your headlamps should be checked regularly for proper aim, so should your eyes be examined regularly. Some drivers suffer from night blindness -- the inability to see in dim light -- and aren't even aware of it.

Driving in Rain and on Wet Roads



Rain and wet roads can mean driving trouble. On a wet road, you can't stop, accelerate or turn as well because your tire-to-road traction isn't as good as on dry roads. And, if your tires don't have much tread left, you'll get even less traction. It's always wise to go slower and be cautious if rain starts to fall while you are driving. The surface may get wet suddenly when your reflexes are tuned for driving on dry pavement.

The heavier the rain, the harder it is to see. Even if your windshield wiper blades are in good shape, a heavy rain can make it harder to see road signs and traffic signals, pavement markings, the edge of the road and even people walking.

It's wise to keep your windshield wiping equipment in good shape and keep your windshield washer tank filled with washer fluid. Replace your windshield wiper inserts when they show signs of streaking or missing areas on the windshield, or when strips of rubber start to separate from the inserts.



 **CAUTION:**

Wet brakes can cause accidents. They won't work well in a quick stop and may cause pulling to one side. You could lose control of the vehicle.

After driving through a large puddle of water or a car wash, apply your brake pedal lightly until your brakes work normally.

Driving too fast through large water puddles or even going through some car washes can cause problems, too. The water may affect your brakes. Try to avoid puddles. But if you can't, try to slow down before you hit them.

Hydroplaning

Hydroplaning is dangerous. So much water can build up under your tires that they can actually ride on the water. This can happen if the road is wet enough and you're going fast enough. When your vehicle is hydroplaning, it has little or no contact with the road.

Hydroplaning doesn't happen often. But it can if your tires haven't much tread or if the pressure in one or more is low. It can happen if a lot of water is standing on the road. If you can see reflections from trees, telephone poles or other vehicles, and raindrops "dimple" the water's surface, there could be hydroplaning.

Hydroplaning usually happens at higher speeds. There just isn't a hard and fast rule about hydroplaning. The best advice is to slow down when it is raining.

Driving Through Deep Standing Water

NOTICE:

If you drive too quickly through deep puddles or standing water, water can come in through your engine's air intake and badly damage your engine. Never drive through water that is slightly lower than the underbody of your vehicle. If you can't avoid deep puddles or standing water, drive through them very slowly.

Some Other Rainy Weather Tips

- Turn on your low-beam headlights -- not just your parking lamps -- to help make you more visible to others.
- Besides slowing down, allow some extra following distance. And be especially careful when you pass another vehicle. Allow yourself more clear room ahead, and be prepared to have your view restricted by road spray.
- Have good tires with proper tread depth. (See "Tires" in the Index.)

City Driving



One of the biggest problems with city streets is the amount of traffic on them. You'll want to watch out for what the other drivers are doing and pay attention to traffic signals.

Here are ways to increase your safety in city driving:

- Know the best way to get to where you are going. Get a city map and plan your trip into an unknown part of the city just as you would for a cross-country trip.
- Try to use the freeways that rim and crisscross most large cities. You'll save time and energy. (See the next part, "Freeway Driving.")
- Treat a green light as a warning signal. A traffic light is there because the corner is busy enough to need it. When a light turns green, and just before you start to move, check both ways for vehicles that have not cleared the intersection or may be running the red light.

Freeway Driving

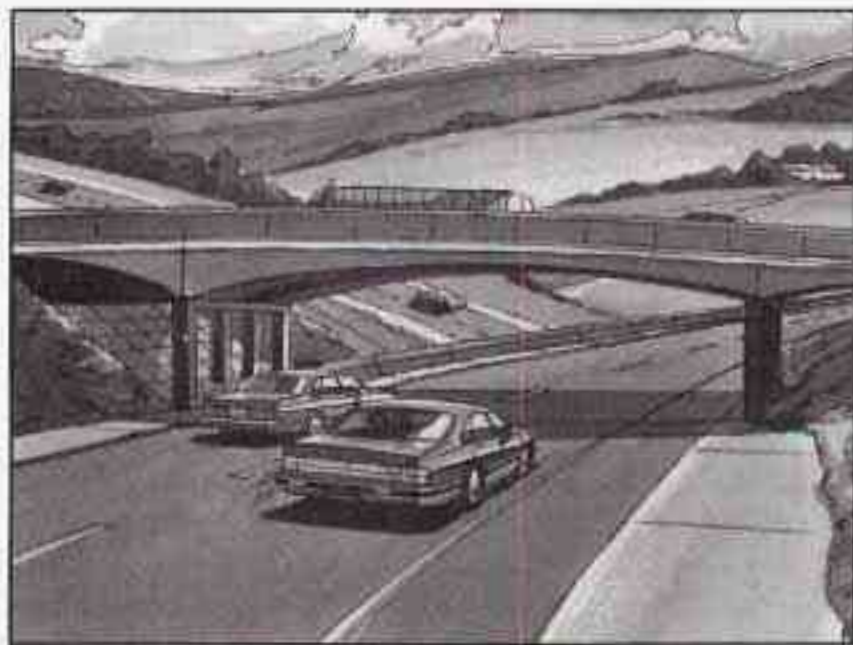

Mile for mile, freeways (also called thruways, parkways, expressways, turnpikes or superhighways) are the safest of all roads. But they have their own special rules.

The most important advice on freeway driving is: Keep up with traffic and keep to the right. Drive at the same speed most of the other drivers are driving. Too-fast or too-slow driving breaks a smooth traffic flow. Treat the left lane on a freeway as a passing lane.

At the entrance, there is usually a ramp that leads to the freeway. If you have a clear view of the freeway as you drive along the entrance ramp, you should begin to check traffic. Try to determine where you expect to blend with the flow. Try to merge into the gap at close to the prevailing speed. Switch on your turn signal, check your mirrors and glance over your shoulder as often as necessary. Try to blend smoothly with the traffic flow.

Once you are on the freeway, adjust your speed to the posted limit or to the prevailing rate if it's slower. Stay in the right lane unless you want to pass.

Before changing lanes, check your mirrors. Then use your turn signal.

Just before you leave the lane, glance quickly over your shoulder to make sure there isn't another vehicle in your "blind" spot.

Once you are moving on the freeway, make certain you allow a reasonable following distance. Expect to move slightly slower at night.

When you want to leave the freeway, move to the proper lane well in advance. If you miss your exit, do not, under any circumstances, stop and back up. Drive on to the next exit.

The exit ramp can be curved, sometimes quite sharply.

The exit speed is usually posted.

Reduce your speed according to your speedometer, not to your sense of motion. After driving for any distance at higher speeds, you may tend to think you are going slower than you actually are.

Before Leaving on a Long Trip

Make sure you're ready. Try to be well rested. If you must start when you're not fresh -- such as after a day's work -- don't plan to make too many miles that first part of the journey. Wear comfortable clothing and shoes you can easily drive in.

Is your vehicle ready for a long trip? If you keep it serviced and maintained, it's ready to go. If it needs service, have it done before starting out. Of course, you'll find experienced and able service experts in Pontiac dealerships all across North America. They'll be ready and willing to help if you need it.

Here are some things you can check before a trip:

- *Windshield Washer Fluid:* Is the reservoir full? Are all windows clean inside and outside?
- *Wiper Blades:* Are they in good shape?
- *Fuel, Engine Oil, Other Fluids:* Have you checked all levels?
- *Lamps:* Are they all working? Are the lenses clean?
- *Tires:* They are vitally important to a safe, trouble-free trip. Is the tread good enough for long-distance driving? Are the tires all inflated to the recommended pressure?
- *Weather Forecasts:* What's the weather outlook along your route? Should you delay your trip a short time to avoid a major storm system?
- *Maps:* Do you have up-to-date maps?

Highway Hypnosis

Is there actually such a condition as “highway hypnosis”? Or is it just plain falling asleep at the wheel? Call it highway hypnosis, lack of awareness, or whatever.

There is something about an easy stretch of road with the same scenery, along with the hum of the tires on the road, the drone of the engine, and the rush of the wind against the vehicle that can make you sleepy. Don't let it happen to you! If it does, your vehicle can leave the road in *less than a second*, and you could crash and be injured.

What can you do about highway hypnosis? First, be aware that it can happen.

Then here are some tips:

- Make sure your vehicle is well ventilated, with a comfortably cool interior.
- Keep your eyes moving. Scan the road ahead and to the sides. Check your rearview mirrors and your instruments frequently.
- If you get sleepy, pull off the road into a rest, service or parking area and take a nap, get some exercise, or both. For safety, treat drowsiness on the highway as an emergency.

Hill and Mountain Roads



Driving on steep hills or mountains is different from driving in flat or rolling terrain.

If you drive regularly in steep country, or if you're planning to visit there, here are some tips that can make your trips safer and more enjoyable.

- Keep your vehicle in good shape. Check all fluid levels and also the brakes, tires, cooling system and transaxle. These parts can work hard on mountain roads.
- Know how to go down hills. The most important thing to know is this: let your engine do some of the slowing down. Shift to a lower gear when you go down a steep or long hill.

 **CAUTION:**

If you don't shift down, your brakes could get so hot that they wouldn't work well. You would then have poor braking or even none going down a hill. You could crash. Shift down to let your engine assist your brakes on a steep downhill slope.

 **CAUTION:**

Coasting downhill in NEUTRAL (N) or with the ignition off is dangerous. Your brakes will have to do all the work of slowing down. They could get so hot that they wouldn't work well. You would then have poor braking or even none going down a hill. You could crash. Always have your engine running and your vehicle in gear when you go downhill.

- Know how to go uphill. You may want to shift down to a lower gear. The lower gears help cool your engine and transaxle, and you can climb the hill better.
- Stay in your own lane when driving on two-lane roads in hills or mountains. Don't swing wide or cut across the center of the road. Drive at speeds that let you stay in your own lane.
- As you go over the top of a hill, be alert. There could be something in your lane, like a stalled car or an accident.
- You may see highway signs on mountains that warn of special problems. Examples are long grades, passing or no-passing zones, a falling rocks area or winding roads. Be alert to these and take appropriate action.

Winter Driving

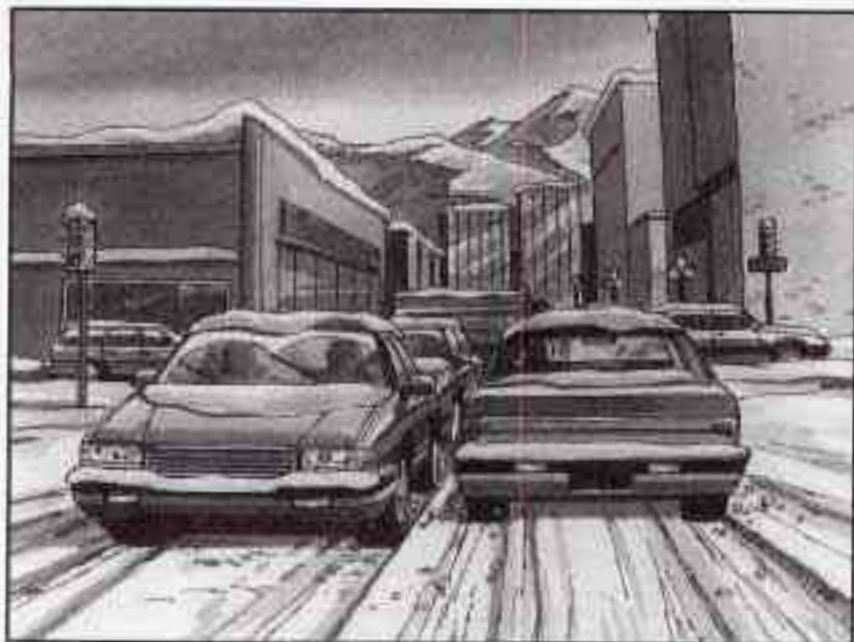

Here are some tips for winter driving:

- Have your Pontiac in good shape for winter.
- You may want to put winter emergency supplies in your trunk.

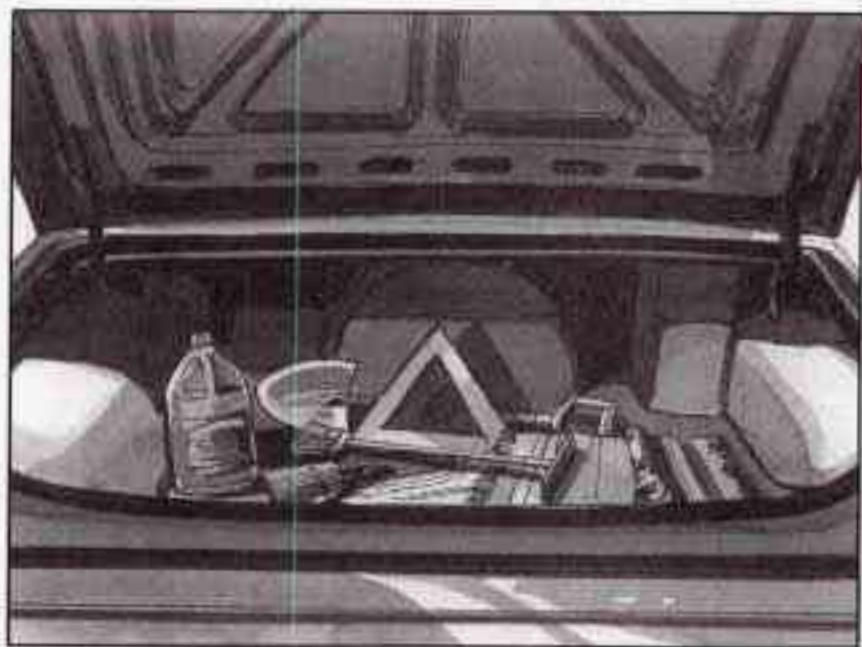

Include an ice scraper, a small brush or broom, a supply of windshield washer fluid, a rag, some winter outer clothing, a small shovel, a flashlight, a red cloth and a couple of reflective warning triangles. And, if you will be driving under severe conditions, include a small bag of sand, a piece of old carpet or a couple of burlap bags to help provide traction. Be sure you properly secure these items in your vehicle.

Driving on Snow or Ice

Most of the time, those places where your tires meet the road probably have good traction.

However, if there is snow or ice between your tires and the road, you can have a very slippery situation. You'll have a lot less traction or "grip" and will need to be very careful.



What's the worst time for this? "Wet ice." Very cold snow or ice can be slick and hard to drive on. But wet ice can be even more trouble because it may offer the least traction of all. You can get wet ice when it's about freezing (32°F; 0°C) and freezing rain begins to fall. Try to avoid driving on wet ice until salt and sand crews can get there.

Whatever the condition -- smooth ice, packed, blowing or loose snow -- drive with caution. Accelerate gently. Try not to break the fragile traction. If you accelerate too fast, the drive wheels will spin and polish the surface under the tires even more.

Unless you have the anti-lock braking system, you'll want to brake very gently, too. (If you do have anti-lock, see "Anti-Lock" in the Index. This system improves your vehicle's stability when you make a hard stop on a slippery road.) Whether you have the anti-lock braking system or not, you'll want to begin stopping sooner than you would on dry pavement. Without anti-lock brakes, if you feel your vehicle begin to slide, let up on the brakes a little. Push the brake pedal down steadily to get the most traction you can.

Remember, unless you have anti-lock, if you brake so hard that your wheels stop rolling, you'll just slide. Brake so your wheels always keep rolling and you can still steer.

- Whatever your braking system, allow greater following distance on any slippery road.
- Watch for slippery spots. The road might be fine until you hit a spot that's covered with ice. On an otherwise clear road, ice patches may appear in shaded areas where the sun can't reach: around clumps of trees, behind buildings or under bridges. Sometimes the surface of a curve or an overpass may remain icy when the surrounding roads are clear. If you see a patch of ice ahead of you, brake before you are on it. Try not to brake while you're actually on the ice, and avoid sudden steering maneuvers.

If You're Caught in a Blizzard

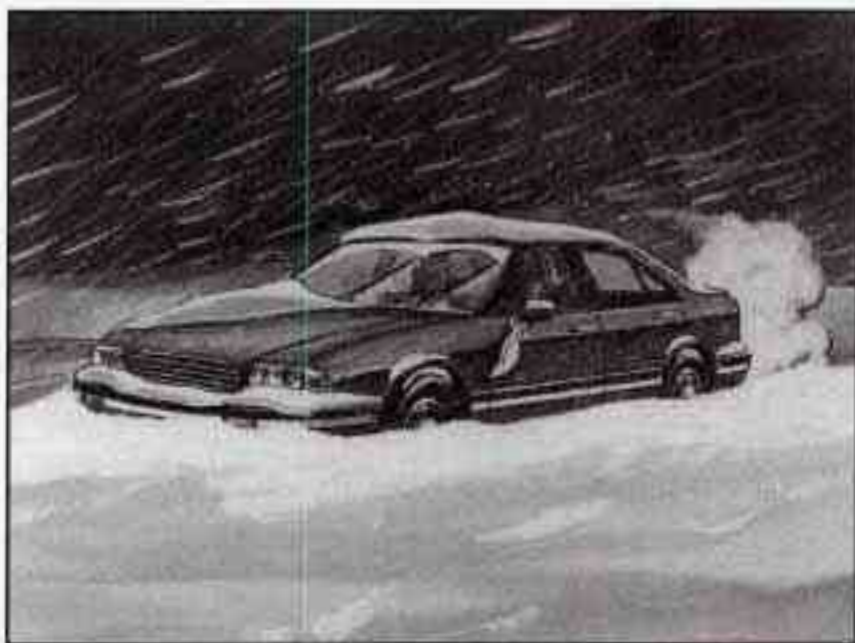

If you are stopped by heavy snow, you could be in a serious situation. You should probably stay with your vehicle unless you know for sure that you are near help and you can hike through the snow. Here are some things to do to summon help and keep yourself and your passengers safe:

- Turn on your hazard flashers.

- Tie a red cloth to your vehicle to alert police that you've been stopped by the snow.
- Put on extra clothing or wrap a blanket around you. If you have no blankets or extra clothing, make body insulators from newspapers, burlap bags, rags, floor mats -- anything you can wrap around yourself or tuck under your clothing to keep warm.



You can run the engine to keep warm, but be careful.

⚠ CAUTION:

Snow can trap exhaust gases under your vehicle. This can cause deadly CO (carbon monoxide) gas to get inside. CO could overcome you and kill you. You can't see it or smell it, so you might not know it is in your vehicle. Clear away snow from around the base of your vehicle, especially any that is blocking your exhaust pipe. And check around again from time to time to be sure snow doesn't collect there.

Open a window just a little on the side of the vehicle that's away from the wind. This will help keep CO out.

Run your engine only as long as you must. This saves fuel. When you run the engine, make it go a little faster than just idle. That is, push the accelerator slightly. This uses less fuel for the heat that you get and it keeps the battery charged. You will need a well-charged battery to restart the vehicle, and possibly for signaling later on with your headlamps. Let the heater run for awhile.

Then, shut the engine off and close the window almost all the way to preserve the heat. Start the engine again and repeat this only when you feel really uncomfortable from the cold. But do it as little as possible. Preserve the fuel as long as you can. To help keep warm, you can get out of the vehicle and do some fairly vigorous exercises every half hour or so until help comes.

Loading Your Vehicle



TIRE-LOADING INFORMATION				
OCCUPANTS			VEHICLE CAP. WT.	
FRT.	CTR.	RR.	TOTAL LBS.	KG
MAX. LOADING & GVWR SAME AS VEHICLE				
CAPACITY WEIGHT		XXX	COLD TIRE	
TIRE SIZE		SPEED	PRESSURE	
		RTG	PSI/KPa	
FRT.				
RR.				
SPA.				
IF TIRES ARE HOT, ADD 4PSI/28KPa				
SEE OWNER'S MANUAL FOR ADDITIONAL INFORMATION				

Two labels on your vehicle show how much weight it may properly carry. The Tire-Loading Information label is on the inside of the trunk lid. The label tells you the proper size, speed rating and recommended inflation pressures for the tires on your vehicle. It also gives you important information about the number of people that can be in your vehicle and the total weight you can carry. This weight is called the vehicle capacity weight and includes the weight of all occupants, cargo and all nonfactory-installed options.



MFD BY GENERAL MOTORS CORP
DATE GVWR GAWR FRT GAWR RR

THIS VEHICLE CONFORMS TO ALL APPLICABLE U.S. FEDERAL MOTOR VEHICLE SAFETY, BUMPER, AND THEFT PREVENTION STANDARDS IN EFFECT ON THE DATE OF MANUFACTURE SHOWN ABOVE.

The other label is the Certification label, found on the rear edge of the driver's door. It tells you the gross weight capacity of your vehicle, called the GVWR (Gross Vehicle Weight Rating). The GVWR includes the weight of the vehicle, all occupants, fuel and cargo. Never exceed the GVWR for your vehicle or the Gross Axle Weight Rating (GAWR) for either the front or rear axle.

If you do have a heavy load, spread it out. Don't carry more than 167 lbs. (75 kg) in your trunk.



CAUTION:

Do not load your vehicle any heavier than the GVWR, or either the maximum front or rear GAWR. If you do, parts on your vehicle can break, or it can change the way your vehicle handles. These could cause you to lose control. Also, overloading can shorten the life of your vehicle.

NOTICE:

Your warranty does not cover parts or components that fail because of overloading.

If you put things inside your vehicle -- like suitcases, tools, packages or anything else -- they will go as fast as

the vehicle goes. If you have to stop or turn quickly, or if there is a crash, they'll keep going.

CAUTION:

Things you put inside your vehicle can strike and injure people in a sudden stop or turn, or in a crash.

- Put things in the trunk of your vehicle. In a trunk, put them as far forward as you can. Try to spread the weight evenly.
- Never stack heavier things, like suitcases, inside the vehicle so that some of them are above the tops of the seats.
- Don't leave an unsecured child restraint in your vehicle.
- When you carry something inside the vehicle, secure it whenever you can.

Towing a Trailer

CAUTION:

If you don't use the correct equipment and drive properly, you can lose control when you pull a trailer. For example, if the trailer is too heavy, the brakes may not work well -- or even at all. You and your passengers could be seriously injured. Pull a trailer only if you have followed all the steps in this section. Ask your Pontiac dealer for advice and information about towing a trailer with your vehicle.

NOTICE:

Pulling a trailer improperly can damage your vehicle and result in costly repairs not covered by your warranty. To pull a trailer correctly, follow the advice in this part, and see your Pontiac dealer for important information about towing a trailer with your vehicle.

Your vehicle can tow a trailer. To identify what the vehicle trailering capacity is for your vehicle, you should read the information in “Weight of the Trailer” that appears later in this section. But trailering is different than just driving your vehicle by itself. Trailering means changes in handling, durability, and fuel economy. Successful, safe trailering takes correct equipment, and it has to be used properly.

That’s the reason for this part. In it are many time-tested, important trailering tips and safety rules. Many of these are important for your safety and that of your passengers. So please read this section carefully before you pull a trailer.

Load-pulling components such as the engine, transaxle, wheel assemblies and tires are forced to work harder against the drag of the added weight. The engine is required to operate at relatively higher speeds and under greater loads, generating extra heat. What’s more, the trailer adds considerably to wind resistance, increasing the pulling requirements.

If You Do Decide To Pull A Trailer

If you do, here are some important points:

- There are many different laws, including speed limit restrictions, having to do with trailering. Make sure your rig will be legal, not only where you live but also where you’ll be driving. A good source for this information can be state or provincial police.
- Consider using a sway control. You can ask a hitch dealer about sway controls.
- Don’t tow a trailer at all during the first 1,000 miles (1 600 km) your new vehicle is driven. Your engine, axle or other parts could be damaged.
- Then, during the first 500 miles (800 km) that you tow a trailer, don’t drive over 50 mph (80 km/h) and don’t make starts at full throttle. This helps your engine and other parts of your vehicle wear in at the heavier loads.
- Obey speed limit restrictions when towing a trailer. Don’t drive faster than the maximum posted speed for trailers (or no more than 55 mph (90 km/h)) to save wear on your vehicle’s parts.

Three important considerations have to do with weight:

- the weight of the trailer,
- the weight of the trailer tongue
- and the total weight on your vehicle’s tires.

Weight of the Trailer

How heavy can a trailer safely be?

It *should never* weigh more than 1,000 lbs. (450 kg). But even that can be too heavy.

It depends on how you plan to use your rig. For example, speed, altitude, road grades, outside temperature and how much your vehicle is used to pull a trailer are all important. And, it can also depend on any special equipment that you have on your vehicle.

You can ask your dealer for our trailering information or advice, or you can write us at:

Customer Assistance Center
Pontiac Division
One Pontiac Plaza
Pontiac, MI 48340-2952

In Canada, write to:

General Motors of Canada Limited
Customer Assistance Center
1908 Colonel Sam Drive
Oshawa, Ontario L1H 8P7

Weight of the Trailer Tongue

The tongue load (A) of any trailer is an important weight to measure because it affects the total capacity weight of your vehicle. The capacity weight includes the curb weight of the vehicle, any cargo you may carry in it, and the people who will be riding in the vehicle. And if you will tow a trailer, you must subtract the tongue load from your vehicle's capacity weight because your vehicle will be carrying that weight, too. See "Loading Your Vehicle" in the Index for more information about your vehicle's maximum load capacity.

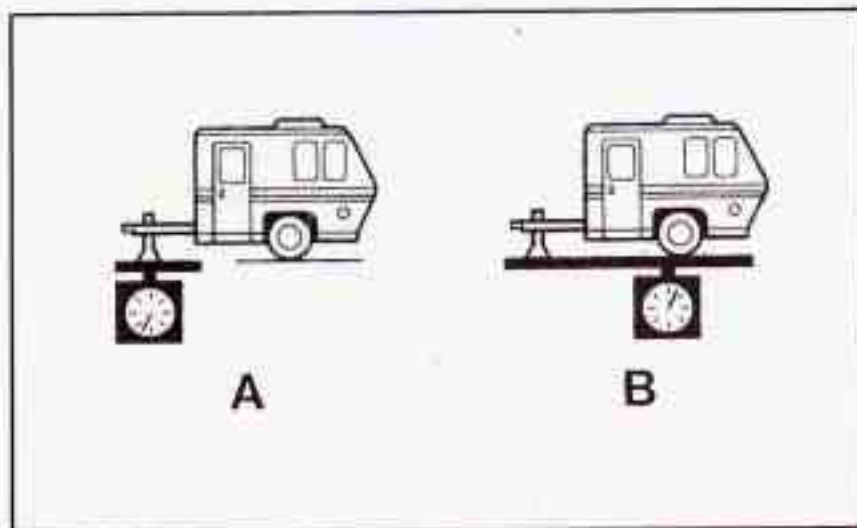

If you're using a weight-carrying hitch, the trailer tongue (A) should weigh 10% of the total loaded trailer weight (B). If you have a weight-distributing hitch, the trailer tongue (A) should weigh 12% of the total loaded trailer weight (B).

After you've loaded your trailer, weigh the trailer and then the tongue, separately, to see if the weights are proper. If they aren't, you may be able to get them right simply by moving some items around in the trailer.

Total Weight on Your Vehicle's Tires

Be sure your vehicle's tires are inflated to the recommended pressure for cold tires. You'll find these numbers on the Tire-Loading Information label (found on the inside of the trunk lid) or see "Loading Your Vehicle" in the Index. Then be sure you don't go over the GVW limit for your vehicle, including the weight of the trailer tongue.

Hitches

It's important to have the correct hitch equipment. Crosswinds, large trucks going by and rough roads are a few reasons why you'll need the right hitch. Here are some rules to follow:

- Will you have to make any holes in the body of your vehicle when you install a trailer hitch? If you do, then be sure to seal the holes later when you remove the hitch. If you don't seal them, deadly carbon monoxide (CO) from your exhaust can get into your vehicle (see "Carbon Monoxide" in the Index). Dirt and water can, too.
- The bumpers on your vehicle are not intended for hitches. Do not attach rental hitches or other bumper-type hitches to them. Use only a frame-mounted hitch that does not attach to the bumper.

Safety Chains

You should always attach chains between your vehicle and your trailer. Cross the safety chains under the tongue of the trailer so that the tongue will not drop to the road if it becomes separated from the hitch. Instructions about safety chains may be provided by the hitch manufacturer or by the trailer manufacturer. Follow the manufacturer's recommendation for attaching safety chains and do not attach them to the bumper. Always leave just enough slack so you can turn with your rig. And, never allow safety chains to drag on the ground.

Trailer Brakes

Does your trailer have its own brakes? Be sure to read and follow the instructions for the trailer brakes so you'll be able to install, adjust and maintain them properly.

- If your vehicle has anti-lock brakes, do not try to tap into your vehicle's brake system. If you do, both brake systems won't work well, or at all.
- Even if your vehicle doesn't have anti-lock brakes, don't tap into your vehicle's brake system if the trailer's brake system will use more than 0.02 cubic inch (0.3 cc) of fluid from your vehicle's master cylinder. If it does, both braking systems won't work well. You could even lose your brakes.

- Will the trailer brake parts take 3,000 psi (20 650 kPa) of pressure? If not, the trailer-brake system must not be used with your vehicle.
- If everything checks out this far, then make the brake fluid tap at the upper rear master cylinder port. But don't use copper tubing for this. If you do, it will bend and break off. Use steel brake tubing.

Driving with a Trailer

Towing a trailer requires a certain amount of experience. Before setting out for the open road, you'll want to get to know your rig. Acquaint yourself with the feel of handling and braking with the added weight of the trailer. And always keep in mind that the vehicle you are driving is now a good deal longer and not nearly as responsive as your vehicle is by itself.

Before you start, check the trailer hitch and platform (and attachments), safety chains, electrical connector, lamps, tires and mirror adjustment. If the trailer has electric brakes, start your vehicle and trailer moving and then apply the trailer brake controller by hand to be sure the brakes are working. This lets you check your electrical connection at the same time.

During your trip, check occasionally to be sure that the load is secure, and that the lamps and any trailer brakes are still working.

Following Distance

Stay at least twice as far behind the vehicle ahead as you would when driving your vehicle without a trailer. This can help you avoid situations that require heavy braking and sudden turns.

Passing

You'll need more passing distance up ahead when you're towing a trailer. And, because you're a good deal longer, you'll need to go much farther beyond the passed vehicle before you can return to your lane.

Backing Up

Hold the bottom of the steering wheel with one hand. Then, to move the trailer to the left, just move that hand to the left. To move the trailer to the right, move your hand to the right. Always back up slowly and, if possible, have someone guide you.

Making Turns

NOTICE:

Making very sharp turns while trailering could cause the trailer to come in contact with the vehicle. Your vehicle could be damaged. Avoid making very sharp turns while trailering.

When you're turning with a trailer, make wider turns than normal. Do this so your trailer won't strike soft shoulders, curbs, road signs, trees or other objects. Avoid jerky or sudden maneuvers. Signal well in advance.

Turn Signals When Towing a Trailer

When you tow a trailer, your vehicle may need a different turn signal flasher and/or extra wiring. Check with your Pontiac dealer. The green arrows on your instrument panel will flash whenever you signal a turn or lane change. Properly hooked up, the trailer lamps will also flash, telling other drivers you're about to turn, change lanes or stop.

When towing a trailer, the green arrows on your instrument panel will flash for turns even if the bulbs on the trailer are burned out. Thus, you may think drivers behind you are seeing your signal when they are not. It's important to check occasionally to be sure the trailer bulbs are still working.

Your vehicle has bulb warning lights. When you plug a trailer lighting system into your vehicle's lighting system, its bulb warning lights may not let you know if one of your lamps goes out. So, when you have a trailer lighting system plugged in, be sure to check your vehicle and trailer lamps from time to time to be sure they're all working. Once you disconnect the trailer lamps, the bulb warning lights again can tell you if one of your vehicle lamps is out.

Driving On Grades

Reduce speed and shift to a lower gear *before* you start down a long or steep downgrade. If you don't shift down, you might have to use your brakes so much that they would get hot and no longer work well.

On a long uphill grade, shift down and reduce your speed to around 45 mph (70 km/h) to reduce the possibility of engine and transaxle overheating.

If you have overdrive, you may want to drive in THIRD (3), instead of DRIVE (D).

Parking on Hills

You really should not park your vehicle, with a trailer attached, on a hill. If something goes wrong, your rig could start to move. People can be injured, and both your vehicle and the trailer can be damaged.

But if you ever have to park your rig on a hill, here's how to do it:

1. Apply your regular brakes, but don't shift into PARK (P) yet.
2. Have someone place chocks under the trailer wheels.
3. When the wheel chocks are in place, release the regular brakes until the chocks absorb the load.
4. Reapply the regular brakes. Then apply your parking brake, and then shift to PARK (P).
5. Release the regular brakes.

When You Are Ready to Leave After Parking on a Hill

1. Apply your regular brakes and hold the pedal down while you:
 - Start your engine;
 - Shift into a gear; and
 - Release the parking brake.
2. Let up on the brake pedal.
3. Drive slowly until the trailer is clear of the chocks.
4. Stop and have someone pick up and store the chocks.

Maintenance When Trailer Towing

Your vehicle will need service more often when you're pulling a trailer. See the Maintenance Schedule for more on this. Things that are especially important in trailer operation are automatic transaxle fluid (don't overfill), engine oil, belt, cooling system and brake adjustment. Each of these is covered in this manual, and the Index will help you find them quickly. If you're trailering, it's a good idea to review these sections before you start your trip.

Check periodically to see that all hitch nuts and bolts are tight.

NOTES



Section 5 Problems on the Road

Here you'll find what to do about some problems that can occur on the road.

Hazard Warning Flashers

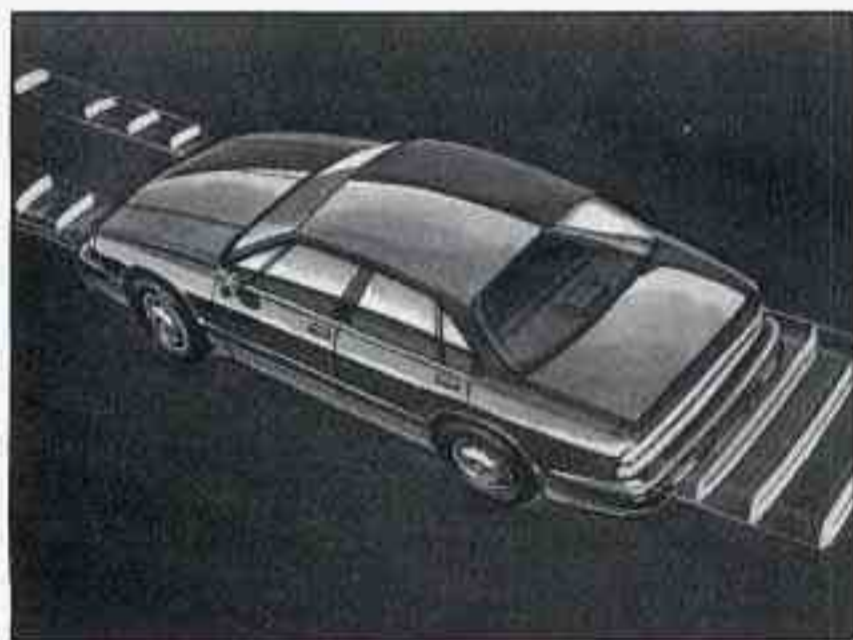

Your hazard warning flashers let you warn others. They also let police know you have a problem. Your front and rear turn signal lamps will flash on and off.



Press the switch to make your front and rear turn signal lamps flash on and off. Your hazard warning flashers work no matter what position your key is in, and even if the key isn't in.

To turn off the flashers, press the switch again. When the hazard warning flashers are on, your turn signals won't work.

Other Warning Devices

If you carry reflective triangles, you can set one up at the side of the road about 300 feet (100 m) behind your vehicle.

Jump Starting

If your battery has run down, you may want to use another vehicle and some jumper cables to start your Pontiac. But please follow the steps below to do it safely.

CAUTION:

Batteries can hurt you. They can be dangerous because:

- They contain acid that can burn you.
- They contain gas that can explode or ignite.
- They contain enough electricity to burn you.

If you don't follow these steps exactly, some or all of these things can hurt you.

NOTICE:

Ignoring these steps could result in costly damage to your vehicle that wouldn't be covered by your warranty. Trying to start your Pontiac by pushing or pulling won't work, and it could damage your vehicle.

1. Check the other vehicle. It must have a 12-volt battery with a negative ground system.

NOTICE:

If the other system isn't a 12-volt system with a negative ground, both vehicles can be damaged.

2. Get the vehicles close enough so the jumper cables can reach, but be sure the vehicles aren't touching each other. If they are, it could cause a ground connection you don't want. You wouldn't be able to start your Pontiac, and the bad grounding could damage the electrical systems.

You could be injured if the vehicles roll. Set the parking brake firmly on each vehicle. Put an automatic transaxle in PARK (P) or a manual transaxle in NEUTRAL (N).

3. Turn off the ignition on both vehicles. Turn off all lamps that aren't needed, and radios. This will avoid sparks and help save both batteries. And it could save your radio!

NOTICE:

If you leave your radio on, it could be badly damaged. The repairs wouldn't be covered by your warranty.



CAUTION:

An electric fan can start up even when the engine is not running and can injure you. Keep hands, clothing and tools away from any underhood electric fan.

4. Find the positive (+) and negative (-) terminals on each battery. Your Pontiac has a remote positive (+) jump starting terminal. The terminal is on the same side of the engine compartment as your battery. You should always use the remote positive (+) terminal instead of the positive (+) terminal on your battery. To uncover the remote positive (+) terminal, lift the red plastic cap.

 **CAUTION:**

Using a match near a battery can cause battery gas to explode. People have been hurt doing this, and some have been blinded. Use a flashlight if you need more light.

Be sure the battery has enough water. You don't need to add water to the Delco Freedom[®] battery installed in every new GM vehicle. But if a battery has filler caps, be sure the right amount of fluid is there. If it is low, add water to take care of that first. If you don't, explosive gas could be present.

Battery fluid contains acid that can burn you. Don't get it on you. If you accidentally get it in your eyes or on your skin, flush the place with water and get medical help immediately.

5. Check that the jumper cables don't have loose or missing insulation. If they do, you could get a shock. The vehicles could be damaged, too.

Before you connect the cables, here are some basic things you should know. Positive (+) will go to positive (+) and negative (-) will go to negative (-) or a metal engine part. Don't connect positive (+) to negative (-), or you'll get a short that would damage the battery and maybe other parts too.

 **CAUTION:**

Fans or other moving engine parts can injure you badly. Keep your hands away from moving parts once the engines are running.



6. Connect the red positive (+) cable to the positive (+) terminal of the vehicle with the dead battery. Use a remote positive (+) terminal if the vehicle has one.



7. Don't let the other end touch metal. Connect it to the positive (+) terminal of the good battery. Use a remote positive (+) terminal if the vehicle has one.



8. Now connect the black negative (-) cable to the good battery's negative (-) terminal. Don't let the other end touch anything until the next step. The other end of the negative (-) cable *doesn't* go to the dead battery.

It goes to a heavy, unpainted, metal part on the engine of the vehicle with the dead battery.

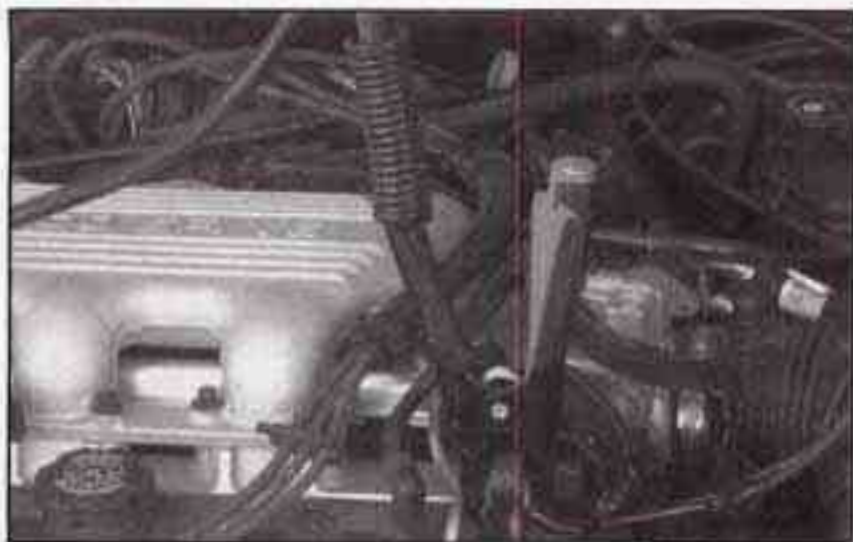

9. Attach the cable at least 18 inches (45 cm) away from the dead battery, but not near engine parts that move. The electrical connection is just as good there, but the chance of sparks getting back to the battery is much less.
10. Now start the vehicle with the good battery and run the engine for a while.
11. Try to start the vehicle with the dead battery. If it won't start after a few tries, it probably needs service.

12. Remove the cables in reverse order to prevent electrical shorting. Take care that they don't touch each other or any other metal.

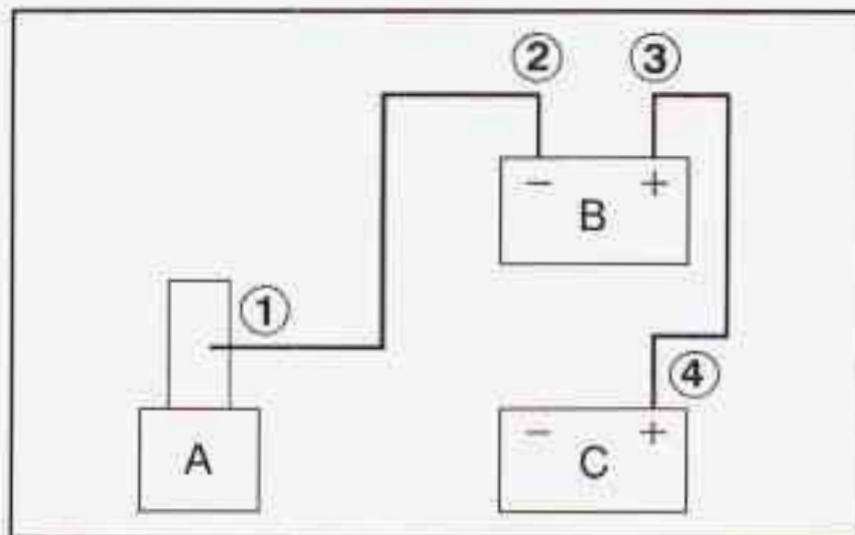

- A. Heavy Metal Engine Part
B. Good Battery
C. Dead Battery

Towing Your Vehicle

Try to have a Pontiac dealer or a professional towing service tow your Grand Prix. See "Roadside Assistance" in the Index.

If your vehicle has been changed or modified since it was factory-new by adding aftermarket items like fog lamps, aero skirting, or special tires and wheels, these instructions and illustrations may not be correct.

Before you do anything, turn on the hazard warning flashers.

When you call, tell the towing service:

- That your vehicle cannot be towed from the front with sling type equipment.
- That your vehicle has front-wheel drive.
- The make, model and year of your vehicle.
- Whether you can still move the shift lever.
- If there was an accident, what was damaged.

When the towing service arrives, let the tow operator know that this manual contains detailed towing instructions and illustrations. The operator may want to see them.

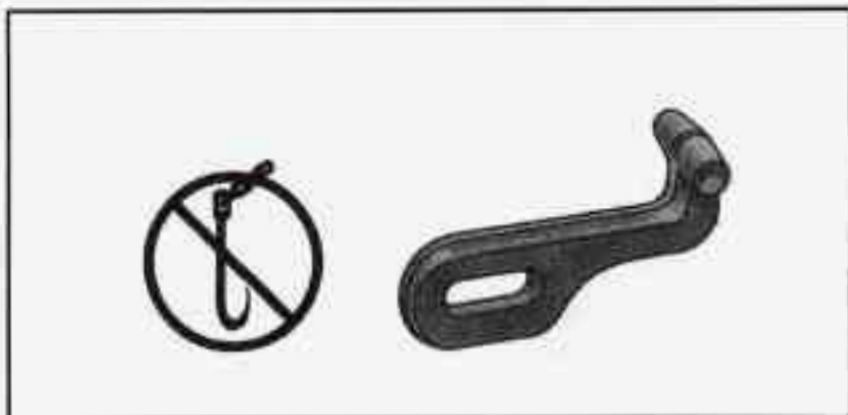

CAUTION:

To help avoid injury to you or others:

- Never let passengers ride in a vehicle that is being towed.
- Never tow faster than safe or posted speeds.
- Never tow with damaged parts not fully secured.
- Never get under your vehicle after it has been lifted by the tow truck.
- Always secure the vehicle on each side with separate safety chains when towing it.
- Never use J-hooks. Use T-hooks instead.

 **CAUTION:**

A vehicle can fall from a car carrier if it isn't adequately secured. This can cause a collision, serious personal injury and vehicle damage. The vehicle should be tightly secured with chains or steel cables before it is transported.

Don't use substitutes (ropes, leather straps, canvas webbing, etc.) that can be cut by sharp edges underneath the towed vehicle. Always use T-hooks inserted in the T-hook slots. Never use J-hooks. They will damage drivetrain and suspension components.

When your vehicle is being towed, have the ignition turned to the OFF position. The steering wheel should be clamped in a straight-ahead position, with a clamping device designed for towing service. Do not use the vehicle's steering column lock for this. The transaxle should be in NEUTRAL (N) and the parking brake released.

Don't have your vehicle towed on the drive wheels, unless you must. If the vehicle must be towed on the drive wheels, be sure to follow the speed and distance restrictions later in this section or your transaxle will be damaged. If these limitations must be exceeded, then the drive wheels have to be supported on a dolly.

Front Towing

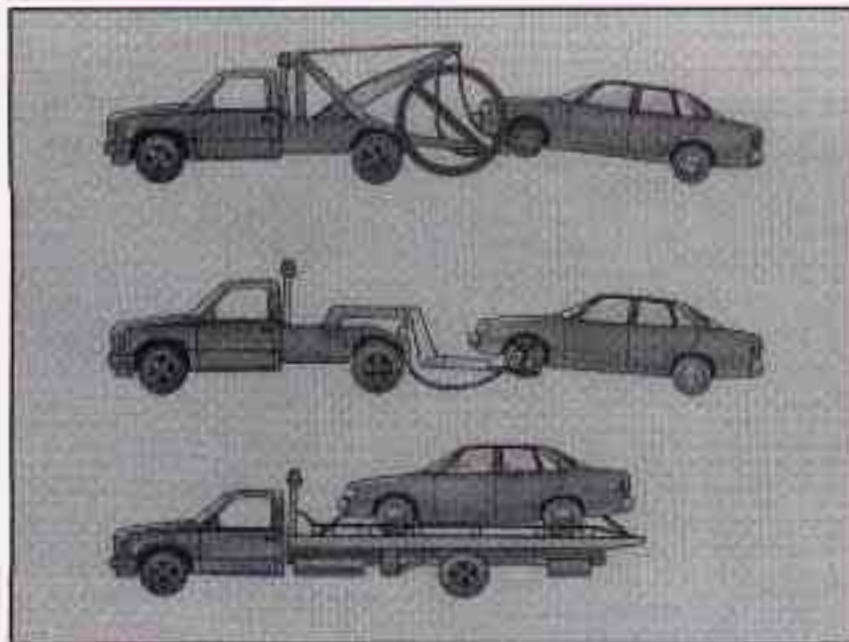

NOTICE:

Do not tow with sling-type equipment or fascia/fog lamp damage will occur. Use wheel-lift or car carrier equipment. Additional ramping may be required for car carrier equipment. Use safety chains and wheel straps.

Towing a vehicle over rough surfaces could damage a vehicle. Damage can occur from vehicle to ground or vehicle to wheel-lift equipment. To help avoid damage, raise the vehicle until adequate clearance is obtained between the ground and/or wheel-lift equipment. Do not attach winch cables or J-hooks to suspension components when using car carrier equipment. Always use T-hooks inserted in the T-hook slots.

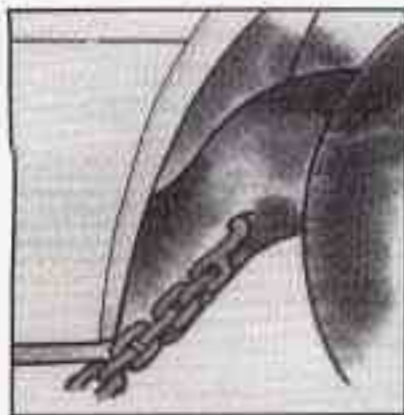

Attach T-hook chains on both sides, in the slotted holes in the bottom of the cradle, behind the front wheels.

These slots are to be used when loading and securing to car carrier equipment.

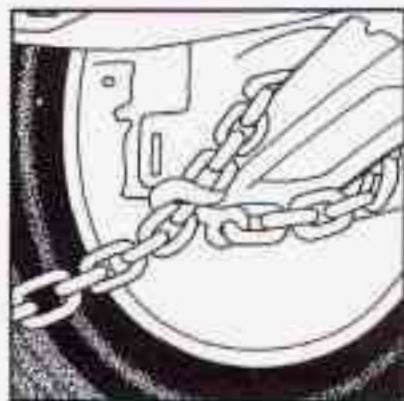

Attach a separate safety chain around the outboard end of each lower control arm.

Rear Towing

Tow limits -- 35 mph (56 km/h), 50 miles (80 km)

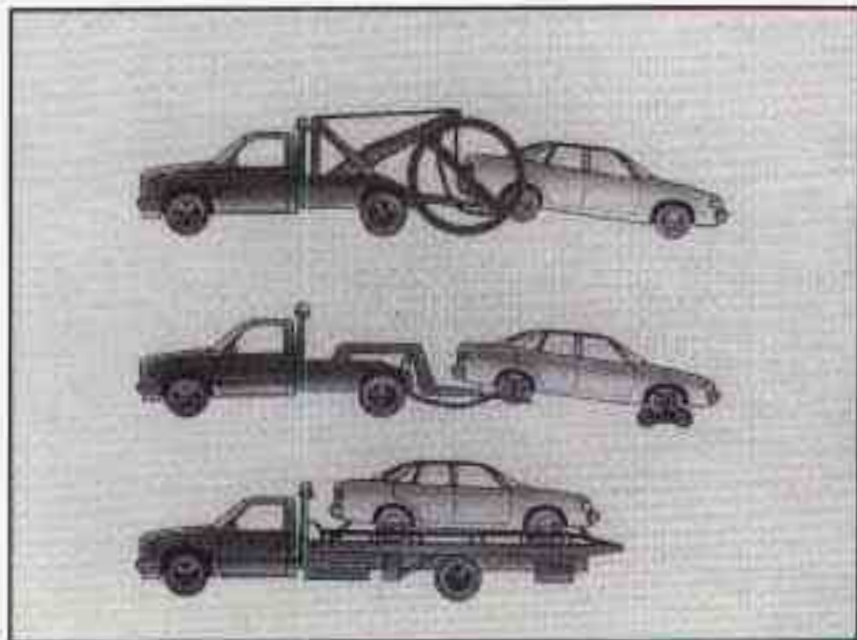

NOTICE:

Do not tow with sling-type equipment or the rear bumper valance will be damaged. Use wheel-lift or car carrier equipment. Additional ramping may be required for car carrier equipment. Use safety chains and wheel straps.

Towing a vehicle over rough surfaces could damage a vehicle. Damage can occur from vehicle to ground or vehicle to wheel-lift equipment. To help avoid damage, install a towing dolly and raise the vehicle until adequate clearance is obtained between the ground and/or wheel-lift equipment.

Do not attach winch cables or J-hooks to suspension components when using car carrier equipment. Always use T-hooks inserted in the T-hook slots.

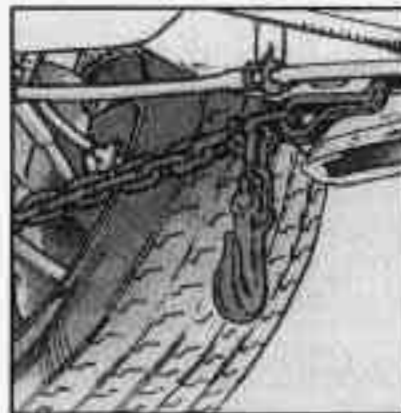

Attach T-hook chains to the T-hook slots in the floor pan support rails, just ahead of the rear wheels, on both sides.

These slots are to be used when loading and securing to car carrier equipment.

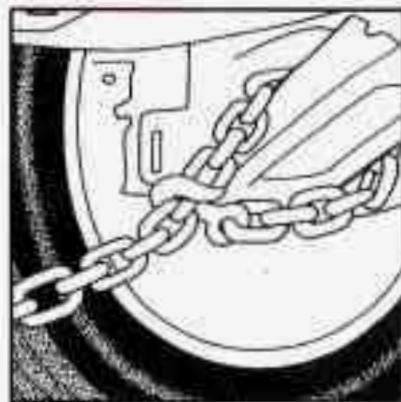

Attach a separate safety chain around the outboard end of both lateral arms.

Engine Overheating

You will find a coolant temperature gage and a warning light about a hot engine on your instrument panel. See "Engine Coolant Temperature Gage" and "Engine Coolant Temperature Warning Light" in the Index. You also have a LOW COOLANT light on your instrument panel. See "Low Coolant Light" in the Index.

If Steam Is Coming From Your Engine



CAUTION:

Steam from an overheated engine can burn you badly, even if you just open the hood. Stay away from the engine if you see or hear steam coming from it. Just turn it off and get everyone away from the vehicle until it cools down. Wait until there is no sign of steam or coolant before opening the hood.

If you keep driving when your engine is overheated, the liquids in it can catch fire. You or others could be badly burned. Stop your engine if it overheats, and get out of the vehicle until the engine is cool.

NOTICE:

If your engine catches fire because you keep driving with no coolant, your vehicle can be badly damaged. The costly repairs would not be covered by your warranty.

If No Steam Is Coming From Your Engine

If you get the overheat warning but see or hear no steam, the problem may not be too serious. Sometimes the engine can get a little too hot when you:

- Climb a long hill on a hot day.
- Stop after high-speed driving.
- Idle for long periods in traffic.
- Tow a trailer.

If you get the overheat warning with no sign of steam, try this for a minute or so:

1. Turn off your air conditioner.
2. Turn on your heater to full hot at the highest fan speed and open the window as necessary.
3. If you're in a traffic jam, shift to NEUTRAL (N); otherwise, shift to the highest gear while driving → DRIVE (D) or THIRD (3).

If you no longer have the overheat warning, you can drive. Just to be safe, drive slower for about 10 minutes. If the warning doesn't come back on, you can drive normally.

If the warning continues, pull over, stop, and park your vehicle right away.

If there's still no sign of steam, you can idle the engine for two or three minutes while you're parked, to see if the warning stops. But then, if you still have the warning, *turn off the engine and get everyone out of the vehicle* until it cools down.

You may decide not to lift the hood but to get service help right away.

When you decide it's safe to lift the hood, here's what you'll see:

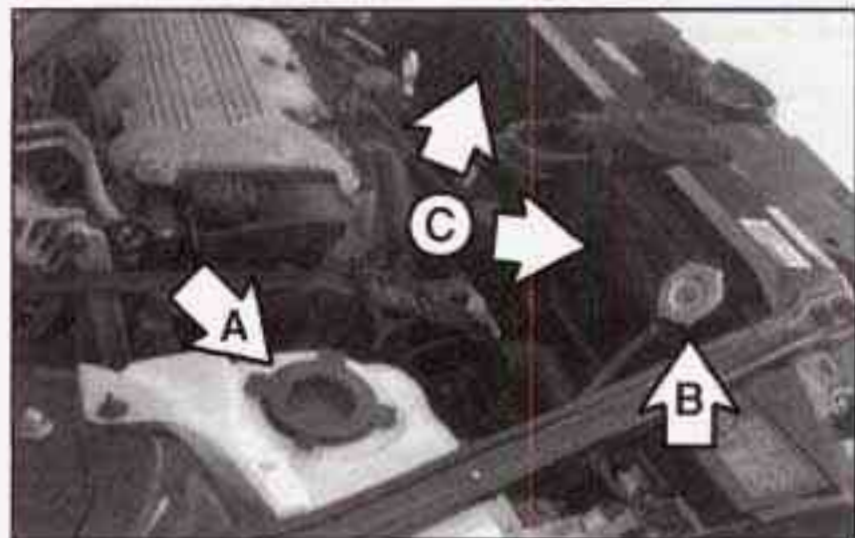

3.1L L82 Engine

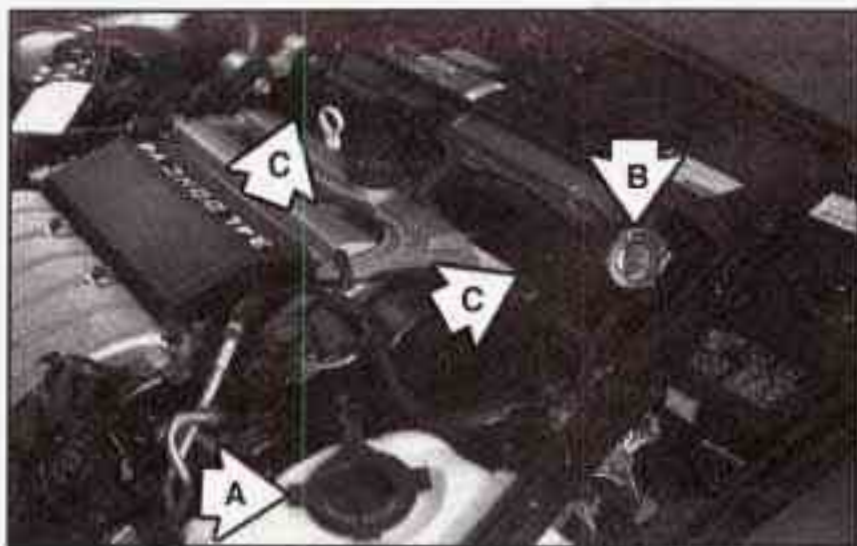

3.4L LQ1 Engine

- A. Coolant Recovery Tank
- B. Radiator Pressure Cap
- C. Electric Engine Fans

⚠ CAUTION:

An electric fan under the hood can start up even when the engine is not running and can injure you. Keep hands, clothing and tools away from any underhood electric fan.

If the coolant inside the coolant recovery tank is boiling, don't do anything else until it cools down.

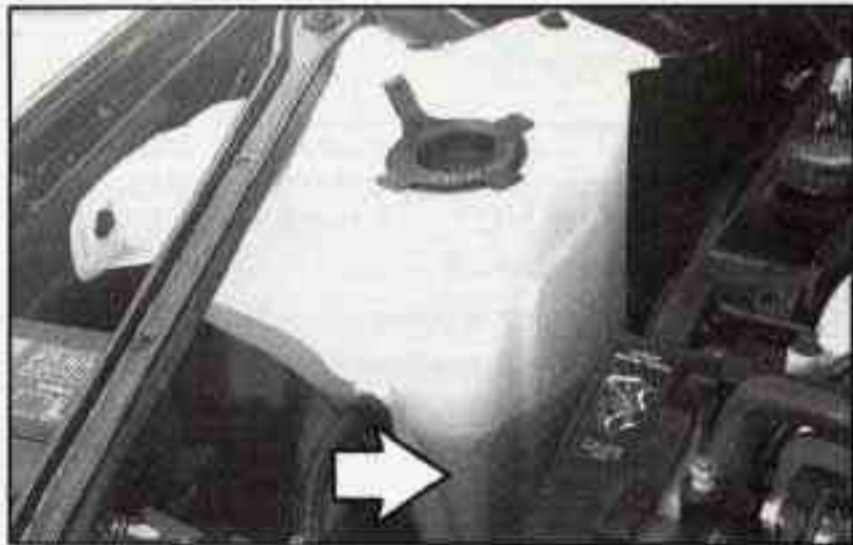

The coolant level should be at or above the COLD mark on a cold engine. The coolant level should be at or above the HOT mark on a hot engine. If it isn't, you may have a leak in the radiator hoses, heater hoses, radiator, water pump or somewhere else in the cooling system.

 **CAUTION:**

Heater and radiator hoses, and other engine parts, can be very hot. Don't touch them. If you do, you can be burned.

Don't run the engine if there is a leak. If you run the engine, it could lose all coolant. That could cause an engine fire, and you could be burned. Get any leak fixed before you drive the vehicle.

NOTICE:

Engine damage from running your engine without coolant isn't covered by your warranty.

If there seems to be no leak, with the engine on, check to see if the electric engine fan(s) are running. If the engine is overheating, both fan(s) should be running. If they aren't, your vehicle needs service.

How to Add Coolant to the Coolant Recovery Tank

If you haven't found a problem yet, but the coolant level isn't at the COLD mark, add a 50/50 mixture of *clean water* (preferably distilled) and DEX-COOL™ (orange-colored, silicate-free) antifreeze at the coolant recovery tank. (See "Engine Coolant" in the Index for more information.)

 **CAUTION:**

Adding only plain water to your cooling system can be dangerous. Plain water, or some other liquid like alcohol, can boil before the proper coolant mix will. Your vehicle's coolant warning system is set for the proper coolant mix. With plain water or the wrong mix, your engine could get too hot but you wouldn't get the overheat warning. Your engine could catch fire and you or others could be burned. Use a 50/50 mix of clean water and DEX-COOL™ antifreeze.

NOTICE:

In cold weather, water can freeze and crack the engine, radiator, heater core and other parts. Use the recommended coolant and the proper coolant mix.



⚠ CAUTION:

You can be burned if you spill coolant on hot engine parts. Coolant contains ethylene glycol and it will burn if the engine parts are hot enough. Don't spill coolant on a hot engine.

When the coolant in the coolant recovery tank is at the COLD mark, start your vehicle.

If the overheat warning continues, there's one more thing you can try. You can add the proper coolant mix directly to the radiator, but be sure the cooling system is cool before you do it.

⚠ CAUTION:

Steam and scalding liquids from a hot cooling system can blow out and burn you badly. They are under pressure, and if you turn the radiator pressure cap -- even a little -- they can come out at high speed. Never turn the cap when the cooling system, including the radiator pressure cap, is hot. Wait for the cooling system and radiator pressure cap to cool if you ever have to turn the pressure cap.



How to Add Coolant to the Radiator

NOTICE:

Your engine has a specific radiator fill procedure. Failure to follow this procedure could cause your engine to overheat and be severely damaged.



1. You can remove the radiator pressure cap when the cooling system, including the radiator pressure cap and upper radiator hose, is no longer hot.

Turn the pressure cap slowly counterclockwise until it first stops. (Don't press down while turning the pressure cap.)

If you hear a hiss, wait for that to stop. A hiss means there is still some pressure left.



2. Then keep turning the pressure cap, but now push down as you turn it. Remove the pressure cap.



CAUTION:

You can be burned if you spill coolant on hot engine parts. Coolant contains ethylene glycol and it will burn if the engine parts are hot enough. Don't spill coolant on a hot engine.

3. After the engine cools, open the coolant air bleed valve.



3.1L V6 (VIN Code M): There are two bleed valves. One is located on the thermostat housing. The other is located on the thermostat bypass tube.



3.4L V6 (VIN Code X): There are two bleed valves. They are located on the thermostat housing and heater inlet pipe. The thermostat location is shown here.



4. Fill the radiator with the proper mix, up to the base of the filler neck.

If you see a stream of coolant coming from an air bleed valve, close the valve. Otherwise, close the valves after the radiator is filled.



5. Rinse or wipe any spilled coolant from the engine and compartment.

6. Then fill the coolant recovery tank to the COLD mark.
7. Put the cap back on the coolant recovery tank, but leave the radiator pressure-cap off.

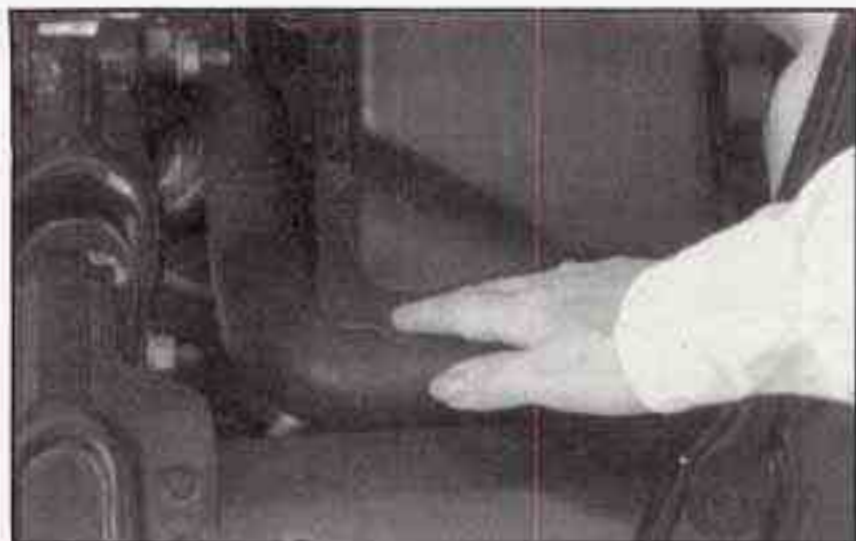

8. Start the engine and let it run until you can feel the upper radiator hose getting hot. Watch out for the engine fans.
9. By this time the coolant level inside the radiator filler neck may be lower. If the level is lower, add more of the proper mix through the filler neck until the level reaches the base of the filler neck.



10. Then replace the pressure cap. At any time during this procedure if coolant begins to flow out of the filler neck, reinstall the pressure cap. Be sure the arrows on the pressure cap line up like this.
11. Check the coolant in the recovery tank. The level in the coolant recovery tank should be at the HOT mark when the engine is hot or at the COLD mark when the engine is cold.

If a Tire Goes Flat

It's unusual for a tire to "blow out" while you're driving, especially if you maintain your tires properly. If air goes out of a tire, it's much more likely to leak out slowly. But if you should ever have a "blowout," here are a few tips about what to expect and what to do:

If a front tire fails, the flat tire will create a drag that pulls the vehicle toward that side. Take your foot off the accelerator pedal and grip the steering wheel firmly. Steer to maintain lane position, and then gently brake to a stop well out of the traffic lane.

A rear blowout, particularly on a curve, acts much like a skid and may require the same correction you'd use in a skid. In any rear blowout, remove your foot from the accelerator pedal. Get the vehicle under control by steering the way you want the vehicle to go. It may be very bumpy and noisy, but you can still steer. Gently brake to a stop -- well off the road if possible.

If a tire goes flat, the next part shows how to use your jacking equipment to change a flat tire safely.

Changing a Flat Tire

If a tire goes flat, avoid further tire and wheel damage by driving slowly to a level place. Turn on your hazard warning flashers.



CAUTION:

Changing a tire can cause an injury. The vehicle can slip off the jack and roll over you or other people. You and they could be badly injured. Find a level place to change your tire. To help prevent the vehicle from moving:

- 1. Set the parking brake firmly.**
- 2. Put the shift lever in PARK (P).**
- 3. Turn off the engine.**

To be even more certain the vehicle won't move, you can put blocks at the front and rear of the tire farthest away from the one being changed. That would be the tire on the other side of the vehicle, at the opposite end.



The following steps will tell you how to use the jack and change a tire.

Removing the Spare Tire and Tools



The equipment you'll need is in the trunk. Pull the carpeting from the floor of the trunk. Turn the center nut on the compact spare cover counterclockwise to remove it. Then lift and remove the cover.



Turn the wing nut counterclockwise and remove it. Then lift off the spacer and remove the spare tire. See "Compact Spare Tire" later in this section for more information about the compact spare.

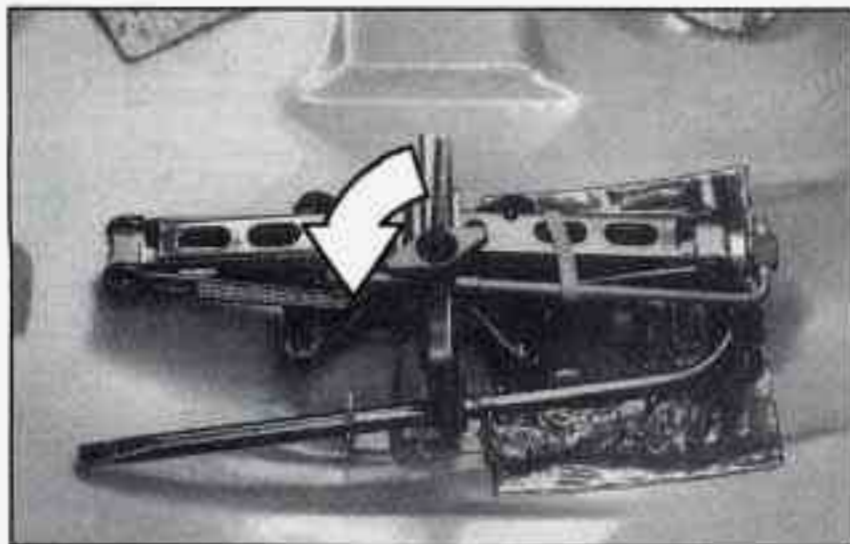

Turn the nut holding the jack and wrench counterclockwise and remove it. Then remove the jack and wrench.

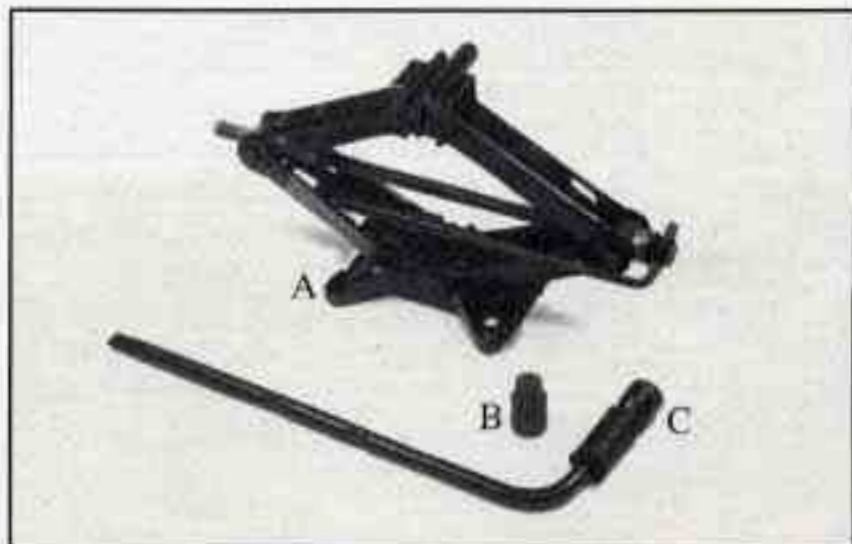

The tools you'll be using include the jack (A), socket (B) and wheel wrench (C).

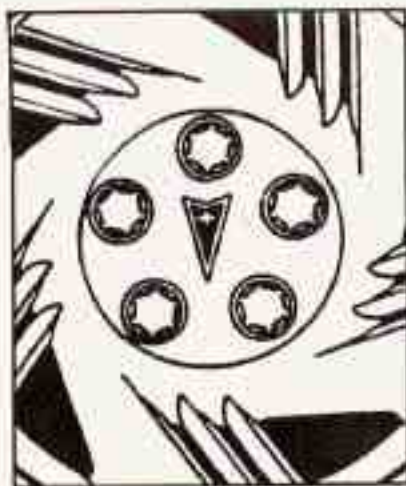

If there is a wheel cover, loosen the plastic nut caps with the wheel wrench. They won't come off. Then, using the flat end of the wheel wrench, pry along the edge of the cover until it comes off. Be careful; the edges may be sharp. Don't try to remove the cover with your bare hands.

If your vehicle has wheel nut caps, remove them using the wheel wrench.

Removing the Flat Tire and Installing the Spare Tire

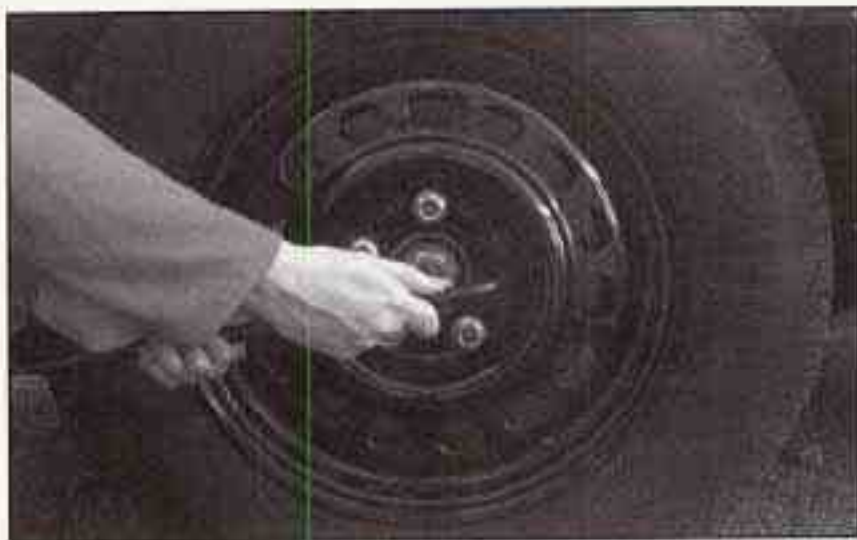

1. Using the wheel wrench, loosen all the wheel nuts. Don't remove them yet.
2. Turn the jack handle clockwise to raise the jack lift head a few inches.

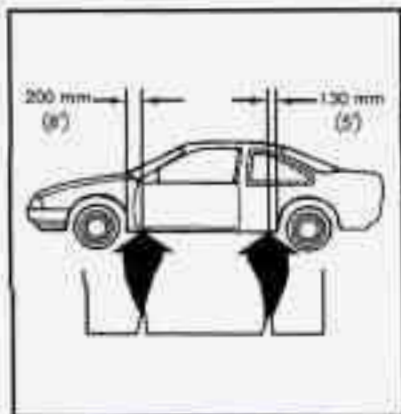

3. Position the jack under the vehicle and raise the jack lift head until it fits firmly into the notch in the vehicle's frame nearest the flat tire.

Put the compact spare tire near you.



CAUTION:

Getting under a vehicle when it is jacked up is dangerous. If the vehicle slips off the jack, you could be badly injured or killed. Never get under a vehicle when it is supported only by a jack.

NOTICE:

Raising your vehicle with the jack improperly positioned will damage the vehicle or may allow the vehicle to fall off the jack. Be sure to fit the jack lift head into the proper location before raising your vehicle.

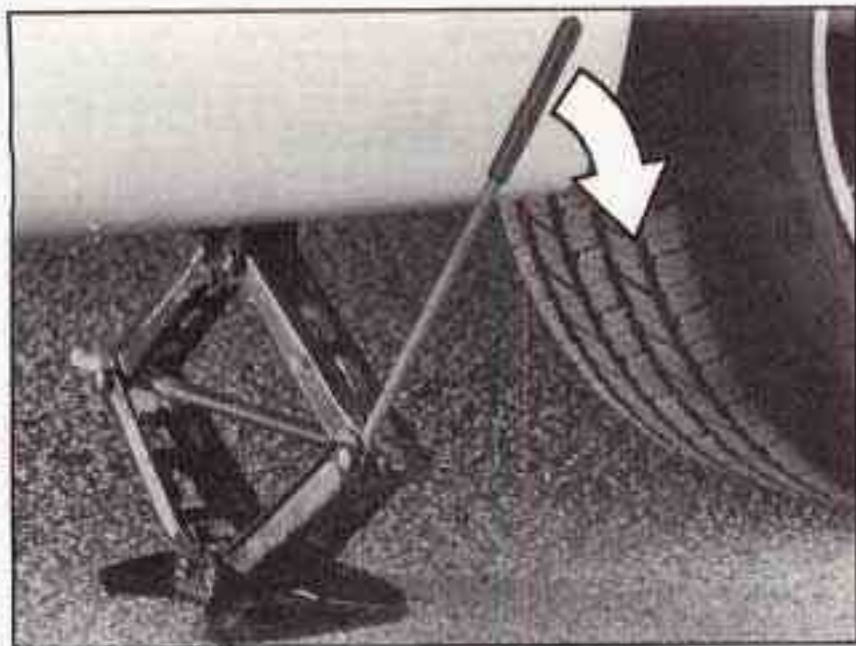

4. Raise the vehicle by turning the jack handle clockwise. Raise the vehicle far enough off the ground for the spare tire to fit under the vehicle.
5. Remove all wheel nuts and take off the flat tire.

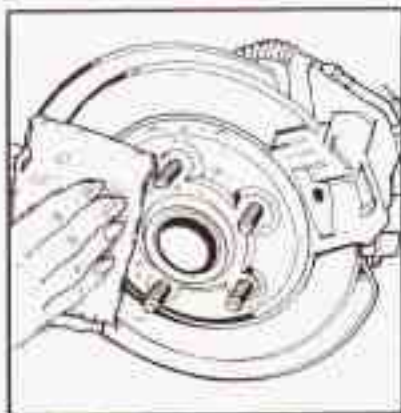

6. Remove any rust or dirt from the wheel bolts, mounting surfaces and spare wheel.

⚠ CAUTION:

Rust or dirt on the wheel, or on the parts to which it is fastened, can make the wheel nuts become loose after a time. The wheel could come off and cause an accident. When you change a wheel, remove any rust or dirt from the places where the wheel attaches to the vehicle. In an emergency, you can use a cloth or a paper towel to do this; but be sure to use a scraper or wire brush later, if you need to, to get all the rust or dirt off.

⚠ CAUTION:

Never use oil or grease on studs or nuts. If you do, the nuts might come loose. Your wheel could fall off, causing a serious accident.



7. Replace the wheel nuts with the rounded end of the nuts toward the wheel. Tighten each nut by hand until the wheel is held against the hub.

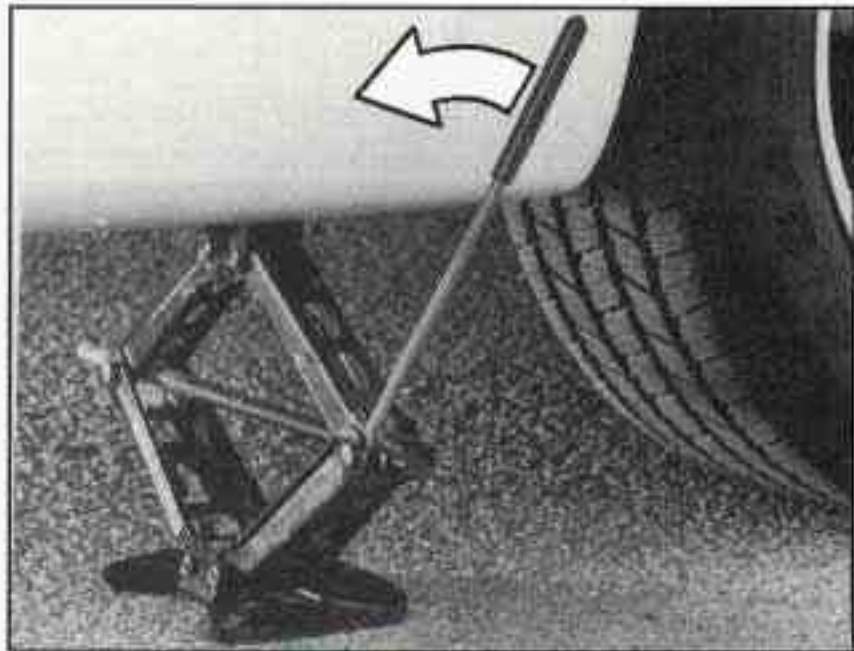

8. Lower the vehicle by turning the jack handle counterclockwise. Lower the jack completely.

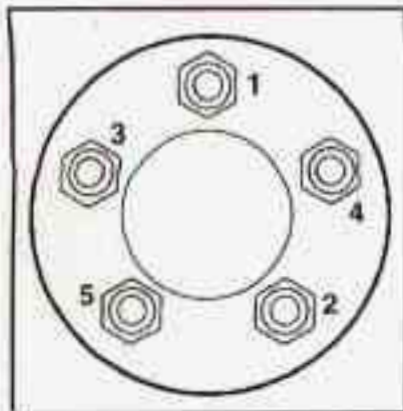

9. Tighten the wheel nuts firmly in a crisscross sequence as shown.

NOTICE:

Improperly tightened wheel nuts can lead to brake pulsation and rotor damage. To avoid expensive brake repairs, evenly tighten the wheel nuts in the proper sequence and to the proper torque specification.

Don't try to put the wheel cover on your compact spare tire. It won't fit. Store the wheel cover in the trunk until you have the flat tire repaired or replaced.

CAUTION:

Incorrect wheel nuts or improperly tightened wheel nuts can cause the wheel to become loose and even come off. This could lead to an accident. Be sure to use the correct wheel nuts. If you have to replace them, be sure to get new GM original equipment wheel nuts.

Stop somewhere as soon as you can and have the nuts tightened with a torque wrench to 100 lb-ft (140 N·m).

NOTICE:

Wheel covers won't fit on your compact spare. If you try to put a wheel cover on your compact spare, you could damage the cover or the spare.

Storing the Flat Tire and Tools

CAUTION:

Storing a jack, a tire or other equipment in the passenger compartment of the vehicle could cause injury. In a sudden stop or collision, loose equipment could strike someone. Store all these in the proper place.

After you've put the compact spare tire on your vehicle, you'll need to store the flat tire in your trunk. Use the following procedure to secure the flat tire in the trunk.

Put the flat tire in the trunk so the side that faces out when it is on the vehicle is facing down. The full-size tire will not fit down into the well. Place it so the front is in the well and the rear is out of the well.

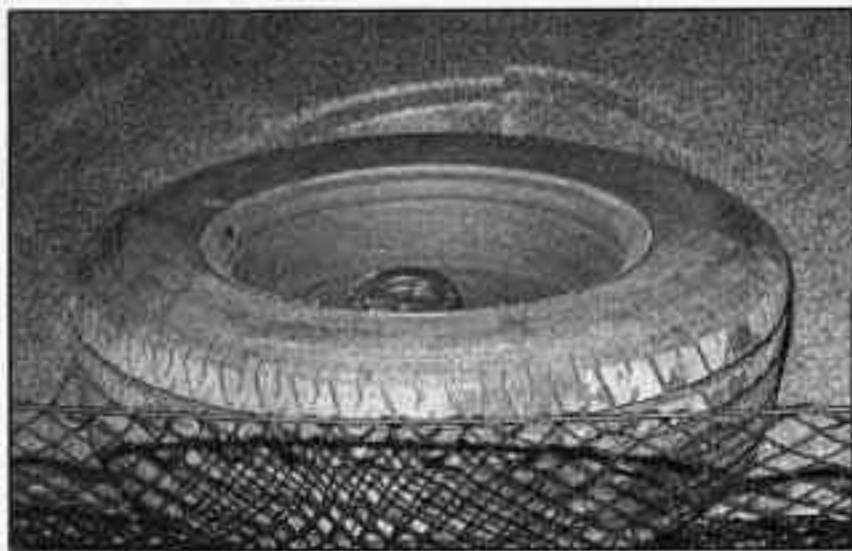

Put the bolt through one of the wheel nut holes, install the retainer over the bolt, then install the wing nut. Put the spacer and nut next to the tire in the well. Store the cover as far forward as possible.

Storing the Spare Tire and Tools

CAUTION:

Storing a jack, a tire or other equipment in the passenger compartment of the vehicle could cause injury. In a sudden stop or collision, loose equipment could strike someone. Store all these in the proper place.

The compact spare is for temporary use only. Replace the compact spare tire with a full-size tire as soon as you can. See "Compact Spare Tire" in the Index. See the storage instructions label to replace your compact spare into your trunk properly.

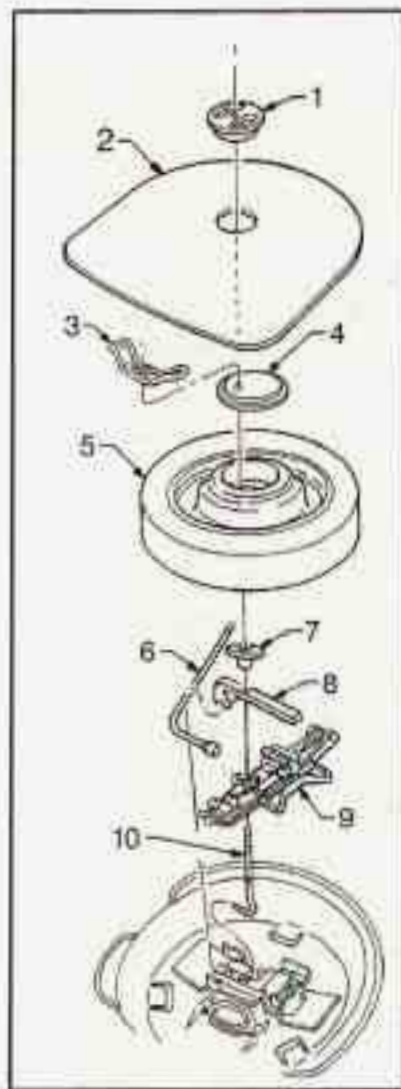

1. Nut
2. Cover
3. Wing Nut
4. Spacer
5. Tire
6. Wrench
7. Nut
8. Retainer
9. Jack
10. Bolt

Compact Spare Tire

Although the compact spare tire was fully inflated when your vehicle was new, it can lose air after a time. Check the inflation pressure regularly. It should be 60 psi (420 kPa).

After installing the compact spare on your vehicle, you should stop as soon as possible and make sure your spare tire is correctly inflated. The compact spare is made to perform well at posted speed limits for distances up to 3,000 miles (5 000 km), so you can finish your trip and have your full-size tire repaired or replaced where you want. Of course, it's best to replace your spare with a full-size tire as soon as you can. Your spare will last longer and be in good shape in case you need it again.

NOTICE:

When the compact spare is installed, don't take your vehicle through an automatic car wash with guide rails. The compact spare can get caught on the rails. That can damage the tire and wheel, and maybe other parts of your vehicle.

Don't use your compact spare on other vehicles.

And don't mix your compact spare tire or wheel with other wheels or tires. They won't fit. Keep your spare tire and its wheel together.

NOTICE:

Tire chains won't fit your compact spare. Using them can damage your vehicle and can damage the chains too. Don't use tire chains on your compact spare.

If You're Stuck: In Sand, Mud, Ice or Snow

What you don't want to do when your vehicle is stuck is to spin your wheels too fast. The method known as "rocking" can help you get out when you're stuck, but you must use caution.

CAUTION:

If you let your tires spin at high speed, they can explode, and you or others could be injured. And, the transaxle or other parts of the vehicle can overheat. That could cause an engine compartment fire or other damage. When you're stuck, spin the wheels as little as possible. Don't spin the wheels above 35 mph (55 km/h) as shown on the speedometer.

NOTICE:

Spinning your wheels can destroy parts of your vehicle as well as the tires. If you spin the wheels too fast while shifting your transaxle back and forth, you can destroy your transaxle.

For information about using tire chains on your vehicle, see "Tire Chains" in the Index.

Rocking Your Vehicle to Get it Out

First, turn your steering wheel left and right. That will clear the area around your front wheels. Then shift back and forth between REVERSE (R) and a forward gear, spinning the wheels as little as possible. Release the accelerator pedal while you shift, and press lightly on the accelerator pedal when the transaxle is in gear. If that doesn't get you out after a few tries, you may need to be towed out. If you do need to be towed out, see "Towing Your Vehicle" in the Index.

Here you will find information about the care of your Pontiac. This section begins with service and fuel information, and then it shows how to check important fluid and lubricant levels. There is also technical information about your vehicle, and a part devoted to its appearance care.

Service

Your Pontiac dealer knows your vehicle best and wants you to be happy with it. We hope you'll go to your dealer for all your service needs. You'll get genuine GM parts and GM-trained and supported service people.

We hope you'll want to keep your GM vehicle all GM. Genuine GM parts have one of these marks:



Doing Your Own Service Work

If you want to do some of your own service work, you'll want to get the proper Pontiac Service Manual. It tells you much more about how to service your Pontiac than this manual can. To order the proper service manual, see "Service and Owner Publications" in the Index.

Your vehicle has an air bag system. Before attempting to do your own service work, see "Servicing Your Air Bag-Equipped Pontiac" in the Index.

You should keep a record with all parts receipts and list the mileage and the date of any service work you perform. See "Maintenance Record" in the Index.

CAUTION:

You can be injured and your vehicle could be damaged if you try to do service work on a vehicle without knowing enough about it.

- **Be sure you have sufficient knowledge, experience, and the proper replacement parts and tools before you attempt any vehicle maintenance task.**
- **Be sure to use the proper nuts, bolts and other fasteners. "English" and "metric" fasteners can be easily confused. If you use the wrong fasteners, parts can later break or fall off. You could be hurt.**

Fuel

Use regular unleaded gasoline rated at 87 octane or higher. At a minimum, it should meet specifications ASTM D4814 in the United States and CGSB 3.5-M93 in Canada. Improved gasoline specifications have been developed by the American Automobile Manufacturers Association (AAMA) for better vehicle performance and engine protection. Gasolines meeting the AAMA specification could provide improved driveability and emission control system protection compared to other gasolines.

Be sure the posted octane is at least 87. If the octane is less than 87, you may get a heavy knocking noise when you drive. If it's bad enough, it can damage your engine.

If you're using fuel rated at 87 octane or higher and you still hear heavy knocking, your engine needs service. But don't worry if you hear a little pinging noise when you're accelerating or driving up a hill. That's normal, and you don't have to buy a higher octane fuel to get rid of pinging. It's the heavy, constant knock that means you have a problem.

If your vehicle is certified to meet California Emission Standards (indicated on the underhood tune-up label), it is designed to operate on fuels that meet California specifications. If such fuels are not available in states adopting California emissions standards, your vehicle will operate satisfactorily on fuels meeting federal specifications, but emission control system performance may be affected. The malfunction indicator lamp on your instrument panel may turn on and/or your vehicle may fail a smog-check test. If this occurs, return to your authorized Pontiac dealer for diagnosis to determine the cause of failure. In the event it is determined that the cause of the condition is the type of fuels used, repairs may not be covered by your warranty.

In Canada, some gasolines contain an octane enhancing additive called MMT. If you use such fuels, your emission control system performance may deteriorate and the malfunction indicator lamp on your instrument panel may turn on. If this happens, return to your authorized Pontiac dealer for service.

To provide cleaner air, all gasolines are now required to contain additives that will help prevent deposits from forming in your engine and fuel system, allowing your emission control system to function properly. Therefore, you should not have to add anything to the fuel. In addition, gasolines containing oxygenates, such as ethers and ethanol, and reformulated gasolines may be available in your area to help clean the air. General Motors recommends that you use these gasolines if they comply with the specifications described earlier.

NOTICE:

Your vehicle was not designed for fuel that contains methanol. Don't use it. It can corrode metal parts in your fuel system and also damage plastic and rubber parts. That damage wouldn't be covered under your warranty.

Fuels in Foreign Countries

If you plan on driving in another country outside the United States or Canada, the proper fuel may be hard to find. Never use leaded gasoline or any other fuel not recommended in the previous text on fuel. Costly repairs caused by use of improper fuel wouldn't be covered by your warranty.

To check on fuel availability, ask an auto club, or contact a major oil company that does business in the country where you'll be driving.

You can also write us at the following address for advice. Just tell us where you're going and give your Vehicle Identification Number (VIN).

General Motors Overseas Distribution Corporation,
North American Export Sales (NAES)
1908 Colonel Sam Drive
Oshawa, Ontario L1H 8P7

Filling Your Tank

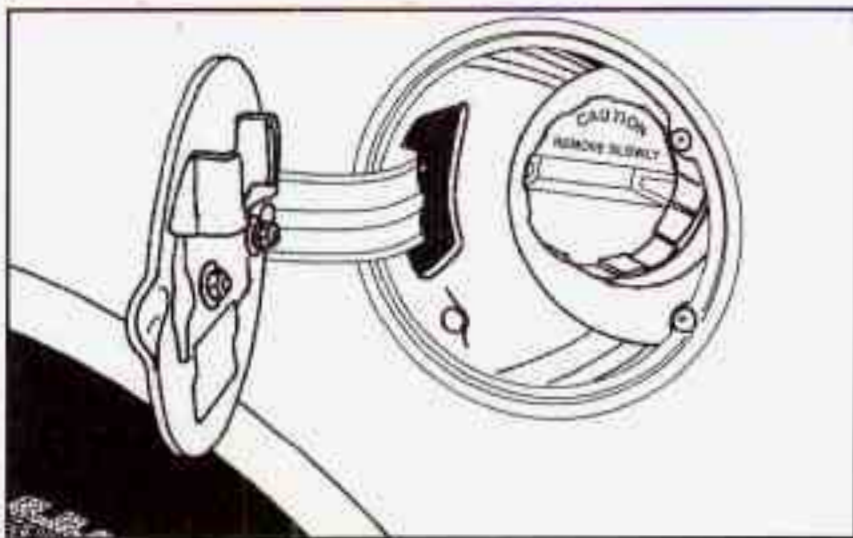

CAUTION:

Gasoline vapor is highly flammable. It burns violently, and that can cause very bad injuries. Don't smoke if you're near gasoline or refueling your vehicle. Keep sparks, flames, and smoking materials away from gasoline.

The cap is behind a hinged door on the left side of your vehicle.

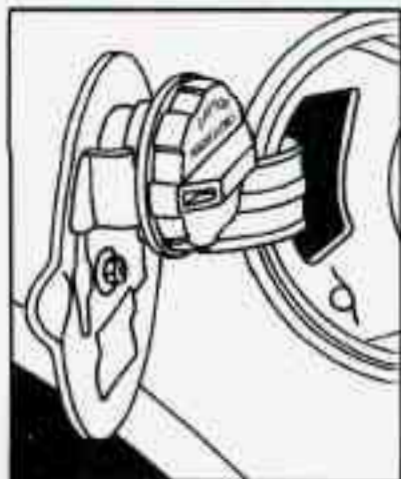

While refueling, hang the cap inside the fuel door.

To take off the cap, turn it slowly to the left (counterclockwise).

CAUTION:

If you get gasoline on yourself and then something ignites it, you could be badly burned. Gasoline can spray out on you if you *open the fuel filler cap too quickly*. This spray can happen if your tank is nearly full, and is more likely in hot weather. Open the fuel filler cap slowly and wait for any “hiss” noise to stop. Then unscrew the cap all the way.

Be careful not to spill gasoline. Clean gasoline from painted surfaces as soon as possible. See “Cleaning the Outside of Your Pontiac” in the Index.

When you put the cap back on, turn it to the right until you hear at least three clicks. Make sure you fully install the cap. The diagnostic system can determine if the fuel cap has been left off or improperly installed. This would allow fuel to evaporate into the atmosphere. See “Malfunction Indicator Lamp” in the Index.

NOTICE:

If you need a new cap, be sure to get the right type. Your dealer can get one for you. If you get the wrong type, it may not fit or have proper venting, and your fuel tank and emissions system might be damaged.

Checking Things Under the Hood

CAUTION:

An electric fan under the hood can start up and injure you even when the engine is not running. Keep hands, clothing and tools away from any underhood electric fan.

CAUTION:

Things that burn can get on hot engine parts and start a fire. These include liquids like gasoline, oil, coolant, brake fluid, windshield washer and other fluids, and plastic or rubber. You or others could be burned. Be careful not to drop or spill things that will burn onto a hot engine.

Hood Release



To open the hood, first pull the handle inside the vehicle.



Then go to the front of the vehicle and release the secondary hood release. Lift the hood.

When you lift the hood of the 3.1L L82 engine, you'll see:

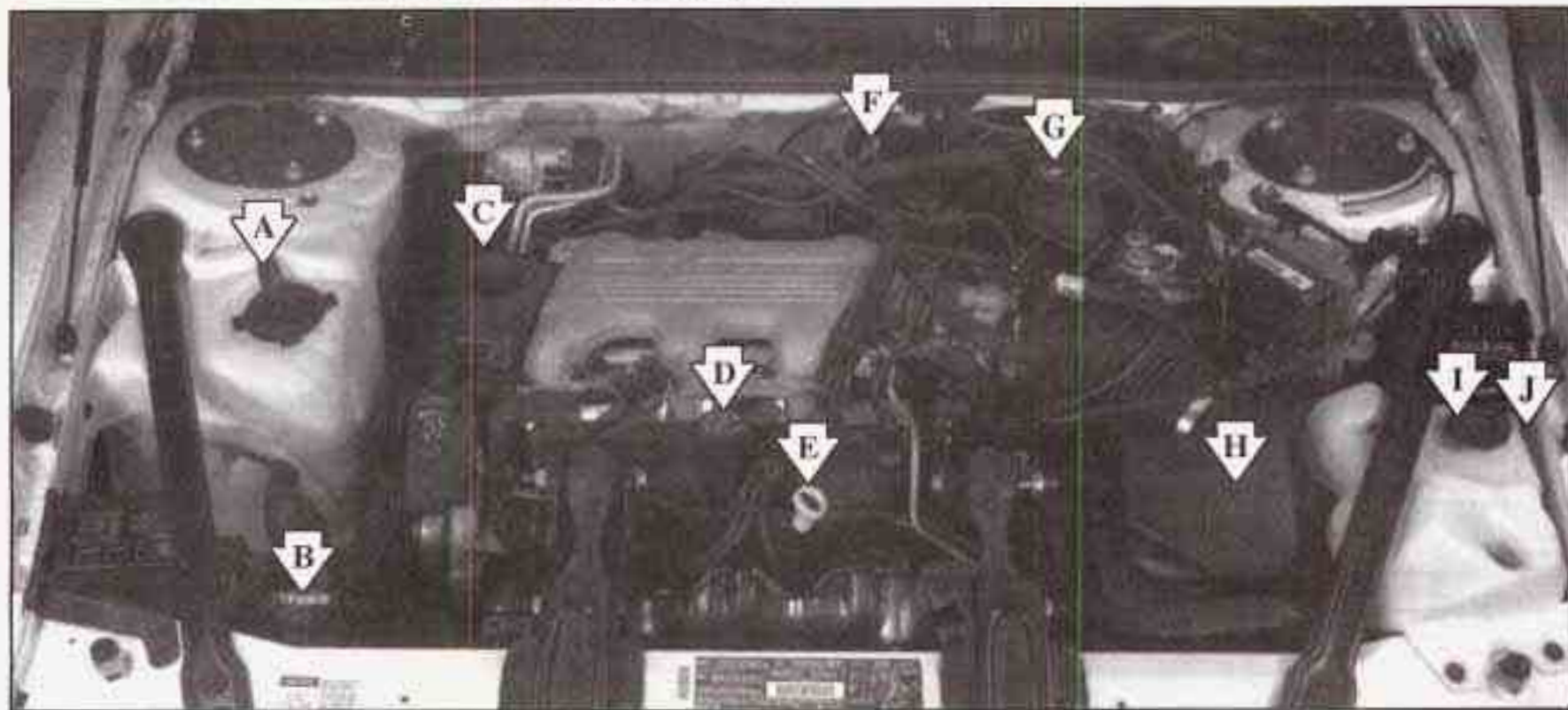

A. Engine Coolant Reservoir

B. Radiator Fill Cap

C. Power Steering Fluid Reservoir

D. Engine Oil Fill Cap

E. Engine Oil Dipstick

F. Automatic Transaxle Dipstick

G. Brake Fluid Reservoir

H. Air Cleaner

I. Windshield Washer
Fluid Reservoir

J. Battery (located under
Windshield Washer
Fluid Reservoir)

When you lift the hood of the 3.4L LQ1 engine, you'll see:

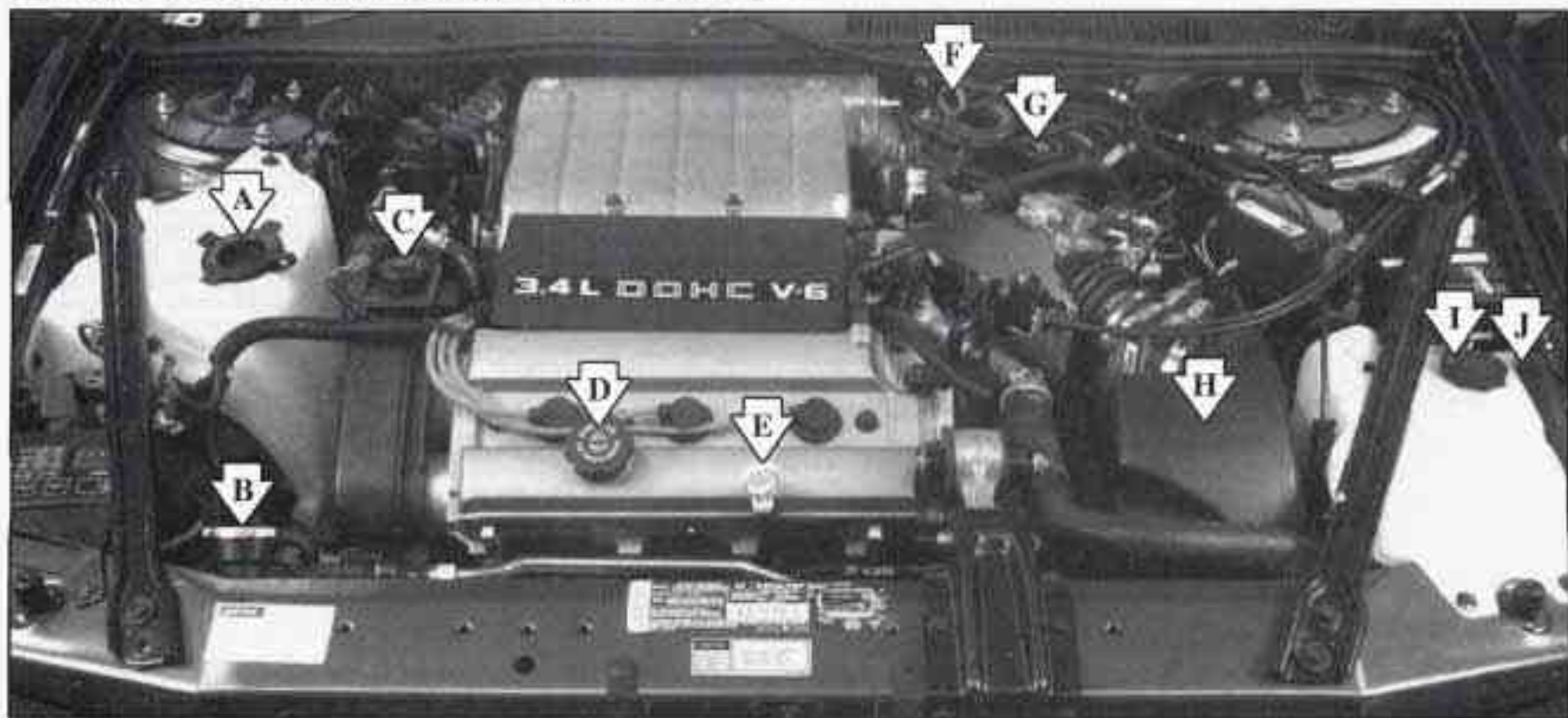

A. Engine Coolant Reservoir

B. Radiator Fill Cap

C. Power Steering Fluid Reservoir

D. Engine Oil Fill Cap

E. Engine Oil Dipstick

F. Automatic Transaxle Dipstick

G. Brake Fluid Reservoir

H. Air Cleaner

I. Windshield Washer
Fluid Reservoir

J. Battery (located under
Windshield Washer
Fluid Reservoir)

Before closing the hood, be sure all the filler caps are on properly. Then just pull the hood down and close it firmly.

Engine Oil

**LOW OIL
LEVEL**

If the **LOW OIL LEVEL** light on the instrument panel comes on, it means you need to check your engine oil level right away.

For more information, see "Low Oil Level Light" in the Index. You should check your engine oil level regularly; this is an added reminder.

It's a good idea to check your engine oil after you get fuel. In order to get an accurate reading, the oil must be hot and the vehicle must be on level ground.



3.1L L82 Engine



3.4L LQ1 Engine

The engine oil dipstick handle is the yellow loop near the front of the engine.

Turn off the engine and give the oil 20 minutes to drain back into the oil pan. If you don't, the oil dipstick might not show the actual level.

Checking Engine Oil

Pull out the dipstick and clean it with a paper towel or cloth, then push it back in all the way. Remove it again, keeping the tip down, and check the level.

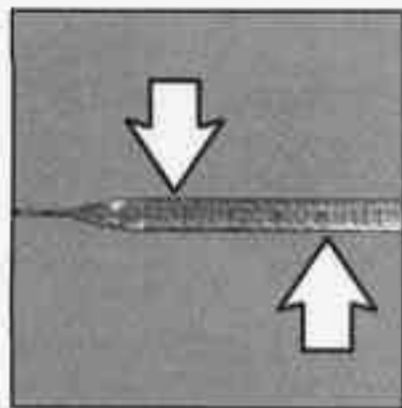

3.1L L82 Engine

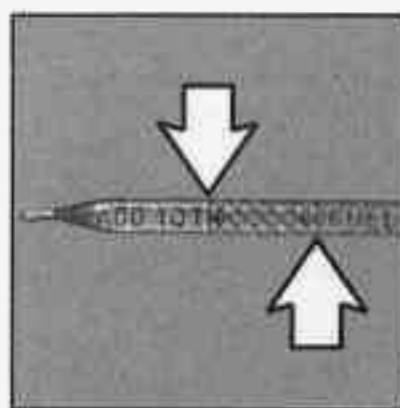

3.4L LQ1 Engine

When to Add Oil

If the oil is at or below the lower mark, then you'll need to add some oil. But you must use the right kind. This part explains what kind of oil to use. For crankcase capacity, see "Capacities and Specifications" in the Index.

NOTICE:

Don't add too much oil. If your engine has so much oil that the oil level gets above the cross-hatched area that shows the proper operating range, your engine could be damaged.



3.1L L82 Engine



3.4L LQ1 Engine

Just fill it enough to put the level somewhere in the proper operating range. Push the dipstick all the way back in when you're through.

What Kind of Oil to Use

Oils recommended for your vehicle can be identified by looking for the "Starburst" symbol. This symbol indicates that the oil has been certified by the American Petroleum Institute (API). Do not use any oil which does not carry this Starburst symbol.



If you change your own oil, be sure you use oil that has the Starburst symbol on the front of the oil container.

If you have your oil changed for you, be sure the oil put into your engine is American Petroleum Institute certified for gasoline engines.

You should also use the proper viscosity oil for your vehicle, as shown in the following chart:

RECOMMENDED SAE VISCOSITY GRADE ENGINE OILS

FOR BEST FUEL ECONOMY AND COLD STARTING, SELECT THE LOWEST SAE VISCOSITY GRADE OIL FOR THE EXPECTED TEMPERATURE RANGE.

**HOT
WEATHER**



**COLD
WEATHER**

**LOOK
FOR THIS
SYMBOL**



DO NOT USE SAE 20W-50 OR ANY OTHER
GRADE OIL NOT RECOMMENDED

As shown in the chart, if you have the 3.1L engine, SAE 5W-30 is best for your vehicle. However, you can use SAE 10W-30 if it's going to be 0°F (-18°C) or above. These numbers on an oil container show its viscosity, or thickness. Do not use other viscosity oils, such as SAE 20W-50.

RECOMMENDED SAE VISCOSITY GRADE ENGINE OILS

FOR BEST FUEL ECONOMY AND COLD STARTING, SELECT THE LOWEST SAE VISCOSITY GRADE OIL FOR THE EXPECTED TEMPERATURE RANGE.

HOT
WEATHER



COLD
WEATHER

LOOK
FOR THIS
SYMBOL



SAE 5W-30

SAE 10W-30
PREFERRED
above 0°F
(-18°C)

DO NOT USE SAE 20W-50 OR ANY OTHER
GRADE OIL NOT RECOMMENDED

As shown in the chart, if you have the 3.4L engine, SAE 10W-30 is best for your vehicle. However, you can use SAE 5W-30 if it's going to be colder than 60°F (16°C) before your next oil change. When it's very cold, you should use SAE 5W-30. These numbers on an oil container show its viscosity, or thickness. Do not use other viscosity oils, such as SAE 20W-50.

NOTICE:

Use only engine oil with the American Petroleum Institute Certified For Gasoline Engines "Starburst" symbol. Failure to use the recommended oil can result in engine damage not covered by your warranty.

GM Goodwrench[®] oil meets all the requirements for your vehicle.

Engine Oil Additives

Don't add anything to your oil. Your Pontiac dealer is ready to advise if you think something should be added.

When to Change Engine Oil

See if any one of these is true for you:

- Most trips are less than 5 to 10 miles (8 to 16 km). This is particularly important when outside temperatures are below freezing.
- Most trips include extensive idling (such as frequent driving in stop-and-go traffic).
- Most trips are through dusty areas.
- You frequently tow a trailer or use a carrier on top of your vehicle.
- The vehicle is used for delivery service, police, taxi or other commercial application.

Driving under these conditions causes engine oil to break down sooner. If any one of these is true for your vehicle, then you need to change your oil and filter every 3,000 miles (5 000 km) or 3 months -- whichever occurs first.

If none of them is true, change the oil and filter every 7,500 miles (12 500 km) or 12 months -- whichever occurs first. Driving a vehicle with a fully warmed engine under highway conditions causes engine oil to break down slower.

What to Do with Used Oil

Did you know that used engine oil contains certain elements that may be unhealthy for your skin and could even cause cancer? Don't let used oil stay on your skin for very long. Clean your skin and nails with soap and water, or a good hand cleaner. Wash or properly throw away clothing or rags containing used engine oil. (See the manufacturer's warnings about the use and disposal of oil products.)

Used oil can be a real threat to the environment. If you change your own oil, be sure to drain all free-flowing oil from the filter before disposal. Don't ever dispose of oil by putting it in the trash, pouring it on the ground, into sewers, or into streams or bodies of water. Instead, recycle it by taking it to a place that collects used oil. If you have a problem properly disposing of your used oil, ask your dealer, a service station or a local recycling center for help.

Air Cleaner

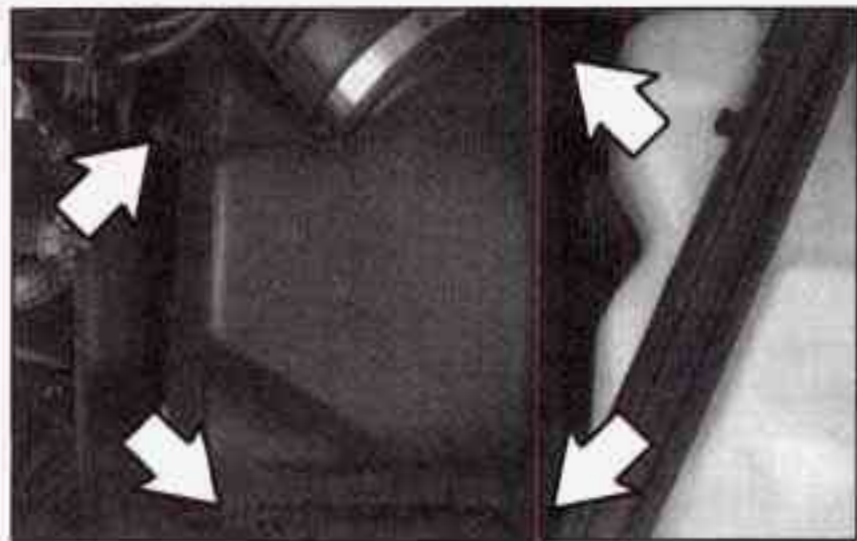

To check or replace the air filter, remove the four screws and pull off the cover.

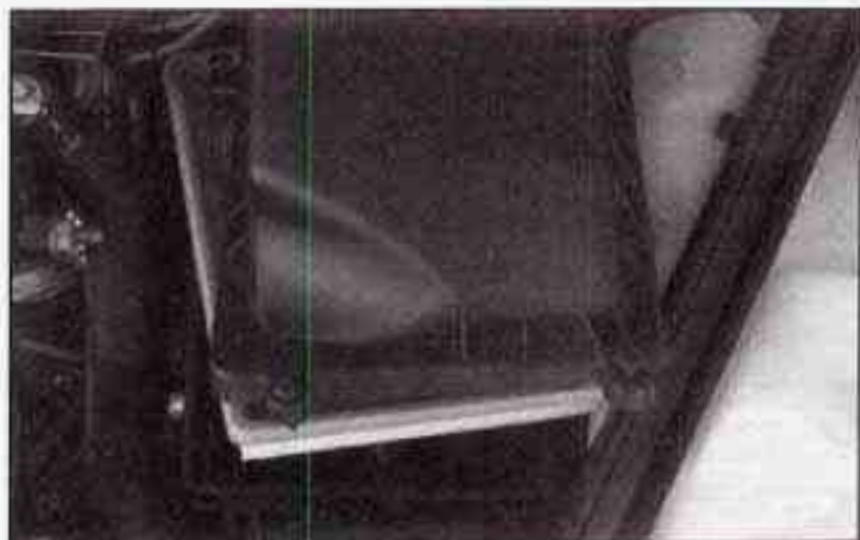

Pull out the filter. Be sure to install the air filter and install the cover tightly when you are finished.

Refer to the Maintenance Schedule to determine when to replace the air filter.

See "Scheduled Maintenance Services" in the Index.



CAUTION:

Operating the engine with the air cleaner off can cause you or others to be burned. The air cleaner not only cleans the air, it stops flame if the engine backfires. If it isn't there, and the engine backfires, you could be burned. Don't drive with it off, and be careful working on the engine with the air cleaner off.

NOTICE:

If the air cleaner is off, a backfire can cause a damaging engine fire. And, dirt can easily get into your engine, which will damage it. Always have the air cleaner in place when you're driving.

Automatic Transaxle Fluid

When to Check and Change

A good time to check your automatic transaxle fluid level is when the engine oil is changed.

Change both the fluid and filter every 50,000 miles (83 000 km) if the vehicle is mainly driven under one or more of these conditions:

- In heavy city traffic where the outside temperature regularly reaches 90°F (32°C) or higher.
- In hilly or mountainous terrain.
- When doing frequent trailer towing.
- Uses such as found in taxi, police or delivery service.

If you do not use your vehicle under any of these conditions, the fluid and filter do not require changing.

See "Scheduled Maintenance Services" in the Index.

How to Check

Because this operation can be a little difficult, you may choose to have this done at your Pontiac dealership Service Department.

If you do it yourself, be sure to follow all the instructions here, or you could get a false reading on the dipstick.

NOTICE:

Too much or too little fluid can damage your transaxle. Too much can mean that some of the fluid could come out and fall on hot engine parts or exhaust system parts, starting a fire. Be sure to get an accurate reading if you check your transaxle fluid.

Wait at least 30 minutes before checking the transaxle fluid level if you have been driving:

- When outside temperatures are above 90°F (32°C).
- At high speed for quite a while.
- In heavy traffic → especially in hot weather.
- While pulling a trailer.

To get the right reading, the fluid should be at normal operating temperature, which is 180°F to 200°F (82°C to 93°C).

Get the vehicle warmed up by driving about 15 miles (24 km) when outside temperatures are above 50°F (10°C). If it's colder than 50°F (10°C), you may have to drive longer.

Checking the Fluid Level

- Park your vehicle on a level place. Keep the engine running.
- With the parking brake applied, place the shift lever in PARK (P).
- With your foot on the brake pedal, move the shift lever through each gear range, pausing for about three seconds in each range. Then, position the shift lever in PARK (P).
- Let the engine run at idle for three to five minutes.

Then, without shutting off the engine, follow these steps:



3.1L L82 Engine



3.4L LQ1 Engine

1. The transaxle fluid dipstick handle is the red loop near the back of the engine. Pull out the dipstick and wipe it with a clean rag or paper towel.
2. Push it back in all the way, wait three seconds and then pull it back out again.

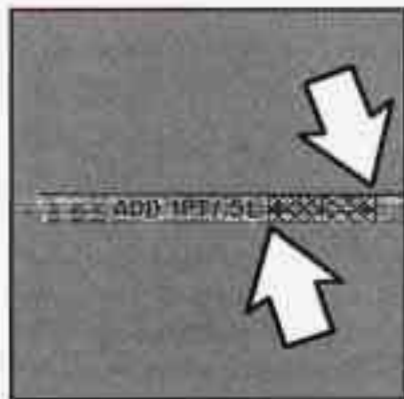

3.1L L82 Engine

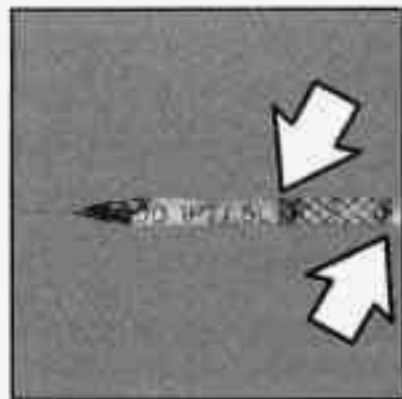

3.4L LQ1 Engine

3. Check both sides of the dipstick, and read the lower level. The fluid level must be in the cross-hatched area.
4. If the fluid level is in the acceptable range, push the dipstick back in all the way.

How to Add Fluid

Refer to the Maintenance Schedule to determine what kind of transaxle fluid to use. See “Recommended Fluids and Lubricants” in the Index.

If the fluid level is low, add only enough of the proper fluid to bring the level into the cross-hatched area on the dipstick.

1. Pull out the dipstick.
2. Using a long-neck funnel, add enough fluid at the dipstick hole to bring it to the proper level.

It doesn't take much fluid, generally less than a pint (0.5 L). *Don't overfill.* We recommend you use only fluid labeled DEXRON®-III, because fluid with that label is made especially for your automatic transaxle. Damage caused by fluid other than DEXRON-III is not covered by your new vehicle warranty.

- After adding fluid, recheck the fluid level as described under “How to Check.”
- When the correct fluid level is obtained, push the dipstick back in all the way.

Engine Coolant

The cooling system in your vehicle is filled with new DEX-COOL™ (orange-colored, silicate-free) engine coolant. This coolant is designed to remain in your vehicle for 5 years or 100,000 miles (166 000 km), whichever occurs first.

The following explains your cooling system and how to add coolant when it is low. If you have a problem with engine overheating or if you need to add coolant to your radiator, see “Engine Overheating” in the Index.

A 50/50 mixture of water and the proper coolant for your Pontiac will:

- Give freezing protection down to -34°F (-37°C),
- Give boiling protection up to 265°F (129°C),
- Protect against rust and corrosion,
- Help keep the proper engine temperature,
- Let the warning lights and gages work as they should.

NOTICE:

When adding coolant it is important that you use DEX-COOL™ (orange-colored, silicate-free) coolant meeting GM Specification 6277M.

If *silicated* coolant is added to the system, premature engine, heater core or radiator corrosion may result. In addition, the engine coolant will require change sooner -- at 30,000 miles (50 000 km) or 24 months, whichever occurs first.

What to Use

Use a mixture of one-half *clean water* (preferably distilled) and one-half DEX-COOL™ (orange-colored, silicate-free) antifreeze that meets GM Specification 6277M, which won't damage aluminum parts. Use GM Engine Coolant Supplement (sealer) (GM Part No. 3634621) with any complete coolant change. If you use this mixture, you don't need to add anything else.

CAUTION:

Adding only plain water to your cooling system can be dangerous. Plain water, or some other liquid like alcohol, can boil before the proper coolant mix will. Your vehicle's coolant warning system is set for the proper coolant mix. With plain water or the wrong mix, your engine could get too hot but you wouldn't get the overheat warning. Your engine could catch fire and you or others could be burned. Use a 50/50 mix of clean water and DEX-COOL™ (orange-colored, silicate-free) antifreeze.

NOTICE:

If you use an improper coolant mix, your engine could overheat and be badly damaged. The repair cost wouldn't be covered by your warranty. Too much water in the mix can freeze and crack the engine, radiator, heater core and other parts.

If you have to add coolant more than four times a year, have your dealer check your cooling system.

NOTICE:

If you use the proper coolant, you don't have to add extra inhibitors or additives which claim to improve the system. These can be harmful.

Checking Coolant

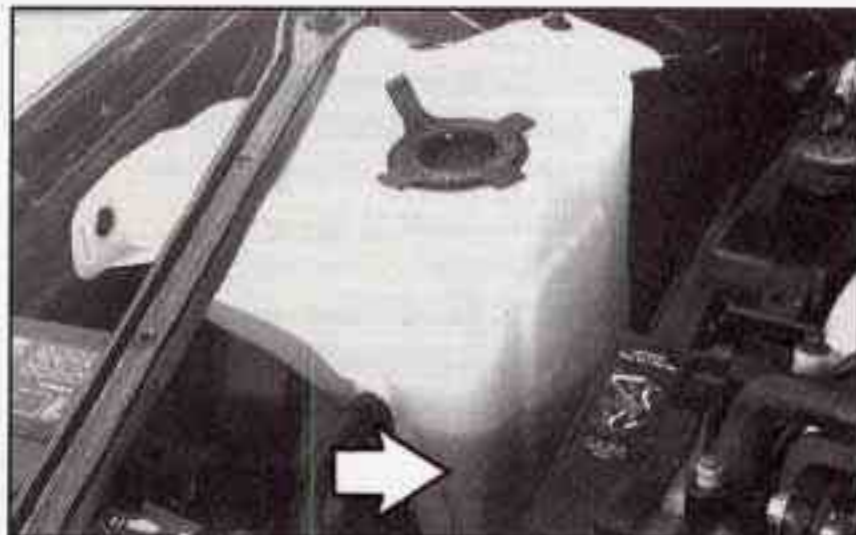

When your engine is cold, the coolant level should be at the COLD mark or a little higher. When your engine is warm, the level should be up to the HOT mark or a little higher.

LOW COOLANT

If this light comes on, it means you're low on engine coolant.

Adding Coolant

If you need more coolant, add the proper mix *at the coolant recovery tank*.

If the coolant recovery tank is completely empty, add coolant to the radiator. (See "Engine Overheating" in the Index.)

CAUTION:

Turning the radiator pressure cap when the engine and radiator are hot can allow steam and scalding liquids to blow out and burn you badly. With the coolant recovery tank, you will almost never have to add coolant at the radiator. Never turn the radiator pressure cap -- even a little -- when the engine and radiator are hot.

Add coolant mix at the recovery tank, but be careful not to spill it.

CAUTION:

You can be burned if you spill coolant on hot engine parts. Coolant contains ethylene glycol, and it will burn if the engine parts are hot enough. Don't spill coolant on a hot engine.

Radiator Pressure Cap

NOTICE:

Your radiator cap is a 15 psi (105 kPa) pressure-type cap and must be tightly installed to prevent coolant loss and possible engine damage from overheating. Be sure the arrows on the cap line up with the overflow tube on the radiator filler neck.

When you replace your radiator pressure cap, an AC[®] cap is recommended.

Thermostat

Engine coolant temperature is controlled by a thermostat in the engine coolant system. The thermostat stops the flow of coolant through the radiator until the coolant reaches a preset temperature.

When you replace your thermostat, an AC[®] thermostat is recommended.

Power Steering Fluid

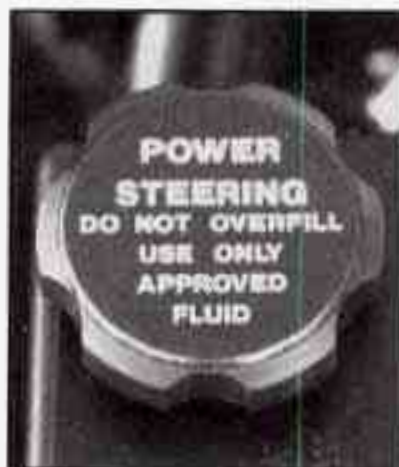

3.1L L82 Engine



3.4L LQ1 Engine

When to Check Power Steering Fluid

It is not necessary to regularly check power steering fluid unless you suspect there is a leak in the system or you hear an unusual noise. A fluid loss in this system could indicate a problem. Have the system inspected and repaired.

How To Check Power Steering Fluid

When the engine compartment is cool, unscrew the cap and wipe the dipstick with a clean rag. Replace the cap and completely tighten it. Then remove the cap again and look at the fluid level on the dipstick.



When the engine compartment is hot, the level should be at the H mark. When it's cold, the level should be at the C mark. If the fluid is at the ADD mark, you should add fluid.

What to Use

Refer to the Maintenance Schedule to determine what kind of fluid to use. See "Recommended Fluids and Lubricants" in the Index. Always use the proper fluid. Failure to use the proper fluid can cause leaks and damage hoses and seals.

Windshield Washer Fluid

What to Use

When you need windshield washer fluid, be sure to read the manufacturer's instructions before use. If you will be operating your vehicle in an area where the temperature may fall below freezing, use a fluid that has sufficient protection against freezing.

Adding Washer Fluid



Open the cap labeled WASHER FLUID ONLY. Add washer fluid until the tank is full.

NOTICE:

- **When using concentrated washer fluid, follow the manufacturer's instructions for adding water.**
- **Don't mix water with ready-to-use washer fluid. Water can cause the solution to freeze and damage your washer fluid tank and other parts of the washer system. Also, water doesn't clean as well as washer fluid.**
- **Fill your washer fluid tank only three-quarters full when it's very cold. This allows for expansion, which could damage the tank if it is completely full.**
- **Don't use radiator antifreeze in your windshield washer. It can damage your washer system and paint.**

Brakes

Brake Fluid



Your brake master cylinder reservoir is here. It is filled with DOT-3 brake fluid.

There are only two reasons why the brake fluid level in the reservoir might go down. The first is that the brake fluid goes down to an acceptable level during normal brake lining wear. When new linings are put in, the fluid level goes back up. The other reason is that fluid is leaking out of the brake system. If it is, you should have your brake system fixed, since a leak means that sooner or later your brakes won't work well, or won't work at all.

So, it isn't a good idea to "top off" your brake fluid. Adding brake fluid won't correct a leak. If you add fluid when your linings are worn, then you'll have too much fluid when you get new brake linings. You should add (or remove) brake fluid, as necessary, only when work is done on the brake hydraulic system.



CAUTION:

If you have too much brake fluid, it can spill on the engine. The fluid will burn if the engine is hot enough. You or others could be burned, and your vehicle could be damaged. Add brake fluid only when work is done on the brake hydraulic system.

When your brake fluid falls to a low level, your brake warning light will come on. See "Brake System Warning Light" in the Index.

What to Add

When you do need brake fluid, use only DOT-3 brake fluid -- such as Delco Supreme 11[®] (GM Part No. 1052535). Use new brake fluid from a sealed container only, and always clean the brake fluid reservoir cap before removing it.

CAUTION:

With the wrong kind of fluid in your brake system, your brakes may not work well, or they may not even work at all. This could cause a crash. Always use the proper brake fluid.

NOTICE:

- Using the wrong fluid can badly damage brake system parts. For example, just a few drops of mineral-based oil, such as engine oil, in your brake system can damage brake system parts so badly that they'll have to be replaced. Don't let someone put in the wrong kind of fluid.
- If you spill brake fluid on your vehicle's painted surfaces, the paint finish can be damaged. Be careful not to spill brake fluid on your vehicle. If you do, wash it off immediately. See "Appearance Care" in the Index.

Brake Wear

Your Pontiac has four-wheel disc brakes.

Disc brake pads have built-in wear indicators that make a high-pitched warning sound when the brake pads are worn and new pads are needed. The sound may come and go or be heard all the time your vehicle is moving (except when you are pushing on the brake pedal firmly).

CAUTION:

The brake wear warning sound means that sooner or later your brakes won't work well. That could lead to an accident. When you hear the brake wear warning sound, have your vehicle serviced.

NOTICE:

Continuing to drive with worn-out brake pads could result in costly brake repair.

Some driving conditions or climates may cause a brake squeal when the brakes are first applied or lightly applied. This does not mean something is wrong with your brakes.

Free movement of brake calipers and properly torqued wheel nuts are necessary to help prevent brake pulsation. When tires are rotated, inspect brake calipers for movement, brake pads for wear, and evenly torque wheel nuts in the proper sequence to GM specifications.

Brake linings should always be replaced as complete axle sets.

Brake Pedal Travel

See your dealer if the brake pedal does not return to normal height, or if there is a rapid increase in pedal travel. This could be a sign of brake trouble.

Brake Adjustment

Every time you apply the brakes, with or without the vehicle moving, your brakes adjust for wear.

Replacing Brake System Parts

The braking system on a modern vehicle is complex. Its many parts have to be of top quality and work well together if the vehicle is to have really good braking. Vehicles we design and test have top-quality GM brake parts in them, as your Pontiac does when it is new. When you replace parts of your braking system -- for example, when your brake linings wear down and you have to have new ones put in -- be sure you get new genuine GM replacement parts. If you don't, your brakes may no longer work properly. For example, if someone puts in brake linings that are wrong for your vehicle, the balance between your front and rear brakes can change -- for the worse. The braking performance you've come to expect can change in many other ways if someone puts in the wrong replacement brake parts.

Battery

Every new Pontiac has a Delco Freedom[®] battery. You never have to add water to one of these. When it's time for a new battery, we recommend a Delco Freedom battery. Get one that has the replacement number shown on the original battery's label.

Vehicle Storage

If you're not going to drive your vehicle for 25 days or more, take off the black, negative (-) cable from the battery. This will help keep your battery from running down.

CAUTION:

Batteries have acid that can burn you and gas that can explode. You can be badly hurt if you aren't careful. See "Jump Starting" in the Index for tips on working around a battery without getting hurt.

Contact your dealer to learn how to prepare your vehicle for longer storage periods.

Also, for your audio system, see "Theft-Deterrent Feature" in the Index.

Bulb Replacement

In this section you'll find directions for changing the bulbs in some of the lamps on your Pontiac. See "Replacement Bulbs" in the Index to find the type of bulb you should use.

Halogen Bulbs

CAUTION:

Halogen bulbs have pressurized gas inside and can burst if you drop or scratch the bulb. You or others could be injured. Be sure to read and follow the instructions on the bulb package.

Headlamps (2-Door Models)

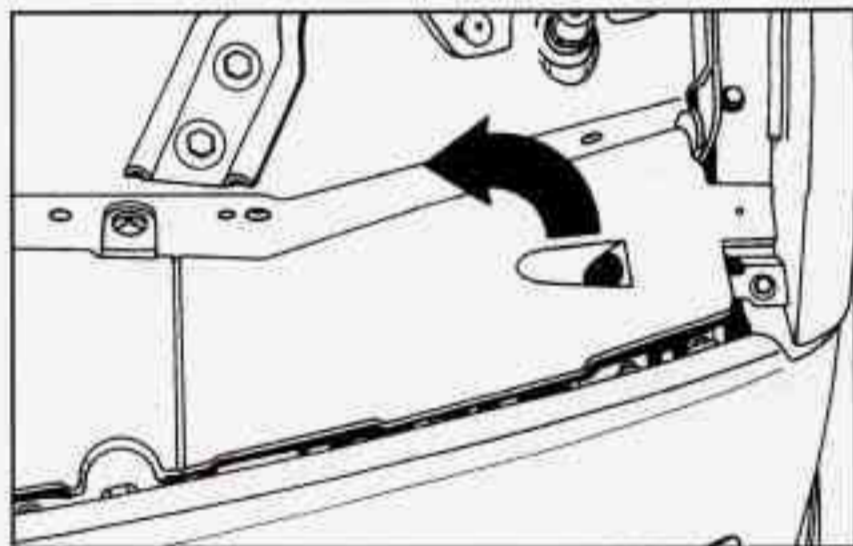

1. Open the headlamp panel.

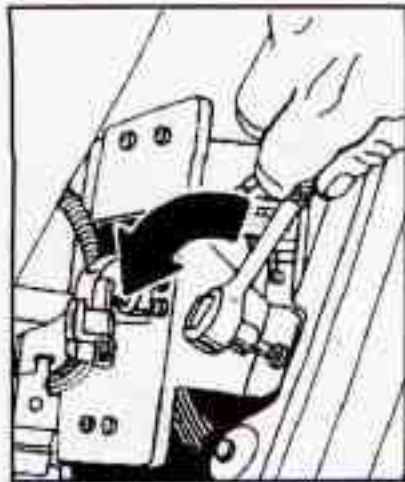

2. Remove the screw at the top of the headlamp support panel. Loosen the two screws at the bottom of the panel. Loosen these two screws until they are out of the headlamp frame, but still in the brackets on the headlamp assembly.

3. Carefully lift the headlamp assembly and support panel.

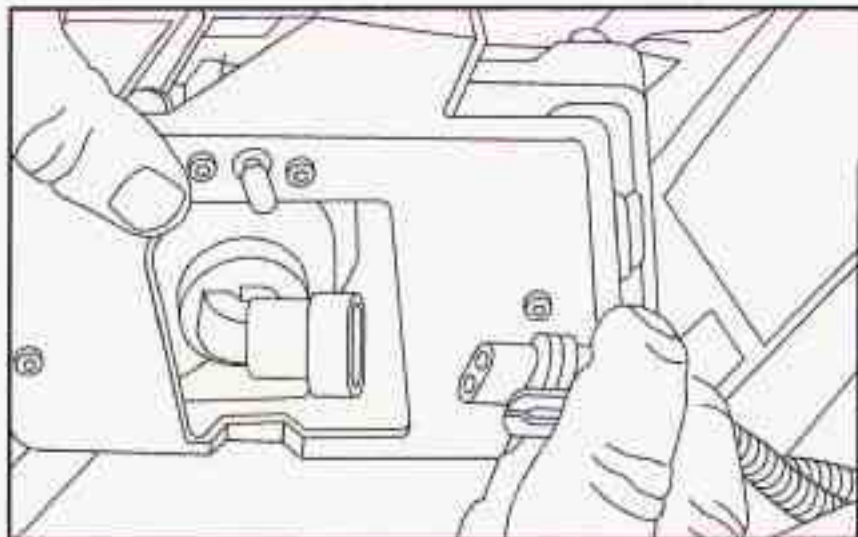

4. Lift the plastic locking tabs on the electrical connector and pull the connector from the headlamp socket.
 - Note which way the socket is pointing before you disconnect it. You'll need to install the new headlamp so the socket points in the same direction.
5. Set the headlamp assembly on a work surface with the lens facing you.

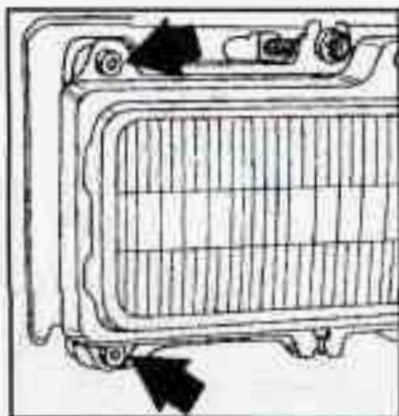

6. Remove the Torx[®] screws at the end of the aiming ring. The aiming ring will swing open like a gate.

7. Remove the aiming ring. Place it face down on the work surface with the aim indicator up.
8. Check that the number on the new headlamp matches the number on the headlamp being replaced. The letter on the headlamp (U or L) must also match.
9. Put the new headlamp in position.
- Make sure the socket points in the same direction as it did with the old headlamp.

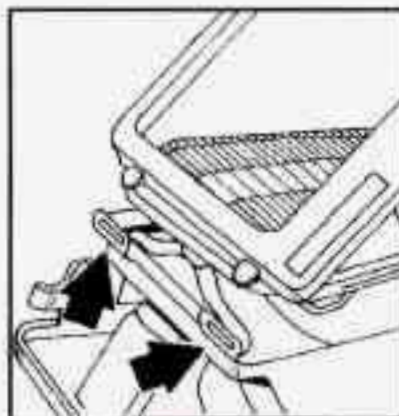

10. Insert the tabs on the aiming ring into the slots in the headlamp assembly.

11. Holding the aiming ring closed, insert the screws at the end of the ring. Tighten the screws until the aiming ring touches the plastic nuts on both the top and bottom.
- Do not overtighten.
 - Do not damage the vertical-aiming bubble.

12. Plug the electrical connector into the headlamp socket. Make sure the locking tabs snap onto the socket.
13. Put the headlamp assembly in position. Make sure the two guide tabs drop into their holes in the headlamp support panel.
14. Tighten the two bottom screws. Make sure the guide tabs are still in place before tightening the screws.
15. Insert the top screw and tighten it.
16. Close the headlamp panel.

Headlamps (4-Door Models)

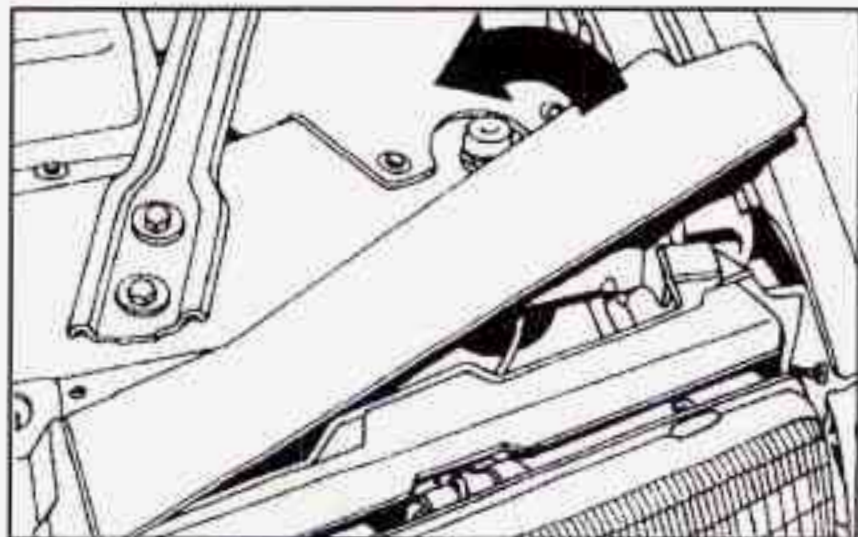

1. Open the headlamp panel.



2. Turn the socket counterclockwise until it pops loose from the housing.

Headlamp Aiming

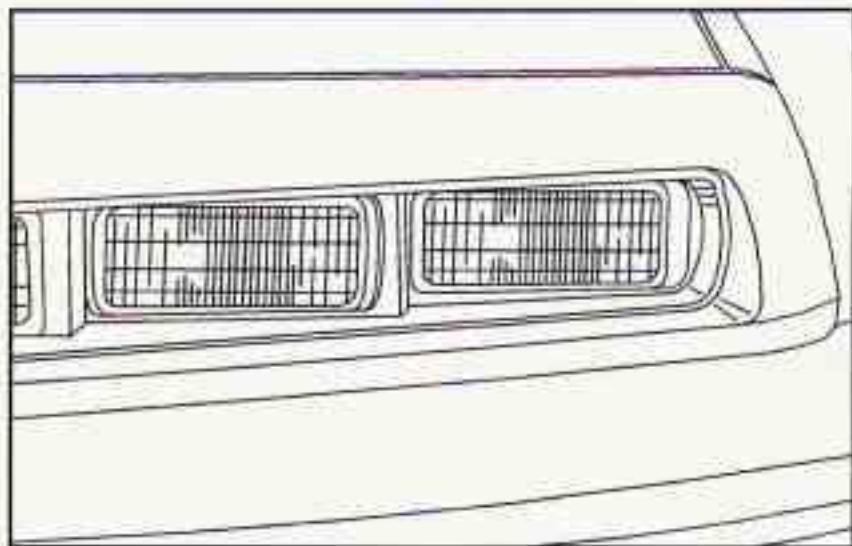

3. Pull out the bulb socket.
4. Lift the plastic locking tab on the electrical connector and pull the connector from the bulb socket.
5. Snap the electrical connector into a new bulb socket.
6. Replace the bulb socket into the housing and turn clockwise.
7. Close the headlamp panel.

This section only applies to two-door Pontiacs. If you have a four-door Pontiac, see your dealer when your headlamp aim needs to be checked or adjusted.

Your vehicle has the 55 x 135 mini-quad headlamp system. These headlamps have horizontal and vertical aim indicators. The aim has been pre-set at the factory and should need no further adjustment.

If your vehicle is damaged in an accident and the headlamp aim seems to be affected, see your Pontiac dealer. Headlamps on damaged vehicles may require recalibration of the horizontal aim by your Pontiac dealer.

To check the aim, the vehicle should be properly prepared as follows:

- The vehicle must have all four tires on a perfectly level surface.
- The vehicle should not have any snow, ice or mud attached to it.
- There should not be any cargo or loading of the vehicle, except it should have a full tank of gas and one person or 160 lbs. (75 kg) on the driver's seat.
- Tires should be properly inflated.

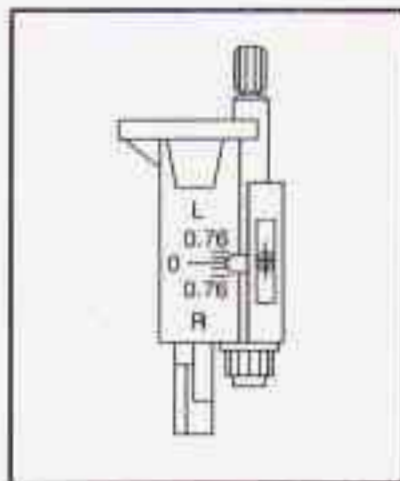

- The horizontal indicator should read "0."

NOTICE:

To make sure your headlamps are aimed properly, read all the instructions before beginning. Failure to follow these instructions could cause damage to headlamp parts.

State inspection stations will allow a vertical reading of plus 0.76 degrees or minus 0.76 degrees from the center of the bubble.

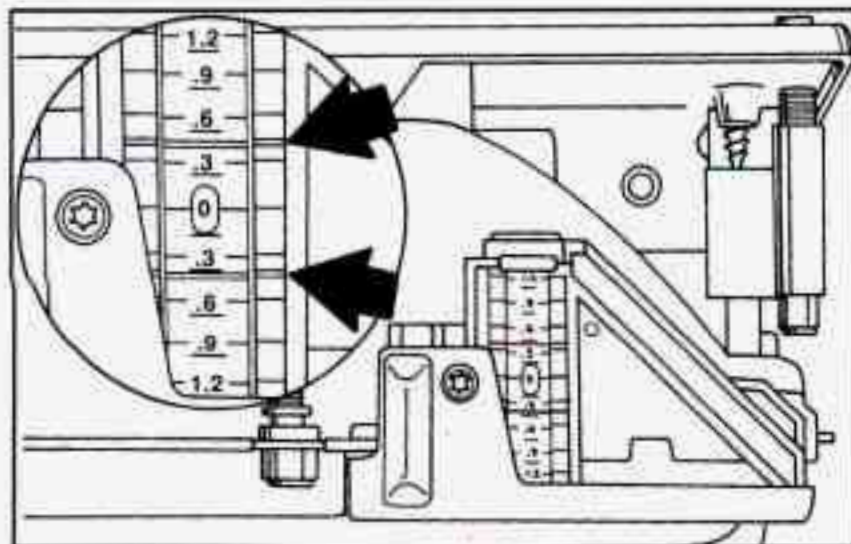

It is recommended that the upper limit not exceed plus 0.4 degrees from the center of the bubble. Other drivers may flash their high beams at you if your adjustment is much above plus 0.4 degrees.

If you find that the headlamp aiming needs adjustment, follow these steps:

Start with the horizontal aim. Don't try to adjust the vertical aim first.

1. Check the horizontal aim indicator. The pointer should be lined up with 0 (zero).

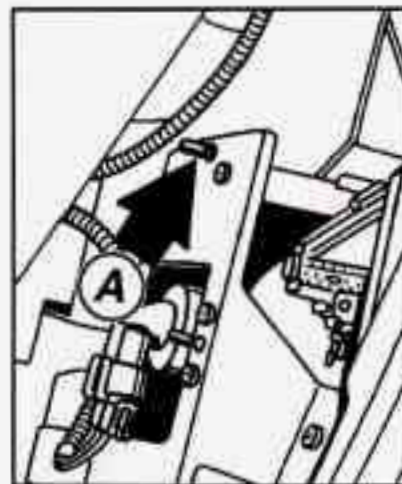

2. If the pointer isn't at 0 (zero), turn the horizontal aiming screw to adjust the aim.

3. Check the vertical aim indicator. The bubble should be centered on 0 (zero).

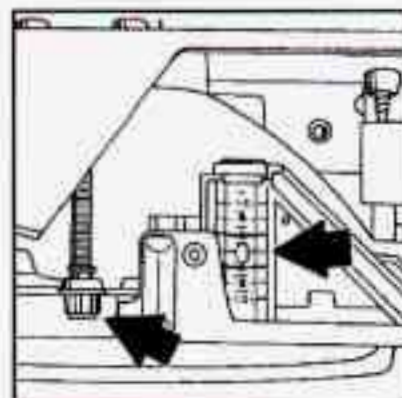

4. If the bubble isn't on 0 (zero), turn the vertical aiming screw to adjust the aim.

Front Lamp Bar (4-Door Models)

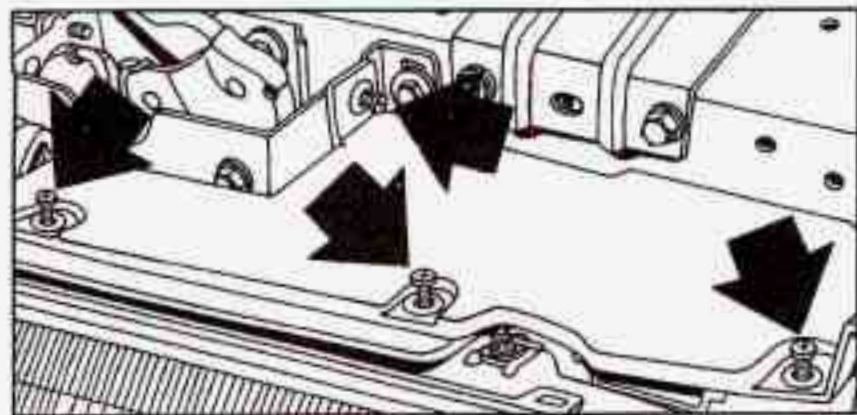

1. Remove the four pins from the cover on the driver's side.

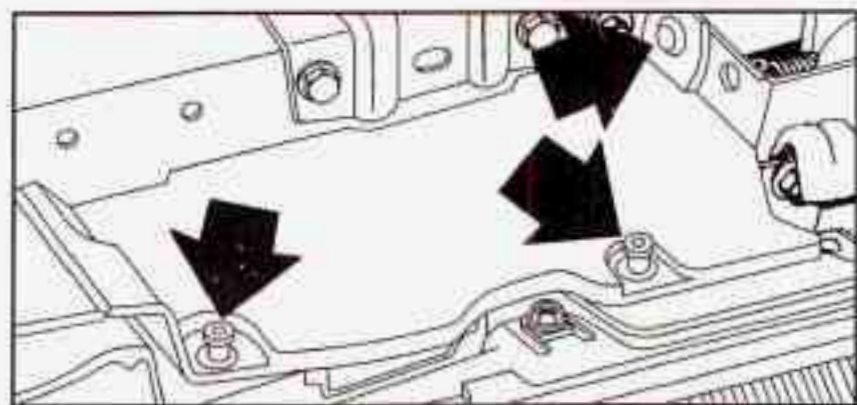

2. Remove the three pins from the cover on the passenger's side.

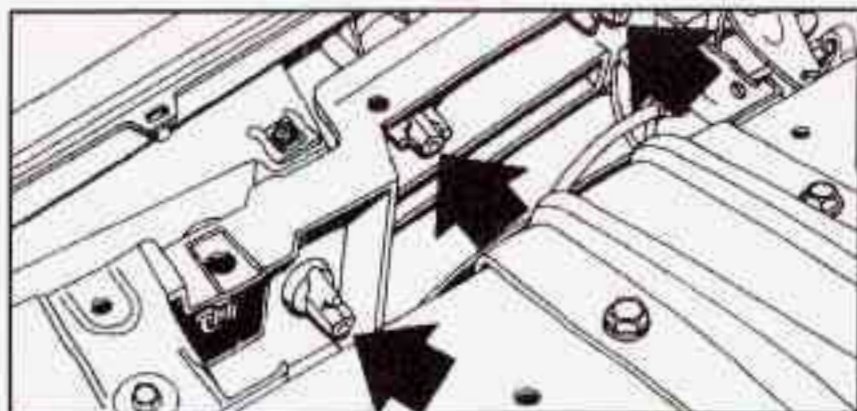

3. Remove the three wing nuts from the lamp bar on the driver's side.

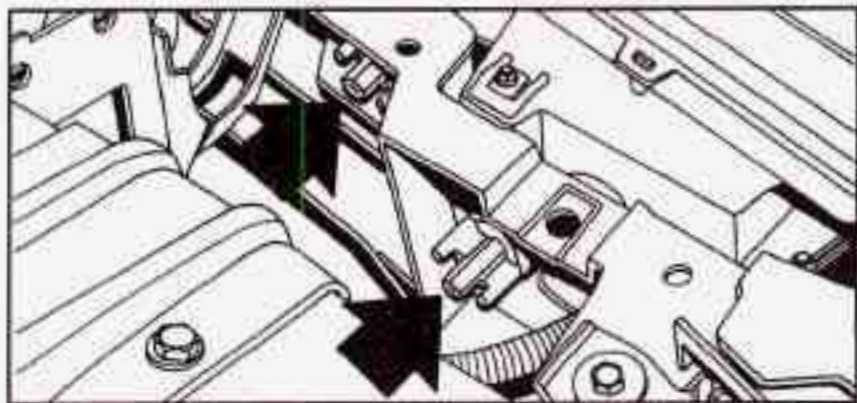

4. Remove the two wing nuts from the lamp bar on the passenger's side.

5. Pull the lamp bar housing away from the body of the vehicle.

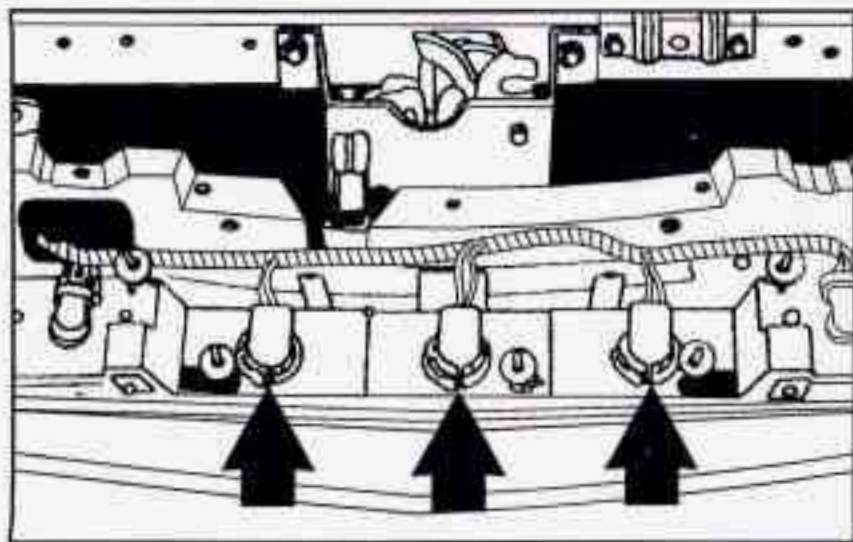

6. Squeeze the tab on the socket and turn the socket counterclockwise.

7. Pull out the socket.
8. Pull the bulb out of the socket.
9. Push in a new bulb.
10. Replace the socket into the lamp bar assembly and turn clockwise.
11. Replace the lamp bar assembly to the body of the vehicle.
12. Install the wing nuts.
13. Put the covers back and install the pins.

Front Sidemarker (4-Door Models)

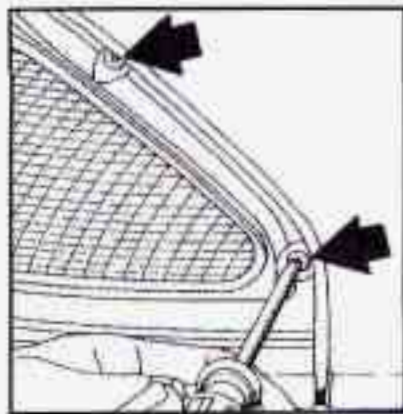

1. Remove the screws and pull the sidemarker housing forward.
2. Turn the socket counterclockwise and pull the socket out of the housing.

3. Pull the bulb out of the socket.
4. Push in a new bulb.
5. Replace the socket into the housing and turn clockwise.
6. Replace the housing to the vehicle.
7. Install the screws.

Front Turn Signal (2-Door Models)

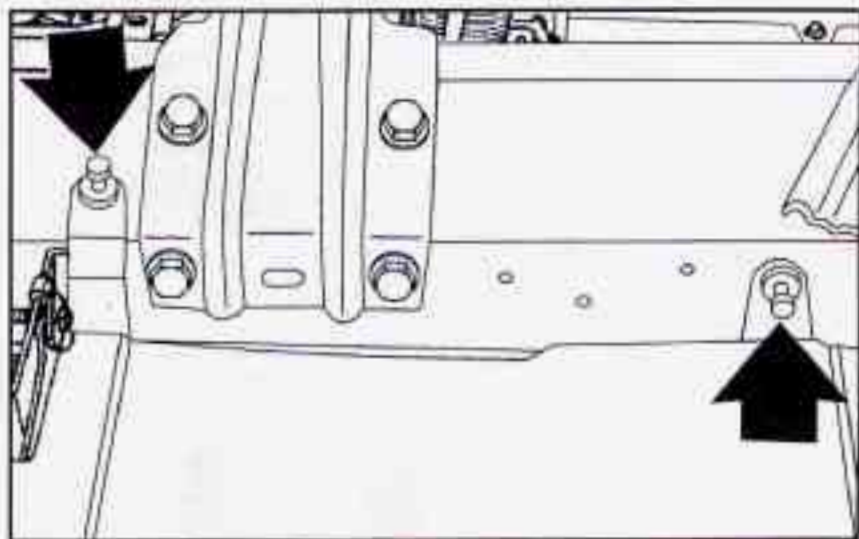

1. Remove the pins from the cover above the turn signal lamps.



2. Turn the socket counterclockwise one-sixth of a turn until it feels loose.

3. Pull out the socket.
4. Pull the bulb out of the socket.
5. Push in a new bulb.
6. Replace the socket into the housing and turn clockwise until it snaps in place.
7. Replace the cover and pins.

Front Turn Signal (4-Door Models)

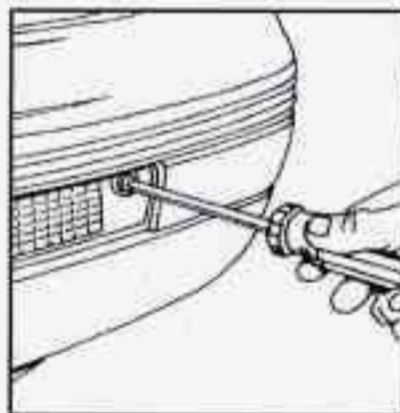

1. Remove the screws and pull the turn signal housing forward.
2. Turn the bulb socket counterclockwise until it pops loose from the housing.

3. Pull out the bulb socket.
4. Lift the plastic locking tab on the electrical connector and pull the connector from the bulb socket.
5. Snap the electrical connector into a new bulb socket.
6. Replace the bulb socket into the housing and turn clockwise.
7. Replace the housing to the vehicle.
8. Install the screws.

Fog Lamps (2-Door Models)

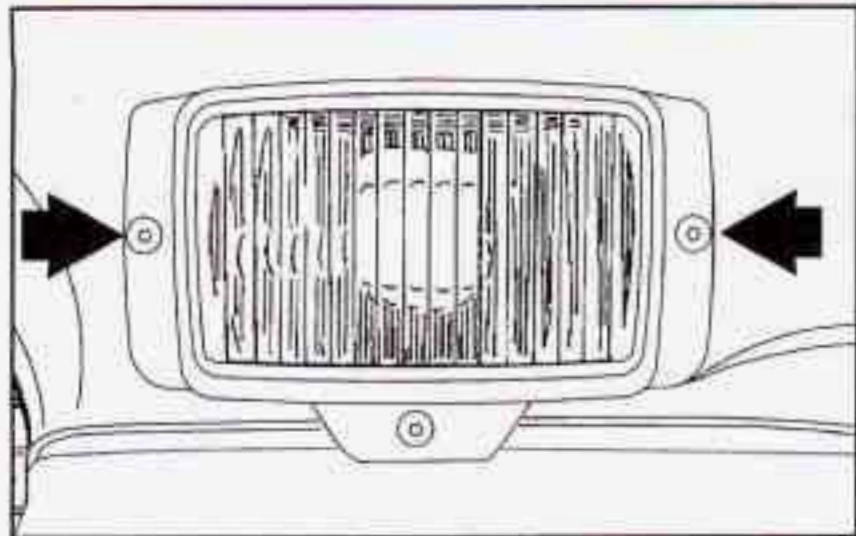

1. Remove the two screws and pull the housing away from the vehicle.

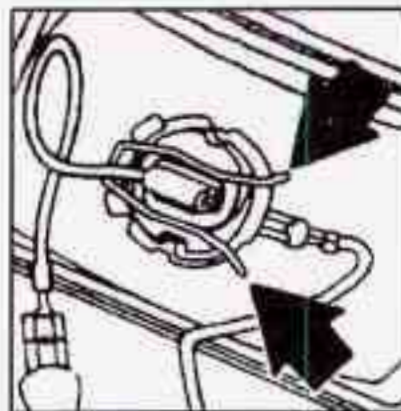

2. Remove the spring clip holding the bulb in the housing and pull out the bulb.

3. Disconnect the electrical connector from the bulb.
4. Connect the electrical connector to a new bulb.
5. Replace the bulb in the housing and install the spring clip.
6. Replace the housing to the vehicle.
7. Install the screws.

Fog Lamps (4-Door Models)

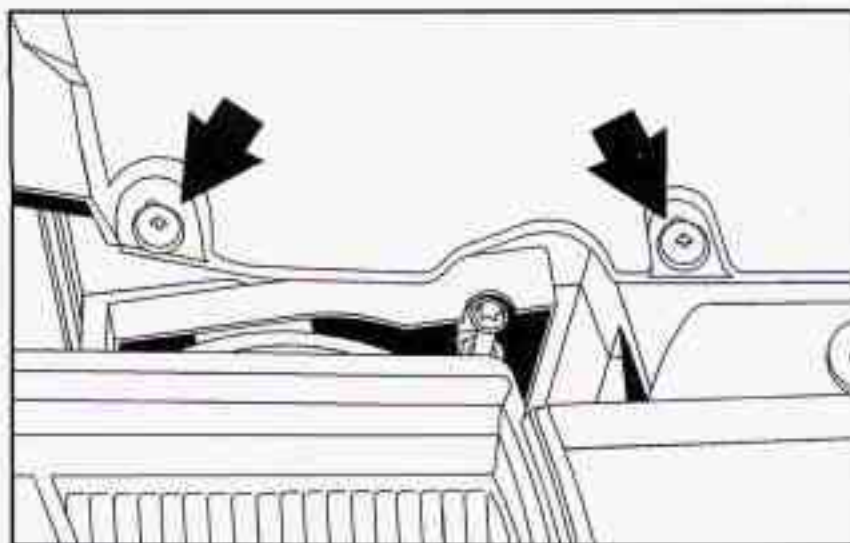

1. Remove the pins from the cover above the fog lamps.

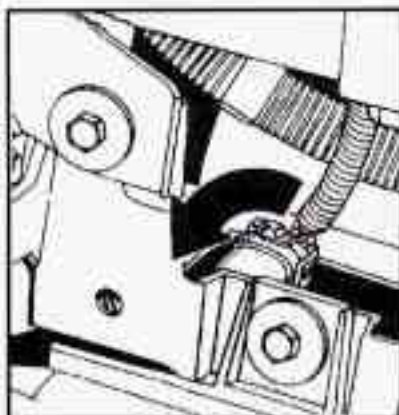

2. Turn the bulb socket counterclockwise until it pops loose from the housing.
3. Pull out the bulb socket.
4. Lift the plastic locking tab on the electrical connector and pull the connector from the bulb socket.
5. Snap the electrical connector into a new bulb socket.
6. Install the screws.
7. Replace the socket into the housing and turn clockwise until it snaps in place.
8. Replace the cover and pins.

Center High-Mounted Stoplamp (2-Door Models)

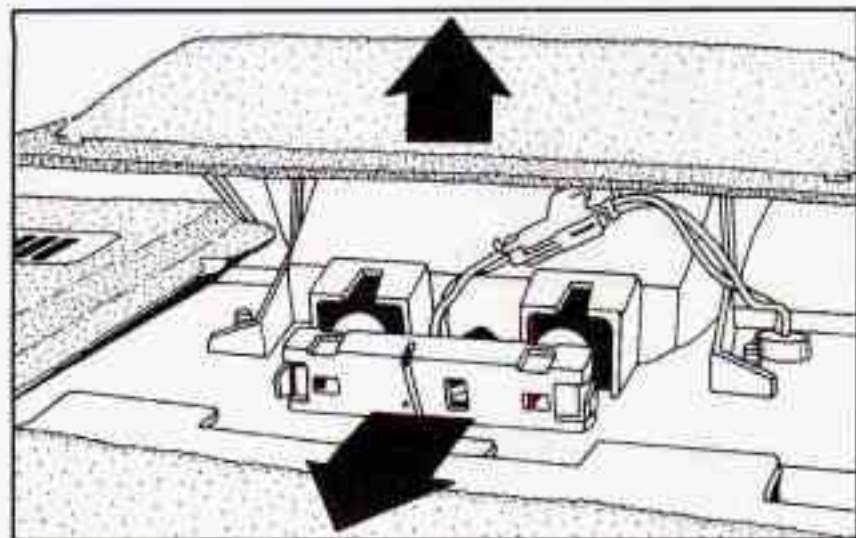

1. Remove two screws and the cover.
2. Unclip the bulb carrier and pull it out.
 - To remove the stoplamp lens to clean the window, remove the two nuts on either side of the housing.

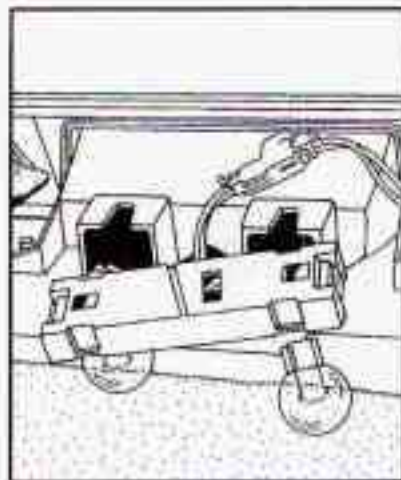

3. Pull out the bulb.

4. Push in a new bulb.
5. Clip the bulb carrier back into place.
6. Replace the cover and screws.

Center High-Mounted Stoplamp (4-Door Models)

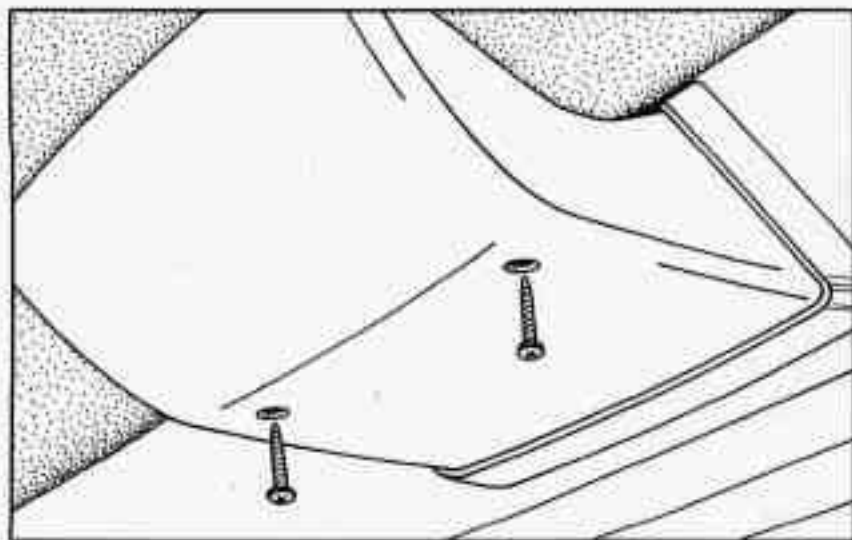

1. Remove the two screws from the cover.
2. Pull down the cover.

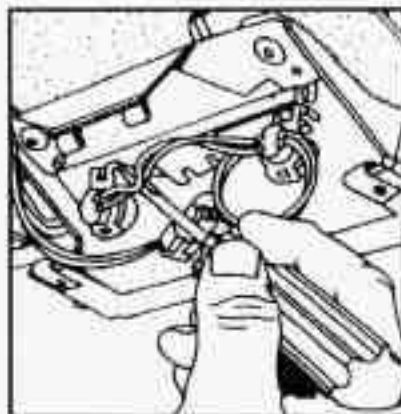

3. Lift the tabs at the top and bottom of the socket and pull it from the housing.
4. Pull out the bulb.
5. Push in a new bulb.
6. Push the socket back into the housing. Make sure the tabs snap in place.
7. Replace the cover and screws.

Taillamps



1. Remove the plastic retainers and pull the carpet away from the rear of the trunk.

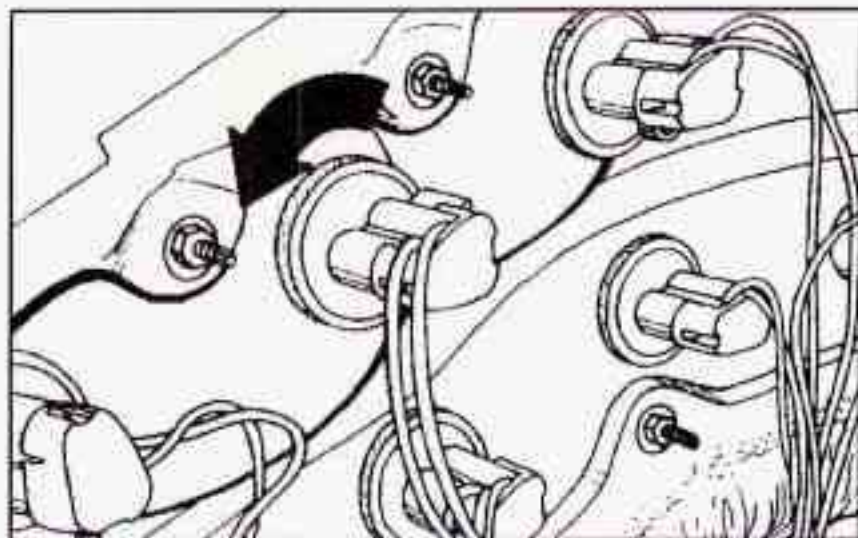

2. If the socket has a tab, squeeze it. Turn the socket counterclockwise.
3. Pull out the socket.
4. Pull the bulb out of the socket.
5. Push in a new bulb.
6. Replace the socket into the housing and turn clockwise.
7. Reposition the carpet and install the plastic retainers.

Rear Lamp Bar

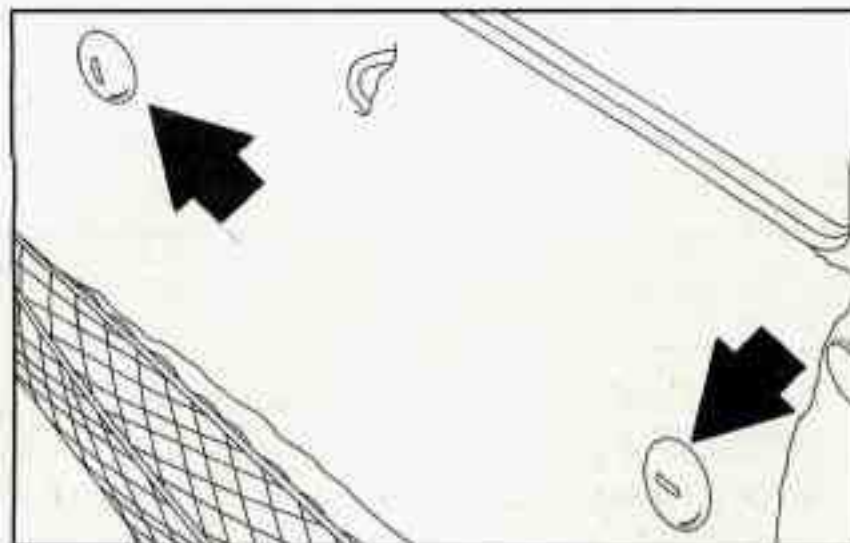

1. Remove the plastic retainers and pull the carpet away from the rear of the trunk.
2. Remove the wing nuts.
3. Pull the housing away from the body of the vehicle.



4. Turn the socket counterclockwise until it pops loose from the housing.
5. Pull out the socket.
6. Pull the bulb out of the socket.
7. Push in a new bulb.
8. Replace the socket into the housing and turn clockwise.
9. Replace the housing to the body of the vehicle.
10. Install the wing nuts.
11. Reposition the carpet and install the plastic retainers.

Windshield Wiper Blade Replacement

1. Pull the windshield wiper arm away from the windshield.

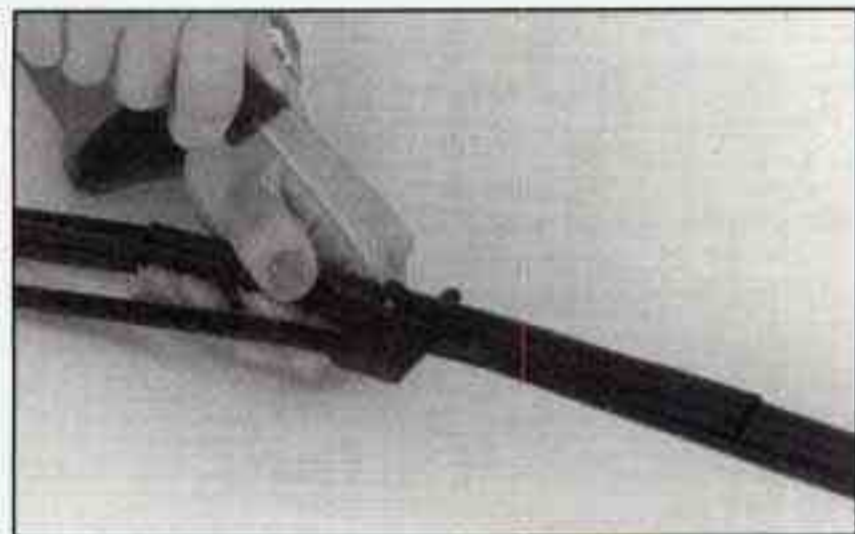

2. Lift the release clip with a screwdriver and pull the blade off the wiper arm.
3. Push the new wiper blade securely onto the wiper arm.

For information on replacement blade length and type, see "Replacement Parts" in the Index.

Tires

We don't make tires. Your new Pontiac comes with high-quality tires made by a leading tire manufacturer. If you ever have questions about your tire warranty and where to obtain service, see your Pontiac Warranty booklet for details.

CAUTION:

Poorly maintained and improperly used tires are dangerous.

- Overloading your tires can cause overheating as a result of too much friction. You could have an air-out and a serious accident. See "Loading Your Vehicle" in the Index.

CAUTION: (Continued)

CAUTION: (Continued)

- Underinflated tires pose the same danger as overloaded tires. The resulting accident could cause serious injury. Check all tires frequently to maintain the recommended pressure. Tire pressure should be checked when your tires are cold.
- Overinflated tires are more likely to be cut, punctured or broken by a sudden impact -- such as when you hit a pothole. Keep tires at the recommended pressure.
- Worn, old tires can cause accidents. If your tread is badly worn, or if your tires have been damaged, replace them.

Inflation -- Tire Pressure

The Tire-Loading Information label, located on the inside of the trunk lid, shows the correct inflation pressures for your tires when they're cold. "Cold" means your vehicle has been sitting for at least three hours or driven no more than 1 mile (1.6 km).

NOTICE:

Don't let anyone tell you that underinflation or overinflation is all right. It's not. If your tires don't have enough air (underinflation), you can get the following:

- Too much flexing
- Too much heat
- Tire overloading
- Bad wear
- Bad handling
- Bad fuel economy.

If your tires have too much air (overinflation), you can get the following:

- Unusual wear
- Bad handling
- Rough ride
- Needless damage from road hazards.

When to Check

Check your tires once a month or more.

Don't forget your compact spare tire. It should be at 60 psi (420 kPa).

How to Check

Use a good quality pocket-type gage to check tire pressure. You can't tell if your tires are properly inflated simply by looking at them. Radial tires may look properly inflated even when they're underinflated.

Be sure to put the valve caps back on the valve stems. They help prevent leaks by keeping out dirt and moisture.

Tire Inspection and Rotation

Tires should be inspected every 6,000 to 8,000 miles (10,000 to 13,000 km) for any signs of unusual wear. If unusual wear is present, rotate your tires as soon as possible and check wheel alignment. Also check for damaged tires or wheels. See "When It's Time for New Tires" and "Wheel Replacement" later in this section for more information.

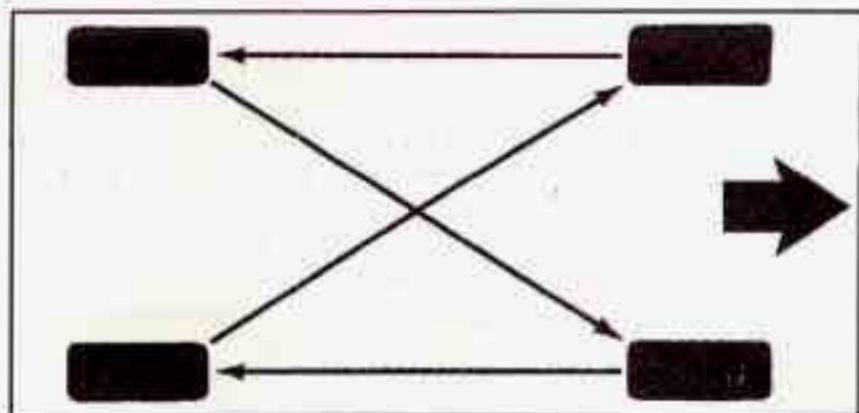

The purpose of regular rotation is to achieve more uniform wear for all tires on the vehicle. The first rotation is the most important. See "Scheduled Maintenance Services" in the Index for scheduled rotation intervals.

When rotating your tires, always use the correct rotation pattern shown here.

Don't include the compact spare tire in your tire rotation.

After the tires have been rotated, adjust the front and rear inflation pressures as shown on the Tire-Loading Information label. Make certain that all wheel nuts are properly tightened. See "Wheel Nut Torque" in the Index.

CAUTION:

Rust or dirt on a wheel, or on the parts to which it is fastened, can make wheel nuts become loose after a time. The wheel could come off and cause an accident. When you change a wheel, remove any rust or dirt from places where the wheel attaches to the vehicle. In an emergency, you can use a cloth or a paper towel to do this; but be sure to use a scraper or wire brush later, if you need to, to get all the rust or dirt off. (See "Changing a Flat Tire" in the Index.)

When It's Time for New Tires

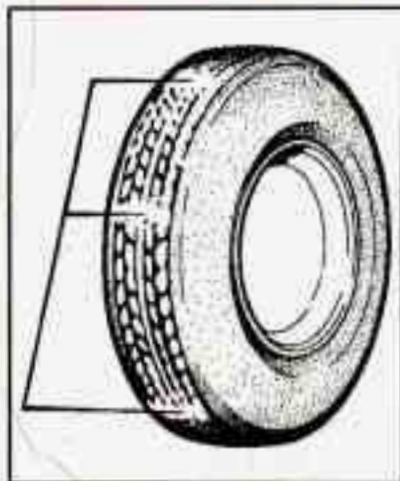

One way to tell when it's time for new tires is to check the treadwear indicators, which will appear when your tires have only 1/16 inch (1.6 mm) or less of tread remaining.

You need a new tire if any of the following statements are true:

- You can see the indicators at three or more places around the tire.
- You can see cord or fabric showing through the tire's rubber.
- The tread or sidewall is cracked, cut or snagged deep enough to show cord or fabric.
- The tire has a bump, bulge or split.
- The tire has a puncture, cut or other damage that can't be repaired well because of the size or location of the damage.

Buying New Tires

To find out what kind and size of tires you need, look at the Tire-Loading Information label.

The tires installed on your vehicle when it was new had a Tire Performance Criteria Specification (TPC Spec) number on each tire's sidewall. When you get new tires, get ones with that same TPC Spec number. That way your vehicle will continue to have tires that are designed to give proper endurance, handling, speed rating, traction, ride and other things during normal service on your vehicle. If your tires have an all-season tread design, the TPC number will be followed by an "MS" (for mud and snow).

If you ever replace your tires with those not having a TPC Spec number, make sure they are the same size, load range, speed rating and construction type (bias, bias-belted or radial) as your original tires.



CAUTION:

Mixing tires could cause you to lose control while driving. If you mix tires of different sizes or types (radial and bias-belted tires), the vehicle may not handle properly, and you could have a crash.

Using tires of different sizes may also cause damage to your vehicle. Be sure to use the same size and type tires on all wheels.

It's all right to drive with your compact spare, though. It was developed for use on your vehicle.

Uniform Tire Quality Grading

The following information relates to the system developed by the United States National Highway Traffic Safety Administration, which grades tires by treadwear, traction and temperature performance. (This applies only to vehicles sold in the United States.) The grades are molded on the sidewalls of most passenger car tires. The Uniform Tire Quality Grading system does not apply to deep tread, winter-type snow tires, space-saver or temporary use spare tires, tires with nominal rim diameters of 10 to 12 inches (25 to 30 cm), or to some limited-production tires.

While the tires available on General Motors passenger cars and light trucks may vary with respect to these grades, they must also conform to Federal safety requirements and additional General Motors Tire Performance Criteria (TPC) standards.

Treadwear

The treadwear grade is a comparative rating based on the wear rate of the tire when tested under controlled conditions on a specified government test course. For example, a tire graded 150 would wear one and a half (1 1/2) times as well on the government course as a tire graded 100. The relative performance of tires depends upon the actual conditions of their use, however, and may depart significantly from the norm due to variations in driving habits, service practices and differences in road characteristics and climate.

Traction -- A, B, C

The traction grades, from highest to lowest, are A, B, and C, and they represent the tire's ability to stop on wet pavement as measured under controlled conditions on specified government test surfaces of asphalt and concrete. A tire marked C may have poor traction performance.

Warning: The traction grade assigned to this tire is based on braking (straightahead) traction tests and does not include cornering (turning) traction.

Temperature -- A, B, C

The temperature grades are A (the highest), B, and C, representing the tire's resistance to the generation of heat and its ability to dissipate heat when tested under controlled conditions on a specified indoor laboratory test wheel. Sustained high temperature can cause the material of the tire to degenerate and reduce tire life, and excessive temperature can lead to sudden tire failure. The grade C corresponds to a level of performance which all passenger car tires must meet under the Federal Motor Vehicle Safety Standard No. 109. Grades B and A represent higher levels of performance on the laboratory test wheel than the minimum required by law.

Warning: The temperature grade for this tire is established for a tire that is properly inflated and not overloaded. Excessive speed, underinflation, or excessive loading, either separately or in combination, can cause heat buildup and possible tire failure.

Wheel Alignment and Tire Balance

The wheels on your vehicle were aligned and balanced carefully at the factory to give you the longest tire life and best overall performance.

In most cases, you will not need to have your wheels aligned again. However, if you notice unusual tire wear or your vehicle pulling one way or the other, the alignment may need to be reset. If you notice your vehicle vibrating when driving on a smooth road, your wheels may need to be rebalanced.

Wheel Replacement

Replace any wheel that is bent, cracked, or badly rusted or corroded. If wheel nuts keep coming loose, the wheel, wheel bolts and wheel nuts should be replaced. If the wheel leaks air, replace it (except some aluminum wheels, which can sometimes be repaired). See your Pontiac dealer if any of these conditions exist.

Your dealer will know the kind of wheel you need.

Each new wheel should have the same load-carrying capacity, diameter, width, offset and be mounted the same way as the one it replaces.

If you need to replace any of your wheels, wheel bolts or wheel nuts, replace them only with new GM original equipment parts. This way, you will be sure to have the right wheel, wheel bolts and wheel nuts for your Pontiac model.



CAUTION:

Using the wrong replacement wheels, wheel bolts or wheel nuts on your vehicle can be dangerous. It could affect the braking and handling of your vehicle, make your tires lose air and make you lose control. You could have a collision in which you or others could be injured. Always use the correct wheel, wheel bolts and wheel nuts for replacement.

NOTICE:

The wrong wheel can also cause problems with bearing life, brake cooling, speedometer or odometer calibration, headlamp aim, bumper height, vehicle ground clearance and tire or tire chain clearance to the body and chassis.

See "Changing a Flat Tire" in the Index for more information.

Used Replacement Wheels



CAUTION:

Putting a used wheel on your vehicle is dangerous. You can't know how it's been used or how many miles it's been driven. It could fail suddenly and cause an accident. If you have to replace a wheel, use a new GM original equipment wheel.

NOTICE:

If your Pontiac has P215/60R16 or P225/60R16 size tires, don't use tire chains. They can damage your vehicle.

If you have other tires, use tire chains only where legal and only when you must. Use only SAE Class "S" type chains that are the proper size for your tires. Install them on the front tires and tighten them as tightly as possible with the ends securely fastened. Drive slowly and follow the chain manufacturer's instructions. If you can hear the chains contacting your vehicle, stop and retighten them. If the contact continues, slow down until it stops. Driving too fast or spinning the wheels with chains on will damage your vehicle.

Appearance Care

Remember, cleaning products can be hazardous. Some are toxic. Others can burst into flame if you strike a match or get them on a hot part of the vehicle. Some are dangerous if you breathe their fumes in a closed space. When you use anything from a container to clean your Pontiac, be sure to follow the manufacturer's warnings and instructions. And always open your doors or windows when you're cleaning the inside.

Never use these to clean your vehicle:

- Gasoline
- Benzene
- Naphtha
- Carbon Tetrachloride
- Acetone
- Paint Thinner
- Turpentine
- Lacquer Thinner
- Nail Polish Remover

They can all be hazardous -- some more than others -- and they can all damage your vehicle, too.

Don't use any of these unless this manual says you can. In many uses, these will damage your vehicle:

- Alcohol
- Laundry Soap
- Bleach
- Reducing Agents

Cleaning the Inside of Your Pontiac

Use a vacuum cleaner often to get rid of dust and loose dirt. Wipe vinyl or leather with a clean, damp cloth.

Your Pontiac dealer has two GM cleaners, a solvent-type spot lifter and a foam-type powdered cleaner. They will clean normal spots and stains very well. Do not use them on vinyl or leather.

Here are some cleaning tips:

- Always read the instructions on the cleaner label.
- Clean up stains as soon as you can -- before they set.
- Use a clean cloth or sponge, and change to a clean area often. A soft brush may be used if stains are stubborn.
- Use solvent-type cleaners in a well-ventilated area only. If you use them, don't saturate the stained area.

- If a ring forms after spot cleaning, clean the entire area immediately or it will set.

Using Foam-Type Cleaner on Fabric

1. Vacuum and brush the area to remove any loose dirt.
2. Always clean a whole trim panel or section. Mask surrounding trim along stitch or welt lines.
3. Mix Multi-Purpose Powdered Cleaner following the directions on the container label.
4. Use suds only and apply with a clean sponge.
5. Don't saturate the material.
6. Don't rub it roughly.
7. As soon as you've cleaned the section, use a sponge to remove the suds.
8. Rinse the section with a clean, wet sponge.
9. Wipe off what's left with a slightly damp paper towel or cloth.
10. Then dry it immediately with a blow dryer.
11. Wipe with a clean cloth.

Using Solvent-Type Cleaner on Fabric

First, see if you have to use solvent-type cleaner at all. Some spots and stains will clean off better with just water and mild soap.

If you need to use a solvent:

- Gently scrape excess soil from the trim material with a clean, dull knife or scraper. Use very little cleaner, light pressure and clean cloths (preferably cheesecloth). Cleaning should start at the outside of the stain, "feathering" toward the center. Keep changing to a clean section of the cloth.
- When you clean a stain from fabric, immediately dry the area with a blow dryer to help prevent a cleaning ring.

Special Cleaning Problems

Greasy or Oily Stains

Stains caused by grease, oil, butter, margarine, shoe polish, coffee with cream, chewing gum, cosmetic creams, vegetable oils, wax crayon, tar and asphalt can be removed as follows:

1. Carefully scrape off excess stain.
2. Follow the solvent-type instructions described earlier.

3. Shoe polish, wax crayon, tar and asphalt will stain if left on a vehicle's seat fabric. They should be removed as soon as possible. Be careful, because the cleaner will dissolve them and may cause them to spread.

Non-Greasy Stains

Stains caused by catsup, coffee (black), egg, fruit, fruit juice, milk, soft drinks, wine, vomit, urine and blood can be removed as follows:

1. Carefully scrape off excess stain, then sponge the soiled area with cool water.
2. If a stain remains, follow the foam-type instructions described earlier.
3. If an odor lingers after cleaning vomit or urine, treat the area with a water/baking soda solution: 1 teaspoon (5 ml) of baking soda to 1 cup (250 ml) of lukewarm water.
4. If needed, clean lightly with solvent-type cleaner.

Combination Stains

Stains caused by candy, ice cream, mayonnaise, chili sauce and unknown stains can be removed as follows:

- Carefully scrape off excess stain, then clean with cool water and allow to dry.
- If a stain remains, clean it with solvent-type cleaner.

Cleaning Vinyl

Use warm water and a clean cloth.

- Rub with a clean, damp cloth to remove dirt. You may have to do it more than once.
- Things like tar, asphalt and shoe polish will stain if you don't get them off quickly. Use a clean cloth and a GM Vinyl/Leather Cleaner or an equivalent product.

Cleaning Leather

Use a soft cloth with lukewarm water and a mild soap or saddle soap.

- For stubborn stains, use a GM Vinyl/Leather Cleaner or an equivalent product.
- *Never* use oils, varnishes, solvent-based or abrasive cleaners, furniture polish or shoe polish on leather.
- Soiled leather should be cleaned immediately. If dirt is allowed to work into the finish, it can harm the leather.

Cleaning the Top of the Instrument Panel

Use only mild soap and water to clean the top surfaces of the instrument panel. Sprays containing silicones or waxes may cause annoying reflections in the windshield and even make it difficult to see through the windshield under certain conditions.

Care of Safety Belts

Keep belts clean and dry.

CAUTION:

Do not bleach or dye safety belts. If you do, it may severely weaken them. In a crash, they might not be able to provide adequate protection. Clean safety belts only with mild soap and lukewarm water.

Glass

Glass should be cleaned often. GM Glass Cleaner (GM Part No. 1050427) or a liquid household glass cleaner will remove normal tobacco smoke and dust films.

Don't use abrasive cleaners on glass, because they may cause scratches. Avoid placing decals on the inside rear window, since they may have to be scraped off later. If abrasive cleaners are used on the inside of the rear window, an electric defogger element may be damaged. Any temporary license should not be attached across the defogger grid.

Cleaning the Outside of the Windshield and Wiper Blades

If the windshield is not clear after using the windshield washer, or if the wiper blade chatters when running, wax or other material may be on the blade or windshield.

Clean the outside of the windshield with GM Windshield Cleaner, Bon-Ami Powder[®] (GM Part No. 1050011). The windshield is clean if beads do not form when you rinse it with water.

Clean the blade by wiping vigorously with a cloth soaked in full-strength windshield washer solvent. Then rinse the blade with water.

Wiper blades should be checked on a regular basis and replaced when worn.

Weatherstrips

Silicone grease on weatherstrips will make them last longer, seal better, and not stick or squeak. Apply silicone grease with a clean cloth at least every six months. During very cold, damp weather more frequent application may be required. (See "Recommended Fluids and Lubricants" in the Index.)

Cleaning the Outside of Your Pontiac

The paint finish on your vehicle provides beauty, depth of color, gloss retention and durability.

Washing Your Vehicle

The best way to preserve your vehicle's finish is to keep it clean by washing it often with lukewarm or cold water.

Don't wash your vehicle in the direct rays of the sun. Don't use strong soaps or chemical detergents. Use liquid hand, dish or car washing (mild detergent) soaps. Don't use cleaning agents that are petroleum based, or that contain acid or abrasives. All cleaning agents should be flushed promptly and not allowed to dry on the surface, or they could stain. Dry the finish with a soft, clean chamois or a 100% cotton towel to avoid surface scratches and water spotting.

High pressure car washes may cause water to enter your vehicle.

Finish Care

Occasional waxing or mild polishing of your Pontiac by hand may be necessary to remove residue from the paint finish. You can get GM-approved cleaning products from your dealer. (See "Appearance Care and Materials" in the Index.)

Your Pontiac has a "basecoat/clearcoat" paint finish. The clearcoat gives more depth and gloss to the colored basecoat. Always use waxes and polishes that are non-abrasive and made for a basecoat/clearcoat paint finish.

NOTICE:

Machine compounding or aggressive polishing on a basecoat/clearcoat paint finish may dull the finish or leave swirl marks.

Foreign materials such as calcium chloride and other salts, ice melting agents, road oil and tar, tree sap, bird droppings, chemicals from industrial chimneys, etc., can damage your vehicle's finish if they remain on painted surfaces. Wash the vehicle as soon as possible.

If necessary, use non-abrasive cleaners that are marked safe for painted surfaces to remove foreign matter.

Exterior painted surfaces are subject to aging, weather and chemical fallout that can take their toll over a period of years. You can help to keep the paint finish looking new by keeping your Pontiac garaged or covered whenever possible.

Aluminum Wheels (If So Equipped)

Keep your wheels clean using a soft clean cloth with mild soap and water. Rinse with clean water. After rinsing thoroughly, dry with a soft clean towel. A wax may then be applied.

The surface of these wheels is similar to the painted surface of your vehicle. Don't use strong soaps, chemicals, abrasive polishes, abrasive cleaners or abrasive cleaning brushes on them because you could damage the surface.

Don't take your vehicle through an automatic car wash that has silicon carbide tire cleaning brushes. These brushes can also damage the surface of these wheels.

Tires

To clean your tires, use a stiff brush with a tire cleaner.

NOTICE:

When applying a tire dressing always take care to wipe off any overspray or splash from all painted surfaces on the body or wheels of the vehicle. Petroleum-based products may damage the paint finish.

Sheet Metal Damage

If your vehicle is damaged and requires sheet metal repair or replacement, make sure the body repair shop applies anti-corrosion material to the parts repaired or replaced to restore corrosion protection.

Finish Damage

Any stone chips, fractures or deep scratches in the finish should be repaired right away. Bare metal will corrode quickly and may develop into a major repair expense.

Minor chips and scratches can be repaired with touch-up materials available from your dealer or other service outlets. Larger areas of finish damage can be corrected in your dealer's body and paint shop.

Underbody Maintenance

Chemicals used for ice and snow removal and dust control can collect on the underbody. If these are not removed, accelerated corrosion (rust) can occur on the underbody parts such as fuel lines, frame, floor pan and exhaust system even though they have corrosion protection.

At least every spring, flush these materials from the underbody with plain water. Clean any areas where mud and other debris can collect. Dirt packed in closed areas of the frame should be loosened before being flushed. Your dealer or an underbody car washing system can do this for you.

Chemical Paint Spotting

Some weather and atmospheric conditions can create a chemical fallout. Airborne pollutants can fall upon and attack painted surfaces on your vehicle. This damage can take two forms: blotchy, ringlet-shaped discolorations, and small irregular dark spots etched into the paint surface.

Although no defect in the paint job causes this, Pontiac will repair, at no charge to the owner, the surfaces of new vehicles damaged by this fallout condition within 12 months or 12,000 miles (20 000 km) of purchase, whichever occurs first.

Appearance Care Materials Chart

PART NUMBER	SIZE	DESCRIPTION	USAGE
1050004	2.75 sq. ft.	Chamois	Shines vehicle without scratching
1050172	16 oz. (0.473 L)	Tar and Road Oil Remover	Also removes old waxes and polishes
1050173	16 oz. (0.473 L)	Chrome Cleaner and Polish	Removes rust and corrosion
1050174	16 oz. (0.473 L)	White Sidewall Tire Cleaner	Removes soil and black marks
1050201	16 oz. (0.473 L)	Magic Mirror Cleaner Polish	Exterior cleaner and polish
1050214	32 oz. (0.946 L)	Vinyl and Leather Cleaner	Spot and stain removal
1050427	23 oz. (0.680 L)	Glass Cleaner	Cleans grease, grime and smoke film
1050429	6 lbs. (2.72 kg)	Multi-Purpose Powdered Cleaner	Cleans vinyl, cloth, tires and mats
1051398*	8 oz. (0.237 L)	Spot Lifter	For cloth
1051515	32 oz. (0.946 L)	Optikleen	Windshield washer solvent and antifreeze
1052870	16 oz. (0.473 L)	Wash and Wax Concentrate	Exterior wash
1052918**	8 oz. (0.237 L)	Armor All™ Protector	Protects vinyl, leather and rubber
1052929	16 oz. (0.473 L)	Wheel Cleaner	Spray on wheel cleaner
1052930	8 oz. (0.237 L)	Capture Dry Spot Remover	Attracts and absorbs soils
12345002**	16 oz. (0.473 L)	Armor All™ Cleaner	Cleans vinyl, leather and rubber
12345725	12 oz. (0.354 L)	Silicone Tire Shine	Shines tires

See your General Motors Parts Department for these products.
See "Fluids and Lubricants" in the Index.

* Not recommended for pigskin suede leather.
** Not recommended for use on instrument panel vinyl.

Vehicle Identification Number (VIN)

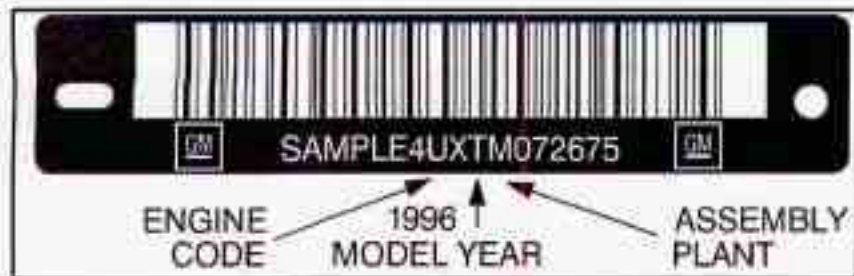

This is the legal identifier for your Pontiac. It appears on a plate in the front corner of the instrument panel, on the driver's side. You can see it if you look through the windshield from outside your vehicle. The VIN also appears on the Vehicle Certification and Service Parts labels and the certificates of title and registration.

Engine Identification

The eighth character in your VIN is the engine code. This code will help you identify your engine, specifications and replacement parts.

Service Parts Identification Label

You'll find this label on your spare tire cover. It's very helpful if you ever need to order parts. On this label is:

- your VIN,
- the model designation,
- paint information, and
- a list of all production options and special equipment.

Be sure that this label is not removed from the vehicle.

Electrical System

Add-On Electrical Equipment

NOTICE:

Don't add anything electrical to your Pontiac unless you check with your dealer first. Some electrical equipment can damage your vehicle and the damage wouldn't be covered by your warranty. Some add-on electrical equipment can keep other components from working as they should.

Your vehicle has an air bag system. Before attempting to add anything electrical to your Pontiac, see "Servicing Your Air Bag-Equipped Pontiac" in the Index.

Headlamp Wiring

The headlamp wiring is protected by a circuit breaker in the underhood electrical center. An electrical overload will cause the lamps to go on and off, or in some cases to remain off. If this happens, have your headlamp system checked right away.

Windshield Wipers

The windshield wiper motor is protected by a circuit breaker and a fuse. If the motor overheats due to heavy snow, etc., the wiper will stop until the motor cools. If the overload is caused by some electrical problem, have it fixed.

Power Windows and Other Power Options

Circuit breakers in the fuse panel protect the power windows and other power accessories. When the current load is too heavy, the circuit breaker opens and closes, protecting the circuit until the problem is fixed.

Fuses and Circuit Breakers

The wiring circuits in your vehicle are protected from short circuits by a combination of fuses, circuit breakers, and fusible thermal links in the wiring itself. This greatly reduces the chance of fires caused by electrical problems.

Look at the silver-colored band inside the fuse. If the band is broken or melted, replace the fuse. Be sure you replace a bad fuse with a new one of the identical size and rating.

Instrument Panel Fuse Block



The fuses are in a fuse block on the passenger's side of the instrument panel. Pull off the cover labeled FUSES to expose the fuses.

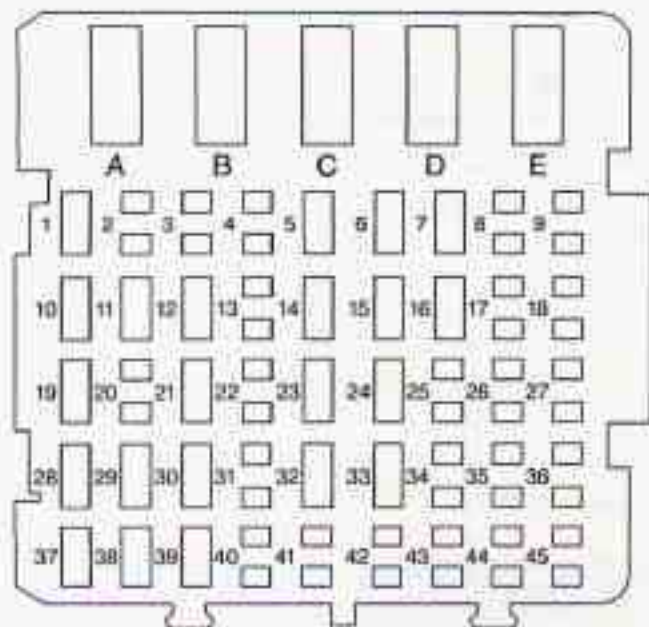

Fuse	Description
1	CIGARETTE LIGHTER -- Instrument Panel Cigarette Lighter
3	DRL MDL
4	HVAC #2 -- HVAC Control Assembly Solenoid Box
5	HAZARD FLASHER
6	POWER ACCESSORY #2 -- Sunroof Control Unit
7	LOCK CONTROL -- Door Lock Relay
10	I/P ELECTRONICS BATTERY FEED -- Chime Module, Electronic Brake Control Module (EBCM), Theft-Deterrent Module, Radio, Radio Amplifier, Trip Computer
11	STARTER RELAY
12	ANTI-THEFT -- Theft-Deterrent Module
13	ABS -- Electronic Brake Control Module (EBCM), ABS Relay
14	HVAC BLOWER MOTOR -- Blower Motor Relay

Circuit Breaker	Description
C	Power Windows
D	Power Seats

Fuse	Description	Fuse	Description
15	HVAC #1 -- Air Temperature Valve Motor, Trip Computer, Daytime Running Lamps (DRL) Module, HVAC Control Assembly, Multifunction Lever Cruise Control Switch	29	WIPER -- Wiper Switch
16	REAR DEFOG -- HVAC Control Assembly Rear Window Defogger Switch	30	TURN SIGNAL -- Turn Signal Flasher
19	POWER ACCESSORY #1 -- Antenna Relay, Power Mirror Switch, Door Lock Switches, Door Handle Switches	32	POWER LOCKS -- Door Lock Relay
21	AIR BAG -- Air Bag System	37	AUXILIARY POWER
23	STOPLAMPS -- TCC/Brake Switch	38	RADIO -- Radio, Steering Wheel Radio Switches
24	CRUISE CONTROL	39	I/P ELECTRONICS IGNITION FEED -- Headlamp Switch, Cruise Control Cut-Out Switch, Air Bag System, TCC/Brake Switch, Instrument Cluster, Chime Module, Second-Gear Start Switch, Head-Up Display (HUD) Switch, Daytime Running Lamps (DRL) Module
28	CTSY LAMPS -- Vanity Mirrors, I/P Courtesy Lamps, I/P Compartment Lamp, Trunk Courtesy Lamp, Header Courtesy and Reading Lamp, I/S Lighted Rearview Mirror, Dome and Reading Lamp, Quarter Courtesy Lamps		

Underhood Electrical Center -- Passenger's Side

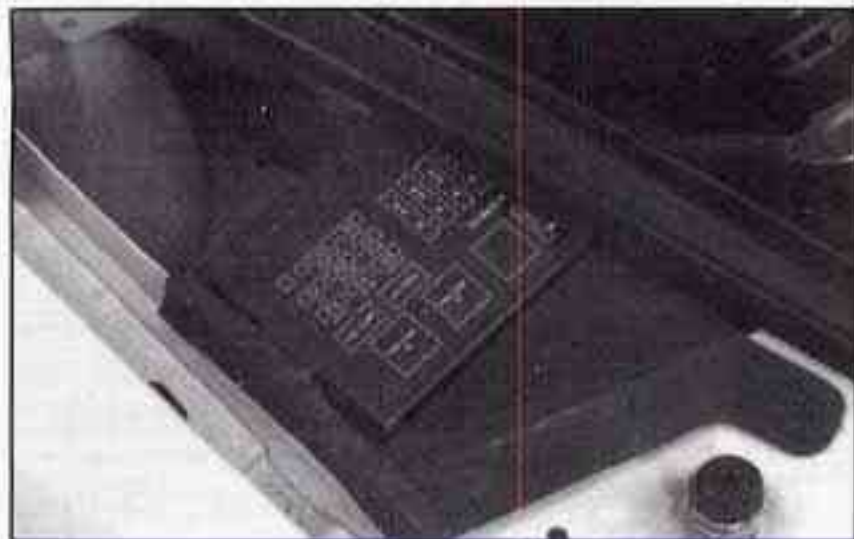

Some fuses are in the underhood electrical center on the passenger's side of the engine compartment.

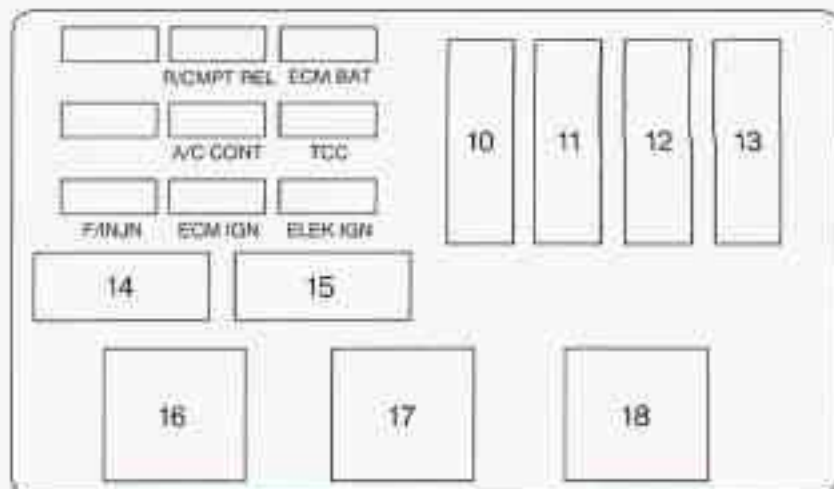

Fuse	Description
R/CMPT REL	Remote Trunk Release, Back-Up Lamps
ECM BAT	Powertrain Control Module (PCM), Fuel Pump, Fuel Pump Relay, Fan Cont #1 Relay
A/C CONT	A/C CMPR Relay (VIN M only)
TCC	Automatic Transaxle, Transaxle Range Switch (VIN M only)

Fuse	Description	Relay	Description
F/INJN	Fuel Injectors	14	FUEL PUMP
ECM IGN	Powertrain Control Module (PCM), Mass Air Flow (MAF) Sensor (VIN X only), EGR, CCP, Oxygen Sensor, VAC CAN SW, FAN #2 Relay	15	A/C CMPR
		16	FAN CONT #2 -- Secondary Cooling Fan (Passenger's Side)
		17	FAN CONT #1 -- Primary Cooling Fan (Driver's Side)
ELEK IGN	Electronic Ignition (EI) Control Module	18	Ignition Relay
10	I/P Fuse Block		
11	FAN CONT #1 Relay		
12	Passenger's Side Underhood Electrical Center and I/P Fuse Blocks: Fuses 5, 14, 23 and 32		
13	FAN CONT #2 Relay and I/P Fuse Block: Fuse 16, Power Seat Circuit Breaker D		

Underhood Electrical Center -- Driver's Side

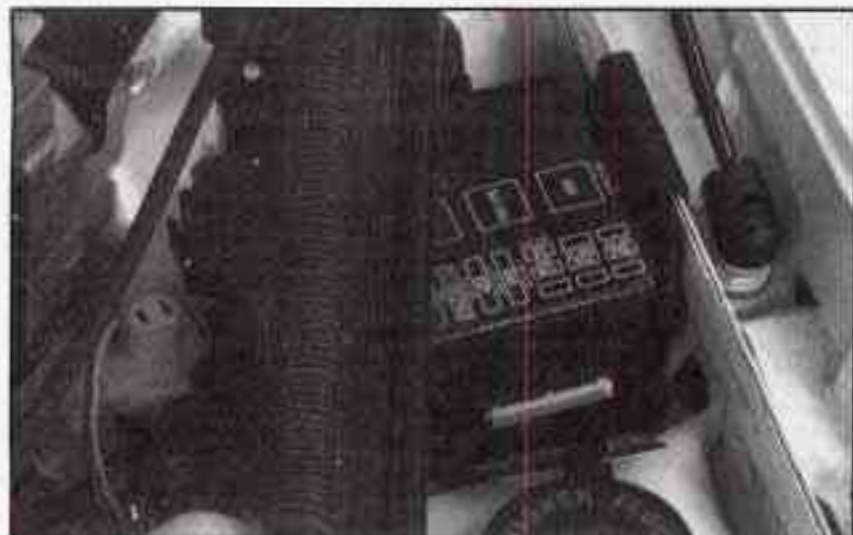

Some fuses are in the underhood electrical center on the passenger's side of the engine compartment.

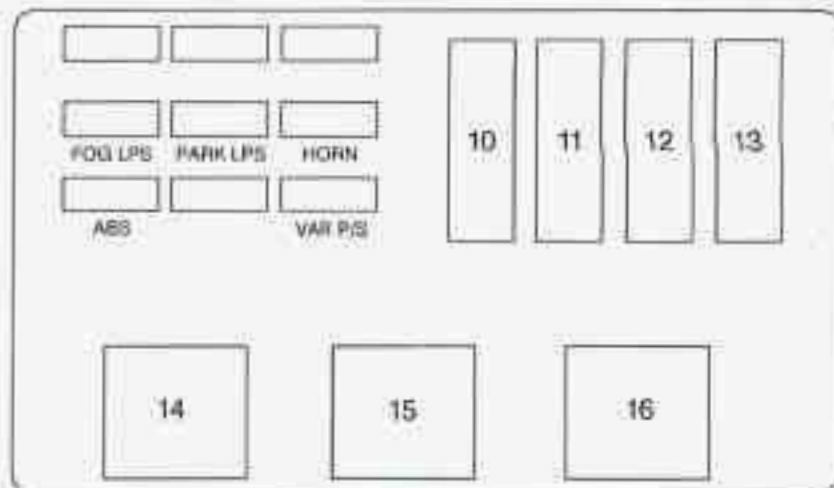

Fuse	Description
FOG LPS	Fog Lamps
PARK LPS	Headlamp Switch
HORN	Horn Relay, Underhood Lamp
VAR P/S	EVO
ABS	Anti-Lock Brake System

Fuse	Description	Relay	Description
10	IGN SW2 -- I/P Fuse Block: PWR WDO and Circuit Breaker D; Passenger's Side Underhood Electrical Center: TCC and ENG EMIS Fuses	14	ABS -- Anti-Lock Brake System
		15	FOG LPS
		16	HORN
11	IGN SW1 -- I/P Fuse Block: Radio, Wiper, HVAC, ABS and Turn Signal Fuses; Passenger's Side Underhood Electrical Center: F/IJN, ECM IGN and ELEK IGN Fuses		
12	HD LPS -- 30 Amp Circuit Breaker to Headlamp Switch		
13	ABS -- ABS Relay		

Replacement Bulbs

Exterior Lamps	Bulb Number
Back-Up	3057
Center High-Mounted Stoplamp	
Roof-Mounted	891T2
Shelf-Mounted	2355
Fog	
2-Door Models	H3 (GTP 880)
4-Door Models	881
Front Parking/Turn Signal	
2-Door Models	3157NA
4-Door Models	889
Headlamp, High-Beam	
2-Door Models	H4352 (U)
4-Door Models	9005

Exterior Lamps	Bulb Number
Headlamp, Low-Beam	
2-Door Models	H4351 (L)
4-Door Models	9006
Headlamp, Auxiliary	193
License Plate	194
Light Bar, Front	3057
Light Bar Panel, Rear	194
Sidemarkers, Front	
2-Door Models	24
4-Door Models	24NA
Sidemarkers, Rear	194
Stop/Tail/Turn Signal	3057

Interior Lamps	Bulb Number
Ashtray	194
Center Instrument Cluster	161, 194, 194R
Courtesy	
Dome	561
Door	562 or 212-2
Instrument Panel	194
Glove Box	194
Heater and Air Conditioning Control ...	T-1.0, T-1.5
High-Beam Indicator	161
Instrument Cluster Indicator	PC161
Luggage Compartment	920
Reading	
Dome	24
Inside Rearview Mirror	192
Rear Seat	906
Turn Signal Indicator	PC161
Visor Vanity	74

Capacities and Specifications

Automatic Transaxle

- Pan Removal and Replacement ... 4 quarts (3.8 L)
- After Complete Overhaul 7 quarts (6.7 L)

When draining/replacing converter or auxiliary cooler, more fluid may be needed.

Automatic Transaxle with Overdrive

- Pan Removal and Replacement ... 7 quarts (6.7 L)
- After Complete Overhaul 10 quarts (9.5 L)

When draining/replacing converter or auxiliary cooler, more fluid may be needed.

Cooling System Including Reservoir

- 3.1L (Code M) 11.6 quarts (10.93 L)
- 3.4L (Code X) 12.3 quarts (11.65 L)

Refrigerant (R-134a), Air

*Conditioning** 2.0 pounds (0.91 kg)

Engine Crankcase

- 3.1L (Code M) 4 quarts (3.8 L)
- 3.4L (Code X) 5 quarts (4.7 L)

Add 1/2 quart more when the filter is changed.

Fuel Tank 16.5 gallons (62.0 L)

**See "Air Conditioning Refrigerants" later in this section.*

Engine Specifications

	3.1L (Code M)	3.4L (Code X)
Type	V6	V6
Displacement	191 CID (3.1L)	207 CID (3.4L)
Compression Ratio	9.5:1	9.25:1
Firing Order	1-2-3-4-5-6	1-2-3-4-5-6
Thermostat Temperature	195°F (91°C)	195°F (91°C)
Horsepower	160 @ 5200	215 @ 5200

Vehicle Dimensions

Wheelbase	107.5" (2730 mm)
Tread Width	
Front	59.5" (1512 mm)
Rear	58.0" (1472 mm)
Overall Length	
Coupe	194.8" (4947 mm)
Sedan	194.9" (4951 mm)
Overall Width	71.9" (1825 mm)
Overall Height	
Coupe	52.9" (1341 mm)
Sedan	54.8" (1391 mm)

Normal Maintenance Replacement Parts

Air Cleaner Filter

All Engines	A1208C
-------------------	--------

Battery

3.1L (Code M)	600 CCA
3.4L (Code X)	690 CCA

Engine Oil Filter

3.1L (Code M)	PF47
3.4L (Code X)	PF51

PCV Valve

3.1L (Code M)	CV892C
3.4L (Code X)	CV895C

Radiator Cap

All Engines	RC27
-------------------	------

Spark Plugs

3.1L (Code M)	AC Type 41-940
	Gap: 0.060" (1.52 mm)
3.4L (Code X)	AC Type 41-919
	Gap: 0.045" (1.14 mm)

Windshield Wiper Blade Replacement

Length	20" (508 mm)
Type	pin

Air Conditioning Refrigerants

Not all air conditioning refrigerants are the same. If the air conditioning system in your vehicle needs refrigerant, be sure the proper refrigerant is used. If you're not sure, ask your Pontiac dealer.

NOTES



Section 7 Maintenance Schedule

**IMPORTANT:
KEEP ENGINE OIL
AT THE PROPER
LEVEL AND CHANGE AS
RECOMMENDED**

This section covers the maintenance required for your Pontiac. Your vehicle needs these services to retain its safety, dependability and emission control performance.



***Protection
Plan***

Have you purchased the GM Protection Plan? The Plan supplements your new vehicle warranties. See your Warranty and Owner Assistance booklet, or your Pontiac dealer for details.

Introduction

Your Vehicle and the Environment

Proper vehicle maintenance not only helps to keep your vehicle in good working condition, but also helps the environment. All recommended maintenance procedures are important. Improper vehicle maintenance can even affect the quality of the air we breathe. Improper fluid levels or the wrong tire inflation can increase the level of emissions from your vehicle. To help protect our environment, and to keep your vehicle in good condition, please maintain your vehicle properly.

How This Section is Organized

The remainder of this section is divided into five parts:

“Part A: Scheduled Maintenance Services” shows what to have done and how often. Some of these services can be complex, so unless you are technically qualified and have the necessary equipment, you should let your dealer’s service department or another qualified service center do these jobs.

CAUTION:

Performing maintenance work on a vehicle can be dangerous. In trying to do some jobs, you can be seriously injured. Do your own maintenance work only if you have the required know-how and the proper tools and equipment for the job. If you have any doubt, have a qualified technician do the work.

If you are skilled enough to do some work on your vehicle, you will probably want to get the service information GM publishes. See “Service and Owner Publications” in the Index.

“Part B: Owner Checks and Services” tells you what should be checked whenever you stop for fuel. It also explains what you can easily do to help keep your vehicle in good condition.

“Part C: Periodic Maintenance Inspections” explains important inspections that your Pontiac dealer’s service department or another qualified service center should perform.

“Part D: Recommended Fluids and Lubricants” lists some products GM recommends to help keep your vehicle properly maintained. These products, or their equivalents, should be used whether you do the work yourself or have it done.

“Part E: Maintenance Record” provides a place for you to record the maintenance performed on your vehicle. Whenever any maintenance is performed, be sure to write it down in this part. This will help you determine when your next maintenance should be done. In addition, it is a good idea to keep your maintenance receipts. They may be needed to qualify your vehicle for warranty repairs.

Part A: Scheduled Maintenance Services

Using Your Maintenance Schedule

We at General Motors want to help you keep your vehicle in good working condition. But we don't know exactly how you'll drive it. You may drive very short distances only a few times a week. Or you may drive long distances all the time in very hot, dusty weather. You may use your vehicle in making deliveries. Or you may drive it to work, to do errands or in many other ways.

Because of all the different ways people use their GM vehicles, maintenance needs vary. You may even need more frequent checks and replacements than you'll find in the schedules in this section. So please read this section and note how you drive. If you have any questions on how to keep your vehicle in good condition, see your Pontiac dealer.

This part tells you the maintenance services you should have done and when you should schedule them. If you go to your dealer for your service needs, you'll know that GM-trained and supported service people will perform the work using genuine GM parts.

The proper fluids and lubricants to use are listed in Part D. Make sure whoever services your vehicle uses these. All parts should be replaced and all necessary repairs done before you or anyone else drives the vehicle.

These schedules are for vehicles that:

- carry passengers and cargo within recommended limits. You will find these limits on your vehicle's Tire-Loading Information label. See "Loading Your Vehicle" in the Index.
- are driven on reasonable road surfaces within legal driving limits.
- use the recommended fuel. See "Fuel" in the Index.

Selecting the Right Schedule

First you'll need to decide which of the two schedules is right for your vehicle. Here's how to decide which schedule to follow:

Maintenance Schedule

Short Trip/City Definition

Follow the Short Trip/City Maintenance Schedule if any one of these conditions is true for your vehicle:

- Most trips are less than 5 to 10 miles (8 to 16 km). This is particularly important when outside temperatures are below freezing.
- Most trips include extensive idling (such as frequent driving in stop-and-go traffic).
- Most trips are through dusty areas.
- You frequently tow a trailer or use a carrier on top of your vehicle.
- If the vehicle is used for delivery service, police, taxi or other commercial application.

One of the reasons you should follow this schedule if you operate your vehicle under any of these conditions is that these conditions cause engine oil to break down sooner.

Short Trip/City Intervals

Every 3,000 Miles (5 000 km): Engine Oil and Filter Change (or 3 months, whichever occurs first).

Every 6,000 Miles (10 000 km): Chassis Lubrication (or 6 months, whichever occurs first).

At 6,000 Miles (10 000 km) -- Then Every 12,000 Miles (20 000 km): Tire Rotation.

Every 15,000 Miles (25 000 km): Air Cleaner Filter Inspection, if driving in dusty conditions.

Every 30,000 Miles (50 000 km): Air Cleaner Filter Replacement. Fuel Tank, Cap and Lines Inspection.

Every 50,000 Miles (83 000 km): Automatic Transaxle Service (severe conditions only).

Every 60,000 Miles (100 000 km): Engine Accessory Drive Belt Inspection.

At 60,000 Miles (100 000 km) -- Then Every 15,000 Miles (25 000 km): Camshaft Timing Belt Inspection (3.4L Code X engine only).

Every 100,000 Miles (166 000 km): Cooling System Service (or every 60 months, whichever occurs first). Spark Plug Wire Inspection. Spark Plug Replacement.

These intervals only summarize maintenance services. Be sure to follow the complete maintenance schedule on the following pages.

Maintenance Schedule

Long Trip/Highway Definition

Follow this maintenance schedule *only* if none of the conditions from the Short Trip/City Maintenance Schedule is true.

Driving a vehicle with a fully warmed engine under highway conditions causes engine oil to break down slower.

Long Trip/Highway Intervals

Every 7,500 Miles (12 500 km): Engine Oil and Filter Change (or every 12 months, whichever occurs first). Chassis Lubrication (or every 12 months, whichever occurs first).

At 7,500 Miles (12 500 km) -- Then Every 15,000 Miles (25 000 km): Tire Rotation.

Every 30,000 Miles (50 000 km): Air Cleaner Filter Replacement. Fuel Tank, Cap and Lines Inspection.

Every 50,000 Miles (83 000 km): Automatic Transaxle Service (severe conditions only).

Every 60,000 Miles (100 000 km): Engine Accessory Drive Belt Inspection.

At 60,000 Miles (100 000 km) -- Then Every 15,000 Miles (25 000 km): Camshaft Timing Belt Inspection (3.4L Code X engine only).

Every 100,000 Miles (166 000 km): Cooling System Service (or every 60 months, whichever occurs first). Spark Plug Wire Inspection. Spark Plug Replacement.

These intervals only summarize maintenance services. Be sure to follow the complete maintenance schedule on the following pages.

Short Trip/City Maintenance Schedule

The services shown in this schedule up to 100,000 miles (166 000 km) should be performed after 100,000 miles (166 000 km) at the same intervals.

Footnotes

† The U.S. Environmental Protection Agency or the California Air Resources Board has determined that the failure to perform this maintenance item will not nullify the emission warranty or limit recall liability prior to the completion of the vehicle's useful life. We, however, urge that all recommended maintenance services be performed at the indicated intervals and the maintenance be recorded.

3,000 Miles (5 000 km)

- Change engine oil and filter (or every 3 months, whichever occurs first).

An Emission Control Service.

DATE	ACTUAL MILEAGE	SERVICED BY:

Short Trip/City Maintenance Schedule

6,000 Miles (10 000 km)

- Change engine oil and filter (or every 3 months, whichever occurs first).
An Emission Control Service.
- Lubricate steering ball joints (or every 6 months, whichever occurs first).
- Rotate tires. See "Tire Inspection and Rotation" in the Index for proper rotation pattern and additional information. During tire rotation, check brake calipers for freedom of movement. Refer to the appropriate GM service manual for proper caliper service procedures.

DATE	ACTUAL MILEAGE	SERVICED BY:

9,000 Miles (15 000 km)

- Change engine oil and filter (or every 3 months, whichever occurs first).
An Emission Control Service.

DATE	ACTUAL MILEAGE	SERVICED BY:

Short Trip/City Maintenance Schedule

12,000 Miles (20 000 km)

- Change engine oil and filter (or every 3 months, whichever occurs first).
An Emission Control Service.
- Lubricate steering ball joints (or every 6 months, whichever occurs first).

DATE	ACTUAL MILEAGE	SERVICED BY:

15,000 Miles (25 000 km)

- Change engine oil and filter (or every 3 months, whichever occurs first).
An Emission Control Service.
- Inspect air cleaner filter if you are driving in dusty conditions. Replace filter if necessary. *An Emission Control Service.* †

DATE	ACTUAL MILEAGE	SERVICED BY:

Short Trip/City Maintenance Schedule

18,000 Miles (30 000 km)

- Change engine oil and filter (or every 3 months, whichever occurs first).
An Emission Control Service.
- Lubricate steering ball joints (or every 6 months, whichever occurs first).
- Rotate tires. See "Tire Inspection and Rotation" in the Index for proper rotation pattern and additional information. During tire rotation, check brake calipers for freedom of movement. Refer to the appropriate GM service manual for proper caliper service procedures.

DATE	ACTUAL MILEAGE	SERVICED BY:

21,000 Miles (35 000 km)

- Change engine oil and filter (or every 3 months, whichever occurs first).
An Emission Control Service.

DATE	ACTUAL MILEAGE	SERVICED BY:

Short Trip/City Maintenance Schedule

24,000 Miles (40 000 km)

- Change engine oil and filter (or every 3 months, whichever occurs first).
An Emission Control Service.
- Lubricate steering ball joints (or every 6 months, whichever occurs first).

DATE	ACTUAL MILEAGE	SERVICED BY:

27,000 Miles (45 000 km)

- Change engine oil and filter (or every 3 months, whichever occurs first).
An Emission Control Service.

DATE	ACTUAL MILEAGE	SERVICED BY:

Short Trip/City Maintenance Schedule

30,000 Miles (50 000 km)

- Change engine oil and filter (or every 3 months, whichever occurs first).
An Emission Control Service.
- Lubricate steering ball joints (or every 6 months, whichever occurs first).
- Replace air cleaner filter.
An Emission Control Service.

- Inspect fuel tank, cap and lines for damage or leaks. Inspect fuel cap gasket for any damage. Replace parts as needed.
An Emission Control Service. †
- Rotate tires. See "Tire Inspection and Rotation" in the Index for proper rotation pattern and additional information. During tire rotation, check brake calipers for freedom of movement. Refer to the appropriate GM service manual for proper caliper service procedures.

DATE	ACTUAL MILEAGE	SERVICED BY:

Short Trip/City Maintenance Schedule

33,000 Miles (55 000 km)

- Change engine oil and filter (or every 3 months, whichever occurs first).
An Emission Control Service.

DATE	ACTUAL MILEAGE	SERVICED BY:

36,000 Miles (60 000 km)

- Change engine oil and filter (or every 3 months, whichever occurs first).
An Emission Control Service.
- Lubricate steering ball joints (or every 6 months, whichever occurs first).

DATE	ACTUAL MILEAGE	SERVICED BY:

Short Trip/City Maintenance Schedule

39,000 Miles (65 000 km)

- Change engine oil and filter (or every 3 months, whichever occurs first).
An Emission Control Service.

DATE	ACTUAL MILEAGE	SERVICED BY:

42,000 Miles (70 000 km)

- Change engine oil and filter (or every 3 months, whichever occurs first).
An Emission Control Service.
- Lubricate steering ball joints (or every 6 months, whichever occurs first).
- Rotate tires. See "Tire Inspection and Rotation" in the Index for proper rotation pattern and additional information. During tire rotation, check brake calipers for freedom of movement. Refer to the appropriate GM service manual for proper caliper service procedures.

DATE	ACTUAL MILEAGE	SERVICED BY:

Short Trip/City Maintenance Schedule

45,000 Miles (75 000 km)

- Change engine oil and filter (or every 3 months, whichever occurs first).
An Emission Control Service.
- Inspect air cleaner filter if you are driving in dusty conditions. Replace filter if necessary. *An Emission Control Service.* †

DATE	ACTUAL MILEAGE	SERVICED BY:

48,000 Miles (80 000 km)

- Change engine oil and filter (or every 3 months, whichever occurs first).
An Emission Control Service.
- Lubricate steering ball joints (or every 6 months, whichever occurs first).

DATE	ACTUAL MILEAGE	SERVICED BY:

Short Trip/City Maintenance Schedule

50,000 Miles (83 000 km)

- Change automatic transaxle fluid and filter if the vehicle is mainly driven under one or more of these conditions:
- In heavy city traffic where the outside temperature regularly reaches 90°F (32°C) or higher.
 - In hilly or mountainous terrain.
 - When doing frequent trailer towing.
 - Uses such as found in taxi, police or delivery service.

If you do not use your vehicle under any of these conditions, the fluid and filter do not require changing.

DATE	ACTUAL MILEAGE	SERVICED BY:

51,000 Miles (85 000 km)

- Change engine oil and filter (or every 3 months, whichever occurs first).
An Emission Control Service.

DATE	ACTUAL MILEAGE	SERVICED BY:

Short Trip/City Maintenance Schedule

54,000 Miles (90 000 km)

- Change engine oil and filter (or every 3 months, whichever occurs first).
An Emission Control Service.
- Lubricate steering ball joints (or every 6 months, whichever occurs first).
- Rotate tires. See "Tire Inspection and Rotation" in the Index for proper rotation pattern and additional information. During tire rotation, check brake calipers for freedom of movement. Refer to the appropriate GM service manual for proper caliper service procedures.

DATE	ACTUAL MILEAGE	SERVICED BY:

57,000 Miles (95 000 km)

- Change engine oil and filter (or every 3 months, whichever occurs first).
An Emission Control Service.

DATE	ACTUAL MILEAGE	SERVICED BY:

Short Trip/City Maintenance Schedule

60,000 Miles (100 000 km)

- Change engine oil and filter (or every 3 months, whichever occurs first).

An Emission Control Service.

- Lubricate steering ball joints (or every 6 months, whichever occurs first).

- Inspect engine accessory drive belt.

An Emission Control Service.

- Vehicles with 3.4L Code X engine only:
Inspect camshaft timing belt.

An Emission Control Service. †

- Replace air cleaner filter.

An Emission Control Service.

- Inspect fuel tank, cap and lines for damage or leaks. Inspect fuel cap gasket for any damage. Replace parts as needed.

An Emission Control Service. †

DATE	ACTUAL MILEAGE	SERVICED BY:

Short Trip/City Maintenance Schedule

63,000 Miles (105 000 km)

- Change engine oil and filter (or every 3 months, whichever occurs first).

An Emission Control Service.

DATE	ACTUAL MILEAGE	SERVICED BY:

66,000 Miles (110 000 km)

- Change engine oil and filter (or every 3 months, whichever occurs first).
An Emission Control Service.
- Lubricate steering ball joints (or every 6 months, whichever occurs first).
- Rotate tires. See "Tire Inspection and Rotation" in the Index for proper rotation pattern and additional information. During tire rotation, check brake calipers for freedom of movement. Refer to the appropriate GM service manual for proper caliper service procedures.

DATE	ACTUAL MILEAGE	SERVICED BY:

Short Trip/City Maintenance Schedule

69,000 Miles (115 000 km)

- Change engine oil and filter (or every 3 months, whichever occurs first).
An Emission Control Service.

72,000 Miles (120 000 km)

- Change engine oil and filter (or every 3 months, whichever occurs first).
An Emission Control Service.
- Lubricate steering ball joints (or every 6 months, whichever occurs first).

DATE	ACTUAL MILEAGE	SERVICED BY:

DATE	ACTUAL MILEAGE	SERVICED BY:

Short Trip/City Maintenance Schedule

75,000 Miles (125 000 km)

- Change engine oil and filter (or every 3 months, whichever occurs first).
An Emission Control Service.
- Inspect air cleaner filter if you are driving in dusty conditions. Replace filter if necessary. *An Emission Control Service.* †
- Vehicles with 3.4L Code X engine only:
Inspect camshaft timing belt.
An Emission Control Service. †

DATE	ACTUAL MILEAGE	SERVICED BY:

78,000 Miles (130 000 km)

- Change engine oil and filter (or every 3 months, whichever occurs first).
An Emission Control Service.
- Lubricate steering ball joints (or every 6 months, whichever occurs first).
- Rotate tires. See "Tire Inspection and Rotation" in the Index for proper rotation pattern and additional information. During tire rotation, check brake calipers for freedom of movement. Refer to the appropriate GM service manual for proper caliper service procedures.

DATE	ACTUAL MILEAGE	SERVICED BY:

Short Trip/City Maintenance Schedule

81,000 Miles (135 000 km)

- Change engine oil and filter (or every 3 months, whichever occurs first).
An Emission Control Service.

DATE	ACTUAL MILEAGE	SERVICED BY:

84,000 Miles (140 000 km)

- Change engine oil and filter (or every 3 months, whichever occurs first).
An Emission Control Service.
- Lubricate steering ball joints (or every 6 months, whichever occurs first).

DATE	ACTUAL MILEAGE	SERVICED BY:

Short Trip/City Maintenance Schedule

87,000 Miles (145 000 km)

- Change engine oil and filter (or every 3 months, whichever occurs first).
An Emission Control Service.

90,000 Miles (150 000 km)

- Change engine oil and filter (or every 3 months, whichever occurs first).
An Emission Control Service.
- Lubricate steering ball joints (or every 6 months, whichever occurs first).
- Vehicles with 3.4L Code X engine only:
Inspect camshaft timing belt.
An Emission Control Service. †
- Replace air cleaner filter.
An Emission Control Service.

DATE	ACTUAL MILEAGE	SERVICED BY:

Short Trip/City Maintenance Schedule

- Inspect fuel tank, cap and lines for damage or leaks. Inspect fuel cap gasket for any damage. Replace parts as needed.
An Emission Control Service. †
- Rotate tires. See "Tire Inspection and Rotation" in the Index for proper rotation pattern and additional information. During tire rotation, check brake calipers for freedom of movement. Refer to the appropriate GM service manual for proper caliper service procedures.

DATE	ACTUAL MILEAGE	SERVICED BY:

93,000 Miles (155 000 km)

- Change engine oil and filter (or every 3 months, whichever occurs first).
An Emission Control Service.

DATE	ACTUAL MILEAGE	SERVICED BY:

Short Trip/City Maintenance Schedule

96,000 Miles (160 000 km)

- Change engine oil and filter (or every 3 months, whichever occurs first).
An Emission Control Service.
- Lubricate steering ball joints (or every 6 months, whichever occurs first).

DATE	ACTUAL MILEAGE	SERVICED BY:

99,000 Miles (165 000 km)

- Change engine oil and filter (or every 3 months, whichever occurs first).
An Emission Control Service.

DATE	ACTUAL MILEAGE	SERVICED BY:

Short Trip/City Maintenance Schedule

100,000 Miles (166 000 km)

- Drain, flush and refill cooling system (or every 60 months since last service, whichever occurs first). See "Engine Coolant" in the Index for what to use. Inspect hoses. Clean radiator, condenser, pressure cap and neck. Pressure test cooling system and pressure cap.

An Emission Control Service. †

- Inspect spark plug wires.

An Emission Control Service.

- Replace spark plugs.

An Emission Control Service.

- Change automatic transaxle fluid and filter if the vehicle is mainly driven under one or more of these conditions:

- In heavy city traffic where the outside temperature regularly reaches 90°F (32°C) or higher.
- In hilly or mountainous terrain.
- When doing frequent trailer towing.
- Uses such as found in taxi, police or delivery service.

If you do not use your vehicle under any of these conditions, the fluid and filter do not require changing.

DATE	ACTUAL MILEAGE	SERVICED BY:

Long Trip/Highway Maintenance Schedule

The services shown in this schedule up to 100,000 miles (166 000 km) should be performed after 100,000 miles (166 000 km) at the same intervals.

Footnotes

† The U.S. Environmental Protection Agency or the California Air Resources Board has determined that the failure to perform this maintenance item will not nullify the emission warranty or limit recall liability prior to the completion of the vehicle's useful life. We, however, urge that all recommended maintenance services be performed at the indicated intervals and the maintenance be recorded.

7,500 Miles (12 500 km)

- Change engine oil and filter (or every 12 months, whichever occurs first).
An Emission Control Service.
- Lubricate steering ball joints (or every 6 months, whichever occurs first).
- Rotate tires. See "Tire Inspection and Rotation" in the Index for proper rotation pattern and additional information. During tire rotation, check brake calipers for freedom of movement. Refer to the appropriate GM service manual for proper caliper service procedures.

DATE	ACTUAL MILEAGE	SERVICED BY:

Long Trip/Highway Maintenance Schedule

15,000 Miles (25 000 km)

- Change engine oil and filter (or every 12 months, whichever occurs first).
An Emission Control Service.
- Lubricate steering ball joints (or every 6 months, whichever occurs first).

DATE	ACTUAL MILEAGE	SERVICED BY:

22,500 Miles (37 500 km)

- Change engine oil and filter (or every 12 months, whichever occurs first).
An Emission Control Service.
- Lubricate steering ball joints (or every 6 months, whichever occurs first).
- Rotate tires. See "Tire Inspection and Rotation" in the Index for proper rotation pattern and additional information. During tire rotation, check brake calipers for freedom of movement. Refer to the appropriate GM service manual for proper caliper service procedures.

DATE	ACTUAL MILEAGE	SERVICED BY:

Long Trip/Highway Maintenance Schedule

30,000 Miles (50 000 km)

- Change engine oil and filter (or every 12 months, whichever occurs first).
An Emission Control Service.
- Lubricate steering ball joints (or every 6 months, whichever occurs first).
- Replace air cleaner filter.
An Emission Control Service.
- Inspect fuel tank, cap and lines for damage or leaks. Inspect fuel cap gasket for any damage. Replace parts as needed.
An Emission Control Service. †

DATE	ACTUAL MILEAGE	SERVICED BY:

37,500 Miles (62 500 km)

- Change engine oil and filter (or every 12 months, whichever occurs first).
An Emission Control Service.
- Lubricate steering ball joints (or every 6 months, whichever occurs first).
- Rotate tires. See "Tire Inspection and Rotation" in the Index for proper rotation pattern and additional information. During tire rotation, check brake calipers for freedom of movement. Refer to the appropriate GM service manual for proper caliper service procedures.

DATE	ACTUAL MILEAGE	SERVICED BY:

Long Trip/Highway Maintenance Schedule

45,000 Miles (75 000 km)

- Change engine oil and filter (or every 12 months, whichever occurs first).
An Emission Control Service.
- Lubricate steering ball joints (or every 6 months, whichever occurs first).

DATE	ACTUAL MILEAGE	SERVICED BY:

50,000 Miles (83 000 km)

- Change automatic transaxle fluid and filter if the vehicle is mainly driven under one or more of these conditions:
 - In heavy city traffic where the outside temperature regularly reaches 90°F (32°C) or higher.
 - In hilly or mountainous terrain.
 - When doing frequent trailer towing.
 - Uses such as found in taxi, police or delivery service.

If you do not use your vehicle under any of these conditions, the fluid and filter do not require changing.

DATE	ACTUAL MILEAGE	SERVICED BY:

Long Trip/Highway Maintenance Schedule

52,500 Miles (87 500 km)

- Change engine oil and filter (or every 12 months, whichever occurs first).
An Emission Control Service.
- Lubricate steering ball joints (or every 6 months, whichever occurs first).
- Rotate tires. See "Tire Inspection and Rotation" in the Index for proper rotation pattern and additional information. During tire rotation, check brake calipers for freedom of movement. Refer to the appropriate GM service manual for proper caliper service procedures.

60,000 Miles (100 000 km)

- Change engine oil and filter (or every 12 months, whichever occurs first).
An Emission Control Service.
- Lubricate steering ball joints (or every 6 months, whichever occurs first).
- Inspect engine accessory drive belt.
An Emission Control Service.
- Vehicles with 3.4L Code X engine only:
Inspect camshaft timing belt.
An Emission Control Service. †

DATE	ACTUAL MILEAGE	SERVICED BY:

Long Trip/Highway Maintenance Schedule

- Replace air cleaner filter.
An Emission Control Service.
- Inspect fuel tank, cap and lines for damage or leaks. Inspect fuel cap gasket for any damage. Replace parts as needed.
An Emission Control Service. †

DATE	ACTUAL MILEAGE	SERVICED BY:

67,500 Miles (112 500 km)

- Change engine oil and filter (or every 12 months, whichever occurs first).
An Emission Control Service.
- Lubricate steering ball joints (or every 6 months, whichever occurs first).
- Rotate tires. See "Tire Inspection and Rotation" in the Index for proper rotation pattern and additional information. During tire rotation, check brake calipers for freedom of movement. Refer to the appropriate GM service manual for proper caliper service procedures.

DATE	ACTUAL MILEAGE	SERVICED BY:

Long Trip/Highway Maintenance Schedule

75,000 Miles (125 000 km)

- Change engine oil and filter (or every 12 months, whichever occurs first).
An Emission Control Service.
- Lubricate steering ball joints (or every 6 months, whichever occurs first).
- Vehicles with 3.4L Code X engine only:
Inspect camshaft timing belt.
An Emission Control Service. †

DATE	ACTUAL MILEAGE	SERVICED BY:

82,500 Miles (137 500 km)

- Change engine oil and filter (or every 12 months, whichever occurs first).
An Emission Control Service.
- Lubricate steering ball joints (or every 6 months, whichever occurs first).
- Rotate tires. See "Tire Inspection and Rotation" in the Index for proper rotation pattern and additional information. During tire rotation, check brake calipers for freedom of movement. Refer to the appropriate GM service manual for proper caliper service procedures.

DATE	ACTUAL MILEAGE	SERVICED BY:

Long Trip/Highway Maintenance Schedule

90,000 Miles (150 000 km)

- Change engine oil and filter (or every 12 months, whichever occurs first).
An Emission Control Service.
- Lubricate steering ball joints (or every 6 months, whichever occurs first).
- Vehicles with 3.4L Code X engine only:
Inspect camshaft timing belt.
An Emission Control Service. †

- Replace air cleaner filter.
An Emission Control Service.
- Inspect fuel tank, cap and lines for damage or leaks. Inspect fuel cap gasket for any damage. Replace parts as needed.
An Emission Control Service. †

DATE	ACTUAL MILEAGE	SERVICED BY:

Long Trip/Highway Maintenance Schedule

97,500 Miles (162 500 km)

- Change engine oil and filter (or every 12 months, whichever occurs first).
An Emission Control Service.
- Lubricate steering ball joints (or every 6 months, whichever occurs first).
- Rotate tires. See "Tire Inspection and Rotation" in the Index for proper rotation pattern and additional information. During tire rotation, check brake calipers for freedom of movement. Refer to the appropriate GM service manual for proper caliper service procedures.

100,000 Miles (166 000 km)

- Drain, flush and refill cooling system (or every 60 months since last service, whichever occurs first). See "Engine Coolant" in the Index for what to use. Inspect hoses. Clean radiator, condenser, pressure cap and neck. Pressure test the cooling system and pressure cap.
An Emission Control Service. †
- Inspect spark plug wires.
An Emission Control Service.
- Replace spark plugs.
An Emission Control Service.

DATE	ACTUAL MILEAGE	SERVICED BY:

Long Trip/Highway Maintenance Schedule

- Change automatic transaxle fluid and filter if the vehicle is mainly driven under one or more of these conditions:
- In heavy city traffic where the outside temperature regularly reaches 90°F (32°C) or higher.
 - In hilly or mountainous terrain.

- When doing frequent trailer towing.
- Uses such as found in taxi, police or delivery service.

If you do not use your vehicle under any of these conditions, the fluid and filter do not require changing.

DATE	ACTUAL MILEAGE	SERVICED BY:

Part B: Owner Checks and Services

Listed below are owner checks and services which should be performed at the intervals specified to help ensure the safety, dependability and emission control performance of your vehicle.

Be sure any necessary repairs are completed at once. Whenever any fluids or lubricants are added to your vehicle, make sure they are the proper ones, as shown in Part D.

At Each Fuel Fill

It is important for you or a service station attendant to perform these underhood checks at each fuel fill.

Engine Oil Level Check

Check the engine oil level and add the proper oil if necessary. See "Engine Oil" in the Index for further details.

Engine Coolant Level Check

Check the engine coolant level and add the proper coolant mix if necessary. See "Engine Coolant" in the Index for further details.

Windshield Washer Fluid Level Check

Check the windshield washer fluid level in the windshield washer tank and add the proper fluid if necessary. See "Windshield Washer Fluid" in the Index for further details.

At Least Once a Month

Tire Inflation Check

Make sure tires are inflated to the correct pressures. See "Tires" in the Index for further details.

Cassette Deck Service

Clean cassette deck. Cleaning should be done every 50 hours of tape play. See "Audio Systems" in the Index for further details.

Power Antenna Service

Clean power antenna mast. See "Audio Systems" in the Index for further details.

At Least Twice a Year

Restraint System Check

Make sure the safety belt reminder light and all your belts, buckles, latch plates, retractors and anchorages are working properly. Look for any other loose or damaged safety belt system parts. If you see anything that might keep a safety belt system from doing its job, have it repaired. Have any torn or frayed safety belts replaced.

Also look for any opened or broken air bag covers, and have them repaired or replaced. (The air bag system does not need regular maintenance.)

Automatic Transaxle Check

Check the transaxle fluid level; add if needed. See "Automatic Transaxle" in the Index. A fluid loss may indicate a problem. Check the system and repair if needed.

At Least Once a Year

Key Lock Cylinders Service

Lubricate the key lock cylinders with the lubricant specified in Part D.

Body Lubrication Service

Lubricate all hinges and latches, including those for the hood, rear compartment, glove box door, console door and any folding seat hardware. Part D tells you what to use. More frequent lubrication may be required when exposed to a corrosive environment.

 **CAUTION:**

When you are doing this check, the vehicle could move suddenly. If it does, you or others could be injured. Follow the steps below.

1. Before you start, be sure you have enough room around the vehicle.
2. Firmly apply both the parking brake (see "Parking Brake" in the Index if necessary) and the regular brake.

NOTE: Do not use the accelerator pedal, and be ready to turn off the engine immediately if it starts.

3. Try to start the engine in each gear. The starter should work only in PARK (P) or NEUTRAL (N). If the starter works in any other position, your vehicle needs service.

 **CAUTION:**

When you are doing this check, the vehicle could move suddenly. If it does, you or others could be injured. Follow the steps below.

1. Before you start, be sure you have enough room around the vehicle. It should be parked on a level surface.
2. Firmly apply the parking brake (see "Parking Brake" in the Index if necessary).

NOTE: Be ready to apply the regular brake immediately if the vehicle begins to move.

3. With the engine off, turn the key to the RUN position, but don't start the engine. Without applying the regular brake, try to move the shift lever out of PARK (P) with normal effort. If the shift lever moves out of PARK (P), your vehicle's BTSI needs service.

Steering Column Lock Check

While parked, and with the parking brake set, try to turn the key to LOCK in each shift lever position.

- The key should turn to LOCK only when the shift lever is in PARK (P).
- The key should come out only in LOCK.

Parking Brake and Automatic Transaxle PARK (P) Mechanism Check



CAUTION:

When you are doing this check, your vehicle could begin to move. You or others could be injured and property could be damaged. Make sure there is room in front of your vehicle in case it begins to roll. Be ready to apply the regular brake at once should the vehicle begin to move.

Park on a fairly steep hill, with the vehicle facing downhill. Keeping your foot on the regular brake, set the parking brake.

- To check the parking brake: With the engine running and transaxle in NEUTRAL (N), slowly remove foot pressure from the regular brake pedal. Do this until the vehicle is held by the parking brake only.
- To check the PARK (P) mechanism's holding ability: With the engine running shift to PARK (P). Then release all brakes.

Underbody Flushing Service

At least every spring, use plain water to flush any corrosive materials from the underbody. Take care to clean thoroughly any areas where mud and other debris can collect.

Part C: Periodic Maintenance

Inspections

Listed below are inspections and services which should be performed at least twice a year (for instance, each spring and fall). You should let your GM dealer's service department or other qualified service center do these jobs. Make sure any necessary repairs are completed at once.

Proper procedures to perform these services may be found in a Pontiac Service Manual. See "Service and Owner Publications" in the Index.

Steering, Suspension and Front-Wheel-Drive Axle Boot and Seal Inspection

Inspect the front and rear suspension and steering system for damaged, loose or missing parts, signs of wear or lack of lubrication. Inspect the power steering lines and hoses for proper hook-up, binding, leaks, cracks, chafing, etc. Clean and then inspect the drive axle boot seals for damage, tears or leakage. Replace seals if necessary.

Exhaust System Inspection

Inspect the complete exhaust system. Inspect the body near the exhaust system. Look for broken, damaged, missing or out-of-position parts as well as open seams, holes, loose

connections or other conditions which could cause a heat build-up in the floor pan or could let exhaust fumes into the vehicle. See "Engine Exhaust" in the Index.

Radiator and Heater Hose Inspection

Inspect the hoses and have them replaced if they are cracked, swollen or deteriorated. Inspect all pipes, fittings and clamps; replace as needed.

Throttle Linkage Inspection

Inspect the throttle linkage for interference or binding, and for damage or missing parts. Replace parts as needed. Replace any cables that have high effort or excessive wear. Do not lubricate accelerator and cruise control cables.

Brake System Inspection

Inspect the complete system. Inspect brake lines and hoses for proper hook-up, binding, leaks, cracks, chafing, etc. Inspect disc brake pads for wear and rotors for surface condition. Inspect other brake parts, including calipers, parking brake, etc. Check parking brake adjustment. You may need to have your brakes inspected more often if your driving habits or conditions result in frequent braking.

Part D: Recommended Fluids and Lubricants

NOTE: Fluids and lubricants identified below by name, part number or specification may be obtained from your GM dealer.

USAGE	FLUID/LUBRICANT
Engine Oil	Engine oil with the American Petroleum Institute Certified For Gasoline Engines "Starburst" symbol of the proper viscosity. To determine the preferred viscosity for your vehicle's engine, see "Engine Oil" in the Index.
Engine Coolant	50/50 mixture of clean water (preferably distilled) and GM Goodwrench [®] DEX-COOL [™] or Havoline [®] DEX-COOL [™] (orange-colored, silicate-free) antifreeze conforming to GM Specification 6277M. See "Engine Coolant" in the Index.

USAGE	FLUID/LUBRICANT
Coolant Supplement Sealer	GM Part No. 3634621 or equivalent with a complete flush and refill.
Hydraulic Brake System	Delco Supreme 11 [®] Brake Fluid (GM Part No. 1052535 or equivalent DOT-3 brake fluid).
Power Steering System	GM Power Steering Fluid (GM Part No. 1052884 - 1 pt., 1050017 - 1 qt., or equivalent).
Automatic Transaxle	DEXRON [®] -III Automatic Transmission Fluid.
Key Lock Cylinders	Multi-Purpose Lubricant, Superlube [®] (GM Part No. 12346241 or equivalent).
Chassis Lubrication	Chassis lubricant (GM Part No. 1052497 or equivalent) or lubricant meeting requirements of NLGI Grade 2, Category LB or GC-LB.

USAGE	FLUID/LUBRICANT
Windshield Washer Solvent	GM Optikleen [®] Washer Solvent (GM Part No. 1051515) or equivalent.
Hood Latch Assembly Pivots, Spring Anchor and Release Pawl	Lubriplate lubricant aerosol (GM Part No. 12346293 or equivalent) or lubricant meeting requirements of NLGI Grade 2, Category LB or GC-LB.
Hood and Door Hinges	Multi-purpose lubricant, Superlube [®] (GM Part No. 12346241 or equivalent).

USAGE	FLUID/LUBRICANT
Fuel Door Hinge and Trunk Access Panel Hinges	Engine oil or Lubriplate Lubricant (GM Part No. 1050109).
Weatherstrip Conditioning	Dielectric Silicone Grease (GM Part No. 12345579 or equivalent).

See "Replacement Parts" in the Index for recommended replacement filters and spark plugs.

Part E: Maintenance Record

After the scheduled services are performed, record the date, odometer reading and who performed the service in the boxes provided after the maintenance interval. Any additional information from "Owner Checks and

Services" or "Periodic Maintenance" can be added on the following record pages. Also, you should retain all maintenance receipts. Your owner information portfolio is a convenient place to store them.

Maintenance Record			
DATE	ODOMETER READING	SERVICED BY	MAINTENANCE PERFORMED



Section 8 Customer Assistance Information

Here you will find out how to contact Pontiac if you need assistance. This section also tells you how to obtain service publications and how to report any safety defects.

This section includes information on:

- The Pontiac Cares Program
- The Customer Satisfaction Procedure
- Customer Assistance for Text Telephone (TTY) Users
- Roadside Assistance
- Courtesy Transportation
- BBB Auto Line -- Alternative Dispute Resolution Program
- Reporting Safety Defects
- Service and Owner Publications

Pontiac Cares



With the PONTIAC CARES program, you are never more than a phone call away from having your concern taken care of.

The PONTIAC CARES philosophy and elements are designed to make you realize that Pontiac recognizes you as a valuable customer, appreciates your purchase decision, and is dedicated to taking care of the most important person ... YOU! PONTIAC CARES is: A valuable feature that comes with every Pontiac, a feature that offers a multitude of benefits that can give you safety, security, comfort and convenience.

What makes up Pontiac Cares?

- A 3 year/36,000 mile Bumper to Bumper Warranty
- Roadside Assistance
- Courtesy Transportation

All of these elements combine to make your driving experience an enjoyable one, and are discussed in greater detail further in your owner's manual. Pontiac is focusing on the changing needs of our customers and is committed in giving you an exceptional level of customer care throughout the ownership experience. Our goal is to create total customer enthusiasm in our product and our services, and make you the most satisfied customer in the world.

Customer Satisfaction Procedure



Your satisfaction and goodwill are important to your dealer and Pontiac. Normally, any concern you may have with your vehicle can be handled by your selling or servicing dealer. Your dealer has the facility, trained technicians, special tools and up-to-date information to promptly address any issue which may arise. Pontiac has empowered its dealers to make any decisions and repair vehicles, and they are eager to resolve your concern to

your complete satisfaction. If your concern has not been resolved to your satisfaction, take the following steps:

STEP ONE -- Discuss your concern with a member of dealership management. Normally, concerns can be quickly resolved at that level. If the matter has already been reviewed with the Sales, Service, or Parts Manager, contact the owner of the dealership or the General Manager.

STEP TWO -- If after contacting a member of dealership management, it appears your concern cannot be resolved by the dealership without further help, contact the Pontiac Customer Assistance Center by calling 1-800-PM-CARES. In Canada, contact GM of Canada Customer Assistance Center in Oshawa by calling 1-800-263-3777 (English) or 1-800-263-7854 (French).

For help outside of the United States and Canada, call the following numbers as appropriate:

- In Mexico: (525) 625-3256
- In Puerto Rico: 1-800-496-9992 (English) or 1-800-496-9993 (Spanish)
- In the U.S. Virgin Islands: 1-800-496-9994
- In the Dominican Republic: 1-800-751-4135 (English) or 1-800-751-4136 (Spanish)

- In the Bahamas: 1-800-389-0009
- In Bermuda, Barbados, Antigua and the British Virgin Islands: 1-800-534-0122
- In all other Caribbean countries: 1-809-763-1315
- In other overseas locations, call GM North American Export Sales in Canada at 1-905-644-4112.

For prompt assistance, please have the following information available to give the Customer Assistance Representative:

- Your name, address, home and business telephone numbers
- Vehicle Identification Number (This is available from the vehicle registration or title, or the plate at the top left of the instrument panel and visible through the windshield.)
- Dealership name and location
- Vehicle delivery date and present mileage
- Nature of concern

We encourage you to call us so we can give your inquiry prompt attention. However, if you wish to write Pontiac, write to:

Pontiac Division
Customer Assistance Center
One Pontiac Plaza
Pontiac, MI 48340-2952.

Refer to your Warranty and Owner Assistance Information booklet for addresses of Canadian and GM Overseas offices.

When contacting Pontiac, please remember that your concern will likely be resolved in the dealership, using the dealer's facilities, equipment and personnel. That is why we suggest you follow Step One first if you have a concern.

Customer Assistance for Text Telephone (TTY) Users

To assist customers who are deaf, hard of hearing, or speech-impaired and who use Text Telephones (TTYs), Pontiac has TTY equipment available at its Customer Assistance Center. Any TTY user can communicate with Pontiac by dialing: 1-800-833-PONT. (TTY users in Canada can dial 1-800-263-3830.)

Pontiac Roadside Assistance Program

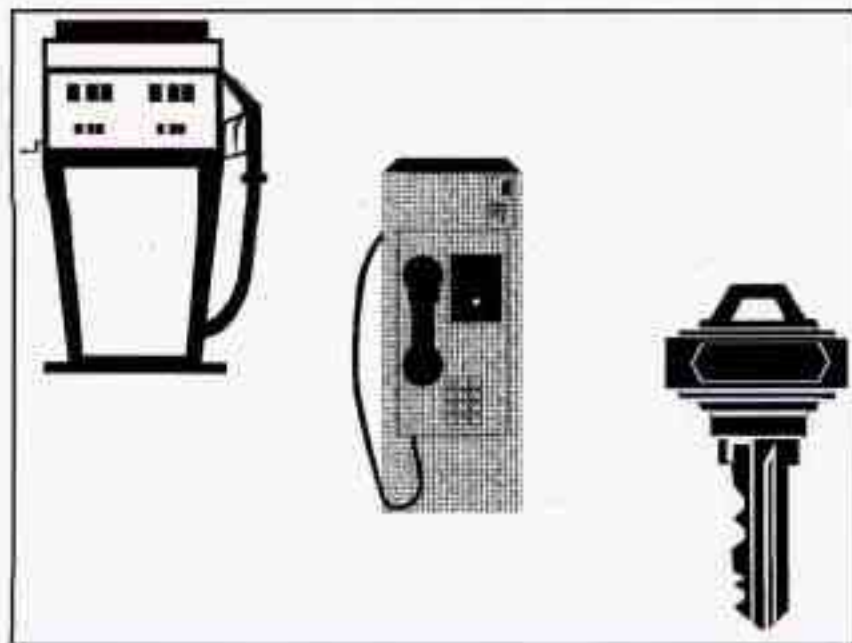

Pontiac's Roadside Assistance toll-free number is staffed by a team of technically trained advisors, who are available 24 hours a day, 365 days a year.

We take anxiety out of uncertain situations by providing minor repair information over the phone or making arrangements to tow your vehicle to the nearest Pontiac dealer.

We will provide the following services for 3 year/36,000 miles, at no expense to you:

- Vehicle out of fuel
- Keys locked in vehicle
- Tow to nearest dealership for warranty service
- Change a flat tire
- Jump starts
- Courtesy Transportation -- See Pontiac Courtesy Transportation section for details

Security While You Travel

1-800-ROADSIDE (1-800-762-3743)

As the proud owner of a new Pontiac vehicle, you are automatically enrolled in the Pontiac Roadside Assistance program. This value-added service is intended to provide you with peace of mind as you drive in the city or travel the open road.

We have quick, easy access to telephone numbers of the following additional services depending on your needs:

- Hotels
- Glass replacement
- Rental vehicle or taxis
- Police, fire department or hospitals

In many instances, mechanical failures are covered under Pontiac's comprehensive warranty. However, when other services are utilized, our advisors will explain any payment obligations you might incur.

For prompt and efficient assistance when calling, please provide the following information to give the advisor:

- Location of vehicle
- Telephone number of your location
- Vehicle model, year and color
- Mileage of vehicle
- Vehicle identification number
- Vehicle license plate number

Pontiac reserves the right to limit services or reimbursement to an owner or driver when in Pontiac's judgement the claims become excessive in frequency or type of occurrence.

While we hope that you never have the occasion to use our service, it is added security while traveling for you and your family. Remember, we're only a phone call away. Pontiac Roadside Assistance -- 1-800-ROADSIDE or 1-800-762-3743.

Canadian Roadside Assistance

Vehicles purchased in Canada have an extensive Roadside Assistance program accessible from anywhere in Canada or the United States. Please refer to the separate brochure provided by the dealer or call 1-800-268-6800 for emergency services.

Pontiac Courtesy Transportation

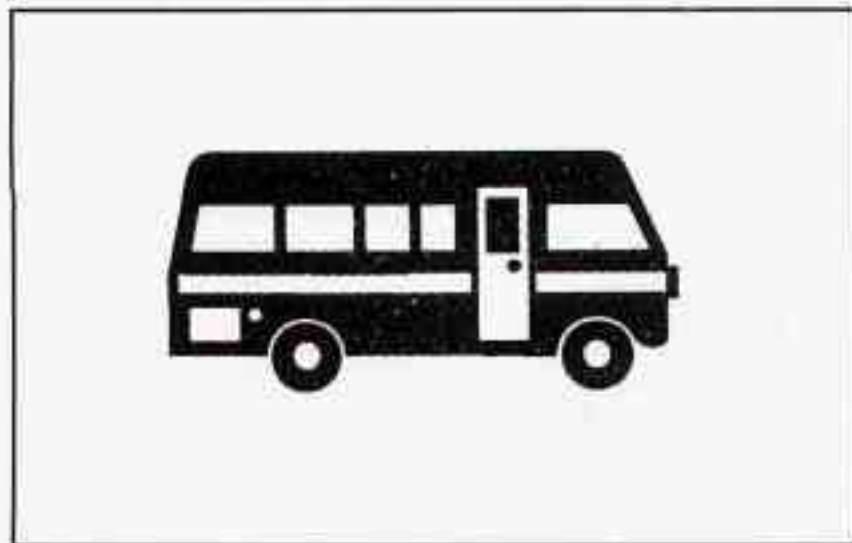

Pontiac strives to give you a worry free ownership of your vehicle, and we realize the inconvenience of being without a car. So Pontiac has come up with a way to eliminate any frustrations you might have when trying to get a ride to work, or wondering how you will get home. Well, your worries are over. Pontiac provides no-cost transportation when you bring your 1996 Pontiac in for warranty service.

It applies to any repair covered under the 3 year/36,000 mile limited warranty, and to any 1996 Pontiac requiring repair as a result of product recall or special policy situations. For same day service, you are entitled to one-way shuttle service of up to 10 miles. If the repairs require an overnight stay for the car, you're entitled to either a Pontiac loaner or reimbursement for a rental car, up to \$30/day, for up to 5 days.

Some state insurance regulations make it impractical to rent vehicles to people under 21 years of age. If you are under 21 and have difficulty renting a vehicle, Pontiac will reimburse you, up to \$30/day, for any documented transportation you receive.

For warranty repairs during the Complete Vehicle Coverage period in the New Vehicle Limited Warranty, interim transportation may be available under the Courtesy Transportation Program. Please consult your dealer for details. The Roadside Assistance program is available only in the United States and Canada.

GM Participation in BBB AUTO LINE -- Alternative Dispute Resolution Program*

*This program may not be available in all states, depending on state law. Canadian owners refer to your Warranty and Owner Assistance Information booklet. General Motors reserves the right to change eligibility limitations and/or to discontinue its participation in this program.

Both Pontiac and your Pontiac dealer are committed to making sure you are completely satisfied with your new vehicle. Our experience has shown that, if a situation arises where you feel your concern has not been adequately addressed, the Customer Satisfaction Procedure described earlier in this section is very successful.

There may be instances where an impartial third party can assist in arriving at a solution to a disagreement regarding vehicle repairs or interpretation of the New Vehicle Limited Warranty. To assist in resolving these disagreements, Pontiac voluntarily participates in BBB AUTO LINE.

BBB AUTO LINE is an out-of-court program administered by the Better Business Bureau system to settle disputes between customers and automobile manufacturers. This program is available free of charge to customers who currently own or lease a GM vehicle.

If you are not satisfied after following the Customer Satisfaction Procedure, you may contact the BBB using the toll-free telephone number, or write them at the following address:

BBB AUTO LINE
Council of Better Business Bureaus
4200 Wilson Boulevard
Suite 800
Arlington, VA 22203
Telephone: 1-800-955-5100

To file a claim, you will be asked to provide your name and address, your Vehicle Identification Number (VIN) and a statement of the nature of your complaint. Eligibility is limited by vehicle age and mileage, and other factors.

We prefer you utilize the Customer Satisfaction Procedure before you resort to AUTO LINE, but you may contact the BBB at any time. The BBB will attempt to resolve the complaint serving as an intermediary between you and Pontiac. If this mediation is unsuccessful, an informal hearing will be scheduled where eligible customers may present their case to an impartial third-party arbitrator.

The arbitrator will make a decision which you may accept or reject. If you accept the decision, GM will be bound by that decision. The entire dispute resolution procedure should ordinarily take about 40 days from the time you file a claim until a decision is made.

Some state laws may require you to use this program before filing a claim with a state-run arbitration program or in the courts. For further information, contact the BBB at 1-800-955-5100 or the Pontiac Customer Assistance Center at 1-800-PM-CARES.

REPORTING SAFETY DEFECTS TO THE UNITED STATES GOVERNMENT

If you believe that your vehicle has a defect which could cause a crash or could cause injury or death, you should immediately inform the National Highway Traffic Safety Administration (NHTSA), in addition to notifying General Motors.

If NHTSA receives similar complaints, it may open an investigation, and if it finds that a safety defect exists in a group of vehicles, it may order a recall and remedy campaign. However, NHTSA cannot become involved in individual problems between you, your dealer, or General Motors.

To contact NHTSA, you may either call the Auto Safety Hotline toll-free at 1-800-424-9393 (or 366-0123 in the Washington, D.C. area) or write to:

NHTSA, U.S. Department of Transportation
Washington, D.C. 20590

You can also obtain other information about motor vehicle safety from the Hotline.

REPORTING SAFETY DEFECTS TO THE CANADIAN GOVERNMENT

If you live in Canada, and you believe that your vehicle has a safety defect, you should immediately notify Transport Canada, in addition to notifying General Motors of Canada Limited. You may write to:

Transport Canada
Box 8880
Ottawa, Ontario K1G 3J2

REPORTING SAFETY DEFECTS TO GENERAL MOTORS

In addition to notifying NHTSA (or Transport Canada) in a situation like this, we certainly hope you'll notify us. Please call us at 1-800-PM-CARES or write:

Pontiac Division
Customer Assistance Center
One Pontiac Plaza
Pontiac, MI 48340-2952

In Canada, please call us at 1-800-263-3777 (English) or 1-800-263-7854 (French). Or, write:

General Motors of Canada Limited
Customer Assistance Center
1908 Colonel Sam Drive
Oshawa, Ontario L1H 8P7

Service and Owner Publications



Service Manuals

Service manuals contain diagnostic and repair information for all chassis and body systems. They may be useful for owners who wish to get a greater understanding of their vehicle. They are also useful for owners with the appropriate skill level or training who wish to perform "do-it-yourself" service. These are authentic General Motors service manuals meant for professional, qualified technicians.

Service manuals, service bulletins, owner's manuals and other service literature are available for purchase for all current and many past model General Motors vehicles.

Toll-free telephone numbers for ordering information:

United States 1-800-551-4123

Canada 1-800-668-5539

Service Bulletins

Service bulletins covering various subjects are regularly sent to all General Motors dealerships. GM monitors product performance in the field. When service methods are found which promote better service on GM vehicles, bulletins are created to help the technician perform better service. Service bulletins may involve any number of vehicles. Some will describe inexpensive service; others will describe expensive service. Some will advise of new or unexpected conditions, and others may help avoid future costly repairs. Service bulletins are meant for qualified technicians. In some cases bulletins refer to service manuals, specialized tools, equipment and safety procedures necessary to service the vehicle. Since these bulletins are issued throughout the model year and beyond, an index is required and published quarterly to help identify specific bulletins. Subscriptions are available. You can order an index at the toll-free numbers listed previously, or ask a GM dealer to see an index or individual bulletin.

Owner Publications

Owner's manuals, warranty folders and various owner assistance booklets provide owners with general operation and maintenance information.



A ccess Panel, Trunk	2-39	Appearance Care Materials	6-63
Accessory Outlet	2-42	Arbitration Program	8-8
Air Bag	1-23	Armrest, Storage	2-38
How Does it Restrain	1-27	Ashtrays	2-40
How it Works	1-25	Audio Controls, Steering Wheel Touch Control	3-21
Location	1-25, 1-26	Audio Equipment, Adding	3-22
Readiness Light	1-25, 2-47	Audio Systems	3-5
Servicing	1-29	Auto-Down Window	2-25
What Makes it Inflate	1-27	Automatic Door Locks	2-4
What Will You See After it Inflates	1-28	Automatic Transaxle	
When Should it Inflate	1-27	Check	7-37
Air Cleaner	6-16	Fluid	6-17
Air Conditioning	3-2	Operation	2-14
Air Conditioning Refrigerants	6-75	Park Mechanism Check	7-39
Alignment and Balance, Tire	6-54	B attery	6-30
Aluminum Wheels, Cleaning	6-61	Jump Starting	5-2
Antenna, Power	3-24	Replacement, Remote Lock Control	2-6
Antifreeze	6-20	Saver	2-36
Anti-Lock		Warnings	5-2, 5-4
Brake System Active Light	2-50, 4-8	BBB Auto Line	8-8
Brake System Warning Light	2-49, 4-7	Better Business Bureau Mediation	8-8
Brakes	4-6		
Anti-Theft, Radio	3-19		
Appearance Care	6-56		

Brake		Certification Label	4-29
Adjustment	6-29	Chains, Safety	4-34
Fluid	6-26	Chains, Tire	6-56
Master Cylinder	6-26	Changing a Flat Tire	5-23
Parking	2-18	Charging System Light	2-47
Pedal Travel	6-29	Checking Your Restraint Systems	1-62
Replacing System Parts	6-30	Chemical Paint Spotting	6-62
System Warning Light	2-48	Child Restraints	1-44
Trailer	4-34	Securing in a Rear Outside Seat Position	1-46
Transaxle Shift Interlock Check	7-38	Securing in the Center Rear Seat Position	1-48
Transaxle Shift Interlock	2-22	Securing in the Passenger Seat Position	1-50, 1-53
Wear	6-29	Securing in the Right Front Seat Position	1-50, 1-53
Brakes, Anti-Lock	4-6	Top Strap	1-45
Braking	4-5	Where to Put	1-44
Braking in Emergencies	4-9	Cigarette Lighter	2-41
Break-In, New Vehicle	2-10	Circuit Breakers and Fuses	6-65
Brightness Control	2-34	Cleaner, Air	6-16
BTSI	2-22	Cleaning	
BTSI Check	7-38	Aluminum Wheels	6-61
Bulb Replacement	6-31	Fabric	6-57
		Glass	6-59
C anadian Roadside Assistance	8-5	Inside of Your Pontiac	6-57
Capacities and Specifications	6-73	Instrument Panel	6-59
Carbon Monoxide	2-23, 4-27, 4-33	Leather	6-59
Cassette Deck Service	7-36	Outside of Your Pontiac	6-60
Cassette Tape Player	3-7, 3-11	Special Problems	6-58
Cassette Tape Player Care	3-23	Stains	6-57
Cassette Tape Player Errors	3-9	Tires	6-62
CD Player Theft-Deterrent Feature	3-19	Vinyl	6-59
Center High-Mounted Stoplamp	6-44, 6-45	Wheels	6-61
Center Passenger Position	1-34	Windshield and Wiper Blades	6-60
		Climate Control System	3-1

Clock, Setting the	3-5
Comfort Controls	3-1
Compact Disc Care	3-23
Compact Disc Player	3-14, 3-16
Compact Disc Player Errors	3-15
Compact Spare Tire	5-33
Console Storage	2-39
Control of a Vehicle	4-5
Convenience Net	2-40
Convex Outside Mirror	2-38
Coolant	6-20
Bleed Valves	5-20
Heater, Engine	2-13
Recovery Tank	5-16
Cooling System	5-14
Courtesy Lamps	2-34
Courtesy Transportation	8-7
Cruise Control	2-29
Cupholders	2-38
Customer Assistance for Text Telephone Users	8-4
Customer Assistance Information	8-1
Customer Satisfaction Procedure	8-2
D amage, Finish	6-62
Damage, Sheet Metal	6-62
Daytime Running Lamps	2-33
Dead Battery	5-2
Defects, Reporting Safety	8-9
Defensive Driving	4-1
Defogger, Rear Window	3-4
Defogging	3-4

Defrosting	3-4
Dimensions, Vehicle	6-75
Dolby [®] B Noise Reduction	3-10
Dome Lamp	2-36
Door Locks	2-3
Drive Position, Automatic Transaxle	2-16
Driver Position	1-10, 1-16
Driving	
City	4-19
Defensive	4-1
Drunken	4-2
Freeway	4-20
In a Blizzard	4-26
In Foreign Countries	6-4
In the Rain	4-16
Night	4-14
On Curves	4-9
On Grades While Towing a Trailer	4-36
On Hill and Mountain Roads	4-22
On Snow and Ice	4-25
Through Water	4-18
Wet Roads	4-16
Winter	4-24
With a Trailer	4-34
Drunken Driving	4-2
E lectrical Equipment, Adding	2-12, 3-22, 6-64
Electrical System	6-64

Engine	6-8, 6-9
Coolant	6-20
Coolant Heater	2-13
Coolant Level Check	7-36
Coolant Temperature Gage	2-51
Coolant Temperature Light	2-50
Exhaust	2-23
Identification	6-64
Overheating	5-12
Running While Parked	2-24
Specifications	6-74
Starting Your	2-11
Adding	6-11
Additives	6-14
Checking	6-11
Level Check	7-36
Used	6-15
When to Change	6-15
Ethanol	6-3
Exhaust, Engine	2-23
F abric Cleaning	6-57
Fan Knob, Climate Control System	3-1
Filling Your Tank	6-4
Filter, Air	6-16
Filter, Engine Oil	6-15
Finish Care	6-61
Finish Damage	6-62
First Gear, Automatic Transaxle	2-17
Flashers, Hazard Warning	5-1
Flat Tire, Changing	5-23
Fluids and Lubricants	7-41
Fog Lamp Bulb Replacement	6-42, 6-43
Fog Lamps	2-33

Foreign Countries, Fuel	6-4
French Language Manual	ii
Front Lamp Bar Bulb Replacement	6-38
Front Sidemarker Bulb Replacement	6-40
Front Towing	5-9
Front Turn Signal Bulb Replacement	6-40
Fuel	6-2
Filling Your Tank	6-4
Gage	2-56
In Foreign Countries	6-4
Canadian	6-3
Fuses and Circuit Breakers	6-65

Gages

Engine Coolant Temperature	2-51
Fuel	2-56
GAWR	4-29
Gear Positions, Automatic Transaxle	2-14
Glove Box	2-38
Gross Axle Weight Rating	4-29
Gross Vehicle Weight Rating	4-29
Guide en Français	ii
GVWR	4-29

Halogen Bulbs

Hazard Warning Flashers	5-1
Head Restraints	1-5
Headlamps	2-32
Aiming	6-35
Bulb Replacement	6-31 6-34
High/Low Beam Changer	2-27
On Reminder	2-32
Wiring	6-65

Head-Up Display	2-58
Hearing Impaired, Customer Assistance	8-4
Heating	3-3
High-Beam Headlamps	2-27
Highway Hypnosis	4-22
Hill and Mountain Roads	4-22
Hitches, Trailer	4-33
Hood	
Checking Things Under	6-6
Release	6-7
Horn	2-25
HUD	2-58
Hydroplaning	4-18
I gnition Positions	2-10
Inflation, Tire	6-49
Inside Day/Night Rearview Mirror	2-37
Inspections	
Brake System	7-40
Exhaust Systems	7-40
Front-Wheel-Drive Axle Boot	7-40
Front-Wheel-Drive Axle Seal	7-40
Radiator and Heater Hose	7-40
Steering	7-40
Suspension	7-40
Throttle Linkage	7-40
Instrument Panel	2-43
Brightness Control	2-34
Cleaning	6-59
Cluster	2-44
Fuse Block	6-65
Interior Lamps	2-34

J ack, Tire	5-23
Jump Starting	5-2
K ey Lock Cylinders Service	7-37
Key Reminder Warning	2-11
Keys	2-1

L abels	
Certification	4-29
Service Parts Identification	6-64
Tire-Loading Information	4-28
Vehicle Identification Number	6-64
Lamps	2-32
Courtesy	2-34
Dome	2-36
Interior	2-34
On Reminder	2-32
Sustained Interior Illumination	2-34
Latches, Seatback	1-5
Leaving Your Vehicle	2-4
Leaving Your Vehicle With the Engine Running	2-21
Lighter	2-41
Lights	
Air Bag Readiness	1-25, 2-47
Anti-Lock Brake System Active	2-50, 4-8
Anti-Lock Brake System Warning	2-49, 4-7
Brake System Warning	2-48
Charging System	2-47
Engine Coolant Temperature	2-50
Interior	2-34
Low Coolant Warning	2-51
Low Fuel	2-57

Low Oil Level	2-55
Oil Warning	2-54
Safety Belt Reminder	1-6, 2-46
Security	2-56
Service Engine Soon	2-52
Loading Your Vehicle	4-28
Locks	2-3
Automatic Door	2-4
Cylinders	7-37
Door	2-3
Key Lock Cylinder Service	7-37
Power Door	2-3
Steering Column Lock Check	7-39
Trunk	2-7
Window	2-25
Low Coolant Warning Light	2-51
Low Fuel Light	2-57
Low Oil Level Light	2-55
Lubricants and Fluids	7-41
Lubrication Service, Body	7-37

M aintenance, Normal Replacement Parts	6-75
Maintenance Record	7-43
Maintenance Schedule	7-1
Long Trip/Highway Definition	7-5
Long Trip/Highway Intervals	7-5, 7-26
Owner Checks and Services	7-36
Periodic Maintenance Inspections	7-40
Recommended Fluids and Lubricants	7-41
Scheduled Maintenance Services	7-3
Short Trip/City Definition	7-4
Short Trip/City Intervals	7-4, 7-6

Maintenance, Underbody	6-62
Maintenance When Trailer Towing	4-37
Malfunction Indicator Lamp	2-52
Manual Front Seat	1-1
Methanol	6-3
Mirrors	2-37
Convex Outside	2-38
Inside Day/Night Rearview	2-37
Manual Outside	2-37
Power Outside	2-37
Visor Vanity	2-41
MMT	6-3
Mode Knob, Climate Control System	3-2
Mountain Roads	4-22
Multifunction Lever	2-26

N et, Convenience	2-40
Neutral, Automatic Transaxle	2-15
New Vehicle "Break-In"	2-10
Night Vision	4-15

O dometer	2-45
Odometer, Trip	2-45
Off-Road Recovery	4-11
Oil, Engine	6-10
Oil Warning Light	2-54
Overheating Engine	5-12
Owner Checks and Services	7-36
Owner Publications, Ordering	8-12

Paint Spotting, Chemical	6-62	Radiator	5-19
Park		Radiator Pressure Cap	6-24
Automatic Transaxle	2-14	Radio Reception	3-22
Shifting Into	2-19	Radios	3-5
Shifting Out of	2-22	Rain, Driving In	4-16
Parking		Reading Lamps	2-35, 2-36
At Night	2-8	Rear	
Brake	2-18	Lamp Bar Bulb Replacement	6-47
Brake Mechanism Check	7-39	Outside Seat Position	1-36
Lots	2-8	Safety Belt Comfort Guides	1-39
Over Things That Burn	2-23	Seat Passengers	1-36
With a Trailer	4-37	Towing	5-10
Passenger Position	1-30, 1-34	Window Defogger	3-4
Passing	4-12	Rearview Mirror, Inside Day/Night	2-37
PASS-Key® II	2-8	Reclining Front Seatbacks	1-3
Periodic Maintenance Inspections	7-40	Recovery Tank, Coolant	5-16
Pontiac Cares Program	8-1	Refrigerants, Air Conditioning	6-75
Power		Remote	
Accessory Outlet	2-42	Lock Control	2-4
Antenna Mast Care	3-24	Trunk Release	2-7
Antenna Service	7-36	Replacement	
Door Locks	2-3	Bulbs	6-72
Option Fuses	6-65	Parts	6-75
Outside Mirror	2-37	Wheel	6-54
Seat	1-2	Replacing Safety Belts	1-62
Steering Fluid	6-24	Reporting Safety Defects	8-9
Steering	4-9	Restraints	
Windows	2-25	Checking	1-62
Pregnancy, Use of Safety Belts	1-30	Child	1-44
Problems on the Road	5-1	Head	1-5
Publications, Service and Owner	8-11	Replacing Parts After a Crash	1-62
		System Check	7-37
		Reverse, Automatic Transaxle	2-15
		Right Front Passenger Position	1-30, 1-34

Roadside Assistance	8-5
Roadside Assistance, Canadian	8-5
Rocking Your Vehicle	5-34
Rotation, Tires	6-50

S afety Belt Extender	1-62
Safety Belts	1-5
Adults	1-10
Automatic Lap-Shoulder	1-31
Care	6-59
Center Passenger Position	1-34
Children	1-42
Driver Position	1-10, 1-16
Extender	1-62
How to Wear Properly	1-10
Incorrect Usage	1-12, 1-19, 1-60, 1-61
Lap Belt	1-34
Lap-Shoulder	1-10, 1-16, 1-31, 1-34, 1-36
Larger Children	1-59
Questions and Answers	1-9
Rear Comfort Guides	1-39
Rear Seat Outside Passenger Positions	1-36
Rear Seat Passengers	1-36
Reminder Light	1-6, 2-46
Replacing After a Crash	1-62
Right Front Passenger Position	1-30, 1-34
Smaller Children and Babies	1-42
Use During Pregnancy	1-30
Why They Work	1-6
Safety Chains	4-34
Safety Defects, Reporting	8-9
Safety Warnings and Symbols	iii
Scheduled Maintenance Services	7-3

Seatback	
Latches	1-5
Reclining Front	1-3
Seats	
Manual Front	1-1
Power	1-2
Restraint Systems	1-1
Seat Controls	1-1
Securing a Child Restraint	1-44
Second Gear, Automatic Transaxle	2-17
Second-Gear Start, Automatic Transaxle	2-18
Security Light	2-56
Security System	2-8
Service	6-1
Bulletins, Ordering	8-12
Engine Soon Light	2-52
Manuals, Ordering	8-11
Parts Identification Label	6-64
Publications, Ordering	8-11
Work, Doing Your Own	6-2
Service and Appearance Care	6-1
Service and Owner Publications	8-11
Service Publications	8-11
Servicing Your Air Bag-Equipped Pontiac	1-29
Sheet Metal Damage	6-62
Shift Lever	2-14
Shifting	
Automatic Transaxle	2-14
Into Park (P)	2-19
Out of Park	2-22
Signaling Turns	2-27
Skidding	4-13
Sound Equipment, Adding	3-22
Spare Tire, Compact	5-33

Specifications and Capacities	6-73	THEFTLOCK™	3-19
Specifications, Engine	6-74	Thermostat	6-24
Speech Impaired, Customer Assistance	8-4	Third Gear, Automatic Transaxle	2-16
Speedometer	2-45	Tilt Steering Wheel	2-26
SRS	1-23	Time, Setting the	3-5
Stains, Cleaning	6-57	Tire Chains	6-56
Starter Switch Check	7-38	Tire Loading	4-28
Starting Your Engine	2-11	Tire-Loading Information Label	4-28
Steam	5-12	Tires	6-48
Steering	4-9	Alignment and Balance	6-54
Column Lock Check	7-39	Buying New	6-52
In Emergencies	4-10	Chains	6-56
Power	4-9	Changing a Flat	5-23
Tips	4-9	Cleaning	6-62
Variable Assist	4-9	Compact Spare	5-33
Wheel, Tilt	2-26	Inflation	6-49
Wheel Touch Controls	3-21	Inflation Check	7-36
Storage Compartments	2-38	Inspection and Rotation	6-50
Storage, Vehicle	6-30	Loading	4-28
Stuck: In Sand, Mud, Ice or Snow	5-34	Pressure	6-49
Sun Visors	2-41	Temperature	6-54
Sunroof	2-42	Traction	6-53
Supplemental Restraint System	1-23	Treadwear	6-53
Sustained Interior Illumination	2-34	Uniform Quality Grading	6-53
Symbols, Vehicle	v	Wear Indicators	6-51
T achometer	2-45	Wheel Replacement	6-54
Taillamp Bulb Replacement	6-46	When It's Time for New	6-51
Tape Player Care	3-23	Top Strap	1-45
Temperature Knob, Climate Control System	3-1	Torque Lock	2-22
Theft-Deterrent Feature, CD Player	3-19	Torque, Wheel Nut	5-30
Theft	2-8	Towing a Trailer	4-30
		Towing Your Vehicle	5-7

Trailer			
Brakes	4-34	Dimensions	6-75
Driving on Grades	4-36	Identification Number	6-64
Driving With	4-34	Loading	4-28
Hitches	4-33	Storage	6-30
Maintenance When Towing	4-37	Ventilation System	3-3
Parking on Hills	4-37	Visor Vanity Mirrors	2-41
Safety Chains	4-34	Visors, Sun	2-41
Tongue Weight	4-32	W arning Devices	5-2
Total Weight on Tires	4-33	Warning Lights, Gages and Indicators	2-46
Towing	4-30	Washer Fluid, Windshield	6-25
Turn Signals	4-36	Washing Your Vehicle	6-60
Weight	4-32	Weatherstrips	6-60
Transmitters, Remote Lock Control	2-4	Wheel	
Transportation, Courtesy	8-7	Alignment	6-54
Trip Calculator	2-57	Nut Torque	5-30
Trip Odometer	2-45	Replacement	6-54
Trunk	2-7	Wrench	5-25
Access Panel	2-39	Windows	2-25
Lock	2-7	Auto-Down	2-25
Release, Remote	2-7	Lock Out	2-25
TTY Users	8-4	Power	2-25
Turn Signal and Lane Change Signals	2-27	Windshield Washer	2-28
Turn Signal On Chime	2-27	Fluid	2-28, 6-25
Turn Signal/Multifunction Lever	2-26	Fluid Level Check	7-36
Turn Signals When Towing a Trailer	4-36	Windshield Wiper	2-28
U nderbody Flushing Service	7-39	Blade Replacement	6-48
Underbody Maintenance	6-62	Fuses	6-65
Underhood Electrical Center	6-68, 6-70	Winter Driving	4-24
V ehicle		Wiring, Headlamp	6-65
Control	4-5	Wrecker Towing	5-7
Damage Warnings	iv	Wrench, Wheel	5-25

1996 1996 1996 1996 1996 1996

