













1993
PONTIAC
Grand Am

OWNER'S MANUAL



Introduction	How to Use this Manual	3	
Part 1	Seats & Safety Belts	7	
Part 2	Features & Controls	43	
Part 3	Comfort Controls & Audio Systems	101	
Part 4	Your Driving and the Road	121	
Part 5	Problems on the Road	169	
Part 6	Service & Appearance Care	197	
Part 7	Maintenance Schedule	259	
Part 8	Customer Assistance Information Includes "Reporting Safety Defects" on page 284	279	
Part 9	Index	293	
	Service Station Information	Last Page	

Important Notes About this Manual

Please keep this manual in your Pontiac, so it will be there if you ever need it when you're on the road. If you sell the vehicle, please leave this manual in it so the new owner can use it.

This manual includes the latest information at the time it was printed. We reserve the right to make changes in the product after that time without further notice.

Note to Canadian Owners

For vehicles first sold in Canada, substitute the name "General Motors of Canada Limited" for Pontiac Division whenever it appears in this manual.

For Canadian Owners Who Prefer a French Language Manual:

Aux propriétaires canadiens: Vous pouvez vous procurer un exemplaire de ce guide en français chez votre concessionnaire ou au DGN Marketing Services Ltd., 1500 Bonhill Road, Mississauga, Ontario L5T 1C7.

Published by **Pontiac Division**
General Motors Corporation

The word **Pontiac**, the Pontiac emblem and the name Grand Am are registered trademarks of General Motors Corporation.

The word **Delco** is a registered trademark of General Motors Corporation.

How to Use this Manual



Using Your 1993 Pontiac Owner's Manual

Many people read their owner's manual from beginning to end when they first receive their new vehicle. This will help you learn about the features and controls for your vehicle. In this manual, you'll find that pictures and words work together to explain things quickly.

There are nine parts with color-tabbed pages in this manual. Each part begins with a brief list of contents, so you can usually tell at a glance if that part contains the information you want.

You can bend the manual slightly to reveal the color tabs that help you find a part.

Part 1: Seats & Safety Belts

This part tells you how to use your seats and safety belts properly.

Part 2: Features & Controls

This part explains how to start and operate your Pontiac.

Part 3: Comfort Controls & Audio Systems

This part tells you how to adjust the ventilation and comfort controls and how to operate your audio system.

Part 4: Your Driving and the Road

Here you'll find helpful information and tips about the road and how to drive under different conditions.

Part 5: Problems on the Road

This part tells you what to do if you have a problem while driving, such as a flat tire or engine overheating.

Part 6: Service & Appearance Care

Here the manual tells you how to keep your Pontiac running properly and looking good.

Part 7: Maintenance Schedule

This part tells you when to perform vehicle maintenance and what fluids and lubricants to use.

Part 8: Customer Assistance Information

This part tells you how to contact Pontiac for assistance and how to get service publications. It also gives you information on *Reporting Safety Defects*.

Part 9: Index

Here's an alphabetical listing of almost every subject in this manual. You can use it to quickly find something you want to read.

Service Station Information

This is a quick reference of service information. You can find it on the last page of this manual.

How to Use this Manual

Safety Warnings and Symbols

You will find a number of safety cautions in this book. We use yellow and the word CAUTION to tell you about things that could hurt you if you were to ignore the warning.

CAUTION



These mean there is something that could hurt you or other people.

In the yellow caution area, we tell you what the hazard is. Then we tell you what to do to help avoid or reduce the hazard. Please read these cautions. If you don't, you or others could be hurt.

You will also find a red circle with a slash through it in this book. This safety symbol means:

Don't
Don't do this
Don't let this happen



Vehicle Damage Warnings

Also, in this book you will find these blue notices:

NOTICE

These mean there is something that could damage your vehicle.

In the blue notice area, we tell you about something that can damage your vehicle. Many times, this damage would not be covered by your warranty, and it could be costly. But the notice will tell you what to do to help avoid the damage.

When you read other manuals, you might see CAUTION and NOTICE warnings in different colors or in different words. In this manual, we've used the familiar words and colors that Pontiac has used for years.

You'll also see warning labels on your vehicle. They use the same colors, and the words CAUTION or NOTICE.

Vehicle Symbols

These are some of the symbols you will find on your vehicle. For example, these symbols are used on an original battery:

Caution Possible Injury



Protect Eyes by Shielding



*Caustic Battery Acid
Could Cause Burns*



Avoid Sparks or Flames



*Spark or Flame Could
Explode Battery*



These symbols are important for you and your passengers whenever your vehicle is driven:

Fasten Safety Belts



Door Lock/Unlock



These symbols have to do with your lights:

Master Lighting Switch



Turn Signal Direction



Hazard Warning Flashers



Headlight High Beam



Parking Lights



Fog Lamps



How to Use this Manual

Vehicle Symbols (CONT.)

These symbols are on some of your controls:

Windshield Wipers



Windshield Washer



Windshield Defroster



Rear Window Defogger

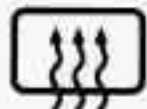

Ventilating Fan



Power Window



These symbols are used on warning and indicator lights:

Engine Coolant Temperature



Battery Charging System



Fuel



Engine Oil Pressure



Brake



Anti-Lock Brakes



Here are some other symbols you may see:

Fuse



Trunk Release



Lighter



Horn



Speaker



Hood Release





Part 1

Seats & Safety Belts

Here you'll find information about the seats in your Pontiac, and how to use your safety belts properly. You can also learn about some things you should **not** do with safety belts.

Seats and Seat Controls	8
Safety Belts	12
How to Wear Safety Belts Properly	17
Driver Position	18
Safety Belt Use During Pregnancy	22
Right Front Passenger Position	22
Rear Seat Passengers	23
Rear Safety Belt Comfort Guides	26
Center Passenger Position	28
Children	29
Smaller Children and Babies	29
Child Restraints	30
Larger Children	38
Safety Belt Extender	40
Replacing Safety Belts After a Crash	40

Seats & Safety Belts

■ *Seats and Seat Controls*

This section tells you about the seats—how to adjust them—and also about reclining seatbacks and head restraints.

Manual Front Seat

CAUTION

 You can lose control of the vehicle if you try to adjust a manual driver's seat while the vehicle is moving. The sudden movement could startle and confuse you, or make you push a pedal when you don't want to. Adjust the driver's seat only when the vehicle is not moving.



Move the control lever under the front of the seat to unlock it. Slide the seat to where you want it. Then release the lever and try to move the seat with your body, to make sure the seat is locked into place.



Manual 4-Way Adjustable Seat (OPTION)

There are two levers at the front of the seat. The left lever adjusts the seat forward and back. The right lever adjusts the angle of the front of the seat.

To Adjust the Seat's Forward and Rearward Movement:

Lift the left lever up and adjust the seat forward or back. Then release the lever and try to move the seat to be certain that it is locked in place.

To Raise or Lower the Front of the Seat:

Lift the right lever, and lean forward or backward.

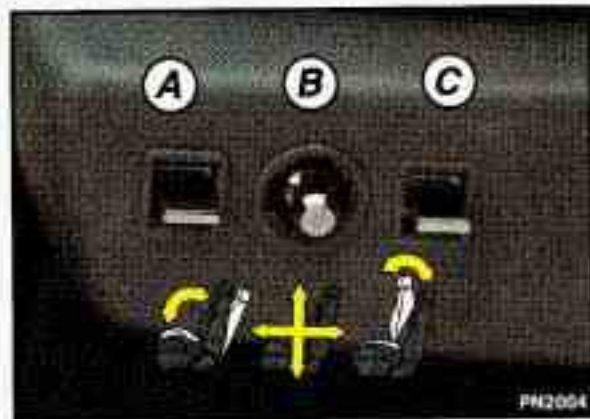

Power Seat Controls (OPTION)

To adjust the power seat on some models:

Front Control (A): Raise the front of the seat by holding the switch up. Lower the front of the seat by holding the switch down.

Center Control (B): Move the seat forward or back by holding the control to the front or back.

Move the seat higher by holding the control up. Lower the seat by holding the control down.

Rear Control (C): Raise the rear of the seat by holding the switch up. Lower the rear of the seat by holding the switch down.



Manual Lumbar Support

Turn the knob on the side of the driver's seat clockwise to increase support to the lower back. Turn the knob counter-clockwise to decrease the support.

Seats & Safety Belts



Manual Reclining Seatback

To adjust the seatback, lift the lever on the outer side of the seat and move the seatback where you want it. Release the lever to lock the seatback.

Pull up on the lever and the seat will go to an upright position.

Don't have a seatback reclined, however, if your vehicle is moving.

CAUTION



Sitting in a reclined position when your vehicle is in motion can be dangerous. Even if you buckle up, your safety belts can't do their job when you're reclined like this.

The shoulder belt can't do its job because it won't be against your body. Instead, it will be in front of you. In a crash you could go into it, receiving neck or other injuries.

The lap belt can't do its job either. In a crash the belt could go up over your abdomen. The belt forces would be there, not at your pelvic bones. This could cause serious internal injuries.

For proper protection when the vehicle is in motion, have the seatback upright. Then sit well back in the seat and wear your safety belt properly.



Head Restraints

Head restraints are fixed on some vehicles and adjustable on others. Slide an adjustable head restraint up or down so that the top of the restraint is closest to the top of your ears.

This position reduces the chance of a neck injury in a crash.

On some models, the head restraints tilt forward and rearward also.



Front Seatback Latches ***(2-DOOR MODELS)***

The front seatback folds forward to let people get into the back seat. Your seatback will move back and forth freely, unless you come to a sudden stop. Then it will lock into place.

There's one time the front seats may not fold without some help from you. That's if your vehicle is parked facing down a fairly steep hill.

To fold a front seatback forward, push the seatback toward the rear seat as you lift this latch. Then the seatback will fold forward. The latch must be down for the seat to work properly.

Easy-Entry Seat ***(2-DOOR MODELS)***

The right front seat of your vehicle makes it easy to get in and out of the rear seat.

- When you tilt the right front seatback fully forward, the whole seat will slide forward.
- After someone gets into the rear seat area, move the right front seatback to its original position. Then move the seat rearward until it locks.

Seats & Safety Belts



Easy-Entry Seat (CONT.)

CAUTION

 If an easy-entry right front seat isn't locked, it can move. In a sudden stop or crash, the person sitting there could be injured. After you've used it, be sure to push rearward on an easy-entry seat to be sure it is locked.

To get out, again tilt the seatback fully forward.

Split Fold-Down Rear Seat (OPTION)

To Open:

Pull forward on the seat tab.

To Close:

Push the seatback up to its original position.

Push the seatback solidly up against the back plate to ensure inertial latch will hook and lock securely during sudden stops.

■ *Safety Belts: They're For Everyone*

This part of the manual tells you how to use safety belts properly. It also tells you some things you should not do with safety belts.

CAUTION

 Don't let anyone ride where they can't wear a safety belt properly. If you are in a crash and you're not wearing a safety belt, your injuries can be **much** worse. You can hit things inside the vehicle or be ejected from it. You can be seriously injured or killed. In the same crash, you might not be if you are buckled up. Always fasten your safety belt, and check that your passengers' belts are fastened properly too.



This figure lights up when you turn the key to **Run** or **Start** when your safety belt isn't buckled, and you'll hear a chime, too. It's the reminder to buckle up. In many states and Canadian provinces, the law says to wear safety belts. Here's why: **They work.**



You never know if you'll be in a crash. If you do have a crash, you don't know if it will be a bad one.

A few crashes are very mild. In them, you won't get hurt even if you're not buckled up. And some crashes can be so serious, like being hit by a train, that even buckled up a person wouldn't survive. But most crashes are in between. In many of them, people who buckle up can survive and sometimes walk away. Without belts they could be badly hurt or killed.

After 25 years of safety belts in vehicles, the facts are clear. In most crashes buckling up does matter . . . a lot!

Seats & Safety Belts

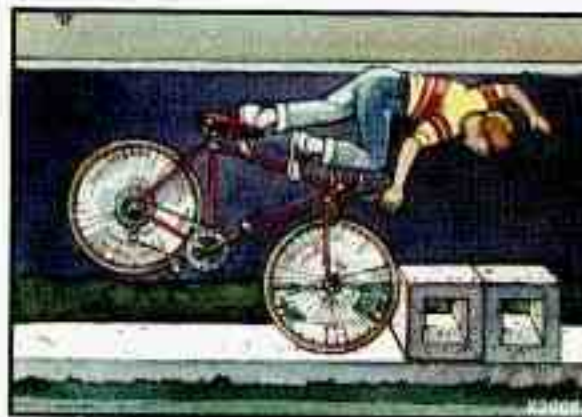

Why Safety Belts Work

When you ride in or on anything, you go as fast as it goes.

- 1. For example, if the bike is going 10 mph (16 km/h), so is the child.**

- 2. When the bike hits the block, it stops. But the child keeps going!**

- 3. Take the simplest "car." Suppose it's just a seat on wheels.**



4. Put someone on it.

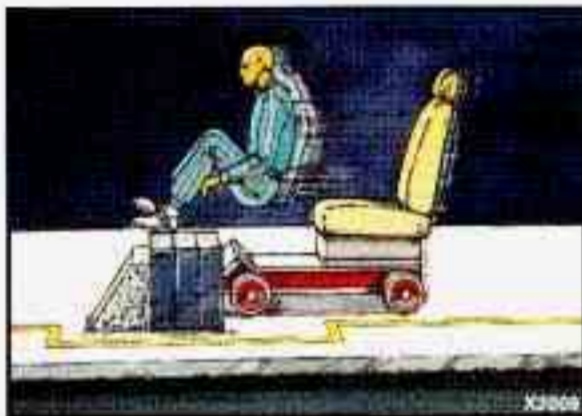

5. Get it up to speed. Then stop the "car." The rider doesn't stop.



6. The person keeps going until stopped by something. In a real vehicle, it could be the windshield...



7. or the instrument panel...



8. or the safety belts!

With safety belts, you slow down as the vehicle does. You get more time to stop. You stop over more distance, and your strongest bones take the forces. That's why safety belts make such good sense.

Seats & Safety Belts

Here Are Questions Many People Ask About Safety Belts—and the Answers

Q: Won't I be trapped in the vehicle after an accident if I'm wearing a safety belt?

A: You **could** be—whether you're wearing a safety belt or not. But you can easily unbuckle a safety belt, even if you're upside down. And your chance of being conscious during and after an accident, so you **can** unbuckle and get out, is **much** greater if you are belted.

Q: Why don't they just put in air bags so people won't have to wear safety belts?

A: "Air bags," or Supplemental Inflatable Restraint systems, are in some vehicles today and will be in more of them in the future. But they are supplemental systems only—so they work **with** safety belts, not instead of them. Every "air bag" system ever offered for sale has required the use of safety belts. Even if you're in a vehicle that has "air bags," you still have to buckle up to get the most protection. That's true not only in frontal collisions, but especially in side and other collisions.

Q: If I'm a good driver, and I never drive far from home, why should I wear safety belts?

A: You may be an excellent driver, but if you're in an accident—even one that isn't your fault—you and your passengers can be hurt. Being a good driver doesn't protect you from things beyond your control, such as bad drivers.

Most accidents occur within 25 miles (40 km) of home. And the greatest number of serious injuries and deaths occur at speeds of less than 40 mph (65 km/h).

Safety belts are for everyone.

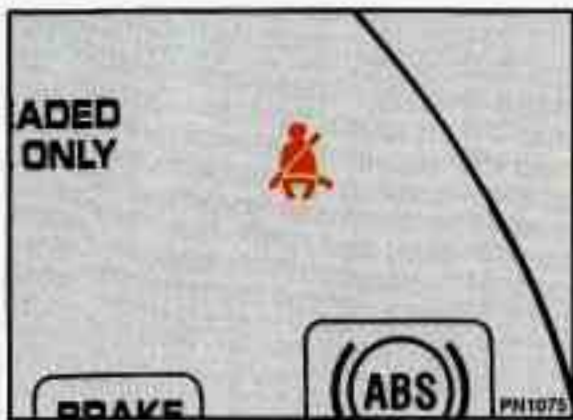

Safety Belt Warning Light

When the key is turned to **Run** or **Start**, a chime will come on for about eight seconds to remind people to fasten their safety belts, unless the driver's safety belt is buckled. The safety belt light will also come on and stay on for about a minute. If the driver's belt is buckled, neither the chime nor the light will come on.

CAUTION

 If your safety belt light ever comes on or stays on after the front doors are closed and the driver's belt is buckled, have your vehicle fixed.

If you don't, you might not have the protection you'd need in a crash.

How to Wear Safety Belts Properly—Adults

This section is only for people of adult size.

CAUTION

 There are special things to know about safety belts and children. And there are different rules for babies and smaller children. If a child will be riding in your Pontiac, see the *Index* under *Children and Safety Belts*. Follow those rules for everyone's protection.

First, you'll want to know which restraint systems your vehicle has. We'll start with the driver position.

Seats & Safety Belts

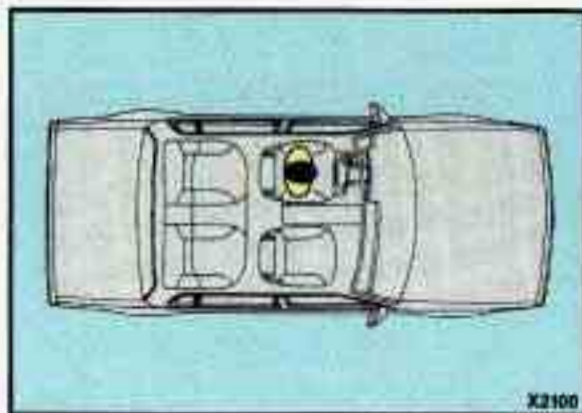

Vehicles First Sold in Canada

Was your Pontiac first sold, when new, in Canada? (If it was, a sticker on the driver's door will say "conforms to all applicable Canada motor vehicle . . ." etc.) If so, then the rest of Part 1 does not apply to your vehicle.

To learn how to use your safety belts, please read the **Owner's Manual Safety Belt Supplement**. It comes with every new Pontiac first sold in Canada.

Driver Position

This section describes the driver's restraint system.



Automatic Lap-Shoulder Belt

This safety belt is called "automatic" because you don't have to buckle up when you get into your vehicle.



And you don't have to unbuckle when you get out.

Just get into your vehicle. Then close and lock the door. Adjust the seat (to see how, see the *Index* under *Seat Controls*) so you can sit up straight.

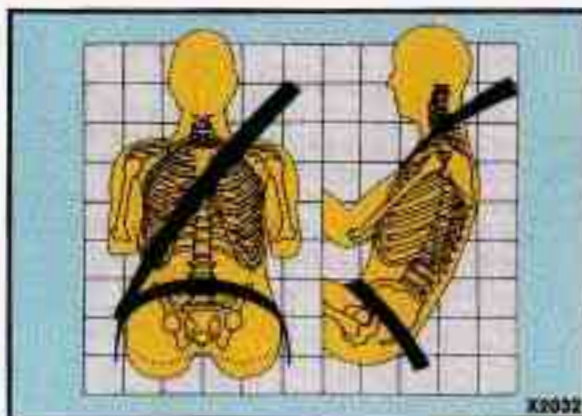

The lap belt should be worn as low on the hips as possible. In a crash, this applies force to the strong pelvic bones. And you'd be less likely to slide under the lap belt. If you slid under it, the belt would apply force at your abdomen. This could cause serious or even fatal injuries. The shoulder belt should go over the shoulder and across the chest. These parts of the body are best able to take belt restraining forces.

The safety belt locks if there's a sudden stop or a crash.

It's possible that an automatic belt could keep you from fully opening a door. That can happen if the door was slammed shut very hard. Just close the door all the way, then slowly open it. If that doesn't fix it, then your Pontiac needs service.

We hope you will always keep your automatic belt buckled. However, you may need to unbuckle it in an emergency.

Seats & Safety Belts



Automatic Lap-Shoulder Belt (CONT.)

To unbuckle the automatic belt, just push the button on the buckle.



To reattach the automatic belt:

1. Close and lock the door.
2. Adjust the seat (to see how, see the *Index* under *Seat Controls*) so you can sit up straight.
3. Pick up the latch plate and pull the belt across you. Don't let it get twisted.
4. Push the latch plate into the buckle until it clicks.



Q: What's wrong with this?

A: The shoulder belt is too loose. It won't give nearly as much protection this way.

CAUTION



You can be seriously hurt if your shoulder belt is too loose. In a crash, you would move forward too much, which could significantly increase injury. The shoulder belt should fit against your body.



Q: What's wrong with this?

A: The belt is buckled in the wrong place.

CAUTION

 You can be seriously injured if your belt is buckled in the wrong place like this. In a crash, the belt would go up over your abdomen. The belt forces would be there, not at the pelvic bones. This could cause serious internal injuries. Always buckle your belt into the buckle nearest you.

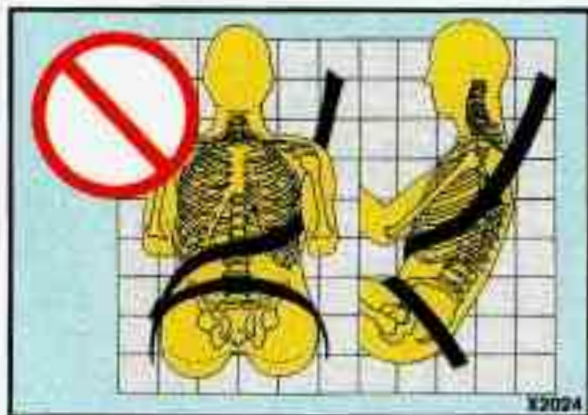

Q: What's wrong with this?

A: The shoulder belt is worn under the arm. It should be worn over the shoulder at all times.

CAUTION

 You can be seriously injured if you wear the shoulder belt under your arm. In a crash, your body would move too far forward, which would increase the chance of head and neck injury. Also, the belt would apply too much force to the ribs, which aren't as strong as shoulder bones. You could also severely injure internal organs like your liver or spleen.

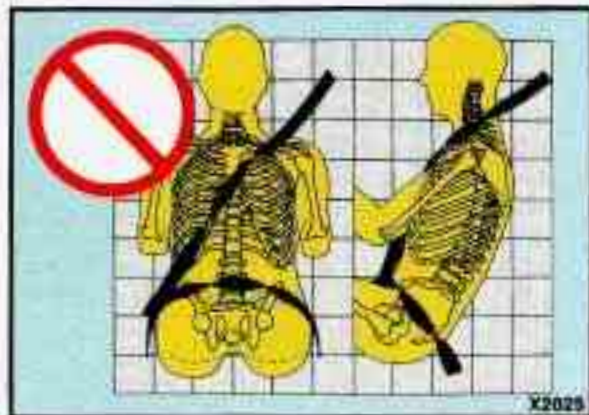

Q: What's wrong with this?

A: The belt is twisted across the body.

CAUTION

 You can be seriously injured by a twisted belt. In a crash, you wouldn't have the full width of the belt to take impact forces. If a belt is twisted, make it straight so it can work properly, or ask your dealer to fix it.

Seats & Safety Belts



Safety Belt Use During Pregnancy

Safety belts work for everyone, including pregnant women. Like all occupants, they are more likely to be seriously injured if they don't wear safety belts.

A pregnant woman should wear a lap-shoulder belt, and the lap portion should be worn as low as possible throughout the pregnancy.

The best way to protect the fetus is to protect the mother. When a safety belt is worn properly, it's more likely that the fetus won't be hurt in a crash. For pregnant women, as for anyone, the key to making safety belts effective is wearing them properly.

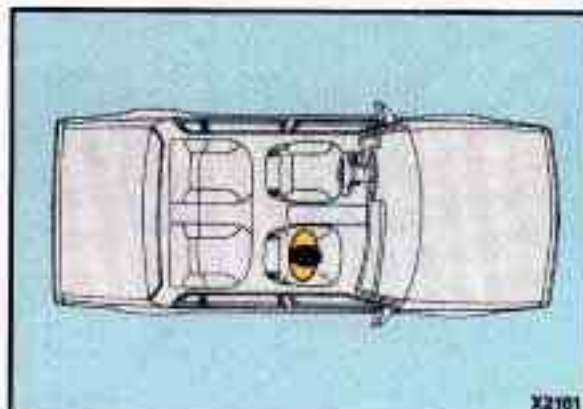

Right Front Passenger Position

The right front passenger's safety belt works the same way as the driver's safety belt.

See the *Index* under *Driver Position*.



Adjust the seat (to see how, see the *Index* under *Seat Controls*) so you can sit up straight. Move your seat far enough forward that your feet touch the part of the vehicle that is called the "toeboard" (A). That way you'd be less likely to slide under the lap belt in a crash.

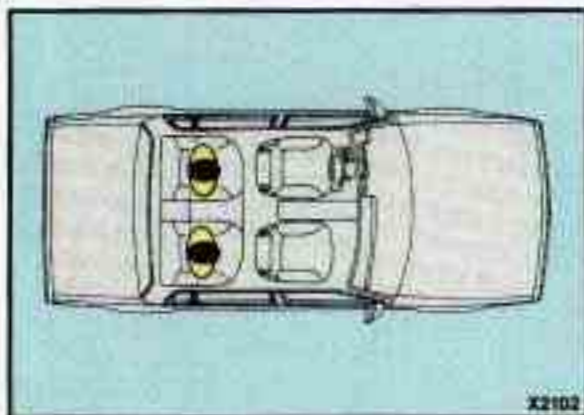

Rear Seat Outside Passenger Positions

The positions next to the windows have lap-shoulder belts.



Here's How to Wear One Properly:

- 1.** Pick up the latch plate and pull the belt across you. Don't let it get twisted.
- 2.** Push the latch plate into the buckle until it clicks.

Rear Seat Passengers

It's very important for rear seat passengers to buckle up! Accident statistics show that unbelted people in the rear seat are hurt more often in crashes than those who are wearing safety belts.

Rear passengers who aren't safety belted can be thrown out of the vehicle in a crash. And they can strike others in the vehicle who are wearing safety belts.

Seats & Safety Belts



Rear Seat Outside Passenger Positions (CONT.)

If the belt stops before it reaches the buckle, tilt the latch plate and keep pulling until you can buckle it.

If the belt is not long enough, see the *Index* under *Safety Belt Extender*.

Make sure the release button on the buckle faces upward or outward so you would be able to unbuckle it quickly if you ever had to.



3. To make the lap part tight, pull down on the buckle end of the belt as you pull up on the shoulder part.

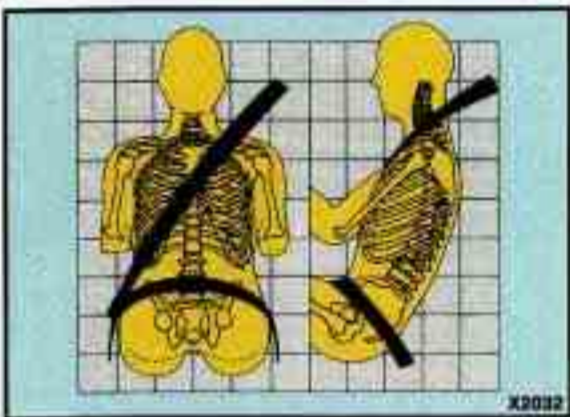

The lap part of the belt should be worn low and snug on the hips, just touching the thighs. In a crash, this applies force to the strong pelvic bones. And you'd be less likely to slide under the lap belt. If you slid under it, the belt would apply force at your abdomen. This could cause serious or even fatal injuries. The shoulder belt should go over the shoulder and across the chest. These parts of the body are best able to take belt restraining forces.

The safety belt locks if there's a sudden stop or a crash.

CAUTION



You can be seriously hurt if your shoulder belt is too loose. In a crash you would move forward too much, which could increase injury. The shoulder belt should fit against your body.



To unlatch the belt, just push the button on the buckle.

Seats & Safety Belts



Rear Safety Belt Comfort Guides for Children and Small Adults

Your vehicle may be equipped with rear shoulder belt comfort guides. This feature will provide added comfort for children who have outgrown child restraints, and for small adults. If your vehicle does not have comfort guides, you may ask your dealer to order and install them for you. The comfort guides pull the shoulder belts away from the neck and head.

There is one guide for each outside passenger position in the rear seat. You will find them tucked in between the seat back and the interior body, about half-way down the edge of the seat back. Here is how you should install the comfort guides on the shoulder belts:

1. Pull the elastic cord out from between the edge of the seat back and the interior body to remove the guide from its storage clip.
2. Slide the guide under and past the belt. The elastic cord must be under the belt. Then, place the guide over the belt, and insert the two edges of the belt into the slots of the guide.



3. Be sure that the belt is not twisted and it lies flat. The elastic cord must be under the belt and the guide on top.

4. Buckle the belt around the child, and make sure that both the lap belt and the shoulder belt are secured properly. Make sure that the shoulder belt crosses the shoulder. See the *Index* under *Safety Belts*.

To remove and store the comfort guides, just perform these steps in reverse order. Squeeze the belt edges together so that you can take them out from the guides. Pull the guide upward to expose its storage clip, and then slide the guide onto the clip. Rotate the guide and clip inward and in between the seat back and the interior body, leaving only the loop of elastic cord exposed.

Seats & Safety Belts

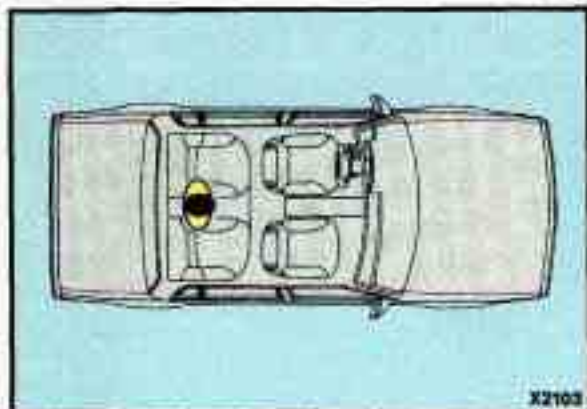

Center Passenger Position

If your vehicle has a rear bench seat, someone can sit in the center position.



When you sit in the center seating position, you have a lap safety belt, which has no retractor. To make the belt longer, tilt the latch plate and pull it along the belt.



To make the belt shorter, pull its free end as shown until the belt is snug.

Buckle, position and release it the same way as the lap part of a lap-shoulder belt.

If the belt isn't long enough, see the *Index* under *Safety Belt Extender*.

Make sure the release button on the buckle faces upward or outward so you would be able to unbuckle it quickly if you ever had to.



■ Children

Everyone in a vehicle needs protection! That includes infants and all children smaller than adult size. In fact, the law in every state and Canadian province says children up to some age must be restrained while in a vehicle.

Smaller Children and Babies

CAUTION

 Smaller children and babies should always be restrained in a child or infant restraint. The instructions for the restraint will say whether it is the right type and size for your child. A very young child's hip bones are so small that a regular belt might not stay low on the hips, as it should. Instead, the belt will likely be over the child's abdomen. In a crash the belt would apply force right on the child's abdomen, which could cause serious or fatal injuries. So, be sure that any child small enough for one is always properly restrained in a child or infant restraint.



CAUTION

 Never hold a baby in your arms while riding in a vehicle. A baby doesn't weigh much—until a crash. During a crash a baby will become so heavy you can't hold it. For example, in a crash at only 25 mph (40 km/h), a 12-pound (5.5 kg) baby will suddenly become a 240-pound (110 kg) force on your arms. The baby would be almost impossible to hold.

(Continued)

Seats & Safety Belts



Smaller Children and Babies (CONT.)

CAUTION



(Continued)

Secure the baby in an infant restraint.

Child Restraints

Be sure to follow the instructions for the restraint. You may find these instructions on the restraint itself or in a booklet, or both. These restraints use the belt system in your vehicle, but the child also has to be secured within the restraint to help reduce the chance of personal injury. The instructions that come with the infant or child restraint will show you how to do that.

Where to Put the Restraint

Accident statistics show that children are safer if they are restrained in the rear rather than the front seat. We at General Motors therefore recommend that you put your child restraint in the rear seat unless the child is an infant and you're the only adult in the vehicle. In that case, you might want to secure the restraint in the front seat where you can keep an eye on the baby.

Wherever you install it, be sure to secure the child restraint properly.

CAUTION

 An unsecured child restraint can move around in a collision or sudden stop and injure people in the vehicle. Be sure to properly secure any child restraint in your vehicle—even when no child is in it.



Top Strap

If your child restraint has a top strap, it should be anchored.

If you need to have an anchor installed, you can ask your Pontiac dealer to put it in for you. If you want to install an anchor yourself, your dealer can tell you how to do it.

Vehicles first sold in Canada have child restraint anchor bracket hardware in the glove box, along with instructions for installing it. This should be used only with a child restraint, and only to secure a child restraint at a rear seating position. Additional anchor brackets for child restraints at the rear seating positions are available at Pontiac dealerships in Canada.

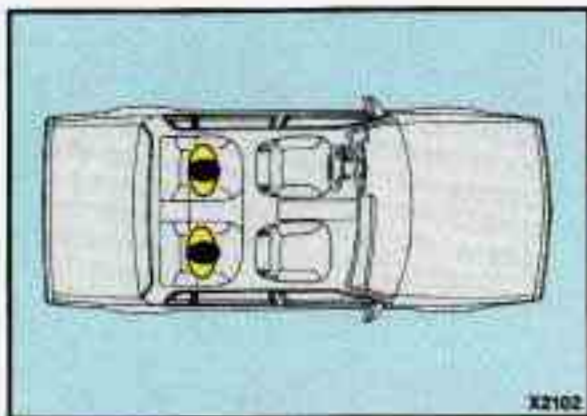

Securing a Child Restraint in a Rear Outside Position

You'll be using the lap-shoulder belt. See the earlier section about the top strap if the child restraint has one.

1. Put the restraint on the seat. Follow the instructions for the child restraint.
2. Secure the child in the child restraint as the instructions say.
3. Pull out the vehicle's safety belt and run the lap part through or around the restraint. The child restraint instructions will show you how. Tilt the latch plate to adjust the belt if needed.

Seats & Safety Belts



Securing a Child Restraint in a Rear Outside Position (CONT.)

See if the shoulder belt would go in front of the child's face or neck. If so, put it behind the child restraint.

4. Buckle the belt. Make sure the release button faces upward or outward, so you'll be able to unbuckle it quickly if you ever need to.



5. To tighten the belt, pull up on the shoulder belt while you push down on the child restraint.



6. Push and pull the child restraint in different directions to be sure it is secure.

To remove the child restraint, just unbuckle the vehicle's safety belt and let it go back all the way. The safety belt will move freely again and be ready to work for an adult or larger child passenger.

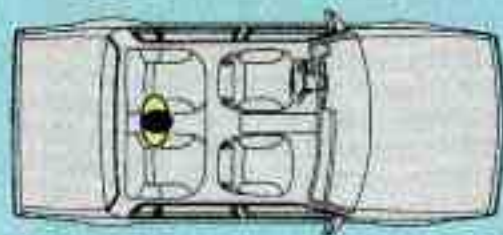

X2103



X2104



X1148

Securing a Child Restraint in the Center Seat Position

When you secure a child restraint in the center seating position, you'll be using the lap belt. See the earlier section about the top strap if the child restraint has one.

- 1.** Make the belt as long as possible by tilting the latch plate and pulling it along the belt.
- 2.** Put the restraint on the seat. Follow the instructions for the child restraint.
- 3.** Secure the child in the child restraint as the instructions say.
- 4.** Run the vehicle's safety belt through or around the restraint. The child restraint instructions will show you how.
- 5.** Buckle the belt. Make sure the release button faces upward or outward, so you'll be able to unbuckle it quickly if you ever need to.

Seats & Safety Belts

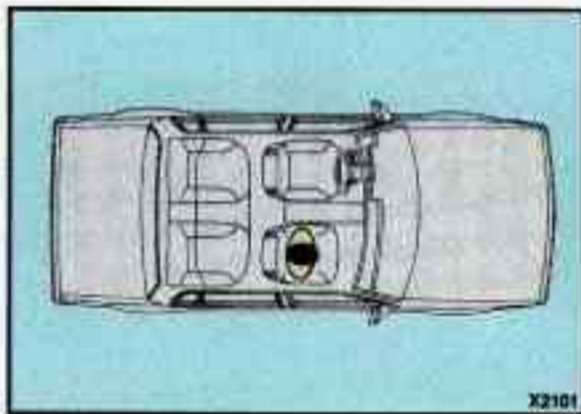

Securing a Child Restraint in the Center Seat Position (CONT.)

6. To tighten the belt, pull its free end while you push down on the child restraint.
7. Push and pull the child restraint in different directions to be sure it is secure. If the child restraint isn't secure, turn the latch plate over and buckle it again. Then see if it is secure. If it isn't, secure the restraint in a different place in the vehicle and contact the child restraint maker for their advice.

To remove the child restraint, just unbuckle the vehicle's safety belt. It will be ready to work for an adult or larger child passenger.

Securing a Child Restraint in the Right Front Seat

To use a child restraint here, you will need a special infant/child seat attaching belt and the hardware that goes with it. See the earlier section about the top strap if the child restraint has one.



Your dealer can get these and install the hardware for you. It's free. The special belt is GM Part No. 12340286. Your dealer can find the correct hardware in the accessory section of the GM Parts Catalog.



CAUTION

 Don't use the special infant/child seat attaching hardware in another vehicle. If you do, it may not work well and the child may not be protected properly in a crash. The special hardware is for your vehicle only. Also, don't use the special belt for anything but securing a child restraint in the right front seat. If an adult or older child uses it, the belt won't provide protection and may even increase injury in a crash.

Once the special hardware is installed, please follow the instructions with it, and these steps:

1. Unbuckle the automatic lap-shoulder belt by pushing the button on the buckle.
It will stay on the door, ready to be rebuckled for use by adults or older children.

2. Snap one hook of the infant/child seat attaching belt near the floor at the door side of the seat.

Seats & Safety Belts



Securing a Child Restraint in the Right Front Seat (CONT.)

3. Put the belt's special latch plate into the vehicle's safety belt buckle.



4. You can make the belt longer by tilting the buckle and pulling it along the belt.
5. Put the restraint on the seat. Follow the instructions for the child restraint.
6. Secure the child in the child restraint as the instructions say.
7. Run the belt through or around the child restraint. The child restraint instructions will show you how.



8. Put the hook on the free end through the slot in the latch plate.



9. To make it tight, pull the belt while you push down on the child restraint. If the belt won't stay tight, switch it end for end.
10. Push and pull the child restraint in different directions to be sure it is secure.

To Remove the Infant/Child Seat Restraint:

1. Push the button on the safety belt buckle and remove the special latch plate. Leave the latch plate on the special belt.



2. Push the spring on the hook near the door and remove the special belt.
3. Put the belt away in a safe place in your vehicle, so it won't fly around in a crash and injure someone.
4. Remember to reattach the automatic belt again, once the child restraint is removed. Be sure it isn't twisted.

Seats & Safety Belts



Larger Children

Children who have outgrown child restraints should wear the vehicle's safety belts.

If you have the choice, a child should sit next to a window so the child can wear a lap-shoulder belt and get the additional restraint a shoulder belt can provide.

Accident statistics show that children are safer if they are restrained in the rear seat. But they need to use the safety belts properly.

- Children who aren't buckled up can be thrown out in a crash.

- Children who aren't buckled up can strike other people who are.

CAUTION



Never do this.

Here two children are wearing the same belt. The belt can't properly spread the impact forces. In a crash, the two children can be crushed together and seriously injured. A belt must be used by only one person at a time.



CAUTION



Never do this.

Here a child is sitting in a seat that has a lap-shoulder belt, but the shoulder part is behind the child. If the child wears the belt in this way, in a crash the child might slide under the belt. The belt's force would then be applied right on the child's abdomen. That could cause serious or fatal injuries.

Wherever the child sits, the lap portion of the belt should be worn low, snug and on the hips, just touching the child's thighs. This applies belt force to the child's pelvic bones in a crash.

Q: What if a child is wearing a lap-shoulder belt, but the child is so small that the shoulder belt is very close to the child's face or neck?

A: Move the child toward the center of the vehicle, but be sure that the shoulder belt still is on the child's shoulder, so that in a crash the child's upper body would have the restraint that belts provide.

If the child is so small that the shoulder belt is still very close to the child's face or neck, you might want to place the child in the center seat position, the one that has only a lap belt.

Seats & Safety Belts

Safety Belt Extender

If the vehicle's safety belt will fasten around you, you should use it.

The automatic lap-shoulder belt has plenty of extra length built in, so it will fasten around almost all people.

But if a safety belt isn't long enough to fasten, your dealer will order you an extender. It's free. When you go in to order it, take the heaviest coat you will wear, so the extender will be long enough for you. The extender will be just for you, and just for the seat in your vehicle that you choose. Don't let someone else use it, and use it only for the seat it is made to fit. To wear it, just attach it to the regular safety belt.

Checking Your Restraint Systems

Now and then, make sure all your belts, buckles, latch plates, retractors, anchorages and reminder systems are working properly. Look for any loose parts or damage. If you see anything that might keep a restraint system from doing its job, have it repaired.

Replacing Safety Belts After a Crash

If you've had a crash, do you need new belts?

After a very minor collision, nothing may be necessary. But if the belts were stretched, as they would be if worn during a more severe crash, then you need new belts.

If belts are cut or damaged, replace them. Collision damage also may mean you will have to have safety belt parts, like the retractor, replaced or anchorage locations repaired—even if the belt wasn't being used at the time of the collision.



If your seat adjuster won't work after a crash, the special part of the safety belt that goes through the seat to the adjuster may need to be replaced.

Q: What's wrong with this?

A: The belt is torn.

CAUTION

 Torn or frayed belts may not protect you in a crash. They can rip apart under impact forces. If a belt is torn or frayed, get a new one right away.

Notes

Part **2**

Features & Controls



Here you can learn about the many standard and optional features on your Pontiac, and information on starting, shifting and braking. Also explained are the instrument panel and the warning systems that tell you if everything is working properly—and what to do if you have a problem.

Keys	44
Locks	45
Glove Box	50
Ignition Switch	51
Starting Your Engine	52
Engine Block Heater	56
Shifting the Transaxle	57
Parking Brake	63
Shifting Into Park	64
Windows	68
Turn Signal/Headlight Beam Lever	69
Cruise Control	70
Light Controls	74
Interior Lights	76
Windshield Wipers	79
Windshield Washer	80
Mirrors	81
Sun Visors	82
Ashtray and Lighter	85
Instrument Panel	86
Warning Lights, Gages and Indicators	91

Features & Controls



Keys

CAUTION



Leaving young children in a vehicle with the ignition key is dangerous for many reasons. A child or others could be badly injured or even killed.

They could operate power windows or other controls or even make the vehicle move.

Don't leave the keys in a vehicle with young children.

The ignition keys are for the ignition only.



The door keys are for the doors and all other locks.

When a new Pontiac is delivered, the dealer removes the plugs from the keys, and gives them to the first owner.

Each plug has a code on it that tells your dealer or a qualified locksmith how to make extra keys. Keep the plugs in a safe place. If you lose your keys, you'll be able to have new ones made easily using these plugs.

NOTICE

Your Pontiac has a number of new features that can help prevent theft. But you can have a lot of trouble getting into your vehicle if you ever lock your keys inside. You may even have to damage your vehicle to get in. So be sure you have extra keys.

Door Locks

CAUTION

 Unlocked doors can be dangerous.

Passengers—especially children—can easily open the doors and fall out. When a door is locked, the inside handle won't open it.

Outsiders can easily enter through an unlocked door when you slow down or stop your vehicle.

This may not be so obvious: You increase the chance of being thrown out of the vehicle in a crash if the doors aren't locked. Wear safety belts properly, lock your doors, and you will be far better off whenever you drive your vehicle.



PN2040



PN2024

There are several ways to lock and unlock your vehicle.

From the Outside:

Use your door key.

From the Inside:

To lock the door, slide the locking lever rearward.

To unlock the door, slide the locking lever forward.

Features & Controls



Power Door Locks

With power door locks, you can lock or unlock all the doors of your vehicle from the driver or front passenger door lock switch.

On 4-door models, the mechanical switch on each rear door works only that door's lock. It won't lock (or unlock) all of the doors—that's a safety feature.

Automatic Door Locks

Just close your doors and turn on the ignition. If you have an automatic transaxle, all of the doors will lock when you move your shift lever out of **P** (Park) or **N** (Neutral). If you have a manual transaxle, all of the doors will lock when the vehicle reaches about 8 mph (13 km/h). Each time you close your doors and turn on the ignition, the doors will lock automatically only once. If someone needs to get out while the vehicle is running, have that person use the manual or power lock. When the door is closed again, it will not lock automatically. Just use the manual or power lock to lock the door again.

Leaving Your Vehicle

If you are leaving the vehicle, open your door and set the locks from inside, then get out and close the door.

Illuminated Entry/Exit System

When you lift the outside handle of either front door, the lights inside your vehicle will go on. These lights will go off after about 40 seconds, or when the ignition is turned on.

If the ignition has been off for less than two minutes, the lights inside your vehicle will stay on for about four seconds to provide an illuminated exit.

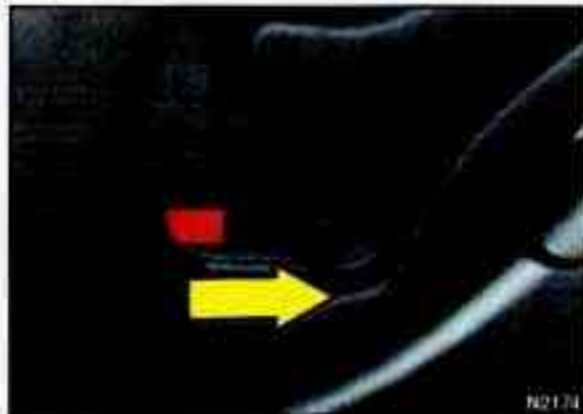
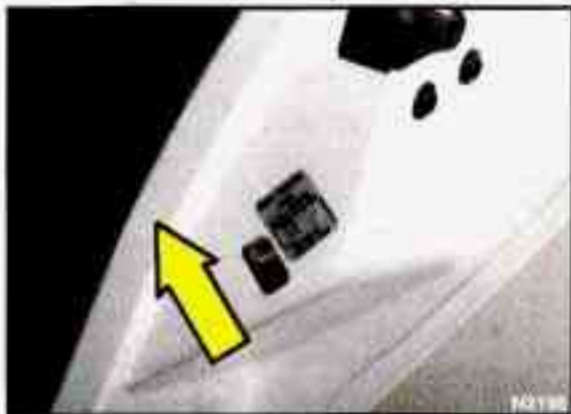

Rear Door Security Locks

Your Pontiac is equipped with rear door security locks that help prevent passengers from opening the rear doors of your vehicle from the inside. To use one of these locks:

1. Use a key to move the lock all the way up.
2. Close the door.
3. Do the same thing to the other rear door lock.

The rear doors of your vehicle cannot be opened from inside when this feature is in use. If you want to open a rear door when the security lock is on:

1. Unlock the door from the inside.

2. Then open the door from the outside.
If you don't cancel the security lock feature, adults or older children who ride in the rear won't be able to open the rear door from the inside. You should let adults and older children know how these security locks work, and how to cancel the locks.

Features & Controls



Rear Door Security Locks (CONT.)

To Cancel the Rear Door Lock:

1. Unlock the door from the inside and open the door from the outside.

2. Use a key to move the lock all the way down.
 3. Do the same for the other rear door.
- The rear door locks will now work normally.

Theft

Vehicle theft is big business, especially in some cities.

Although your Pontiac has a number of theft-deterrent features, we know that nothing we put on it can make it impossible to steal. However, there are ways you can help.

Key in the Ignition: If you walk away from your vehicle with the keys inside, it's an easy target for joy riders or professional thieves—so don't do it. When you park your Pontiac and open the driver's door, you'll hear a chime reminding you to remove your key from the ignition and take it with you.

Always do this. Your steering wheel will be locked, and so will your ignition. If you have an automatic transaxle, taking your key out also locks your transaxle. And remember to lock the doors.



Trunk Lock

To unlock the trunk from the outside, insert the door key and turn the trunk lock cylinder.



Remote Trunk Release

Pull upward on the remote release handle, located on the floor near the left side of the driver's seat, to release the trunk lid. Make sure the lockout feature is not activated.

Parking at Night: Park in a lighted spot, close all windows and lock your vehicle. Remember to keep your valuables out of sight. Put them in a storage area, or take them with you.

Parking Lots: If you park in a lot where someone will be watching your vehicle, it's best to lock it up and take your keys. But what if you have to leave your ignition key? What if you have to leave something valuable in your vehicle?

- Put your valuables in a storage area, like your trunk or glove box.
- Activate the remote trunk release lockout feature.
- Lock the glove box.
- Lock all the doors except the driver's.
- Then take the door key with you.

Features & Controls

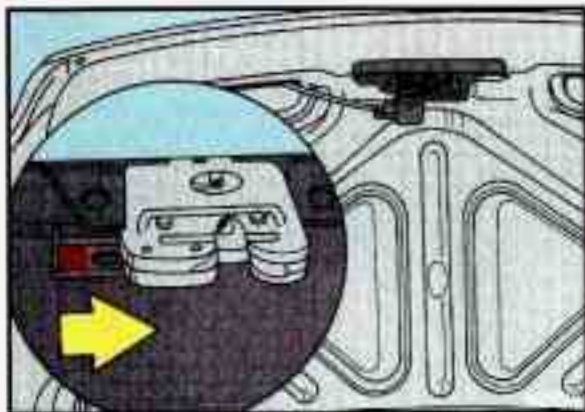

Remote Trunk Release (CONT.)

Lockout Feature:

The remote trunk release is equipped with a lockout feature to help prevent unauthorized entry into the trunk when leaving the vehicle unattended. The switch is located on the inside of the trunk lid, mounted to the trunk lid latch.

To turn the lockout on, slide the switch all the way to the right. To turn the lockout off, slide the switch all the way to the left.

When the lockout is on, the mechanical remote trunk release will not release the trunk lid. However, the trunk lid can still be opened with the key.



Glove Box

Use the door key to lock and unlock the glove box. To open, pull the glove box handle toward you.

New Vehicle "Break-In"

NOTICE

Your modern Pontiac doesn't need an elaborate "break-in." But it will perform better in the long run if you follow these guidelines:

- Don't drive at any one speed—fast or slow—for the first 500 miles (804 km). Don't make full-throttle starts.
- Avoid making hard stops for the first 200 miles (322 km) or so. During this time your new brake linings aren't yet broken in. Hard stops with new linings can mean premature wear and earlier replacement. Follow this "breaking-in" guideline every time you get new brake linings.

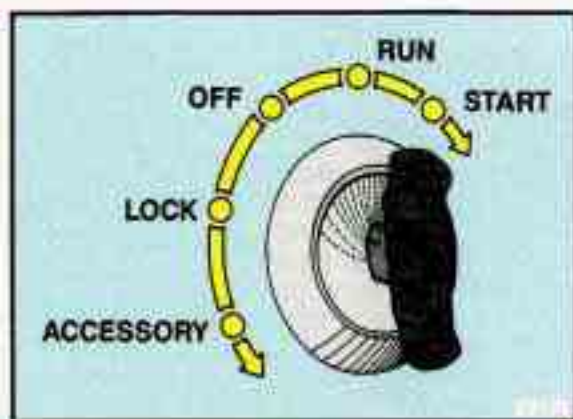

Ignition Switch

With the ignition key in the ignition switch, you can turn the switch to five positions:

Accessory: An “on” position in which you can operate some of your electrical power accessories. Press in the ignition switch as you turn the top of it toward you.

Lock: The only position in which you can remove the key. This locks your steering wheel, ignition and transaxle (on automatic models).

Off: Unlocks the steering wheel, ignition, and transaxle (on automatic models), but does not send electrical power to any accessories. Use this position if your vehicle must be pushed or towed, but never try to push-start your vehicle. A warning chime will sound if you open the driver’s door

when the ignition is off and the key is in the ignition.

Run: An “on” position to which the switch returns after you start your engine and release the switch. The switch stays in the **Run** position when the engine is running. But even when the engine is not running, you can use **Run** to operate your electrical power accessories, and to display some instrument panel warning lights.

Start: Starts the engine. When the engine starts, release the key. The ignition switch will return to **Run** for normal driving.

Note that even if the engine is not running, the positions **Accessory** and **Run** are “on” positions that allow you to operate some of your electrical accessories, such as the radio.



Key Release Button (MANUAL TRANSAXLE)

The ignition key cannot be removed from the ignition unless the key release button is used.

To Remove the Key:

Turn the key to the **Lock** position while pressing the key release button in. Keeping your finger on the button, pull the key straight out.

Features & Controls

Key Release Button (CONT.)

CAUTION



On manual transaxle vehicles, turning the key to **Lock** will lock the steering column and result in a loss of ability to steer the vehicle. This could cause a collision. If you need to turn the engine off while the vehicle is moving, turn the key only to **Off**. Don't press the key release button while the vehicle is moving.

NOTICE

If your key seems stuck in **Lock** and you can't turn it, be sure it is all the way in. If it is, then turn the steering wheel to the left while you turn the key. But turn the key only with your hand. Using a tool to force it could break the key or the ignition switch. If none of this works, then your vehicle needs service.

■ Starting Your Engine

Engines start differently. The 8th digit of your Vehicle Identification Number (VIN) shows the code letter or number for your engine. You will find the VIN at the top left of your instrument panel. (See the *Index* under *Vehicle Identification Number*.) Follow the proper steps to start the engine.



Automatic Transaxle

Move your shift lever to **P** (Park) or **N** (Neutral). Your engine won't start in any other position—that's a safety feature. To restart when you're already moving, use **N** (Neutral) only.

NOTICE

Don't try to shift to **P** (Park) if your Pontiac is moving. If you do, you could damage the transaxle. Shift to **P** (Park) only when your vehicle is stopped.

Manual Transaxle

Shift your gear selector to **N** (Neutral) and hold the clutch pedal to the floor while starting the engine. Your vehicle won't start if the clutch pedal is not all the way down—that's a safety feature.

Both Transaxles

To Start Your 2.3L Quad OHC or Quad 4 Engine (Code 3, A or D):

1. Don't push the accelerator pedal before starting your engine. In some other vehicles you might need to do this, but because of your vehicle's computer systems, you don't.
2. Turn your ignition key to **Start**. When the engine starts, let go of the key. The idle speed will go down as your engine gets warm.
3. If it doesn't start right away, and the weather is very cold (below -20°F , or -29°C), push the accelerator pedal about one-quarter of the way down while you turn the key to **Start**. Do this until the engine starts. As soon as it does, let go of the key.

Features & Controls

Both Transaxles (CONT.)

NOTICE

Holding your key in **Start** for longer than 15 seconds at a time will cause your battery to be drained much sooner. And the excessive heat can damage your starter motor.

4. If your engine still won't start (or starts but then stops), it could be flooded with too much gasoline. Try pushing your accelerator pedal all the way to the floor and holding it there as you hold the key in **Start** for about three seconds. This clears the extra gasoline from the engine. If the vehicle starts briefly but then stops again, do the same thing, but this time keep the pedal about one-quarter of the way down for five or six seconds.

NOTICE

Your engine is designed to work with the electronics in your vehicle. If you add electrical parts or accessories, you could change the way the fuel injection system operates. Before adding electrical equipment, check with your dealer. If you don't, your engine might not perform properly.

If you ever have to have your vehicle towed, see the part of this manual that tells how to do it without damaging your vehicle. See the *Index* under *Towing Your Pontiac*.

To Start Your 3300 V6 Engine (Code N):

1. Don't push the accelerator pedal before starting your engine. In some other vehicles you might need to do this, but because of your vehicle's computer systems, you don't.
2. Turn your ignition key to **Start**. When the engine starts, let go of the key. The idle speed will go down as your engine gets warm.
3. If it doesn't start right away, push the accelerator pedal about one-quarter of the way down while you turn the key to **Start**. Do this until the engine starts. As soon as it does, let go of the key and the accelerator pedal.

NOTICE

Holding your key in **Start** for longer than 15 seconds at a time will cause your battery to be drained much sooner. And the excessive heat can damage your starter motor.

4. If your engine still won't start (or starts but then stops), it could be flooded with too much gasoline. Try pushing your accelerator pedal all the way to the floor and holding it there as you hold the key in **Start** for about 15 seconds. This clears the extra gasoline from the engine. Turn the ignition key to **Off**. Wait 10 seconds, then repeat step 3.

NOTICE

Your engine is designed to work with the electronics in your vehicle. If you add electrical parts or accessories, you could change the way the fuel injection system operates. Before adding electrical equipment, check with your dealer. If you don't, your engine might not perform properly.

If you ever have to have your vehicle towed, see the part of this manual that tells how to do it without damaging your vehicle. See the *Index* under *Towing Your Pontiac*.

Driving Through Deep Standing Water

NOTICE

If you drive too quickly through deep puddles or standing water, water can come in through your engine's air intake and badly damage your engine. If you can't avoid deep puddles or standing water, drive through them very slowly.

Features & Controls



Engine Block Heater (OPTION)

In very cold weather, 0°F (-18°C) or colder, the engine block heater can help. You'll get easier starting and better fuel economy during engine warm-up.

To Use the Block Heater:

1. Turn off the engine.
2. Open the hood and unwrap the electrical cord.
3. Plug it into a normal, grounded 110-volt outlet.

CAUTION



Plugging the cord into an ungrounded outlet could cause an electrical shock. Also, the wrong kind of extension cord could overheat and cause a fire. You could be seriously injured. Plug the cord into a properly grounded three-prong 110-volt outlet. If the cord won't reach, use a heavy-duty three-prong extension cord rated for at least 15 amps.

NOTICE

After you've used the block heater, be sure to store the cord as it was before, to keep it away from moving engine parts. If you don't, it could be damaged.

How long should you keep the block heater plugged in? The answer depends on the weather, the kind of oil you have, and some other things. Instead of trying to list everything here, we ask that you contact a Pontiac dealer in the area where you'll be parking your vehicle. The dealer can give you the best advice for that particular area.



■ *Shifting the Automatic Transaxle*

Your automatic transaxle has a shift lever located on the console between the seats.

There are several different positions for your shift lever. In this manual, these are referred to by the commonly used symbols in the right column below:

Park	P
Reverse	R
Neutral	N
Drive	D
Second	2
First	1

Park

P (Park): This locks your front wheels. It's the best position to use when you start your engine because your vehicle can't move easily.

CAUTION



It can be dangerous to get out of your vehicle if the shift lever is not fully in **P** (Park) with the parking brake firmly set. Your vehicle can roll.

Don't leave your vehicle when the engine is running unless you have to. If you have left the engine running, the vehicle can move suddenly. You or others could be injured. To be sure your vehicle won't move, when you're on fairly level ground, always set your parking brake and move the shift lever to **P** (Park). See the *Index* under *Shifting into P (Park)*. If you are parking on a hill, or if you're pulling a trailer, also see the *Index* under *Parking on Hills* or *Towing a Trailer*.

Features & Controls



Park (CONT.)

Ensure the shift lever is fully in **P** (Park) range before starting the engine. Your Pontiac has a brake-transaxle shift interlock. You have to **apply** your regular brake **before** you can shift from **P** (Park) when the ignition key is in the **Run** position. If you cannot shift out of **P** (Park), ease pressure on the shift lever—push the shift lever all the way into **P** (Park)—as you maintain brake application. Then move the shift lever into the gear you wish. (Press the shift lever button before moving the shift lever.) See *Shifting Out of P (Park)* later in this section.

Reverse

R (Reverse): Use this gear to back up.

NOTICE

Shifting to **R** (Reverse) while your vehicle is moving forward could damage your transaxle. Shift to **R** only after your vehicle is stopped.

To rock your vehicle back and forth to get out of snow, ice or sand without damaging your transaxle, see the *Index* under *If You're Stuck: In Sand, Mud, Ice or Snow*.



Neutral

N (Neutral): In this position, your engine doesn't connect with the wheels. To restart when you're already moving, use **N** (Neutral) only. Also, use **N** when your vehicle is being towed.

CAUTION

 Shifting out of **P** (Park) or **N** (Neutral) while your engine is "racing" (running at high speed) is dangerous. Unless your foot is firmly on the brake pedal, your vehicle could move very rapidly. You could lose control and hit people or objects. Don't shift out of **P** (Park) or **N** (Neutral) while your engine is racing.



NOTICE

Damage to your transaxle caused by shifting out of **P** (Park) or **N** (Neutral) with the engine racing isn't covered by your warranty.

Forward Gears

D (Drive): This position is for normal driving.

2 (Second Gear): This position gives you more power but lower fuel economy. You can use **2** on hills. It can help control your speed as you go down steep mountain roads, but then you would also want to use your brakes off and on.

NOTICE

Don't drive in **2** (Second Gear) for more than 5 miles (8 km), or at speeds over 55 mph (88 km/h), or you can damage your transaxle. Use **D** as much as possible.

Don't shift into **2** unless you are going slower than 65 mph (105 km/h), or you can damage your engine.

Features & Controls

Forward Gears (CONT.)

1 (First Gear): This position gives you even more power (but lower fuel economy) than **2**. You can use it on very steep hills, or in deep snow or mud. If the selector lever is put in **1**, the transaxle won't shift into first gear until the vehicle is going slowly enough.

NOTICE

If your front wheels can't rotate, don't try to drive. This might happen if you were stuck in very deep sand or mud or were up against a solid object. You could damage your transaxle.

Also, if you stop when going uphill, don't hold your vehicle there with only the accelerator pedal. This could overheat and damage the transaxle. Use your brakes or shift into **P** (Park) to hold your vehicle in position on a hill.



■ *Shifting the Five-Speed Manual Transaxle*

There are seven different positions:

- N** Neutral
- 1** First Gear
- 2** Second Gear
- 3** Third Gear
- 4** Fourth Gear
- 5** Fifth Gear
- R** Reverse

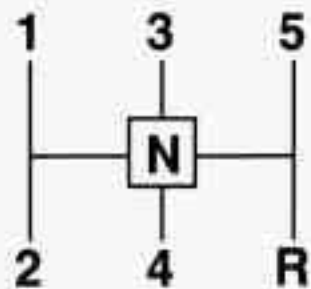

This is your shift pattern. Here's how to operate your transaxle:

1 (First Gear): Press the clutch pedal and shift into **1**. Then, slowly let up on the clutch pedal as you press the accelerator pedal.

You can shift into **1** when you're going less than 20 mph (32 km/h). If you've come to a complete stop and it's hard to shift into **1**, put the shift lever in **N** (Neutral) and let up on the clutch. Press the clutch pedal back down. Then shift into **1**.

2 (Second Gear): Press the clutch pedal as you let up on the accelerator pedal and shift into **2**. Then, slowly let up on the clutch pedal as you press the accelerator pedal.

3, 4 and 5 (Third, Fourth and Fifth Gears): Shift into **3**, **4** and **5** the same way you do for **2**. Slowly let up on the clutch pedal as you press the accelerator pedal.

To Stop: Let up on the accelerator pedal and press the brake pedal. Just before the vehicle stops, press the clutch pedal and the brake pedal, and shift into **N** (Neutral).

N (Neutral): Use this position when you start or idle your engine.

R (Reverse): To back up, press the clutch pedal and shift into **R**. Let up on the clutch pedal slowly while pressing the accelerator pedal.

NOTICE

Shift to **R** (Reverse) only after your vehicle is stopped. Shifting to **R** (Reverse) while your vehicle is moving could damage your transaxle.

Also, use **R** (Reverse), along with the parking brake, for parking your vehicle.

Features & Controls

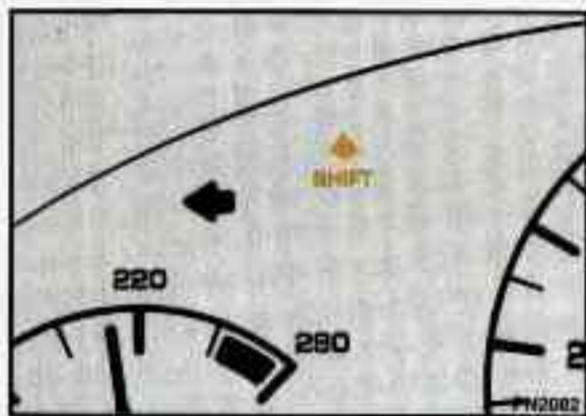

Shift Light (MANUAL TRANSAXLE)

If you have a manual transaxle, you have a **SHIFT** light. This light will show you when to shift to the next higher gear for best fuel economy.

When this light comes on, you can shift to the next higher gear if weather, road and traffic conditions let you. For the best fuel economy, accelerate slowly and shift when the light comes on.

While you accelerate, it is normal for the light to go on and off if you quickly change the position of the accelerator. Ignore the **SHIFT** light when you downshift.

Shift Speeds (MANUAL TRANSAXLE)

This chart shows when to shift to the next higher gear for best fuel economy.

Acceleration Shift Speeds for 2.3L OHC and 2.3L High Output Quad 4 Engines (Codes 3 and A):

1st to 2nd	15 mph (24 km/h)
2nd to 3rd	25 mph (40 km/h)
3rd to 4th	40 mph (64 km/h)
4th to 5th	45 mph (72 km/h)

If your speed drops below 20 mph (32 km/h), or if the engine is not running smoothly, you should downshift to the next lower gear. You may have to downshift two or more gears to keep the engine running smoothly or for good performance.

CAUTION



If you skip more than one gear when you downshift, you could lose control of your vehicle. And you could injure yourself or others. Don't shift from 5 to 2 or 4 to 1.

NOTICE

If you skip more than one gear when you downshift, or if you race the engine when you downshift, you can damage the clutch or transaxle.

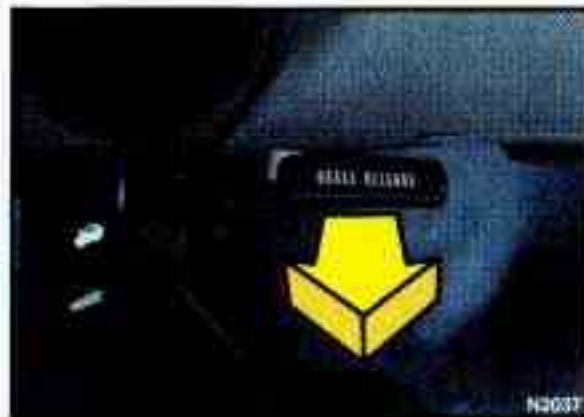
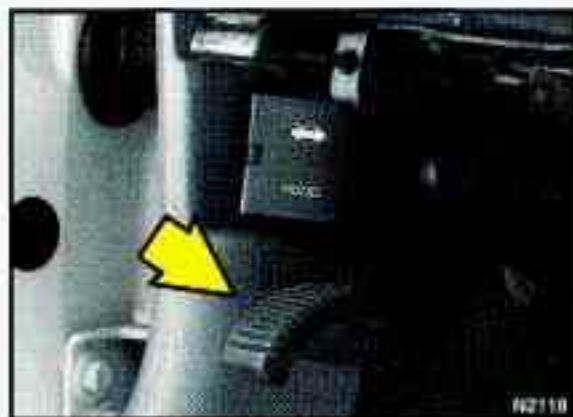

Parking Brake

To Set the Parking Brake:

Hold the regular brake pedal down with your right foot. Push down the parking brake pedal with your left foot. If the ignition is on, the brake system warning light will come on.

To Release the Parking Brake:

Hold the regular brake pedal down. Pull the **BRAKE RELEASE** lever.

NOTICE

Driving with the parking brake on can cause your rear brakes to overheat. You may have to replace them, and you could also damage other parts of your vehicle.

If You are on a Hill:

See the *Index* under *Parking on Hills*. That section shows how to turn your front wheels.

If You are Towing a Trailer and are Parking on a Hill:

See the *Index* under *Towing a Trailer*. That section shows what to do first to keep the trailer from moving.

Features & Controls



Shifting Into P (Park) (AUTOMATIC TRANSAXLE)

CAUTION

 It can be dangerous to get out of your vehicle if the shift lever is not fully in **P** (Park) with the parking brake firmly set. Your vehicle can roll.

If you have left the engine running, the vehicle can move suddenly. You or others could be injured. To be sure your vehicle won't move, when you're on fairly level ground, use the steps that follow. If you are parking on a hill, or if you're pulling a trailer, also see the *Index* under *Parking on Hills* or *Towing a Trailer*.

1. Hold the brake pedal down with your right foot and set the parking brake.

2. Move the shift lever into **P** (Park) position like this:
 - Hold in the button on the lever.
 - Push the lever all the way toward the front of your vehicle.
3. Move the ignition key to **Lock**.
4. Remove the key and take it with you. If you can walk away from your vehicle with the ignition key in your hand, your vehicle is in **P** (Park).

Leaving Your Vehicle With the Engine Running (AUTOMATIC TRANSAXLE)

CAUTION

 It is dangerous to leave your vehicle with the engine running. Your vehicle could move suddenly if the shift lever is not fully in **P** (Park) with the parking brake firmly set. And, if you leave the vehicle with the engine running, it could overheat and even catch fire. You or others could be injured. Don't leave your vehicle with the engine running unless you have to.

If you have to leave your vehicle with the engine running, be sure your vehicle is in **P** (Park) and your parking brake is firmly set before you leave it. After you've moved the shift lever into the **P** (Park) position, hold the regular brake pedal down. Then, see if you can move the shift lever away from **P** (Park) without first pushing the button.

If you can, it means that the shift lever wasn't fully locked into **P** (Park).

Shifting Out of P (Park) **(AUTOMATIC TRANSAXLE)**

Your Pontiac has a brake-transaxle shift interlock. You have to **apply** your regular brake **before** you can shift from **P** (Park) when the ignition is in the **Run** position. See the *Index* under *Automatic Transaxle*.

If you cannot shift out of **P** (Park), ease pressure on the shift lever—push the shift lever all the way into **P** (Park)—as you maintain brake application. Then move the shift lever into the gear you wish. (Press the shift lever button before moving the shift lever.)

If you ever hold the brake pedal down but still can't shift out of **P** (Park), try this:

1. Turn the key to **Off**.
2. Apply and hold the brake until the end of Step 4.
3. Shift to **N** (Neutral).
4. Start the vehicle and then shift to the drive gear you want.
5. Have the vehicle fixed as soon as you can.

Features & Controls

Parking Your Vehicle **(MANUAL TRANSAXLE)**

Before you get out of your vehicle, put your manual transaxle in **R** (Reverse) and firmly apply the parking brake.

If you are parking on a hill, or if your vehicle is equipped to tow a trailer, see the *Index* under *Parking on Hills* or *Towing a Trailer*.



Parking Over Things That Burn

CAUTION

 Things that can burn could touch hot exhaust parts under your vehicle and ignite. Don't park over papers, leaves, dry grass or other things that can burn.

Engine Exhaust

CAUTION

 Engine exhaust can kill. It contains the gas carbon monoxide (CO), which you can't see or smell. It can cause unconsciousness and death.

You might have exhaust coming in if:

- Your exhaust system sounds strange or different.
- Your vehicle gets rusty underneath.
- Your vehicle was damaged in a collision.
- Your vehicle was damaged when driving over high points on the road or over road debris.
- Repairs weren't done correctly.
- Your vehicle or exhaust system has been modified improperly.

If you **ever** suspect exhaust is coming into your vehicle:

- Drive it only with all the windows down to blow out any CO; and
- Have it fixed **immediately**.

Running Your Engine While You're Parked (AUTOMATIC TRANSAXLE)

It's better not to park with the engine running. But if you ever have to, here are some things to know.

CAUTION

 Idling the engine with the air system control **OFF** could allow dangerous exhaust into your vehicle (see the earlier **CAUTION** under *Engine Exhaust*).

Also, idling in a closed-in place can let deadly carbon monoxide (CO) into your vehicle even if the fan switch is at the highest setting. One place this can happen is a garage. Exhaust—with CO—can come in easily. **Never** park in a garage with the engine running.

Another closed-in place can be a blizzard. (See the *Index* under *Blizzard*.)

It can be dangerous to get out of your vehicle if the shift lever is not fully in **P** (Park) with the parking brake firmly set. Your vehicle can roll. Don't leave your vehicle when the engine is running unless you have to. If you've left the engine running, the vehicle can move suddenly. You or others could be injured. To be sure your vehicle won't move, even when you're on fairly level ground, always set your parking brake and move the shift lever to **P** (Park).

If you are parking on a hill, or if you're pulling a trailer, also see the *Index* under *Parking on Hills* or *Towing a Trailer*.



Horn

You can sound the horn by pressing the horn symbol on your steering wheel.

Features & Controls

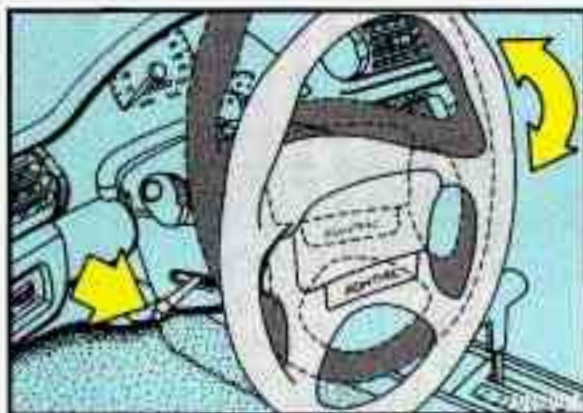

Tilt Steering Wheel (OPTION)

A tilt steering wheel allows you to adjust the steering wheel before you drive.

You can also raise it to the highest level to give your legs more room when you exit and enter the vehicle.

To tilt the wheel, hold the steering wheel and pull the lever.

Move the steering wheel to a comfortable level, then release the lever to lock the wheel in place.



Windows

On a vehicle with manual windows, use the window crank to open and close each window.



Power Windows (OPTION)

With power windows, switches on the center console control each of the windows when the ignition is on. In addition, each passenger door has a control switch for its own window.

The driver's window switch has an Auto Down feature. The driver's window can be opened to any position by pushing the rear of the switch to the first detent. When the switch is fully depressed, the window will go down all the way.

To stop the window while it is lowering, press the switch, then release.

To raise the window, press and hold the switch forward.



Power Window Lock-Out Switch (OPTION)

On 4-door models, this switch disables all passenger power windows. Push the switch forward to lock the windows. Push the switch back to unlock the windows.



Turn Signal/Headlight Beam Lever

The lever on the left side of the steering column includes your:

- Turn Signal and Lane Change Indicator
- Headlight High-Low Beam Changer
- Flash-to-Pass Feature
- Cruise Control (Option)

The High-Low Beam feature is discussed under *Headlights*. See the *Index* under *Headlights*.

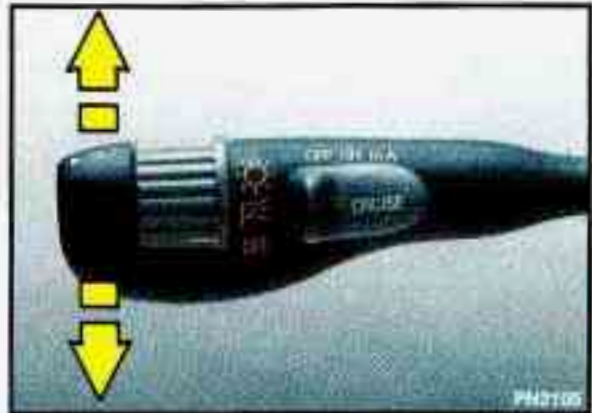

Turn Signal and Lane Change Indicator

The turn signal has two upward (for Right) and two downward (for Left) positions. These positions allow you to signal a turn or a lane change.

To signal a turn, move the lever all the way up or down. When the turn is finished, the lever will return automatically.

A green arrow on the instrument panel will flash in the direction of the turn or lane change.

Features & Controls

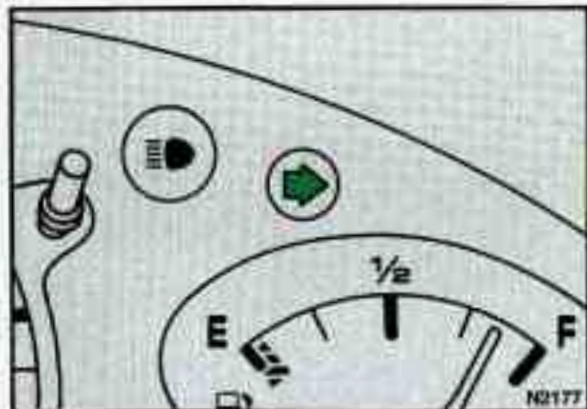

Turn Signal and Lane Change Indicator (CONT.)

To signal a lane change, just raise or lower the lever until the green arrow starts to flash. Hold it there until you complete your lane change. The lever will return by itself when you release it.

As you signal a turn or a lane change, if the arrows don't flash but just stay on, a signal bulb may be burned out and other drivers won't see your turn signal.

If a bulb is burned out, replace it to help avoid an accident. If the green arrows don't go on at all when you signal a turn, check the fuse (see the *Index* under *Fuses & Circuit Breakers*) and for burned-out bulbs.



■ Cruise Control (OPTION)

With cruise control, you can maintain a speed of about 25 mph (40 km/h) or more without keeping your foot on the accelerator. This can really help on long trips. Cruise control does not work at speeds below about 25 mph (40 km/h).

When you apply your brake or the clutch pedal, the cruise control shuts off.

CAUTION



- Cruise control can be dangerous where you can't drive safely at a steady speed. So, don't use your cruise control on winding roads or in heavy traffic.
- Cruise control can be dangerous on slippery roads. On such roads, fast changes in tire traction can cause needless wheel spinning, and you could lose control. Don't use cruise control on slippery roads.

To Set Cruise Control

1. Move the cruise control switch to **ON**.

CAUTION

 If you leave your cruise control switch **ON** when you're not using cruise, you might hit a button and go into cruise when you don't want to. You could be startled and even lose control. Keep the cruise control switch **OFF** until you want to use it.

2. Get up to the speed you want.



3. Push in the **SET** button at the end of the lever and release it.
4. Take your foot off the accelerator pedal.



To Resume a Set Speed

Suppose you set your cruise control at a desired speed and then you apply the brake or clutch pedal. This, of course, shuts off the cruise control. But you don't need to reset it. Once you're going about 25 mph (40 km/h) or more, you can move the cruise control switch from **ON** to **R/A** (which stands for Resume/Accelerate) for about half a second. You'll go right back up to your chosen speed and stay there.

Features & Controls

To Resume a Set Speed (CONT.)

CAUTION



If you hold the switch at **R/A** longer than half a second, the vehicle will keep going faster until you release the switch or apply the brake or clutch pedal. You could be startled and even lose control. So unless you want to go faster, don't hold the switch at **R/A**.

To Increase Speed While Using Cruise Control

There are two ways to go to a higher speed. Here's the first:

1. Use the accelerator pedal to get to the higher speed.
2. Push the button at the end of the lever, then release the button and the accelerator pedal.

You'll now cruise at the higher speed.

Here's the second way to go to a higher speed:

- Move the cruise switch from **ON** to **R/A**. Hold it there until you get up to the speed you want, and then release the switch.
- To increase your speed in very small amounts, move the switch to **R/A** for less than half a second and then release it. Each time you do this, your vehicle will go 1 mph (1.6 km/h) faster.



To Reduce Speed While Using Cruise Control

There are two ways to reduce your speed while using cruise control:

- Push in the button at the end of the lever until you reach the lower speed you want, then release it.
- To slow down in very small amounts, push the button for less than half a second. Each time you do this, you'll go 1 mph (1.6 km/h) slower.

Passing Another Vehicle While Using Cruise Control

Use the accelerator pedal to increase your speed. When you take your foot off the pedal, your vehicle will slow down to the cruise control speed you set earlier.

Using Cruise Control on Hills

How well your cruise control will work on hills depends upon your speed, load, and the steepness of the hills. When going up steep hills, you may have to step on the accelerator pedal to maintain your speed. When going downhill, you may have to brake or shift to a lower gear to keep your speed down. Of course, applying the brake or clutch pedal takes you out of cruise control. Many drivers find this to be too much trouble and don't use cruise control on steep hills.

Features & Controls



To Get Out of Cruise Control

There are two ways to turn off the cruise control:

- Step lightly on the brake pedal or push the clutch pedal, if you have a manual transaxle; OR
- Move the cruise switch to **OFF**.

To Erase Cruise Speed Memory

When you turn off the cruise control or the ignition, your cruise control set speed memory is erased.

Light Controls

Parking Lights:

Rotate the switch up to  to turn on:

- Parking Lights
- Side Marker Lights
- Taillights
- Instrument Panel Lights

Headlights:

Rotate the switch to  to turn on:

- Headlights
- Parking Lights
- Side Marker Lights
- Taillights
- Instrument Panel Lights

Rotate the switch to **OFF** to turn all the lights off.

Operation of Lights

Although your vehicle's lighting system (headlamps, parking lamps, fog lamps, side marker lamps and taillamps) meets all applicable federal lighting requirements, certain states and provinces may apply their own lighting regulations that may require special attention before you operate these lamps. For example, some jurisdictions may require that you operate your lower beam lamps with fog lamps at all times, or that headlamps be turned on whenever you must use your windshield wipers. In addition, most jurisdictions prohibit driving solely with parking lamps, especially at dawn or dusk. It is recommended that you check with your own state or provincial highway authority for applicable lighting regulations.

Lights On Reminder

If you open the driver's door while leaving the lights on, you will hear a warning chime.

Daytime Running Lights

(CANADA ONLY)

The Canadian federal government has decided that Daytime Running Lights (DRL) are a useful feature, in that DRL can make your vehicle more visible to pedestrians and other drivers during daylight hours. DRL are required on new vehicles sold in Canada.

Your DRL work with a light sensor on top of the instrument panel. Don't cover it up.

The high beam headlights will come on at reduced brightness in daylight when:

- The ignition is on
- The headlight switch is off, and
- The parking brake is released on a manual transaxle; or
- The shift lever is shifted out of **P** (Park) or **N** (Neutral) on an automatic transaxle.

At dusk, the exterior lights and headlights will come on automatically. At dawn, the exterior lights will go out and the high beams will change to the reduced brightness of DRL again (if the headlight switch is off).

Of course, you may still turn on the headlights any time you need to.

To idle your vehicle with the DRL off, set the parking brake on a manual transaxle or put the vehicle in **P** (Park) or **N** (Neutral) on an automatic transaxle, while the ignition is in the **Off** or **Lock** position. Then start the vehicle. The DRL will stay off until you release the parking brake on a manual transaxle or shift out of **P** (Park) or **N** (Neutral) on an automatic transaxle.

Features & Controls



Headlight High-Low Beam Changer

To change the headlights from low beam to high or high to low, pull the turn signal lever all the way toward you. Then release it. When the high beams are on, a blue light on the instrument panel also will be on.

Flash-to-Pass (EXCEPT CANADA)

Flash-to-pass lets you use your high beam headlights to signal a driver in front of you that you want to pass.

To use it, pull the turn signal/headlight beam lever toward you.

If Your Headlights are Off:

Your high beam headlights will turn on. They'll stay on as long as you hold the lever there. Release the lever to turn them off.

If Your Headlights are On:

No flash-to-pass. Use the lever to change between high and low beams.



Instrument Panel Intensity Control

You can brighten or dim your instrument cluster lights by rotating the instrument panel intensity control switch. Rotate the switch all the way to the right to turn on the interior courtesy lights. Rotate the switch to the left to turn off the instrument cluster lights and displays.



PN0037

Fog Lights

The switch for your fog lights is next to the instrument panel intensity control.

Push the top of the switch to turn the fog lights on.

When using fog lights, the parking lights or low beam headlights must be on.

Fog lights will go off whenever the high beam headlights come on. When the high beams go off, the fog lights will come on again.



N2158

Front Reading Lights (OPTION)

These lights and the interior courtesy lights will come on when you open the doors.

To turn on a reading light when the doors are closed, press the button. Press it again to turn the light off.

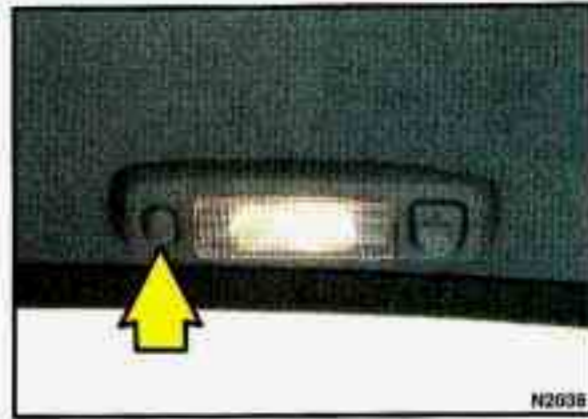

N2636

Rear Reading Lights (OPTION)

These overhead lights and the interior courtesy lights will come on when you open the doors.

To turn on a reading light when the doors are closed, press the button. Press it again to turn off the light.

Features & Controls

Trunk Light

This light comes on when you open your trunk. It also comes on when you open the doors or turn on the courtesy lights.

Battery Rundown Protection

Your Pontiac is equipped with a Battery Rundown Protection feature designed to protect your vehicle's battery.

When any interior light (trunk, reading, footwell or glove box) is left on when the ignition is turned off, the Battery Rundown Protection system will automatically shut the light off after 20 minutes. This will avoid draining the battery.

To reactivate the interior lights, either:

- The ignition must be turned on
- The activated light switch must be turned off and then on, OR
- A front door must be opened.

The Battery Rundown Protection feature will also be activated when any door of your vehicle is left open.

Also, if your vehicle is left with the ignition turned off for over 24 days, battery power to your clock and audio system will be turned off to reduce battery drain. When the ignition is turned on again, battery power will be resupplied. However, under these conditions, it will be necessary to reset the clock and audio system settings.



Windshield Wipers

You control the windshield wipers by moving the stalk up or down.

For a Single Wiper Cycle:

Push the stalk down to **MIST**, then release it. For more cycles, hold the stalk down longer.

For Steady Wiper Cycles:

Move the stalk up to either **LO** or **HI**, depending on the wiper speed you want.

To Turn Wipers Off:

Move the stalk to **OFF**.

CAUTION



Damaged wiper blades may prevent you from seeing well enough to drive safely. To avoid damage, be sure to clear ice and snow from the wiper blades before using them. If they're frozen to the windshield, carefully loosen or thaw them. If your blades do become damaged, get new blades or blade inserts.

Heavy snow or ice can overload your wipers. A circuit breaker will stop them until the motor cools. Clear away snow or ice to prevent an overload.

Features & Controls



Controlled-Cycle Windshield Wipers (OPTION)

If your vehicle has controlled-cycle wipers, you can set the wiper speed as slow as 25 seconds between wiper cycles, or faster. The controlled-cycle delay is very useful in light rain or snow.

Move the stalk to **DELAY**, then rotate the inner band and choose the delay you want. Rotate the inner band up for shorter delay times between wiper cycles. Rotate the band down for a longer delay time between wiper cycles.

With controlled-cycle wipers you can also use **MIST** for a single wiper cycle.

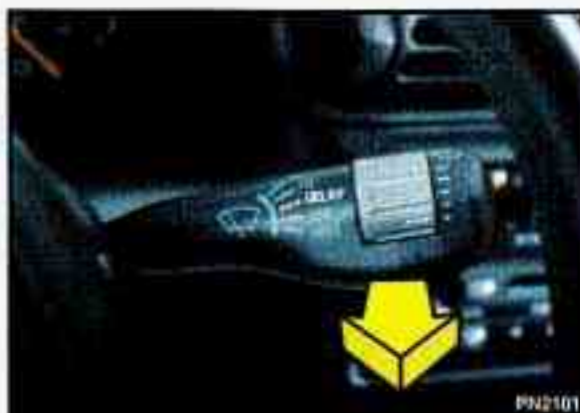

Windshield Washer

Standard Wipers:

To wash your windshield, pull the stalk labeled  toward you until the washers begin. When you release the stalk, the washers will stop, but the wipers will keep going in **LO** until you move the stalk to **OFF**.

Controlled-Cycle Wipers:

If you have controlled-cycle wipers, after each wash cycle ends the wipers will resume the delay speed you were using before. If you had no speed selected, the wipers will stop.

CAUTION



- Driving without washer fluid can be dangerous. A bad mud splash can block your vision. You could hit another vehicle or go off the road. Check your washer fluid level often.
- In freezing weather, don't use your washer until the windshield is warmed. Otherwise the washer fluid can form ice on the windshield, blocking your vision.

NOTICE

- When using concentrated washer fluid, follow the manufacturer's instructions for adding water.
- Don't mix water with ready-to-use washer fluid. Water can cause the solution to freeze and damage your washer fluid tank and other parts of the washer system. Also, water doesn't clean as well as washer fluid.
- Fill your washer fluid tank only $\frac{3}{4}$ full when it's very cold. This allows for expansion, which could damage the tank if it is completely full.
- Don't use radiator antifreeze in your windshield washer. It can damage your washer system and paint.



Inside Manual Day/Night Rearview Mirror

To reduce glare from lights behind you, pull the lever toward you to the night position.



Convex Outside Mirror

Your right side mirror is convex. A convex mirror's surface is curved so you can see more from the driver's seat.

CAUTION

 If you aren't used to a convex mirror, you can hit another vehicle. A convex mirror can make things (like other vehicles) look farther away than they really are. If you cut too sharply into the right lane, you could hit a vehicle on your right. Check your inside mirror or glance over your shoulder before changing lanes.

Features & Controls



Manual Remote Control Mirrors

The outside rearview mirrors should be adjusted so you can just see the side of your vehicle when you are sitting in a comfortable driving position.

Adjust the driver side outside mirror with the control lever on the driver's door.

To adjust your passenger side mirror, sit in the driver's seat and have a passenger adjust the mirror for you.



Power Remote Control Mirrors (OPTION)

A selector knob on the center console controls both outside rearview mirrors. Select the mirror you want to adjust by rotating the knob to the left or right. Adjust each mirror so that you can just see the side of your vehicle when you are sitting in a comfortable driving position.

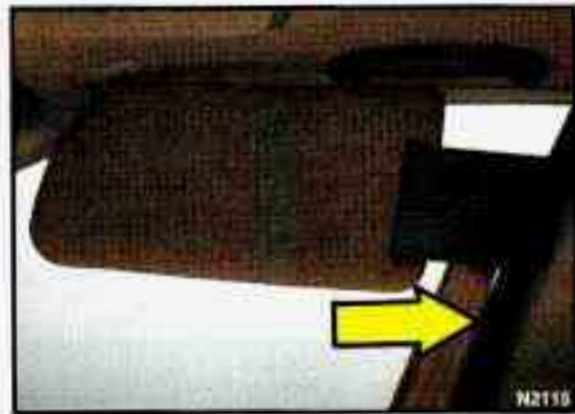

Sun Visors

To block out glare, you can swing down the visors. You can also swing them to the side.

Your vehicle may also have a plastic extension which pulls out of the main visor to increase protection from glare.

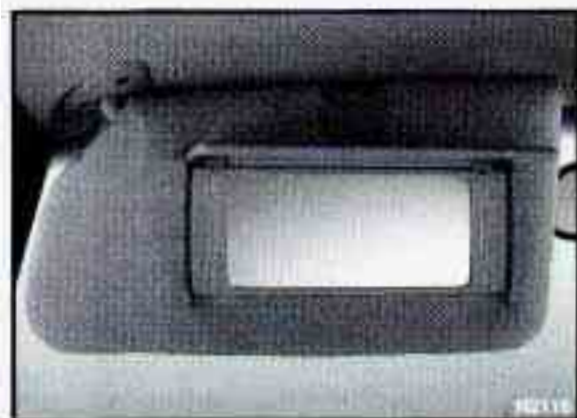

Visor Vanity Mirror

Open the visor cover to expose the vanity mirror.



Armrest Storage Compartment

Pull up on the front edge of the armrest to open the armrest storage area for cassette tapes, gloves, etc.



Cup Holders

The front doors, and the rear side panels on 2-door models, provide space for holding a cup or soft drink.

Features & Controls



Passenger Side Cup Holder/ Storage Area

To access the cup holder and storage area, slide your finger in the groove and press in on the button located in the upper left corner of the instrument panel on the passenger side. Then pull the cup holder forward and down. To close the cup holder/storage area, push the cup holder up and to the left until it latches.

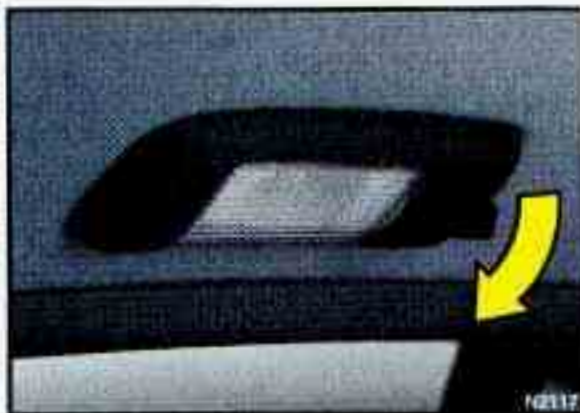

Garment Hook

Push down on the tab marked  to fold down the garment hook.



Coin Holder

Place your coins in the appropriate slots.



Ashtray and Lighter

Lift the cover to reveal the ashtray.

To clean the ashtray, lift it out by pulling up on the snuffer.

You can also use this tray as a cup holder.

NOTICE

Don't put papers and other things that burn into your ashtrays. If you do, cigarettes or other smoking materials could set them on fire, causing damage.

To use the lighter, just push it in all the way and let go. When it's ready, it will pop back by itself.

NOTICE

Don't hold a cigarette lighter in with your hand while it is heating. If you do, it won't be able to back away from the heating element when it's ready. That can make it overheat, damaging the lighter and the heating element.



Sunglasses Storage

Place your sunglasses in the open area located above you in the overhead console.

Features & Controls

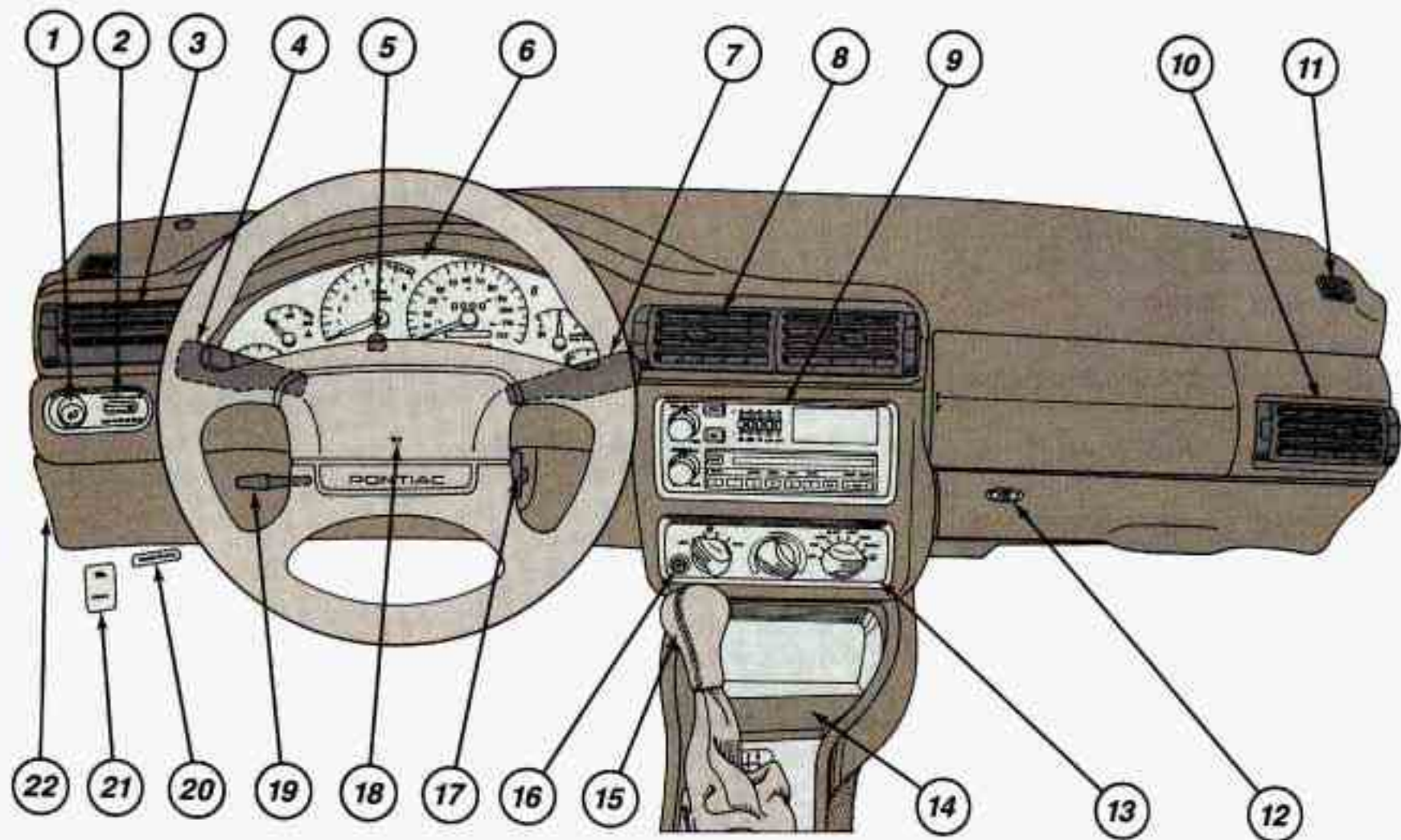



The Instrument Panel— Your Information System

Your instrument panel is designed to let you know at a glance how your vehicle is running. You'll know how fast you're going, how much fuel you're using, and many other things you'll need to drive safely and economically.

The main components of your instrument panel are:

1. Fog Light Switch
2. Instrument Panel Intensity Control/Interior Lights Switch
3. Side Vent
4. Turn Signal/Headlight Beam Lever
5. Hazard Warning Flashers Switch
6. Instrument Cluster
7. Windshield Wiper/Washer Stalk
8. Center Vent
9. Audio System
10. Side Vent
11. Side Window Defogger Vent
12. Glove Box
13. Climate Control System
14. Ashtray/Lighter
15. Gear Shift Lever
16. Rear Window Defogger (Option)
17. Ignition Switch
18. Horn
19. Tilt Steering Wheel Lever (Option)
20. Parking Brake Release Lever
21. Hood Release Handle
22. Fuse Panel

Features & Controls

■ *Instrument Panel Clusters*

Your Pontiac is equipped with one of these instrument panel clusters, which includes indicator warning lights and gages that are explained on the following pages. Be sure to read about those that apply to the instrument panel cluster for your vehicle.

Standard Cluster



NZ101

Optional Cluster



PN2072

Features & Controls

Speedometer and Odometer

Your speedometer lets you see your speed in both miles per hour (mph) and kilometers per hour (km/h). Your odometer shows how far your vehicle has been driven, in either miles (used in the U.S.) or kilometers (used in Canada).

Tamper Resistant Odometer

Your Pontiac has a tamper resistant odometer. If you see silver lines between the numbers, you'll know that someone has probably tried to turn it back, so the numbers may not be true.

You may wonder what happens if your vehicle needs a new odometer installed. If the new one can be set to the mileage total of the old odometer, then it must be. But if it can't, then it's set at zero and a label must be put on the driver's door to show the old mileage reading when the new odometer was installed.

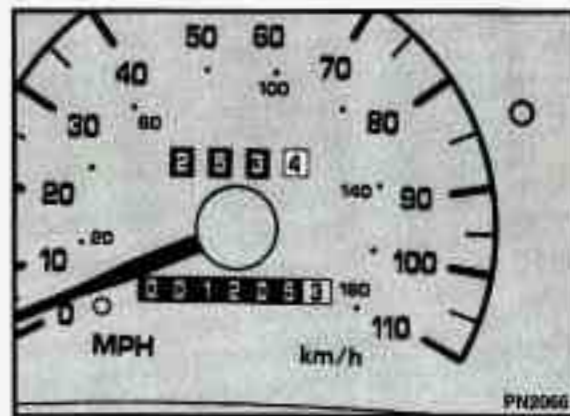

Trip Odometer

The trip odometer can tell you how far you have driven since you last reset it. To reset the trip odometer to zero, press the knob to the right of the gage.

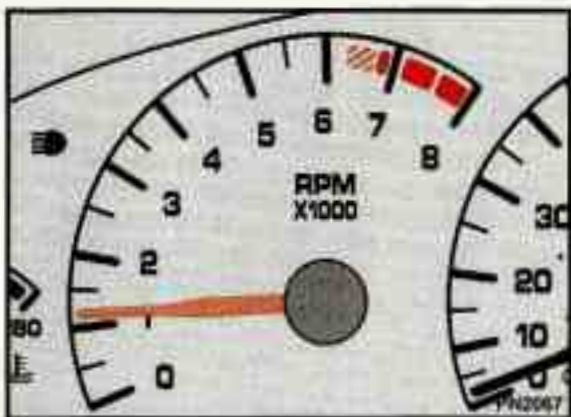

Tachometer (OPTION)

The tachometer shows your engine speed in revolutions per minute (rpm).

NOTICE

Do not run your engine at speeds in the red area, or engine damage may occur.

■ **Warning Lights, Gages and Indicators**

This section describes the warning lights and gages that may be on your vehicle. The pictures will help you locate them.

Warning lights and gages can signal that something is wrong before it becomes serious enough to cause an expensive repair or replacement. Paying attention to your warning lights and gages could also save you or others from injury.

Warning lights go on when there may be or is a problem with one of your vehicle's functions. As you will see in the details on the next few pages, some warning lights come on briefly when you turn the ignition key just to let you know they're working. If you are familiar with this section, you should not be alarmed when this happens.

Gages can indicate when there may be or is a problem with one of your vehicle's functions. Often gages and warning lights work together to let you know when there's a problem with your vehicle.

When one of the warning lights comes on and stays on when you are driving, or when one of the gages shows there may be a problem, check the section that tells you what to do about it. Please follow the manual's advice. Waiting to do repairs can be costly—and even dangerous. So please get to know your warning lights and gages. They're a big help.

Features & Controls

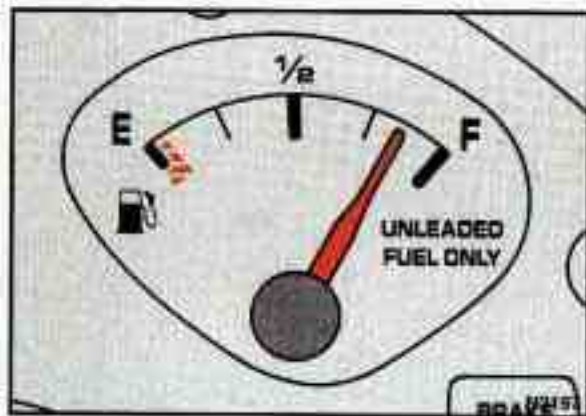

Fuel Gage

Your fuel gage tells you about how much fuel you have left, when the ignition is on. When the indicator nears **E** (Empty), you still have a little fuel left, but you should get more soon.

Here are four things that some owners ask about. None of these show a problem with your fuel gage:

- At the gas station, the gas pump shuts off before the gage reads **F** (Full).
- It takes a little more or less fuel to fill up than the gage indicated. For example, the gage may have indicated the tank was half full, but it actually took a little more or less than half the tank's capacity to fill the tank.

- The gage moves a little when you turn a corner or speed up.
- The gage doesn't go back to **E** when you turn off the ignition.

For your fuel tank capacity, see *Service Station Information* on the last page of this manual.

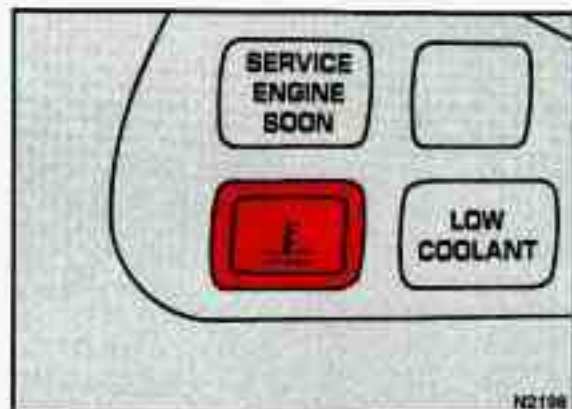

Engine Coolant Temperature Warning Light

This light tells you that your engine coolant has overheated or your radiator cooling fan is not working.

If you have been operating your vehicle under normal driving conditions, you should pull off the road, stop your vehicle and turn the engine off as soon as possible.

HOT COOLANT CAN BURN YOU BADLY!

In *Problems on the Road*, this manual shows what to do. See the *Index* under *Engine Overheating*.

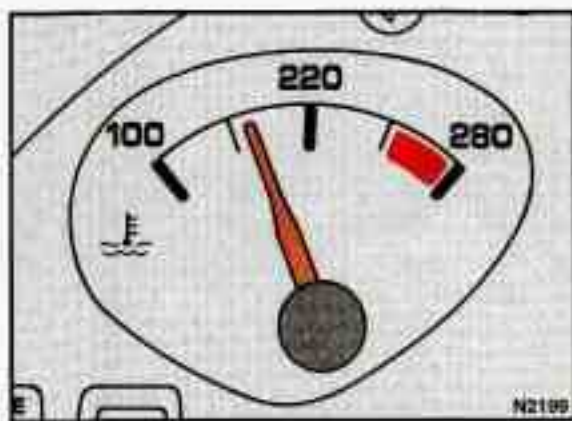

N2199

Engine Coolant Temperature Gage

This gage shows the engine coolant temperature. If the gage pointer moves into the red area, your engine is too hot! That reading means the same thing as the warning light. It means that your engine coolant has overheated.

If you have been operating your vehicle under normal driving conditions, you should pull off the road, stop your vehicle and turn off the engine as soon as possible.

HOT COOLANT CAN BURN YOU BADLY!

In *Problems on the Road*, this manual shows what to do. See the *Index* under *Engine Overheating*.

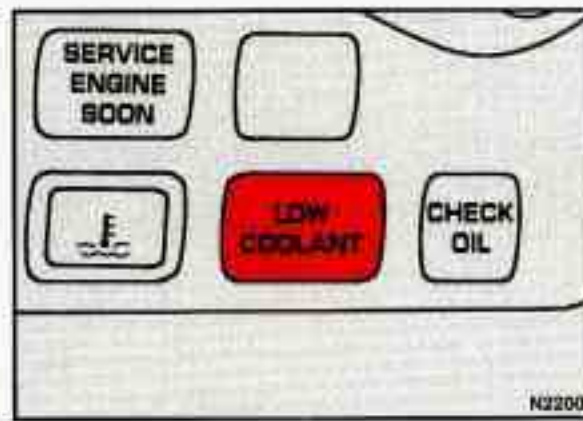

N2200

Low Coolant Warning Light

If this light comes on, your system is low on coolant and the engine may overheat. See the *Index* under *Engine Overheating* and have your vehicle serviced as soon as you can.

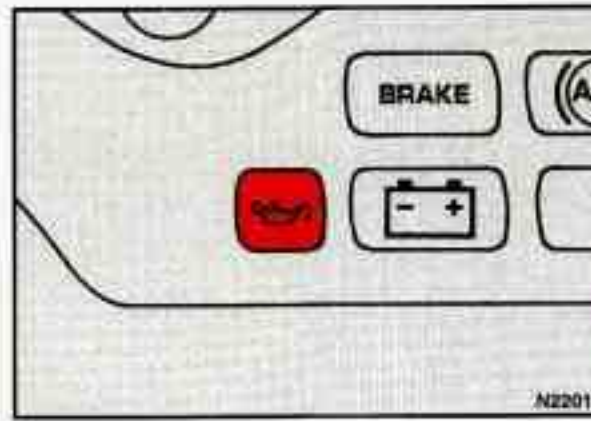

N2201

Oil Warning Light

If you have a problem with your oil, this light may stay on after you start your engine, or come on when you are driving. This indicates that oil is not going through your engine quickly enough to keep it lubricated. The engine could be low on oil, or could have some other oil problem. Have it fixed right away.

Features & Controls

Oil Warning Light (CONT.)

The oil light could also come on in three other situations:

- When the ignition is on but the engine is not running, the light will come on as a test to show you it is working, but the light will go out when you turn the ignition to **Start**. If it doesn't come on with the ignition on, you may have a problem with the fuse or bulb. Have it fixed right away.
- Sometimes when the engine is idling at a stop, the light may blink on and off. This is normal.
- If you make a hard stop, the light may come on for a moment. This is normal.

CAUTION



Don't keep driving if the oil pressure is low. If you do, your engine can become so hot that it catches fire. You or others could be burned. Check your oil as soon as possible and have your vehicle serviced.

NOTICE

Damage to your engine from neglected oil problems can be costly and is not covered by your warranty.

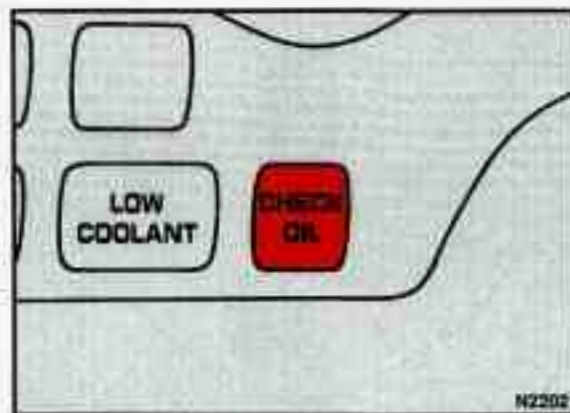

Check Oil Light

This light should come on briefly when you turn your ignition key to **Run**. It also comes on and stays on when the oil level in your vehicle is low. If this happens, park your vehicle in a level place, check your oil level and bring the engine oil up to its proper level. See the *Index* under *Engine Oil*.

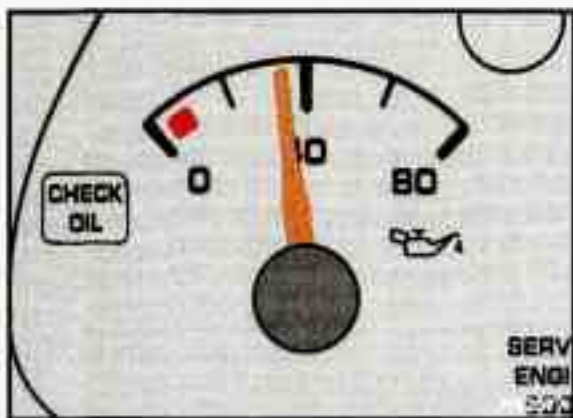

Oil Pressure Gage (OPTION)

The oil pressure gage shows the engine oil pressure in psi (pounds per square inch) when the engine is running. Canadian vehicles indicate pressure in kPa. Oil pressure may vary with engine speed, outside temperature and oil viscosity, but readings above the red warning zone indicate the normal operating range.

A reading in the red zone may be caused by a dangerously low oil level or other problem causing low oil pressure. Have your vehicle serviced immediately.

CAUTION



Don't keep driving if the oil pressure is low. If you do, your engine can become so hot that it catches fire. You or others could be burned. Check your oil as soon as possible and have your vehicle serviced.

NOTICE

Damage to your engine from neglected oil problems can be costly and is not covered by your warranty.

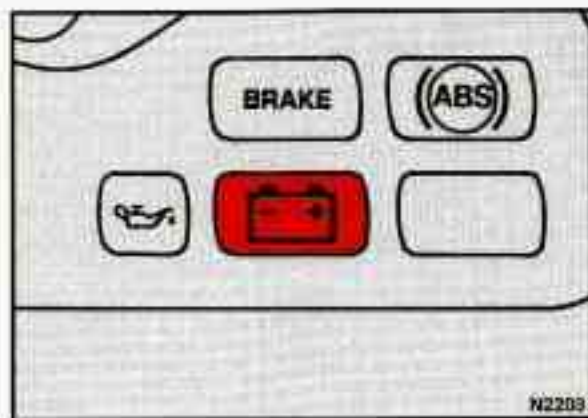

Charging System Light

The charging system light will come on briefly when you turn on the ignition, but the engine is not running, as a check to show you it is working. Then it should go out. If it stays on when your engine is running, or comes on while you are driving, you may have a problem with the electrical charging system. It could indicate that you have a loose generator drive belt or another electrical problem. Have it checked right away. Driving while this light is on could drain your battery.

If you must drive a short distance with the light on, be certain to turn off all your accessories, such as the radio and air conditioner.

Features & Controls



Voltmeter (OPTION)

When your engine is running, this gage shows the condition of your charging system.

When your engine is not running, but the ignition is on (in the **Run** position), the gage shows your battery's state of charge in DC volts. Readings between the red warning zones indicate the normal operating range.

Readings in either red warning zone indicate a possible problem in the electrical system. Have your vehicle serviced immediately.

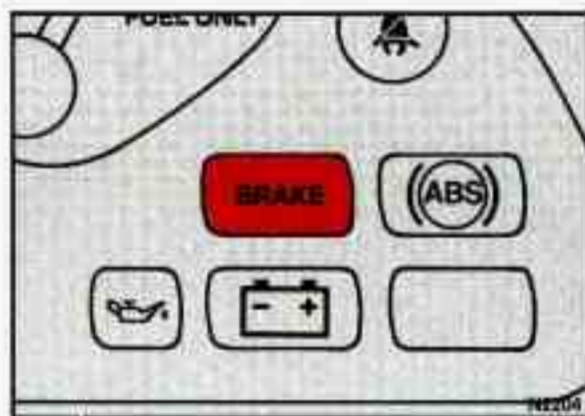

Brake System Warning Light

Your Pontiac's hydraulic brake system is divided into two parts. If one part isn't working, the other part can still work and stop you. For good braking, though, you need both parts working well.

If the warning light goes on, there could be a brake problem. Have your brake system inspected right away.

This light should come on as you start the vehicle. If it doesn't come on then, have it fixed so it will be ready to warn you if there's a problem.

This light will also come on when you set your parking brake, and will stay on if your parking brake doesn't release fully. If it stays on after your parking brake is fully released, it means you have a brake problem. If the light comes on while driving, pull off the road and stop carefully. You may notice that the pedal is harder to push. Or, the pedal may go closer to the floor. It may take longer to stop. If the light is still on, have the vehicle towed for service. (See the *Index* under *Towing Your Pontiac*.)

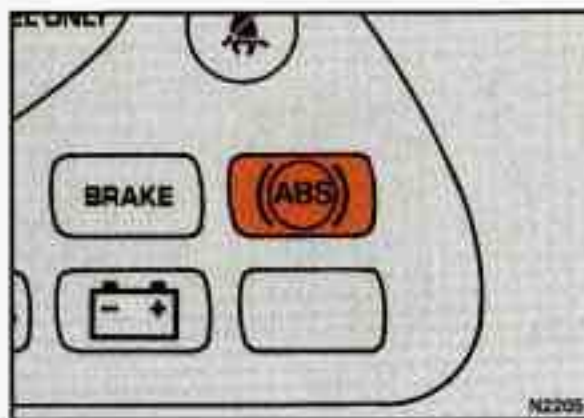

CAUTION



Your brake system may not be working properly if the brake warning light is on. Driving with the brake warning light on can lead to an accident. If the light is still on after you've pulled off the road and stopped carefully, have the vehicle towed for service.

Anti-Lock Brake System Warning Light

With anti-lock, this light will go on when you start your engine and may stay on for two seconds or so. That's normal. If the light doesn't come on, have it fixed so it will be ready to warn you if there is a problem.

If the light stays on or comes on when you're driving, stop as soon as possible and turn the key off. Then start the engine to reset the system. If the light still stays on, or comes on again while you're driving, your Pontiac needs service. Unless the regular brake system warning light is also on, you will still have brakes, but not anti-lock brakes. If the regular brake system warning light is

also on, see *Brake System Warning Light* earlier in this part.

If the anti-lock brake system warning light ever flashes, your anti-lock brake system is still working but needs service as soon as possible.

Features & Controls

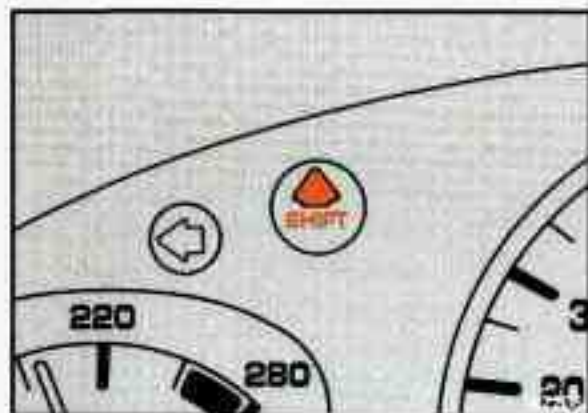

Shift Light (MANUAL TRANSAXLE)

This light comes on when you need to shift to the next higher gear. See the *Index* under *Manual Transaxle*.

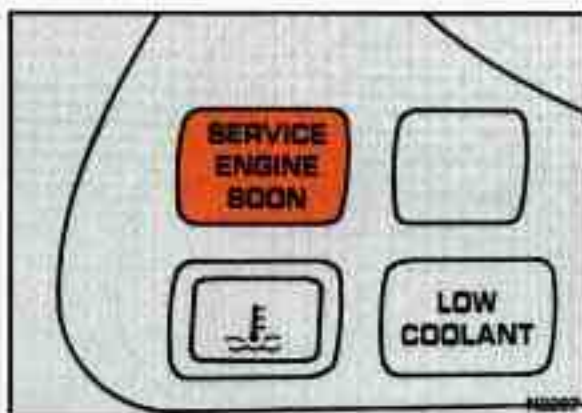

Malfunction Indicator Lamp (Service Engine Soon Light)

A computer monitors operation of your fuel, ignition and emission control systems. This light should come on when the ignition is on, but the engine is not running, as a check to show you it is working. If it does not come on at all, have it fixed right away. If it stays on, or it comes on while you are driving, the computer is indicating that you have a problem. You should take your vehicle in for service soon.

NOTICE

If you keep driving your vehicle with this light on, after a while the emission controls won't work as well, your fuel economy won't be as good and your engine may not run as smoothly. This could lead to costly repairs not covered by your warranty.

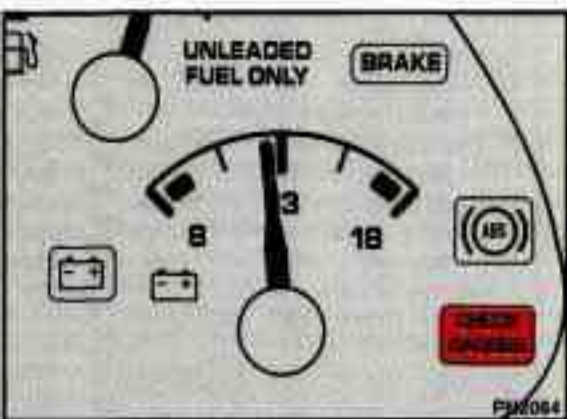

Check Gauges Light (OPTION)

This light will come on briefly when you are starting the engine. If the light comes on and stays on while you are driving, check your various gauges to see if they are in the warning zones.

Notes

Part **3**

Comfort Controls & Audio Systems



In this part you'll find out how to operate the comfort control systems and audio systems offered with your Pontiac. Be sure to read about the particular system supplied with your vehicle.

Climate Control System	102
Air Conditioning System	103
Setting the Clock	107
AM/FM Stereo Radio	108
AM/FM Stereo Radio with Cassette Tape Player	109
AM/FM Stereo Radio with Cassette Tape Player and Graphic Equalizer	111
AM/FM Stereo Radio with Compact Disc Player	113
Understanding Radio Reception	117
Care of Your Cassette Tape Player	118
Care of Your Compact Discs	118
Fixed Mast Antenna	119
Power Antenna Mast Care	119

Comfort Controls & Audio Systems



■ Climate Control System

With this system, you can control the ventilation and heating in your vehicle.

Your vehicle also has the flow-through ventilation system described later in this section.

 : The left control knob sets the fan speed. To select the force of air you want, turn the knob. The fan is always running unless the mode control is moved to **OFF**.

Temperature Control: The center control knob regulates the temperature of the air coming through the system.

Mode Control: The right control knob changes the functions of your system.

 (**Bi-Level**): Use on cool, but sunny days. This setting brings in the outside air, but directs it in two ways. The cool air is directed to the upper portion of your body through the instrument panel outlets, but slightly warmer air is directed through the heater ducts and defroster vents. At times this temperature difference may be more apparent than others.

 (**Vent**): Use when outside temperatures are mild, and little heating or cooling is needed. Air flow is through the instrument panel outlets. Set the center control knob to the temperature desired.

 (**Heater**): This setting brings heated air through the heater ducts, and some through the windshield defroster vents. If you have the optional engine block heater and use it during cold weather, 0°F (-18°C) or lower, your heating system will more quickly provide heat because the engine coolant is already warmed. See the *Index* under *Engine Block Heater*.

 (**Blend**): This setting divides air flow equally between the heater ducts and the windshield defroster vents.

 (**Defrost**): This setting directs most air through the windshield defroster vents, and some through the heater ducts.



Defogging Windows

To defog the windshield, turn all three control knobs to the far right.

■ Air Conditioning System (OPTION)

The air conditioner and heater work best if you keep your windows closed while using them. Your vehicle also has the flow-through ventilation system described later in this section.

: The left control knob sets the fan speed. To select the force of air you want, turn the knob. The fan is always running unless the mode control is moved to **OFF**.

Temperature Control: The center control knob regulates the temperature of the air coming through the system.

Mode Control: The right control knob changes the functions of your system.

Air Conditioning

Your system has three air conditioner settings. Before using your air conditioner on very hot days, open the windows long enough to let hot inside air escape. This reduces the amount of work your air conditioner's compressor will have to do, which should help fuel economy.

MAX: Use for maximum cooling. This setting recirculates much of the air inside your vehicle so it maximizes your air conditioner's performance and your vehicle's fuel economy.

A/C: Use for normal cooling on hot days. This setting cools outside air and directs it through the instrument panel outlets.

Comfort Controls & Audio Systems

Air Conditioning (CONT.)

 (Bi-Level): Use on cool, but sunny days. This setting brings in the outside air, but directs it in two ways. The cool air is directed to the upper portion of your body through the instrument panel outlets, but slightly warmer air is directed through the heater ducts and defroster vents. At times this temperature difference may be more apparent than others.



The air conditioner compressor operates in all three air conditioning positions. It also operates in  (Defrost) when the outside temperature is higher than about 40°F (4.5°C).

Ventilation

Use when outside temperatures are mild, and little heating or cooling is needed. Turn the right control knob to  (Vent). Air flow is directed through the instrument panel outlets. Set the center control knob to the temperature desired.

Heating

Turning the right control knob to  (Heater) and the center control knob clockwise will send heated air through the heater ducts, and some through the defroster vents.

 (Vent) and  (Heater) are economical positions because the air conditioner compressor doesn't run in these two settings. This reduces engine load, resulting in improved fuel economy. If either setting fails to keep

you comfortable, or causes your windows to fog up, turn the right control knob to one of the air conditioning positions, or to  (Defrost).

If you have the optional engine block heater and use it during cold weather, 0°F (-18°C) or lower, your heating system will more quickly provide heat because the engine coolant is already warmed. See the *Index* under *Engine Block Heater*.

 (Blend): This setting divides air flow equally between the heater ducts and the windshield defroster vents.

Defrosting

The  (Defrost) setting directs most air through the defroster vents, and some through the heater ducts.

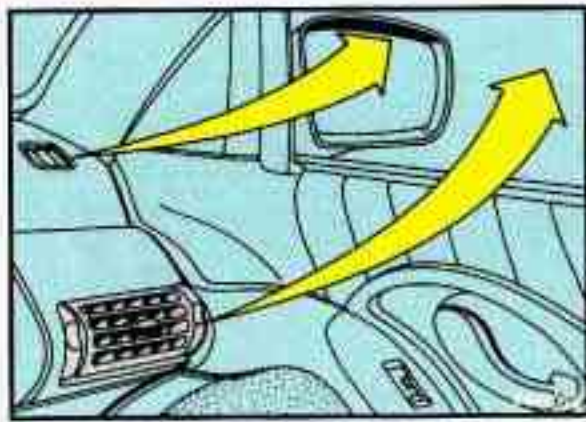

Defogging Windows with Air Conditioning System

To defog the windshield, turn all three control knobs to the far right.

To defog the side windows, turn the right control knob to  (Bi-Level) and the fan control knob to **HIGH**. Aim the side vents toward the side windows. For increased air flow to the side vents, close the center vents.

Rear Window Defogger (OPTION)

The rear window defogger uses a warming grid to remove fog from the rear window. Press the defogger switch. The indicator light will glow. If your vehicle is traveling under 45 mph (70 km/h), the rear window defogger will turn off automatically after about 10 minutes of use. If your vehicle is traveling over 45 mph (70 km/h), the defogger will operate continuously. You can turn the defogger off by turning off the ignition or pressing the switch again. Do not attach a temporary vehicle license across the defogger grid on the rear window.

Comfort Controls & Audio Systems



Rear Window Defogger (CONT.)

NOTICE

Don't use a razor blade or something else sharp on the inside of the rear window. If you do, you could cut or damage the warming grid, and the repairs wouldn't be covered by your warranty.

Flow-Through Ventilation System

Your Pontiac's flow-through ventilation system supplies outside air into the vehicle when it is moving. Outside air will also enter the vehicle when the heater or the air conditioning fan is running.

Ventilation Tips

- Keep the hood and front air inlet free of ice, snow, or any other obstruction (such as leaves). The heater and defroster will work far better, reducing the chance of fogging the inside of your windows.
- When you enter a vehicle in cold weather, turn the fan control knob to **HIGH** for a few moments before driving off. This helps clear the intake ducts of snow and moisture, and reduces the chance of fogging the inside of your windows.
- Keep the air path under the front seats clear of objects. This helps air to circulate throughout your vehicle.

■ Audio Systems

The following pages describe the audio systems available for your Pontiac, and how to get the best performance from them. Please read about the system in your vehicle.

CAUTION

 Hearing damage from loud noise is almost undetectable until it is too late. Your hearing can adapt to higher volumes of sound. Sound that seems normal can be loud and harmful to your hearing. Take precautions by adjusting the volume control on your radio to a safe sound level before your hearing adapts to it.

To help avoid hearing loss or damage:

1. Adjust the volume control to the lowest setting.
2. Increase volume slowly until you hear comfortably and clearly.

NOTICE

Before you add any sound equipment to your vehicle—like a tape player, CB radio, mobile telephone or two-way radio—be sure you can add what you want. If you can, it's very important to do it properly. Added sound equipment may interfere with the operation of your vehicle's engine, Delco® radio or other systems, and even damage them. And, your vehicle's systems may interfere with the operation of sound equipment that has been added improperly.

So, before adding sound equipment, check with your dealer and be sure to check federal rules covering mobile radio and telephone units.



Setting the Clock

No matter which audio system you have in your vehicle, setting the clock is easy.

1. With the ignition on and radio on or off, press **SET**. The **SET** indicator will appear on the digital screen for five seconds.
2. You must begin to set the clock to the correct hour and minute during those five seconds.

Depress **▼SEEK** or **◀SEEK** to set the hour.

Depress **SEEK▲** or **SEEK▶** to set the minute.

Comfort Controls & Audio Systems



AM/FM Stereo Radio

The digital display indicates information on time or radio station frequency, the AM or FM radio band, whether the station is in stereo, and other radio functions.

PWR•VOL (Power•Volume): With the ignition on, rotate the upper knob to the right to turn on the radio and increase volume.

RECALL: Press the upper knob to change between the clock and the radio station frequency displayed when the radio is on.

BAL (Balance): The control ring behind the upper knob adjusts the left/right speaker balance.

TUNE: Rotate the lower knob to the left or right to tune in radio stations (the radio station frequency will be displayed on the digital screen).

AM•FM: Press the lower knob to change between the AM and FM bands (the digital screen will display AM or FM, and if the station is in stereo, FM STEREO will be displayed).

FADE: The control ring behind the lower knob adjusts the front/rear speaker balance.

TREB (Treble): Slide this lever up to increase treble, or down to decrease it. If a station is weak or noisy, reduce the treble.

BASS: Slide this lever up to increase bass, or down to decrease it.

SEEK: Each time you press SEEK, you will tune in the next station higher or lower on the AM or FM radio band.

To Preset Radio Stations:

The four numbered pushbuttons can be used to preset up to 14 radio stations (seven AM and seven FM).

1. Tune in the desired station.
 2. Press SET. The word SET will appear on the digital screen for five seconds.
 3. While SET is displayed, press one of the four pushbuttons. Whenever you press this button again, the preset station will be tuned in.
 4. Repeat steps 1-3 for each of four AM and four FM stations.
- Up to three additional stations on each band may be preset by "pairing" pushbuttons:
1. Tune in the desired station.
 2. Press SET, and within five seconds press any two adjacent pushbuttons at the same time. Whenever you press these two buttons again, the preset station will be tuned in.



AM/FM Stereo Radio with Cassette Tape Player (OPTION)

The digital display indicates information on time or radio station frequency, the AM or FM radio band, whether the station is in stereo, and other radio functions.

TURN PWR (Power): With the ignition on, rotate the upper knob to turn your audio system on and off.

VOL-BAL (Volume-Balance): Rotate the upper knob to the right to increase volume, and to the left to decrease volume.

PROG-RCL (Program-Recall): Press the upper knob to change between the clock and the radio station frequency displayed when the radio is on.

R L (Balance): The control ring behind the upper knob adjusts the left/right speaker balance.

TUNE-FADE: Rotate the lower knob to the left or right to tune in radio stations (the radio station frequency will be displayed on the digital screen).

AM-FM: Press the lower knob to change between the AM and FM bands (the digital screen will display AM or FM, and if the station is in stereo, STEREO will be displayed).

F R (Fade): The control ring behind the lower knob adjusts the front/rear speaker balance.

TREBLE: Slide this lever up to increase treble, or down to decrease it. If a station is weak or noisy, reduce the treble.

BASS: Slide this lever up to increase bass, or down to decrease it.

SEEK: Each time you press **SEEK**, you will tune in the next station higher or lower on the AM or FM radio band.

To Preset Radio Stations:

The four pushbuttons below the digital display can be used to preset up to 14 radio stations (seven AM and seven FM).

1. Tune in the desired station.
2. Press **SET**. The word **SET** will appear on the digital screen for five seconds.
3. While **SET** is displayed, press one of the four pushbuttons. Whenever you press this button again, the preset station will be tuned in.
4. Repeat steps 1-3 for each of four AM and four FM stations.

Comfort Controls & Audio Systems



AM/FM Stereo Radio with Cassette Tape Player (CONT.)

Up to three additional stations on each band may be preset by "pairing" pushbuttons:

1. Tune in the desired station.
2. Press **SET**, and within five seconds press any two adjacent pushbuttons at the same time. Whenever you press these two buttons again, the preset station will be tuned in.

Cassette Tape Player

With the power on, insert a tape into the cassette door. Do not use tapes that are longer than 45 minutes on each side.

When the left indicator arrow is lit, selections listed on the top side of the cassette are playing. When the right indicator arrow is lit, selections listed on the bottom side of the cassette are playing. Press the upper control knob to change sides of a cassette while it is playing. The tape player automatically begins playing the other side when it reaches the end of a tape.

Fast Forward▶: To advance the tape rapidly, press the button with the arrow pointing to the right. To stop fast forward, press the **STOP-EJECT** button.

Reverse◀: To reverse the tape rapidly, press the button with the arrow pointing to the left. To stop reverse, press the **STOP-EJECT** button.

STOP-EJECT: To stop playing a tape, press this button. The cassette will be partially ejected, and the radio will begin playing.



AM/FM Stereo Radio with Cassette Tape Player and Graphic Equalizer (OPTION)

The digital display indicates information on time or radio station frequency, the AM or FM radio band, whether the station is in stereo, and other radio functions.

TURN PWR (Power): With the ignition on, rotate the upper knob to turn your audio system on and off.

VOL-BAL (Volume-Balance): Rotate the upper knob to the right to increase volume, and to the left to decrease volume.

PROG-RCL (Program-Recall): Press the upper knob to change between the clock and the radio station frequency displayed when the radio is on.

R -> L (Balance): The control ring behind the upper knob adjusts the left/right speaker balance.

TUNE-FADE: Rotate the lower knob to the left or right to tune in radio stations (the radio station frequency will be displayed on the digital screen).

AM-FM: Press the lower knob to change between the AM and FM bands (the digital screen will display **AM** or **FM**, and if the station is in stereo, **AM STEREO** or **FM STEREO** will be displayed).

F -> R (Fade): The control ring behind the lower knob adjusts the front/rear speaker balance.

Graphic Equalizer Controls: Boost the bass, emphasize a voice in a song, brighten the treble—your equalizer allows you to adjust five separate frequencies of sound to your individual taste. Move a lever up to emphasize a frequency, and move it down to de-emphasize a frequency. It's best to begin with the levers in the middle position, then adjust each lever as you like.

AM/ST: Press this button if you don't want AM stereo, such as when a station is weak or noisy. Press again to return to AM stereo.

▼SEEK▲: Each time you press **SEEK**, you will tune in the next station higher or lower on the AM or FM radio band.

Comfort Controls & Audio Systems

AM/FM Stereo Radio with Cassette Tape Player and Graphic Equalizer (CONT.)

To Preset Radio Stations:

The four pushbuttons below the digital display can be used to preset up to 14 radio stations (seven AM and seven FM).

1. Tune in the desired station.
2. Press **SET**. The word **SET** will appear on the digital screen for five seconds.
3. While **SET** is displayed, press one of the four pushbuttons. Whenever you press this button again, the preset station will be tuned in.
4. Repeat steps 1-3 for each of four AM and four FM stations.

Up to three additional stations on each band may be preset by "pairing" pushbuttons:

1. Tune in the desired station.
2. Press **SET**, and within five seconds press any two adjacent pushbuttons at the same time. Whenever you press these two buttons again, the preset station will be tuned in.

Cassette Tape Player

With the power on, insert a tape into the cassette door. Do not use tapes that are longer than 45 minutes on each side.

When the indicator arrow pointing up is lit, selections listed on the top side of the cassette are playing. When the indicator arrow pointing down is lit, selections listed on the bottom side of the cassette are playing. Press the upper control knob to change sides of a cassette while it is playing. The tape player automatically begins playing the other side when it reaches the end of a tape.

FWD (Fast Forward): Press to advance the tape rapidly. Press again to play the tape.

REV (Reverse): Press to reverse the tape rapidly. Press again to play the tape.

SEARCH: Move this switch to the right and the **FWD** and **REV** buttons will function as a "music search," stopping the cassette at the next selection on the tape. (There must be at least a three second gap between selections on the tape for this function to work.) The **ON** light will come on to indicate the music search is in progress.

EJECT: To stop playing a tape, press this button. The cassette will be partially ejected, and the radio will begin playing.

CrO₂: This button sets tape bias. When playing high bias chrome or metal tapes, press **CrO₂** to turn the button light on. When playing standard tapes, press again to turn the button light off.



AM/FM Stereo Radio with Compact Disc Player (OPTION)

The digital display indicates information on time or radio station frequency, the AM or FM radio band, whether the station is in stereo, and other radio functions.

PWR (Power): With the ignition on, press this button to turn your audio system on and off.

VOL (Volume): Rotate the upper knob to the right to increase volume, and to the left to decrease volume.

MUTE: Press the upper knob to mute the radio or compact disc player. Press the knob again to listen.

BAL (Balance): The control ring behind the upper knob adjusts the left/right speaker balance.

TUNE: Rotate the lower knob to the left or right to tune in radio stations (the radio station will be displayed on the digital screen).

BAND: Press the lower knob to change between the AM, FM1 and FM2 bands (the digital screen will display the band you select).

Your radio has an AMAX-certified receiver. It can produce quality AM stereo sound and receive C-Quan[®] stereo broadcasts. AMAX reduces noise

without reducing the high frequencies you need for the best sound. You don't have to do anything to your Delco/GM radio because AMAX is automatic.

FADE: The control ring behind the lower knob adjusts the front/rear speaker balance.

RCL (Recall): Press this button to alternate the digital display between the time, station and radio band.

◀SEEK▶: Each time you press **SEEK**, you will tune in the next station higher or lower on the AM, FM1 or FM2 radio band.

Graphic Equalizer Controls: Boost the bass, emphasize a voice in a song, brighten the treble—your equalizer allows you to adjust five separate frequencies of sound to your individual taste. Move a lever up to emphasize a frequency, and move it down to de-emphasize a frequency. It's best to begin with the levers in the middle position, then adjust each lever as you like.

Comfort Controls & Audio Systems

AM/FM Stereo Radio with Compact Disc Player (CONT.)

To Preset Radio Stations:

The five numbered pushbuttons can be used to preset up to 15 radio stations (five AM, five FMI and five FM2). The buttons have other uses when you are playing a compact disc.

1. Tune in the desired station.
2. Press **SET**. The word **SET** will appear on the digital screen for five seconds.
3. While **SET** is displayed, press one of the five pushbuttons. Whenever you press this button again, the preset station will be tuned in.
4. Repeat steps 1-3 for each of five AM and five FMI stations.
5. Press the lower knob until **FM2** appears on the digital display. You can then follow steps 1-3 for five more FM stations.



Compact Disc Player

Many of the controls for the radio also have functions for the compact disc player, as explained here.

Don't use mini-discs that are called singles. They won't eject. Use only full-size compact discs.

1. Press **PWR** to turn the radio on.
2. Insert a disc part-way into the slot, with the label side up. The player will pull it in. Within a few seconds, the disc should play.

If the disc comes back out and/or **Err** appears on the display:

- The disc may be upside down.
- The disc may be dirty, scratched or wet.
- There may be too much moisture in the air (wait about one hour and try again).
- The player may be too hot, or the road may be too rough for the disc to play. As soon as things get back to normal, the disc should play.

While a disc is playing, the **CD** indicator is displayed on the digital screen, as is the clock.

RCL (Recall): Press this button once to see which track is playing. Press again within five seconds to see how long your selection has been playing. The track number also will be displayed when the volume is changed or a new track starts to play.

COMP (Compression): Pressing this button makes soft and loud passages more equal in volume. Press again to resume normal play.

RDM (Random): Press to play tracks in random, rather than sequential, order. Press the button again to play the tracks sequentially.

REV (Reverse): Press and hold to rapidly reverse the disc. Release to resume playing.

FWD (Fast Forward): Press and hold to rapidly advance the disc. Release to resume playing.

PREV (Previous): Press to play a track again. If you keep pressing the **PREV** button, the disc will keep backing up to previous tracks.

NEXT: Press to advance to the next track. If you keep pressing the **NEXT** button, the disc will keep advancing to other tracks.

When Finished with the Compact Disc Player:

If you press **PWR** or turn off the ignition, the disc will stay in the player and start again when you turn on the ignition or the **PWR** button. The disc will begin playing at the point where it had been stopped.

ST-PL (Stop-Play): Press to stop the disc player; the radio will play. Press again to play the disc (the player will start playing the disc where it had stopped earlier).

EJCT (Eject): Press to eject the disc; the radio will play. You can also eject the disc with the radio or ignition off.

Comfort Controls & Audio Systems

CD Player Anti-Theft Feature

Delco LOC II® is an anti-theft feature for the compact disc player. It can be used or ignored. If ignored, the system plays normally. If it is used, your player won't be usable if it is ever stolen, because it will go to **LOC** mode any time battery power is removed. It will also go to **LOC** mode any time power from the battery is turned off by the Battery Rundown Protection feature (see the *Index* under *Battery Rundown Protection*). Until an unLOC code is entered, it will not turn on.

The instructions below tell you how to enter a secret code into the system. If your vehicle loses battery power for any reason, you must unlock the system with the secret code before your audio system will turn on.

To Set the Anti-Theft System:

1. Write down any six-digit number and keep it in a safe place. This is your secret code.
2. Turn the ignition to the **Accessory** or **Run** position.
3. Press the **PWR** button to turn the radio off.

4. Press station preset buttons **1** and **4** at the same time and hold until "----" appears on the display.

NOTE: You now have only 15 seconds between each of the following steps.

5. Press **SET**, and **000** will appear on the display.
6. Press the **SEEK▶** button until the first digit of your code appears.
7. Rotate the lower knob right or left until the second and third digits of your code appear.
8. Press the lower knob (**000** will appear again on the display).
9. Press the **SEEK▶** button until the fourth digit of your code appears.
10. Rotate the lower knob right or left until the fifth and sixth digits of your code appear.
11. Press the lower knob (**rEP** will appear for five seconds, then **000**).
12. Repeat steps 6-11. This time **SEC** will appear, indicating that Delco LOC II® is set, and your audio system is secure.

To Disable the Anti-Theft System:

Enter your secret code by following these steps (you will have only 15 seconds between each step).

1. Turn the ignition to the **Accessory** or **Run** position, and turn the radio off.
2. Press station preset buttons **1** and **4** at the same time. **SEC** will appear on the display, indicating the audio system is secure.
3. Press **SET**, and **000** will appear on the display.
4. Press the **SEEK▶** button until the first digit of your code appears.
5. Rotate the lower knob right or left until the second and third digits of your code appear.

6. Press the lower knob (**000** will appear again on the display).
7. Press the **SEEK▶** button until the fourth digit of your code appears.
8. Rotate the lower knob right or left until the fifth and sixth digits of your code appear.
9. Press the lower knob. If the display shows “—”, the disabling sequence was successful (the numbers matched the user-selected code or the factory back-up code) and the audio system is in the **UNSECURED** mode. If the display shows **SEC**, the disabling sequence was unsuccessful and the numbers did not match either of the codes. In this case, the audio system will remain in the **SECURED** mode.

To Unlock the System After a Power Loss:

When battery power is reapplied to a secured audio system after a loss of power, the audio system will not turn on and **LOC** will appear on the digital display. You will need to unlock the Delco LOC II[®] system.

1. Turn the ignition to the **Accessory** or **Run** position, and turn the radio off.
2. Press **SET**, and **000** will appear on the display.
3. Follow steps 4-8 for disabling your anti-theft system.
4. Press the lower knob. The time will appear on the digital display if you are successful. If **SEC** appears, however, the numbers did not match and your audio system is still locked.

Understanding Radio Reception

FM Stereo

FM stereo will give you the best sound, but FM signals will reach only about 10 to 40 miles (16 to 65 km). Tall buildings or hills can interfere with FM signals, causing the sound to come and go.

AM

The range for most AM stations is greater than for FM, especially at night. The longer range, however, can cause stations to interfere with each other. AM can also pick up noise from things like storms and power lines. To lower this noise, try reducing the treble level.

AM Stereo

Your Delco[®] system may be able to receive C-Quam[®] stereo broadcasts. Many AM stations around the country use C-Quam[®] to produce stereo, though some do not. C-Quam[®] is a registered trademark of Motorola, Inc. If your Delco[®] system can get C-Quam[®] signals, your stereo indicator light will come on when you are receiving it.

Comfort Controls & Audio Systems



Care of Your Cassette Tape Player

A tape player that is not cleaned regularly can cause reduced sound quality, ruined cassettes, or a damaged mechanism. Cassette tapes should be stored in their cases away from contaminants, direct sunlight, and extreme heat. If they aren't, they may not operate properly or cause failure of the tape player.

Your tape player should be cleaned regularly each month or after every 15 hours of use. If you notice a reduction in sound quality, try a known good cassette to see if the tape or the tape player is at fault. If this other cassette has no improvement in sound quality, clean the tape player.

Clean your tape player with a wiping-action, non-abrasive cleaning cassette, and follow the directions provided with it.

Cassettes are subject to wear and the sound quality may degrade over time. Always make sure that the cassette tape is in good condition before you have your tape player serviced.



Care of Your Compact Discs

Handle discs carefully. Store them in their original cases or other protective cases and away from direct sunlight and dust. If the surface of a disc is soiled, dampen a clean, soft cloth in a mild, neutral detergent solution and clean it, wiping from the center to the edge.

Be sure never to touch the signal surface when handling discs. Pick up discs by grasping the outer edges or the edge of the hole and the outer edge.



NOTICE

Don't lubricate the power antenna. Lubrication could damage it.

NOTICE

Before entering an automatic vehicle wash, turn off your radio to make the power antenna go down. This will prevent the mast from possibly getting damaged. If the antenna does not go down when you turn the radio off, it may be damaged or need to be cleaned. In either case, lower the antenna by hand by carefully pressing the antenna down.

If the mast portion of your antenna is damaged, you can easily replace it. See your dealer for a replacement kit and follow the instructions in the kit.

Fixed Mast Antenna

The fixed mast antenna can withstand most vehicle washes without being damaged. If the mast should ever become slightly bent, you can straighten it out by hand. If the mast is badly bent, as it might be by vandals, you should replace it.

Check every once in a while to be sure the mast is still tightened to the fender.

Power Antenna Mast Care

The optional power antenna will look its best and work well if it's cleaned from time to time.

To Clean the Antenna Mast:

1. Turn on the ignition and radio to raise the antenna to full mast extension.
2. Dampen a clean cloth with mineral spirits or equivalent solvent.
3. Wipe cloth over the mast sections, removing any dirt.
4. Wipe dry with a clean cloth before retracting.
5. Make the antenna go up and down by turning the radio or ignition on and off.
6. Then repeat if necessary.

Notes



Part 4

Your Driving and the Road

Here you'll find information about driving on different kinds of roads and in varying weather conditions. We've also included many other useful tips on driving.

Road Signs	122
Defensive Driving	126
Drunken Driving	127
Control of a Vehicle	129
Braking	130
Anti-Lock Brakes	131
Steering Tips	136
Steering in Emergencies	137
Passing	138
Driving at Night	142
Driving in the Rain	144
Driving in Fog, Mist and Haze	146
City Driving	147
Freeway Driving	148
Driving a Long Distance	150
Hill and Mountain Roads	152
Parking on Hills	154
Winter Driving	156
Towing a Trailer	159

Your Driving and the Road

■ Road Signs

The road signs you see everywhere are coded by color, shape and symbols. It's a good idea to know these codes so that you can quickly grasp the basic meaning or intent of the sign even before you have a chance to read it.



STOP

DO NOT
ENTER

WRONG
WAY

Color of Road Signs

Red means **Stop**. It may also indicate that some movement is not allowed. Examples are **Do Not Enter** and **Wrong Way**.



Green is used to guide the driver. Green signs may indicate upcoming freeway exits or show the direction you should turn to reach a particular place.

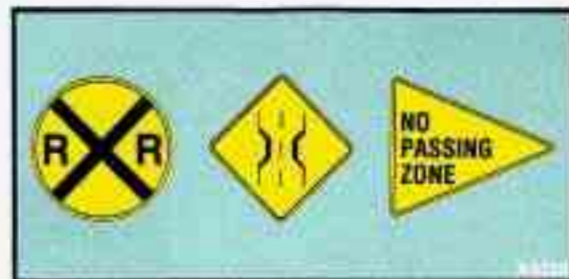

RR ADVANCE
CROSSING

NARROW
BRIDGE

NO PASSING
ZONE

Yellow indicates a general warning. Slow down and be careful when you see a yellow sign. It may signal a railroad crossing ahead, a no passing zone, or some other potentially dangerous situation. Likewise, a yellow solid line painted on the road means **Don't Cross**.



HOSPITAL

INFORMATION

Blue signs with white letters show motorists' services.



LOW
SHOULDER

WORKERS
AHEAD

FLAGGER
AHEAD

Orange indicates road construction or maintenance. You'll want to slow down when you see an orange sign, as part of the road may be closed off or torn up. And there may be workers and maintenance vehicles around, too.



X3014

Shape of Road Signs

The shape of the sign will tell you something, too.

An **octagonal** (eight-sided) sign means **Stop**. It is always red with white letters.



A **diamond**-shaped sign is a warning of something ahead—for example, a curve, steep hill, soft shoulder, or a narrow bridge.



X3013

CANOEING

SWIMMING

Brown signs point out recreation areas or points of historic or cultural interest.



X3016

A **triangle**, pointed downward, indicates **Yield**. It assigns the right of way to traffic on certain approaches to an intersection.



X3017

A **triangular** sign also is used on two-lane roads to indicate a **No Passing Zone**. This sign will be on the left side of the roadway.

Your Driving and the Road

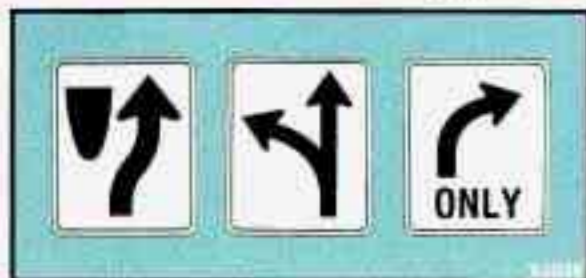

KEEP
RIGHT

LEFT OR
THROUGH

RIGHT TURN
ONLY

Shape of Road Signs (CONT.)

Rectangular (square or oblong) signs show speed limits, parking regulations, give directions, and such information as distances to cities.



Symbols on Road Signs

There are many international road signs in use today.



NO U
TURN

NO
PARKING

NO
BICYCLES

The basic message of many of these signs is in pictures or graphic symbols. A picture within a circle with a diagonal line across it shows what **not** to do.



Traffic Lights

We're all familiar with traffic lights or stop lights. Often green arrows are being used in the lights for improved traffic control. On some multilane roads, green arrows light up, indicating that traffic in one or more lanes can move or make a turn. Green arrows don't mean "go no matter what." You'll still need to proceed with caution, yielding the right of way to pedestrians and sometimes to other vehicles.

Some traffic lights also use red arrows to signify that you must stop before turning on red.

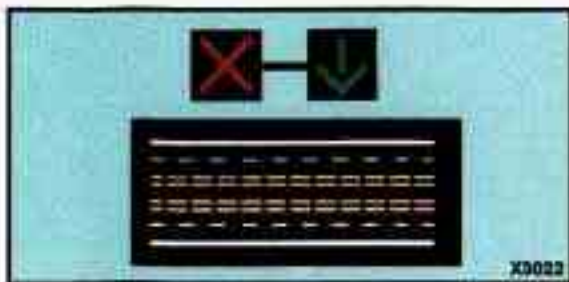

REVERSIBLE LANE ON MULTILANE ROADWAY



NO-PASSING ZONE

Pavement Markings

Pavement markings add to traffic signs and signals. They give information to drivers without taking attention from the roadway. A solid yellow line on your side of the road or lane means **Don't Cross**.

Your Own Signals

Drivers signal to others, too. It's not only more polite, it's safer to let other drivers know what you are doing. And in some places the law requires driver signals.

Turn and Lane Change Signals:

Always signal when you plan to turn or change lanes.

If necessary, you can use hand signals out the window: Left arm straight out for a left turn, down for slow or about-to-stop, and up for a right turn.

Slowing Down: If time allows, tap the brake pedal once or twice in advance of slowing or stopping. This warns the driver behind you.

Disabled: Your four-way flashers signal that your vehicle is disabled or is a hazard. See the *Index* under *Hazard Warning Flashers*.

Traffic Officer

The traffic police officer is also a source of important information. The officer's signals govern, no matter what the traffic lights or other signs say.

The next section discusses some of the road conditions you may encounter.

Many city roads and expressways, and even bridges, use reversible-lane traffic control during rush hours. A red X light above a lane means no driving in that lane at that time. A green arrow means you may drive in that lane. Look for the signs posted to warn drivers what hours and days these systems are in effect.

Your Driving and the Road

Defensive Driving

The best advice anyone can give about driving is: Drive defensively.

Please start with a very important safety device in your Pontiac: Buckle up. (See the *Index* under *Safety Belts*.)

Defensive driving really means "be ready for anything." On city streets, rural roads, or freeways, it means "always expect the unexpected."

Assume that pedestrians or other drivers are going to be careless and make mistakes. Anticipate what they might do. Be ready for their mistakes.

Expect children to dash out from behind parked cars, often followed by other children. Expect occupants in parked cars to open doors into traffic. Watch for movement in parked cars—someone may be about to open a door.

Expect other drivers to run stop signs when you are on a through street. Be ready to brake if necessary as you go through intersections. You may not have to use the brake, but if you do, you will be ready.

If you're driving through a shopping center parking lot where there are well-marked lanes, directional arrows, and designated parking areas, expect some drivers to ignore all these markings and dash straight toward one part of the lot.

Pedestrians can be careless. Watch for them. In general, you must give way to pedestrians even if you know you have the right of way.

Rear-end collisions are about the most preventable of accidents. Yet they are common. Allow enough following

distance. It's the best defensive driving maneuver, in both city and rural driving. You never know when the vehicle in front of you is going to brake or turn suddenly.

Here's a final bit of information about defensive driving. The most dangerous time for driving in the U.S. is very early on Sunday morning. In fact, GM Research studies show that the most and the least dangerous times for driving, every week, fall on the same day. That day is Sunday. The most dangerous time is Sunday from 3 a.m. to 4 a.m. The safest time is Sunday from 10 a.m. to 11 a.m. Driving the same distance on a Sunday at 3 a.m. isn't just a little more dangerous than it is at 10 a.m. It's about 134 times more dangerous!

That leads to the next section.

Drunken Driving

Death and injury associated with drinking and driving is a national tragedy. It's the number one contributor to the highway death toll, claiming thousands of victims every year. Alcohol takes away three things that anyone needs to drive a vehicle:

- Judgment
- Muscular Coordination
- Vision

Police records show that half of all motor vehicle-related deaths involve alcohol—a driver, a passenger or someone else, such as a pedestrian, had been drinking. In most cases, these deaths are the result of someone who was drinking and driving. Over 25,000 motor vehicle-related deaths occur each year because of alcohol, and thousands of people are injured.

Just how much alcohol is too much if a person plans to drive? Ideally, no one should drink alcohol and then drive. But if one does, then what's "too much" can be a lot less than many might think. Although it depends on each person and situation, here is some general information on the problem.

The Blood Alcohol Content (BAC) of someone who is drinking depends upon four things:

- How much alcohol is in the drink.
- The drinker's body weight.
- The amount of food that is consumed before and during drinking.
- The length of time it has taken the drinker to consume the alcohol.



According to the American Medical Association, a 180-pound (82 kg) person who drinks three 12-ounce (355 ml) bottles of beer in an hour will end up with a BAC of about 0.06 percent. The person would reach the same BAC by drinking three 4-ounce (120 ml) glasses of wine or three mixed drinks if each had 1½ ounces (45 ml) of a liquor like whiskey, gin or vodka.

It's the amount of alcohol that counts. For example, if the same person drank three double martinis (3 ounces or 90 ml of liquor each) within an hour, the person's BAC would be close to 0.12 percent. A person who consumes food just before or during drinking will have a slightly lower BAC level.

Your Driving and the Road

Drinking that Will Result in a BAC of .05% in the Time Shown

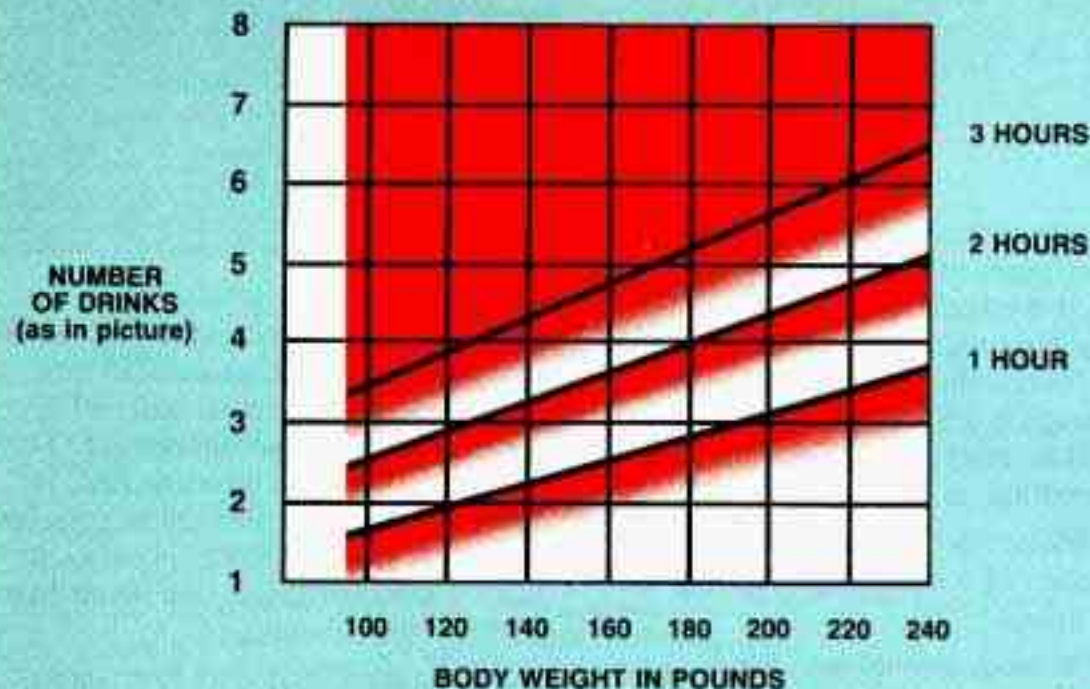

Drunken Driving (CONT.)

The law in most U.S. states sets the legal limit at a BAC of 0.10 percent. In Canada the limit is 0.08 percent, and in some other countries it's lower than that. The BAC will be over 0.10 percent after three to six drinks (in one hour).

Of course, as we've seen, it depends on how much alcohol is in the drinks, and how quickly the person drinks them.

But it's very important to keep in mind that the ability to drive is affected well below a BAC of 0.10 percent. Research shows that the driving skills of many

people are impaired at a BAC approaching 0.05 percent, and that the effects are worse at night. All drivers are impaired at BAC levels above 0.05 percent. Statistics show that the chance of being in an accident increases sharply for drivers who have a BAC of 0.05 percent or above. A driver with a BAC level of 0.06 percent (three beers in one hour for a 180-pound or 82 kg person) has doubled his or her chance of having an accident. At a BAC level of 0.10 percent, the chance of that driver having an accident is six times greater; at a level of 0.15 percent, the chances are twenty-five times greater! And, the body takes about an hour to rid itself of the alcohol in one drink. No amount of coffee or number of cold showers will speed that up.

"I'll be careful" isn't the right answer. What if there's an emergency, a need to take sudden action, as when a child darts into the street? A person with a higher BAC might not be able to react quickly enough to avoid the collision. There's something else about drinking and driving that many people don't know. Medical research shows that alcohol in a person's system can make crash injuries worse. That's especially true for brain, spinal cord and heart injuries. That means that if anyone who has been drinking—driver or passenger—is in a crash, the chance of being killed or permanently disabled is higher than if that person had not been drinking. And we've already seen that

the chance of a crash itself is higher for drinking drivers.

CAUTION



Drinking and then driving is very dangerous. Your reflexes, perceptions, and judgment will be affected by even a small amount of alcohol. You could have a serious—or even fatal—accident if you drive after drinking. Please don't drink and drive or ride with a driver who has been drinking. Ride home in a cab; or if you're with a group, designate a driver who will not drink.

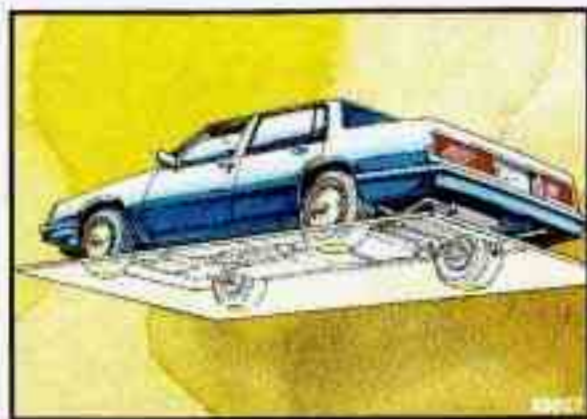

■ *Control of a Vehicle*

You have three systems that make your vehicle go where you want it to go. They are the brakes, the steering and the accelerator. All three systems have to do their work at the places where the tires meet the road.

Sometimes, as when you're driving on snow or ice, it's easy to ask more of those control systems than the tires and road can provide. That means you can lose control of your vehicle.

Your Driving and the Road

Braking

Braking action involves **perception time** and **reaction time**.

First, you have to decide to push on the brake pedal. That's **perception time**. Then you have to bring up your foot and do it. That's **reaction time**.

Average **reaction time** is about $\frac{3}{4}$ of a second. But that's only an average. It might be less with one driver and as long as two or three seconds or more with another. Age, physical condition, alertness, coordination, and eyesight all play a part. So do alcohol, drugs and frustration. But even in $\frac{3}{4}$ of a second, a vehicle moving at 60 mph (100 km/h) travels 66 feet (20 m). That could be a lot of distance in an emergency, so keeping enough space between your vehicle and others is important.

And, of course, actual stopping distances vary greatly with the surface of the road (whether it's pavement or gravel); the condition of the road (wet, dry, icy); tire tread; and the condition of your brakes.

Most drivers treat their brakes with care. Some, however, overwork the braking system with poor driving habits.

- Avoid needless heavy braking. Some people drive in spurts—heavy acceleration followed by heavy braking—rather than keeping pace with traffic. This is a mistake. Your brakes may not have time to cool between hard stops. Your brakes will wear out much faster if you do a lot of heavy braking.



- Don't "ride" the brakes by letting your left foot rest lightly on the brake pedal while driving.

CAUTION



"Riding" your brakes can cause them to overheat to the point that they won't work well. You might not be able to stop your vehicle in time to avoid an accident. If you "ride" your brakes, they will get so hot they will require a lot of pedal force to slow you down. Avoid "riding" the brakes.

NOTICE

“Riding” the brakes wears them out much faster. You would need costly brake replacement much sooner than normal, and it also reduces fuel economy.

If you keep pace with the traffic and allow realistic following distances, you will eliminate a lot of unnecessary braking. That means better braking and longer brake life.

- If your engine ever stops while you're driving, brake normally but don't pump your brakes. If you do, the pedal may get harder to push down. If your engine stops, you will still have some power brake assist. But you will use it when you brake. Once the power assist is used up, it may take longer to stop and the brake pedal will be harder to push.

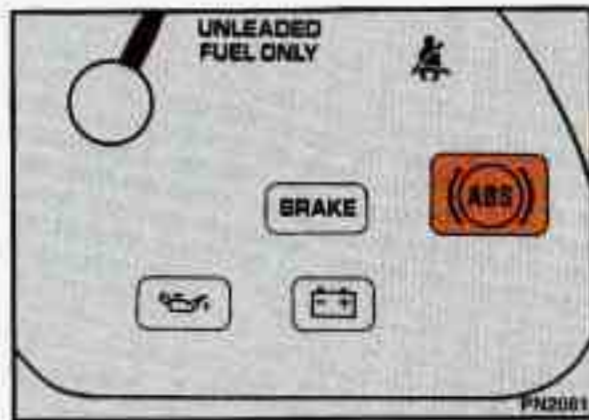

Anti-Lock Brakes (ABS)

Your Pontiac has an advanced electronic braking system that will help prevent skidding.

This light on the instrument panel will go on when you start your vehicle.

When you start your vehicle and begin to drive away you may hear a momentary motor or clicking noise and you may even notice that your brake pedal moves a little while this is going on. This is the ABS system testing itself. If you have your foot on the brake pedal, this check won't happen until the vehicle goes about 4 mph (6 km/h) or until you take your foot off the brake pedal.

Your Driving and the Road



Anti-Lock Brakes (CONT.)

After an ABS stop, you may also hear a clicking noise the next time the vehicle reaches about 4 mph (6 km/h).

If there's a problem with the anti-lock brake system, the anti-lock brake system warning light will stay on or flash.

See the *Index* under *Anti-Lock Brake System Warning Light*.



Here's how anti-lock works. Let's say the road is wet. You're driving safely. Suddenly an animal jumps out in front of you.

You slam on the brakes. Here's what happens with ABS.

A computer senses that wheels are slowing down. The computer separately works the brakes at each front wheel and at the rear wheels.

The anti-lock system can change the brake pressure faster than any driver could. The computer is programmed to make the most of available tire and road conditions.



You can steer around the obstacle while braking hard. As you brake, your computer keeps receiving updates on wheel speed and controls braking pressure accordingly.

CAUTION



Anti-lock doesn't change the time you need to get your foot up to the brake pedal. If you get too close to the vehicle in front of you, you won't have time to apply your brakes if that vehicle suddenly slows or stops. Always leave enough room up ahead to stop, even though you have anti-lock brakes.

To Use Anti-Lock:

Don't pump the brakes. Just hold the brake pedal down and let anti-lock work for you. You may hear a clicking noise as you accelerate after a hard stop.

Disc Brake Wear Indicators

Your Pontiac has front disc brakes and rear drum brakes. Disc brake pads have built-in wear indicators that make a high-pitched warning sound when the brake pads are worn and new pads are needed. The sound may come and go or be heard all the time your vehicle is moving (except when you are pushing on the brake pedal firmly).

CAUTION



The brake wear warning sound means that sooner or later your brakes won't work well. That could lead to an accident. When you hear the brake wear warning sound, have your vehicle serviced.

Your Driving and the Road

Disc Brake Wear Indicators (CONT.)

NOTICE

Continuing to drive with worn-out brake pads could result in costly brake repair.

Some driving conditions or climates may cause a brake squeal when the brakes are first applied or lightly applied. This does not mean something is wrong with your brakes.

Rear Drum Brakes

Your rear drum brakes don't have wear indicators, but if you ever hear a rear brake rubbing noise, have the rear brake linings inspected. When you have the front brakes replaced, have the rear brakes inspected, too.

Brake linings should always be replaced as complete axle sets.

Brake Pedal Travel

See your dealer if the brake pedal does not return to normal height, or if there is a rapid increase in pedal travel. This could be a sign of brake trouble.

Brake Adjustment

Every time you make a moderate reverse brake stop, your brakes adjust for wear. If you rarely make a moderate or heavier stop, then your brakes might not adjust correctly. If you drive in that way, then—very carefully—make a few moderate brake stops about every 1,000 miles (1,600 km), so your brakes will adjust properly.

If your brake pedal goes down farther than normal, your rear drum brakes may need adjustment. Adjust them by backing up and firmly applying the brakes a few times.

Braking In Emergencies

Use your anti-lock braking system when you need to. With anti-lock, you can steer and brake at the same time. In many emergencies, steering can help you more than even the very best braking.

Power Steering

If you lose power steering assist because the engine stops or the system fails to function, you can steer but it will take much more effort.

Your Driving and the Road

Variable Effort Steering (OPTION)

This steering system provides lighter steering effort for parking and at low vehicle speeds. Steering effort will increase at higher speeds for improved road feel.

Steering Tips—Driving on Curves

It's important to take curves at a reasonable speed.

A lot of the "driver lost control" accidents mentioned on the news happen on curves. Here's why:

Experienced driver or beginner, each of us is subject to the same laws of physics when driving on curves. The traction of the tires against the road surface makes it possible for the vehicle to change its path when you turn the front wheels. If there's no traction, inertia will keep the vehicle going in the same direction. If you've ever tried to steer a vehicle on wet ice, you'll understand this.

The traction you can get in a curve depends on the condition of your tires and the road surface, the angle at which the curve is banked, and your speed. While you're in a curve, speed is the one factor you can control.

Suppose you're steering through a sharp curve. Then you suddenly accelerate. Those two control systems—steering and acceleration—can overwhelm those places where the tires meet the road and make you lose control.

What should you do if this ever happens? Let up on the accelerator pedal, steer the vehicle the way you want it to go, and slow down.



Steering in Emergencies

There are times when steering can be more effective than braking. For example, you come over a hill and find a truck stopped in your lane, or a car suddenly pulls out from nowhere, or a child darts out from between parked cars and stops right in front of you. You can avoid these problems by braking—if you can stop in time. But sometimes you can't; there isn't room. That's the time for evasive action—steering around the problem.

Your Pontiac can perform very well in emergencies like these. First apply your brakes. It is better to remove as much speed as you can from a possible collision. Then steer around the problem, to the left or right depending on the space available.

An emergency like this requires close attention and a quick decision. If you are holding the steering wheel at the recommended 9 and 3 o'clock positions, you can turn it a full 180 degrees very quickly without removing either hand. But you have to act fast, steer quickly, and just as quickly straighten the wheel once you have avoided the object. You must then be prepared to steer back to your original lane and then brake to a controlled stop.

Depending on your speed, this can be rather violent for an unprepared driver. This is one of the reasons driving experts recommend that you use your safety belts and keep both hands on the steering wheel.

The fact that such emergency situations are always possible is a good reason to practice defensive driving at all times.

Speed limit signs near curves warn that you should adjust your speed. Of course, the posted speeds are based on good weather and road conditions. Under less favorable conditions you'll want to go slower.

If you need to reduce your speed as you approach a curve, do it before you enter the curve, while your front wheels are straight ahead.

Try to adjust your speed so you can "drive" through the curve. Maintain a reasonable, steady speed. Wait to accelerate until you are out of the curve, and then accelerate gently into the straightaway.

When you drive into a curve at night, it's harder to see the road ahead of you because it bends away from the straight beams of your lights. This is one good reason to drive slower.

Your Driving and the Road



Off-Road Recovery

You may find sometime that your right wheels have dropped off the edge of a road onto the shoulder while you're driving.

If the level of the shoulder is only slightly below the pavement, recovery should be fairly easy. Ease off the accelerator and then, if there is nothing in the way, steer so that your vehicle straddles the edge of the pavement. You can turn the steering wheel up to $\frac{1}{4}$ turn until the right front tire contacts the pavement edge. Then turn your steering wheel to go straight down the roadway.

If the shoulder appears to be about four inches (100 mm) or more below the pavement, this difference can cause problems. If there is not enough room to

pull entirely onto the shoulder and stop, then follow the same procedures. But if the right front tire scrubs against the side of the pavement, do **not** steer more sharply. With too much steering angle, the vehicle may jump back onto the road with so much steering input that it crosses over into the oncoming traffic before you can bring it back under control. Instead, ease off again on the accelerator and steering input, straddle the pavement once more, then try again.

Passing

The driver of a vehicle about to pass another on a two-lane highway waits for just the right moment, accelerates, moves around the vehicle ahead, then goes back into the right lane again. A simple maneuver?

Not necessarily! Passing another vehicle on a two-lane highway is a potentially dangerous move, since the passing vehicle occupies the same lane as oncoming traffic for several seconds. A miscalculation, an error in judgment, or a brief surrender to frustration or anger can suddenly put the passing driver face to face with the worst of all traffic accidents—the head-on collision.

So here are some tips for passing:

- "Drive ahead." Look down the road, to the sides, and to crossroads for situations that might affect your passing patterns. If you have any doubt whatsoever about making a successful pass, wait for a better time.
- Watch for traffic signs, pavement markings, and lines. If you can see a sign up ahead that might indicate a turn or an intersection, delay your pass. A broken center line usually indicates it's all right to pass (providing the road ahead is clear). Never cross a solid line on your side of the lane or a double solid line, even if the road seems empty of approaching traffic.

- If you suspect that the driver of the vehicle you want to pass isn't aware of your presence, tap the horn a couple of times before passing. Or, you can use flash-to-pass. See the *Index* under *Flash-to-Pass*.
- Do not get too close to the vehicle you want to pass while you're awaiting an opportunity. For one thing, following too closely reduces your area of vision, especially if you're following a larger vehicle. Also, you won't have adequate space if the vehicle ahead suddenly slows or stops. Keep back a reasonable distance.

- When it looks like a chance to pass is coming up, start to accelerate but stay in the right lane and don't get too close. Time your move so you will be increasing speed as the time comes to move into the other lane. If the way is clear to pass, you will have a "running start" that more than makes up for the distance you would lose by dropping back. And if something happens to cause you to cancel your pass, you need only slow down and drop back again and wait for another opportunity.
- If other cars are lined up to pass a slow vehicle, wait your turn. But take care that someone isn't trying to pass you as you pull out to pass the slow vehicle. Remember to glance over your shoulder and check the blind spot.

Your Driving and the Road

Passing (CONT.)

- Check your mirrors, glance over your shoulder, and start your left lane change signal before moving out of the right lane to pass. When you are far enough ahead of the passed vehicle to see its front in your inside mirror, activate your right lane change signal and move back into the right lane. (Remember that your right outside mirror is convex. The vehicle you just passed may seem to be farther away from you than it really is.)

- Try not to pass more than one vehicle at a time on two-lane roads. Reconsider before passing the next vehicle.
- Don't overtake a slowly moving vehicle too rapidly. Even though the brake lights are not flashing, it may be slowing down or starting to turn.
- If you're being passed, make it easy for the following driver to get ahead of you. Perhaps you can ease a little to the right.

Loss of Control

Let's review what driving experts say about what happens when the three control systems (brakes, steering and acceleration) don't have enough friction where the tires meet the road to do what the driver has asked.

In any emergency, don't give up. Keep trying to steer and constantly seek an escape route or area of less danger.

Skidding

In a skid, a driver can lose control of the vehicle. Defensive drivers avoid most skids by taking reasonable care suited to existing conditions, and by not "overdriving" those conditions. But skids are always possible.

The three types of skids correspond to your Pontiac's three control systems. In the braking skid your wheels aren't rolling. In the steering or cornering skid, too much speed or steering in a curve causes tires to slip and lose cornering force. And in the acceleration skid too much throttle causes the driving wheels to spin.

A cornering skid and an acceleration skid are best handled by easing your foot off the accelerator pedal. If your vehicle starts to slide (as when you turn a corner on a wet, snow- or ice-covered road), ease your foot off the accelerator pedal as soon as you feel the vehicle start to slide. Quickly steer the way you want the vehicle to go. If you start steering quickly enough, your vehicle will straighten out. As it does, straighten the front wheels.

Of course, traction is reduced when water, snow, ice, gravel, or other material is on the road. For safety, you'll want to slow down and adjust your driving to these conditions. It is important to slow down on slippery surfaces because stopping distance will be longer and vehicle control more limited.

While driving on a surface with reduced traction, try your best to avoid sudden steering, acceleration, or braking (including engine braking by shifting to a lower gear). Any sudden change could cause the tires to slide. You may not realize the surface is slippery until your vehicle is skidding. Learn to recognize warning clues—such as enough water, ice or packed snow on the road to make a "mirrored surface"—and slow down when you have any doubt.

Remember: Any anti-lock braking system (ABS) helps avoid only the braking skid.

Your Driving and the Road



Driving at Night

Night driving is more dangerous than day driving. One reason is that some drivers are likely to be impaired—by alcohol or drugs, with night vision problems, or by fatigue.

Here are some tips on night driving.

- Drive defensively. Remember, this is the most dangerous time.
- Don't drink and drive. (See the *Index* under *Drunken Driving* for more on this problem.)
- Adjust your inside rearview mirror to reduce the glare from headlights behind you.

- Since you can't see as well, you may need to slow down and keep more space between you and other vehicles. It's hard to tell how fast the vehicle ahead is going just by looking at its taillights.
- Slow down, especially on higher speed roads. Your headlights can light up only so much road ahead.
- In remote areas, watch for animals.
- If you're tired, pull off the road in a safe place and rest.

Night Vision

No one can see as well at night as in the daytime. But as we get older these differences increase. A 50-year-old driver may require at least twice as much light to see the same thing at night as a 20-year-old.

What you do in the daytime can also affect your night vision. For example, if you spend the day in bright sunshine you are wise to wear sunglasses. Your eyes will have less trouble adjusting to night.

But if you're driving, don't wear sunglasses at night. They may cut down on glare from headlights, but they also make a lot of things invisible that should remain visible—such as parked cars, obstacles, pedestrians, or even trains blocking railway crossings. You may want to put on your sunglasses after you have pulled into a brightly-lighted service or refreshment area. Eyes

shielded from that glare may adjust more quickly to darkness back on the road. But be sure to remove your sunglasses before you leave the service area.

You can be temporarily blinded by approaching lights. It can take a second or two, or even several seconds, for your eyes to readjust to the dark. When you are faced with severe glare (as from a driver who doesn't lower the high beams, or a vehicle with misaimed headlights), slow down a little. Avoid staring directly into the approaching lights. If there is a line of opposing traffic, make occasional glances over the line of headlights to make certain that one of the vehicles isn't starting to move into your lane. Once you are past the bright lights, give your eyes time to readjust before resuming speed.

High Beams

If the vehicle approaching you has its high beams on, signal by flicking yours to high and then back to low beam. This is the usual signal to lower the headlight beams. If the other driver still doesn't lower the beams, resist the temptation to put your high beams on. This only makes two half-blinded drivers.

On a freeway, use your high beams only in remote areas where you won't impair approaching drivers. In some places, like cities, using high beams is illegal.

When you follow another vehicle on a freeway or highway, use low beams. True, most vehicles now have day-night mirrors that enable the driver to reduce glare. But outside mirrors are not of this type and high beams from behind can bother the driver ahead.

A Few More Night Driving Suggestions

Keep your windshield and all the glass on your vehicle clean—inside and out. Glare at night is made much worse by dirt on the glass. Even the inside of the glass can build up a film caused by dust. Tobacco smoke also makes inside glass surfaces very filmy and can be a vision hazard if it's left there.

Dirty glass makes lights dazzle and flash more than clean glass would, making the pupils of your eyes contract repeatedly. You might even want to keep a cloth and some glass cleaner in your vehicle if you need to clean your glass frequently.

Your Driving and the Road



A Few More Night Driving Suggestions (CONT.)

Remember that your headlights light up far less of a roadway when you are in a turn or curve.

Keep your eyes moving; that way, it's easier to pick out dimly lighted objects.

Just as your headlights should be checked regularly for proper aim, so should your eyes be examined regularly. Some drivers suffer from night blindness—the inability to see in dim light—and aren't even aware of it.

Driving in the Rain

Rain and wet roads can mean driving trouble. On a wet road you can't stop, accelerate or turn as well because your tire-to-road traction isn't as good as on dry roads. And, if your tires don't have much tread left, you'll get even less traction.

It's always wise to go slower and be cautious if rain starts to fall while you are driving. The surface may get wet suddenly when your reflexes are tuned for driving on dry pavement.

The heavier the rain, the harder it is to see. Even if your windshield wiper

blades are in good shape, a heavy rain can make it harder to see road signs and traffic signals, pavement markings, the edge of the road, and even people walking. Road spray can often be worse for vision than rain, especially if it comes from a dirty road.

So it is wise to keep your wiping equipment in good shape and keep your windshield washer tank filled. Replace your windshield wiper inserts when they show signs of streaking or missing areas on the windshield, or when strips of rubber start to separate from the inserts.



Driving too fast through large water puddles or even going through some vehicle washes can cause problems, too. The water may affect your brakes. Try to avoid puddles. But if you can't, try to slow down before you hit them.

CAUTION



Wet brakes can cause accidents. They won't work well in a quick stop and may cause pulling to one side. You could lose control of the vehicle.

After driving through a large puddle of water or a vehicle wash, apply your brake pedal lightly until your brakes work normally.

Hydroplaning

Hydroplaning is dangerous. So much water can build up under your tires that they can actually ride on the water. This can happen if the road is wet enough and you're going fast enough. When your vehicle is hydroplaning, it has little or no contact with the road.

You might not be aware of hydroplaning. You could drive along for some time without realizing your tires aren't in constant contact with the road. You could find out the hard way: when you have to slow, turn, move out to pass—or if you get hit by a gust of wind. You could suddenly find yourself out of control.

Hydroplaning doesn't happen often. But it can if your tires haven't much tread or if the pressure in one or more is low. It can happen if a lot of water is standing on the road. If you can see reflections from trees, telephone poles, or other vehicles, and raindrops "dimple" the water's surface, there could be hydroplaning.

Hydroplaning usually happens at higher speeds. There just isn't a hard and fast rule about hydroplaning. The best advice is to slow down when it is raining, and be careful.

Your Driving and the Road

Some Other Rainy Weather Tips

- Turn on your headlights—not just your parking lights—to help make you more visible to others.
- Look for hard-to-see vehicles coming from behind. You may want to use your headlights even in daytime if it's raining hard.
- Besides slowing down, allow some extra following distance. And be especially careful when you pass another vehicle. Allow yourself more clear room ahead, and be prepared to have your view restricted by road spray. If the road spray is so heavy you are actually blinded, drop back. Don't pass until conditions improve. Going more slowly is better than having an accident.
- Use your defogger if it helps.
- Have good tires with proper tread depth. (See the *Index* under *Tires*.)



Driving in Fog, Mist and Haze

Fog can occur with high humidity or heavy frost. It can be so mild that you can see through it for several hundred feet (meters). Or it might be so thick that you can see only a few feet (meters) ahead. It may come suddenly to an otherwise clear road. And it can be a major hazard.

When you drive into a fog patch, your visibility will be reduced quickly. The biggest dangers are striking the vehicle ahead or being struck by the one behind. Try to "read" the fog density down the road. If the vehicle ahead starts to become less clear or, at night, if the taillights are harder to see, the fog is probably thickening. Slow down to give traffic behind you a chance to slow down.

Everybody then has a better chance to avoid hitting the vehicle ahead.

A patch of dense fog may extend only for a few feet (meters) or for miles (kilometers); you can't really tell while you're in it. You can only treat the situation with extreme care.

One common fog condition—sometimes called mist or ground fog—can happen in weather that seems perfect, especially at night or in the early morning in valley and low, marshy areas. You can be suddenly enveloped in thick, wet haze that may even coat your windshield. You can often spot these fog patches or mist layers with your headlights. But sometimes they can be waiting for you as you come over a hill or dip into a shallow valley. Start your windshield wipers and washer to help clear accumulated road dirt. Slow down carefully.



Tips on Driving in Fog

If you get caught in fog, turn your headlights on low beam, even in daytime. You'll see—and be seen—better. Use your fog lights.

Don't use your high beams. The light will bounce off the water droplets that make up fog and reflect back at you.

Use your defogger. In high humidity, even a light build-up of moisture on the inside of the glass will cut down on your already limited visibility. Run your windshield wipers and washer occasionally. Moisture can build up on the outside glass, and what seems to be fog may actually be moisture on the outside of your windshield.

Treat dense fog as an emergency. Try to find a place to pull off the road. Of

course you want to respect another's property, but you might need to put something between you and moving vehicles—space, trees, telephone poles, a private driveway, anything that removes you from other traffic.

If visibility is near zero and you must stop but are unsure whether you are away from the road, turn your lights on, start your hazard warning flashers, and sound your horn at intervals or when you hear approaching traffic.

Pass other vehicles in fog only if you can see far enough ahead to pass safely. Even then, be prepared to delay your pass if you suspect the fog is worse up ahead. If other vehicles try to pass you, make it easy for them.

City Driving

One of the biggest problems with city streets is the amount of traffic on them. You'll want to watch out for what the other drivers are doing and pay attention to traffic signals.

Here are ways to increase your safety in city driving:

- Know the best way to get to where you are going. Try not to drive around trying to pick out a familiar street or landmark. Get a city map and plan your trip into an unknown part of the city just as you would for a cross-country trip.
- Try to use the freeways that rim and crisscross most large cities. You'll save time and energy. (See the next section, *Freeway Driving*.)

Your Driving and the Road



City Driving (CONT.)

- Treat a green light as a warning signal. A traffic light is there because the corner is busy enough to need it. When a light turns green, and just before you start to move, check both ways for vehicles that have not cleared the intersection or may be running the red light.
- Obey all posted speed limits. But remember that they are for ideal road, weather and visibility conditions. You may need to drive below the posted limit in bad weather or when visibility is especially poor.
- Pull to the right (with care) and stop clear of intersections when you see or hear emergency vehicles.

Freeway Driving

Mile for mile, freeways (also called thruways, parkways, expressways, turnpikes, or superhighways) are the safest of all roads. But they have their own special rules.

The most important advice on freeway driving is: Keep up with traffic and keep to the right. Drive at the same speed most of the other drivers are driving. Too-fast or too-slow driving breaks a smooth traffic flow. Treat the left lane on a freeway as a passing lane.

Entering the Freeway

At the entrance there is usually a ramp that leads to the freeway. If you have a clear view of the freeway as you drive along the entrance ramp, you should begin to check traffic. Try to determine where you expect to blend with the flow. If traffic is light, you may have no problem. But if it is heavy, find a gap as you move along the entering lane and time your approach. Try to merge into the gap at close to the prevailing speed. Switch on your turn signal, check your rearview mirrors as you move along, and glance over your shoulder as often as necessary. Try to blend smoothly with the traffic flow.

Driving on the Freeway

Once you are on the freeway, adjust your speed to the posted limit or to the prevailing rate if it's slower. Stay in the right lane unless you want to pass. If you are on a two-lane freeway, treat the right lane as the slow lane and the left lane as the passing lane.

If you are on a three-lane freeway, treat the right lane as the slower-speed through lane, the middle lane as the higher-speed through lane, and the left lane as the passing lane.

Before changing lanes, check your rearview mirrors. Then use your turn signal. Just before you leave the lane, glance quickly over your shoulder to make sure there isn't another vehicle in your "blind" spot.

If you are moving from an outside to a center lane on a freeway having more than two lanes, make sure another vehicle isn't about to move into the same spot. Look at the vehicles two lanes over and watch for telltale signs: turn signals flashing, an increase in speed, or moving toward the edge of the lane. Be prepared to delay your move.

Once you are moving on the freeway, make certain you allow a reasonable following distance. Expect to move slightly slower at night.

Leaving the Freeway

When you want to leave the freeway, move to the proper lane well in advance. Dashing across lanes at the last minute is dangerous. If you miss your exit do not, under any circumstances, stop and back up. Drive on to the next exit.

At each exit point is a deceleration lane. Ideally it should be long enough for you to enter it at freeway speed (after signaling, of course) and then do your braking before moving onto the exit ramp. Unfortunately, not all deceleration lanes are long enough—some are too short for all the braking. Decide when to start braking. If you must brake on the through lane, and if there is traffic close behind you, you can allow a little

Your Driving and the Road

Leaving the Freeway (CONT.)

extra time and flash your brake lights (in addition to your turn signal) as extra warning that you are about to slow down and exit.

The exit ramp can be curved, sometimes quite sharply. The exit speed is usually posted. Reduce your speed according to your speedometer, not to your sense of motion. After driving for any distance at higher speeds, you may tend to think you are going slower than you actually are. For example, 40 mph (65 km/h) might seem like only 20 mph (32 km/h). Obviously, this could lead to serious trouble on a ramp designed for 20 mph (32 km/h)!

Driving a Long Distance

Although most long trips today are made on freeways, there are still many made on regular highways.

Long-distance driving on freeways and regular highways is the same in some ways. The trip has to be planned and the vehicle prepared, you drive at higher-than-city speeds, and there are longer turns behind the wheel. You'll enjoy your trip more if you and your vehicle are in good shape. Here are some tips for a successful long trip.

Before Leaving on a Long Trip

Make sure you're ready. Try to be well rested. If you must start when you're not fresh—such as after a day's work—don't plan to make too many miles that first part of the journey. Wear comfortable clothing and shoes you can easily drive in.

Is your vehicle ready for a long trip? If you keep it serviced and maintained, it's ready to go. If it needs service, have it done before starting out. Of course, you'll find experienced and able service experts in Pontiac dealerships all across North America. They'll be ready and willing to help if you need it.

Here are some things you can check before a trip:

- **Windshield Washer Fluid:** Is the reservoir full? Are all windows clean inside and outside?
- **Wiper Blades:** Are they in good shape?
- **Fuel, Engine Oil, Other Fluids:** Have you checked all levels?
- **Lights:** Are they all working? Are the lenses clean?
- **Tires:** They are vitally important to a safe, trouble-free trip. Is the tread good enough for long-distance driving? Are the tires all inflated to the recommended pressure?
- **Weather Forecasts:** What's the weather outlook along your route? Should you delay your trip a short time to avoid a major storm system?
- **Maps:** Do you have up-to-date maps?

On the Road

Unless you are the only driver, it is good to share the driving task with others. Limit turns behind the wheel to about 100 miles (160 km) or two hours at a sitting. Then, either change drivers or stop for some refreshment like coffee, tea or soft drinks and some limbering up. But do stop and move around. Eat lightly along the way. Heavier meals tend to make some people sleepy.

On two-lane highways or undivided multilane highways that do not have controlled access, you'll want to watch for some situations not usually found on freeways. Examples are: stop signs and signals, shopping centers with direct access to the highway, no passing zones and school zones, vehicles turning left and right off the road, pedestrians, cyclists, parked vehicles, and even animals.

Highway Hypnosis

Is there actually such a condition as "highway hypnosis"? Or is it just plain falling asleep at the wheel? Call it highway hypnosis, lack of awareness, or whatever.

There is something about an easy stretch of road with the same scenery, along with the hum of the tires on the road, the drone of the engine, and the rush of the wind against the vehicle that can make you sleepy. Don't let it happen to you! If it does, your vehicle can leave the road in **less than a second**, and you could crash and be injured.

What can you do about highway hypnosis? First, be aware that it can happen.

Then here are some tips:

- Make sure your vehicle is well ventilated, with a comfortably cool interior.

Your Driving and the Road

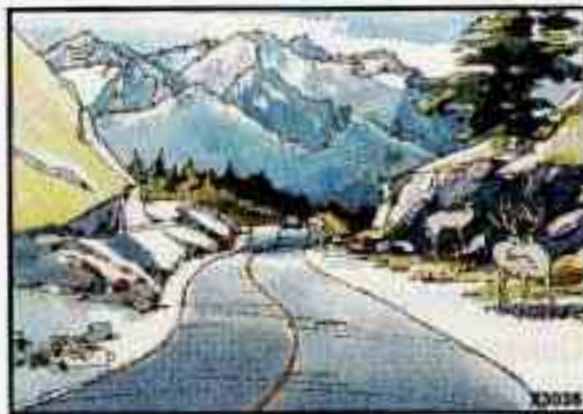

Highway Hypnosis (CONT.)

- Keep your eyes moving. Scan the road ahead and to the sides. Check your rearview mirrors frequently and your instruments from time to time. This can help you avoid a fixed stare.
- Wear good sunglasses in bright light. Glare can cause drowsiness. But don't wear sunglasses at night. They will drastically reduce your overall vision at the very time you need all the seeing power you have.
- If you get sleepy, pull off the road into a rest, service, or parking area and take a nap, get some exercise, or both. For safety, treat drowsiness on the highway as an emergency.

As in any driving situation, keep pace with traffic and allow adequate following distances.

Hill and Mountain Roads

Driving on steep hills or mountains is different from driving in flat or rolling terrain. If you drive regularly in steep country, or if you're planning to visit there, here are some tips that can make your trips safer and more enjoyable.

- Keep your vehicle in good shape. Check all fluid levels and also the brakes, tires, cooling system and transaxle. These parts can work hard on mountain roads.
- Know how to go down hills. The most important thing to know is this: let your engine do some of the slowing down. Don't make your brakes do it all. Shift to a lower gear when you go down a steep or long hill. That way, you will slow down without excessive use of your brakes.

CAUTION



If you don't shift down, your brakes could get so hot that they wouldn't work well. You would then have poor braking or even none going down a hill. You could crash. Shift down to let your engine assist your brakes on a steep downhill slope.

CAUTION



Coasting downhill in N (Neutral) or with the ignition off is dangerous. Your brakes will have to do all the work of slowing down. They could get so hot that they wouldn't work well. You could crash. Always have your engine running and your vehicle in gear when you go downhill.

- Know how to go uphill. Drive in the highest gear possible.
- Stay in your own lane when driving on two-lane roads in hills or mountains. Don't swing wide or cut across the center of the road. Drive at speeds that let you stay in your own lane. That way, you won't be surprised by a vehicle coming toward you in the same lane.
- It takes longer to pass another vehicle when you're going uphill. You'll want to leave extra room to pass. If a vehicle is passing you and doesn't have enough room, slow down to make it easier for the other vehicle to get by.
- As you go over the top of a hill, be alert. There could be something in your lane, like a stalled car or an accident.
- You may see highway signs on mountains that warn of special problems. Examples are long grades, passing or no passing zones, a falling rocks area, or winding roads. Be alert to these and take appropriate action.
- Winter driving can present special problems. See the *Index* under *Winter Driving*.

Your Driving and the Road



Parking on Hills

Hills and mountains mean spectacular scenery. But please be careful where you stop if you decide to look at the view or take pictures. Look for pull-offs or parking areas provided for scenic viewing.

Another part of this manual tells how to use your parking brake (see the *Index* under *Parking Brake*). But on a mountain or steep hill, you can do one more thing. You can turn your front wheels to keep your vehicle from rolling downhill or out into traffic.

Here's how:



Parking Downhill

Turn your wheels to the right.

You don't have to jam your tires against the curb, if there is a curb. A gentle contact is all you need.



Parking Uphill

If there is a curb, turn your wheels to the left if the curb is at the right side of your vehicle.



If you're going uphill on a one-way street and you're parking on the left side, your wheels should point to the right.



If there is no curb when you're parking uphill, turn the wheels to the right.

If there is no curb when you're parking uphill on the left side of a one-way street, your wheels should be turned to the left.

Torque Lock (AUTOMATIC TRANSAXLE)

If you are parking on a hill and you don't shift your transaxle into **P** (Park) properly, the weight of the vehicle may put too much force on the parking pawl in the transaxle. You may find it difficult to pull the shift lever out of **P** (Park). This is called "torque lock." To prevent torque lock, always be sure to shift into **P** (Park) properly before you leave the driver's seat. To find out how, see the *Index* under *Shifting Into P (Park)*.

When you are ready to drive, move the shift lever out of **P** (Park) **before** you release the parking brake.

If torque lock does occur, you may need to have another vehicle push yours a little uphill to take some of the pressure from the transaxle, so you can pull the shift lever out of **P** (Park).

Your Driving and the Road



Winter Driving

Here are some tips for winter driving:

- Have your Pontiac in good shape for winter. Be sure your engine coolant mix is correct.
- Snow tires can help in loose snow, but they may give you less traction on ice than regular tires. If you do not expect to be driving in deep snow, but may have to travel over ice, you may not want to switch to snow tires at all.



- You may want to put winter emergency supplies in your trunk. Include an ice scraper, a small brush or broom, a supply of windshield washer fluid, a rag, some winter outer clothing, a small shovel, a flashlight, a red cloth, and a couple of reflective warning triangles. And, if you will be driving under severe conditions, include a small bag of sand, a piece of old carpet or a couple of burlap bags to help provide traction. Be sure you properly secure these items in your vehicle.



Driving on Snow or Ice

Most of the time, those places where your tires meet the road probably have good traction.

However, if there is snow or ice between your tires and the road, you can have a very slippery situation. You'll have a lot less traction or "grip" and will need to be very careful.

What's the worst time for this? "Wet ice." Very cold snow or ice can be slick and hard to drive on. But wet ice can be even more trouble because it may offer the least traction of all. You can get wet ice when it's about freezing (32°F; 0°C) and freezing rain begins to fall. Try to avoid driving on wet ice until salt and sand crews can get there.

Whatever the condition—smooth ice, packed, blowing or loose snow—drive with caution. Accelerate gently. Try not to break the fragile traction. If you accelerate too fast, the drive wheels will spin and polish the surface under the tires even more.

Your anti-lock brakes improve your ability to make a hard stop on a slippery road. Even though you have the anti-lock braking system, you'll want to begin stopping sooner than you would on dry pavement. See the *Index* under *Anti-Lock Brake System (ABS)*.

- Allow greater following distance on any slippery road.
- Watch for slippery spots. The road might be fine until you hit a spot that's covered with ice. On an otherwise clear road, ice patches may appear in shaded areas where the sun can't reach: around clumps of trees, behind buildings, or under bridges. Sometimes the surface of a curve or an overpass may remain icy when the surrounding roads are clear. If you see a patch of ice ahead of you, brake before you are on it. Try not to brake while you're actually on the ice, and avoid sudden steering maneuvers.



If You're Caught in a Blizzard

If you are stopped by heavy snow, you could be in a serious situation. You should probably stay with your vehicle unless you know for sure that you are near help and you can hike through the snow. Here are some things to do to summon help and keep yourself and your passengers safe:

- Turn on your hazard flashers.
- Tie a red cloth to your vehicle to alert police that you've been stopped by the snow.

Your Driving and the Road



If You're Caught in a Blizzard (CONT.)

- Put on extra clothing or wrap a blanket around you. If you have no blankets or extra clothing, make body insulators from newspapers, burlap bags, rags, floor mats—anything you can wrap around yourself or tuck under your clothing to keep warm.
- You can run the engine to keep warm, but be careful.

CAUTION



Snow can trap exhaust gases under your vehicle. This can cause deadly CO (carbon monoxide) gas to get inside. CO could overcome you and kill you. You can't see it or smell it, so you might not know it was in your vehicle. Clear away snow from around the base of your vehicle, especially any that is blocking your exhaust pipe. And check around again from time to time to be sure snow doesn't collect there.

Open a window just a little on the side of the vehicle that's away from the wind. This will help keep CO out.

Run your engine only as long as you must. This saves fuel. When you run the engine, make it go a little faster than just idle. That is, push the accelerator slightly. This uses less fuel for the heat that you get and it keeps the battery charged. You will need a well-charged battery to restart the vehicle and possibly for signaling later on with your headlights. Let the heater run for a while.

Then, shut the engine off and close the window almost all the way to preserve the heat. Start the engine again and repeat this only when you feel really uncomfortable from the cold. But do it as little as possible. Preserve the fuel as long as you can.

To help keep warm, you can get out of the vehicle and do some fairly vigorous exercises every half-hour or so until help comes.

If You're Stuck in Deep Snow

This manual explains how to get the vehicle out of deep snow without damaging it. See the *Index* under *Rocking Your Vehicle*.

Towing a Trailer

CAUTION



If you don't use the correct equipment and drive properly, you can lose control when you pull a trailer. For example, if the trailer is too heavy, the brakes may not work well—or even at all. You and your passengers could be seriously injured. Pull a trailer only if you have followed all the steps in this section.

Your Driving and the Road

Towing a Trailer (CONT.)

NOTICE

Pulling a trailer improperly can damage your vehicle and result in costly repairs not covered by your warranty. To pull a trailer correctly, follow the advice in this section.

Do not tow a trailer if your vehicle is equipped with the 2.3L OHC or Quad 4 Engine (Code 3 or D).

Your vehicle can tow a trailer if it is equipped with the 2.3L High Output Quad 4 (Code A) or 3300 V6 (Code N) engine and proper trailer towing equipment. To identify what the vehicle trailering capacity is for your vehicle, you should read the information in *Weight of the Trailer* that appears later in this section. But trailering is different than just driving your vehicle by itself. Trailering means changes in handling, durability, and fuel economy. Successful, safe trailering takes correct equipment, and it has to be used properly.

That's the reason for this section. In it are many time-tested, important trailering tips and safety rules. Many of these are important for your safety and that of your passengers. So please read this section carefully before you pull a trailer.

Load-pulling components such as the engine, transaxle, wheel assemblies, and tires are forced to work harder against the drag of the added weight. The engine is required to operate at relatively higher speeds and under greater loads, generating extra heat. What's more, the trailer adds considerably to wind resistance, increasing the pulling requirements.

If You Do Decide to Pull a Trailer

If you do, here are some important points.

- There are many different laws having to do with trailering. Make sure your rig will be legal, not only where you live but also where you'll be driving. A good source for this information can be state or provincial police.
- Consider using a sway control. You can ask a hitch dealer about sway controls.
- Don't tow a trailer at all during the first 500 miles (804 km) your new vehicle is driven. Your engine, axle or other parts could be damaged.

- Then, during the first 500 miles (804 km) that you tow a trailer, don't drive over 50 mph (80 km/h) and don't make starts at full throttle. This helps your engine and other parts of your vehicle wear in at the heavier loads.
- Three important considerations have to do with weight:

Weight of the Trailer

How heavy can a trailer safely be? It should never weigh more than 1,000 pounds (450 kg).

But even that can be too heavy. It depends on how you plan to use your rig. For example, speed, altitude, road grades, outside temperature and how much your vehicle is used to pull a trailer are all important. And, it can also depend on any special equipment that you have on your vehicle.

Your Driving and the Road

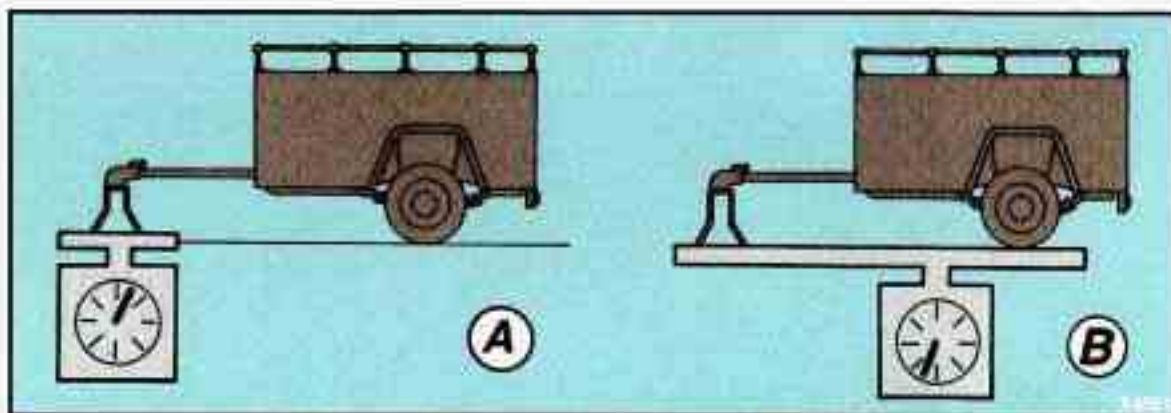

If You Do Decide to Pull a Trailer (CONT.)

You can ask your dealer for our trailering information or advice, or you can write us at:

Pontiac Customer Services
Department
One Pontiac Plaza
Pontiac, Michigan 48340-2952

In Canada, write to:

General Motors of Canada Limited
Customer Assistance Center
1908 Colonel Sam Drive
Oshawa, Ontario, L1H 8P7

Weight of the Trailer Tongue

The tongue load (A) of any trailer is an important weight to measure because it affects the total capacity weight of your vehicle. The capacity weight includes the curb weight of the vehicle, any cargo you may carry in it, and the people who will be riding in the vehicle. And if you will tow a trailer, you must subtract the tongue load from your vehicle's capacity weight because your vehicle will be carrying that weight, too. See the *Index* under *Loading Your Vehicle* for more information about your vehicle's maximum load capacity.

The trailer tongue (A) should weigh 10% of the total loaded trailer weight (B).

After you've loaded your trailer, weigh the trailer and then the tongue, separately, to see if the weights are proper. If they aren't, you may be able to get them right simply by moving some items around in the trailer.

Total Weight on Your Vehicle's Tires

Be sure your vehicle's tires are inflated to the limit for cold tires. You will find these numbers on the Certification label at the rear edge of the driver's door (or see the *Index* under *Tire Loading*). Then be sure you don't go over the GVW limit for your vehicle.

Hitches

It's important to have the correct hitch equipment. Crosswinds, large trucks going by, and rough roads are a few reasons why you'll need the right hitch. Here are some rules to follow:

- Will you have to make any holes in the body of your vehicle when you install a trailer hitch? If you do, then be sure to seal the holes later when you remove the hitch. If you don't seal them, deadly carbon monoxide (CO) from your exhaust can get into your vehicle. (See the *Index* under *Carbon Monoxide in Exhaust*.) Dirt and water can, too.
- The bumpers on your vehicle are not intended for hitches. Do not attach rental hitches or other bumper-type hitches to them.

Safety Chains

You should always attach chains between your vehicle and your trailer. Cross the safety chains under the tongue of the trailer so that the tongue will not drop to the road if it becomes separated from the hitch. Instructions about safety chains may be provided by the hitch manufacturer or by the trailer manufacturer. Follow the manufacturer's recommendation for attaching safety chains. Always leave just enough slack so you can turn with your rig. And, never allow safety chains to drag on the ground.

Trailer Brakes

Does your trailer have its own brakes?

Be sure to read and follow the instructions for the trailer brakes so you'll be able to install, adjust and maintain them properly. And because you have anti-lock brakes, do not try to tap into your vehicle's brake system. If you do, both brake systems won't work well, or at all.

Your Driving and the Road

Driving with a Trailer

Towing a trailer requires a certain amount of experience. Before setting out for the open road, you'll want to get to know your rig. Acquaint yourself with the feel of handling and braking with the added weight of the trailer. And always keep in mind that the vehicle you are driving is now a good deal longer and not nearly so responsive as your vehicle is by itself.

Before you start, check the trailer hitch and platform, safety chains, electrical connector, lights, tires and mirror adjustment. If the trailer has electric brakes, start your vehicle and trailer moving and then apply the trailer brake controller by hand to be sure the brakes are working. This lets you check your electrical connection at the same time.

During your trip, check occasionally to be sure that the load is secure, and that the lights and any trailer brakes are still working.

Following Distance

Stay at least twice as far behind the vehicle ahead as you would when driving your vehicle without a trailer. This can help you avoid situations that require heavy braking and sudden turns.

Passing

You'll need more passing distance up ahead when you're towing a trailer. And, because you're a good deal longer, you'll need to go much farther beyond the passed vehicle before you can return to your lane.

Backing Up

Hold the bottom of the steering wheel with one hand. Then, to move the trailer to the left, just move that hand to the left. To move the trailer to the right, move your hand to the right. Always back up slowly and, if possible, have someone guide you.

Making Turns

When you're turning with a trailer, make wider turns than normal. Do this so your trailer won't strike soft shoulders, curbs, road signs, trees, or other objects. Avoid jerky or sudden maneuvers. Signal well in advance.

Turn Signals When Towing a Trailer

When you tow a trailer, your vehicle has to have a different turn signal flasher and extra wiring. The green arrows on your instrument panel will flash whenever you signal a turn or lane change. Properly hooked up, the trailer lights will also flash, telling other drivers you're about to turn, change lanes or stop.

When towing a trailer, the green arrows on your instrument panel will flash for turns even if the bulbs on the trailer are burned out. Thus, you may think drivers behind you are seeing your signal when they are not. It's important to check occasionally to be sure the trailer bulbs are still working.

Driving On Grades

Reduce speed and shift to a lower gear **before** you start down a long or steep downgrade. If you don't shift down, you might have to use your brakes so much that they would get hot and no longer work well.

On a long uphill grade, use the highest gear possible. If you cannot maintain posted speeds, driving at a lower speed may help avoid overheating your engine and transaxle.

If you have a manual transaxle with fifth gear, it's better not to use fifth gear. Just drive in fourth gear (or, as you need to, a lower gear).

Parking on Hills

You really should not park your vehicle, with a trailer attached, on a hill. If something goes wrong, your rig could start to move. People can be injured, and both your vehicle and the trailer can be damaged.

But if you ever have to park your rig on a hill, here's how to do it:

1. Apply your regular brakes, but don't shift into **P** (Park) yet, or into gear for a manual transaxle.
2. Have someone place chocks under the trailer wheels.
3. When the wheel chocks are in place, release the regular brakes until the chocks absorb the load.

Your Driving and the Road

Driving with a Trailer (CONT.)

4. Reapply the regular brakes. Then apply your parking brake, and then shift to **P** (Park), or **R** (Reverse) for a manual transaxle.
5. Release the regular brakes.

When You Are Ready to Leave After Parking on a Hill

1. Apply your regular brakes and hold the pedal down while you:
 - Start your engine;
 - Shift into a gear; and
 - Release the parking brake.
2. Let up on the brake pedal.
3. Drive slowly until the trailer is clear of the chocks.
4. Stop and have someone pick up and store the chocks.

Maintenance When Trailer Towing

Your vehicle will need service more often when you're pulling a trailer. See the Maintenance Schedule for more on this. Things that are especially important in trailer operation are automatic transaxle fluid (don't overfill), engine oil, belts, cooling system, and brake adjustment. Each of these is covered in this manual, and the *Index* will help you find them quickly. If you're trailering, it's a good idea to review these sections before you start your trip.

Check periodically to see that all hitch nuts and bolts are tight.

Notes

Part 5

Problems on the Road



Here you'll find what to do about some problems that can occur on the road.

Hazard Warning Flashers	170
Jump Starting	171
Towing Your Pontiac	175
Engine Overheating	179
If a Tire Goes Flat	185
Changing a Flat Tire	186
Compact Spare	192
If You're Stuck: In Sand, Mud, Ice or Snow	193

Problems on the Road



Hazard Warning Flashers

Your hazard warning flashers let you warn others. They also let police know you have a problem. Your front and rear turn signal lights will flash on and off.



Move the switch to the right to make your front and rear turn signal lights flash on and off.

Your hazard warning flashers work no matter what position your key is in, and even if the key isn't in.

To turn off the flashers, move the switch to the left.

When the hazard warning flashers are on, your turn signals won't work.

Other Warning Devices

If you carry reflective triangles, you can set one up at the side of the road about 300 feet (100 m) behind your vehicle.

Jump Starting

If your battery has run down, you may want to use another vehicle and some jumper cables to start your Pontiac. But please follow the steps here to do it safely.

CAUTION



Batteries can hurt you. They can be dangerous because:

- They contain **acid** that can burn you.
- They contain **gas** that can explode or ignite.
- They contain enough **electricity** to burn you.

If you don't follow these steps exactly, some or all of these things can hurt you.

NOTICE

Ignoring these steps could result in costly damage to your vehicle that wouldn't be covered by your warranty.

Trying to start your Pontiac by pushing or pulling it could damage your vehicle, even if you have a manual transaxle. And if you have an automatic transaxle, it won't start that way.

To Jump Start Your Pontiac:

1. Check the other vehicle. It must have a 12-volt battery with a negative ground system.

NOTICE

If the other system isn't a 12-volt system with a negative ground, both vehicles can be damaged.

Problems on the Road

Jump Starting (CONT.)

2. Get the vehicles close enough so the jumper cables can reach, but be sure the vehicles aren't touching each other. If they are, it could cause a ground connection you don't want. You wouldn't be able to start your Pontiac, and the bad grounding could damage the electrical systems.

CAUTION



You could be injured if the vehicles roll. Set the parking brake firmly on each vehicle. Put an automatic transaxle in **P** (Park) or a manual transaxle in **N** (Neutral).

3. Turn off the ignition on both vehicles. Turn off all lights that aren't needed, and radios. This will avoid sparks and help save both batteries. And it could save your radio!

NOTICE

If you leave your radio on, it could be badly damaged. The repairs wouldn't be covered by your warranty.

4. Open the hoods and locate the batteries.

CAUTION



An electric fan can start up even when the engine is not running and can injure you. Keep hands, clothing and tools away from any underhood electric fan.

Find the positive (+) and negative (-) terminals on each battery.

CAUTION

 Using a match near a battery can cause battery gas to explode. People have been hurt doing this, and some have been blinded. Use a flashlight if you need more light.

Be sure the battery has enough water.

You don't need to add water to the Delco Freedom® battery installed in every new GM vehicle. But if a battery has filler caps, be sure the right amount of fluid is there. If it is low, add water to take care of that first. If you don't, explosive gas could be present.

Battery fluid contains acid that can burn you. Don't get it on you. If you accidentally get it in your eyes or on your skin, flush the place with water and get medical help immediately.

5. Check that the jumper cables don't have loose or missing insulation. If they do, you could get a shock. The vehicles could be damaged, too.

Before you connect the cables, here are some things you should know. Positive (+) will go to positive (+) and negative (-) will go to negative (-) or a metal engine part.

Don't connect (+) to (-) or you'll get a short that would damage the battery and maybe other parts, too.

CAUTION

 Fans or other moving engine parts can injure you badly. Keep your hands away from moving parts once the engines are running.

Problems on the Road

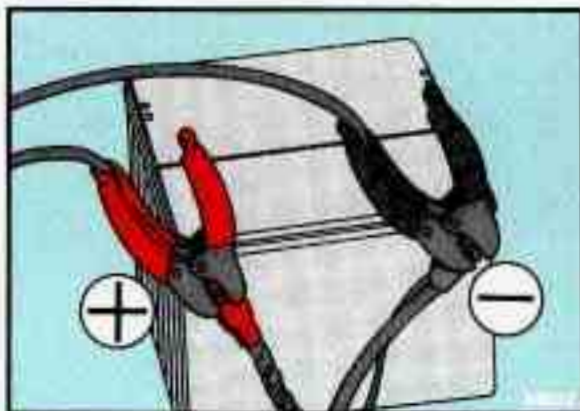

Jump Starting (CONT.)

- 6.** Connect the red positive (+) cable to the positive (+) terminal of the vehicle with the dead battery.

Use a remote positive (+) terminal if the vehicle has one.

- 7.** Don't let the other end touch metal. Connect it to the positive (+) terminal of the good battery.

Use a remote positive (+) terminal if the vehicle has one.

- 8.** Now connect the black negative (-) cable to the good battery's negative (-) terminal.

Don't let the other end touch anything until the next step. The other end of the negative cable **doesn't** go to the dead battery. It goes to a heavy unpainted metal part on the engine of the vehicle with the dead battery.

- 9.** Attach the cable at least 18 inches (45 cm) away from the dead battery, but not near engine parts that move. The electrical connection is just as good there, but the chance of sparks getting back to the battery is much less.

- 10.** Now start the vehicle with the good battery and run the engine for a while.

- 11.** Try to start the vehicle with the dead battery.

If it won't start after a few tries, it probably needs service.

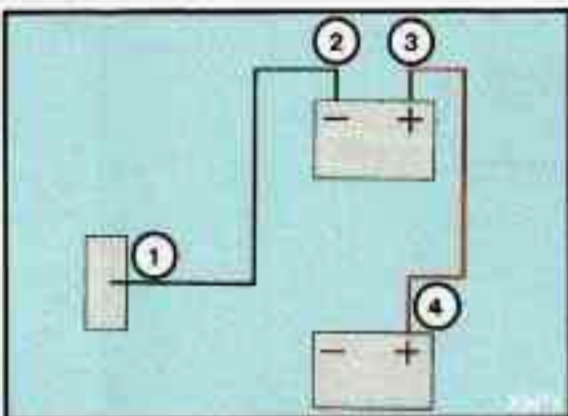

12. Remove the cables in reverse order to prevent electrical shorting. Take care that they don't touch each other or any other metal.

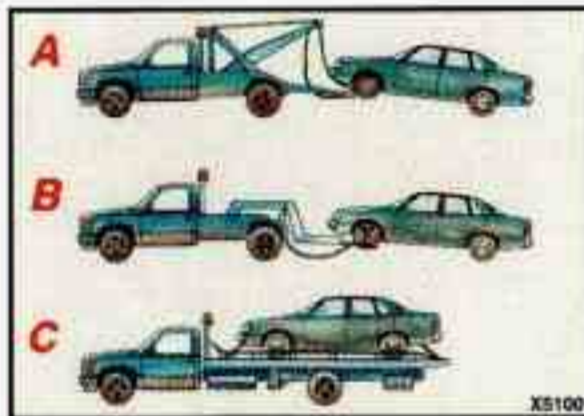

Towing Your Pontiac

Try to have a GM dealer or a professional towing service tow your Pontiac. The usual towing equipment is:

- (A) Sling-type tow truck
- (B) Wheel-lift tow truck
- (C) Car carrier

If your vehicle has been changed or modified since it was factory-new by adding aftermarket items like fog lamps, aero skirting, or special tires and wheels, these instructions and illustrations may not be correct.

Before you do anything, turn on the hazard warning flashers.

When you call, tell the towing service:

- That your vehicle cannot be towed from the front or rear with sling-type equipment, as described later in this section.
- That your vehicle has front-wheel drive.
- The make, model, and year of your vehicle.
- Whether you can still move the shift lever.
- If there was an accident, what was damaged.

When the towing service arrives, let the tow operator know that this manual contains detailed towing instructions and illustrations.

The operator may want to see them.

Problems on the Road



Towing Your Pontiac (CONT.)

CAUTION

 To help avoid injury to you or others:

- Never let passengers ride in a vehicle that is being towed.
- Never tow faster than safe or posted speeds.
- Never tow with damaged parts not fully secured.
- Never get under your vehicle after it has been lifted by the tow truck.
- Always use separate safety chains on each side when towing a vehicle.
- Never use "J" hooks. Use T-hooks instead.

When your vehicle is being towed, have the ignition key off. The steering wheel should be clamped in a straight-ahead position, with a clamping device designed for towing service. Do not use the vehicle's steering column lock for this. The transaxle should be in **N** (Neutral) and the parking brake released.

The ignition key must be in the **Off** position to prevent the automatic door locks from locking during towing.

Don't have your vehicle towed on the front wheels, unless you must. If the vehicle must be towed on the front wheels, don't go more than 35 mph (56 km/h) or farther than 50 miles (80 km) or your transaxle will be damaged. If these limits must be exceeded, then the front wheels have to be supported on a dolly.

CAUTION

 A vehicle can fall from a car carrier if it isn't properly secured. This can cause a collision, serious personal injury and vehicle damage. The vehicle should be tightly secured with chains or steel cables before it is transported.

Don't use substitutes (ropes, leather straps, canvas webbing, etc.) that can be cut by sharp edges underneath the towed vehicle.

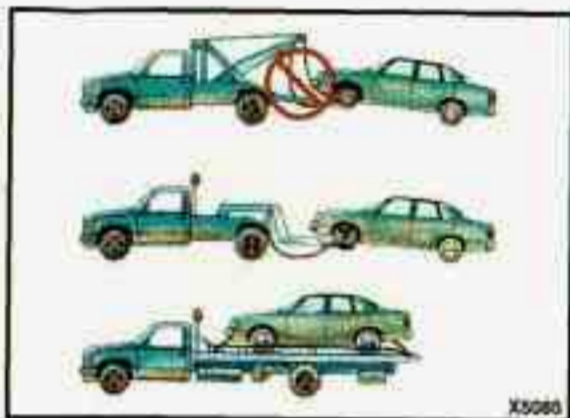

X5080

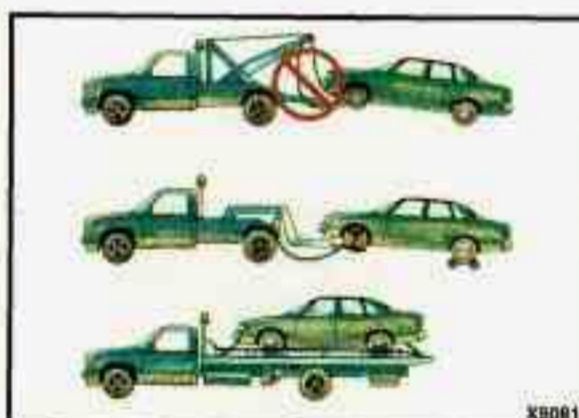

X8081



PH8018

Towing from the Front— Vehicle Hook-Up

Before hooking up to a tow truck, be sure to read all the information in *Towing Your Pontiac* earlier in this section.

NOTICE

Do not tow with sling-type equipment or fascia/fog light damage will occur. Use wheel-lift or car carrier equipment. Additional ramping may be required for car carrier equipment.

NOTICE

When using wheel-lift equipment, towing over rough surfaces can damage a vehicle. To help avoid this, install a towing dolly beneath the wheels that would otherwise be on the ground during the tow. This will increase clearance between the wheel-lift equipment and the underbody of the towed vehicle.

Attach a separate safety chain around the outboard end of each lower control arm.

Problems on the Road

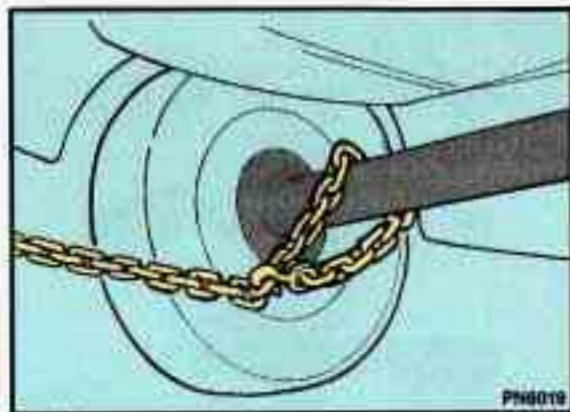
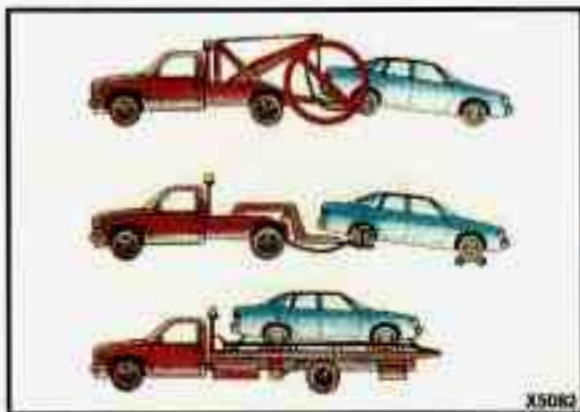
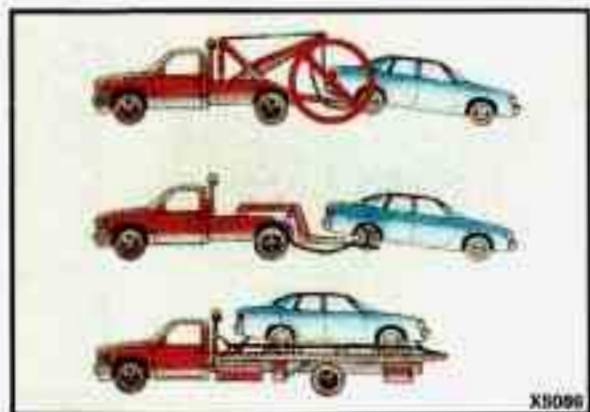

Towing from the Rear— Vehicle Hook-Up

Before hooking up to a tow truck, be sure to read all the information in *Towing Your Pontiac* earlier in this section. Also be sure to use the proper hook-up for your particular vehicle.

NOTICE

Do not tow with sling-type equipment or rear bumper valance will be damaged. Use wheel-lift or car carrier equipment (additional ramping may be required for car carrier equipment). Use safety chains and wheel straps.

NOTICE

When using wheel-lift equipment, towing over rough surfaces can damage a vehicle. To help avoid this, install a towing dolly beneath the wheels that would otherwise be on the ground during the tow. This will increase clearance between the wheel-lift equipment and the underbody of the towed vehicle.

Attach a separate safety chain to each side of the axle inboard of the spring.



Engine Overheating

You will find a coolant temperature gage or the warning light about a hot engine on your Pontiac's instrument panel. See the *Index* under *Coolant Temperature Gage* and *Coolant Temperature Warning Light*.

You will also find a low coolant warning light on your Pontiac's instrument panel.

If Steam is Coming from Your Engine:

CAUTION



Steam from an overheated engine can burn you badly, even if you just open the hood. Stay away from the engine if you see or hear steam coming from it. Just turn it off and get everyone away from the vehicle until it cools down. Wait until there is no sign of steam or coolant before opening the hood. If you keep driving when your engine is overheated, the liquids in it can catch fire. You or others could be badly burned. Stop your engine if it overheats, and get out of the vehicle until the engine is cool.

NOTICE

If your engine catches fire because you keep driving with no coolant, your vehicle can be badly damaged. The costly repairs would not be covered by your warranty.

Problems on the Road

Engine Overheating (CONT.)

If No Steam is Coming from Your Engine:

If you get the overheat warning but see or hear no steam, the problem may not be too serious. Sometimes the engine can get a little too hot when you:

- Climb a long hill on a hot day.
- Stop after high speed driving.
- Idle for long periods in traffic.
- Tow a trailer.

If you get the overheat warning with no sign of steam, try this for a minute or so:

1. If you have an air conditioner, turn it off.
2. Turn your heater to full hot at the highest fan speed and open the window as necessary.
3. Try to keep your engine under load (in a drive gear where the engine runs slower).

If you no longer have the overheat warning, you can drive. Just to be safe, drive slower for about ten minutes. If the warning doesn't come back on, you can drive normally.

If the warning continues, pull over, stop, and park your vehicle right away.

If there's still no sign of steam, you can idle the engine for two or three minutes while you're parked, to see if the warning stops.

But then, if you still have the warning, **TURN OFF THE ENGINE AND GET EVERYONE OUT OF THE VEHICLE** until it cools down.

You may decide not to lift the hood but to get service help right away.

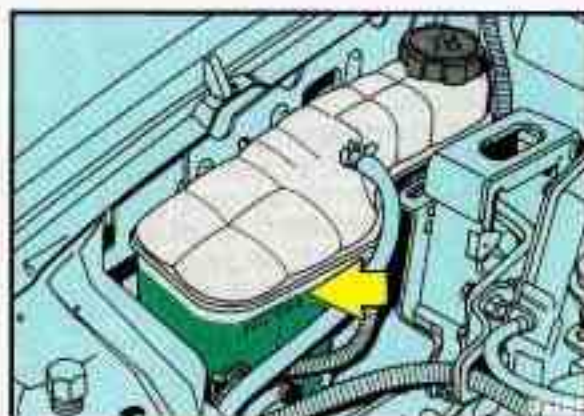
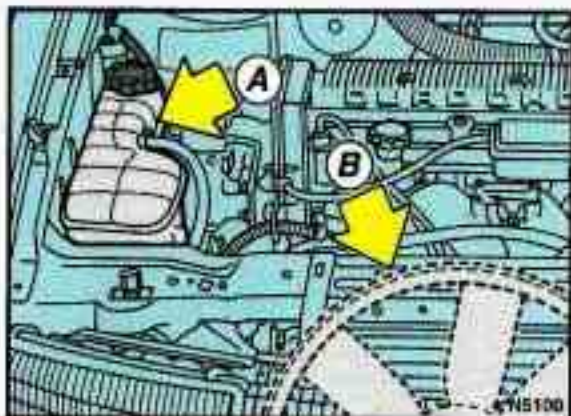

Cooling System

When you decide it's safe to lift the hood, here's what you'll see:

- (A) Coolant surge tank with pressure cap
- (B) Electric engine fan

CAUTION

 An electric fan under the hood can start up even when the engine is not running and can injure you. Keep hands, clothing and tools away from any underhood electric fan.

If the coolant inside the coolant surge tank is boiling, don't do anything else until it cools down.

The coolant level should be at or above **FULL COLD**.

If it isn't, you may have a leak in the radiator hoses, heater hoses, radiator, water pump or somewhere else in the cooling system.

CAUTION

 Heater and radiator hoses, and other engine parts, can be very hot. Don't touch them. If you do, you can be burned.

Don't run the engine if there is a leak. If you run the engine, it could lose all coolant. That could cause an engine fire, and you could be burned. Get any leak fixed before you drive the vehicle.

NOTICE

Engine damage from running your engine without coolant isn't covered by your warranty.

If there seems to be no leak, check to see if the electric engine fan is running. If the engine is overheating, the fan should be running. If it isn't, your vehicle needs service.

Problems on the Road

Engine Overheating (CONT.)

How to Add Coolant to the Coolant Surge Tank:

If you haven't found a problem yet, but the coolant level isn't at or above **FULL COLD**, add a 50/50 mixture of **clean water** (preferably distilled) and a proper antifreeze at the coolant surge tank, but be sure the cooling system, including the coolant surge tank pressure cap, is cool before you do it. (See the *Index* under *Engine Coolant* for more information about the proper coolant mix.)

CAUTION



Steam and scalding liquids from a hot cooling system can blow out and burn you badly. They are under pressure, and if you turn the coolant surge tank pressure cap—even a little—they can come out at high speed. Never turn the pressure cap when the cooling system, including the coolant surge tank pressure cap, is hot. Wait for the cooling system and coolant surge tank pressure cap to cool if you ever have to turn the pressure cap.

CAUTION



Adding only plain water to your cooling system can be dangerous. Plain water, or some other liquid like alcohol, can boil before the proper coolant mix will. Your vehicle's coolant warning system is set for the proper coolant mix. With plain water or the wrong mix, your engine could get too hot but you wouldn't get the overheat warning. Your engine could catch fire and you or others could be burned. Use a 50/50 mix of **clean water** and a proper antifreeze.

NOTICE

In cold weather, water can freeze and crack the engine, radiator, heater core and other parts. So use the recommended coolant.

CAUTION



You can be burned if you spill coolant on hot engine parts. Coolant contains ethylene glycol and it will burn if the engine parts are hot enough. Don't spill coolant on a hot engine.

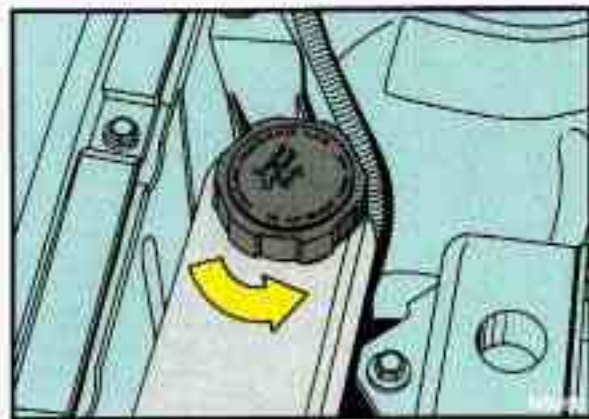

1. You can remove the coolant surge tank pressure cap when the cooling system, including the coolant surge tank pressure cap and upper radiator hose, is no longer hot. Turn the pressure cap slowly about $\frac{1}{4}$ turn to the left and then stop.

If you hear a hiss, wait for that to stop. A hiss means there is still some pressure left.

Problems on the Road

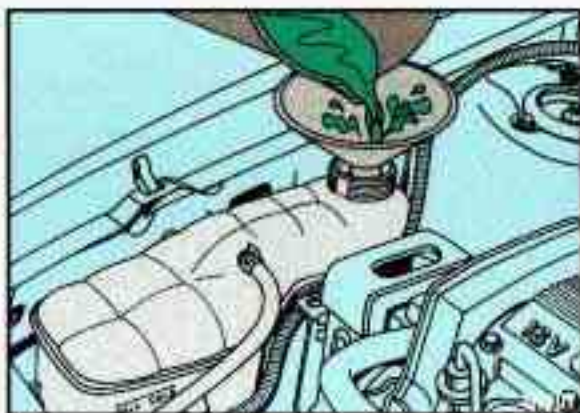
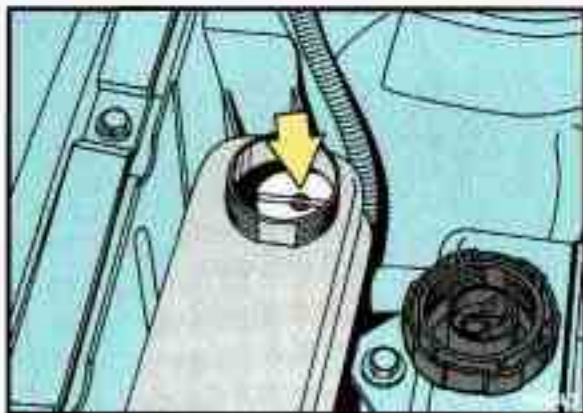

Engine Overheating (CONT.)

2. Then keep turning the pressure cap, and remove it.

Once the pressure cap is off, look inside the surge tank opening and look for a small cylinder at the base of the opening. This should be covered with coolant. If the cylinder is uncovered, the coolant in your system is low.

3. Fill the coolant surge tank with the proper mix, up to **FULL COLD**, or just above the small cylinder at the base of the opening.

4. With the coolant surge tank pressure cap off, start the engine and let it run until you can feel the upper radiator hose getting hot. Watch out for the engine fan.

By this time, the coolant level inside the coolant surge tank may be lower. If the level is lower, add more of the proper mix to the coolant surge tank until the level reaches **FULL COLD**, or just above the small cylinder at the base of the opening.

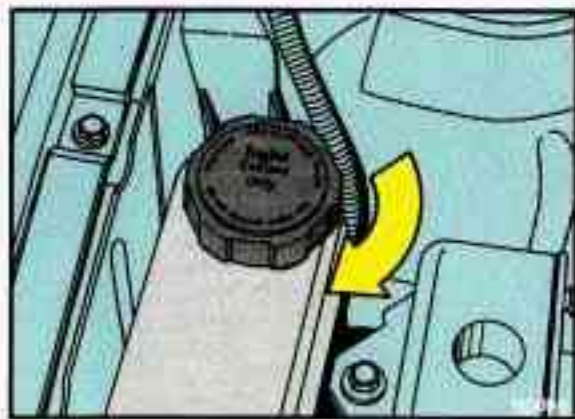

5. Then replace the pressure cap. Be sure the pressure cap is tight.

■ *If a Tire Goes Flat*

It's unusual for a tire to "blow out" while you're driving, especially if you maintain your tires properly. If air goes out of a tire, it's much more likely to leak out slowly. But if you should ever have a "blowout," here are a few tips about what to expect and what to do:

If a front tire fails, the flat tire will create a drag that pulls the vehicle toward that side. Take your foot off the accelerator pedal and grip the steering wheel firmly. Steer to maintain lane position, then gently brake to a stop well out of the traffic lane.

A rear blowout, particularly on a curve, acts much like a skid and may require the same correction you'd use in a skid. In any rear blowout, remove your foot from the accelerator pedal. Get the vehicle under control by steering the way you want the vehicle to go. It may be very bumpy and noisy, but you can still steer. Gently brake to a stop, well off the road if possible.

If your tire goes flat, the next section shows how to use your jacking equipment to change a flat tire safely.

Problems on the Road



Changing a Flat Tire

If a tire goes flat, avoid further tire and wheel damage by driving slowly to a level place. Turn on your hazard warning flashers.

CAUTION



Changing a tire can cause an injury. The vehicle can slip off the jack and roll over you or other people. You and they could be badly injured. Find a level place to change your tire. To help prevent the vehicle from moving:

1. Set the parking brake firmly.
2. Put an automatic shift lever in **P** (Park).
3. Shift a manual transaxle to **1** or **R** (Reverse).
4. Turn off the engine.

To be even more certain the vehicle won't move, you can put chocks at the front and rear of the tire farthest away from the one being changed. That would be the tire on the other side of the vehicle, at the opposite end.



The following steps will tell you how to use the jack and change a tire. The equipment you'll need is in the trunk.

1. Turn the center retainer nut on the compact spare tire housing counterclockwise to remove it, then lift the tire cover. You will find the jacking instructions label on the underside of the tire cover.

- 2.** Remove the wing bolt securing the compact spare tire, spacer and wheel wrench by turning it counterclockwise. Then lift off the spacer and remove the spare tire.
- 3.** Remove the bolt securing the jack by turning it counterclockwise. Then remove the jack.

Problems on the Road

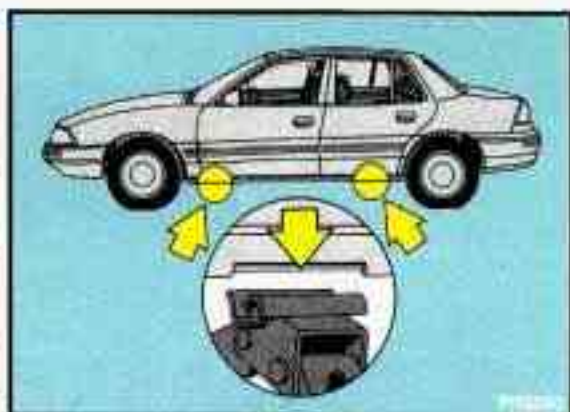
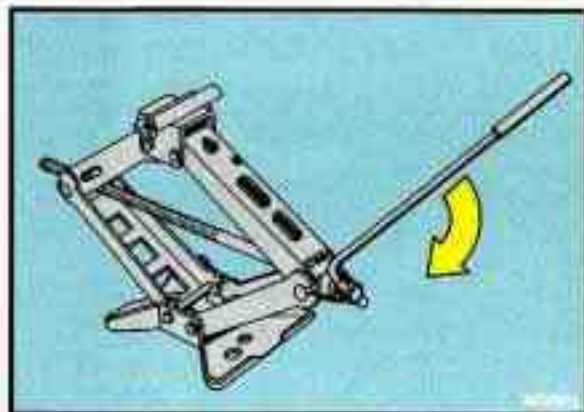

Changing a Flat Tire (CONT.)

- 4.** Remove the band around the jack. Turn the jack handle clockwise to raise the jack head a few inches.

- 5.** Using the wheel wrench, remove the plastic cap nuts (if your vehicle has them) and loosen all the wheel nuts. Don't remove them yet.

On some models, a cover plate must be removed to find the wheel nuts. Carefully use the wedge end of the wheel wrench to pry it off.

- 6.** Near each wheel, there is a notch in the vehicle's frame. Position the jack under the vehicle. Raise the jack head until it fits firmly into the notch in the vehicle's frame nearest the flat tire. Put the compact spare tire near you.

CAUTION



Getting under a vehicle when it is jacked up is dangerous. If the vehicle slips off the jack, you could be badly injured or killed. Never get under a vehicle when it is supported only by a jack.

NOTICE

Raising your vehicle with the jack improperly positioned will damage the vehicle or may allow the vehicle to fall off the jack. Be sure to fit the jack lift head into the proper location before raising your vehicle.

NOTICE

Do not jack or lift vehicle using oil pan. Pans could crack and begin to leak fluid.

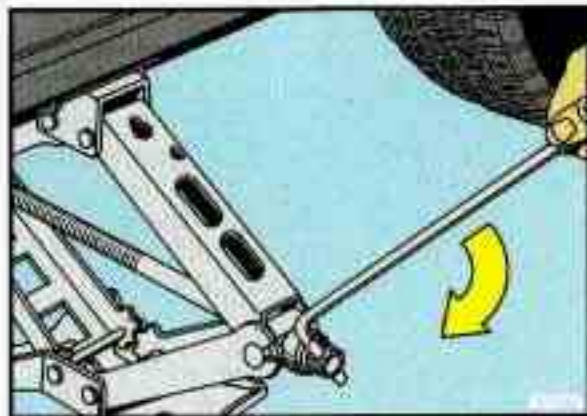

7. Raise the vehicle by rotating the wheel wrench clockwise. Raise the vehicle far enough off the ground so there is enough room for the spare tire to fit.
8. Remove all of the wheel nuts, and carefully pry the wheel cover from the wheel, if your flat tire has one. Then take off the flat tire.

Problems on the Road

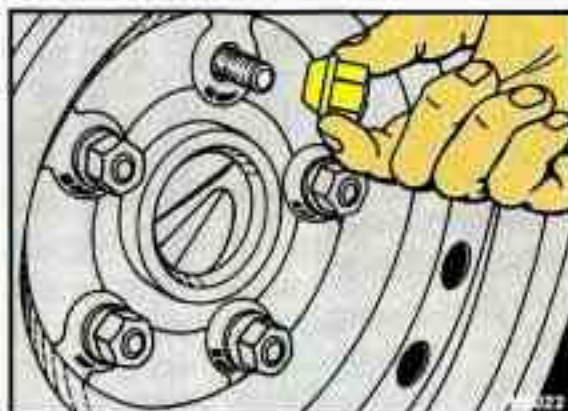

Changing a Flat Tire (CONT.)

CAUTION

 Rust or dirt on the wheel, or on the parts to which it is fastened, can make the wheel nuts become loose after a time. The wheel could come off and cause an accident. When you change a wheel, remove any rust or dirt from the places where the wheel attaches to the vehicle. In an emergency, you can use a cloth or a paper towel to do this; but be sure to use a scraper or wire brush later, if you need to, to get all the rust or dirt off.

9. Remove any rust or dirt from the wheel bolts, mounting surfaces or spare wheel.
10. Place the spare on the wheel mounting surface.

CAUTION

 Never use oil or grease on studs or nuts. If you do, the nuts might come loose. Your wheel could fall off, causing a serious accident.

11. Replace the wheel nuts with the rounded end of the nuts toward the wheel. Tighten each nut by hand until the wheel is held against the hub.

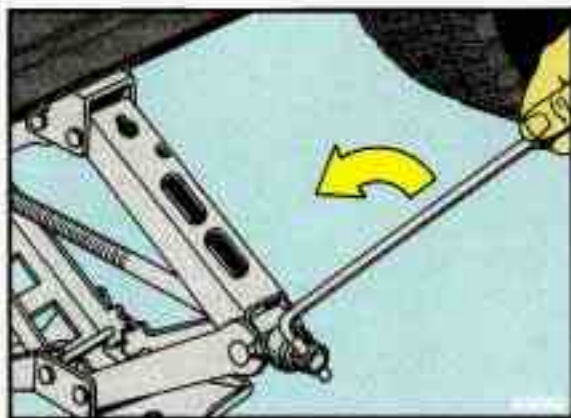

12. Lower the vehicle by rotating the wheel wrench counterclockwise. Lower the jack completely.

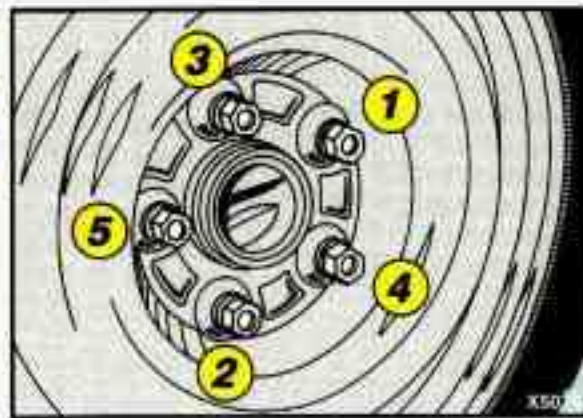

13. Tighten the wheel nuts firmly in a criss-cross sequence, as shown.

CAUTION



Incorrect wheel nuts or improperly tightened wheel nuts can cause the wheel to become loose and even come off. This could lead to an accident. Be sure to use the correct wheel nuts. If you have to replace them, be sure to get the right kind.

Stop somewhere as soon as you can and have the nuts tightened with a torque wrench to 100 pound-feet (140 N•m).

Don't try to put a wheel cover on your compact spare tire. It won't fit. Store the wheel cover and plastic cap nuts in the trunk until you have the flat tire repaired or replaced.

NOTICE

Wheel covers won't fit on your compact spare. If you try to put a wheel cover on your compact spare, you could damage the cover or the spare.

Problems on the Road

Changing a Flat Tire (CONT.)

14. Store the flat tire in the compact spare tire compartment, and secure with the wing bolt and extension. Store the jack and wheel wrench in their compartment, also.

CAUTION



Storing a jack, a tire, or other equipment in the passenger compartment of the vehicle could cause injury. In a sudden stop or collision, loose equipment could strike someone. Store all these in the proper place.

Compact Spare Tire

Although the compact spare was fully inflated when your vehicle was new, it can lose air after a time. Check the inflation pressure regularly. It should be 60 psi (420 kPa). The compact spare is made to go up to 3,000 miles (5 000 km), so you can finish your trip and have your full-size tire repaired or replaced where you want. Of course, it's best to replace your spare with a full-size tire as soon as you can. Your spare will last longer and be in good shape in case you need it again.

Your anti-lock brake system warning light may come on when you are driving with a compact spare. See the *Index* under *Anti-Lock Brake System Warning Light*.

NOTICE

Don't take your compact spare through an automatic vehicle wash with guide rails. The compact spare can get caught on the rails. That can damage the tire and wheel, and maybe other parts of your vehicle.

Don't use your compact spare on some other vehicle.

And don't mix your compact spare or wheel with other wheels or tires. They won't fit. Keep your spare and its wheel together.

NOTICE

Tire chains won't fit your compact spare. Using them will damage your vehicle and destroy the chains too. Don't use tire chains on your compact spare.

CAUTION



Storing a jack, a tire, or other equipment in the passenger compartment of the vehicle could cause injury. In a sudden stop or collision, loose equipment could strike someone. Store all these in the proper place.

If You're Stuck: In Sand, Mud, Ice or Snow

What you **don't** want to do when your vehicle is stuck is to spin your wheels. The method known as "rocking" can help you get out when you're stuck, but you must use caution.

CAUTION



If you let your tires spin at high speed, they can explode and you or others could be injured. And, the transaxle or other parts of the vehicle can overheat. That could cause an engine compartment fire or other damage. When you're stuck, spin the wheels as little as possible. Don't spin the wheels above 35 mph (56 km/h) as shown on the speedometer.

Problems on the Road

If You're Stuck: In Sand, Mud, Ice or Snow (CONT.)

NOTICE

Spinning your wheels can destroy parts of your vehicle as well as the tires. If you spin the wheels too fast while shifting your transaxle back and forth, you can destroy your transaxle.

Rocking Your Vehicle to Get it Out:

First, turn your steering wheel left and right. That will clear the area around your front wheels. Then shift back and forth between **R** (Reverse) and a forward gear, or with a manual transaxle, between **1** or **2** and **R** (Reverse), spinning the wheels as little as possible. Release the accelerator pedal while you shift, and press lightly on the accelerator pedal when the transaxle is in gear. If that doesn't get you out after a few tries, you may need to be towed out.

If you do need to be towed out, see the *Index* under *Towing Your Pontiac*.



Part 6

Service & Appearance Care

Here you will find information about the care of your Pontiac. This part begins with service and fuel information, and then it shows how to check important fluid and lubricant levels. There is also technical information about your vehicle, and a section devoted to its appearance care.

Service	198
Fuel	199
Hood Release	205
Engine Oil	209
Air Cleaner	214
Transaxle Fluid	216
Engine Coolant	221
Power Steering Fluid	224
Windshield Washer Fluid	224
Brakes	225
Battery	227
Bulb Replacement	228
Windshield Wiper Blade Replacement	230
Loading Your Vehicle	230
Tires	232
Appearance Care	239
Vehicle Identification Number (VIN)	247
Add-On Electrical Equipment	248
Fuses & Circuit Breakers	248
Capacities & Specifications	251
Fluids & Lubricants	253
Replacement Bulbs	254
Normal Maintenance Replacement Parts	257

Service & Appearance Care



Service

Your Pontiac dealer knows your vehicle best and wants you to be happy with it. We hope you'll go to your dealer for all your service needs. You'll get genuine GM parts and GM-trained and supported service people.

We hope you'll want to keep your GM vehicle all GM. Genuine GM parts have one of these marks.

Doing Your Own Service Work

If you want to do some of your own service work, you'll want to get the proper Pontiac service manual. It tells you much more about how to service your Pontiac than this manual can. To order the proper service manual, see the *Index* under *Service Publications*.

You should keep a record with all parts receipts and list the mileage and the date of any service work you perform. See the *Index* under *Maintenance Record*.

CAUTION



You can be injured if you try to do service work on a vehicle without knowing enough about it.

- Be sure you have sufficient knowledge, experience, and the proper replacement parts and tools before you attempt any vehicle maintenance task.
- Be sure to use the proper nuts, bolts and other fasteners. "English" and "metric" fasteners can be easily confused. If you use the wrong fasteners, parts can later break or fall off. You could be hurt.



NOTICE

If you try to do your own service work without knowing enough about it, your vehicle could be damaged.

Fuel

2.3L Quad OHC and Quad 4 Engines (Codes 3 and D) and 3300 V6 Engine (Code N):

The 8th digit of your Vehicle Identification Number (VIN) shows the code letter for your engine. You will find the VIN at the top left of your instrument panel. (See the *Index* under *Vehicle Identification Number*.)

Use regular unleaded gasoline rated at 87 octane or higher. It should meet specifications ASTM D4814 in the U.S. and CGSB 3.5-92 in Canada. These fuels should have the proper additives, so you should not have to add anything to the fuel.

In the U.S. and Canada, it's easy to be sure you get the right kind of gasoline (unleaded). You'll see "UNLEADED" right on the pump. And only unleaded nozzles will fit into your vehicle's filler neck.

Be sure the posted octane is at least 87. If the octane is less than 87, you may get a heavy knocking noise when you drive. If it's bad enough, it can damage your engine.

Service & Appearance Care

Fuel (CONT.)

If you're using fuel rated at 87 octane or higher and you still hear heavy knocking, your engine needs service. But don't worry if you hear a little pinging noise when you're accelerating or driving up a hill. That's normal, and you don't have to buy a higher octane fuel to get rid of pinging. It's the heavy, constant knock that means you have a problem.

2.3L High Output Quad 4 Engine (Code A):

The 8th digit of your Vehicle Identification Number (VIN) shows the code letter for your engine. You will find the VIN at the top left of your instrument panel. (See the *Index* under *Vehicle Identification Number*.)

Use premium unleaded gasoline rated at 91 octane or higher. You may use middle grade or regular unleaded gasolines, but your vehicle may not accelerate as well. The gasoline you use should meet specifications ASTM D4814 in the U.S. and CGSB 3.5-92 in Canada. These fuels should have the proper additives, so you should not have to add anything to the fuel.

In the U.S. and Canada, it's easy to be sure you get the right kind of gasoline (unleaded). You'll see "UNLEADED" right on the pump. And only unleaded nozzles will fit into your vehicle's filler neck.

Be sure the posted octane for premium is at least 91 (at least 89 for middle grade and 87 for regular). If the octane is less than 87, you may get a heavy knocking noise when you drive. If it's bad enough, it can damage your engine.

If you're using fuel rated at 91 octane or higher and you still hear heavy knocking, your engine needs service. But don't worry if you hear a little pinging noise when you're accelerating or driving up a hill. That's normal and you don't have to buy a higher octane fuel to get rid of pinging. It's the heavy, constant knock that means you have a problem.

What about gasoline with blending materials that contain oxygen, such as MTBE or alcohol?

- **MTBE** is "methyl tertiary-butyl ether." Fuel that is no more than 15% **MTBE** is fine for your vehicle.
- **Ethanol** is ethyl or grain alcohol. Properly-blended fuel that is no more than 10% **ethanol** is fine for your vehicle.
- **Methanol** is methyl or wood alcohol.

NOTICE

Fuel that is more than 5% **methanol** is bad for your vehicle. Don't use it. It can corrode metal parts in your fuel system and also damage plastic and rubber parts. That damage wouldn't be covered under your warranty. And even at 5% or less, there must be "cosolvents" and corrosion preventers in this fuel to help avoid these problems.

Fuel Capacity:

15.2 U.S. Gallons (57.5L). Use unleaded fuel only.

Service & Appearance Care

Gasolines for Cleaner Air

Your use of gasoline with detergent additives will help prevent deposits from forming in your engine and fuel system. That helps keep your engine in tune and your emission control system working properly. It's good for your vehicle, and you'll be doing your part for cleaner air.

Many gasolines are now blended with materials called oxygenates. General Motors recommends that you use gasolines with these blending materials, such as MTBE and ethanol. By doing so, you can help clean the air, especially in those parts of the country that have high carbon monoxide levels.

In addition, some gasoline suppliers are now producing reformulated gasolines. These gasolines are specially designed to reduce vehicle emissions. General Motors recommends that you use reformulated gasoline. By doing so, you can help clean the air, especially in those parts of the country that have high ozone levels.

You should ask your service station operators if their gasolines contain detergents and oxygenates, and if they have been reformulated to reduce vehicle emissions.

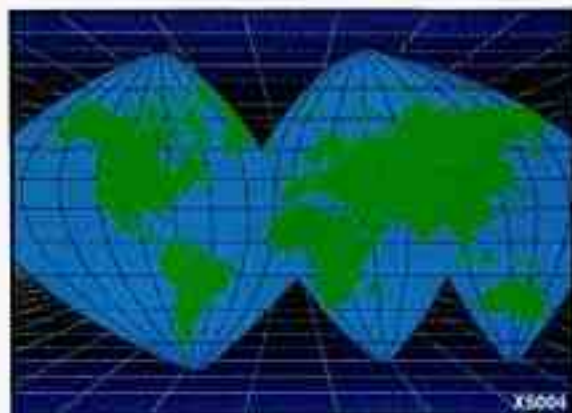

Fuels in Foreign Countries

If you plan on driving in another country outside the U.S. or Canada, unleaded fuel may be hard to find.

Do not use leaded gasoline. If you use even one tankful, your emission controls won't work well or at all. With continuous use, spark plugs can get fouled, the exhaust system can corrode, and your engine oil can deteriorate quickly. Your vehicle's oxygen sensor will be damaged. All of that means costly repairs that wouldn't be covered by your warranty.



Remote Fuel Filler Door Release

The remote fuel filler door release can help keep your fuel tank from being siphoned. Always be sure the fuel door is closed and latched after refueling.

To open the fuel door (on the right rear quarter panel), pull the fuel access handle on the floor by the driver's seat.



Filling Your Tank

CAUTION

 Gasoline vapor is highly flammable. It burns violently, and that can cause very bad injuries. Don't smoke if you're near gasoline or refueling your vehicle. Keep sparks, flames, and smoking materials away from gasoline.

The cap is behind a hinged door on the right side of your vehicle.

To take off the cap, turn it slowly to the left (counterclockwise).

To check on fuel availability, ask an auto club, or contact a major oil company that does business in the country where you'll be driving.

You can also write us at the following address for advice. Just tell us where you're going and give your Vehicle Identification Number (VIN).

General Motors of Canada Ltd.
International Export Sales
P.O. Box 828
Oshawa, Ontario L1H 7N1, Canada

Service & Appearance Care



Filling Your Tank (CONT.)

While refueling, hang the cap inside the fuel door.

CAUTION



If you get gasoline on you and then something ignites it, you could be badly burned. Gasoline can spray out on you if you open the fuel filler cap too quickly. This spray can happen if your tank is nearly full, and is more likely in hot weather. Open the fuel filler cap slowly and wait for any "hiss" noise to stop. Then unscrew the cap all the way.

When you put the cap back on, turn it to the right until you hear a clicking noise.

NOTICE

If you need a new cap, be sure to get the right type. Your dealer can get one for you. If you get the wrong type, it may not fit or have proper venting, and your fuel tank and emissions system might be damaged.

■ **Checking Things Under the Hood**

The following sections tell you how to check fluids, lubricants and important parts underhood.



Hood Release

To open the hood, first pull the **HOOD** release handle inside the vehicle.

Then go to the front of the vehicle and release the secondary hood release.

Lift the hood, release the hood prop rod from its retainer and put the hood prop into the slot in the hood.

Service & Appearance Care

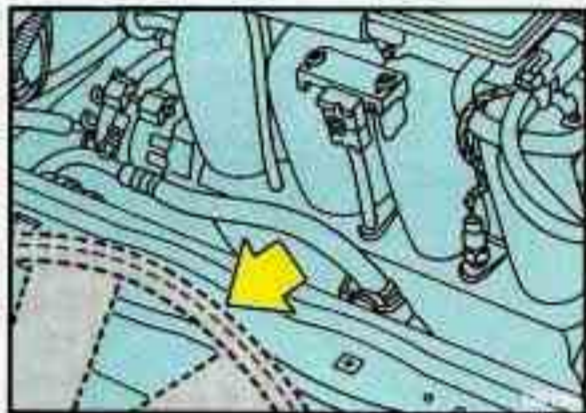

Hood Release (CONT.)

CAUTION



An electric fan under the hood can start up and injure you even when the engine is not running. Keep hands, clothing and tools away from any underhood electric fan.

CAUTION



Things that burn can get on hot engine parts and start a fire. These include liquids like gasoline, oil, coolant, brake fluid, windshield washer and other fluids, and plastic or rubber. You or others could be burned. Be careful not to drop or spill things that will burn onto a hot engine.

Before closing the hood, be sure all the filler caps are on properly. Then lift the hood to relieve pressure on the hood prop. Remove the hood prop from the slot in the hood and return the prop to its retainer. Then just let the hood down and close it firmly.

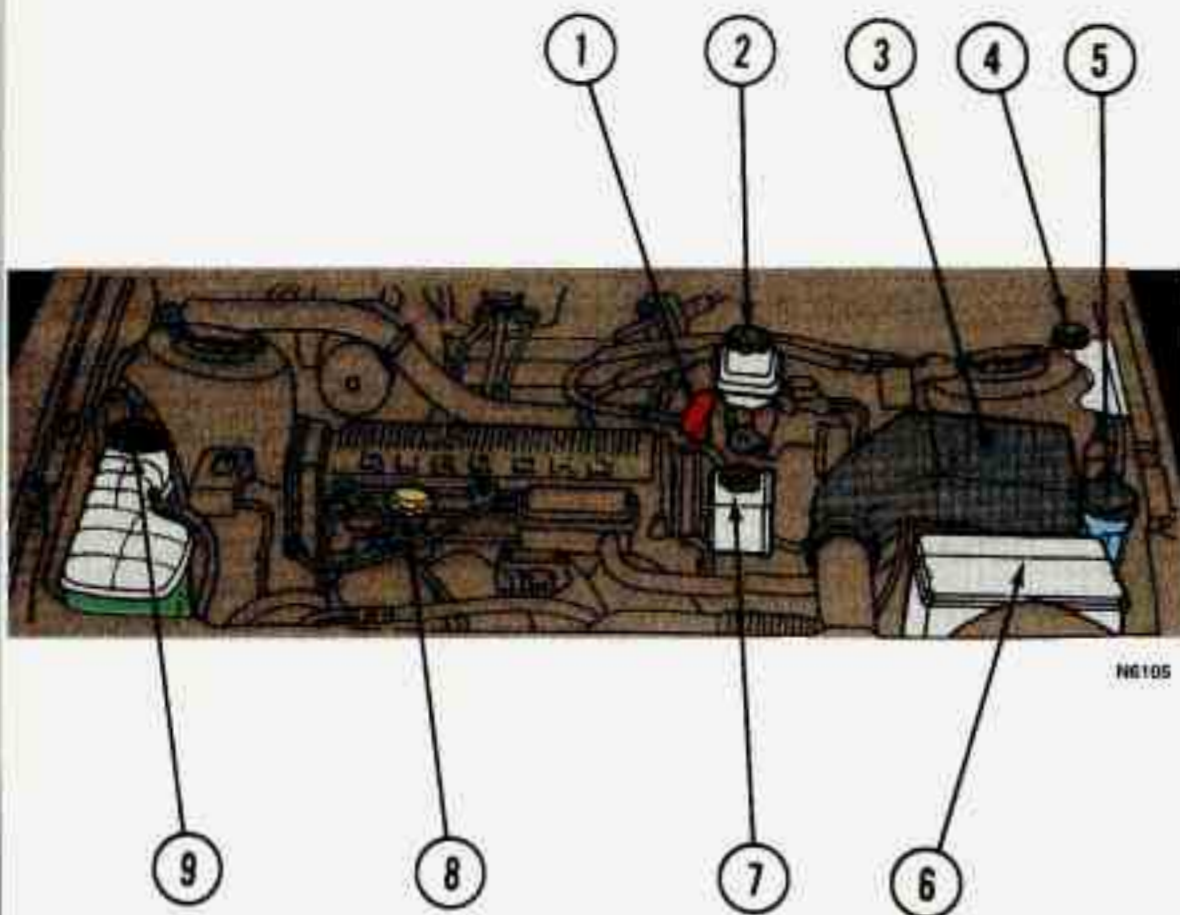

NE105

2.3L Quad OHC and Quad 4 Engines (CODES 3, D AND A)

When you open the hood, you'll see:

1. Automatic Transaxle Dipstick (if equipped)
2. Brake Fluid Reservoir
3. Air Cleaner
4. Hydraulic Clutch Fluid Reservoir (if equipped)
5. Windshield Washer Fluid Reservoir
6. Battery
7. Power Steering Fluid Reservoir
8. Engine Oil Fill Cap, Engine Oil Dipstick
9. Engine Coolant Surge Tank

Service & Appearance Care

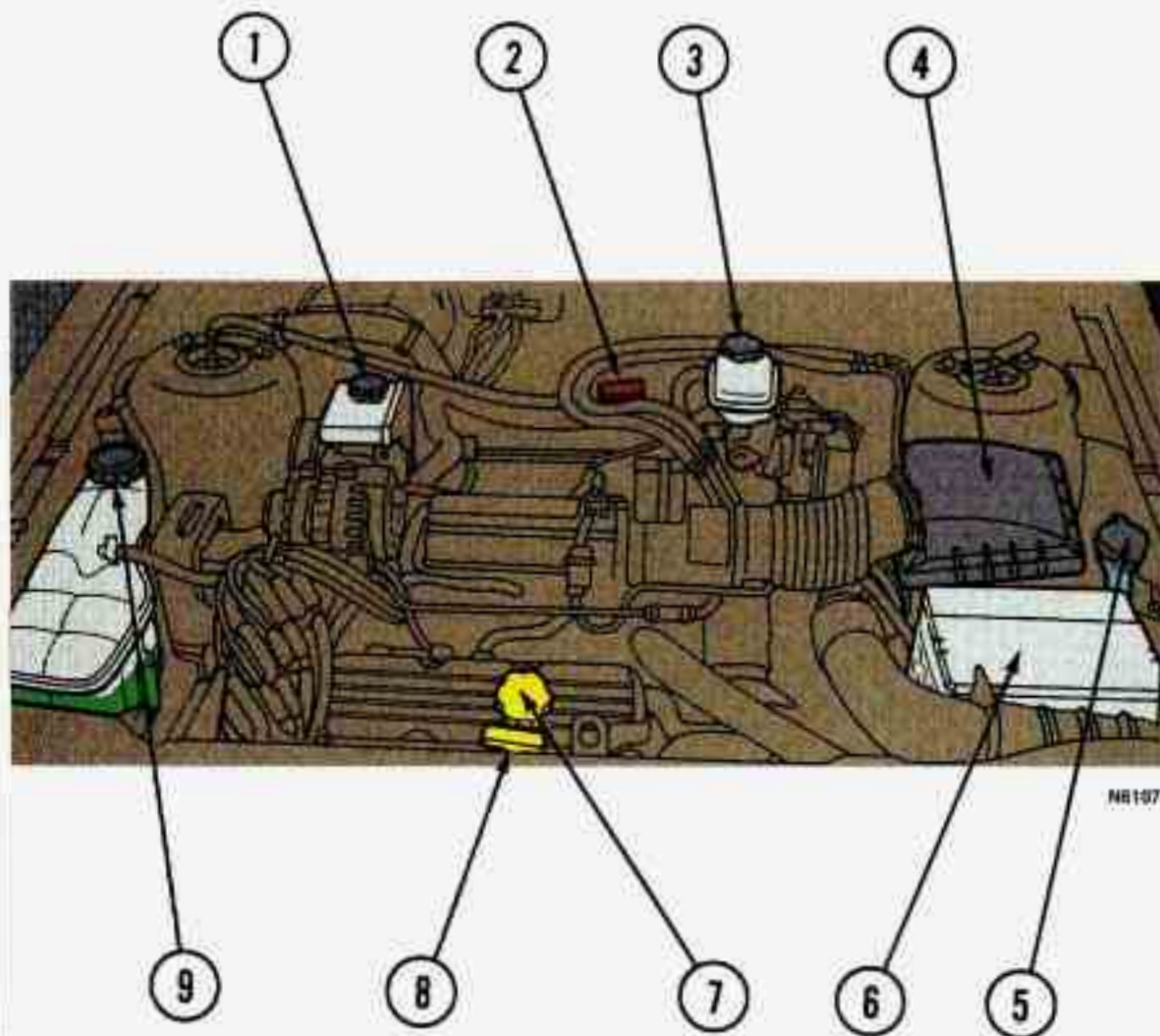

3300 V6 Engine (CODE N)

When you open your hood, you'll see:

1. Power Steering Fluid Reservoir
2. Automatic Transaxle Fluid Dipstick (if equipped)
3. Brake Fluid Reservoir
4. Air Cleaner
5. Windshield Washer Fluid Reservoir
6. Battery
7. Engine Oil Fill Cap
8. Engine Oil Dipstick
9. Engine Coolant Surge Tank

Engine Oil

It's a good idea to check your engine oil every time you get fuel. In order to get an accurate reading, the oil must be warm and the vehicle must be on level ground. Turn off the engine and give the oil a few minutes to drain back into the oil pan. If you don't, the oil dipstick might not show the actual level.

To Check Engine Oil:

Pull out the dipstick and clean it with a paper towel or cloth, then push it back in all the way. Remove it again, keeping the tip lower.

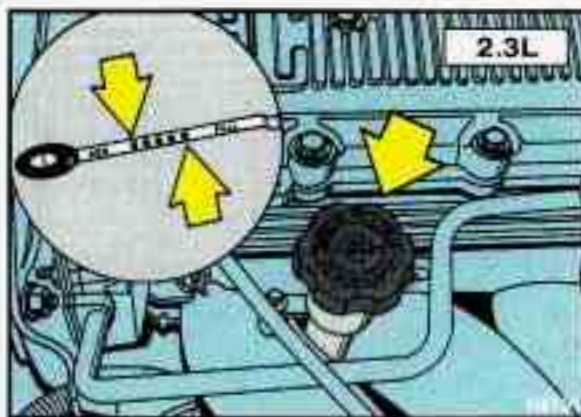

2.3L Quad OHC and Quad 4:
Checking Engine Oil

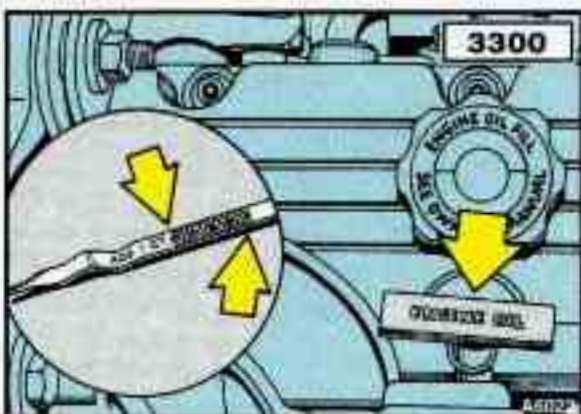

3300 V6: Checking Engine Oil

When to Add Oil:

If the oil is at or below the **ADD** line, then you'll need to add some oil. But you must use the right kind. This section explains what kind of oil to use. For crankcase capacity, see the *Index* under *Capacities & Specifications*.

NOTICE

Don't add too much oil. If your engine has so much oil that the oil level gets above the cross-hatched area that shows the proper operating range, your engine could be damaged.

Service & Appearance Care

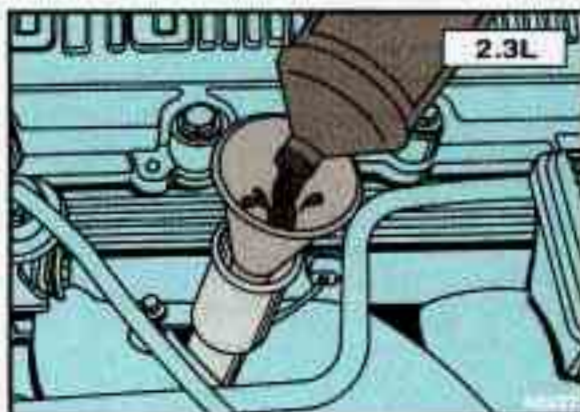

2.3L Quad OHC and Quad 4: Adding Engine Oil



3300 V6: Adding Engine Oil



What Kind of Oil to Use

Look for Three Things:

- **SG**

"SG" must be on the oil container, either by itself or combined with other quality designations, such as "SG/CC," "SG/CD," "SF, SG, CC," etc. These letters show American Petroleum Institute (API) levels of quality.

Engine Oil (CONT.)

Just fill it enough to put the level somewhere in the proper operating range. Push the dipstick all the way back in when you're through.

NOTICE

If you use oils that don't have the "SG" designation, you can cause engine damage not covered by your warranty.

Recommended SAE Viscosity Grade Engine Oils

For best fuel economy and cold starting, select the lowest SAE viscosity grade oil for the expected temperature range.

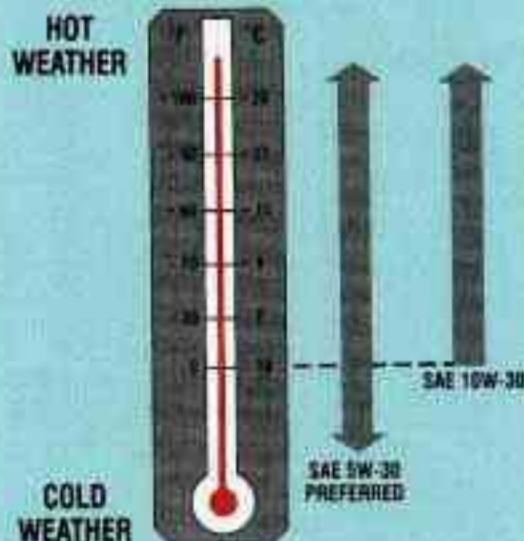

IF NEITHER SAE 5W-30 NOR SAE 10W-30 GRADE OILS ARE AVAILABLE, SAE 30 GRADE MAY BE USED AT TEMPERATURES ABOVE 40 DEGREES F (4 DEGREES C).

DO NOT USE SAE 10W-40, SAE 20W-50 OR ANY OTHER GRADE OIL NOT RECOMMENDED.

- **SAE 5W-30 (2.3L Quad OHC and Quad 4 Engines)**

As shown in the viscosity chart, SAE 5W-30 is best for your vehicle. However, you can use SAE 10W-30 if it's going to be 0°F (-18°C) or above.

These numbers on an oil container show its viscosity, or thickness.

Do not use other viscosity oils such as SAE 10W-40 or SAE 20W-50.

Service & Appearance Care



What Kind of Oil to Use (CONT.)

- **SAE 10W-30 (3300 V6 Engine)**

As shown in the viscosity chart, SAE 10W-30 is best for your vehicle.

However, you can use SAE 5W-30 if it's going to be colder than 60°F (16°C) before your next oil change.

When it's very cold, below 0°F (-18°C), you should use SAE 5W-30.

These numbers on an oil container show its viscosity, or thickness.

Do not use other viscosity oils such as SAE 10W-40 or SAE 20W-50.

Recommended SAE Viscosity Grade Engine Oils

For best fuel economy and cold starting, select the lowest SAE viscosity grade oil for the expected temperature range.

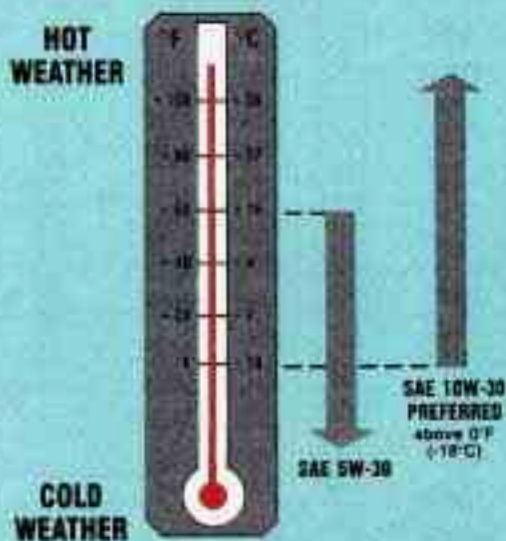

IF NEITHER SAE 5W-30 NOR SAE 10W-30 GRADE OILS ARE AVAILABLE, SAE 30 GRADE MAY BE USED AT TEMPERATURES ABOVE 40 DEGREES F (4 DEGREES C).

DO NOT USE SAE 10W-40, SAE 20W-50 OR ANY OTHER GRADE OIL NOT RECOMMENDED.

- **Energy Conserving II**

Oils with these words on the container will help you save fuel.

This doughnut-shaped logo (symbol) is used on most oil containers to help you select the correct oil.

You should look for this on the oil container, and use **only** those oils that display the logo.

GM Goodwrench® Oil (in Canada, GM Engine Oil) meets all the requirements for your vehicle.

Engine Oil Additives

Don't add anything to your oil. Your Pontiac dealer is ready to advise if you think something should be added.

When to Change Engine Oil

See if any one of these is true for you:

- Most trips are less than 4 miles (6 km).
- It's below freezing outside and most trips are less than 10 miles (16 km).
- The engine is at low speed most of the time (as in door-to-door delivery, or in stop-and-go traffic).
- You tow a trailer often.
- Most trips are through dusty places.

If any one of these is true for your vehicle, then you need to change your **oil and filter** every 3,000 miles (5 000 km) or 3 months—whichever comes first. (See the *Index* under *Check Oil Light*.)

If none of them is true, change the oil every 7,500 miles (12 500 km) or 12 months—whichever comes first. Change the filter at the first oil change and at every other oil change after that.

Engine Block Heater

An engine block heater can be a big help if you have to park outside in very cold weather, 0°F (-18°C) or colder. If your vehicle has this option, see the *Index* under *Engine Block Heater*.

Service & Appearance Care

What to Do with Used Oil

CAUTION

 Used engine oil contains things that have caused skin cancer in laboratory animals. Don't let used oil stay on your skin for very long. Clean your skin and nails with soap and water, or a good hand cleaner. Wash or properly throw away clothing or rags containing used engine oil.

Used oil can be a real threat to the environment.

If you change your own oil, be sure to drain all free-flowing oil from the filter before disposal.

Don't ever dispose of oil by pouring it on the ground, into sewers, or into streams or bodies of water. Instead, recycle it by taking it to a place that collects used oil. If you have a problem properly disposing of your used oil, ask your dealer, a service station or a local recycling center for help.

Air Cleaner

Refer to the Maintenance Schedule to determine when to replace the air filter. See the *Index* under *Scheduled Maintenance Services*.

CAUTION

 Operating the engine with the air cleaner off can cause you or others to be burned. The air cleaner not only cleans the air, it stops flame if the engine backfires. If it isn't there, and the engine backfires, you could be burned. Don't drive with it off, and be careful working on the engine with the air cleaner off.

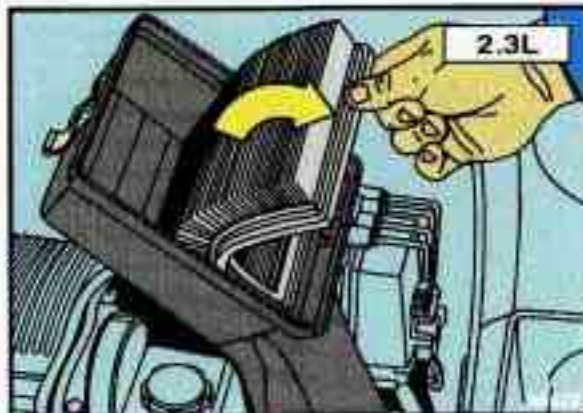
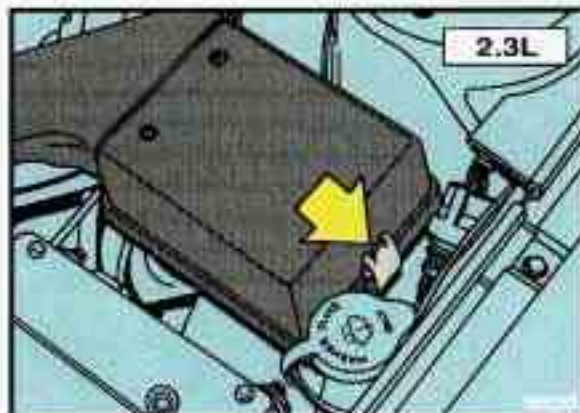

NOTICE

If the air cleaner is off, a backfire can cause a damaging engine fire. And, dirt can easily get into your engine, which will damage it. Always have the air cleaner in place when you're driving.

2.3L Quad OHC and Quad 4: Air Filter Replacement

1. Unsnap the clip on the housing cover and pull the cover back.
2. Remove the air cleaner filter.
3. Be sure to install the air cleaner filter and replace the cover tightly.

Service & Appearance Care

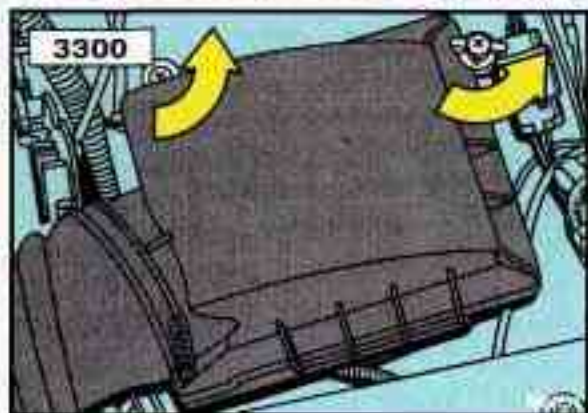

Air Cleaner (CONT.)

3300 V6: Air Filter Replacement

1. Unscrew the two wing nuts, then slide the cover forward and up.



2. Remove the air cleaner.
3. Be sure to install the air cleaner filter and replace the cover.

Automatic Transaxle Fluid

When to Check and Change:

A good time to check your automatic transaxle fluid level is when the engine oil is changed. Refer to the Maintenance Schedule to determine when to change your fluid. See the *Index* under *Scheduled Maintenance Services*.

How to Check:

Because this operation can be a little difficult, you may choose to have this done at a Pontiac dealership Service Department.

If you do it yourself, be sure to follow all the instructions here, or you could get a false reading on the dipstick.

NOTICE

Too much or too little fluid can damage your transaxle. Too much can mean that some of the fluid could come out and fall on hot engine parts, starting a fire. Be sure to get an accurate reading if you check your transaxle fluid.

Wait at least 30 minutes before checking the transaxle fluid level if you have been driving:

- When outside temperatures are above 90°F (32°C).
- At high speed for quite a while.
- In heavy traffic—especially in hot weather.
- While pulling a trailer.

To get the right reading, the fluid should be at normal operating temperature, which is 180°F to 200°F (82°C to 93°C).

Get the vehicle warmed up by driving about 15 miles (24 km) when outside temperatures are above 50°F (10°C). If it's colder than 50°F (10°C), you may have to drive longer.

To Check the Fluid Level:

- Park your vehicle on a level place.
- Place the shift lever in **P** (Park) with the parking brake applied.
- With your foot on the brake pedal, move the shift lever through each gear range, pausing for about three seconds in each range. Then, position the shift lever in **P** (Park).
- Let the engine run at idle for three to five minutes.

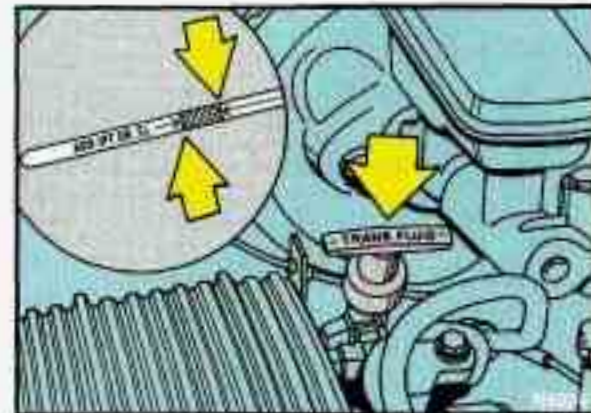

Then, Without Shutting Off the Engine, Follow These Steps:

1. Pull out the dipstick and wipe it with a clean rag or paper towel.
2. Push it back in all the way, wait three seconds and then pull it back out again.
3. Check both sides of the dipstick, and read the lower level. The fluid level must be in the cross-hatched area.
4. If the fluid level is where it should be, push the dipstick back in all the way.

Service & Appearance Care

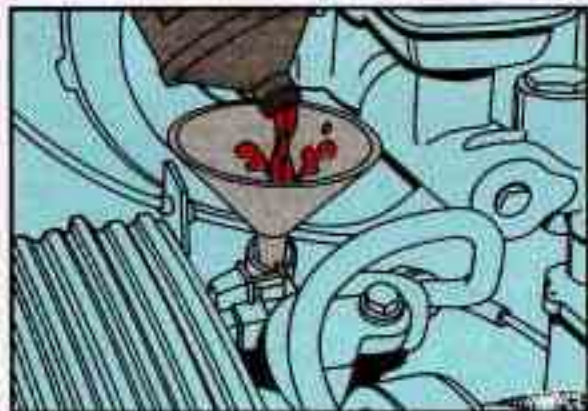

Automatic Transaxle Fluid (CONT.)

How To Add Fluid:

Refer to the Maintenance Schedule to determine what kind of transaxle fluid to use. See the *Index* under *Fluids & Lubricants*.

If the fluid level is low, add only enough of the proper fluid to bring the level into the cross-hatched area on the dipstick.

It doesn't take much fluid, generally less than a pint. Don't overfill.

We recommend you use only fluid labeled DEXRON[®]-III, because fluids with that label are made especially for your automatic transaxle. Damage caused by fluid other than DEXRON[®]-III is not covered by your new vehicle warranty.

After adding fluid, recheck the fluid level as described under *How to Check*.

When the correct fluid level is obtained, push the dipstick back in all the way.

Manual Transaxle Fluid

When to Check:

A good time to have it checked is when the engine oil is changed. However, the fluid in your manual transaxle doesn't require changing.

How to Check:

Because this operation can be a little difficult, you may choose to have this done at a Pontiac dealership Service Department.

If you do it yourself, be sure to follow all the instructions here, or you could get a false reading on the dipstick.

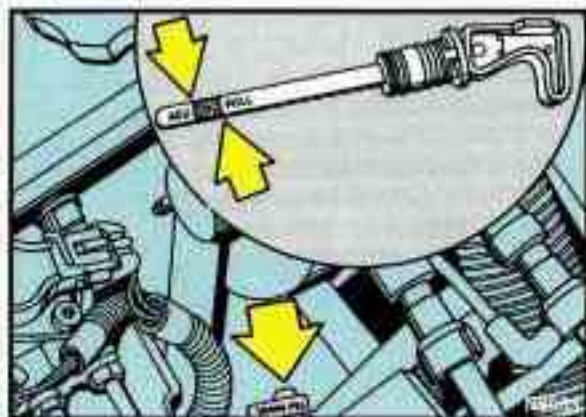

NOTICE

Too much or too little fluid can damage your transaxle. Too much can mean that some of the fluid could come out and fall on hot engine parts, starting a fire. Be sure to get an accurate reading if you check your transaxle fluid.

Check the fluid level only when your engine is off, the vehicle is parked on a level place and the transaxle is cool enough for you to rest your fingers on the transaxle case.

Then, Follow These Steps:

1. Flip the handle up and then pull out the dipstick and clean it with a rag or paper towel.
2. Push it back in all the way and remove it.
3. Check both sides of the dipstick and read the lower level. The fluid level must be between the **ADD** and **FULL** marks. (Note: Fluid may appear at the bottom of the dipstick even when the fluid level is several pints low.)
4. If the fluid level is where it should be, push the dipstick back in all the way.
5. Be sure to push the handle down fully.

Service & Appearance Care

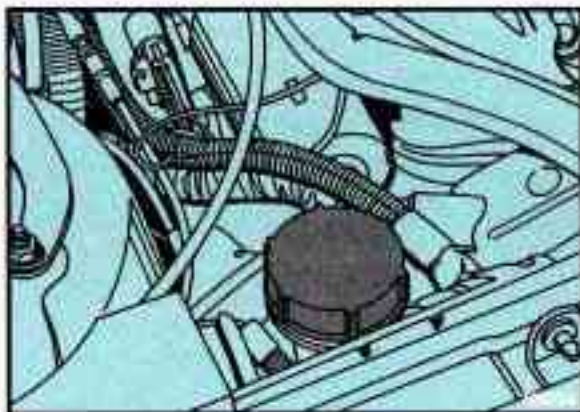

Manual Transaxle Fluid (CONT.)

How to Add Fluid:

Here's how to add fluid. Refer to the Maintenance Schedule to determine what kind of fluid to use. See the *Index* under *Fluids & Lubricants*.

1. Remove the dipstick by flipping the handle up and then pulling the dipstick out.
2. Add fluid at the dipstick hole.
Add only enough fluid to bring the fluid level up to the **FULL** mark on the dipstick.
3. Push the dipstick back in all the way; then flip the handle down to lock the dipstick in place.

Hydraulic Clutch (MANUAL TRANSAXLE)

The hydraulic clutch in your vehicle is self-adjusting.

When to Check and What to Use:

Refer to the Maintenance Schedule to determine how often you should check the fluid level in your clutch master cylinder reservoir and what to add. See the *Index* under *Fluids & Lubricants*.

How to Check:

The proper fluid should be added if the level is at or below the **STEP** mark on the reservoir cap. See the instructions on the reservoir cap.

Engine Coolant

The following explains your cooling system and how to add coolant when it is low. If you have a problem with engine overheating, see the *Index* under *Engine Overheating*.

The proper coolant for your Pontiac will:

- Give freezing protection down to -34°F (-37°C).
- Give boiling protection up to 262°F (128°C).
- Protect against rust and corrosion.
- Help keep the proper engine temperature.
- Let the warning lights work as they should.

What to Use:

Use a mixture of one-half **clean water** (preferably distilled) and one-half antifreeze that meets "GM Specification 1825-M," which won't damage aluminum parts. You can also use a recycled coolant conforming to GM Specification 1825-M with a complete coolant flush and refill. If you use this mixture, you don't need to add anything else.

CAUTION



Adding only plain water to your cooling system can be dangerous. Plain water, or some other liquid like alcohol, can boil before the proper coolant mix will. Your vehicle's coolant warning system is set for the proper coolant mix. With plain water or the wrong mix, your engine could get too hot but you wouldn't get the overheat warning. Your engine could catch fire and you or others could be burned. Use a 50/50 mix of clean water and a proper antifreeze.

Service & Appearance Care

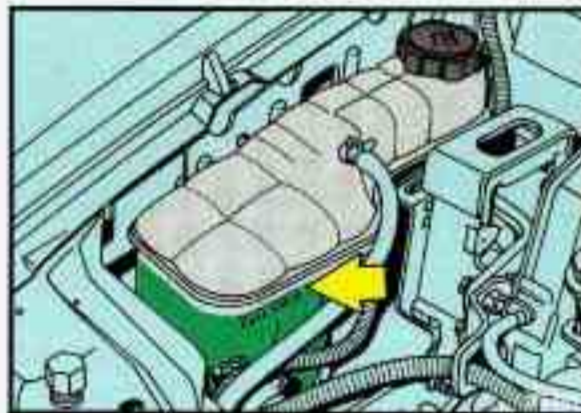

Engine Coolant (CONT.)

NOTICE

If you use an improper coolant mix, your engine could overheat and be badly damaged. The repair cost wouldn't be covered by your warranty. Too much water in the mix can freeze and crack the engine, radiator, heater core and other parts.

Adding Coolant

To Check Coolant:

When your engine is cold, the coolant level should be at **FULL COLD**, or a little higher.

To Add Coolant:

If you need more coolant, add the proper mix **at the surge tank**, but only when the engine is cool.

CAUTION

 Turning the surge tank pressure cap when the engine and radiator are hot can allow steam and scalding liquids to blow out and burn you badly. Never turn the surge tank pressure cap—even a little—when the engine and radiator are hot.



CAUTION



You can be burned if you spill coolant on hot engine parts. Coolant contains ethylene glycol, and it will burn if the engine parts are hot enough. Don't spill coolant on a hot engine.

Surge Tank Pressure Cap

NOTICE

Your surge tank pressure cap is an 18 psi (124 kPa) pressure-type cap and must be tightly installed to prevent coolant loss and possible engine damage from overheating.

When you replace your surge tank pressure cap, a GM cap is recommended.

Thermostat

Engine coolant temperature is controlled by a thermostat in the engine coolant system. The thermostat stops the flow of coolant through the radiator until the coolant reaches a preset temperature.

When you replace your thermostat, an AC® thermostat is recommended.

Service & Appearance Care

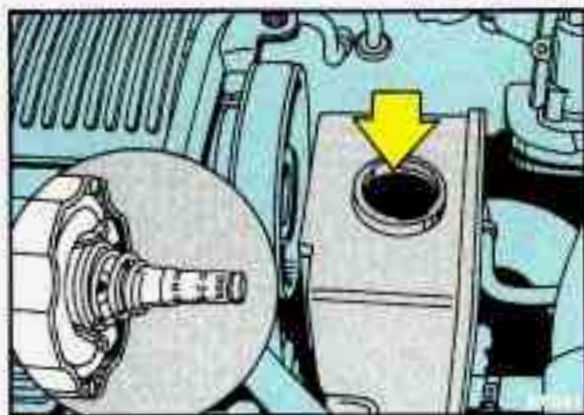

Power Steering Fluid

How to Check Power Steering Fluid:

Unscrew the cap and wipe the dipstick with a clean rag. Replace the cap and completely tighten it. Then remove the cap again and look at the fluid level on the dipstick.

- When the engine compartment is hot, the level should be at the **H** (Hot) mark.
- When the engine compartment is cool, the level should be at the **C** (Cold) mark.

What to Add:

Refer to the Maintenance Schedule to determine what kind of fluid to use. See the *Index* under *Fluids & Lubricants*.

NOTICE

When adding power steering fluid or making a complete fluid change, always use the proper fluid. Failure to use the proper fluid can cause leaks and damage hoses and seals.



Windshield Washer Fluid

To Add:

Open the cap labeled **WASHER FLUID ONLY**.

Add washer fluid until the bottle is full.

NOTICE

- When using concentrated washer fluid, follow the manufacturer's instructions for adding water.
- Don't mix water with ready-to-use washer fluid. Water can cause the solution to freeze and damage your washer fluid tank and other parts of the washer system. Also, water doesn't clean as well as washer fluid.
- Fill your washer fluid tank only $\frac{3}{4}$ full when it's very cold. This allows for expansion, which could damage the tank if it is completely full.
- Don't use radiator antifreeze in your windshield washer. It can damage your washer system and paint.



Brake Master Cylinder

Your brake master cylinder is here. It is filled with DOT-3 brake fluid.

There are only two reasons why the brake fluid level in your master cylinder might go down. The first is that the brake fluid goes down to an acceptable level during normal brake lining wear. When new linings are put in, the fluid level goes back up.

The other reason is that fluid is leaking out of the brake system. If it is, you should have your brake system fixed, since a leak means that sooner or later your brakes won't work well, or won't work at all.

So, it isn't a good idea to "top off" your brake fluid. Adding brake fluid won't correct a leak. If you add fluid when your linings are worn, then you'll have too much fluid when you get new brake linings. You should add (or remove) brake fluid, as necessary, only when work is done on the brake hydraulic system.

Service & Appearance Care

Brake Master Cylinder (CONT.)

CAUTION



If you have too much brake fluid, it can spill on the engine. The fluid will burn if the engine is hot enough. You or others could be burned, and your vehicle could be damaged. Add brake fluid only when work is done on the brake hydraulic system.

When your brake fluid falls to a low level, your brake warning light will come on. See the *Index* under *Brake System Warning Light*.

What to Add:

When you do need brake fluid, use only DOT-3 brake fluid—such as Delco Supreme II® (GM Part No. 1052535). Use new brake fluid from a sealed container only.

NOTICE

- DOT-5 silicone brake fluid can damage your vehicle. Don't use it.
- Don't let someone put in the wrong kind of fluid. For example, just a few drops of mineral-based oil, such as engine oil, in your brake system can damage brake system parts so badly that they'll have to be replaced.
- Brake fluid can damage paint, so be careful not to spill brake fluid on your vehicle.

Replacing Brake System Parts

The braking system on a modern vehicle is complex. Its many parts have to be of top quality and work well together if the vehicle is to have really good braking. Vehicles we design and test have top-quality GM brake parts in them, as your Pontiac does when it is new. When you replace parts of your braking system—for example, when your brake linings wear down and you have to have new ones put in—be sure you get new genuine GM replacement parts. If you don't, your brakes may no longer work properly. For example, if someone puts in brake linings that are wrong for your vehicle, the balance between your front and rear brakes can change, for the worse. The braking performance you've come to expect can change in many other ways if someone puts in the wrong replacement brake parts.

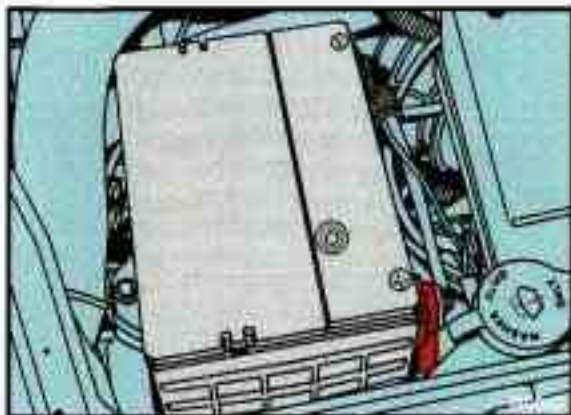

Battery

Every new Pontiac has a Delco Freedom[®] battery. You never have to add water to one of these. When it's time for a new battery, we recommend a Delco Freedom[®] battery. Get one that has the catalog number shown on the original battery's label.

Jump Starting

For jump starting instructions, see the *Index* under *Jump Starting*.

Vehicle Storage

If you're not going to drive your vehicle for 25 days or more, take off the black negative (-) cable from the battery. This will help keep your battery from running down.

CAUTION

 Batteries have acid that can burn you and gas that can explode. You can be badly hurt if you aren't careful. See the *Index* under *Jump Starting* for tips on working around a battery without getting hurt.

Contact your dealer to learn how to prepare your vehicle for longer storage periods.

Halogen Bulbs

CAUTION

 Halogen bulbs have pressurized gas inside and can burst if you drop or scratch the bulb. You or others could be injured. Take special care when handling and disposing of halogen bulbs.

Service & Appearance Care

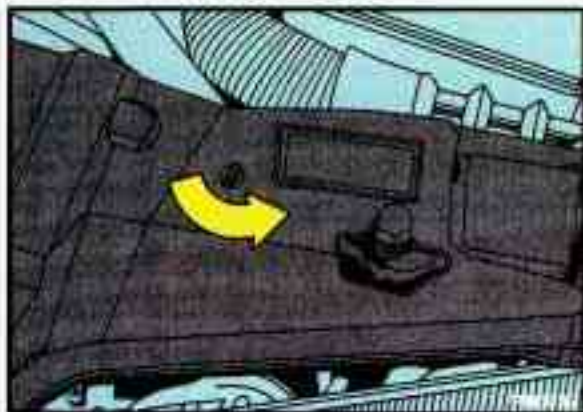

Headlight Bulb Replacement

For the type of bulb, see the *Index* under *Replacement Bulbs*.

1. On the driver's side only, unscrew the butterfly fastener. Then lift the plate.

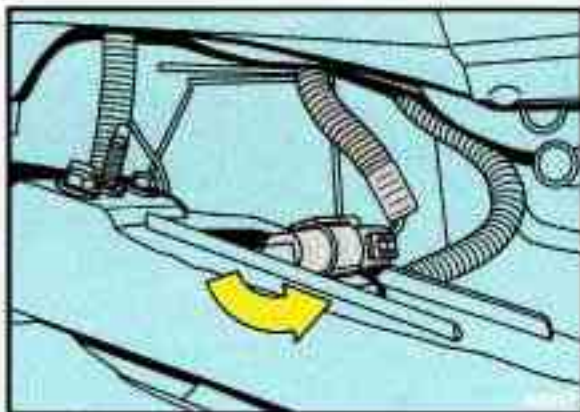

Both Sides:

2. Twist the bulb assembly counter-clockwise $\frac{1}{8}$ turn and pull out the bulb assembly.

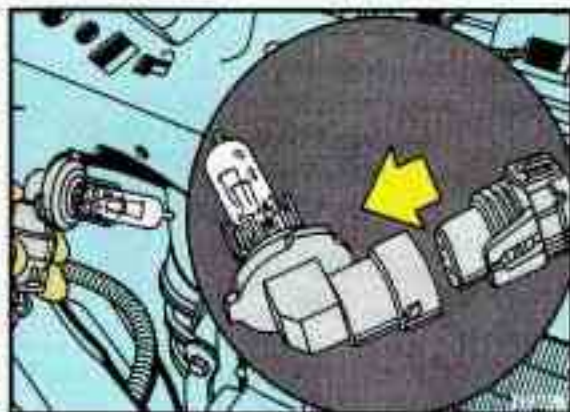

3. Unclip the bulb assembly from the wiring harness.
4. Reverse steps 1-3 to replace the bulb assembly and headlight housing.

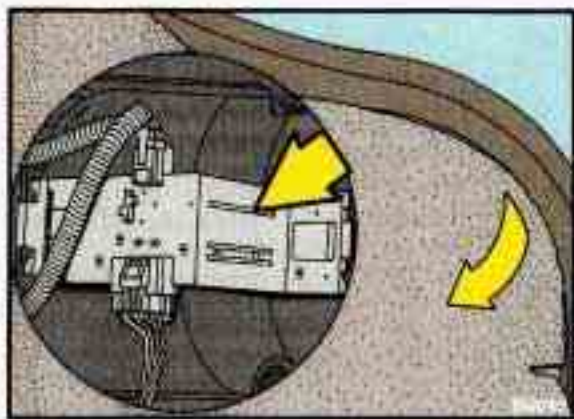

Taillight Bulb Replacement

For the type of bulb, see the *Index* under *Replacement Bulbs*.

1. Pull back the trunk trim.
2. Carefully push one end of the plastic taillight brace in while pulling the brace toward the front of the vehicle.

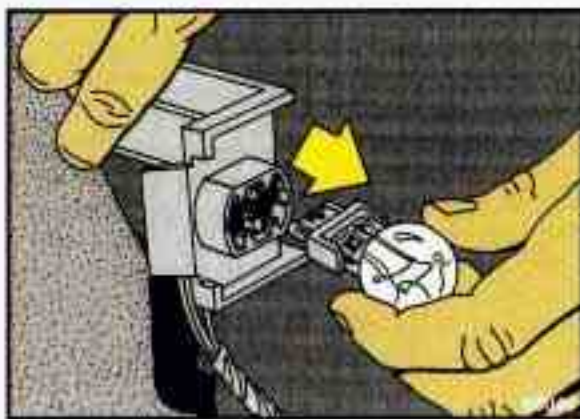

3. Gently wiggle the bulb out of the socket.
4. Replace the bulb.
5. Reverse the steps to reassemble the taillight.

Fog Light Bulb Replacement

Don't change your fog light bulbs unless you have the proper aiming equipment. See your Pontiac dealer if you have any further questions.

Service & Appearance Care

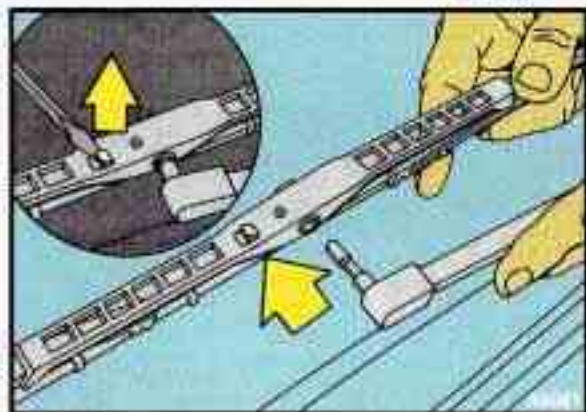

Windshield Wiper Blade Replacement

Replacement blades come in different types and are removed in different ways. Here's how to remove the type with a release clip:

1. Pull the windshield wiper arm away from the windshield.
2. Lift the release clip with a screwdriver and pull the blade assembly off the wiper arm.
3. Push the new wiper blade securely on the wiper arm.



Loading Your Vehicle

Two labels on your vehicle show how much weight it may properly carry. The Tire-Loading Information label found on the rear edge of the driver's door tells you the proper size, speed rating and recommended inflation pressures for the tires on your vehicle. It also gives you important information about the number of people that can be in your vehicle and the total weight that you can carry. This weight is called the Vehicle Capacity Weight and includes the weight of all occupants, cargo, and all nonfactory-installed options.

The other label is the Certification sticker, also on the rear edge of the driver's door. It tells you the gross weight capacity of your vehicle, called the GVWR (Gross Vehicle Weight Rating). The GVWR includes the weight of the vehicle, all occupants, fuel and cargo. Never exceed the GVWR for your vehicle, or the Gross Axle Weight Rating (GAWR) for either the front or rear axle.

And, if you do have a heavy load, you should spread it out. Don't carry more than 132 lbs. (60 kg) in your trunk.

CAUTION

 Do not load your vehicle any heavier than the GVWR or the maximum front and rear GAWRs. If you do, parts on your vehicle can break, or it can change the way your vehicle handles. These could cause you to lose control. Also, overloading can shorten the life of your vehicle.

NOTICE

Your warranty does not cover parts or components that fail because of overloading.

If you put things inside your vehicle—like suitcases, tools, packages, or anything else—they will go as fast as the vehicle goes. If you have to stop or turn quickly, or if there is a crash, they'll keep going.

CAUTION

 Things you put inside your vehicle can strike and injure people in a sudden stop or turn, or in a crash.

- Put things in the trunk of your vehicle. In a trunk, put them as far forward as you can.
- Try to spread the weight evenly.
- Never stack heavier things, like suitcases, inside the vehicle so that some of them are above the tops of the seats.
- When you carry something inside the vehicle, secure it whenever you can.
- Don't leave a seat folded down unless you need to.

Service & Appearance Care

■ Tires

We don't make tires. Your new vehicle comes with high quality tires made by a leading tire manufacturer. These tires are warranted by the tire manufacturers and their warranties are delivered with every new Pontiac. If your spare tire is a different brand than your road tires, you will have a tire warranty folder from each of these manufacturers.

CAUTION



Poorly maintained and improperly used tires are dangerous.

- Overloading your tires can cause overheating as a result of too much friction. You could have an air-out and a serious accident. See the *Index* under *Loading Your Vehicle*.
- Underinflated tires pose the same danger as overloaded tires. The resulting accident could cause serious injury. Check all tires frequently to maintain the recommended pressure. Tire pressure should be checked when your tires are cold.
- Overinflated tires are more likely to be cut, punctured, or broken by a sudden impact, such as when you hit a pothole. Keep tires at the recommended pressure.
- Worn, old tires can cause accidents. If your tread is badly worn, or if your tires have been damaged, replace them.

Inflation—Tire Pressure

The Tire-Loading Information label which is on the rear edge of the driver's door shows the correct inflation pressures for your tires, when they're cold. "Cold" means your vehicle has been sitting for at least three hours or driven no more than a mile.

NOTICE

Don't let anyone tell you that underinflation or overinflation is all right. It's not. If your tires don't have enough air (underinflation), you can get:

- Too much flexing
- Too much heat
- Tire overloading
- Bad wear
- Bad handling
- Bad fuel economy.

If your tires have too much air (overinflation), you can get:

- Unusual wear
- Bad handling
- Rough ride
- Needless damage from road hazards.

When to Check:

Check your tires once a month or more. Don't forget your compact spare tire. It should be at 60 psi (420 kPa).

How to Check:

Use a good quality pocket-type gage to check tire pressure. Simply looking at the tires will not tell you the pressure, especially if you have radial tires—which may look properly inflated even if they're underinflated.

If your tires have valve caps, be sure to put them back on. They help prevent leaks by keeping out dirt and moisture.

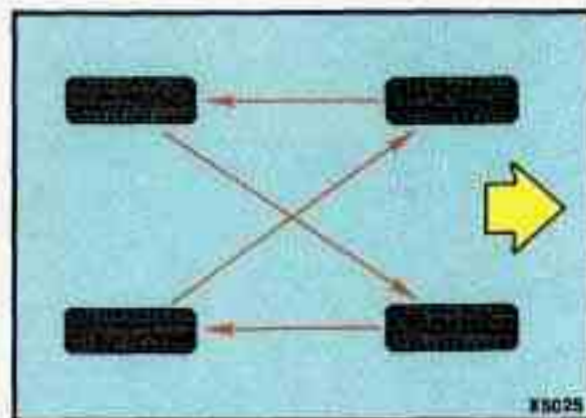

Tire Inspection and Rotation

To make your tires last longer, have them inspected and rotated at the mileages recommended in the Maintenance Schedule. See the *Index* under *Scheduled Maintenance Services*.

Use this rotation pattern.

After the tires have been rotated, adjust the front and rear inflation pressure as shown on the Tire-Loading Information label. Make certain that all wheel nuts are properly tightened. See the *Index* under *Wheel Nut Torque*.

Service & Appearance Care

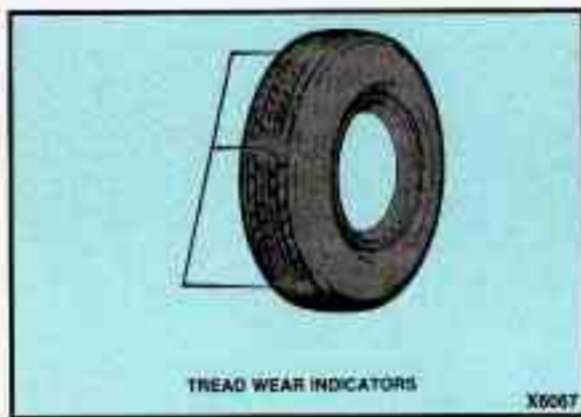

Tire Inspection and Rotation (CONT.)

CAUTION

 Rust or dirt on a wheel, or on the parts to which it is fastened, can make wheel nuts become loose after a time. The wheel could come off and cause an accident. When you change a wheel, remove any rust or dirt from places where the wheel attaches to the vehicle. In an emergency, you can use a cloth or a paper towel to do this; but be sure to use a scraper or wire brush later, if you need to, to get all the rust or dirt off. (See the *Index* under *Changing a Flat Tire.*)

When It's Time for New Tires

One way to tell when it's time for new tires is to check the treadwear indicators, which will appear when your tires have only 2/32 inch (1.6 mm) or less of tread remaining.

You need a new tire if:

- You can see the indicators at three places around the tire.
- You can see cord or fabric showing through the tire's rubber.
- The tread or sidewall is cracked, cut, or snagged deep enough to show cord or fabric.
- The tire has a bump, bulge or split.
- The tire has a puncture, cut, or other damage that can't be repaired well because of the size or location of the damage.

Buying New Tires

To find out what kind and size of tires you need, look at the Tire-Loading Information label.

The tires installed on your vehicle when it was new had a Tire Performance Criteria Specification (TPC Spec) number on each tire's sidewall. When you get new tires, get ones with that same TPC Spec number. That way, your vehicle will continue to have tires that are designed to give proper endurance, handling, speed rating, traction, ride and other things during normal service on your vehicle. If your tires have an all-season tread design, the TPC number will be followed by a "MS" (for mud and snow).

If you ever replace your tires with those not having a TPC Spec number, make sure they are the same size, load range, speed rating and construction type (bias, bias-belted or radial) as your original tires.

CAUTION



Mixing tires could cause you to lose control while driving.

If you mix tires of different sizes or types (radial and bias-belted tires), the vehicle may not handle properly, and you could have a crash. Be sure to use the same size and type tires on all wheels.

It's all right to drive with your compact spare, though. It was developed for limited use on your vehicle.

■ *Uniform Tire Quality Grading*

The following information relates to the system developed by the United States National Highway Traffic Safety Administration which grades tires by treadwear, traction and temperature performance. (This applies only to vehicles sold in the United States.)

Treadwear

The treadwear grade is a comparative rating based on the wear rate of the tire when tested under controlled conditions on a specified government test course. For example, a tire graded 150 would wear one and a half (1½) times as well on the government course as a tire graded 100. The relative performance of tires depends upon the actual conditions of their use, however, and may depart significantly from the norm due to variations in driving habits, service practices and differences in road characteristics and climate.

Service & Appearance Care

Traction—A, B, C

The traction grades, from highest to lowest are: A, B, and C. They represent the tire's ability to stop on wet pavement as measured under controlled conditions on specified government test surfaces of asphalt and concrete. A tire marked C may have poor traction performance.

Warning: The traction grade assigned to this tire is based on braking (straight-ahead) traction tests and does not include cornering (turning) traction.

Temperature—A, B, C

The temperature grades are A (the highest), B, and C, representing the tire's resistance to the generation of heat and its ability to dissipate heat when tested under controlled conditions on a specified indoor laboratory test wheel. Sustained high temperature can cause the material of the tire to degenerate and reduce tire life, and excessive temperature can lead to sudden tire failure. The grade C corresponds to a level of performance which all passenger car tires must meet under the Federal Motor Vehicle Safety Standard No. 109. Grades B and A represent higher levels of performance on the laboratory test wheel than the minimum required by law.

Warning: The temperature grade for this tire is established for a tire that is properly inflated and not overloaded. Excessive speed, underinflation, or excessive loading, either separately or in combination, can cause heat buildup and possible tire failure.

Those grades are molded on the sidewalls of passenger car tires.

While the tires available as standard or optional equipment on General Motors vehicles may vary with respect to these grades, all such tires meet General Motors performance standards and have been approved for use on General Motors vehicles. All passenger type (P Metric) tires must conform to Federal safety requirements in addition to these grades.

Wheel Alignment and Tire Balance

The wheels on your vehicle were aligned and balanced carefully at the factory to give you the longest tire life and best overall performance.

In most cases, you will not need to have your wheels aligned again. However, if you notice unusual tire wear or your vehicle pulling one way or the other, the alignment may need to be reset. If you notice your vehicle vibrating when driving on a smooth road, your wheels may need to be rebalanced.

Wheel Replacement

Replace any wheel that is bent, cracked or badly rusted. If wheel nuts keep coming loose, the wheel, wheel bolts, and wheel nuts should be replaced. If the wheel leaks air out, replace it (except some aluminum wheels, which can sometimes be repaired). See your Pontiac dealer if any of these conditions exist.

Your dealer will know the kind of wheel you need.

Each new wheel should have the same load carrying capacity, diameter, width, offset, and be mounted the same way as the one it replaces.

If you need to replace any of your wheels, wheel bolts, or wheel nuts, replace them only with new GM original equipment parts. This way, you will be sure to have the right wheel, wheel bolts, and wheel nuts for your Pontiac model.

CAUTION



Using the wrong replacement wheels, wheel bolts, or wheel nuts on your vehicle can be dangerous. It could affect the braking and handling of your vehicle, make your tires lose air and make you lose control. You could have a collision in which you or others could be injured. Always use the correct wheel, wheel bolts, and wheel nuts for replacement.

Service & Appearance Care

Wheel Replacement (CONT.)

NOTICE

The wrong wheel can also cause problems with bearing life, brake cooling, speedometer/odometer calibration, headlight aim, bumper height, vehicle ground clearance, and tire or tire chain clearance to the body and chassis.

Used Replacement Wheels

CAUTION

 Putting a used wheel on your vehicle is dangerous. You can't know how it's been used or how many miles it's been driven. It could fail suddenly and cause an accident. If you have to replace a wheel, use a **new** GM original equipment wheel.

Tire Chains

NOTICE

If your Pontiac has P195/70R14, P195/65R15 or P205/55R16 size tires, don't use tire chains; they can damage your vehicle.

If you have other tires, use tire chains only when you must. Use only SAE Class "S" type chains that are the proper size for your tires. Install them on the front tires and tighten them as tightly as possible with the ends securely fastened. Drive slowly and follow the chain manufacturer's instructions. If you can hear the chains contacting your vehicle, stop and retighten them. If the contact continues, slow down until it stops. Driving too fast with chains on will damage your vehicle.



■ Appearance Care

CAUTION

 Cleaning products can be hazardous. Some are toxic. Others can burst into flame if you strike a match or get them on a hot part of the vehicle. Some are dangerous if you breathe their fumes in a closed space. When you use anything in a container to clean your Pontiac, be sure to follow the instructions. And always open your doors or windows when you're cleaning the inside.

Never use these to clean your vehicle:

- Gasoline
- Benzene
- Naphtha
- Carbon Tetrachloride
- Acetone
- Paint Thinner
- Turpentine
- Lacquer Thinner
- Nail Polish Remover

They can all be hazardous—some more than others—and they can all damage your vehicle, too.

NOTICE

Don't use any of these unless this manual says you can. In many uses, they will damage your vehicle:

- Laundry Soap
- Bleach
- Reducing Agents

Service & Appearance Care

Cleaning the Inside of Your Pontiac

Use a vacuum cleaner often to get rid of dust and loose dirt. Wipe vinyl with a clean, damp cloth.

Your Pontiac dealer has two GM cleaners—a solvent-type spot lifter and a foam-type powdered cleaner. They will clean normal spots and stains very well.

Here are some cleaning tips:

- Always read the instructions on the cleaner label.
- Clean up stains as soon as you can—before they set.
- Use a clean cloth or sponge, and change to a clean area often. A soft brush may be used if stains are stubborn.

- Use solvent-type cleaners in a well-ventilated area only. If you use them, don't saturate the stained area.
- If a ring forms after spot cleaning, clean the entire area immediately or it will set.

Using Foam-Type Cleaner on Fabric

- Vacuum and brush the area to remove any loose dirt.
- Always clean a whole trim panel or section. Mask surrounding trim along stitch or welt lines.
- Mix Multi-Purpose Powdered Cleaner following the directions on the container label.
- Use suds only and apply with a clean sponge.

- Don't saturate the material.
- Don't rub it roughly.
- As soon as you've cleaned the section, use a sponge to remove the suds.
- Rinse the section with a clean, wet sponge.
- Wipe off what's left with a slightly damp paper towel or cloth.
- Then dry it immediately with an air hose, a hair dryer or a heat lamp.

NOTICE

Be careful with a hair dryer or heat lamp. You could scorch the fabric.

- Wipe with a clean cloth.

Using Solvent-Type Cleaner on Fabric

First, see if you have to use solvent-type cleaner at all. Some spots and stains will clean off better with just water and mild soap.

If you need to use it, then:

- Gently scrape excess soil from the trim material with a clean, dull knife or scraper. Use very little cleaner, light pressure and clean cloths (preferably cheesecloth). Cleaning should start at the outside of the stain, "feathering" toward the center. Keep changing to a clean section of the cloth.
- When you clean a stain from fabric, immediately dry the area with an air hose, hair dryer, or heat lamp to help prevent a cleaning ring. (See previous NOTICE.)

Special Cleaning Problems

Greasy or Oily Stains: Like grease, oil, butter, margarine, shoe polish, coffee with cream, chewing gum, cosmetic creams, vegetable oils, wax crayon, tar and asphalt.

- Carefully scrape off excess stain.
- Then follow the solvent-type instructions earlier in this section.
- Shoe polish, wax crayon, tar and asphalt will stain if left on a vehicle seat fabric. They should be removed as soon as possible. Be careful, because the cleaner will dissolve them and may cause them to bleed.

Non-Greasy Stains: Like catsup, coffee (black), egg, fruit, fruit juice, milk, soft drinks, wine, vomit, urine and blood.

- Carefully scrape off excess stain, then sponge the soiled area with cool water.

- If a stain remains, follow the foam-type instructions earlier in this section.
- If an odor lingers after cleaning vomit or urine, treat the area with a water/baking soda solution: 1 teaspoon (5 ml) of baking soda to 1 cup (250 ml) of lukewarm water.
- Finally, if needed, clean lightly with solvent-type cleaner.

Combination Stains: Like candy, ice cream, mayonnaise, chili sauce and unknown stains.

- Carefully scrape off excess stain, then clean with cool water and allow to dry.
- If a stain remains, clean it with solvent-type cleaner.

Service & Appearance Care

Cleaning Vinyl

Just use warm water and a clean cloth.

- Rub with a clean, damp cloth to remove dirt. You may have to do it more than once.
- Things like tar, asphalt and shoe polish will stain if you don't get them off quickly. Use a clean cloth and solvent-type vinyl/leather cleaner.

Cleaning the Top of the Instrument Panel

Use only mild soap and water to clean the top surfaces of the instrument panel. Sprays containing silicones or waxes may cause annoying reflections in the windshield and even make it difficult to see through the windshield under certain conditions.

Care of Safety Belts

Keep belts clean and dry.

CAUTION



Do not bleach or dye safety belts. If you do, it may severely weaken them. In a crash they might not be able to provide adequate protection. Clean safety belts only with mild soap and lukewarm water.

Glass

Glass should be cleaned often. GM Glass Cleaner (GM Part No. 1050427) or a liquid household glass cleaner will remove normal tobacco smoke and dust films.

Don't use abrasive cleaners on glass, because they may cause scratches. Avoid placing decals on the inside rear window, since they may have to be scraped off later.

If abrasive cleaners are used on the inside of the rear window, an electric defogger element may be damaged. Any temporary license should not be attached across the defogger grid.

Cleaning the Outside of the Windshield and Wiper Blades

If the windshield is not clear after using the windshield washer, or if the wiper blade chatters when running, wax or other material may be on the blade or windshield.

Clean the outside of the windshield with GM Windshield Cleaner, Bon-Ami Powder® (GM Part No. 1050011). The windshield is clean if beads do not form when you rinse it with water.

Clean the blade by wiping vigorously with a cloth soaked in full strength windshield washer solvent. Then rinse the blade with water.

Wiper blades should be checked on a regular basis and replaced when worn.

Cleaning the Outside of Your Pontiac

The paint finish on your vehicle provides beauty, depth of color, gloss retention and durability.

Washing Your Vehicle

The best way to preserve your vehicle's finish is to keep it clean by washing it often with lukewarm or cold water.

Don't wash your vehicle in the direct rays of the sun. Don't use strong soaps or chemical detergents. Use liquid hand,

Service & Appearance Care

Cleaning the Outside of Your Pontiac (CONT.)

dish or car washing (non-detergent) soaps. Don't use cleaning agents that contain acid or abrasives. All cleaning agents should be flushed promptly and not allowed to dry on the surface, or they could stain. Dry the finish with a soft, clean chamois or a 100% cotton towel to avoid surface scratches and water spotting.

High pressure vehicle washes may cause water to enter your vehicle.

Finish Care

Occasional waxing or mild polishing of your Pontiac may be necessary to remove residue from the paint finish. You can get GM approved cleaning products from your dealer. (See the *Index* under *Appearance Care*.)

Your Pontiac has a "basecoat/clearcoat" paint finish. The clearcoat gives more depth and gloss to the colored basecoat.

NOTICE

Machine compounding or aggressive polishing on a basecoat/clearcoat paint finish may dull the finish or leave swirl marks.

Aluminum Wheels

If your Pontiac has these, don't use chrome polish on them. Use wax after you clean them. Also, don't use abrasive cleaners or cleaning brushes on them—you could damage the protective coating.

NOTICE

If you have aluminum wheels, don't use an automatic vehicle wash that has hard silicon carbide cleaning brushes. These brushes can take off the protective coating.

White Sidewall Tires

Your Pontiac dealer has a GM White Sidewall Tire Cleaner. You can use a stiff brush with it.

Weatherstrips

These are places where glass or metal meets rubber. Silicone grease there will make them last longer, seal better, and not squeak. Apply silicone grease with a clean cloth at least every six months.

Sheet Metal Damage

If your vehicle is damaged and requires sheet metal repair or replacement, make sure the body repair shop applies anti-corrosion material to the parts repaired or replaced to restore corrosion protection.

Foreign Material

Calcium chloride and other salts, ice melting agents, road oil and tar, tree sap, bird droppings, chemicals from industrial chimneys, and other foreign matter can damage your vehicle's finish if they remain on painted surfaces. Use cleaners that are marked safe for painted surfaces for these stains.

Service & Appearance Care

Finish Damage

Any stone chips, fractures or deep scratches in the finish should be repaired right away. Bare metal will corrode quickly and may develop into a major repair expense.

Minor chips and scratches can be repaired with touch-up materials available from your dealer or other service outlets. Larger areas of finish damage can be corrected in your dealer's body and paint shop.

Underbody Maintenance

Chemicals used for ice and snow removal and dust control can collect on the underbody. If these are not removed, accelerated corrosion (rust) can occur on the underbody parts such as fuel lines, frame, floor pan, and exhaust system even though they have corrosion protection.

At least every spring, flush these materials from the underbody with plain water. Clean any areas where mud and other debris can collect. Dirt packed in closed areas of the frame should be loosened before being flushed. Your dealer or an underbody vehicle washing system can do this for you.

Chemical Paint Spotting

Some weather and atmospheric conditions can create a chemical fallout. Airborne pollutants can fall upon and attack painted surfaces on your vehicle. This damage can take two forms: blotchy, ringlet-shaped discolorations, and small irregular dark spots etched into the paint surface.

Although no defect in the paint job causes this, Pontiac will repair, at no charge to the owner, the surfaces of new vehicles damaged by this fallout condition within 12 months or 12,000 miles (20,000 km) of purchase, whichever comes first.

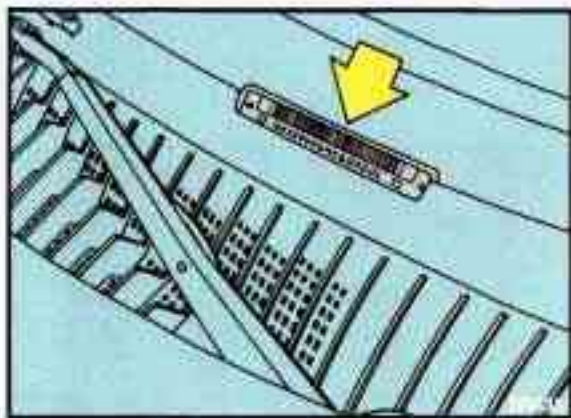

Vehicle Identification Number (VIN)

This is the legal identifier for your Pontiac. It appears on a plate in the front corner of the instrument panel, on the driver's side. You can see it if you look through the windshield from outside your vehicle. The VIN also appears on the Vehicle Certification and Service Parts labels and the certificates of title and registration.

Engine Identification

The 8th character in your VIN is the engine code for your GM engine. This code will help you identify your engine, specifications, and replacement parts in this section.



Service Parts Identification Label

You'll find this label on your spare tire cover. It's very helpful if you ever need to order parts. On this label is:

- Your VIN.
- Its model designation.
- Paint information.
- A list of all production options and special equipment.

Be sure that this label is not removed from the vehicle.

Service & Appearance Care

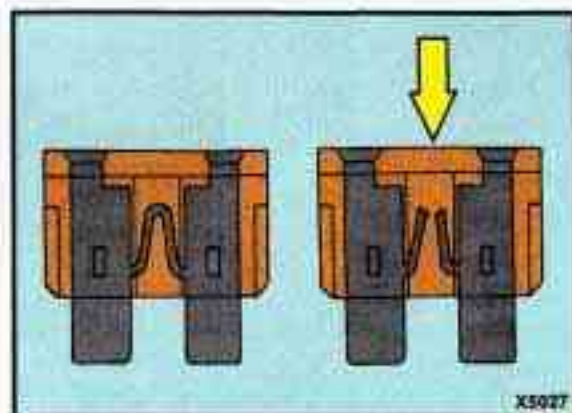
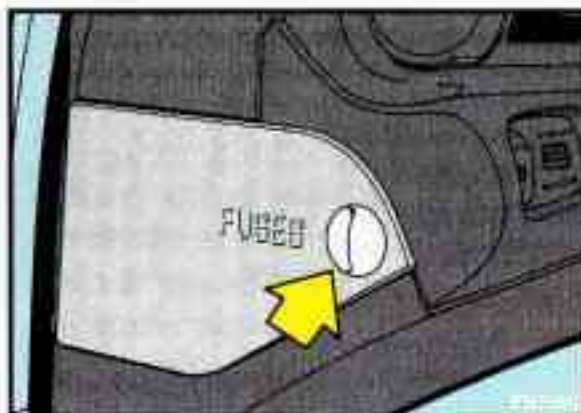

Add-On Electrical Equipment

NOTICE

Don't add anything electrical to your Pontiac unless you check with your dealer first. Some electrical equipment can damage your vehicle and the damage wouldn't be covered by your warranty. Some of it can just keep other things from working as they should.

Fuses & Circuit Breakers

The wiring circuits in your vehicle are protected from short circuits by a combination of fuses and circuit breakers.

The main fuse panel is located on the left side of the instrument panel. To access the fuses, open the fuse panel door.

Look at the silver-colored band inside the fuse. If the band is broken or melted, replace the fuse. Be sure you replace a bad fuse with a new one of the correct size.

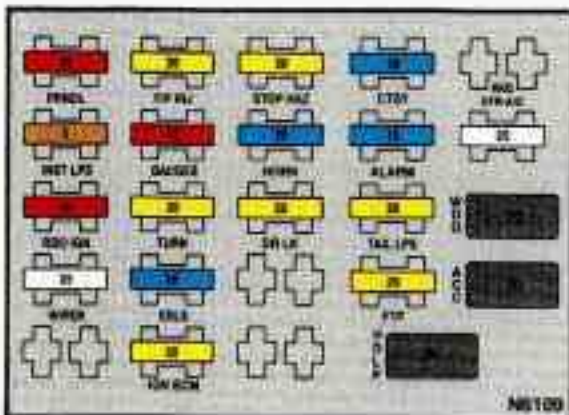

Fuse Usage

Fuse	Rating (AMP.)	Circuitry
PRNDL	10	Back Up Lights, Electronic PRNDL (automatic transaxle)
F/P INJ	20	Fuel Pump, Fuel Injectors
STOP HAZ	20	Turn/Hazard/Stop Lights, Anti-Lock Brakes (ABS), Brake-Transaxle Shift Interlock (BTSI)
CTSY	15	Power Door Locks, Power Mirrors, Cigar Lighter
INST LPS	5	Instrument Panel Lights
GAUGES	10	Rear Window Defogger Relay, Chime, Gages, ABS , BTSI, Daytime Running Lights (DRL) (Canada)
HORN	15	Horn
ALARM	15	Chime, Interior Lights, Passive Restraints, Radio/Clock Memory
HTR-A/C	25	Heater, Air Conditioning, ABS, DRL (Canada), Engine Block Heater
RDO IGN	10	Radio, Cruise Control, Variable Effort Steering
TURN	20	Turn Signals
DR LK	20	Power Door Locks
TAIL LPS	20	Exterior Lights, Fog Lights, Instrument Panel Lights, DRL (Canada)
WDO	30	Power Windows (Circuit Breaker)
WIPER	25	Windshield Wipers/Washer
ERLS	15	Engine Controls, Starter and Charging System
FTP	20	Flash-to-Pass (U.S.)
ACC	30	Power Seats, Rear Window Defogger (Circuit Breaker)
IGN ECM	20	Engine Control Module, Ignition System
HDLP	20	Headlights, DRL (Canada) (Circuit Breaker)

Service & Appearance Care

Headlight Wiring

The headlight wiring is protected by a circuit breaker in the fuse block. An electrical overload will cause the lights to go on and off or, in some cases, to remain off. If this happens, have your headlight system checked right away.

Windshield Wipers

The windshield wiper motor is protected by a circuit breaker and a fuse. If the motor overheats due to heavy snow, etc., the wiper will stop until the motor cools. If the overload is caused by some electrical problem, have it fixed.

Power Windows and Other Power Options

Circuit breakers in the fuse panel protect the power windows and other power accessories. When the current load is too heavy, the circuit breaker opens and closes, protecting the circuit until the problem is fixed.

Capacities & Specifications

Engine Crankcase (All Models) 4 quarts 3.8 L

When changing filter, up to 1 quart (1 liter) more oil may be needed.

Automatic Transaxle

Pan Removal and Replacement 4 quarts 3.8 L

After Complete Overhaul 6 quarts 5.5 L

When draining or replacing torque converter, more fluid may be needed.

Manual Transaxle, 5-Speed

Complete Drain and Refill

T5550 2.1 quarts 2.0 L

Isuzu 2.0 quarts 1.9 L

Cooling System

2.3L Quad OHC and Quad 4 10.4 quarts 9.8 L

3300 V6 10.8 quarts 10.2 L

Service & Appearance Care

Capacities & Specifications (CONT.)

Refrigerant, Air Conditioning See refrigerant charge label under hood.

Not all air conditioning refrigerants are the same. If the air conditioning system in your vehicle needs refrigerant, be sure the proper refrigerant is used. If you're not sure, ask your Pontiac dealer.

Fuel Tank 15.2 gallons 57.5 L

Power Steering

Pump Only 1.00 pint 0.50 L

Complete System 2.25 pints 1.25 L

Tire Pressures, Sizes See Tire-Loading Information label on driver's door.

Wheel Nut Torque 100 pound-feet (140 N•m)

NOTE: All capacities are approximate. When adding, be sure to fill to the appropriate level or as recommended in this manual.

Fluids & Lubricants

ITEM	APPLICATION	GM PART NUMBER	SIZE
Antifreeze Coolant (Ethylene Glycol Base)	Year-round antifreeze for coolant mixtures	1052753	1 gal. (3.8 L)
Chassis Lubricant (Grease Gun Insert)	General chassis lube, etc.	1052497	14 oz. (397 g)
Delco Supreme 11 [®] Brake Fluid	Brake System and Clutch Master Cylinder	1052535	16 oz. (0.5 L)
DEXRON [®] -III Automatic Transmission Fluid	Automatic Transaxle	12345880 12345881	16 oz. (0.5 L) 32 oz. (1.0 L)
Synchromesh Transmission Fluid	Manual Transaxle	12345349	32 oz. (1.0 L)
GM Hydraulic Fluid	Clutch Master Cylinder	12345347	16 oz. (0.5 L)
Engine Oil	Engine lubrication	See the <i>Index</i> under <i>Engine Oil</i> .	
GM Engine Oil Supplement (E.O.S.)	See your dealer for advice	1052367	16 oz. (0.5 L)
Engine Oil	Hood and door hinges		
Windshield Washer Solvent	Windshield washer fluid		
Power Steering Fluid	Power Steering System	1050017 1052884	32 oz. (1.0 L) 16 oz. (0.5 L)
Silicone Grease	Weatherstrips	12345579	1 oz. (28 g)
Spray-A-Squeak Silicone Lubricant	General purpose silicone lubricant, weatherstrips	1052276 (aerosol) 1052277	4.5 oz. (127 g) 12 oz. (0.35 L)

Service & Appearance Care

Replacement Bulbs

OUTSIDE LIGHTS	BULB
Back Up Lights	2057
Front Parking/Turn Signal Lights	2057 NA
License Plate Light	194
Center High-Mounted Stoplight	912
Halogen Headlights	
Low Beam	9006
High Beam	9005
Side Marker Lights	
Front	194 NA
Rear	24
Stop/Tail/Turn Signal Lights	3057
Trunk Light	562
Fog Lights	9442876

INSIDE LIGHTS	BULB
Ashtray	194
Front Reading Light	168
Rear Reading Light	168
Underdash Light	194
Heater & A/C Control	161
High-Beam Indicator	161
Indicator Lights	
Charge, Oil, Fasten Safety Belts, ABS, Upshift, Low Coolant . .	74
Brake, Turn Signals, Malfunction Indicator Lamp (Service Engine Soon), Check Gages	161

Service & Appearance Care

Engine Specifications

	Quad 2.3L OHC	Quad 4 2.3L DOHC	Quad 4 2.3L High Output	3300 V6
VIN Engine Code	3	D	A	N
Type	L4	L4	L4	V6
Displacement	2.3 Liters	2.3 Liters	2.3 Liters	3.3 Liters
Compression Ratio	9.5:1	9.5:1	10.0:1	9.0:1
Firing Order	1-3-4-2	1-3-4-2	1-3-4-2	1-6-5-4-3-2
Thermostat Temperature	195°F (91°C)	195°F (91°C)	195°F (91°C)	195°F (91°C)

Normal Maintenance Replacement Parts

Air Cleaner Element

2.3L Quad OHC and Quad 4	AC Type A-1172C
3300 V6	AC Type A-974C

Engine Oil Filter

2.3L Quad OHC and Quad 4	AC Type PF-1225
3300 V6	AC Type PF-47

PCV Valve

3300 V6	AC Type CV-899C
---------------	-----------------

Spark Plugs

2.3L Quad OHC and Quad 4	AC Type •FR3LSK* Gap: 0.035 inch (.889 mm)
2.3L Quad High Output	AC Type •FR2LSK* Gap: 0.035 inch (.889 mm)
3300 V6	AC Type 41-600 Gap: 0.060 inch (1.52 mm)

*These spark plugs are made with special thread plating and spark plug boot release agents that may help prevent damage to your aluminum cylinder head and spark plug wiring.

IMPORTANT

KEEP ENGINE OIL
AT THE PROPER
LEVEL AND CHANGE AS
RECOMMENDED

This part covers the maintenance required for your Pontiac. Your vehicle needs these services to retain its safety, dependability and emission control performance.



Have you purchased the
GM Protection Plan?
The Plan supplements your
new vehicle warranties.
See your Pontiac dealer for details.

Part 7 Maintenance Schedule

Section

Introduction

A Word About Maintenance	260
Your Vehicle and the Environment	260
How This Part is Organized	261
A. Scheduled Maintenance Services	
Using Your Maintenance Schedules	262
Selecting the Right Schedule	262
Schedule I	264
Schedule II	266
Explanation of Scheduled Maintenance Services	268
B. Owner Checks & Services	
At Each Fuel Fill	271
At Least Once a Month	271
At Least Once a Year	272
C. Periodic Maintenance Inspections	275
D. Recommended Fluids & Lubricants	276
E. Maintenance Record	278

Maintenance Schedule

Introduction

A Word About Maintenance

We at General Motors want to help you keep your vehicle in good working condition. But we don't know exactly how you'll drive it. You may drive very short distances only a few times a week. Or you may drive long distances all the time in very hot, dusty weather. You may use your vehicle in making deliveries. Or you may drive it to work, to do errands or in many other ways.

Because of all the different ways people use their GM vehicles, maintenance needs vary. You may even need more frequent checks and replacements than you will find in the schedules in this part. So please read this part and note how you drive. If you have any questions on how to keep your vehicle in good condition, see your Pontiac dealer, the place many GM owners choose to have their maintenance work done. Your dealer can be relied upon to use proper parts and practices.

Your Vehicle and the Environment

Proper vehicle maintenance not only helps to keep your vehicle in good working condition, but also helps the environment. All recommended maintenance procedures are important. Improper vehicle maintenance or the removal of important components can significantly affect the quality of the air we breathe. Improper fluid levels or even the wrong tire inflation can increase the level of emissions from your vehicle. To help protect our environment, and to help keep your vehicle in good condition, please maintain your vehicle properly.

How This Part is Organized

The remainder of this part is divided into five sections:

Section A: Scheduled Maintenance Services shows what to have done and how often. Some of these services can be complex, so unless you are technically qualified and have the necessary equipment, you should let your dealer's service department or another qualified service center do these jobs.

CAUTION



Performing maintenance work on a vehicle can be dangerous. In trying to do some jobs, you can be seriously injured. Do your own maintenance work only if you have the required know-how and the proper tools and equipment for the job. If you have any doubt, have a qualified technician do the work.

If you are skilled enough to do some work on your vehicle, you will probably want to get the service information GM publishes. You will find a list of publications and how to get them in this manual. See the *Index* under *Service Publications*.

Section B: Owner Checks & Services tells you what should be checked whenever you stop for fuel. It also explains what you can easily do to help keep your vehicle in good condition.

Section C: Periodic Maintenance Inspections explains important inspections that your Pontiac dealer's service department or another qualified service center should perform.

Section D: Recommended Fluids & Lubricants lists some products GM recommends to help keep your vehicle properly maintained. These products, or their equivalents, should be used whether you do the work yourself or have it done.

Section E: Maintenance Record provides a place for you to record the maintenance performed on your vehicle. Whenever any maintenance is performed, be sure to write it down in this section. This will help you determine when your next maintenance should be done. In addition, it is a good idea to keep your maintenance receipts. They may be needed to qualify your vehicle for warranty repairs.

Maintenance Schedule

Section A: Scheduled Maintenance Services

Using Your Maintenance Schedules

This section tells you the maintenance services you should have done and when you should schedule them. Your Pontiac dealer knows your vehicle best and wants you to be happy with it. If you go to your dealer for your service needs, you'll know that GM-trained and supported service people will perform the work using genuine GM parts.

These schedules are for vehicles that:

- carry passengers and cargo within recommended limits. You will find these limits on your vehicle's Tire-Loading Information label. See the *Index* under *Loading Your Vehicle*.
- are driven on reasonable road surfaces within legal driving limits.
- use the recommended unleaded fuel. See the *Index* under *Fuel*.

Selecting the Right Schedule

First you'll need to decide which of the two Schedules is right for your vehicle. Here is how to decide which schedule to follow:

Schedule I

Is any one of these true for your vehicle?

- Most trips are less than 4 miles (6 km).
- Most trips are less than 10 miles (16 km) when outside temperatures are below freezing.
- The engine is at low speed most of the time (as in door-to-door delivery, or in stop-and-go traffic).
- You operate your vehicle in dusty areas.
- You tow a trailer. (With some models you shouldn't ever tow a trailer. See the *Index* under *Towing a Trailer*.)

If any one (or more) of these is true for your driving, follow Schedule I.

Schedule II

Follow Schedule II **only** if none of the above conditions is true.

Maintenance Schedule

Section A: Scheduled Maintenance Services (Cont.)

Schedule I

Follow Schedule I if your vehicle is **MAINLY** driven under one or more of the following conditions:

- When most trips are less than 4 miles (6 km).
- When most trips are less than 10 miles (16 km) and outside temperatures remain below freezing.
- When most trips include extended idling and/or frequent low-speed operation, as in stop-and-go traffic.
- When towing a trailer. (With some models, you shouldn't ever tow a trailer. See the *Index* under *Towing a Trailer*.)
- When operating in dusty areas.

Schedule I should also be followed if the vehicle is used for delivery service, police, taxi or other commercial applications.

* An Emission Control Service.

☆ The U.S. Environmental Protection Agency has determined that the failure to perform this maintenance item will not nullify the emission warranty or limit recall liability prior to the completion of vehicle useful life. General Motors, however, urges that all recommended maintenance services be performed at the indicated intervals and the maintenance be recorded in Section E: Maintenance Record.

ITEM NO.	TO BE SERVICED <i>See Explanation of Scheduled Maintenance Services following Schedules I and II.</i>	WHEN TO PERFORM <i>Miles (kilometers) or Months (whichever occurs first).</i>
1	Engine Oil Change & Oil Filter Change*	Every 3,000 Miles (5,000 km) or 3 Months.
2	Chassis Lubrication	Every other oil change.
3	Throttle Body Mounting Bolt Torque (3300 V6 Code N engine)*	At 6,000 Miles (10,000 km) only.
4	Tire and Wheel Rotation & Inspection	At 6,000 Miles (10,000 km) and then every 15,000 Miles (25,000 km) or as necessary.
5	Engine Accessory Drive Belt Inspection*	Every 30,000 Miles (50,000 km) or 24 Months.
6	Cooling System Service*	Every 30,000 Miles (50,000 km) or 24 Months.
7	Transaxle Service	<i>See Explanation of Scheduled Maintenance Services following Schedules I and II.</i>
8	Spark Plug Replacement*	Every 30,000 Miles (50,000 km).
9	Spark Plug Wire Inspection (3300 V6 Code N engine)* ☆	Every 30,000 Miles (50,000 km).
10	Air Cleaner Filter Replacement*	Every 30,000 Miles (50,000 km).
11	Fuel Tank, Cap and Lines Inspection* ☆	Every 30,000 Miles (50,000 km).

The services shown in this schedule up to 48,000 miles (80 000 km) are to be performed after 48,000 miles at the same intervals.

MILES (000)

3 6 9 12 15 18 21 24 27 30 33 36 39 42 45 48

KILOMETERS (000)

5 10 15 20 25 30 35 40 45 50 55 60 65 70 75 80

•	•	•	•	•	•	•	•	•	•	•	•	•	•	•	•
	•		•		•		•		•		•		•		•
	•														
	•					•					•				
									•						
									•						
									•						
									•						
									•						
									•						
									•						

Maintenance Schedule

Section A: Scheduled Maintenance Services [Cont.]

Schedule II

Follow Schedule II ONLY if none of the driving conditions specified in Schedule I apply.

ITEM NO.	TO BE SERVICED <i>See Explanation of Scheduled Maintenance Services following Schedules I and II.</i>	WHEN TO PERFORM <i>Miles (kilometers) or Months (whichever occurs first).</i>
1	Engine Oil Change *	Every 7,500 Miles (12,500 km) or 12 Months.
	Oil Filter Change *	At first and then every other oil change.
2	Chassis Lubrication	Every 7,500 Miles (12,500 km) or 12 Months.
3	Throttle Body Mounting Bolt Torque (3300 V6 Code N engine)*	At 7,500 Miles (12,500 km) only.
4	Tire and Wheel Rotation & Inspection	At 7,500 Miles (12,500 km) and then every 15,000 Miles (25,000 km) or as necessary.
5	Engine Accessory Drive Belt Inspection*	Every 30,000 Miles (50,000 km) or 24 Months.
6	Cooling System Service*	Every 30,000 Miles (50,000 km) or 24 Months.
7	Transaxle Service	<i>See Explanation of Scheduled Maintenance Services following Schedules I and II.</i>
8	Spark Plug Replacement *	Every 30,000 Miles (50,000 km).
9	Spark Plug Wire Inspection (3300 V6 Code N engine)* ⇨	Every 30,000 Miles (50,000 km).
10	Air Cleaner Filter Replacement*	Every 30,000 Miles (50,000 km).
11	Fuel Tank, Cap and Lines Inspection* ⇨	Every 30,000 Miles (50,000 km).

*An Emission Control Service.

⇨ The U.S. Environmental Protection Agency has determined that the failure to perform this maintenance item will not nullify the emission warranty or limit recall liability prior to the completion of vehicle useful life. General Motors, however, urges that all recommended maintenance services be performed at the indicated intervals and the maintenance be recorded in Section E: Maintenance Record.

The services shown in this schedule up to 45,000 miles (75 000 km) are to be performed after 45,000 miles at the same intervals.

MILES (000)

7.5	15	22.5	30	37.5	45
-----	----	------	----	------	----

KILOMETERS (000)

12.5	25	37.5	50	62.5	75
------	----	------	----	------	----

•	•	•	•	•	•
---	---	---	---	---	---

•		•		•	
---	--	---	--	---	--

•	•	•	•	•	•
---	---	---	---	---	---

•					
---	--	--	--	--	--

•		•		•	
---	--	---	--	---	--

			•		
--	--	--	---	--	--

			•		
--	--	--	---	--	--

--	--	--	--	--	--

			•		
--	--	--	---	--	--

			•		
--	--	--	---	--	--

			•		
--	--	--	---	--	--

			•		
--	--	--	---	--	--

Maintenance Schedule

Section A: Scheduled Maintenance Services (Cont.)

Explanation of Scheduled Maintenance Services

Below are explanations of the services listed in Schedule I and Schedule II.

The proper fluids and lubricants to use are listed in Section D. Make sure whoever services your vehicle uses

these. All parts should be replaced and all necessary repairs done before you or anyone else drives the vehicle.

NOTE: To determine your engine's displacement and code, see the *Index* under *Engine Identification*.

ITEM

NO. SERVICE

- 1 Engine Oil and Filter Change***—Always use SG Energy Conserving II oils of proper viscosity. The "SG" designation may be shown alone or in combination with others, such as "SG/CC," "SG/CD" or "SF, SG, CC," etc. If you have the 2.3L Quad OHC or a Quad 4 engine, the preferred viscosity for your vehicle's engine is SAE 5W-30. However, you can use SAE 10W-30 if it's going to be 0°F (-18°C) or above. If you have the 3300 V6 engine, the preferred viscosity for your vehicle's engine is SAE 10W-30. However, you can use SAE 5W-30 if it's going to be 60°F (16°C) or below.

ITEM

NO. SERVICE

- 2 Chassis Lubrication**—Lubricate the transaxle shift linkage, parking brake cable guides, underbody contact points and linkage. Lubricate the front and rear suspension, steering linkage and fuel filler door and striker plunger.
- 3 Throttle Body Mounting Bolt Torque (3300 V6 Code N engine)***—Check the torque of the mounting bolts and/or nuts.
- 4 Tire and Wheel Rotation and Inspection**—For proper wear and maximum tire life, rotate your tires following the instructions in this manual. See the *Index* under *Tires, Inspection & Rotation*. Check the tires for uneven wear or damage. If you see irregular or premature wear, check the wheel alignment. Check for damaged wheels also.

* An Emission Control Service.

⚠ The U.S. Environmental Protection Agency has determined that the failure to perform this maintenance item will not nullify the emission warranty or limit recall liability prior to the completion of vehicle useful life. General Motors, however, urges that all recommended maintenance services be performed at the indicated intervals and the maintenance be recorded in Section E: Maintenance Record.

**ITEM
NO. SERVICE**

- 5 Engine Accessory Drive Belt Inspection***—Inspect the belt for cracks, fraying, wear and proper tension. Replace as needed.
- 6 Cooling System Service***—Drain, flush and refill the system with new or approved recycled coolant conforming to GM Specification 1825M. Keep coolant at the proper mixture as specified. See the *Index* under *Coolant*. This provides proper freeze protection, corrosion inhibitor level and engine operating temperature.
- Inspect hoses and replace if they are cracked, swollen or deteriorated. Clean the outside of the surge tank and air conditioning condenser.
- To help ensure proper operation, we recommend a pressure test of both the cooling system and the surge tank pressure cap.
- 7 Transaxle Service**—For a manual transaxle, fluid doesn't require changing.

**ITEM
NO. SERVICE**

For an automatic transaxle, change both the fluid and filter every 15,000 miles (25 000 km) if the vehicle is mainly driven under one or more of these conditions:

- In heavy city traffic where the outside temperature regularly reaches 90°F (32°C) or higher.
- In hilly or mountainous terrain.
- When doing frequent trailer towing. With some models, you shouldn't even tow a trailer. See the *Index* under *Towing a Trailer*.
- Uses such as found in taxi, police car or delivery service.

If you do not use your vehicle under any of these conditions, change both the fluid and filter every 100,000 miles (160 000 km).

- 8 Spark Plug Replacement***—Replace spark plugs with the proper type. See the *Index* under *Replacement Parts*.
- 9 Spark Plug Wire Inspection (3300 V6 Code N engine)* ☆**—Inspect for burns, cracks or other damage. Check the boot fit at the coils and at the spark plugs. Replace wires as needed.

Maintenance Schedule

Section A: Scheduled Maintenance Services (Cont.)

ITEM NO.

SERVICE

- 10** **Air Cleaner Filter Replacement***—Replace every 30,000 miles (50,000 km) or more often under dusty conditions. Ask your dealer for the proper replacement intervals for your driving conditions.

ITEM NO.

SERVICE

- 11** **Fuel Tank, Cap and Lines Inspection*☆**—Inspect fuel tank, cap and lines (including fuel rails and injection assembly) for damage or leaks. Inspect fuel cap gasket for an even filler neck imprint or any damage. Replace parts as needed. Periodic replacement of the fuel filter is not required.

*An Emission Control Service.

☆The U.S. Environmental Protection Agency has determined that the failure to perform this maintenance item will not nullify the emission warranty or limit recall liability prior to the completion of vehicle useful life. General Motors, however, urges that all recommended maintenance services be performed at the indicated intervals and the maintenance be recorded in Section E: Maintenance Record.

Section B: Owner Checks & Services

Listed below are owner checks and services which should be performed at the intervals specified to help ensure the safety, dependability and emission control performance of your vehicle.

Be sure any necessary repairs are completed at once. Whenever any fluids or lubricants are added to your vehicle, make sure they are the proper ones, as shown in Section D.

At Each Fuel Fill (It is important for you or a service station attendant to perform these underhood checks at each fuel fill.)

CHECK OR SERVICE	WHAT TO DO
Engine Oil Level	Check the engine oil level and add the proper oil if necessary. See the <i>Index</i> under <i>Engine Oil</i> for further details.
Engine Coolant Level	Check the engine coolant level in the surge tank and add the proper coolant mix if necessary. See the <i>Index</i> under <i>Coolant</i> for further details.
Windshield Washer Fluid Level	Check the windshield washer fluid level in the windshield washer tank and add the proper fluid if necessary. See the <i>Index</i> under <i>Windshield Washer Fluid</i> for further details.

At Least Once a Month

CHECK OR SERVICE	WHAT TO DO
Tire Inflation	Check tire inflation: make sure they are inflated to the pressures specified on the Tire-Loading Information label located on the rear edge of the driver's door. See the <i>Index</i> under <i>Tires</i> for further details.

Maintenance Schedule

Section B: Owner Checks & Services (Cont.)

At Least Once a Year

CHECK OR SERVICE	WHAT TO DO
Key Lock Cylinders	Lubricate the key lock cylinders with the lubricant specified in Section D.
Body Lubrication	Lubricate all body door hinges. Also lubricate all hinges and latches, including those for the hood, trunk, glove box door, console door, and any folding seat hardware. Section D tells you what to use.
Starter Switch	CAUTION
	 When you are doing this check, the vehicle could move suddenly. If it does, you or others could be injured. Follow the steps below.
	<ol style="list-style-type: none">1. Before you start, be sure you have enough room around the vehicle.2. Firmly apply both the parking brake (see the <i>Index</i> under <i>Parking Brake</i> if necessary) and the regular brake. <p>NOTE: Do not use the accelerator pedal, and be ready to turn off the engine immediately if it starts.</p> <ol style="list-style-type: none">3. On automatic transaxle vehicles, try to start the engine in each gear. The starter should work only in P (Park) or N (Neutral). If the starter works in any other position, your vehicle needs service. <p>On manual transaxle vehicles, put the shift lever in N (Neutral), push the clutch down halfway and try to start the engine. The starter should work only when the clutch is pushed down all the way to the floor. If the starter works when the clutch isn't pushed all the way down, your vehicle needs service.</p>

CHECK OR SERVICE	WHAT TO DO
Brake-Transaxle Shift Interlock—BTSl (Automatic Transaxle)	<p>CAUTION</p> <p> When you are doing this check, the vehicle could move suddenly. If it does, you or others could be injured. Follow the steps below.</p> <ol style="list-style-type: none"> 1. Before you start, be sure you have enough room around the vehicle. It should be parked on a level surface. 2. Firmly apply the parking brake (see the <i>Index</i> under <i>Parking Brake</i> if necessary). <p>NOTE: Be ready to apply the regular brake immediately if the vehicle begins to move.</p> <ol style="list-style-type: none"> 3. With the engine off, turn the key to the Run position, but don't start the engine. Without applying the regular brake, try to move the shift lever out of P (Park) with normal effort. If the shift lever moves out of P (Park), your vehicle's BTSl needs service.
Steering Column Lock	<p>While parked and with the parking brake set, try to turn the key to Lock in each shift lever position.</p> <ul style="list-style-type: none"> • With an automatic transaxle, the key should turn to Lock when the shift lever is in any shift lever position. • With a manual transaxle, the key should turn to Lock when the shift lever is in any shift lever position. <p>On vehicles with a key release button, try to turn the key to Lock without pressing the button. The key should turn to Lock only with the key button depressed. On all vehicles, the key should come out only in Lock.</p>

Maintenance Schedule

Section B: Owner Checks & Services (Cont.)

At Least Once a Year (CONT.)

CHECK OR SERVICE	WHAT TO DO
Parking Brake and Automatic Transaxle P (Park) Mechanism Check	<p data-bbox="476 677 1836 728">CAUTION</p> <p data-bbox="476 728 1836 906"> When you are doing this check, your vehicle could begin to move. You or others could be injured and property could be damaged. Make sure there is room in front of your vehicle in case it begins to roll. Be ready to apply the regular brake at once should the vehicle begin to move.</p> <p data-bbox="476 920 1836 996">Park on a fairly steep hill, with the vehicle facing downhill. Keeping your foot on the regular brake, set the parking brake.</p> <ul data-bbox="476 1009 1836 1167" style="list-style-type: none">• To check the parking brake: With the engine running and the transaxle in N (Neutral), slowly remove foot pressure from the regular brake pedal. Do this until the vehicle is held by the parking brake only.• To check the P (Park) mechanism's holding ability: Shift to P (Park). Then release all brakes.
Underbody Flushing	At least every spring, use plain water to flush any corrosive materials from the underbody. Take care to clean thoroughly any areas where mud and other debris can collect.

Section C: Periodic Maintenance Inspections

Listed below are inspections and services which should be performed at least twice a year (for instance, each spring and fall). You should let your GM dealer's service department or other qualified service center do these jobs. Make sure any necessary repairs are completed at once.

INSPECTION OR SERVICE	WHAT SHOULD BE DONE
Steering, Suspension and Front-Wheel-Drive Axle Boot and Seal Inspection	Inspect the front and rear suspension and steering system for damaged, loose or missing parts, signs of wear, or lack of lubrication. Inspect the power steering lines and hoses for proper hookup, binding, leaks, cracks, chafing, etc. Clean and then inspect the drive axle boot seals for damage, tears or leakage. Replace seals if necessary.
Exhaust System Inspection	Inspect the complete exhaust system. Inspect the body near the exhaust system. Look for broken, damaged, missing or out-of-position parts as well as open seams, holes, loose connections, or other conditions which could cause a heat build-up in the floor pan or could let exhaust fumes into the vehicle. See the <i>Index</i> under <i>Engine Exhaust</i> .
Throttle Linkage Inspection	Inspect the throttle linkage for interference or binding, and for damaged or missing parts. Replace parts as needed.
Brake System Inspection	Inspect the complete system. Inspect brake lines and hoses for proper hookup, binding, leaks, cracks, chafing, etc. Inspect disc brake pads for wear and rotors for surface condition. Also inspect drum brake linings for wear and cracks. Inspect other brake parts, including drums, wheel cylinders, calipers, parking brake, etc. The parking brake is self-adjusting and no manual adjustment is required. You may need to have your brakes inspected more often if your driving habits or conditions result in frequent braking. NOTE: A low brake fluid level can indicate worn disc brake pads which may need to be serviced. Also, if the brake system warning light stays on or comes on, something may be wrong with the brake system. See the <i>Index</i> under <i>Brake System Warning Light</i> . If your anti-lock brake system warning light stays on, comes on or flashes, something may be wrong with the anti-lock brake system. See the <i>Index</i> under <i>Anti-Lock Brake System Warning Light</i> .

Maintenance Schedule

Section D: Recommended Fluids & Lubricants

NOTE: Fluids and lubricants identified below by name, part number or specification may be obtained from your GM dealer.

USAGE	FLUID/LUBRICANT
Engine Oil	GM Goodwrench Motor Oil or equivalent for API Service SG Energy Conserving II oils of the proper viscosity. The "SG" designation may be shown alone or in combination with others, such as "SG/CC," "SG/CD," or "SF, SG, CC," etc. If you have the 2.3L Quad OHC or a Quad 4 engine, the preferred viscosity for your vehicle's engine is SAE 5W-30. However, you can use SAE 10W-30 if it's going to be 0°F (-18°C) or above. If you have the 3300 V6 engine, the preferred viscosity for your vehicle's engine is SAE 10W-30. However, you can use SAE 5W-30 if it's going to be 60°F (16°C) or below. See the <i>Index</i> under <i>Engine Oil</i> .
Engine Coolant	A 50/50 mixture of water (preferably distilled) and good quality ethylene glycol base antifreeze (GM Part No. 1052753 or equivalent) conforming to GM Specification 1825M, or an approved recycled coolant conforming to GM Specification 1825M.
Hydraulic Brake System	Delco Supreme II® Brake Fluid (GM Part No. 1052535) or equivalent DOT-3 brake fluid.
Hydraulic Clutch System	Hydraulic Clutch Fluid (GM Part No. 12345347) or equivalent.
Parking Brake Guides	Chassis lubricant meeting requirements of NLGI Grade 2, Category LB or GC-LB (GM Part No. 12346003) or GM Part No. 1052497 or equivalent.
Power Steering System	GM Hydraulic Power Steering Fluid (GM Part No. 1052884) or equivalent.
Manual Transaxle	Synchromesh Transmission Fluid (GM Part No. 12345349) or equivalent.
Automatic Transaxle	DEXRON®-III Automatic Transmission Fluid (GM Part No. 12345881).
Key Lock Cylinders	Lubricate with Multi-Purpose Lubricant (GM Part No. 12345120), synthetic SAE 5W-30 engine oil or silicone lubricant (GM Part No. 1052276 or 1052277).

USAGE	FLUID/LUBRICANT
Manual Transaxle Shift Linkage	Chassis lubricant meeting requirements of NLGI Grade 2, Category LB or GC-LB (GM Part No. 12346003) or GM Part No. 1052497 or equivalent.
Automatic Transaxle Shift Linkage	Engine oil.
Clutch Linkage Pivot Points	Engine oil.
Chassis Lubrication and Fuel Filler Door and Striker Plunger.	Chassis lubricant meeting requirements of NLGI Grade 2, Category LB or GC-LB (GM Part No. 12346003) or GM Part No. 1052497 or equivalent.
Windshield Washer Solvent	Washer Solvent (GM Part No. 1051515) or equivalent.
Hood Latch Assembly a. Pivots and Spring Anchor b. Release Pawl	a. Engine oil. b. Chassis lubricant meeting requirements of NLGI Grade 2, Category LB or GC-LB (GM Part No. 12346003) or GM Part No. 1052497 or equivalent.
Hood and Door Hinges, Rear Folding Seat	Engine oil, or Lubriplate Lubricant (GM Part No. 1050109).
Weatherstrips	Dielectric Silicone Grease (GM Part No. 12345579 or equivalent).

See the *Index* under *Replacement Parts* for recommended replacement filters, valves and spark plugs.

Maintenance Schedule

Section E: Maintenance Record

After the scheduled services are performed, record the date, odometer reading and who performed the service in the columns indicated. When completing the Maintenance Performed column, insert the numbers from the Schedule

I or Schedule II maintenance charts which correspond to the maintenance performed. Also, you should retain all maintenance receipts. Your owner information portfolio is a convenient place to store them.

<i>DATE</i>	<i>ODOMETER READING</i>	<i>SERVICED BY</i>	<i>MAINTENANCE PERFORMED</i>



Part **8** **Customer Assistance Information**

Here you will find out how to contact Pontiac if you need assistance. This part also tells you how to obtain service publications and how to report any safety defects.

Customer Satisfaction Procedure	280
Customer Assistance for the Hearing or Speech Impaired	281
BBB Mediation/Arbitration Program	282
Reporting Safety Defects	284
Pontiac Roadside Assistance Program	285
Service Publications	286

Customer Assistance Information



Customer Satisfaction Procedure

Your satisfaction and goodwill are important to your dealer and Pontiac. Normally, any concern with the sales transaction or the operation of your vehicle will be resolved by your dealer's Sales or Service Departments. Sometimes, however, despite the best intentions of all concerned, misunderstandings can occur. If your concern has not been resolved to your satisfaction, the following steps should be taken:

STEP ONE: Discuss your concern with a member of dealership management. Complaints can often be quickly resolved at that level. If the matter has already been reviewed with the Sales, Service, or Parts Manager, contact the owner of the dealership or the General Manager.

STEP TWO: If after contacting a member of Dealership Management, it appears your concern cannot be resolved by the dealership without further help, contact the Pontiac Customer Assistance Center by calling 1-800-PM CARES. In Canada, contact GM of Canada Customer Assistance Center in Oshawa by calling 1-800-263-3777 (English) or 1-800-263-7854 (French).

In Mexico, call (525) 254-3777. In Puerto Rico or U.S. Virgin Islands, call 1-809-763-1315. In all other overseas locations, contact GM International Export Sales in Canada by calling 1-416-644-4112.

For prompt assistance, please have the following information available to give the Customer Assistance Representative:

- Your name, address, telephone number
- Vehicle Identification Number (This is available from the vehicle registration or title, or the plate attached to the left top of the instrument panel and visible through the windshield.)
- Dealership name and location
- Vehicle delivery date and present mileage
- Nature of concern

We encourage you to call the toll-free number listed previously in order to give your inquiry prompt attention. However, if you wish to write Pontiac, write to:

United States

Pontiac Division
Customer Assistance Center
One Pontiac Plaza
Pontiac, MI 48340

Canada

General Motors of Canada Limited
Customer Assistance Centre
1908 Colonel Sam Drive
Oshawa, Ontario L1H 8P7

A listing of all Pontiac Zone Offices and offices outside the U.S. which can assist you can also be found in the warranty booklet.

When contacting Pontiac, please remember that your concern will likely be resolved in the dealership, using the dealership's facilities, equipment and personnel. That is why we suggest you follow Step One first if you have a concern.

***Customer Assistance For the
Hearing or Speech Impaired
(TDD)***

To assist owners who have hearing difficulties, Pontiac has installed special TDD (Telecommunication Devices for the Deaf) equipment at its Customer Assistance Center. Any hearing or speech impaired customer who has access to a TDD or a conventional teletypewriter (TTY) can communicate with Pontiac by dialing: 1-800-TDD-PONT. (TDD users in Canada can dial 1-800-263-3830.)

Customer Assistance Information

GM Participation In Better Business Bureau Mediation/Arbitration Program*

Our experience has shown that the Customer Satisfaction Procedure described earlier in this part has been very successful in achieving customer satisfaction. However, if you have not been substantially satisfied, Pontiac wants you to be aware of GM's voluntary participation in a no-charge mediation/arbitration program called BBB AUTO LINE. This program is administered by the Council of Better Business Bureaus through local Better Business Bureaus. It can resolve individual disputes involving vehicle repairs and the interpretation of your New Vehicle Limited Warranty.

We prefer that you not resort to BBB AUTO LINE until after a final decision is made under the Customer Satisfaction Procedure. However, you may file a claim at any time by contacting your local Better Business Bureau (BBB) at the following toll-free number: 1-800-955-5100. For further information about filing a claim, you may also write to:

BBB AUTO LINE
Council of Better Business Bureaus
4200 Wilson Boulevard
Suite 800
Arlington, VA 22203

In order to file a claim, you will have to provide your name and address, the vehicle identification number (VIN) of your vehicle, and a statement of the nature of your complaint. BBB staff may try to help resolve your dispute through mediation. If mediation is not successful, or if you do not wish to participate in mediation, eligible customers may present their case to an impartial third-party arbitrator at an informal hearing. The arbitrator will render a decision in your case, which you may accept or reject. If you accept a valid arbitrator decision, GM will be bound by that decision. The entire dispute settlement process should ordinarily take about 40 days from the

time you file your complaint to the time a decision is rendered (or 47 days if you did not first contact your dealer or Pontiac).

We encourage you to use this program before or instead of resorting to the courts. We believe it offers advantages over courts in most jurisdictions because it is fast, free of charge, and informal (lawyers are not usually present, although you may retain one at your expense if you choose). Arbitrators make decisions based on the principles of fairness and equity, and are not required to duplicate the functions of courts by strictly applying state or federal law. If you wish to go to court, however, we do not require that you first file a claim with BBB AUTO LINE** unless state law provides otherwise.

Whatever your preference may be, remember that if you are unhappy with the results of BBB AUTO LINE, you can still go to court because an arbitrator's decision is binding on GM but not on you, unless you accept it.

Eligibility is limited by vehicle age/mileage and other factors. For further information concerning the program, call the BBB at 1-800-955-5100. You may also call the Pontiac Customer Assistance Center.

** This program may not be available in all states, depending on state law. Canadian owners refer to your warranty booklet. General Motors reserves the right to change eligibility limitations and/or to discontinue its participation in this program.*

*** Some states may require that you file a claim with BBB AUTO LINE before resorting to state-operated procedures (including court).*

Customer Assistance Information

Reporting Safety Defects to the United States Government

If you believe that your vehicle has a defect which could cause a crash or could cause injury or death, you should immediately inform the National Highway Traffic Safety Administration (NHTSA), in addition to notifying General Motors.

If NHTSA receives similar complaints, it may open an investigation, and if it finds that a safety defect exists in a group of vehicles, it may order a recall and remedy campaign. However, NHTSA cannot become involved in individual problems between you, your dealer, or General Motors.

To contact NHTSA, you may either call the Auto Safety Hotline toll-free at 1-800-424-9393 (or 366-0123 in the Washington, D.C. area) or write to:

NHTSA
U.S. Department of Transportation
Washington, D.C. 20590

You can also obtain other information about motor vehicle safety from the Hotline.

Reporting Safety Defects to the Canadian Government

If you live in Canada, and you believe that your vehicle has a safety defect, you should immediately notify Transport Canada, in addition to notifying General Motors of Canada Limited. You may write to:

Transport Canada
Box 8880
Ottawa, Ontario K1G 3J2

Reporting Safety Defects to General Motors

In addition to notifying NHTSA (or Transport Canada) in a situation like this, we certainly hope you'll notify us. Please call us at **1-800-PM-CARES**, or write:

Pontiac Division
Customer Assistance Center
One Pontiac Plaza
Pontiac, MI 48340

In Canada, please call us at 1-800-263-3777 (English) or 1-800-263-7854 (French). Or, write:

General Motors of Canada Limited
Customer Assistance Centre
1908 Colonel Sam Drive
Oshawa, Ontario L1H 8P7



■ *Pontiac Roadside Assistance Program*

Security While You Travel

1-800-ROADSIDE 1-800-762-3743

As the proud owner of a new Pontiac vehicle, you are automatically enrolled in the Pontiac Roadside Assistance Program.* This value-added service is intended to provide you with peace of mind as you drive in the city or travel the open road.

Pontiac's Roadside Assistance toll-free number is staffed by a team of technically trained advisors, who are available 24 hours a day, 365 days a year.

We take anxiety out of uncertain situations by providing minor repair

information over the phone or making arrangements to tow your vehicle to the nearest Pontiac dealer.

We will provide the following services for 3 years/36,000 miles, at no expense to you:

- Vehicle out of fuel
- Keys locked in vehicle
- Tow to nearest dealer for warranty
- Change a flat tire
- Jump starts

We have quick, easy access to telephone numbers of the following services depending on your needs:

- Hotels
- Glass replacement
- Rental vehicles or taxis
- Police, fire department or hospitals

In many instances, mechanical failures are covered under Pontiac's comprehensive warranty. However, when other services are utilized, our advisors will explain any payment obligations you might incur.

Pontiac reserves the right to limit services or reimbursement to an owner or driver when in Pontiac's judgement the claims become obsessive in frequency or type of occurrence.

**In Canada, call 1-800-268-6800 for details on Roadside Assistance.*

Customer Assistance Information

■ *Pontiac Roadside Assistance Program (Cont.)*

For prompt and efficient assistance when calling, please provide the following information to the advisor:

- Location of vehicle
- Telephone number of your location
- Vehicle model, year and color
- Mileage of vehicle
- Vehicle identification number
- Vehicle license plate number

While we hope that you never have the occasion to use our service, it is added security while travelling for you and your family. Remember, we're only a phone call away. Pontiac Roadside Assistance—1-800-ROADSIDE or 1-800-762-3743.

■ *Service Publications*

Information on how to obtain Product Service Publications and Indexes as described below is applicable only in the fifty U.S. states (and the District of Columbia) and only for cars and light trucks with GVWR less than 10,000 pounds (4536 kg).

In Canada, information pertaining to Product Service Bulletins and Indexes can be obtained by writing to:

General Motors of Canada Limited
Service Publications Department
1908 Colonel Sam Drive
Oshawa, Ontario L1H 8P7

Pontiac regularly sends its dealers useful service bulletins about Pontiac products. Pontiac monitors product performance in the field. We then prepare bulletins for servicing our products better. Now, you can get these bulletins too.

Bulletins cover various subjects. Some pertain to the proper use and care of your vehicle. Some describe costly repairs. Others describe inexpensive repairs which, if done on time with the latest parts, may avoid future costly repairs. Some bulletins tell a technician how to repair a new or unexpected condition. Others describe a quicker way to fix your vehicle. They can help a technician service your vehicle better.

Most bulletins apply to conditions affecting a small number of cars or trucks. Your Pontiac dealer or a qualified technician may have to determine if a specific bulletin applies to your vehicle.

Individual PSP's

If you don't want to buy all the PSP's issued by Pontiac for all models in the model year, you can buy individual PSP's, such as those which may pertain to a particular model. To do this, you will first need to see our index of PSP's. It provides a variety of information. Here's what you'll find in the index and how you can get one:

What You'll Find in the Index

- A list of all PSP's published by Pontiac in a model year (1990 or later). PSP's covering all models of Pontiac vehicles are listed in the same index.
- Ordering information so you can buy the specific PSP's you may want.
- Price information for the PSP's you may want to buy.

Customer Assistance Information

How You Can Get an Index

Indexes are published periodically. Most of the PSP's which could potentially apply to the most recent Pontiac models will be listed in the most recent publication for that model year. This means you may want to wait until the end of the model year before ordering an index, if you are interested in buying PSP's pertaining to a current model year car or truck.

Some PSP's pertaining to a particular model year vehicle may be published in later years, and these would be listed in the later year's index. When you order an index for a model year that is not over yet, we'll send you the most recently published issue. Check the order form for indexes for earlier model years.

Cut out the order form, fill it out, and mail it in. We will then see to it that an index is mailed to you. There is no charge for indexes for the 1990-1993 model years.

Toll-Free Telephone Number

If you want an additional order form for an index, just call toll-free and we'll be happy to send you one. Automated recording equipment will take your name and mailing address. The number to call is 1-800-551-4123.

A Very Important Reminder

These PSP's are meant for technicians. They are not meant for the "do-it-yourselfer." Technicians have the equipment, tools, safety instructions, and know-how to do a job quickly and safely.

Pontiac Service Publications

You can get these by using the following order form.

Pontiac Division service manuals are intended for use by professional, qualified technicians. Attempting repairs or service without the appropriate training, tools, and equipment could cause injury to you or others and damage to your vehicle that may cause it not to operate properly.

1993 PONTIAC SERVICE PUBLICATIONS ORDERING INFORMATION

The following publications covering the operation and servicing of your vehicle can be purchased by filling out the Service Publications Order Form in this book and mailing it with your check, money order or credit card information to Helm, Incorporated (address listed below).

CURRENT PUBLICATIONS FOR 1993 PONTIAC GRAND AM

PRODUCT SERVICE PUBLICATIONS

Product Service Publications (PSP's), are bulletins, letters and articles published for trained dealer service personnel. See Service Publications listed previously in this section.

A cumulative index is published quarterly during the current model year. The indexes list all PSP's published by Pontiac in the model year.

PSP Index

Year	Form Number	Price
1993	PSPI-93-P	Free
1992	PSPI-92-P	Free
1991	PSPI-91-P	Free
1990	PSPI-90-P	Free

NOTE: Form Numbers for individual Product Service Publications may be found in the PSP Index. Prices are \$4.00 for the first PSP and \$2.00 for each additional PSP on the same order.

PSP Bound Bulletin Book (Complete Year Bulletins)

Year	Description	Form Number	Price
1991	All PSP's	S-91-PSP-4	15.00
1990	All PSP's	S-90-PSP-4	15.00

For subscription information call Helm, Incorporated.

CURRENT & PAST MODEL ORDER FORMS

Service Publications are available for current and past model Pontiac vehicles. To request an order form, please specify year and model name of vehicle.

SERVICE MANUALS

Service Manuals have the diagnosis, repair and overhaul information on engines, transmission, axle, suspension, brakes, electrical, steering, body, etc.

Model	Form Number	Price
1993 Pontiac Grand Am	S-9310-N	\$43.00

*Please specify special body or engine types on order form. Write information in the Form Number column. For example: Turbo, Convertible.

OWNER'S INFORMATION

Owner publications are written directly for owners and intended to provide basic operational information about the vehicle. The Owner's Manual includes the Maintenance Schedule for all models.

1993 Pontiac Grand Am Owner's Manual

In Portfolio: Includes Portfolio, Owner's Manual and Warranty Booklet.		
1993	Pontiac Grand Am In-Portfolio	10222124 \$15.00
Without Portfolio: Includes Owner's Manual.		
1993	Pontiac Grand Am Without Portfolio ..	10202167 \$11.00

Address all inquiries to: HELM, INCORPORATED
P.O. Box 07130
Detroit, MI 48207

Credit Card Orders ONLY: 1-800-782-4356

For information and inquiries call: (313) 883-1430

Index

- A**dding
- Brake Fluid 225, 253
 - Electrical Equipment 55, 107, 248
 - Engine Coolant 222, 251, 253
 - Engine Oil 209, 251, 253
 - Power Steering Fluid 224, 252, 253
 - Hydraulic Clutch Fluid 220, 253
 - Transaxle Fluid
 - Automatic 218, 251, 253
 - Manual 220, 251, 253
 - Windshield Washer Fluid 224, 253
 - Air Cleaner 214, 257
 - Air Conditioner 103
 - Alcohol, Driving Under the
 - Influence of 127
 - Alcohol in Gasoline 201
 - Aluminum Wheels
 - Cleaning 244
 - Removing 188
 - Antenna 119
 - Fixed Mast 119
 - Antifreeze 221, 251, 253
 - Anti-Lock Brake System (ABS) 131
 - Anti-Lock Brake System
 - Warning Light 97
 - Appearance Care 239
 - Ashtray and Lighter 85
 - Audio Systems 107
 - AM/FM Stereo Radio 108
 - AM/FM Stereo Radio with
 - Cassette Player 109
 - AM/FM Stereo Radio with
 - Compact Disc Player 113
 - Care of Audio Systems 118
 - Delco LOC II® 116
 - Radio Reception, For the Best 117
 - Setting the Clock 107
 - Automatic Door Locks 46
 - Automatic Lap-Shoulder Belt
 - (see *Safety Belts*)
 - Automatic Transaxle
 - Adding Fluid 218, 251, 253
 - Checking Fluid 216
 - Shifting 57
 - Starting Your Engine 52
 - B**BB Hot Line 282
 - Battery 171, 227
 - Jump Starting 171
 - Battery Rundown Protection 78
 - Warning 173
 - Voltmeter 96
 - Blizzard, If You're Caught In a 157
 - Block Heater, Engine 56, 213
 - Blowout, Tire 185
 - Brakes 96, 97, 131
 - Adjustment 135
 - Anti-Lock Brake System (ABS) 131
 - Brake Pedal Travel 134
 - Fluid 225, 253
 - Master Cylinder 225
 - Parking 63
 - Rear Drums 134
 - Replacement 226
 - Warning Light 96, 97
 - Wear Indicators 133
 - Brake System Warning Light 96
 - Anti-Lock Brake System 97
 - Standard Brakes 96
 - Brake/Transaxle Shift Interlock 65
 - Brakes, Anti-Lock
 - Warning Light 97
 - Braking 130
 - Braking Emergencies 135
 - Braking Technique 130
 - "Break-In," New Vehicle
 - Normal Driving 50
 - When Towing a Trailer 161

Index

- Buckling Up (see *Safety Belts*)
- Bulb Replacement
- Fog Lights 229
 - Headlight 228, 254
 - Taillight 229, 254
- C**
- Capacities & Specifications 251
- Carbon Monoxide in Exhaust . . . 66, 67
- Cassette Tape Player
(see *Audio Systems*)
- Center Passenger Position 28
- Chains, Safety 164
- Chains, Tire 193, 238
- Changing a Flat Tire 186
- Charging System Warning Light . . . 95
- "Check Gauges" Light 99
- Check Oil Light 94
- Checking
- Brake Fluid 225
 - Engine Coolant 222
 - Engine Oil Level 209
 - Hydraulic Clutch 220
 - Power Steering Fluid 224
 - Safety Belt Systems 40
 - Transaxle Fluid
 - Automatic 216
 - Manual 218
- Checking Things
- Under the Hood 204
- Checks & Services, Owner 271
- Chemical Paint Spotting 246
- Child Restraints 30
- Children and Safety Belts 29, 38
- Cigarette Lighter 85
- Circuit Breakers & Fuses 248
- City Driving 147
- Cleaner, Air 214, 257
- Cleaning
- Aluminum Wheels 244
 - Antenna 119
 - Cassette Player and Tapes 118
 - Compact Discs 119
 - Fabric 240
 - Finish Damage 246
 - Foreign Material 245
 - Glass 243
 - Inside of Your Pontiac 240
 - Leather and Vinyl 242
 - Outside of Your Pontiac 243
 - Safety Belts 242
 - Sheet Metal Damage 245
 - Special Problems 241
 - Top of the Instrument Panel 242
- Underbody Maintenance 246
- Using Solvent Type Cleaner 241
- Warnings 239, 240, 242, 244
- Weatherstrips 245
- White Sidewall Tires 244
- Windshield and Wiper Blades . . . 243
- Climate Control System 102
- Clock, Setting the 107
- Clutch, Hydraulic
- Adding Fluid 220, 253
 - Checking Fluid 220
- Coin Holder 84
- Comfort Controls 101
- Air Conditioning System 103
 - Climate Control System 102
 - Defrosting 102
 - Heater 102
 - Ventilation 102, 104
- Compact Disc Player
(see *Audio Systems*)
- Compact Spare Tire 192, 304
- Control of a Vehicle 129
- Controlled-Cycle Windshield Wipers . . 80
- Convex Outside Mirror 81
- Coolant 221
- Checking & Adding . . . 222, 251, 253
 - Low Coolant Warning Light 93

Proper Mixture to Use	221
Safety Warnings,	
About	179, 181, 182, 183
Temperature Gage	93
Temperature Warning Light	92
Thermostat	223
Corrosion Protection	246
Cruise Control	70
Cup Holders	83
Curves, Driving on	136
Customer Assistance Information	279

D aytime Running Lights	75
Dead Battery: What to Do	171
Defects, Safety, Reporting (see <i>Safety Defects</i>)	
Defensive Driving	126
Defogger, Rear Window	105
Defogging Your Windows	103, 105
Door Locks	45
Door, Remote Fuel Filler	203
Downshifting	62, 152
Driver Position	18
Driving	121
At Night	142

City	147
Controlling a Skid	141
Defensively	126
Drunken	127
Freeway	148
Highway Hypnosis	151
Hill and Mountain	152
In a Foreign Country	202
In Fog, Mist and Haze	146
In the Rain	144
Long Distance	150
Loss of Control	140
On Curves	136
Passing	138
Skidding	141
Through Deep Standing Water	55
Winter Driving	156
With a Trailer	164
Driving on Snow or Ice	156
Drunken Driving	127

E asy-Entry Seat	11
Electrical Equipment,	
Adding	55, 107, 248
Emergencies, Braking	135

Emergencies on the Road	169
Emergencies, Steering in	137
Emergency Starting	171
Emergency Towing	175
Engine Block Heater	56, 213
Engine Coolant (see <i>Coolant</i>)	
Engine Coolant Temperature Warning Light (see <i>Coolant</i>)	
Engine Identification	52, 247
Engine Oil	209
Additives	213
Checking & Adding	209
Disposing of Used Oil	214
Energy Conserving	212
Filter	213, 257
Kind of Oil to Use	210
Pressure Gage	95
Warning Light	93
When to Change	213
Engine Overheating	179
Engine Specifications	256
Engine, Starting	52
Automatic Transaxle	53
Manual Transaxle	53
2.3L Quad 4 Engine	53
3300 V6 Engine	54

Index

Ethanol in Gasoline	201
Exhaust	
Dangerous Gas in	66, 67
Parking with the Engine Running	64, 67
Expectant Mothers, Use of	
Safety Belts	22
Expressway Driving	148
Extender, Safety Belt	38
Exterior Appearance	
<i>(see Appearance Care)</i>	
F	
Fabric Cleaning	
<i>(see Appearance Care)</i>	
Fan Warnings	172, 173, 181, 206
Filling the Fuel Tank	203, 252, 304
Filter, Oil	213, 257
Finish Damage	246
Flash-to-Pass	76
Flashers, Hazard Warning	170
Flat Tire	185
Flooded Engine	54
Flow-Through Ventilation System	106
Fluid	
Brake	225, 253
Capacities	251

Hydraulic Clutch	220, 253
Power Steering	224, 252, 253
Transaxle	
Automatic	216, 251, 253
Manual	218, 251, 253
Windshield Washer	80, 224
Fluids & Lubricants	253, 276
Fog, Driving in	146
Fog Lights	77, 229
Freeway Driving	148
French Language Manual	2
Fuel	199
Alcohol in Fuel	201
Capacity	201
Exhaust Warnings	66, 67
Filling Your Tank	203, 252, 304
Fuels with Alcohol	201
Gage	92
In Foreign Countries	202
Remote Fuel Filler Door	203
Requirements	199
Fuse Usage Chart	249
Fuses & Circuit Breakers	248

G	
Gages	
Coolant Temperature	93
Fuel	92
Oil Pressure	95
Tachometer	91
Voltmeter	96
Garment Hook	84
Gas Station Information	304
Gasoline	199
Gasoline Tank, Filling Your	203, 252, 304
Gear Positions	
<i>(see Shifting the Transaxle)</i>	
Gearshift Lever	
<i>(see Shifting the Transaxle)</i>	
Glove Box	50
Graphic Equalizer <i>(see Audio Systems)</i>	
Gross Axle Weight Rating (GAWR)	230
Gross Vehicle Weight Rating	
(GVWR)	230
H	
Halogen Bulbs	227, 254
Hazard Warning Flashers	170
Head Restraint	11
Headlight & Taillight, Removing and	
Replacing	228, 229, 254

Headlights	74
High-Low Beam Changer	76
Instrument Panel	
Intensity Control	76
"On" Reminder	75
Replacement Bulb	228
Wiring	250
Heater (see <i>Comfort Controls</i>)	
Heater, Engine Block	56, 213
High Beams	76, 143
Highway Hypnosis	151
Hill and Mountain Roads	152
Hills, Parking on	154, 165
Hood Release	205
Safety Warning	206
Warning, Overheated Engine	92
Horn	67
Hot Engine, Safety Warnings	179, 206
How the Anti-Lock Brake System Works	132
Hydraulic Clutch	220, 253
Hydroplaning	145

I dentification Number, Vehicle	247
Idling Your Engine	64, 67

Ignition	
Key	44
Key Release Button	51
Positions	51
Illuminated Entry/Exit System	46
Indicator Lights	
(see <i>Warning Lights</i>)	
Infant Restraint	
(see <i>Child Restraints</i>)	
Inflation, Tires	232, 252, 304
Inside Rearview Mirror	81
Inspections, Owner	271
Instrument Panel	86
Instrument Panel Warning Lights	91

J ack, Tire	187
Jump Starting	171

K ey Release Button	51
Keys	44

L ane Change Indicator	69
Lap-Shoulder Safety Belt	18
Front	18
Rear	23
Use by Children	27, 36
Latches, Seatback	11
Lighter	85
Lights	
Charging System	95
Check Gauges	99
Daytime Running Lights	75
Fog Lights	77, 229
Headlights	74, 228, 254
Headlights Reminder	75
Instrument Panel Intensity Control	76
Parking	74, 254
Reading	77, 255
Removing & Replacing	
Bulbs	228, 229, 254
Replacement Bulbs	254
Shift	62
Taillights	229, 254
Trunk	78
Turn Signal	69, 254
Warning Lights	91, 170
Lights on Reminder	75
Loading Your Vehicle	230

Index

Locks	45
Automatic Door Lock	46
Rear Door Security Locks	47
Long Distance Driving	150
Low Battery	171
Low Oil Pressure Warning	93, 94
Lubricants & Fluids	253, 276
Lumbar Support	9

M aintenance Record	278
Maintenance Schedule	259
Maintenance Services, Scheduled	262
Malfunction Indicator Lamp	98
Manual Front Seat	8
Manual Lumbar Support	9
Manual 4-Way Adjustable Seat	9
Manual Transaxle	
Adding Fluid	220, 251, 253
Checking Fluid	218
Parking	66
Shifting	60
Starting Your Engine	52
Upshift Indicator Light	62, 98
Master Cylinder, Brake	225
Methanol in Gasoline	201

Mileage Indicator	
<i>(see Odometer & Speedometer)</i>	
Mirrors	
Inside Manual Day/Night	81
Manual Remote Control	82
Convex Outside	81
Power Remote Control	82
Mountain Driving	152

N ew Car "Break-In"	
Requirements	50, 161
Night Driving	142
Night Vision	142

O ctane Requirements	
<i>(see Fuel Requirements)</i>	
Odometer & Speedometer	90
Off-Road Recovery	138
Oil, Engine	209
Pressure Gage	95
Quality	210
Thickness	211
Used Oil	214
When to Change	213

Oil Warning Light	93
Operation of Lights	74
Outside Rearview Mirrors	82
Overheated Engine	179
Overheated Engine Coolant	
Warning Light	92
Owner Checks & Services	271

P arking	
On Hills	154, 165
Over Things That Burn	66
With the Engine Running	64, 67
Parking Brake	63
Park, Shifting Into	57, 64
Passenger Belts <i>(see Safety Belts)</i>	
Passenger Side Cup Holder/Storage	
Area	84
Passing	138
Polishing and Waxing	
<i>(see Appearance Care)</i>	
Power Door Locks	46
Power Mirrors	82
Power Seat Controls	9
Power Steering	
Fluid	224, 252, 253

Power Window Lock-Out Switch	69
Power Windows	68, 250
Pregnancy, Use of Safety Belts	
During	22
Problems On the Road	169
Publications (see <i>Service Publications</i>)	

Radiator Overheating
(see *Overheated Engine*)

Radio (see <i>Audio Systems</i>)	
Reading Lights	77, 255
Rear Door Security Locks	47
Rear Seat, Split Fold-Down	12
Rearview Mirrors	81
Rear Window Defogger	105
Reclining Seatbacks	10
Remote Fuel Filler Door	203
Remote Trunk Release	49
Replacement Brakes	226
Replacement Bulbs	254
Replacement Fuses	249
Replacement Parts	257
Replacement, Windshield Wiper	230
Replacing Safety Belts	40
Replacing Tires	234

Replacing Wheels	237
Restraint, Head	11
Restraints, Child	30, 38
Road Signs	122
Color	122
Shape	123
Symbols	124
Traffic Lights	124
Traffic Officers	125
Your Own Signs	125
Roads, Hill and Mountain	152
Roadside Assistance	
Program	285
Rocking Your Vehicle	194
Rotation, Tire	233

S afety Belts	12
Adults	17
Automatic Lap-Shoulder Belt	18
Center Rear Lap Belt	28
Checking	30
Children	29, 38
Child Restraints	30
Child Restraints—How to	
Install	30

Child Restraints, Where to Put	30
Cleaning	242
Driver Position	18
Extender	40
How to Wear	17
Passenger Belts	22
Pregnancy, Use During	22
Questions & Answers	16, 20, 39, 41
Rear Safety Belts	23
Replacement	40
Right Front, Adult Passenger	22
Smaller Children and Babies	29
Top Strap	31
Torn	41
Twisted	21
Vehicles First Sold in Canada	18
Warning Light	17
Why You Should Wear	
Safety Belts	14
Safety Defects, Reporting	284
Scheduled Maintenance Services	262
Seat Adjustment	9
Seat Belts (see <i>Safety Belts</i>)	
Seat Controls	8
Easy-Entry	11
Head Restraint	11

Index

- | | | | | | |
|---|---------|---|----------|---|--------------|
| Manual Front Seat | 8 | Snowstorm, If You're Caught in a | 157 | Glove Box | 50 |
| Manual Lumbar Support | 9 | Sound Equipment, Adding | 107 | Passenger Side Cup Holder/Storage
Area | 84 |
| Manual Reclining Seatback | 10 | Sound Systems
(see <i>Audio Systems</i>) | | Sunglasses Storage | 85 |
| Manual 4-Way Adjustable Seat | 9 | Spare Tire, Compact | 192, 304 | Storing Your Pontiac | 227 |
| Power Seat Controls | 9 | Specifications & Capacities | 251 | Stuck, If You Are | 193 |
| Reclining Seatback | 10 | Speed Control (see <i>Cruise Control</i>) | | Subscriptions | 287 |
| Seatback Latches | 11 | Speedometer and Odometer | 90 | Sun Visors | 82 |
| Seat, Split Fold-Down Rear | 12 | Trip Odometer | 90 | Surge Tank Pressure Cap | 223 |
| Service Engine Soon Light | 98 | Stains, Removing | 241 | | |
| Service Parts Identification
Label | 247 | Starting Your Engine | 52 | T achometer | 91 |
| Service Publications | 286 | Automatic Transaxle | 53 | Tape Player (see <i>Audio Systems</i>) | |
| Service Publications Order Form | 289 | Manual Transaxle | 53 | Technical Facts & Specifications
Bulbs | 254 |
| Service Station Information | 304 | 2.3L Quad 4 Engine | 53 | Electrical Equipment,
Add-On | 55, 107, 248 |
| Setting the Clock | 107 | 3300 V6 Engine | 54 | Fluid Capacities & Types | 251, 252 |
| Sheet Metal Damage | 245 | Starting Your Pontiac if the Battery
is Dead (see <i>Jump Starting</i>) | | Fuses & Circuit Breakers | 248 |
| Setting the Trip Odometer | 90 | Steering | | Service Parts Identification Label | 247 |
| Shift Light | 62, 98 | In Emergencies | 137 | Vehicle Identification Number
(VIN) | 247 |
| Shifting Into P (Park) | 57, 64 | Off-Road Recovery | 138 | Temperature Warning Light | 92 |
| Shifting the Transaxle
Automatic Transaxle | 57 | Tips | 136 | Theft | 48 |
| Manual Transaxle | 60 | Steering Wheel, Tilt | 68 | Thermostat | 223 |
| Shifting Out of P (Park) | 65 | Stereo Sound Systems
(see <i>Audio Systems</i>) | | Tilt Steering Wheel | 68 |
| Signaling Turns | 69, 125 | Storage | | | |
| Signs, Road | 122 | Armrest | 83 | | |
| Skidding | 141 | | | | |

Time, Setting the	107
Tires	232
Buying New	234
Chains	193, 238
Flat, Changing	186
Inflation	232
Inspection & Rotation	233
Loading	230
Pressure	232
Quality Grading	235
Spare, Compact	192, 304
Wear Indicators	234
Wheel Alignment and Tire Balance	237
Wheel Replacement	237
When to Replace Wheels	237
Winter Driving and Tires	156
Top Strap	31
Torque Lock	155, 252
Towing a Trailer	159
Towing Your Pontiac	175
Traffic Lights	124
Trailer Towing	159
Driving with a Trailer	164
Maintenance	166
Parking on Hills	165

Trailer Brakes	163
Transaxle, Automatic (see <i>Automatic Transaxle</i>)	
Transaxle, Manual (see <i>Manual Transaxle</i>)	
Transmission, Automatic (see <i>Automatic Transaxle</i>)	
Transmission, Manual (see <i>Manual Transaxle</i>)	
Trip Odometer	90
Trunk	49
Trunk Light	78
Trunk Release, Remote	49
Turn Signal Indicator	69
Turn Signal/Headlight Beam Lever	69
Cruise Control	70
Headlight High/Low Beam	76
Turn Signal & Lane Change Indicator	69

U nderbody Maintenance	246
Unleaded Gasoline	199
Upholstery Care	240
Upshift Indicator Light	62, 98
Urban Driving	147

V ariable Effort Steering	136
Vehicle "Break-In" Period	50
Vehicle, Control of a	129
Vehicle Identification Number (VIN)	247
Vehicle Loading	230
Vehicle Storage	227
Ventilation (see <i>Comfort Controls</i>)	
VIN	247
Visors, Sun	82
Visor Vanity Mirror	83
Voltmeter	96

W arning Flashers, Hazard	170
Warning Lights	91, 170
ABS	97
Battery	96
Brake	96
Charging System	95
Check Gauges	99
Coolant Temperature	92
Fasten Belts	17
Low Coolant	93
Oil	93
Safety Belt	17

Index

- | | | | |
|--------------------------------------|----------|------------------------------|----------|
| Service Engine Soon | 98 | Winter Driving | 156 |
| Upshift Indicator | 62, 98 | Driving on Snow or Ice | 156 |
| Washer, Windshield | 80, 224 | If Your Car is Stuck in | |
| Weight | | Deep Snow | 159, 193 |
| Gross Axle Rating (GAWR) | 230 | If You're Caught in a | |
| Gross Vehicle Rating (GVWR) | 230 | Blizzard | 157 |
| Wheel Alignment & Tire Balance | 237 | Wrecker Towing | 175 |
| Wheel Covers, How to Remove | 188 | | |
| Wheel Nuts | 188 | | |
| Wheel Nut Torque | 191, 252 | | |
| Wheel Replacement | 237 | | |
| Windows | | | |
| Defogging | 103, 105 | | |
| Power | 68 | | |
| Standard | 68 | | |
| Windshield Washer | 80, 224 | | |
| Windshield Washer Fluid | 224, 253 | | |
| Windshield Wiper Blade | | | |
| Replacement | 230 | | |
| Windshield Wipers | 79, 250 | | |
| Cleaning | 243 | | |
| Controlled-Cycle | 80 | | |

Service Station Information





WE SUPPORT
VOLUNTARY TECHNICIAN
CERTIFICATION THROUGH

NATIONAL INSTITUTE FOR

**AUTOMOTIVE
SERVICE
EXCELLENCE**



PONTIAC

