

Oldsmobile

INTRIGUE



**INTRIGUE**

# **24-hour Roadside Assistance**



Courtesy  
Transportation  

---

Trip Routing

**1-800-442-OLDS**  
(For vehicles purchased in Canada,  
call **1-800-268-6800**)  
that provides in an emergency:

- ▶ **Free** lockout assistance
- ▶ **Free** dead-battery assistance
- ▶ **Free** out-of-fuel assistance
- ▶ **Free** flat-tire change
- ▶ **Emergency** towing



# 2001 Oldsmobile Intrigue Owner's Manual

Litho in U.S.A.  
Part Number 10421957 A First Edition

© Copyright General Motors Corporation 2000  
All Rights Reserved



## Table of Contents

---



### *Seats and Restraint Systems*

- ▶ Seats and Seat Controls
- ▶ Safety Belts
- ▶ Supplemental Restraint System (SRS)
- ▶ Restraint Systems for Children



### *Features and Controls*

- ▶ Windows
- ▶ Keys and Door Locks
- ▶ Remote Keyless Entry System (If Equipped)
- ▶ Remote Trunk Release
- ▶ Automatic Transaxle
- ▶ Parking Brake
- ▶ Tilt Wheel
- ▶ Turn Signal/Multifunction Lever
- ▶ Windshield Wipers
- ▶ Cruise Control
- ▶ Exterior and Interior Lamps
- ▶ Mirrors
- ▶ Storage Compartments
- ▶ Convenience Net (If Equipped)
- ▶ Accessory Power Outlets
- ▶ OnStar® System (If Equipped)
- ▶ Power Sunroof (Option)
- ▶ Instrument Panel, Warning Lights and Gages



## Table of Contents (cont'd)

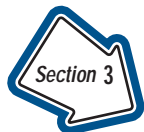

### *Comfort Controls and Audio Systems*

- ▶ Heating and Air Conditioning
- ▶ Setting the Radio Clock
- ▶ Radio/Cassette Player/CD Player
- ▶ Radio Theft-Deterrent Feature
- ▶ Steering Wheel Controls (If Equipped)



### *Your Driving and the Road*

- ▶ Defensive Driving
- ▶ Drunken Driving
- ▶ Control of Vehicle
- ▶ Braking
- ▶ Steering
- ▶ Driving Tips for Various Road Conditions
- ▶ Recreational Vehicle Towing
- ▶ Loading Your Vehicle
- ▶ Towing a Trailer

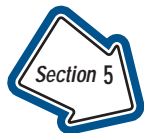

### *Problems on the Road*

- ▶ Hazard Warning Flashers
- ▶ Jump Starting
- ▶ Towing Your Vehicle
- ▶ Engine Overheating
- ▶ Changing a Flat Tire
- ▶ If You're Stuck



## Table of Contents (cont'd)

---



### *Service and Appearance Care*

- ▶ Fuel
- ▶ Checking Fluids and Lubricants
- ▶ GM Oil Life System™
- ▶ Engine Air Cleaner/Filter
- ▶ Passenger Compartment Air Filter
- ▶ Brakes
- ▶ Bulb Replacement
- ▶ Windshield Wiper Blade Replacement
- ▶ Tires and Wheels
- ▶ Appearance Care
- ▶ Electrical System/Fuses and Circuit Breakers
- ▶ Capacities and Specifications
- ▶ Normal Maintenance Replacement Parts



### *Maintenance Schedule*

- ▶ Scheduled Maintenance
- ▶ Owner Checks and Services
- ▶ Periodic Maintenance Inspections
- ▶ Recommended Fluids and Lubricants
- ▶ Maintenance Records



## Table of Contents (cont'd)

---

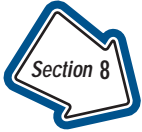

### *Customer Assistance Information*

- ▶ Customer Satisfaction Procedures
- ▶ Customer Assistance Offices
- ▶ Roadside Assistance and Courtesy Transportation
- ▶ Warranty Information (See Warranty Manual)
- ▶ Reporting Safety Defects on page 8-10
- ▶ Service Publications

Please refer to the last page of this manual for your *Service Station Guide*

---



GENERAL MOTORS, GM, the GM Emblem, OLDSMOBILE, the OLDSMOBILE Rocket Emblem and the name INTRIGUE are registered trademarks of General Motors Corporation.

This manual includes the latest information at the time it was printed. We reserve the right to make changes after that time without further notice. For vehicles first sold in Canada, substitute the name “General Motors of Canada Limited” for Oldsmobile Division whenever it appears in this manual.

Please keep this manual in your vehicle, so it will be there if you ever need it when you’re on the road. If you sell the vehicle, please leave this manual in it so the new owner can use it.



We support voluntary technician certification.

## For Canadian Owners Who Prefer a French Language Manual:

**Aux propriétaires canadiens:** Vous pouvez vous procurer un exemplaire de ce guide en français chez votre concessionnaire ou au:

Helm, Incorporated  
P.O. Box 07130  
Detroit, MI 48207



## How to Use this Manual

Many people read their owner's manual from beginning to end when they first receive their new vehicle. If you do this, it will help you learn about the features and controls for your vehicle. In this manual, you'll find that pictures and words work together to explain things quickly.

## Safety Warnings and Symbols

You will find a number of safety cautions in this book. We use a box and the word CAUTION to tell you about things that could hurt you if you were to ignore the warning.



**These mean there is something that could hurt you or other people.**

In the caution area, we tell you what the hazard is. Then we tell you what to do to help avoid or reduce the hazard. Please read these cautions. If you don't, you or others could be hurt.

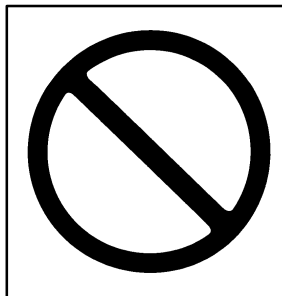

You will also find a circle with a slash through it in this book. This safety symbol means "Don't," "Don't do this" or "Don't let this happen."

## Vehicle Damage Warnings

Also in this book you will find these notices:

### **NOTICE:**

**These mean there is something that could damage your vehicle.**

In the notice area, we tell you about something that can damage your vehicle. Many times, this damage would not be covered by your warranty, and it could be costly. But the notice will tell you what to do to help avoid the damage.

When you read other manuals, you might see CAUTION and NOTICE warnings in different colors or in different words.

You'll also see warning labels on your vehicle. They use the same words, CAUTION or NOTICE.

## Vehicle Symbols

These are some of the symbols you may find on your vehicle. Also see “Warning Lights and Gages” in the Index.

For example, these symbols are used on an original battery:

CAUTION  
POSSIBLE  
INJURY



PROTECT  
EYES BY  
SHIELDING



CAUSTIC  
BATTERY  
ACID COULD  
CAUSE  
BURNS



AVOID  
SPARKS OR  
FLAMES



SPARK OR  
FLAME  
COULD  
EXPLODE  
BATTERY



These symbols are important for you and your passengers whenever your vehicle is driven:

CHILD  
RESTRAINT  
TOP STRAP  
ANCHOR



DOOR LOCK  
UNLOCK



FASTEN  
SEAT  
BELTS



POWER  
WINDOW



AIR BAG



These symbols have to do with your lamps:

MASTER  
LIGHTING  
SWITCH



TURN  
SIGNALS



PARKING  
LAMPS



HAZARD  
WARNING  
FLASHER



DAYTIME  
RUNNING  
LAMPS



FOG LAMPS



These symbols are on some of your controls:

WINDSHIELD  
WIPER



WINDSHIELD  
WASHER



WINDSHIELD  
DEFROSTER



REAR  
WINDOW  
DEFOGGER



VENTILATING  
FAN



These symbols are used on warning and indicator lights:

ENGINE  
COOLANT  
TEMP



BATTERY  
CHARGING  
SYSTEM



BRAKE



COOLANT



ENGINE OIL  
PRESSURE



ANTI-LOCK  
BRAKES



Here are some other symbols you may see:

FUSE



LIGHTER



HORN



FUEL



OWNER'S  
MANUAL



SERVICE  
MANUAL





## Service Station Guide

For a More Detailed Look at What's Under the Hood See Section 6

Battery See Section 6  
Windshield Washer Fluid See Section 6  
Cooling System See Section 5

Tire Pressure See Section 6

Hood Release See Section 6

Engine Oil Dipstick See Section 6

Oil Viscosity Engine Oil See Section 6

Fuel Use unleaded gas only. See Section 6 for octane ratings.

Spare Tire Pressure See Section 5

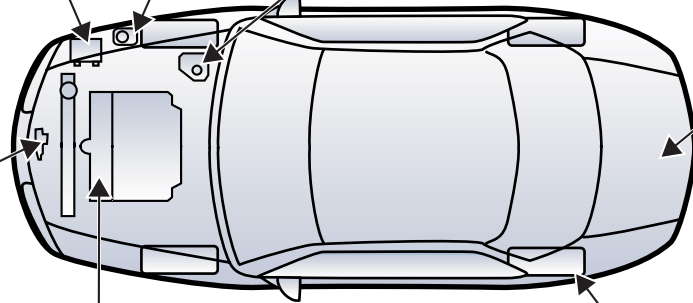



## Section 1 Seats and Restraint Systems

---

Here you'll find information about the seats in your vehicle and how to use your safety belts properly. You can also learn about some things you should *not* do with air bags and safety belts.

1-2	Seats and Seat Controls	1-30	Rear Safety Belt Comfort Guides for Children and Small Adults
1-6	Safety Belts: They're for Everyone	1-33	Center Passenger Position
1-11	Here Are Questions Many People Ask About Safety Belts -- and the Answers	1-34	Children
1-12	How to Wear Safety Belts Properly	1-38	Restraint Systems for Children
1-12	Driver Position	1-52	Older Children
1-19	Safety Belt Use During Pregnancy	1-55	Safety Belt Extender
1-20	Right Front Passenger Position	1-55	Checking Your Restraint Systems
1-21	Supplemental Restraint System (SRS)	1-55	Replacing Restraint System Parts After a Crash
1-27	Rear Seat Passengers		

## Seats and Seat Controls

This section tells you how to adjust the seats and explains reclining seatbacks, folding rear seats and head restraints.

### Manual Front Seat

#### CAUTION:

**You can lose control of the vehicle if you try to adjust a manual driver's seat while the vehicle is moving. The sudden movement could startle and confuse you, or make you push a pedal when you don't want to. Adjust the driver's seat only when the vehicle is not moving.**



Lift the lever, located under the front of the seat, upward using a twisting motion. This will unlock the seat. Slide the seat to where you want it and release the lever. Try to move the seat back and forth with your body to be sure the seat is locked into place.

## 6-Way Power Seat (If Equipped)



This switch is designed to imitate the movements of your seat cushion. It is located on the outboard side of both the driver's and the passenger's seat cushion.

To move the seat forward or rearward, slide the switch forward or rearward. To raise or lower the seat, push the switch up or down. To raise or lower the front portion of your seat, push the front of the switch up or down. To raise or lower the rear portion of your seat, push the rear of the switch up or down.

## Heated Front Seat (If Equipped)

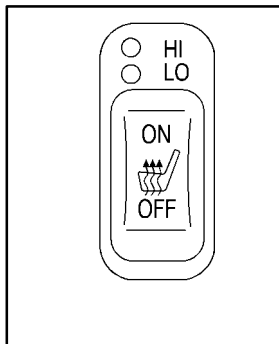

The driver's and passenger's heated seat switches are located on the instrument panel near the comfort controls.

The driver's switch is on the left, and the passenger's switch is on the right.

There are two settings, LO and HI. To choose the LO setting, press the top part of the toggle switch once. A light on the switch will glow when the LO setting has been selected.

To choose the HI setting, press the top part of the toggle switch twice. A light on the switch will glow when the HI setting has been selected.

To turn the system off, press the lower part of the toggle switch once. The light should go out when the system is not in use.

## Reclining Front Seatbacks



The levers for the driver's and the passenger's front seatbacks are located on the outboard side of each seat cushion. Lift the lever to release the seatback, then move the seatback to where you want it. Release the lever to lock the seatback in place. Pull up on the lever without pushing on the seatback and the seatback will move forward.



But don't have a seatback reclined if your vehicle is moving.



## **⚠ CAUTION:**

**Sitting in a reclined position when your vehicle is in motion can be dangerous. Even if you buckle up, your safety belts can't do their job when you're reclined like this.**

**The shoulder belt can't do its job because it won't be against your body. Instead, it will be in front of you. In a crash you could go into it, receiving neck or other injuries.**

**The lap belt can't do its job either. In a crash the belt could go up over your abdomen. The belt forces would be there, not at your pelvic bones. This could cause serious internal injuries.**

**For proper protection when the vehicle is in motion, have the seatback upright. Then sit well back in the seat and wear your safety belt properly.**

## **Head Restraints**



Slide the head restraint up or down so that the top of the restraint is closest to the top of your ears. This position reduces the chance of a neck injury in a crash.

## Split Folding Rear Seat (If Equipped)

This feature enables you to have direct access to the trunk from the rear seat of the vehicle.



To fold down the rear seatback, pull the seat tab latch forward or pull the remote release straps in the trunk.

To return the seat to its original position, push it back up and make sure it latches in the locked position by pulling and pushing on the seatback.

## Safety Belts: They're for Everyone

This part of the manual tells you how to use safety belts properly. It also tells you some things you should not do with safety belts.

And it explains the Supplemental Restraint System (SRS), or air bag system.

### CAUTION:

**Don't let anyone ride where he or she can't wear a safety belt properly. If you are in a crash and you're not wearing a safety belt, your injuries can be much worse. You can hit things inside the vehicle or be ejected from it. You can be seriously injured or killed. In the same crash, you might not be if you are buckled up. Always fasten your safety belt, and check that your passengers' belts are fastened properly too.**

 **CAUTION:**

**It is extremely dangerous to ride in a cargo area, inside or outside of a vehicle. In a collision, people riding in these areas are more likely to be seriously injured or killed. Do not allow people to ride in any area of your vehicle that is not equipped with seats and safety belts. Be sure everyone in your vehicle is in a seat and using a safety belt properly.**



Your vehicle has a light that comes on as a reminder to buckle up. See “Safety Belt Reminder Light” in the Index.

In most states and Canadian provinces, the law says to wear safety belts. Here’s why: *They work.*

You never know if you’ll be in a crash. If you do have a crash, you don’t know if it will be a bad one.

A few crashes are mild, and some crashes can be so serious that even buckled up a person wouldn’t survive. But most crashes are in between. In many of them, people who buckle up can survive and sometimes walk away. Without belts they could have been badly hurt or killed.

After more than 30 years of safety belts in vehicles, the facts are clear. In most crashes buckling up does matter ... a lot!

## Why Safety Belts Work

When you ride in or on anything, you go as fast as it goes.

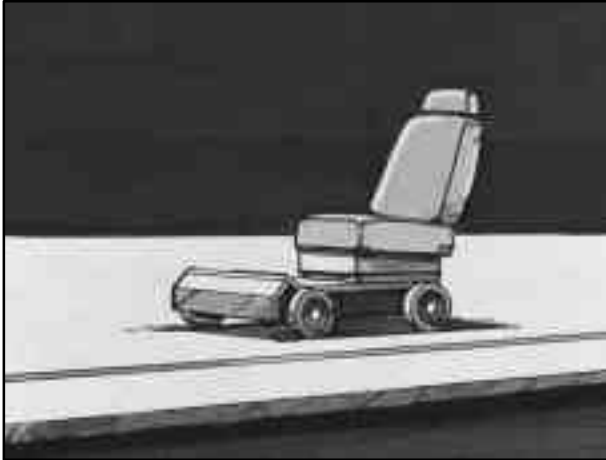

Take the simplest vehicle. Suppose it's just a seat on wheels.



Put someone on it.

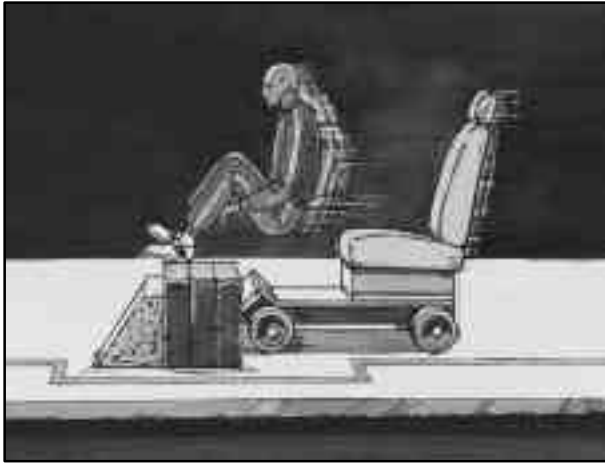

Get it up to speed. Then stop the vehicle. The rider doesn't stop.



The person keeps going until stopped by something. In a real vehicle, it could be the windshield ...



or the instrument panel ...

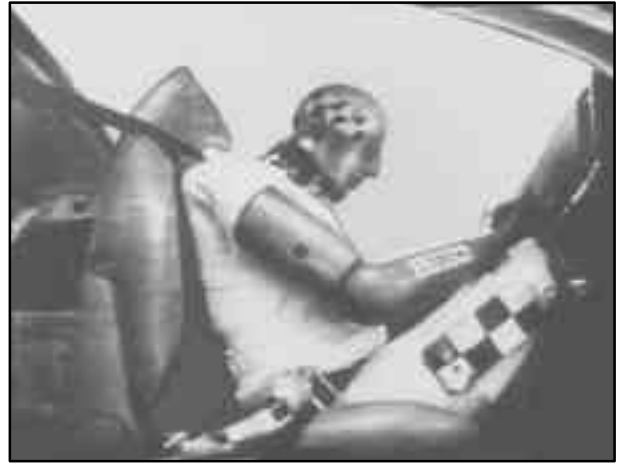

or the safety belts!

With safety belts, you slow down as the vehicle does. You get more time to stop. You stop over more distance, and your strongest bones take the forces. That's why safety belts make such good sense.

## Here Are Questions Many People Ask About Safety Belts -- and the Answers

**Q:** Won't I be trapped in the vehicle after an accident if I'm wearing a safety belt?

**A:** You *could* be -- whether you're wearing a safety belt or not. But you can unbuckle a safety belt, even if you're upside down. And your chance of being conscious during and after an accident, so you *can* unbuckle and get out, is *much* greater if you are belted.

**Q:** If my vehicle has air bags, why should I have to wear safety belts?

**A:** Air bags are in many vehicles today and will be in most of them in the future. But they are supplemental systems only; so they work *with* safety belts -- not instead of them. Every air bag system ever offered for sale has required the use of safety belts. Even if you're in a vehicle that has air bags, you still have to buckle up to get the most protection. That's true not only in frontal collisions, but especially in side and other collisions.

**Q:** If I'm a good driver, and I never drive far from home, why should I wear safety belts?

**A:** You may be an excellent driver, but if you're in an accident -- even one that isn't your fault -- you and your passengers can be hurt. Being a good driver doesn't protect you from things beyond your control, such as bad drivers.

Most accidents occur within 25 miles (40 km) of home. And the greatest number of serious injuries and deaths occur at speeds of less than 40 mph (65 km/h).

Safety belts are for everyone.

# How to Wear Safety Belts Properly

## Adults

This part is only for people of adult size.

Be aware that there are special things to know about safety belts and children. And there are different rules for smaller children and babies. If a child will be riding in your vehicle, see the part of this manual called “Children.” Follow those rules for everyone’s protection.

First, you’ll want to know which restraint systems your vehicle has.

We’ll start with the driver position.

## Driver Position

This part describes the driver’s restraint system.

### Lap-Shoulder Belt

The driver has a lap-shoulder belt. Here’s how to wear it properly.

1. Close and lock the door.
2. Adjust the seat so you can sit up straight. To see how, see “Seats” in the Index.



3. Pick up the latch plate and pull the belt across you. Don’t let it get twisted.

The shoulder belt may lock if you pull the belt across you very quickly. If this happens, let the belt go back slightly to unlock it. Then pull the belt across you more slowly.

4. Push the latch plate into the buckle until it clicks.



Pull up on the latch plate to make sure it is secure. If the belt isn't long enough, see "Safety Belt Extender" at the end of this section.

Make sure the release button on the buckle is positioned so you would be able to unbuckle the safety belt quickly if you ever had to.



5. To make the lap part tight, pull down on the buckle end of the belt as you pull up on the shoulder belt.

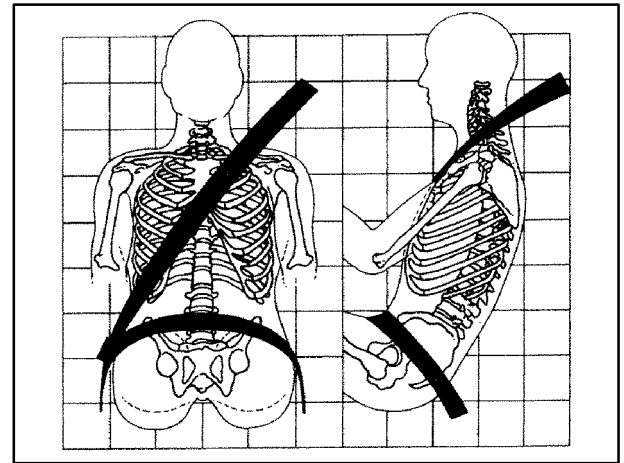

The lap part of the belt should be worn low and snug on the hips, just touching the thighs. In a crash, this applies force to the strong pelvic bones. And you'd be less likely to slide under the lap belt. If you slid under it, the belt would apply force at your abdomen. This could cause serious or even fatal injuries. The shoulder belt should go over the shoulder and across the chest. These parts of the body are best able to take belt restraining forces.

The safety belt locks if there's a sudden stop or crash, or if you pull the belt very quickly out of the retractor.

## Shoulder Belt Height Adjuster

Before you begin to drive, move the shoulder belt adjuster to the height that is right for you.



To move it down, squeeze the release lever and the shoulder belt guide as shown and move the height adjuster to the desired position. You can move the adjuster up just by pushing up on the shoulder belt guide. After you move the adjuster to where you want it, try to move it down without squeezing the release lever to make sure it has locked into position.

Adjust the height so that the shoulder portion of the belt is centered on your shoulder. The belt should be away from your face and neck, but not falling off your shoulder.

**Q:** What's wrong with this?

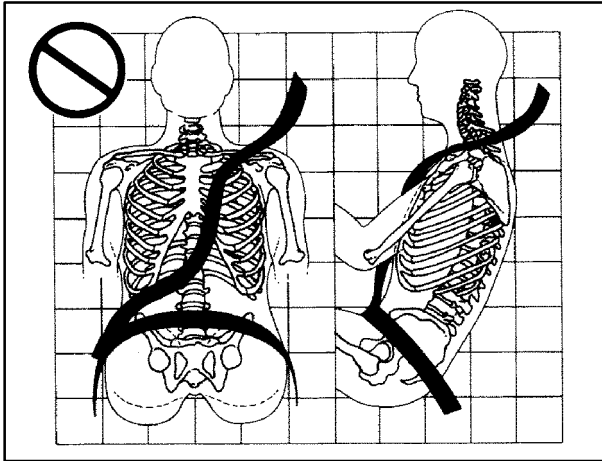

**A:** The shoulder belt is too loose. It won't give nearly as much protection this way.

**⚠ CAUTION:**

You can be seriously hurt if your shoulder belt is too loose. In a crash, you would move forward too much, which could increase injury. The shoulder belt should fit against your body.

**Q:** What's wrong with this?

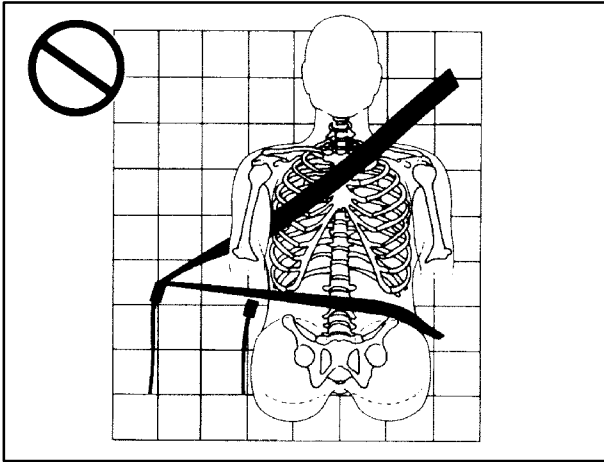

**A:** The belt is buckled in the wrong place.

**⚠ CAUTION:**

You can be seriously injured if your belt is buckled in the wrong place like this. In a crash, the belt would go up over your abdomen. The belt forces would be there, not at the pelvic bones. This could cause serious internal injuries. Always buckle your belt into the buckle nearest you.

**Q:** What's wrong with this?

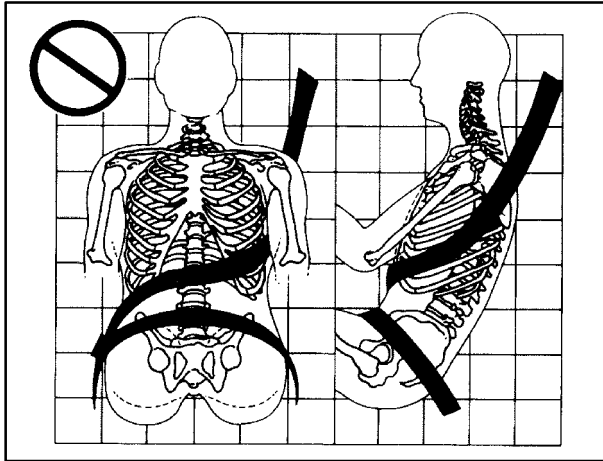

**A:** The shoulder belt is worn under the arm. It should be worn over the shoulder at all times.

**⚠ CAUTION:**

You can be seriously injured if you wear the shoulder belt under your arm. In a crash, your body would move too far forward, which would increase the chance of head and neck injury. Also, the belt would apply too much force to the ribs, which aren't as strong as shoulder bones. You could also severely injure internal organs like your liver or spleen.

**Q:** What's wrong with this?

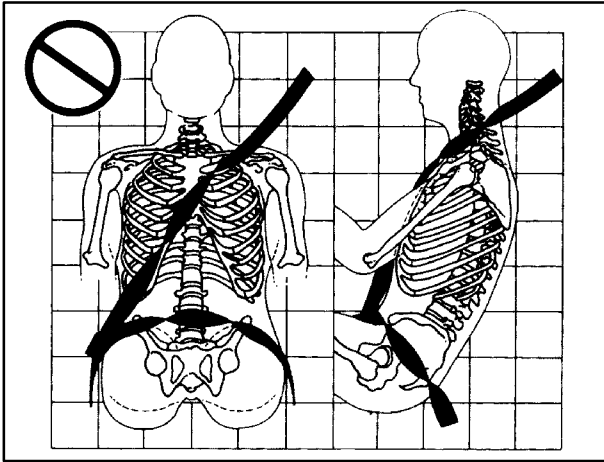

**A:** The belt is twisted across the body.

**⚠ CAUTION:**

You can be seriously injured by a twisted belt. In a crash, you wouldn't have the full width of the belt to spread impact forces. If a belt is twisted, make it straight so it can work properly, or ask your dealer to fix it.



To unlatch the belt, just push the button on the buckle. The belt should go back out of the way.

Before you close the door, be sure the belt is out of the way. If you slam the door on it, you can damage both the belt and your vehicle.

## Safety Belt Use During Pregnancy

Safety belts work for everyone, including pregnant women. Like all occupants, they are more likely to be seriously injured if they don't wear safety belts.

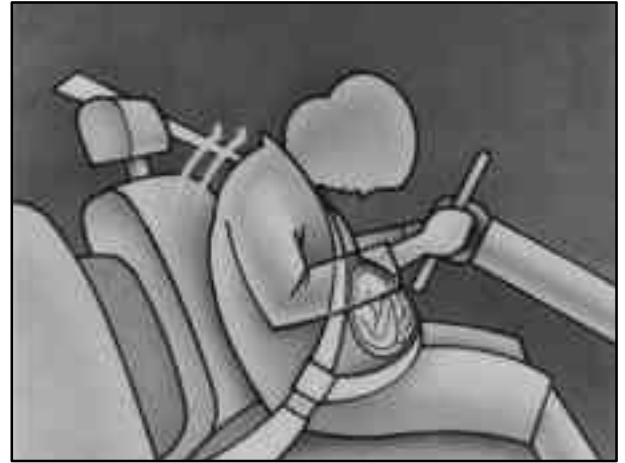

A pregnant woman should wear a lap-shoulder belt, and the lap portion should be worn as low as possible, below the rounding, throughout the pregnancy.

The best way to protect the fetus is to protect the mother. When a safety belt is worn properly, it's more likely that the fetus won't be hurt in a crash. For pregnant women, as for anyone, the key to making safety belts effective is wearing them properly.

## **Right Front Passenger Position**

To learn how to wear the right front passenger's safety belt properly, see "Driver Position" earlier in this section.

The right front passenger's safety belt works the same way as the driver's safety belt -- except for two things.



If the belt stops before it reaches the buckle, tilt the latch plate and keep pulling until you can buckle the belt.

On some vehicles, if you pull the shoulder portion of the belt out all the way, you will engage the child restraint locking feature. If this happens, just let the belt go back all the way and start again.



## Supplemental Restraint System (SRS)

This part explains the Supplemental Restraint System (SRS) or air bag system.

Your vehicle has air bags -- one air bag for the driver and another air bag for the right front passenger.

Frontal air bags are designed to help reduce the risk of injury from the force of an inflating air bag. But these air bags must inflate very quickly to do their job and comply with federal regulations.

Here are the most important things to know about the air bag system:

### CAUTION:

**You can be severely injured or killed in a crash if you aren't wearing your safety belt -- even if you have air bags. Wearing your safety belt during a crash helps reduce your chance of hitting things inside the vehicle or being ejected from it. Air bags are "supplemental restraints" to the safety belts. All air bags are designed to work with safety belts, but don't replace them. Air bags are designed to work only in moderate to severe crashes where the front of your vehicle hits something. They aren't designed to inflate at all in rollover, rear, side or low-speed frontal crashes. And, for unrestrained occupants, air bags may provide less protection in frontal crashes than more forceful air bags have provided in the past. Everyone in your vehicle should wear a safety belt properly -- whether or not there's an air bag for that person.**

**⚠ CAUTION:**

Air bags inflate with great force, faster than the blink of an eye. If you're too close to an inflating air bag, as you would be if you were leaning forward, it could seriously injure you. Safety belts help keep you in position before and during a crash. Always wear your safety belt, even with air bags. The driver should sit as far back as possible while still maintaining control of the vehicle.

**⚠ CAUTION:**

Anyone who is up against, or very close to, any air bag when it inflates can be seriously injured or killed. Air bags plus lap-shoulder belts offer the best protection for adults, but not for young  
**CAUTION: (Continued)**

**CAUTION: (Continued)**

children and infants. Neither the vehicle's safety belt system nor its air bag system is designed for them. Young children and infants need the protection that a child restraint system can provide. Always secure children properly in your vehicle. To read how, see the part of this manual called "Children."



There is an air bag readiness light on the instrument panel, which shows the air bag symbol.

The system checks the air bag electrical system for malfunctions. The light tells you if there is an electrical problem. See "Air Bag Readiness Light" in the Index for more information.

## How the Air Bag System Works



### Where are the air bags?

The driver's air bag is in the middle of the steering wheel.



The right front passenger's air bag is in the instrument panel on the passenger's side.

 **CAUTION:**

**If something is between an occupant and an air bag, the bag might not inflate properly or it might force the object into that person. The path of an inflating air bag must be kept clear. Don't put anything between an occupant and an air bag, and don't attach or put anything on the steering wheel hub or on or near any other air bag covering.**

### **When should an air bag inflate?**

An air bag is designed to inflate in a moderate to severe frontal or near-frontal crash. The air bag will inflate only if the impact speed is above the system's designed "threshold level." If your vehicle goes straight into a wall that doesn't move or deform, the threshold level is about 12 to 18 mph (19 to 29 km/h).

The threshold level can vary, however, with specific vehicle design, so that it can be somewhat above or below this range. If your vehicle strikes something that will move or deform, such as a parked car, the threshold level will be higher. The air bag is not designed to inflate in rollovers, side impacts or rear impacts, because inflation would not help the occupant.

In any particular crash, no one can say whether an air bag should have inflated simply because of the damage to a vehicle or because of what the repair costs were. Inflation is determined by the angle of the impact and how quickly the vehicle slows down in frontal or near-frontal impacts.

### **What makes an air bag inflate?**

In an impact of sufficient severity, the air bag sensing system detects that the vehicle is in a crash. The sensing system triggers a release of gas from the inflator, which inflates the air bag. The inflator, air bag and related hardware are all part of the air bag modules inside the steering wheel and in the instrument panel in front of the right front passenger.

## How does an air bag restrain?

In moderate to severe frontal or near-frontal collisions, even belted occupants can contact the steering wheel or the instrument panel. Air bags supplement the protection provided by safety belts. Air bags distribute the force of the impact more evenly over the occupant's upper body, stopping the occupant more gradually. But air bags would not help you in many types of collisions, including rollovers, rear impacts and side impacts, primarily because an occupant's motion is not toward those air bags. Air bags should never be regarded as anything more than a supplement to safety belts, and then only in moderate to severe frontal or near-frontal collisions.

## What will you see after an air bag inflates?

After an air bag inflates, it quickly deflates, so quickly that some people may not even realize the air bag inflated. Some components of the air bag module -- the steering wheel hub for the driver's air bag, or the instrument panel for the right front passenger's bag -- will be hot for a short time. The parts of the bag that come into contact with you may be warm, but not too hot to touch. There will be some smoke and dust coming from vents in the deflated air bags. Air bag inflation doesn't prevent the driver from seeing or from being able to steer the vehicle, nor does it stop people from leaving the vehicle.

## CAUTION:

**When an air bag inflates, there is dust in the air. This dust could cause breathing problems for people with a history of asthma or other breathing trouble. To avoid this, everyone in the vehicle should get out as soon as it is safe to do so. If you have breathing problems but can't get out of the vehicle after an air bag inflates, then get fresh air by opening a window or door.**

In many crashes severe enough to inflate an air bag, windshields are broken by vehicle deformation. Additional windshield breakage may also occur from the right front passenger air bag.

- Air bags are designed to inflate only once. After they inflate, you'll need some new parts for your air bag system. If you don't get them, the air bag system won't be there to help protect you in another crash. A new system will include air bag modules and possibly other parts. The service manual for your vehicle covers the need to replace other parts.
- Your vehicle is equipped with a crash sensing and diagnostic module, which records information about the air bag system. The module records information about the readiness of the system, when the system commands air bag inflation and driver's safety belt usage at deployment. The module also records speed, engine rpm, brake and throttle data.

- Let only qualified technicians work on your air bag system. Improper service can mean that your air bag system won't work properly. See your dealer for service.

## **NOTICE:**

**If you damage the covering for the driver's or the right front passenger's air bag, the bag may not work properly. You may have to replace the air bag module in the steering wheel or both the air bag module and the instrument panel for the right front passenger's air bag. Do not open or break the air bag coverings.**

## Servicing Your Air Bag-Equipped Vehicle

Air bags affect how your vehicle should be serviced. There are parts of the air bag system in several places around your vehicle. You don't want the system to inflate while someone is working on your vehicle. Your dealer and the service manual have information about servicing your vehicle and the air bag system. To purchase a service manual, see "Service and Owner Publications" in the Index.

### CAUTION:

**For up to 10 seconds after the ignition key is turned off and the battery is disconnected, an air bag can still inflate during improper service. You can be injured if you are close to an air bag when it inflates. Avoid yellow connectors. They are probably part of the air bag system. Be sure to follow proper service procedures, and make sure the person performing work for you is qualified to do so.**

The air bag system does not need regular maintenance.

## Rear Seat Passengers

It's very important for rear seat passengers to buckle up! Accident statistics show that unbelted people in the rear seat are hurt more often in crashes than those who are wearing safety belts.

Rear passengers who aren't safety belted can be thrown out of the vehicle in a crash. And they can strike others in the vehicle who are wearing safety belts.

## Rear Seat Outside Passenger Positions

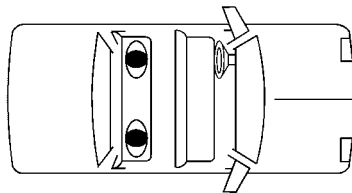

## Lap-Shoulder Belt

The positions next to the windows have lap-shoulder belts. Here's how to wear one properly.



1. Pick up the latch plate and pull the belt across you. Don't let it get twisted.

The shoulder belt may lock if you pull the belt across you very quickly. If this happens, let the belt go back slightly to unlock it. Then pull the belt across you more slowly.

2. Push the latch plate into the buckle until it clicks.

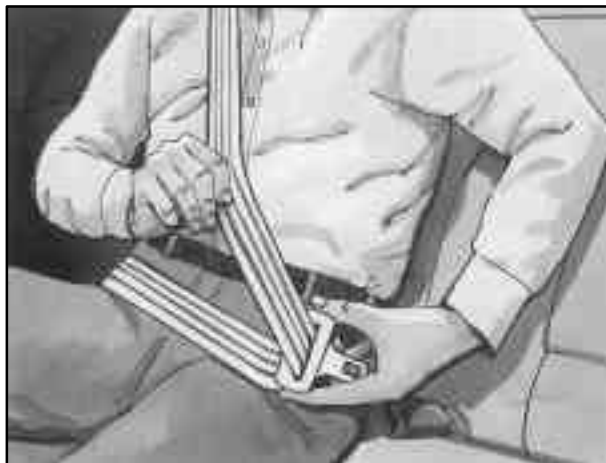

If the belt stops before it reaches the buckle, tilt the latch plate and keep pulling until you can buckle it. Pull up on the latch plate to make sure it is secure.



On some vehicles, when the shoulder belt is pulled out all the way, it will lock. If it does, let it go back all the way and start again. If the belt is not long enough, see “Safety Belt Extender” at the end of this section. Make sure the release button on the buckle is positioned so you would be able to unbuckle the safety belt quickly if you ever had to.



3. To make the lap part tight, pull down on the buckle end of the belt as you pull up on the shoulder part.

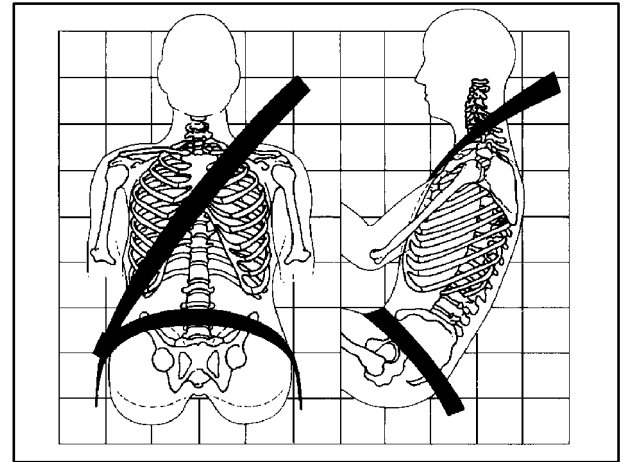

The lap part of the belt should be worn low and snug on the hips, just touching the thighs. In a crash, this applies force to the strong pelvic bones. And you’d be less likely to slide under the lap belt. If you slid under it, the belt would apply force at your abdomen. This could cause serious or even fatal injuries. The shoulder belt should go over the shoulder and across the chest. These parts of the body are best able to take belt restraining forces.

The safety belt locks if there’s a sudden stop or a crash, or if you pull the belt very quickly out of the retractor.

**⚠ CAUTION:**

**You can be seriously hurt if your shoulder belt is too loose. In a crash, you would move forward too much, which could increase injury. The shoulder belt should fit against your body.**



To unlatch the belt, just push the button on the buckle.

## **Rear Safety Belt Comfort Guides for Children and Small Adults**

Rear shoulder belt comfort guides will provide added safety belt comfort for older children who have outgrown booster seats and for small adults. When installed on a shoulder belt, the comfort guide better positions the belt away from the neck and head.

There is one guide for each outside passenger position in the rear seat. To provide added safety belt comfort for children who have outgrown child restraints and for smaller adults, the comfort guides may be installed on the shoulder belts. Here's how to install a comfort guide and use the safety belt:



1. Pull the elastic cord out from between the edge of the seatback and the interior body to remove the guide from its storage clip.



2. Slide the guide under and past the belt. The elastic cord must be under the belt. Then, place the guide over the belt, and insert the two edges of the belt into the slots of the guide.

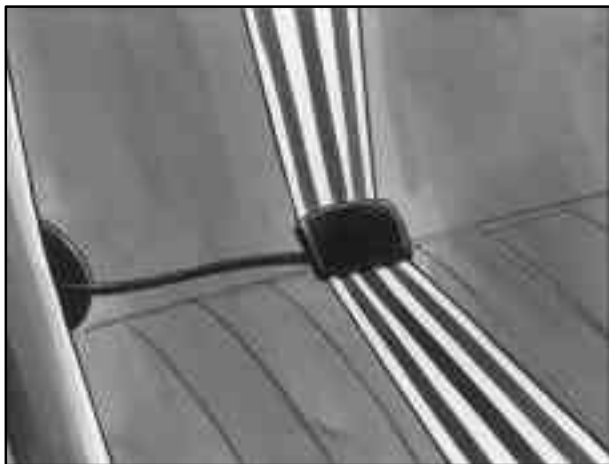

3. Be sure that the belt is not twisted and it lies flat. The elastic cord must be under the belt and the guide on top.



4. Buckle, position and release the safety belt as described in “Rear Seat Outside Passenger Positions” earlier in this section. Make sure that the shoulder belt crosses the shoulder.

To remove and store the comfort guides, squeeze the belt edges together so that you can take them out from the guides. Pull the guide upward to expose its storage clip, and then slide the guide onto the clip. Turn the guide and clip inward and place them in between the seatback and the interior body, leaving only the loop of elastic cord exposed.

## Center Passenger Position

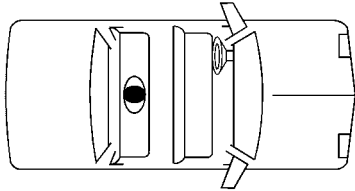

## Lap Belt



When you sit in the center seating position, you have a lap safety belt, which has no retractor. To make the belt longer, tilt the latch plate and pull it along the belt.



To make the belt shorter, pull its free end as shown until the belt is snug.

Buckle, position and release it the same way as the lap part of a lap-shoulder belt. If the belt isn't long enough, see "Safety Belt Extender" at the end of this section.

Make sure the release button on the buckle is positioned so you would be able to unbuckle the safety belt quickly if you ever had to.

## Children

Everyone in a vehicle needs protection! This includes infants and all other children. Neither the distance traveled nor the age and size of the traveler changes the need, for everyone, to use safety restraints. In fact, the law in every state in the United States and in every Canadian province says children up to some age must be restrained while in a vehicle.

### Infants and Young Children

Every time infants and young children ride in vehicles, they should have the protection provided by the appropriate restraint. Young children should not use the vehicle's safety belts, unless there is no other choice.



**CAUTION: (Continued)**

For example, in a crash at only 25 mph (40 km/h), a 12-lb. (5.5 kg) baby will suddenly become a 240-lb. (110 kg) force on a person's arms. A baby should be secured in an appropriate restraint.

**⚠ CAUTION:**

People should never hold a baby in their arms while riding in a vehicle. A baby doesn't weigh much -- until a crash. During a crash a baby will become so heavy it is not possible to hold it.

**CAUTION: (Continued)**



 **CAUTION:**

**Children who are up against, or very close to, any air bag when it inflates can be seriously injured or killed. Air bags plus lap-shoulder belts offer outstanding protection for adults and older children, but not for young children and infants. Neither the vehicle's safety belt system nor its air bag system is designed for them. Young children and infants need the protection that a child restraint system can provide.**

**Q:** What are the different types of add-on child restraints?

**A:** Add-on child restraints, which are purchased by the vehicle's owner, are available in four basic types. Selection of a particular restraint should take into consideration not only the child's weight, height and age but also whether or not the restraint will be compatible with the motor vehicle in which it will be used.

For most basic types of child restraints, there are many different models available. When purchasing a child restraint, be sure it is designed to be used in a motor vehicle. If it is, the restraint will have a label saying that it meets federal motor vehicle safety standards.

The restraint manufacturer's instructions that come with the restraint state the weight and height limitations for a particular child restraint. In addition, there are many kinds of restraints available for children with special needs.





## **CAUTION:**

Newborn infants need complete support, including support for the head and neck. This is necessary because a newborn infant's neck is weak and its head weighs so much compared with the rest of its body. In a crash, an infant in a rear-facing seat settles into the restraint, so the crash forces can be distributed across the strongest part of an infant's body, the back and shoulders. Infants always should be secured in appropriate infant restraints.



## **CAUTION:**

The body structure of a young child is quite unlike that of an adult or older child, for whom the safety belts are designed. A young child's hip bones are still so small that vehicle's regular safety belt may not remain low on the hip bones, as it should. Instead, it may settle up around the child's abdomen. In a crash, the belt would apply force on a body area that's unprotected by any bony structure. This alone could cause serious or fatal injuries. Young children always should be secured in appropriate child restraints.

## Restraint Systems for Children

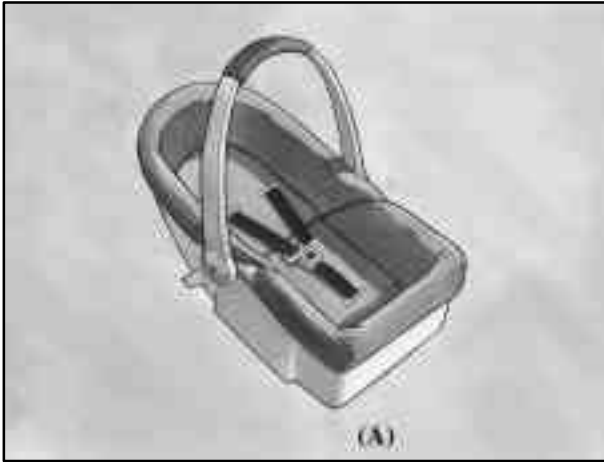

An infant car bed (A), a special bed made for use in a motor vehicle, is an infant restraint system designed to restrain or position a child on a continuous flat surface. Make sure that the infant's head rests toward the center of the vehicle.

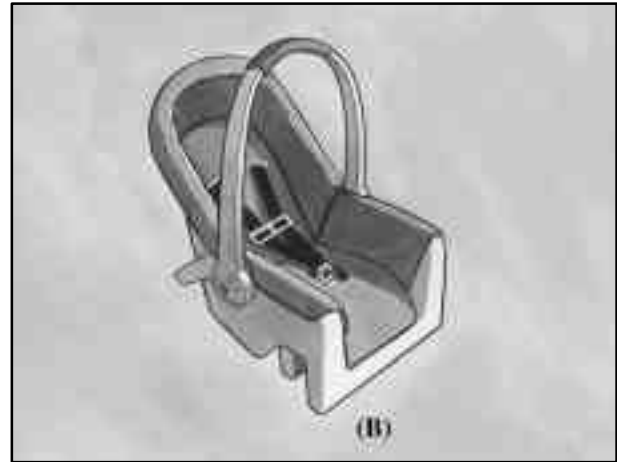

A rear-facing infant seat (B) provides restraint with the seating surface against the back of the infant. The harness system holds the infant in place and, in a crash, acts to keep the infant positioned in the restraint.

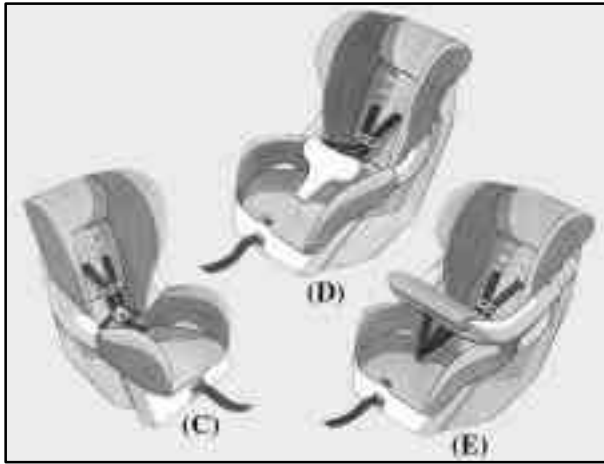

A forward-facing child seat (C-E) provides restraint for the child's body with the harness and also sometimes with surfaces such as T-shaped or shelf-like shields.

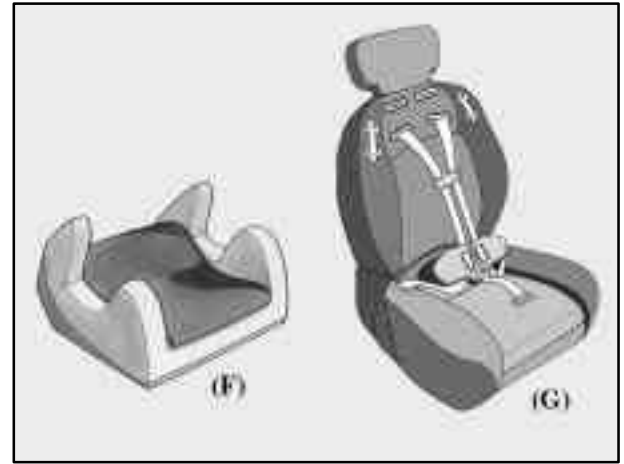

A booster seat (F-G) is a child restraint designed to improve the fit of the vehicle's safety belt system. Some booster seats have a shoulder belt positioner, and some high-back booster seats have a five-point harness. A booster seat can also help a child to see out the window.

**Q: How do child restraints work?**

**A:** A child restraint system is any device designed for use in a motor vehicle to restrain, seat, or position children. A built-in child restraint system is a permanent part of the motor vehicle. An add-on child restraint system is a portable one, which is purchased by the vehicle's owner.

For many years, add-on child restraints have used the adult belt system in the vehicle. To help reduce the chance of injury, the child also has to be secured within the restraint. The vehicle's belt system secures the add-on child restraint in the vehicle, and the add-on child restraint's harness system holds the child in place within the restraint.

One system, the three-point harness, has straps that come down over each of the infant's shoulders and buckle together at the crotch. The five-point harness system has two shoulder straps, two hip straps and a crotch strap. A shield may take the place of hip straps.

A T-shaped shield has shoulder straps that are attached to a flat pad which rests low against the child's body. A shelf- or armrest-type shield has straps that are attached to a wide, shelf-like shield that swings up or to the side.

When choosing a child restraint, be sure the child restraint is designed to be used in a vehicle. If it is, it will have a label saying that it meets federal motor vehicle safety standards.

Then follow the instructions for the restraint. You may find these instructions on the restraint itself or in a booklet, or both. These restraints use the belt system in your vehicle, but the child also has to be secured within the restraint to help reduce the chance of personal injury. When securing an add-on child restraint, refer to the instructions that come with the restraint which may be on the restraint itself or in a booklet, or both, and to this manual. The child restraint instructions are important, so if they are not available, obtain a replacement copy from the manufacturer.

## Where to Put the Restraint

Accident statistics show that children are safer if they are restrained in the rear rather than the front seat. General Motors, therefore, recommends that child restraints be secured in the rear seat including an infant riding in a rear-facing infant seat, a child riding in a forward-facing child seat and an older child riding in a booster seat. *Never* put a rear-facing child restraint in the front passenger seat. Here's why:

### CAUTION:

**A child in a rear-facing child restraint can be seriously injured or killed if the right front passenger's air bag inflates. This is because the back of the rear-facing child restraint would be very close to the inflating air bag. Always secure a rear-facing child restraint in a rear seat.**

**You may secure a forward-facing child restraint in the right front seat, but before you do, always move the front passenger seat as far back as it will go. It's better to secure the child restraint in a rear seat.**

Wherever you install it, be sure to secure the child restraint properly.

Keep in mind that an unsecured child restraint can move around in a collision or sudden stop and injure people in the vehicle. Be sure to properly secure any child restraint in your vehicle -- even when no child is in it.

## Top Strap

Some child restraints have a top strap, or "top tether." It can help restrain the child restraint during a collision. For it to work, a top strap must be properly anchored to the vehicle.

If the child restraint does not have a top strap, one can be obtained, in kit form, for many child restraints. Ask the child restraint manufacturer whether or not a kit is available.

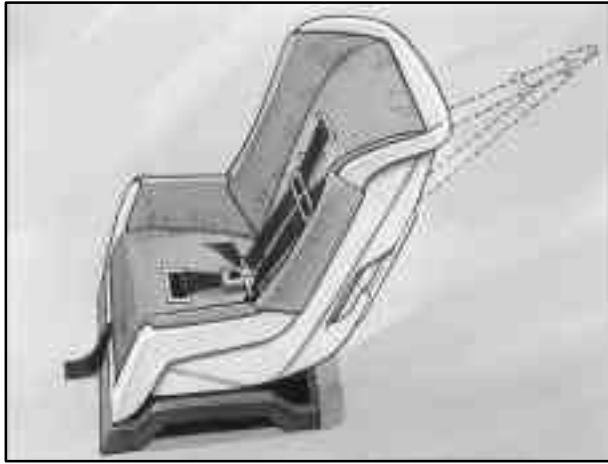

In Canada, the law requires that forward-facing child restraints have a top strap, and that the strap be anchored. In the United States, some child restraints also have a top strap. If your child restraint has a top strap, it should be anchored.

Your vehicle has top strap anchors already installed for the rear seating positions. You'll find them behind the rear seat on the filler panel.

In order to get to a bracket, you'll have to open the trim cover.

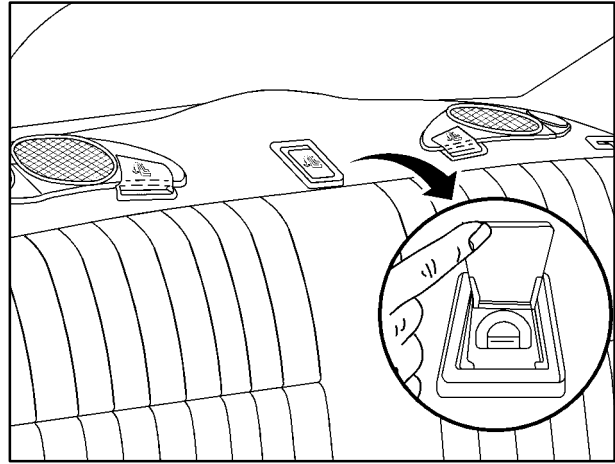

Anchor the top strap to one of these anchor points. Be sure to use an anchor point located on the same side of the vehicle as the seating position where the child restraint will be placed.

Once you have the top strap anchored, you'll be ready to secure the child restraint itself. Tighten the top strap when and as the child restraint manufacturer's instructions say.

## Securing a Child Restraint in a Rear Outside Seat Position

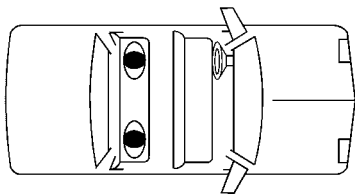

You'll be using the lap-shoulder belt. See the earlier part about the top strap if the child restraint has one. Be sure to follow the instructions that came with the child restraint. Secure the child in the child restraint when and as the instructions say.

1. Put the restraint on the seat.
2. Pick up the latch plate, and run the lap and shoulder portions of the vehicle's safety belt through or around the restraint. The child restraint instructions will show you how.

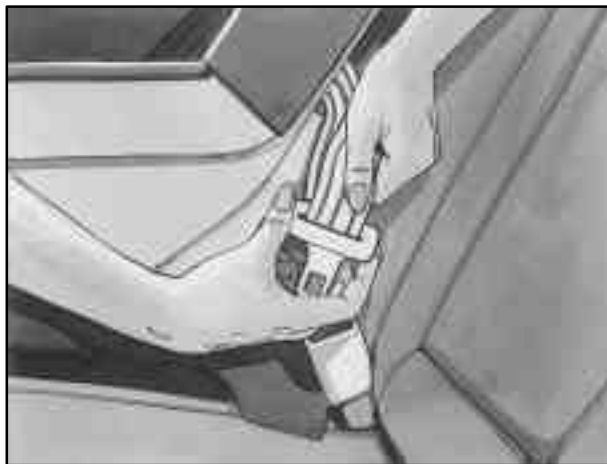

Tilt the latch plate to adjust the belt if needed.

If the shoulder belt goes in front of the child's face or neck, put it behind the child restraint.



3. Buckle the belt. Make sure the release button is positioned so you would be able to unbuckle the safety belt quickly if you ever had to.



4. Some vehicles have a child restraint locking feature on the shoulder belt retractor. You can tell if your vehicle has this feature by pulling the shoulder belt all the way out of the retractor. Then, let the belt go back a few inches, and try to pull the belt out again. If you can't pull the belt out because it has locked, it means the retractor has the child restraint locking feature.



If the belt doesn't lock and you can pull the belt out of the retractor again, it means your vehicle doesn't have the child restraint locking feature on the shoulder belt retractor.



- If your vehicle has the child restraint locking feature on the shoulder belt retractor, pull the rest of the shoulder belt all the way out of the retractor to set the lock.

To tighten the belt, feed the shoulder belt back into the retractor while you push down on the child restraint. If you're using a forward-facing child restraint, you may find it helpful to use your knee to push down on the child restraint as you tighten the belt.

- If your vehicle doesn't have the child restraint locking feature on the shoulder belt retractor, tighten the belt by pulling up on the shoulder belt while you push down on the child restraint. If you're using a forward-facing child restraint you may find it helpful to use your knee to push down on the child restraint as you tighten the belt.
5. Push and pull the child restraint in different directions to be sure it is secure.

To remove the child restraint, just unbuckle the vehicle's safety belt and let it go back all the way. The safety belt will move freely again and be ready to work for an adult or larger child passenger.

## Securing a Child Restraint in the Center Rear Seat Position

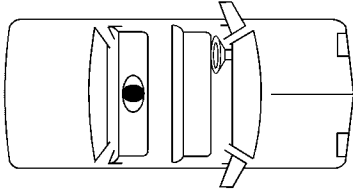

You'll be using the lap belt. Be sure to follow the instructions that came with the child restraint. Secure the child in the child restraint when and as the instructions say.

See the earlier part about the top strap if the child restraint has one.



1. Make the belt as long as possible by tilting the latch plate and pulling it along the belt.
2. Put the restraint on the seat.
3. Run the vehicle's safety belt through or around the restraint. The child restraint instructions will show you how.



4. Buckle the belt. Make sure the release button is positioned so you would be able to unbuckle the safety belt quickly if you ever had to.
  5. To tighten the belt, pull its free end while you push down on the child restraint. If you're using a forward-facing child restraint, you may find it helpful to use your knee to push down on the child restraint as you tighten the belt.
  6. Push and pull the child restraint in different directions to be sure it is secure.
- To remove the child restraint, just unbuckle the vehicle's safety belt. It will be ready to work for an adult or larger child passenger.

## Securing a Child Restraint in the Right Front Seat Position

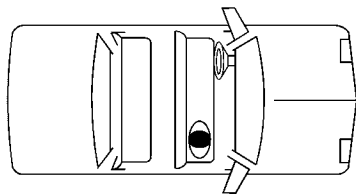

Your vehicle has a right front passenger air bag. *Never* put a rear-facing child restraint in this seat. Here's why:

### CAUTION:

**A child in a rear-facing child restraint can be seriously injured or killed if the right front passenger's air bag inflates. This is because the back of the rear-facing child restraint would be very close to the inflating air bag. Always secure a rear-facing child restraint in the rear seat.**

Although a rear seat is a safer place, you can secure a forward-facing child restraint in the right front seat.

You'll be using the lap-shoulder belt. See the earlier part about the top strap if the child restraint has one. Be sure to follow the instructions that came with the child restraint. Secure the child in the child restraint when and as the instructions say.

1. Because your vehicle has a right front passenger air bag, always move the seat as far back as it will go before securing a forward-facing child restraint. See "Seats" in the Index.
2. Put the restraint on the seat.
3. Pick up the latch plate, and run the lap and shoulder portions of the vehicle's safety belt through or around the restraint. The child restraint instructions will show you how.



Tilt the latch plate to adjust the belt if needed.

If the shoulder belt goes in front of the child's face or neck, put it behind the child restraint.



4. Buckle the belt. Make sure the release button is positioned so you would be able to unbuckle the safety belt quickly if you ever had to.



5. Some vehicles have a child restraint locking feature on the shoulder belt retractor. You can tell if your vehicle has this feature by pulling the shoulder belt all the way out of the retractor. Then, let the belt go back a few inches, and try to pull the belt out again. If you can't pull the belt out because it has locked, it means the retractor has the child restraint locking feature. If the belt doesn't lock and you can pull the belt out of the retractor again, it means your vehicle doesn't have the child restraint locking feature on the shoulder belt retractor.

- If your vehicle has the child restraint locking feature on the shoulder belt retractor, pull the rest of the shoulder belt all the way out of the retractor to set the lock.

To tighten the belt, feed the shoulder belt back into the retractor while you push down on the child restraint. You may find it helpful to use your knee to push down on the child restraint as you tighten the belt.

- If your vehicle doesn't have the child restraint locking feature on the shoulder belt retractor, tighten the belt by pulling up on the shoulder belt while you push down on the child restraint. You may find it helpful to use your knee to push down on the child restraint as you tighten the belt.



6. Push and pull the child restraint in different directions to be sure it is secure.

To remove the child restraint, just unbuckle the vehicle's safety belt and let it go back all the way. The safety belt will move freely again and be ready to work for an adult or larger child passenger.

## Older Children



Older children who have outgrown booster seats should wear the vehicle's safety belts.

If you have the choice, a child should sit next to a window so the child can wear a lap-shoulder belt and get the additional restraint a shoulder belt can provide.

**Q:** What is the proper way to wear safety belts?

**A:** If possible, an older child should wear a lap-shoulder belt and get the additional restraint a shoulder belt can provide. The shoulder belt should not cross the face or neck. The lap belt should fit snugly below the hips, just touching the top of the thighs. It should never be worn over the abdomen, which could cause severe or even fatal internal injuries in a crash.

Accident statistics show that children are safer if they are restrained in the rear seat.

In a crash, children who are not buckled up can strike other people who are buckled up, or can be thrown out of the vehicle. Older children need to use safety belts properly.





**⚠ CAUTION:**

**Never do this.**

**Here two children are wearing the same belt. The belt can't properly spread the impact forces. In a crash, the two children can be crushed together and seriously injured. A belt must be used by only one person at a time.**

**Q:** What if a child is wearing a lap-shoulder belt, but the child is so small that the shoulder belt is very close to the child's face or neck?

**A:** Move the child toward the center of the vehicle, but be sure that the shoulder belt still is on the child's shoulder, so that in a crash the child's upper body would have the restraint that belts provide. If the child is sitting in a rear seat outside position, see "Rear Safety Belt Comfort Guides" in the Index. If the child is so small that the shoulder belt is still very close to the child's face or neck, you might want to place the child in the center seat position, the one that has only a lap belt.



**⚠ CAUTION:**

**Never do this.**

**Here a child is sitting in a seat that has a lap-shoulder belt, but the shoulder part is behind the child. If the child wears the belt in this way, in a crash the child might slide under the belt. The belt's force would then be applied right on the child's abdomen. That could cause serious or fatal injuries.**

Wherever the child sits, the lap portion of the belt should be worn low and snug on the hips, just touching the child's thighs. This applies belt force to the child's pelvic bones in a crash.

## Safety Belt Extender

If the vehicle's safety belt will fasten around you, you should use it.

But if a safety belt isn't long enough to fasten, your dealer will order you an extender. It's free. When you go in to order it, take the heaviest coat you will wear, so the extender will be long enough for you. The extender will be just for you, and just for the seat in your vehicle that you choose. Don't let someone else use it, and use it only for the seat it is made to fit. To wear it, just attach it to the regular safety belt.

## Checking Your Restraint Systems

Now and then, make sure the safety belt reminder light and all your belts, buckles, latch plates, retractors and anchorages are working properly. Look for any other loose or damaged safety belt system parts. If you see anything that might keep a safety belt system from doing its job, have it repaired.

Torn or frayed safety belts may not protect you in a crash. They can rip apart under impact forces. If a belt is torn or frayed, get a new one right away.

Also look for any opened or broken air bag covers, and have them repaired or replaced. (The air bag system does not need regular maintenance.)

## Replacing Restraint System Parts After a Crash

If you've had a crash, do you need new belts?

After a very minor collision, nothing may be necessary. But if the belts were stretched, as they would be if worn during a more severe crash, then you need new belts.

If belts are cut or damaged, replace them. Collision damage also may mean you will need to have safety belt or seat parts repaired or replaced. New parts and repairs may be necessary even if the belt wasn't being used at the time of the collision.

If an air bag inflates, you'll need to replace air bag system parts. See the part on the air bag system earlier in this section.



## Section 2 Features and Controls

---

Here you can learn about the many standard and optional features on your vehicle, and information on starting, shifting and braking. Also explained are the instrument panel and the warning systems that tell you if everything is working properly -- and what to do if you have a problem.

2-2	Windows	2-32	Engine Exhaust
2-4	Keys	2-32	Running Your Engine While You're Parked
2-6	Door Locks	2-33	Horn
2-11	Remote Keyless Entry System (If Equipped)	2-33	Tilt Wheel
2-16	Trunk Lid	2-34	Turn Signal/Multifunction Lever
2-18	Theft	2-40	Exterior Lamps
2-19	Passlock <sup>®</sup>	2-43	Interior Lamps
2-19	New Vehicle "Break-In"	2-46	Mirrors
2-20	Ignition Positions	2-50	Storage Compartments
2-21	Starting Your Engine	2-52	Ashtrays and Cigarette Lighter
2-22	Engine Coolant Heater (Option)	2-52	Accessory Power Outlets
2-24	Automatic Transaxle Operation	2-53	OnStar <sup>®</sup> System (If Equipped)
2-28	Parking Brake	2-57	Power Sunroof (Option)
2-29	Shifting Into PARK (P)	2-58	The Instrument Panel -- Your Information System
2-31	Shifting Out of PARK (P)	2-58	Warning Lights, Gages and Indicators
2-31	Parking Over Things That Burn		

## Windows

### CAUTION:

**Leaving children in a vehicle with the windows closed is dangerous. A child can be overcome by the extreme heat and can suffer permanent injuries or even death from heat stroke. Never leave a child alone in a vehicle, especially with the windows closed in warm or hot weather.**



## Power Windows



Switches located on the driver's door armrest operate each of the windows when the ignition is on. In addition, each passenger door has an individual window switch.

## Express-Down Window

The driver's window switch has an auto-down feature. This switch is labeled AUTO. Tap the switch rearward, and the driver's window will open a small amount. If the switch is moved all the way back, the window will go all the way down.

To stop the window while it is lowering, press the switch. To raise the window, press and hold the switch forward.

## Lock-Out Switch



The driver's window controls also include a lock-out switch. Press LOCK to stop front and rear passengers from using their window switches.

The driver can still operate all windows with the lock on. Press the other side of the LOCK switch to return to normal window operation.

## Keys

### CAUTION:

Leaving children in a vehicle with the ignition key is dangerous for many reasons. A child or others could be badly injured or even killed.

They could operate the power windows or other controls or even make the vehicle move. Don't leave the keys in a vehicle with children.





Your vehicle comes with two master keys and one spare key. The master key can be used for the ignition, as well as all door locks, trunk and storage compartments. The third key is provided as a spare key.

These keys don't have key plugs. Your Oldsmobile dealer has a code for your key and can assist you if you need a new key. In an emergency, contact Oldsmobile Roadside Assistance. See "Roadside Assistance" in the Index for more information.

### **NOTICE:**

**Your vehicle has a number of features that can help prevent theft. But you can have a lot of trouble getting into your vehicle if you ever lock your key inside. You may have to damage your vehicle to get in. So be sure you have an extra key.**



## Door Locks

### CAUTION:

Unlocked doors can be dangerous.

- Passengers -- especially children -- can easily open the doors and fall out of a moving vehicle. When a door is locked, the handle won't open it. You increase the chance of being thrown out of the vehicle in a crash if the doors aren't locked. So, wear safety belts properly and lock the doors whenever you drive.
- Young children who get into unlocked vehicles may be unable to get out. A child can be overcome by extreme heat and can suffer permanent injuries or even death from heat stroke. Always lock your vehicle whenever you leave it.
- Outsiders can easily enter through an unlocked door when you slow down or stop your vehicle. Locking your doors can help prevent this from happening.

There are several ways to lock and unlock your vehicle.

From the outside, use your key or keyless entry transmitter (if equipped).



From the inside, use the manual lever. Each door has a lever that works only on that door's lock. The lever won't unlock or lock all the doors. Push the lever rearward to unlock and forward to lock.

## Power Door Locks



Press the power door lock switch located on either front door near the handle to lock or unlock all the doors.

The rear doors do not have power door lock switches. Push the manual lever rearward to unlock and forward to lock.

## Last Door Closed Locking

This feature allows the doors to be locked while the passengers are leaving the vehicle. This also provides a brief time period after all the doors are closed, but before the doors lock, in which the doors may be reopened.

Last door closed locking is activated by either the power door lock switch inside the vehicle or by pressing LOCK on the remote keyless entry transmitter (if equipped). After pressing the power door lock switch once, three chimes will be heard. The three chimes indicate that the last door closed locking has been activated.

If you wish to let the last door closed locking feature complete the locking cycle, no additional action is required. The last door closed locking feature will lock the doors automatically after all the doors have been closed for a period of five seconds. During this five second period, any door may be reopened.

You can customize or disable the last door closed locking feature. If disabled, the doors will lock immediately when a power door lock switch is pressed.

## Programmable Modes

**Mode 1:** Cancel the last door closed locking by pressing the unlock switch or by fully inserting the key in the ignition.

**Mode 2:** Override the last door closed locking feature and lock the doors immediately by pressing the lock switch a second time.

**Mode 3:** Let the last door closed locking feature complete the locking of the vehicle.

When your vehicle was shipped from the factory, it was programmed to Mode 3. The mode to which your vehicle was programmed may have been changed since it left the factory. To determine the mode to which your vehicle is programmed or to program your vehicle to a different mode, do the following:

1. Close all doors and turn the ignition switch to ON.
2. Press and hold the power door lock switch in the unlock position.

3. While holding the door unlock switch, cycle the transaxle out of and back into PARK (P). Count the number of chimes you hear. The number of chimes tells you which mode your vehicle is set for. (If you do not wish to change the current mode, you can either exit the programming mode by following the instructions listed here or program the next feature available on your vehicle).
4. A single chime will be heard if the last door closed locking feature is disabled, and two chimes will be heard if the feature is enabled. After the initial transaxle cycle, each additional cycle will turn the last door closed locking feature on or off.
5. When the door unlock switch is released, the vehicle will remain in the most recent operating mode.

The mode you selected is now set. You can either exit the programming mode by following the instructions above or program the next feature available on your vehicle.

Disconnecting the battery for up to a year will not change any previously programmed modes.

## Programmable Automatic Door Locks

Programmable automatic door locks is a standard feature intended to provide enhanced security and convenience by automatically locking and unlocking vehicle doors. The automatic locking and unlocking of the vehicle will occur if the ignition key is in ON and the driver's door is closed when the vehicle is shifted out of PARK (P).

### Programmable Modes

**Mode 1:** No automatic door lock or unlock.

**Mode 2:** Automatic all door lock when the transaxle is shifted out of PARK (P). No automatic door unlock.

**Mode 3:** Automatic all door lock when the transaxle is shifted out of PARK (P). Automatic all door unlock when the transaxle is shifted into PARK (P).

**Mode 4:** Automatic all door lock when the transaxle is shifted out of PARK (P). Automatic driver's door only unlock when the transaxle is shifted into PARK (P).

When your vehicle was shipped from the factory, it was programmed to Mode 3. The mode to which your vehicle was programmed may have been changed since it left the factory. To determine the mode to which your vehicle is programmed or to program your vehicle to a different mode, do the following:

1. Close all doors and turn the ignition switch to ON.
2. Press and hold the power door lock switch in the lock position.
3. While holding the door lock switch, cycle the transaxle out of and back into PARK (P). The door lock and unlock functions will operate as defined, depending upon the current mode selected. (If you do not wish to change the current mode, you can either exit the programming mode by following the instructions listed here or program the next feature available on your vehicle).
4. After an initial transaxle cycle, each additional cycle will advance to the operating mode by one, starting from the current operating mode.
5. If cycled beyond Mode 4, the vehicle will enter operating Mode 1. When the door lock switch is released, the vehicle will remain in the most recent operating mode.

The mode you selected is now set. You can either exit the programming mode by following the instructions above or program the next feature available on your vehicle.

Disconnecting the battery for up to a year will not change or delete any previously programmed modes.

## Rear Security Locks

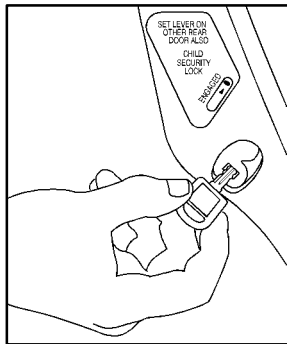

Your vehicle is equipped with rear door security locks that help prevent passengers from opening the rear doors of your vehicle from the inside.

To use one of these locks, do the following:

1. Open one of the rear doors.
2. On the inside of the rear door will be a lock. Insert your master key into this lock and turn it upward. This will engage the safety lock.
3. Close the door.
4. Do the same thing to the other rear door.

The rear doors on your vehicle cannot be opened from the inside when this feature is in use. If you want to open the rear door when the security lock is on, unlock the door from the inside and then open the door from the outside.

## Lockout Prevention

Lockout Prevention is a standard feature intended to provide enhanced security and convenience. This feature prevents a driver who has left the key in the ignition from locking the doors using the power door lock switch while any door is open.

This feature cannot guarantee that you will never be locked out of your vehicle. If you don't leave the key in the ignition, or if you use the manual door lock, you could still lock your keys inside your vehicle. Always remember to take your keys with you.

## Programmable Modes

**Mode 1:** Turns feature on.

**Mode 2:** Turns feature off.

When your vehicle was shipped from the factory, it was programmed to Mode 1. The mode to which your vehicle was programmed may have been changed since it left the factory. To determine the mode to which your vehicle is programmed or to program your vehicle to a different mode, do the following:

1. Open a door and put the key in the ignition.
2. Hold down the power door lock switch for more than three seconds. This will turn the feature off or on, depending upon the current mode selected. (If you do not wish to change the current mode, you can either exit the programming mode by following the instructions listed here or program the next feature available on your vehicle).
3. When the door lock switch is released, the vehicle will remain in the most recent operating mode.

The mode you selected is now set. You can either exit the programming mode by following the instructions above or program the next feature available on your vehicle.

## **Remote Keyless Entry System (If Equipped)**

If your vehicle has this feature, you can lock and unlock your doors or unlock your trunk from about 3 feet (1 m) up to 30 feet (9 m) away using the remote keyless entry transmitter supplied with your vehicle.

Your keyless entry system operates on a radio frequency subject to Federal Communications Commission (FCC) Rules and with Industry Canada.

This device complies with Part 15 of the FCC Rules. Operation is subject to the following two conditions:  
(1) this device may not cause harmful interference, and  
(2) this device must accept any interference received, including interference that may cause undesired operation.

This device complies with RSS-210 of Industry Canada. Operation is subject to the following two conditions:  
(1) this device may not cause interference, and  
(2) this device must accept any interference received, including interference that may cause undesired operation of the device.

Changes or modifications to this system by other than an authorized service facility could void authorization to use this equipment.

At times you may notice a decrease in range. This is normal for any remote system. If the transmitter does not work or if you have to stand closer to your vehicle for the transmitter to work, try this:

- Check the distance. You may be too far from your vehicle. You may need to stand closer during rainy or snowy weather.
- Check the location. Other vehicles or objects may be blocking the signal. Take a few steps to the left or right, hold the transmitter higher, and try again.
- Check to determine if battery replacement is necessary. See the instructions that follow.
- If you're still having trouble, see your dealer or a qualified technician for service.

## Operation

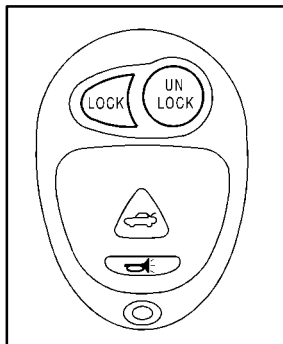

Press UNLOCK once to unlock the driver's door and to turn the interior lamps on (see "Illumination on Remote Activation" in the Index for more details).

Press UNLOCK again within five seconds to unlock all doors. To lock all doors, press LOCK. To unlock the trunk, press the trunk symbol on the remote keyless entry transmitter. The trunk will only unlock when the vehicle is in PARK (P).

## Remote Alarm

When you press the alarm button on the remote keyless entry transmitter, the headlamps will flash, the horn will sound repeatedly and the interior lamps will illuminate. This will allow you to attract attention if needed. The alarm will continue until one of the following occurs:

- The driver presses the alarm button on the remote keyless entry transmitter a second time,
- the ignition is turned to ON or
- 110 seconds has elapsed.

## Remote Activation Verification (RAV)

This feature helps provide audible and/or visible feedback that a remote keyless entry lock or unlock command has been received and executed. The ignition must be in OFF for the remote activation verification to work.

You may select one of four operating modes for lock and unlock commands. The selection and programming of the lock and unlock modes are independent of each other.

### Programmable Modes

**Mode 1:** No Verification

**Mode 2:** Horn Chirp only

**Mode 3:** Headlamp and Parking Lamp Flash only

**Mode 4:** Horn Chirp and Headlamp and Parking Lamp Flash

### RAV Lock Mode Programming

When your vehicle was shipped from the factory, it was programmed to Mode 3. The mode to which your vehicle was programmed may have been changed since it left the factory. To determine the RAV lock mode to which your vehicle is programmed to or to program your vehicle to a different mode, do the following:

1. Close all doors and turn the ignition switch to ON.
2. Press and hold down the power door lock switch in the LOCK position.
3. While holding the door lock switch, press and release the remote keyless entry transmitter LOCK button. This button press will initialize the customization mode. Upon initiation of this mode, the chime will sound. Count the number of chimes you hear. The number of chimes tells you which mode your vehicle is set for. (If you do not wish to change the current mode, you can either exit the programming mode by following the instructions listed here or program the next feature available on your vehicle).



4. Each additional press of the remote keyless entry transmitter LOCK button will cause the vehicle to advance to the RAV lock mode by one, starting from the current RAV lock mode.
5. If cycled beyond RAV lock Mode 4, the vehicle will enter RAV lock Mode 1. When the door lock switch is released, the vehicle will remain in the most recent RAV lock mode.

### **RAV Unlock Mode Programming**

When your vehicle was shipped from the factory, it was programmed to Mode 1. The mode to which your vehicle was programmed may have been changed since it left the factory. To determine the RAV unlock mode to which your vehicle is programmed or to program your vehicle to a different mode, do the following:

1. Close all doors and turn the ignition switch to ON.
2. Press and hold down the power door lock switch in the UNLOCK position.
3. While holding the door lock switch, press and release the remote keyless entry transmitter UNLOCK button. This button press will initialize the customization mode. Upon initiation of this

mode, the chime will sound. Count the number of chimes you hear. The number of chimes tells you which mode your vehicle is set for. (If you do not wish to change the current mode, you can either exit the programming mode by following the instructions listed here or program the next feature available on your vehicle).

4. Each additional press of the remote keyless entry transmitter UNLOCK button will cause the vehicle to advance the RAV unlock mode by one, starting from the current RAV unlock mode.
5. If cycled beyond RAV unlock Mode 4, the vehicle will enter RAV unlock Mode 1. When the door lock switch is released, the vehicle will remain in the most recent RAV unlock mode.

The mode you selected is now set. You can either exit the programming mode by following the instructions above or program the next feature available on your vehicle.

Disconnecting the battery for up to a year will not change or delete any previously programmed modes.

## Illumination on Remote Activation

This feature is included on vehicles with the remote keyless entry system. The interior illumination will be activated when a remote keyless entry door unlock command is received. The ignition must be off for the remote activation illumination to work. The interior lamps will illuminate until the ignition is turned to ON or until the illumination period of 40 seconds has elapsed.

If during the illumination period, a door is opened, the timed illumination period will be cancelled, though the interior lamps will remain on until all doors are closed.

## Matching Transmitter(s) to Your Vehicle

Each remote keyless entry transmitter is coded to prevent another transmitter from unlocking your vehicle. If a transmitter is lost or stolen, a replacement can be purchased through your dealer. Remember to bring any remaining transmitters with you when you go to your dealer. When the dealer matches the replacement transmitter to your vehicle, any remaining transmitters must also be matched. Once your dealer has coded the new transmitter, the lost transmitter will not unlock your vehicle. Each vehicle can have only four transmitters matched to it.

## Battery Replacement

Under normal use, the battery in your remote keyless entry transmitter should last about three years.

You can tell the battery is weak if the transmitter won't work at the normal range in any location. If you have to get close to your vehicle before the transmitter works, it's probably time to change the battery.

### **NOTICE:**

**When replacing the battery, use care not to touch any of the circuitry. Static from your body transferred to these surfaces may damage the transmitter.**



To replace the battery do the following:

1. Insert a flat object like a coin into the slot on the back of the transmitter. Gently pry apart the front and back.
2. Gently pry the battery out of the transmitter. (Do not use a metal object.)
3. Put the new battery into the transmitter as shown on the transmitter (use a type CR2032 battery).
4. Put the two halves back together. Make sure the halves are together tightly so water won't get in.
5. Test the operation of the transmitter.

## Trunk Lid

### CAUTION:

**It can be dangerous to drive with the trunk lid open because carbon monoxide (CO) gas can come into your vehicle. You can't see or smell CO. It can cause unconsciousness and even death.**

**If you must drive with the trunk lid open or if electrical wiring or other cable connections must pass through the seal between the body and the trunk lid:**

- **Make sure all other windows are shut.**
- **Turn the fan on your heating or cooling system to its highest speed with the setting on VENT. That will force outside air into your vehicle. See "Comfort Controls" in the Index.**
- **If you have air outlets on or under the instrument panel, open them all the way.**

**See "Engine Exhaust" in the Index.**

## Trunk Lock

To unlock the trunk from the outside, insert the key and turn it clockwise.

You can also use the remote keyless entry transmitter (if equipped).

## Remote Trunk Release

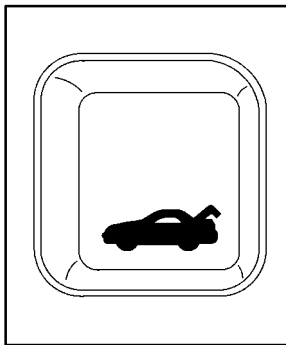

Press the button on the left side of the instrument panel to unlock the trunk from inside your vehicle. Your vehicle must be in PARK (P).

## Trunk Release Handle (If Equipped)

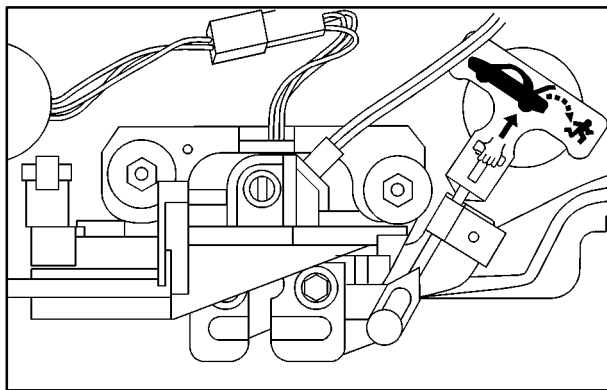

### NOTICE:

**The trunk release handle was not designed to be used to tie down the trunk lid or as an anchor point when securing items in the trunk. Improper use of the trunk release handle could damage it.**

There is a glow-in-the-dark trunk release handle located inside the trunk on the latch. This handle will glow following exposure to light. Pull the release handle up to open the trunk from the inside.

## Trap-Resistant Trunk Kit

To help prevent a child from becoming trapped in your trunk, you can order a trap-resistant trunk kit from your dealer. This kit includes:

- a modified trunk latch,
- a lighted release handle, and
- seatback tethers (for vehicles with folding rear seatbacks).

See your dealer for additional information.

## Theft

Vehicle theft is big business, especially in some cities. Although your vehicle has a number of theft-deterrent features, we know that nothing we put on it can make it impossible to steal. However, there are ways you can help.

### Key in the Ignition

If you leave your vehicle with the keys inside, it's an easy target for joy riders or professional thieves -- so don't do it.

When you park your vehicle and open the driver's door, you'll hear a chime reminding you to remove your key from the ignition and take it with you. Always do this. Your ignition and transaxle will be locked. And remember to lock the doors.

### Parking at Night

Park in a lighted spot, close all windows and lock your vehicle. Remember to keep your valuables out of sight. Put them in a storage area, or take them with you.

### Parking Lots

Even if you park in a lot where someone will be watching your vehicle, it's still best to lock it up and take your keys. But what if you have to leave your ignition key?

- If possible, park in a busy, well-lit area.
- Put your valuables in a storage area, like your trunk or glove box. Be sure to close and lock the storage area.
- Close all windows.
- Lock the glove box.
- Lock all the doors except the driver's.
- Then take the remote keyless entry transmitter with you.

## Passlock<sup>®</sup>

Your vehicle is equipped with the Passlock theft-deterrent system.

Passlock is a passive theft-deterrent system. Passlock enables fuel if the ignition lock cylinder is turned with a valid key. If a correct key is not used or the ignition lock cylinder is tampered with, fuel is disabled.

During normal operation, the SECURITY light will go off approximately five seconds after the key is turned to the START ignition position.

If the engine stalls and the SECURITY light flashes, wait until the light stops flashing before trying to restart the engine. Remember to release the key from START as soon as the engine starts.

If the engine is running and the SECURITY light comes on, you will be able to restart the engine if you turn the engine off. However, your Passlock system is not working properly and must be serviced by your dealer. Your vehicle is not protected by Passlock at this time. You may also want to check the fuse (see “Fuses and Circuit Breakers” in the Index). See your dealer for assistance.

In an emergency, contact Oldsmobile Roadside Assistance. See “Roadside Assistance” in the Index for more information.

## New Vehicle “Break-In”

### NOTICE:

**Your vehicle doesn't need an elaborate “break-in.” But it will perform better in the long run if you follow these guidelines:**

- **Don't drive at any one speed -- fast or slow -- for the first 500 miles (805 km). Don't make full-throttle starts.**
- **Avoid making hard stops for the first 200 miles (322 km) or so. During this time your new brake linings aren't yet broken in. Hard stops with new linings can mean premature wear and earlier replacement. Follow this breaking-in guideline every time you get new brake linings.**
- **Don't tow a trailer during break-in. See “Towing a Trailer” in the Index for more information.**

## Ignition Positions

Your ignition switch is located on the instrument panel. With the ignition key in the switch, you can turn the switch to four positions.

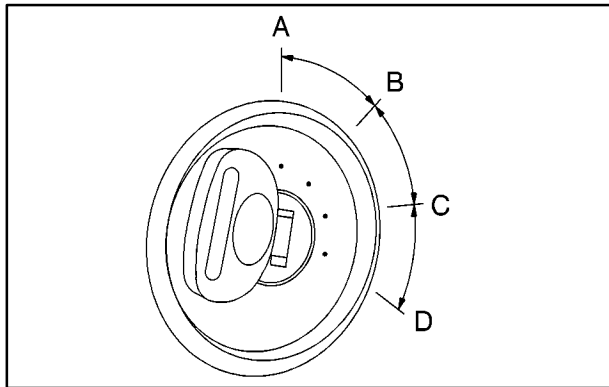

**OFF (A):** This position locks your ignition and transaxle. It's a theft-deterrent feature. It's also the only position from which you can remove your key.

### NOTICE:

**If your key seems stuck in OFF and you can't turn it, be sure you are using the correct key; if so, is it all the way in? Turn the key only with your hand. Using a tool to force it could break the key or the ignition switch. If none of this works, then your vehicle needs service.**

**ACC (B):** This position lets you turn off the ignition. It also lets you use things like the radio and windshield wipers when the engine is off. Your steering wheel will unlock. Use ACC if you must have your vehicle pushed or towed.

**ON (C):** This position is where the key returns to after you start the vehicle. With the engine off, you can use ON to display some of your warning and indicator lights.

**START (D):** This position starts your engine.

## Retained Accessory Power (RAP)

With retained accessory power, the power windows, audio system and sunroof (option) will continue to work up to 10 minutes after the ignition key is turned to OFF and none of the doors is opened.

## Starting Your Engine

Move your shift lever to PARK (P) or NEUTRAL (N). Your engine won't start in any other position -- that's a safety feature. To restart when you're already moving, use NEUTRAL (N) only.

### NOTICE:

**Don't try to shift to PARK (P) if your vehicle is moving. If you do, you could damage the transaxle. Shift to PARK (P) only when your vehicle is stopped.**

1. With your foot off the accelerator pedal, turn your ignition key to START. When the engine starts, let go of the key. The idle speed will go down as your engine gets warm.

### NOTICE:

**Holding your key in START for longer than 15 seconds at a time will cause your battery to be drained much sooner. And the excessive heat can damage your starter motor. Wait about 15 seconds between each try to help avoid draining your battery or damaging your starter.**

2. If it doesn't start within 10 seconds, hold your key in START for about 10 seconds at a time until your engine starts. Wait about 15 seconds between each try.



3. If your engine still won't start (or starts but then stops), it could be flooded with too much gasoline. Try pushing your accelerator pedal all the way to the floor and holding it there as you hold the key in START for about three seconds. If the vehicle starts briefly but then stops again, do the same thing. This time keep the pedal down for five or six seconds to clear the extra gasoline from the engine. After waiting about 15 seconds, repeat the normal starting procedure.

## **NOTICE:**

**Your engine is designed to work with the electronics in your vehicle. If you add electrical parts or accessories, you could change the way the engine operates. Before adding electrical equipment, check with your dealer. If you don't, your engine might not perform properly.**

## **Engine Coolant Heater (Option)**

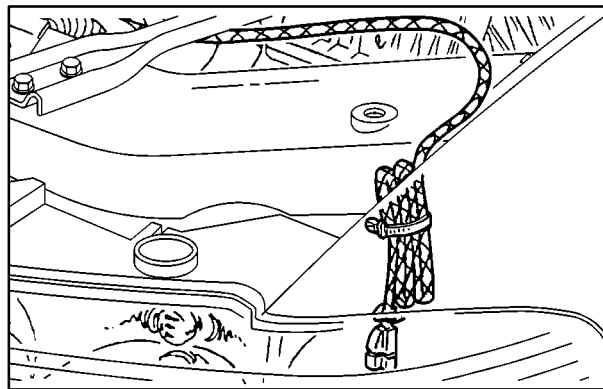

In very cold weather, 0°F (-18°C) or colder, the engine coolant heater can help. You'll get easier starting and better fuel economy during engine warm-up. Usually, the coolant heater should be plugged in a minimum of four hours prior to starting your vehicle.

## To Use the Engine Coolant Heater

1. Turn off the engine.
2. Open the hood and unwrap the electrical cord.  
The cord is located behind the driver's side headlamp assembly.
3. Plug it into a normal, grounded 110-volt AC outlet.

### CAUTION:

**Plugging the cord into an ungrounded outlet could cause an electrical shock. Also, the wrong kind of extension cord could overheat and cause a fire. You could be seriously injured. Plug the cord into a properly grounded three-prong 110-volt AC outlet. If the cord won't reach, use a heavy-duty three-prong extension cord rated for at least 15 amps.**

4. Before starting the engine, be sure to unplug and store the cord as it was before to keep it away from moving engine parts. If you don't, it could be damaged.

How long should you keep the coolant heater plugged in? The answer depends on the outside temperature, the kind of oil you have, and some other things. Instead of trying to list everything here, we ask that you contact your dealer in the area where you'll be parking your vehicle. The dealer can give you the best advice for that particular area.

## Automatic Transaxle Operation



Your automatic transaxle has a shift lever located on the console between the seats.

Maximum engine speed is limited when your vehicle is in PARK (P) or NEUTRAL (N) to protect driveline components from improper operations.

There are several positions for your shift lever.

**PARK (P):** This position locks your front wheels. It's the best position to use when you start your engine because your vehicle can't move easily.

### CAUTION:

**It is dangerous to get out of your vehicle if the shift lever is not fully in PARK (P) with the parking brake firmly set. Your vehicle can roll.**

**Don't leave your vehicle when the engine is running unless you have to. If you have left the engine running, the vehicle can move suddenly. You or others could be injured. To be sure your vehicle won't move, even when you're on fairly level ground, always set your parking brake and move the shift lever to PARK (P).**

**See "Shifting Into PARK (P)" in the Index. If you're pulling a trailer, see "Towing a Trailer" in the Index.**

Make sure the shift lever is fully in PARK (P) before starting the engine. Your vehicle has an automatic transaxle shift lock control system. You must fully apply your regular brakes before you can shift from PARK (P) when the ignition is in ON. If you cannot shift out of PARK (P), ease pressure on the shift lever by pushing it all the way into PARK (P) while keeping the brake pushed down. Then move the shift lever out of PARK (P), being sure to press the shift lever button. See “Shifting Out of PARK (P)” in the Index.

**REVERSE (R):** Use this gear to back up.

### **NOTICE:**

**Shifting to REVERSE (R) while your vehicle is moving forward could damage your transaxle. Shift to REVERSE (R) only after your vehicle is stopped.**

To rock your vehicle back and forth to get out of snow, ice or sand without damaging your transaxle, see “Stuck: In Sand, Mud, Ice or Snow” in the Index.

**NEUTRAL (N):** In this position, your engine doesn’t connect with the wheels. To restart when you’re already moving, use NEUTRAL (N) only. Also, use NEUTRAL (N) when your vehicle is being towed.

### **CAUTION:**

**Shifting out of PARK (P) or NEUTRAL (N) while your engine is “racing” (running at high speed) is dangerous. Unless your foot is firmly on the brake pedal, your vehicle could move very rapidly. You could lose control and hit people or objects. Don’t shift out of PARK (P) or NEUTRAL (N) while your engine is racing.**

### **NOTICE:**

**Damage to your transaxle caused by shifting out of PARK (P) or NEUTRAL (N) with the engine racing isn’t covered by your warranty.**

**AUTOMATIC OVERDRIVE (D):** This position is for normal driving. If you need more power for passing, and you're:

- Going less than 35 mph (55 km/h), push your accelerator pedal about halfway down.
- Going about 35 mph (55 km/h) or more, push the accelerator pedal all the way down.

You'll shift down to the next gear and have more power.

## **NOTICE:**

**If your vehicle seems to start up rather slowly, or if it seems not to shift gears as you go faster, something may be wrong with a transaxle system sensor. If you drive very far that way, your vehicle can be damaged. If this happens, have your vehicle serviced right away.**

**NOTICE: (Continued)**

## **NOTICE: (Continued)**

**Until then, you can use SECOND (2) when you are driving less than 35 mph (55 km/h) and AUTOMATIC OVERDRIVE (D) for higher speeds.**

**THIRD (3):** This position is also used for normal driving, but it offers more power and lower fuel economy than AUTOMATIC OVERDRIVE (D).

Here are some times you might choose THIRD (3) instead of AUTOMATIC OVERDRIVE (D):

- When driving on hilly, winding roads.
- When towing a trailer, so there is less shifting between gears.
- When going down a steep hill.

**SECOND (2):** This position gives you more power, but lower fuel economy. You can use SECOND (2) on hills. It can help control your speed as you go down steep mountain roads, but then you would also want to use your brakes off and on.

**NOTICE:**

**Don't drive in SECOND (2) for more than 25 miles (40 km) at speeds over 55 mph (88 km/h), or you can damage your transaxle. Use AUTOMATIC OVERDRIVE (D) or THIRD (3) as much as possible.**

**Don't shift into SECOND (2) unless you are going slower than 65 mph (105 km/h), or you can damage your engine.**

**FIRST (1):** This position gives you even more power (but lower fuel economy) than SECOND (2). You can use it on very steep hills, or in deep snow or mud. If the shift lever is put in FIRST (1), the transaxle won't shift into first gear until the vehicle is going slowly enough.

**NOTICE:**

**If your front wheels can't turn, don't try to drive. This might happen if you were stuck in very deep sand or mud or were up against a solid object. You could damage your transaxle. Also, if you stop when going uphill, don't hold your vehicle there with only the accelerator pedal. This could overheat and damage the transaxle. Use your brakes or shift into PARK (P) to hold your vehicle in position on a hill.**

## Parking Brake



The parking brake is located to the left of the brake pedal near the driver's door.

To set the parking brake, hold the brake pedal down with your right foot. Then, push down the parking brake pedal with your left foot.

To release the parking brake, hold the regular brake pedal down with your right foot and push the parking brake pedal with your left foot. When you lift your left foot, the parking brake pedal will follow it to the released position.

### **NOTICE:**

**Driving with the parking brake on can cause your rear brakes to overheat. You may have to replace them, and you could also damage other parts of your vehicle.**

If you are towing a trailer and are parking on a hill, see "Towing a Trailer" in the Index. That section shows what to do first to keep the trailer from moving.

## Shifting Into PARK (P)

### CAUTION:

**It can be dangerous to get out of your vehicle if the shift lever is not fully in PARK (P) with the parking brake firmly set. Your vehicle can roll. If you have left the engine running, the vehicle can move suddenly. You or others could be injured. To be sure your vehicle won't move, even when you're on fairly level ground, use the steps that follow. If you're pulling a trailer, see "Towing a Trailer" in the Index.**

1. Hold the brake pedal down with your right foot and set the parking brake.
2. Move the shift lever into PARK (P) like this:
  - Hold in the button on the lever.
  - Push the lever all the way toward the front of the vehicle.
3. Turn the ignition key to OFF.
4. Remove the key and take it with you. If you can leave with the ignition key in your hand, your vehicle is in PARK (P).





## Leaving Your Vehicle With the Engine Running

### CAUTION:

**It can be dangerous to leave your vehicle with the engine running. Your vehicle could move suddenly if the shift lever is not fully in PARK (P) with the parking brake firmly set. And, if you leave the vehicle with the engine running, it could overheat and even catch fire. You or others could be injured. Don't leave your vehicle with the engine running unless you have to.**

If you have to leave your vehicle with the engine running, be sure your vehicle is in PARK (P) and your parking brake is firmly set before you leave it. After you've moved the shift lever into the PARK (P) position, hold the regular brake pedal down. Then, see if you can move the shift lever away from PARK (P) without first pushing the shift lever button. If you can, it means that the shift lever wasn't fully locked into PARK (P).

## Torque Lock

If you are parking on a hill and you don't shift your transaxle into PARK (P) properly, the weight of the vehicle may put too much force on the parking pawl in the transaxle. You may find it difficult to pull the shift lever out of PARK (P). This is called "torque lock." To prevent torque lock, set the parking brake and then shift into PARK (P) properly before you leave the driver's seat. To find out how, see "Shifting Into PARK (P)" in the Index.

When you are ready to drive, move the shift lever out of PARK (P) *before* you release the parking brake.

If torque lock does occur, you may need to have another vehicle push yours a little uphill to take some of the pressure from the parking pawl in the transaxle, so you can pull the shift lever out of PARK (P).

## Shifting Out of Park (P)

Your vehicle has an automatic transaxle shift lock control system. You must fully apply your regular brakes before you can shift from PARK (P) when the ignition is in ON. See “Automatic Transaxle Operation” in the Index.

If you cannot shift out of PARK (P), ease pressure on the shift lever by pushing it all the way into PARK (P) while keeping the brake pedal pushed down. Release the shift lever button as you maintain brake application. Then move the shift lever out of PARK (P) into the gear that you wish.

If you ever hold the brake pedal down, but still can't shift out of PARK(P), try this:

1. Turn the key to ACC.
2. Apply and hold the brake.
3. Shift to NEUTRAL (N).
4. Start the engine, and then shift to the drive gear you want.
5. Have the system fixed as soon as you can.

## Parking Over Things That Burn

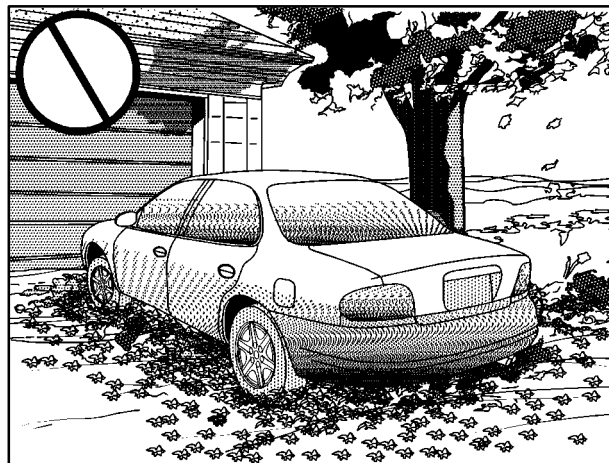

### CAUTION:

**Things that can burn could touch hot exhaust parts under your vehicle and ignite. Don't park over papers, leaves, dry grass or other things that can burn.**

## Engine Exhaust

### CAUTION:

Engine exhaust can kill. It contains the gas carbon monoxide (CO), which you can't see or smell. It can cause unconsciousness and death.

You might have exhaust coming in if:

- Your exhaust system sounds strange or different.
- Your vehicle gets rusty underneath.
- Your vehicle was damaged in a collision.
- Your vehicle was damaged when driving over high points on the road or over road debris.
- Repairs weren't done correctly.
- Your vehicle or exhaust system had been modified improperly.

If you ever suspect exhaust is coming into your vehicle:

- Drive it only with all the windows down to blow out any CO; and
- Have your vehicle fixed immediately.

## Running Your Engine While You're Parked

It's better not to park with the engine running. But if you ever have to, here are some things to know.

### CAUTION:

Idling the engine with the climate control system off could allow dangerous exhaust into your vehicle. See the earlier Caution under "Engine Exhaust."

Also, idling in a closed-in place can let deadly carbon monoxide (CO) into your vehicle even if the fan switch is at the highest setting. One place this can happen is a garage. Exhaust -- with CO -- can come in easily. NEVER park in a garage with the engine running.

Another closed-in place can be a blizzard. See "Blizzard" in the Index.

## CAUTION:

**It can be dangerous to get out of your vehicle if the shift lever is not fully in PARK (P) with the parking brake firmly set. Your vehicle can roll. Don't leave your vehicle when the engine is running unless you have to. If you've left the engine running, the vehicle can move suddenly. You or others could be injured. To be sure your vehicle won't move, even when you're on fairly level ground, always set your parking brake and move the shift lever to PARK (P).**

Follow the proper steps to be sure your vehicle won't move. See "Shifting Into PARK (P)" in the Index.

If you are parking on a hill and if you're pulling a trailer, also see "Towing a Trailer" in the Index.

## Horn

Press at or near the horn symbols to sound the horn.

## Tilt Wheel



A tilt wheel allows you to adjust the steering wheel before you drive. You can also raise it to the highest level to give your legs more room when you exit and enter the vehicle.

To tilt the wheel, hold the wheel and pull the lever located on the left side of your steering column. Move the wheel to a comfortable level, then release the lever to lock the wheel in place.

## Turn Signal/Multifunction Lever

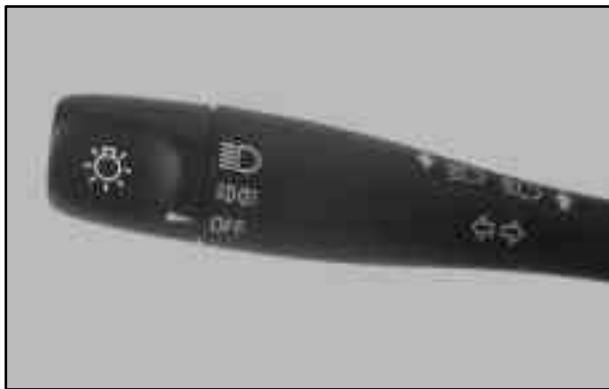

The lever on the left side of the steering column includes the following:

- Turn and Lane-Change Signals
- Headlamp High/Low-Beam Changer
- Flash-to-Pass
- Headlamps
- Taillamps
- Parking Lamps

## Turn and Lane-Change Signals

The turn signal lever has two upward (for right) and two downward (for left) positions. These positions allow you to signal a turn or lane change.

To signal a turn, move the lever all the way up or down. When the turn is finished, the lever will return automatically.

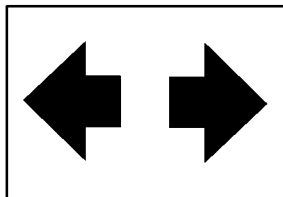

An arrow on the instrument panel cluster will flash in the direction of the turn or lane change.

To signal a lane change, just raise or lower the lever until the arrow starts to flash. Hold it there until you complete your lane change. The lever will return by itself when you release it.

As you signal a turn or lane change, if the arrow flashes faster than normal, a signal bulb may be burned out and other drivers won't see your turn signal.

If a bulb is burned out, replace it to help avoid an accident. If the arrows don't go on at all when you signal a turn, check for burned-out bulbs and then check the fuse (see "Fuses and Circuit Breakers" in the Index).

A chime will sound if you leave your turn signal on for more than 3/4 mile (1.2 km).

## Headlamp High/Low-Beam Changer

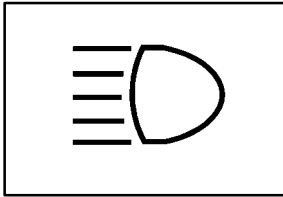

To change your headlamps from low beam to high beam, push the lever away from you. To change back to low beam, pull the lever toward you.

To flash your high beams, pull the lever toward you and release. The lever will return to the low-beam position. Fog lamps (if equipped) will not be illuminated while the headlamps are in the high-beam mode.

## Flash-to-Pass

With the lever in the low-beam position, pull the lever toward you momentarily to switch to high beams (to signal you are going to pass). If you have the headlamps on, they will return to low beams when you release the lever.

## Windshield Wipers



You can control the windshield wipers by moving the lever with the wiper symbol on it up or down. This lever is located on the right side of the steering wheel.

For a single wiping cycle, pull down on the lever to MIST. Hold it there until the wipers start, then let go. The wipers will stop after one cycle. If you want more cycles, hold the lever down longer.

You can set the wiper speed for a long delay or short delay between wipes. This can be very useful in light rain or snow. Push the lever up one click to INT (intermittent), then turn the band, located on the lever, to adjust the delay time. Turn the band down for a longer delay, up for a shorter delay. The wiper speed can only be adjusted when the lever is in the INT position, not in HI or LO.

Be sure to clear the ice and snow from the wiper blades before using them. If they're frozen to the windshield, carefully loosen or thaw them. If your blades do become damaged, get new blades or blade inserts.

Heavy snow or ice can overload your wipers. A circuit breaker will stop them until the motor cools. Clear away snow or ice to prevent an overload.

## Windshield Washer

At the end of the lever on right side of the steering wheel, there is a wiper symbol. To spray washer fluid on the windshield, push the button on the end of the lever. The wipers will run for several sweeps and then either stop or return to your preset speed.



### CAUTION:

**In freezing weather, don't use your washer until the windshield is warmed. Otherwise the washer fluid can form ice on the windshield, blocking your vision.**

## LOW WASHER FLUID

The LOW WASHER FLUID light will appear when your vehicle is low on washer fluid.

If you see this light while driving, your vehicle's washer fluid is low. You should refill the windshield washer fluid tank as soon as possible so that you'll have washer fluid when you need it.

### Cruise Control

With cruise control, you can maintain a speed of about 25 mph (40 km/h) or more without keeping your foot on the accelerator. This can really help on long trips. Cruise control does not work at speeds below about 25 mph (40 km/h).

When you apply your brakes, the cruise control shuts off.

## CAUTION:

- **Cruise control can be dangerous where you can't drive safely at a steady speed. So, don't use your cruise control on winding roads or in heavy traffic.**
- **Cruise control can be dangerous on slippery roads. On such roads, fast changes in tire traction can cause needless wheel spinning, and you could lose control. Don't use cruise control on slippery roads.**

If your vehicle is in cruise control when the optional traction control system begins to limit wheel spin, the cruise control will automatically disengage. See "Traction Control System" in the Index. When road conditions allow you to safely use it again, you may turn the cruise control back on.



## Setting Cruise Control

### CAUTION:

If you leave your cruise control switch on when you're not using cruise, you might hit a button and go into cruise when you don't want to. You could be startled and even lose control. Keep the cruise control switch off until you want to use cruise control.



1. Press the CRUISE button on the right side of the instrument panel to turn it on. A light on the button will indicate that the system is on.

2. Get up to the speed you want.



3. Press the COAST SET button on your steering wheel and release it.

4. Take your foot off the accelerator.

The CRUISE light on the instrument panel cluster will come on after the cruise control has been set to the desired speed. It will go off when you do the following:

- Step lightly on the brake pedal,
- press CLEAR on the steering wheel or
- press the CRUISE button on the instrument panel.

## Resuming a Set Speed

Suppose you set your cruise control at a desired speed and then you apply the brake. This, of course shuts off the cruise control. But you don't need to reset it.

Once you're going about 25 mph (40 km/h) or more, press the RES ACCEL button on your steering wheel. You'll go right back up to your chosen speed and stay there.

## Increasing Speed While Using Cruise Control

There are two ways to go to a higher speed:

- Use the accelerator pedal to get to the higher speed. Press the COAST SET button on the steering wheel, then release the button and the accelerator pedal. You'll now cruise at the higher speed.
- Press the RES ACCEL button on the steering wheel. Hold it there until you get up to the speed you want and then release the button. (To increase your speed in very small amounts, press the RES ACCEL button briefly and then release it. Each time you do this, your vehicle will go 1 mph (1.6 km/h) faster.)

The accelerate feature will only work after you set the cruise control speed by pressing the COAST SET button on the steering wheel.

## Reducing Speed While Using Cruise Control

There are two ways to reduce your speed while using cruise control:

- Press the COAST SET button on the steering wheel until you reach the lower speed you want, then release it.
- To slow down in very small amounts, press the COAST SET button on the steering wheel briefly and then release it. Each time you do this, you'll go 1 mph (1.6 km/h) slower.

## Passing Another Vehicle While Using Cruise Control

Use the accelerator pedal to increase your speed. When you take your foot off the pedal, your vehicle will slow down to the cruise speed you set earlier.

## Using Cruise Control on Hills

How well your cruise control will work on hills depends upon your speed, load and the steepness of the hills. When going up steep hills, you may have to step on the accelerator pedal to maintain your speed. When going downhill, you may have to brake or shift to a lower gear to keep your speed down. Of course, applying the brake takes you out of cruise control. Many drivers find this to be too much trouble and don't use cruise control on steep hills.

## Ending Cruise Control

There are three ways to cancel the cruise control:

- Step lightly on the brake pedal,
- press CLEAR on the steering wheel or
- press the CRUISE button on the instrument panel.

## Erasing Cruise Speed Memory

When you turn off the cruise control or the ignition, your cruise control set speed memory is erased.

## Exterior Lamps



The lamp controls are located on the multifunction lever on the left of the steering wheel. They control the following systems:

- Headlamps
- Taillamps
- Parking Lamps
- License Lamps
- Sidemarkers Lamps
- Instrument Panel Lights

 : Turn the end of the lever to this symbol to turn on the headlamps and other operating lamps.

 : Turn the end of the lever to this symbol to turn on the parking and other operating lamps without the headlamps.

Turn the end of the lever to OFF to turn off the lamps.

A warning chime will sound if you open the driver's door when you turn the ignition switch to OFF or ACC with the lamps on.

## **Daytime Running Lamps / Automatic Headlamp Control**

Daytime Running Lamps (DRL) can make it easier for others to see the front of your vehicle during the day. DRL can be helpful in many different driving conditions, but they can be especially helpful in the short periods after dawn and before sunset. Fully functional daytime running lights are required on all vehicles first sold in Canada.

A light sensor on top of the instrument panel makes the DRL work, so be sure it isn't covered.

The DRL system will make your front turn signal lamps come on when the following conditions are met:

- The ignition is on,
- the headlamp switch is off and
- the parking brake is released.

When the DRL are on, only your front turn signal lamps will be on. The headlamps, taillamps, sidemarker and other lamps won't be on. Your instrument panel won't be lit up either.

When it's dark enough outside, your front turn signal lamps will turn off and your headlamps and parking lamps will turn on.

When it's bright enough outside, your headlamps will go off and your front turn signal lamps will come on.

To idle your vehicle with the DRL or automatic headlamps off, set the parking brake while the ignition is in OFF. Then start your vehicle. The DRL, headlamps and parking lamps will stay off until you release the parking brake.

To turn off the automatic headlamp feature when it's dark outside, move the exterior lamp control to the parking lamp position. Your parking lamps will remain illuminated and your headlamps will turn off. The fog lamps (if equipped) will also be lit if they were on when you switched to the parking lamp position.

As with any vehicle, you should turn on the regular headlamp system when you need it.

## Fog Lamps (If Equipped)

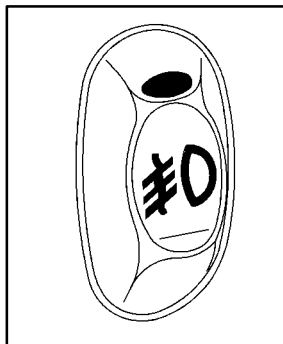

To turn the fog lamps on, press the top of the fog lamp switch located on the left side of the instrument panel.

A light will glow on the switch to let you know that they are on. The parking lamps must be on or your fog lamps will not illuminate. Press the bottom of the switch to turn the fog lamps off.

The fog lamps will go off whenever you change to high-beam headlamps. When you return to low beams, the fog lamps will come on again.

## Interior Lamps

### Instrument Panel Brightness Control

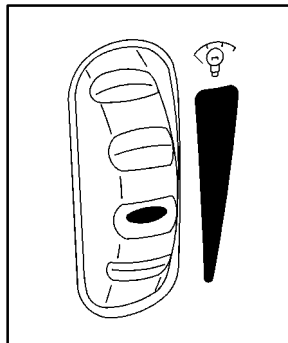

You can brighten or dim the instrument panel lights by turning the interior lamps thumbwheel.

Turn the thumbwheel upward to increase the brightness of the instrument panel lights. Turn the thumbwheel downward to decrease the brightness.

### Parade Mode

The instrument panel brightness control has an added feature called parade mode to assist you in seeing certain instrument panel controls if your headlamps are on in the daylight. Without turning the courtesy lamps on, turn the instrument panel brightness thumbwheel all the way to the top. The radio, season/trip odometer, gearshift selection indicator on the instrument panel cluster and the heating and air conditioning controls will come on at their maximum brightness. This will occur only with the parking lamps or headlamps on.

### Courtesy Lamps

When any door is opened, several lamps come on. These lamps are courtesy lamps. They make it easy for you to enter and leave your vehicle. You can also turn these lamps on by turning the interior lamps thumbwheel all the way up or by turning on each individual lamp.

## Illuminated Entry

Your courtesy lamps will come on and stay on for a set time whenever you press UNLOCK on the remote keyless entry transmitter (if equipped).

If you open a door, the lamps will stay on while it's open then turn off automatically about 25 seconds after you close it. If you press UNLOCK and don't open a door, the lamps will turn off after about 40 seconds.

Illuminated entry includes a feature called theater dimming. With theater dimming, the lamps don't just turn off at the end of the delay time. Instead, they slowly dim after the delay time until they go out. The delay time is cancelled if you turn the ignition key to ON so that the lamps will dim out right away. When the ignition is on, illuminated entry is inactive, which means the courtesy lamps won't come on unless a door is opened.

## Illumination on Door Handle Activation

Illumination on door handle activation is a standard feature intended to provide enhanced security and convenience by allowing the driver to activate the vehicle interior illumination without unlocking or opening any vehicle door.

The ignition must be off and the doors locked for the illumination on door handle activation to work. The illumination on door handle activation feature can function in two ways.

If the driver pulls and releases any front door handle within one second, the interior lamps will illuminate until one of the following occurs:

- The ignition is turned to ON,
- the power door locks are activated or
- an illumination period of 25 seconds has elapsed.

Or, if the driver pulls and holds any front door handle for more than one second, the interior lamps will illuminate until one of the following occurs:

- The ignition is turned to ON,
- the door handle is released or
- an illumination period of 50 seconds has elapsed.

If during the illumination period a door is opened, the timed illumination period will be cancelled, though the interior lamps will remain on because a vehicle door is open.

## Delayed Illumination

The delayed illumination feature will continue to illuminate the interior for 25 seconds after all doors have been closed so that you can find the ignition and buckle your seat belt at night. Delayed illumination will not occur while the ignition is in ON. After 25 seconds have elapsed, the interior lamps will slowly fade out. The lamps will fade out before 25 seconds have elapsed if you do one of the following:

- Turn the ignition to ON.
- Lock all doors using your remote keyless entry transmitter (if equipped).
- Lock the doors using the power door lock switch.

If during the delayed illumination period a door is opened, the timed illumination period will be cancelled, though the interior lamps will remain on because a door is open.

## Exit Illumination

To see better when exiting your vehicle at night, your vehicle is equipped with an exit illumination feature. The interior lamps will illuminate for up to 25 seconds when you remove your key from the ignition. After 25 seconds have elapsed, the interior lamps will slowly fade out. The lamps will fade out before the 25 seconds have elapsed if you do one of the following:

- Turn the ignition to ON.
- Lock all doors using your remote keyless entry transmitter (if equipped).
- Lock the doors using the power door lock switch.

When any door is opened, exit illumination is cancelled. The interior lamps will stay on when any door is open. The interior lamps may stay on for up to 25 seconds after all the doors have been closed if they have not been locked. See “Delayed Illumination” in the Index.



## Battery Saver

Your vehicle has a feature to help prevent you from draining the battery in case you accidentally leave an interior or trunk lamp on. If you leave any of these lamps on while the ignition is in ACC or OFF, they will automatically turn off after 20 minutes. The lamps won't come back on until you do one of the following:

- Turn the ignition to ON,
- turn the interior lamp thumbwheel all the way up or
- open (or close and reopen) a door that is closed.

If the vehicle has less than 15 miles (25 km) on the odometer, the battery saver will turn off the lamps after only three minutes.

## Mirrors

Adjust all mirrors so you can see clearly when you are sitting in a comfortable position.

### Inside Day/Night Rearview Mirror

To reduce glare from lamps behind you, push the lever located on the bottom center of the mirror away from you to the night position. To return the mirror back to the day position, pull the lever toward you.

## Electrochromic Day/Night Rearview Mirror with Compass and Map Lamps (If Equipped)

Your vehicle may have an automatic electrochromic day/night rearview mirror with a compass and map lamps.



This mirror automatically changes to reduce glare from headlamps behind you. A time delay feature prevents rapid changing from the day to night positions while driving under lights and through traffic.



The mirror includes two map lamps, an automatic dimming function and an eight-point compass display in the upper corner of the mirror face. When the compass display is turned on, the compass automatically calibrates as the vehicle is driven.

The automatic dimming feature is turned on or off by pressing the IO button located on the lower part of the mirror. Press and hold the IO button for up to three seconds to turn this feature on or off.

The compass display feature is turned on or off by pressing the IO button for three seconds or more.

When cleaning the mirror, use a paper towel or similar material dampened with glass cleaner. Do not spray glass cleaner directly on the mirror housing.

The compass may need to be calibrated. See “Compass Calibration” in the Index.

### **Electrochromic Day/Night Rearview Mirror with Compass Display and OnStar<sup>®</sup> (If Equipped)**

Your vehicle may have an automatic electrochromic day/night rearview mirror with a compass display and the OnStar system.

When turned on, this mirror functions exactly like the electrochromic mirror described previously. See “Mirrors, Electrochromic Rearview with Compass” in the Index for more information.

The mirror has an eight-point compass display in the upper right corner of the mirror face and a three-button OnStar system. There are also two map lamps located on the bottom of the mirror. Each lamp is turned on or off with a switch located next to the lamp.

The automatic dimming feature is turned on or off by pressing the far left button, located on the lower part of the mirror face, for up to three seconds. If the button is pressed and held for five to seven seconds, the compass display will go blank.



There are three buttons for the OnStar system. See your dealer for more information on the system and how to subscribe to OnStar. See “OnStar<sup>®</sup> System” in the Index for more information on the services OnStar provides.

## Compass Calibration

Press the on/off button for eight seconds to activate the compass calibration mode. The letter “C” will be displayed in the compass window of the mirror.

The mirror can be calibrated in one of two ways:

- Drive the vehicle in circles at 5 mph (8 km/h) or less until the display indicates a direction, or
- drive the vehicle on your everyday routine.

## Compass Variance

The mirror is set in zone eight upon leaving the factory. It will be necessary to adjust the compass to compensate for compass variance if you live outside zone eight. Under certain circumstances, such as during a long distance cross-country trip, it will be necessary to adjust for compass variance. Compass variance is the difference between earth’s magnetic north and true geographic north. If not adjusted to account for compass variance, your compass could give false readings.

To adjust for compass variance do the following:

1. Find your current location and variance zone number on the following zone map.

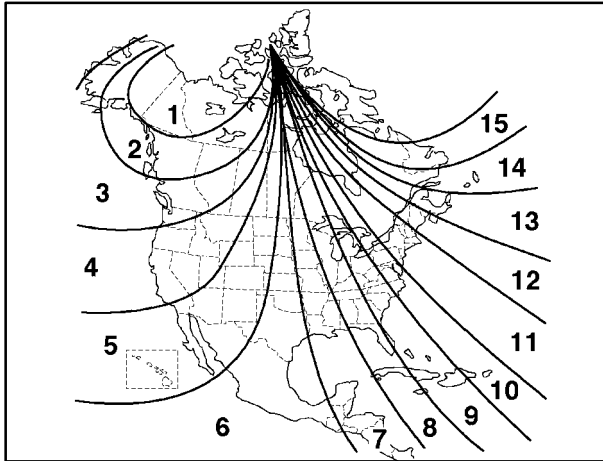

2. Make sure the compass is in calibration mode. See “Compass Calibration” in the Index. Press the on/off button to display the zone number.
3. Scroll through the zone numbers that appear in the compass window of the mirror. Once you find your zone number in the window, release the on/off button. After about four seconds, the mirror will return to the compass display, and the new zone number will be set. (Compass calibration may be necessary. See “Compass Calibration” in the Index).

## Power Outside Mirrors



The power mirror controls are located near the driver's window, on the armrest.

Slide the top switch to the left to adjust the driver's side mirror, or slide it to the right to adjust the passenger's side mirror. Then press the arrows on the lower control in the direction you want to move the mirror. Once the mirror is adjusted, move the top switch to the middle position.

## Convex Outside Mirror

Your passenger's side mirror is convex. A convex mirror's surface is curved so you can see more from the driver's seat.

## CAUTION:

**A convex mirror can make things (like other vehicles) look farther away than they really are. If you cut too sharply into the right lane, you could hit a vehicle on your right. Check your inside mirror or glance over your shoulder before changing lanes.**

## Storage Compartments

### Glove Box

Use the key to lock and unlock the glove box.

### Center Console

To open the storage area located between the driver's and passenger's seat, press back on the front edge and lift the cover. The console has a cassette tape and compact disc storage area and a coinholder. The cupholder is located below the storage area. Push down on the door and the cupholder will come out.

## Rear Console Cupholders



The cupholders are located in the rear of the front console. Pull down to use the cupholders.

## Convenience Net (If Equipped)

Your vehicle may have a convenience net. You'll see it on the back wall of the trunk.

Put small loads, like grocery bags, behind the net. It can help keep them from falling over during sharp turns or quick starts and stops.

The net isn't for larger, heavier loads. Store them in the trunk as far forward as you can.

You can unhook the net so that it will lie flat when you're not using it. You can also push the net down and hook it under the plastic hooks.

## Ashtrays and Cigarette Lighter

When your vehicle is delivered, the cigarette lighter assembly will be in a plastic bag placed in the center console storage area. The ashtray is available upon request from your dealer. If the ashtray and lighter are needed, insert the ashtray and holder into the stationary, open cupholder in front of the shift lever.

The lighter outlet is located behind a flip-out door below the heating and air conditioning controls.

## Sun Visors

To block out the glare, you can swing down the visors. You can also swing them from front to side. The visors have extenders that you can pull out for added coverage.

## Visor Vanity Mirrors

Open the cover to expose the vanity mirror. If your vehicle has the optional lighted vanity mirrors, the lamps will come on when you open the cover.

## Accessory Power Outlets



The accessory power outlets are located on the passenger's lower left side and below the comfort controls on the instrument panel.

The power outlets can be used to plug in electrical equipment such as a cellular telephone, a compact disc player, etc. Follow the proper installation instructions included with any electrical equipment you install.

Certain accessory power plugs may not be compatible to the accessory power outlet and could result in blown vehicle or adapter fuses. If you experience a problem, see your dealer for additional information on the accessory power plugs.

## NOTICE:

**Adding some electrical equipment to your vehicle can damage it or keep other things from working as they should. This wouldn't be covered by your warranty. Check with your dealer before adding electrical equipment, and never use anything that exceeds the fuse rating.**

## OnStar<sup>®</sup> System (If Equipped)

OnStar is a vehicle communications system that offers a variety of services and provides a hands-free communication link between you and the OnStar Center. A service subscription agreement and fee are required in order to receive OnStar service. Services are available 24 hours a day, 7 days a week. For more information, call 1-888-ONSTAR-7 (1-888-667-8277).



**OnStar Services Button:** Press this button once to contact an advisor who will be able to assist you with these services. If you are not quickly connected, the system will automatically reset and redial. This ensures connection to the center; there is no additional action required. Press the Call Answer/End button to cancel the automatic redial.



 **Emergency Button:** In an emergency situation, press the emergency service button. Upon receiving the call, an advisor at the center will locate your vehicle and assess the situation. If necessary, the advisor will alert the nearest emergency service provider.

 **Call ANSWER/END Button:** Use this button to answer a call. (If you are receiving a call, the audio system will mute, and the ring will be heard). Press this button at the end of a call to disconnect and return the audio system to its previous settings. This button will also cancel a call if one of the buttons is accidentally pressed or if the automatic redial function is activated.

**Volume Control:** You can control the volume of the OnStar system using either the volume control knob on the radio or by using the audio steering wheel controls (if equipped).

 **Telltale Light:** This light will indicate the status of the system. A solid green light will come on when you start the vehicle to let you know that the system is on and is ready to make or receive calls.

If the light blinks green it means that an incoming or outgoing call is in progress. Press the Call ANSWER/END button if you notice the light blinking and you are not on a call.

The light will be red in the event of an OnStar system malfunction. If this occurs press the OnStar button to attempt to contact an advisor. If the connection is made, the advisor will assist you with steps to take to make sure that the system is functioning properly. If you cannot contact the advisor, take your vehicle to your dealership as soon as possible for assistance.

## Safety and Security Services

- **Automatic Notification of Air Bag**

**Deployment** -- If an air bag deploys, a priority emergency signal is automatically sent to the center. An advisor will locate your vehicle's position, try to contact you and assist you in the situation. If the center is unable to contact you, an emergency service provider will be contacted.

- **Stolen Vehicle Tracking** -- Call the center at 1-888-4-ONSTAR (1-888-466-7827) to report your vehicle stolen. The system can then locate and track your vehicle and the advisor will be able to notify the proper authorities.
- **Roadside Assistance with Location** -- For vehicle breakdowns, press the OnStar button. An advisor will contact the appropriate help.
- **Remote Diagnostics** -- If an instrument panel light comes on, the center can perform a check of the engine on-board computer. An advisor can then recommend what action needs to be taken.

- **OnStar MED-NET** -- Med-Net can store your personal medical history and provide it to emergency personnel if necessary. (Requires activation and additional fee.)
- **Accident Assist** -- An advisor can provide step-by-step guidance following an accident.
- **Remote Door Unlock** -- To contact the center, call 1-888-4-ONSTAR. You will be required to provide your security information. An advisor will send a command to your vehicle to unlock itself. The advisor can delay unlocking your vehicle. Remote Door Unlock is disabled 48 hours after the vehicle is parked to maintain the battery charge.
- **Vehicle Locator Service** -- To contact the center, call 1-888-4-ONSTAR. You will be required to provide your security information. An advisor will send a command to your vehicle to sound the horn and/or flash the lamps.

In order to provide you with excellent service, calls with the OnStar Center may be monitored or recorded.

## Premium Services (Includes Safety and Security Services)

- **Route Support** -- An advisor can provide directions or guidance to anywhere you want to go. In addition, they can help you locate gas stations, rest areas, ATMs, hospitals, hotels, stores, eateries and more.
- **Concierge Services** -- The concierge advisor can obtain tickets, reservations, or help with vacation/trip planning and other unique items and services.
- **Ride Assist** -- An advisor can locate transportation in the event that you are unable to drive.

## OnStar System Limitations

Complete limitations can be found on the Subscriber Services Agreement.

OnStar Service is:

- available in the United States and Canada;
- available when the vehicle is within the operating range of a cellular provider;

- subject to limitations caused by atmospheric conditions, such as severe weather or topographical conditions, such as mountainous terrain;
- subject to cellular carrier equipment limitations.

Global positioning capabilities used to deliver OnStar Service will not be available if satellite signals are obstructed.

OnStar will not function if the vehicle's battery is discharged or disconnected. It may also be inoperative if the vehicle is in an accident and the OnStar or vehicle electrical system components are damaged.

Safety and security services are provided by existing governmental emergency service providers. OnStar will use reasonable efforts to contact the appropriate emergency service provider and request assistance but cannot promise that they will respond to the call in a timely manner or at all.

## Power Sunroof (Option)



The sunroof includes a sliding glass panel and a sunshade. The switch works only when the ignition or retained accessory power (RAP) is active. See “Retained Accessory Power (RAP)” in the Index.

To open the sunroof to the vent position only, push and hold the front of the switch. You will need to open the sunshade by hand. To close the sunroof from the vent position, push and hold the rear of the switch.

To open the sunroof, push the rear of the switch once. The sunroof and sunshade will open by themselves. This is the express-open feature.

To close the sunroof, push and hold the front of the switch until the sunroof motor stops. The sunshade must be closed by hand.

## The Instrument Panel -- Your Information System

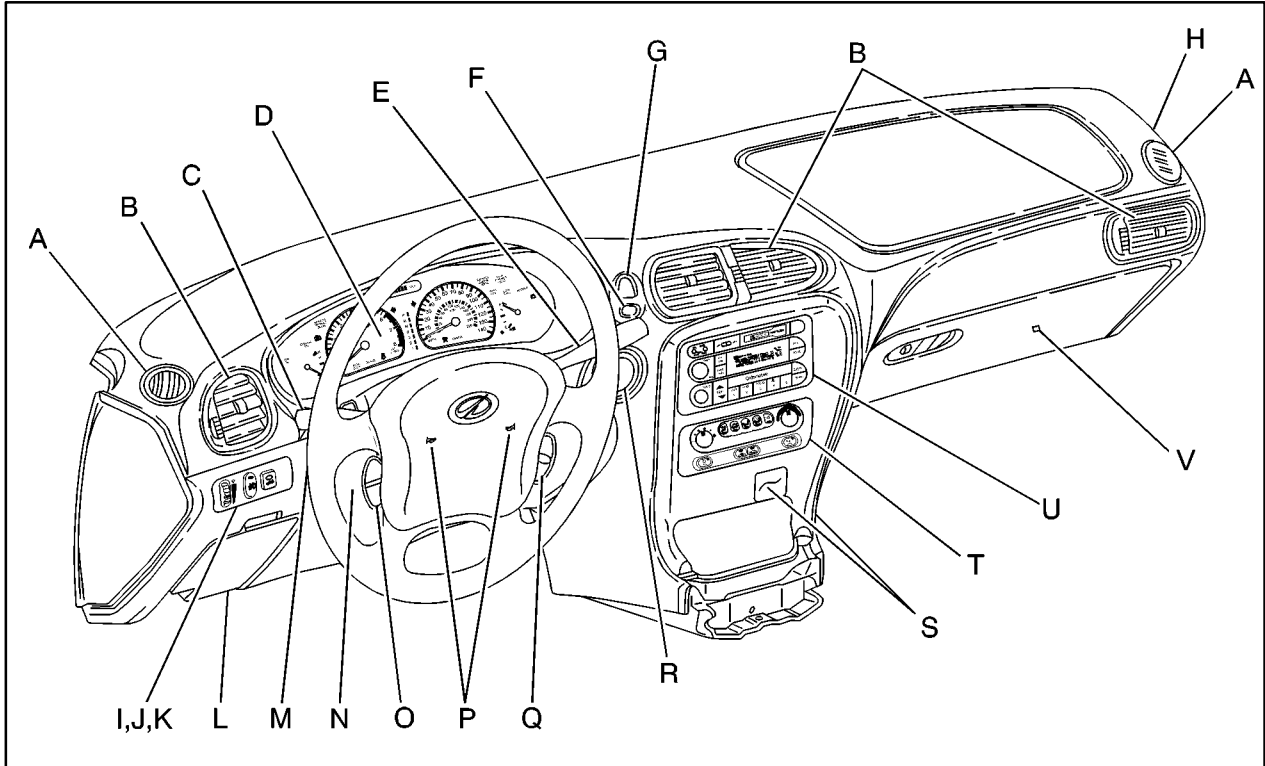

Your instrument panel is designed to let you know at a glance how your vehicle is running. You'll know how fast you're going, about how much fuel is in your tank and many other things you need to drive safely and economically.

The main components of your instrument panel are listed below:

- A. Side Window Defogger Vents
- B. Instrument Panel Outlets
- C. Turn Signal/Multifunction Lever
- D. Instrument Panel Cluster
- E. Windshield Wipers/Washer Fluid Lever
- F. Cruise Control (CRUISE) Button
- G. Hazard Button
- H. Instrument Panel Fuse Block
- I. Instrument Panel Dimmer Thumbwheel
- J. Fog Lamp Button (If Equipped)
- K. Trunk Lid Release Button
- L. Storage Bin
- M. Trip Odometer
- N. Tilt Wheel Lever (behind the steering wheel)
- O. Audio Steering Wheel Controls (If Equipped)
- P. Horn
- Q. Cruise Control Switches (RES ACCEL, CLEAR, COAST SET)
- R. Ignition Switch
- S. Accessory Power Outlets
- T. Comfort Controls
- U. Audio System
- V. Glove Box

## Instrument Panel Cluster

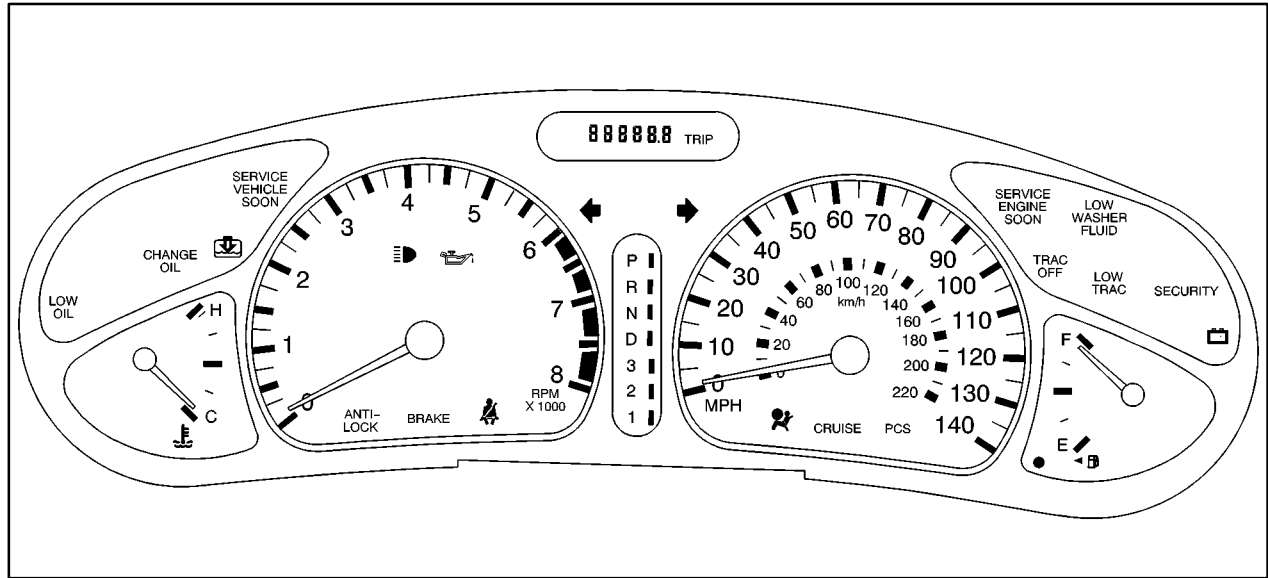

**United States version shown, Canadian similar**

Your instrument panel cluster includes indicator warning lights and gages that are explained on the following pages.

## Speedometer/Odometer

Your speedometer lets you see your speed in both miles per hour (mph) and kilometers per hour (km/h). Your odometer shows how far your vehicle has been driven in either miles (used in the United States) or in kilometers (used in Canada).

Your vehicle has a tamper-resistant odometer.

If your odometer fails and needs to be replaced, the entire cluster needs to be replaced. Take your vehicle to the dealer to have this done. The dealer will have the new cluster odometer set to the mileage of the old odometer/cluster if at all possible. But if it can't, then it's set at zero and a label must be put on the driver's door to show the old mileage reading when the new odometer was installed.

## Season/Trip Mode



Press this button to display the total vehicle mileage (season mode).

It is also pressed to display the trip mileage (trip mode). The mode switch is located on the left side of the instrument panel, next to the TRIP RESET button for the trip odometer.



## Trip Odometer



Your trip odometer (trip mode) tells you how far you have driven since you last reset it. To set it to zero, press and hold the TRIP RESET button on the left side of the instrument panel for two to three seconds.

## Tachometer

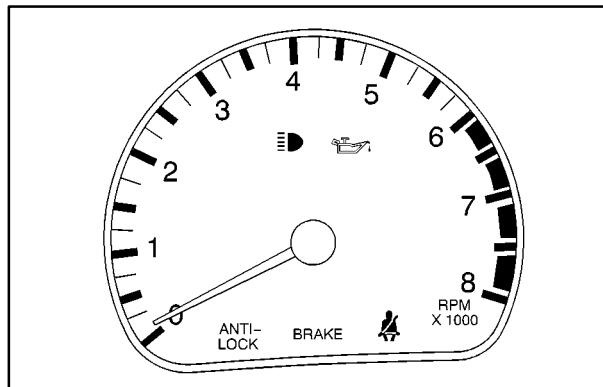

The tachometer displays the engine speed in thousands of revolutions per minute (rpm).

### **NOTICE:**

**Do not operate the engine with the tachometer in the shaded area, or engine damage may occur.**

## Warning Lights, Gages and Indicators

This part describes the warning lights and gages that may be on your vehicle. The pictures will help you locate them.

Warning lights and gages can signal that something is wrong before it becomes serious enough to cause an expensive repair or replacement. Paying attention to your warning lights and gages could also save you or others from injury.

Warning lights come on when there may be or is a problem with one of your vehicle's functions. As you will see in the details on the next few pages, some warning lights come on briefly when you start the engine just to let you know they're working. If you are familiar with this section, you should not be alarmed when this happens.

Gages can indicate when there may be or is a problem with one of your vehicle's functions. Often gages and warning lights work together to let you know when there's a problem with your vehicle.

When one of the warning lights comes on and stays on when you are driving, or when one of the gages shows there may be a problem, check the section that tells you what to do about it. Please follow this manual's advice. Waiting to do repairs can be costly -- and even dangerous. So please get to know your warning lights and gages. They're a big help.

### Safety Belt Reminder Light

When the key is turned to ON, a chime will come on for about eight seconds to remind people to fasten their safety belts, unless the driver's safety belt is already buckled.



The safety belt light will also come on and stay on for about 20 seconds, then it will flash for about 55 seconds.

If the driver's belt is already buckled, neither the chime nor the light will come on.

## Air Bag Readiness Light

There is an air bag readiness light on the instrument panel, which shows the air bag symbol. The system checks the air bag's electrical system for malfunctions. The light tells you if there is an electrical problem. The system check includes the air bag modules, the wiring and the crash sensing and diagnostic module. For more information on the air bag system, see "Air Bag" in the Index.

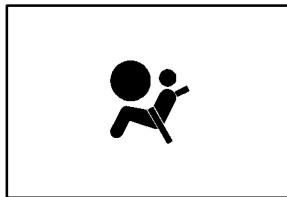

This light will come on when you start your vehicle, and it will flash for a few seconds. Then the light should go out. This means the system is ready.

If the air bag readiness light stays on after you start the vehicle or comes on when you are driving, your air bag system may not work properly. Have your vehicle serviced right away.

### CAUTION:

**If the air bag readiness light stays on after you start your vehicle, it means the air bag system may not be working properly. The air bags in your vehicle may not inflate in a crash, or they could even inflate without a crash. To help avoid injury to yourself or others, have your vehicle serviced right away if the air bag readiness light stays on after you start your vehicle.**

The air bag readiness light should flash for a few seconds when you turn the ignition key to ON. If the light doesn't come on then, have it fixed so it will be ready to warn you if there is a problem.

## Charging System Light

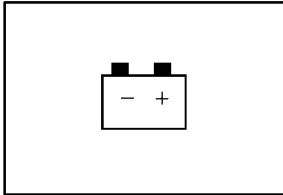

The charging system light will come on briefly when you turn the ignition key to ON as a check to show you it's working. Then it should go out.

If it stays on, or comes on while you're driving, you may have a problem with the charging system. It could indicate that you have a loose drive belt or another electrical problem. Have it checked right away. Driving while this light is on could drain your battery.

If you must drive a short distance with the light on, be certain to turn off all your accessories, such as the radio and air conditioner.

## Brake System Warning Light

Your vehicle's hydraulic brake system is divided into two parts. If one part isn't working, the other part can still work and stop you. For good braking, though, you need both parts working well.

If the warning light comes on, there is a brake problem. Have your brake system inspected right away.



**United States**

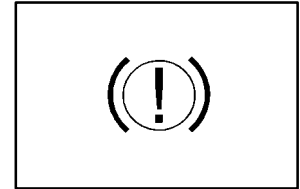

**Canada**

This light should come on briefly when you turn the ignition key to ON. If it doesn't come on then, have it fixed so it will be ready to warn you if there's a problem.

If the light comes on while you are driving, pull off the road and stop carefully. You may notice that the pedal is harder to push. Or, the pedal may go closer to the floor. It may take longer to stop. If the light is still on, have the vehicle towed for service. See “Towing Your Vehicle” in the Index.

## Anti-Lock Brake System Warning Light

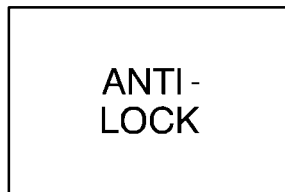

United States

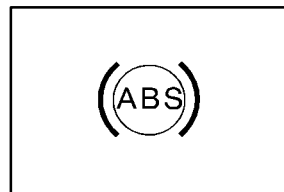

Canada

With the anti-lock brake system, the light will come on when your engine is started and may stay on for three seconds. That's normal.

If the anti-lock brake system warning light stays on longer than normal after you've started your engine, turn the ignition off. Or, if the light comes on and stays on when you're driving, stop as soon as possible and turn the ignition off. Then start the engine again to reset the system. If the light still stays on, or comes on again while you're driving, your vehicle needs service. If the light is on and the regular brake system warning light isn't on, you still have brakes, but you don't have anti-lock brakes. Adjust your driving accordingly.

The anti-lock brake system warning light should come on briefly when you turn the ignition key to ON. If the light doesn't come on then, have it fixed so it will be ready to warn you if there is a problem.

### CAUTION:

**Your brake system may not be working properly if the brake system warning light is on. Driving with the brake system warning light on can lead to an accident. If the light is still on after you've pulled off the road and stopped carefully, have the vehicle towed for service.**

When the ignition is on, the brake system warning light will also come on when you set your parking brake. The light will stay on if your parking brake doesn't release fully. If it stays on after your parking brake is fully released, it means you have a brake problem.

A warning chime will sound if your parking brake is set and the gear shift is not in PARK (P) or NEUTRAL (N).

## Traction Control System Warning Light (Option)

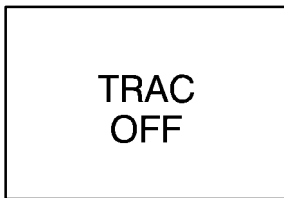

This warning light should come on briefly when the engine is started.

If the warning light doesn't come on then, have it fixed so it will be ready to warn you if there's a problem. If it stays on, or comes on when you're driving, there may be a problem with your traction control system and your vehicle may need service. When this warning light is on, the system will not limit wheel spin. Adjust your driving accordingly.

The traction control system warning light may come on for the following reasons:

- If you turn the system off by pressing the TRACTION CONTROL button located on the console, the warning light will come on and stay on. To turn the system back on, press the button again. The warning light should go off. See “Traction Control System” in the Index for more information.
- If there's a brake system problem that is specifically related to traction control, the traction control system will turn off and the warning light will come on. If your brakes begin to overheat, the traction control system will turn off and the warning light will come on until your brakes cool down.
- If the traction control system is affected by an engine-related problem, the system will turn off and the warning light will come on.

If the traction control system warning light comes on and stays on for an extended period of time when the system is turned on, your vehicle needs service.

## Precision Control System (PCS) Warning Light (Option)

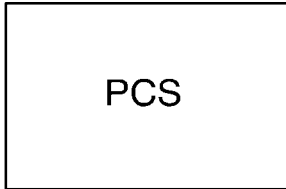

**United States**



**Canada**

This light should come on briefly as you start your engine. If the light doesn't come on then, have it serviced so it will be ready to warn you if there's a problem.

If the PCS warning light comes on, it means there may be a problem with your Precision Control System. When this light comes on, so will the TRAC OFF light and both the Precision Control System and the Traction Control System will not be functioning. If these lights come on, try to reset the system (stop; turn off the engine; then start the engine again). If the PCS and TRAC OFF lights remain on, it means there is a problem and you should see your dealer for service. Reduce your speed and drive accordingly.

## Low Traction Active (LOW TRAC) Light

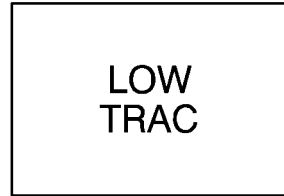

Your LOW TRAC (Low Traction Active) light may come on for one of the following reasons:

- The Precision Control System (PCS) (if equipped) is active and is adjusting brake pressure to help your vehicle continue to go in the direction in which you are steering. The PCS activates when the computer senses that your vehicle is starting to spin, as might happen if you hit a patch of ice or other slippery surface on the road, and assists the driver by selectively applying any one of the vehicle's brakes. The system is designed to help you in bad weather or other difficult driving situations by making the most of whatever road conditions will allow. When the system is on, you may hear a noise or feel a vibration in the brake pedal. This is normal.
- The optional Traction Control System is active and is limiting wheel spin. You may feel the system working, but this is normal. Slippery road conditions may exist, so adjust your driving accordingly.

If the LOW TRAC light comes on, slippery road conditions may exist, so you should consider slowing down and adjusting your driving accordingly.

## Engine Coolant Temperature Gage

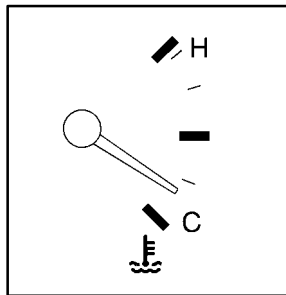

You have a gage that shows the engine coolant temperature. If the gage moves into the shaded area near the hot mark, your engine is too hot.

That reading means the same thing as the warning light. It means that your engine coolant has overheated. If you have been operating your vehicle under normal driving conditions, you should pull off the road, stop your vehicle and turn off the engine as soon as possible.

See “Engine Overheating” in the Index.

## Low Coolant Warning Light

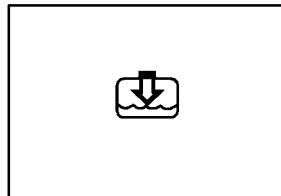

If this light comes on, your system is low on coolant, and the engine may overheat.

This light will come on briefly when the ignition is turned to ON. This is normal.

See “Engine Coolant” in the Index for more information, and have your vehicle serviced as soon as possible.



## Malfunction Indicator Lamp (Service Engine Soon Light in the United States or Check Engine Light in Canada)

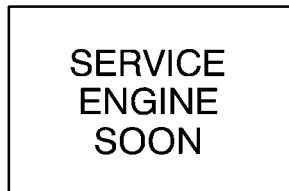

United States

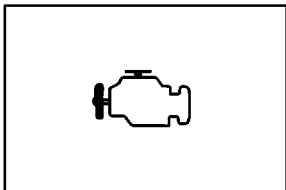

Canada

Your vehicle is equipped with a computer which monitors operation of the fuel, ignition and emission control systems.

This system is called OBD II (On-Board Diagnostics-Second Generation) and is intended to assure that emissions are at acceptable levels for the life of the vehicle, helping to produce a cleaner environment. The SERVICE ENGINE SOON or CHECK ENGINE light comes on and a chime will sound to indicate that there is a problem and service is required. Malfunctions often will be indicated by the system before any problem is apparent. This may prevent more serious damage to your vehicle. This system is also designed to assist your service technician in correctly diagnosing any malfunction.

### NOTICE:

If you keep driving your vehicle with this light on, after a while, your emission controls may not work as well, your fuel economy may not be as good and your engine may not run as smoothly. This could lead to costly repairs that may not be covered by your warranty.

### NOTICE:

Modifications made to the engine, transaxle, exhaust, intake or fuel system of your vehicle or the replacement of the original tires with other than those of the same Tire Performance Criteria (TPC) can affect your vehicle's emission controls and may cause the SERVICE ENGINE SOON or CHECK ENGINE light to come on. Modifications to these systems could lead to costly repairs not covered by your warranty. This may also result in a failure to pass a required Emission Inspection/Maintenance test.

This light should come on, as a check to show you it is working, when the ignition is on and the engine is not running. If the light doesn't come on, have it repaired. This light will also come on during a malfunction in one of two ways:

- **Light Flashing** -- A misfire condition has been detected. A misfire increases vehicle emissions and may damage the emission control system on your vehicle. Dealer or qualified service center diagnosis and service may be required.
- **Light On Steady** -- An emission control system malfunction has been detected on your vehicle. Dealer or qualified service center diagnosis and service may be required.

### **If the Light Is Flashing**

The following may prevent more serious damage to your vehicle:

- Reducing vehicle speed.
- Avoiding hard accelerations.
- Avoiding steep uphill grades.
- If you are towing a trailer, reduce the amount of cargo being hauled as soon as it is possible.

If the light stops flashing and remains on steady, see “If the Light Is On Steady” following.

If the light continues to flash, when it is safe to do so, *stop the vehicle*. Find a safe place to park your vehicle. Turn the key off, wait at least 10 seconds and restart the engine. If the light remains on steady, see “If the Light Is On Steady” following. If the light is still flashing, follow the previous steps, and drive the vehicle to your dealer or qualified service center for service.

### **If the Light Is On Steady**

You may be able to correct the emission system malfunction by considering the following:

Did you recently put fuel into your vehicle?

If so, reinstall the fuel cap, making sure to fully install the cap. See “Filling Your Tank” in the Index. The diagnostic system can determine if the fuel cap has been left off or improperly installed. A loose or missing fuel cap will allow fuel to evaporate into the atmosphere. A few driving trips with the cap properly installed should turn the light off.

Did you just drive through a deep puddle of water?

If so, your electrical system may be wet. The condition will usually be corrected when the electrical system dries out. A few driving trips should turn the light off.

Are you low on fuel?

As your engine starts to run out of fuel, your engine may not run as efficiently as designed since small amounts of air are sucked into the fuel line causing a misfire. The system can detect this. Adding fuel should correct this condition. Make sure to install the fuel cap properly. See “Filling Your Tank” in the Index. It will take a few driving trips to turn the light off.

Have you recently changed brands of fuel?

If so, be sure to fuel your vehicle with quality fuel. See “Fuel” in the Index. Poor fuel quality will cause your engine not to run as efficiently as designed. You may notice this as stalling after start-up, stalling when you put the vehicle into gear, misfiring, hesitation on acceleration or stumbling on acceleration. (These conditions may go away once the engine is warmed up.) This will be detected by the system and cause the light to turn on.

If you experience one or more of these conditions, change the fuel brand you use. It will require at least one full tank of the proper fuel to turn the light off.

If none of the above steps have made the light turn off, have your dealer or qualified service center check the vehicle. Your dealer has the proper test equipment and diagnostic tools to fix any mechanical or electrical problems that may have developed.

## Emissions Inspection and Maintenance Programs

Some state/provincial and local governments have or may begin programs to inspect the emission control equipment on your vehicle. Failure to pass this inspection could prevent you from getting a vehicle registration.

Here are some things you need to know in order to help your vehicle pass an inspection:

Your vehicle will not pass this inspection if the SERVICE ENGINE SOON or CHECK ENGINE light is on or not working properly.

Your vehicle will not pass this inspection if the OBD (on-board diagnostic) system determines that critical emission control systems have not been completely diagnosed by the system. The vehicle would be considered not ready for inspection. This can happen if you have recently replaced your battery or if your battery has run down. The diagnostic system is designed to evaluate critical emission control systems during normal driving. This may take several days of routine driving. If you have done this and your vehicle still does not pass the inspection for lack of OBD system readiness, see your dealer or qualified service center to prepare the vehicle for inspection.

## Oil Warning Light

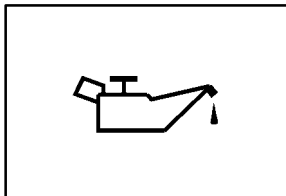

If you have a problem with your oil, this light may stay on after you start your engine or come on when you are driving.

This indicates that oil is not going through your engine quickly enough to keep it lubricated. The engine could be low on oil or could have some other oil problem. Have your vehicle serviced immediately.

The oil light could also come on when the ignition is on but the engine is not running. This is normal. The light comes on as a test to show you it's working, but the light should go out when you turn the ignition to ON. If it doesn't come on with the ignition on, you may have a problem with the fuse or bulb. Have it fixed right away.

### **CAUTION:**

**Don't keep driving if the oil pressure is low. If you do, your engine can become so hot that it catches fire. You or others could be burned. Check your oil as soon as possible and have your vehicle serviced.**

### **NOTICE:**

**Damage to your engine from neglected oil problems can be costly and is not covered by your warranty.**

## Service Vehicle Soon Light



This light will come on briefly when the ignition is turned to ON to show that the bulb is working.

This light indicates problems with your vehicle that are not related to emissions.

These problems may not be obvious and may affect vehicle performance and durability. Consult your dealer for necessary repairs to maintain vehicle performance.

## Low Oil Level Light

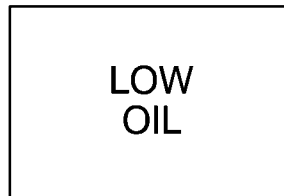

Your engine is equipped with an oil level monitoring system. When the ignition is turned to ON, the LOW OIL light will briefly come on.

If the light does not flash, have it fixed so it will be ready to warn you if there's a problem.

If the light stays on, stop the vehicle on a level surface and turn the engine off. Check the oil level using the engine oil dipstick. (See "Engine Oil" in the Index.)

The oil level monitoring system only checks oil level during the brief period between key on and engine crank. It does not monitor engine oil level when the engine is running. Additionally, an oil level check is only performed if the engine has been turned off for an extended period of time, allowing the oil normally in circulation to drain back into the oil pan.

## Change Oil Light

**CHANGE  
OIL**

The CHANGE OIL light should come on briefly as a bulb check when you start the engine. If the light doesn't come on, have the vehicle serviced right away.

If the CHANGE OIL light comes on and stays on after you start the engine, have the oil changed.

For additional information see “Engine Oil, When to Change” in the Index. To reset the GM Oil Life System,™ see “How to Reset the Change Oil Light” in the Index.

## Security Light

**SECURITY**

This light will come on when you turn the key to START and will stay on until the engine starts.

If you're driving and the SECURITY light comes on and stays on, your Passlock® system is not working properly. Your vehicle is not protected by Passlock and you should see your dealer. For more information, see “Passlock” in the Index.

## Cruise Light

**CRUISE**

The CRUISE light comes on whenever you set your cruise control. See “Cruise Control” in the Index.

## Low Washer Fluid Light

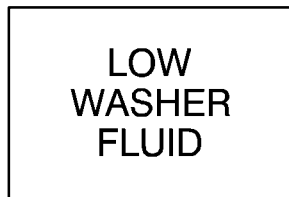

This light appears when your vehicle is low on windshield washer fluid.

This light will come on when your ignition is turned on to check the bulb. It will go out after a few seconds. If the light does not come on when you start your vehicle, the bulb may need to be replaced. See your dealer to have it fixed right away.

If this light appears while you're driving, your vehicle is low on washer fluid. Be sure to refill the tank as soon as possible so that you'll have washer fluid available when you need it.

## Fuel Gage

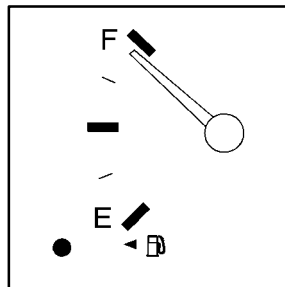

United States

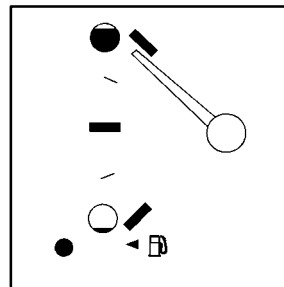

Canada

Your fuel gage tells you about how much fuel you have left when the ignition is on.

When the indicator nears empty, you still have a little fuel left, but you should get more soon.

Here are four things that some owners ask about. All these things are normal and do not indicate a problem with the fuel gage:

- At the gas station, the gas pump shuts off before the gage reads full.
- It takes more (or less) fuel to fill up than the gage reads. For example, the gage reads half full, but it takes more (or less) than half the fuel tank's capacity to fill it.
- The gage pointer may move while cornering, braking or speeding up.
- The gage may not indicate empty when the ignition is turned off.

## Low Fuel Light

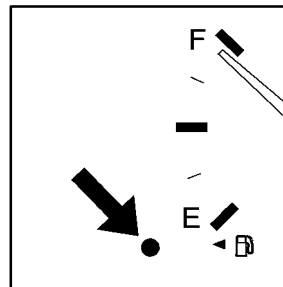

**United States**

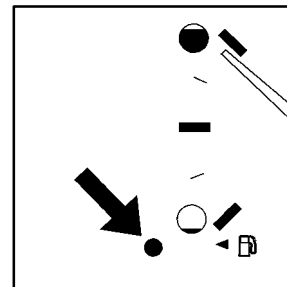

**Canada**

If your vehicle is low on fuel, this warning light near the fuel gage will come on.

It will also come on for a few seconds when you first turn on the ignition as a check to show you it's working. If it doesn't come on then, the bulb may need to be replaced. See your dealer to have it fixed right away.





## Section 3 Comfort Controls and Audio Systems

---

In this section, you'll find out how to operate the comfort control and audio systems offered with your vehicle. Be sure to read about the particular systems supplied with your vehicle.

3-2	Comfort Controls	3-15	AM-FM Stereo with Cassette Tape and Compact Disc Player with Automatic Tone Control (If Equipped)
3-2	Air Conditioning with Electronic Controls	3-22	Theft-Deterrent Feature
3-4	Air Conditioning	3-24	Audio Steering Wheel Controls (If Equipped)
3-5	Air Conditioning with Automatic and Auxiliary Temperature Control (If Equipped)	3-24	Understanding Radio Reception
3-9	Rear Window Defogger	3-24	Tips About Your Audio System
3-10	Ventilation System	3-25	Care of Your Cassette Tape Player
3-11	Audio Systems	3-26	Care of Your Compact Discs
3-11	Setting the Clock	3-26	Care of Your Compact Disc Player
3-11	AM-FM Stereo with Cassette Tape Player and Automatic Tone Control	3-27	Backglass Antenna

## Comfort Controls

### Air Conditioning with Electronic Controls

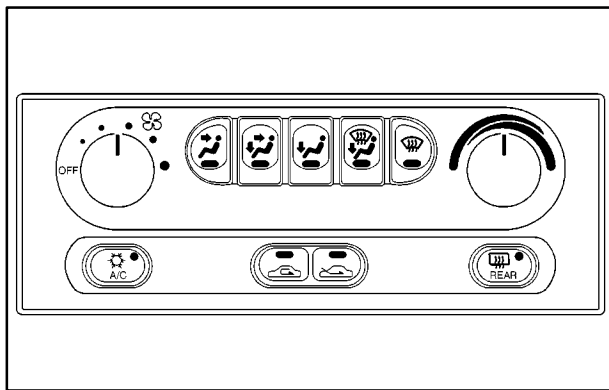

With this system, you can control the heating, cooling and ventilation in your vehicle. The system works best if you keep your windows closed while using it.

#### Fan Knob

The left knob regulates the amount of air coming into the vehicle. To turn the fan off, turn the knob to OFF. The fan must be on to run the air conditioning compressor.

If the airflow seems very low when the fan knob is turned to the highest setting, regardless of the mode setting, your passenger compartment air filter (if equipped) may need to be replaced. See “Maintenance Schedule” and “Passenger Compartment Air Filter” in the Index.

#### Temperature Knob

The right knob changes the temperature of the air coming through the system. Turn this knob clockwise (toward red) for warmer air. Turn it counterclockwise (toward blue) for cooler air.

#### Mode Push Buttons

The upper row of push buttons control the direction of airflow. Each button has an indicator which will glow when the button is pressed.





**UPPER:** This setting directs air through the instrument panel outlets.



**BI-LEVEL:** This setting directs air two ways. Half of the air is directed through the instrument panel outlets. Most of the remaining air is directed through the floor ducts and a little to the defrost and side window vents.

 **LOWER:** This setting sends most of the air through the ducts near the floor. The rest comes out of the defroster and side window vents. When using this setting in the recirculation mode, the windows may fog up. See “Recirculation” in the Index for more information.

 **DEFOG:** This setting allows half of the air to go to the floor ducts and half to the defrost and side window vents. The air conditioning compressor will run automatically in this setting unless the outside temperature is below 38°F (3.3°C). (Even when the compressor is running, you can control the temperature.)

 **DEFROST:** This setting directs most of the air through the defrost and side window vents. Some of the air goes to the floor ducts. The air conditioning compressor will run automatically in this setting unless the outside temperature is below 38°F (3.3°C). (Even when the compressor is running, you can control the temperature.)

## Air Conditioning Compressor Button

Press the A/C button in to operate the air conditioning compressor. The indicator light on the button will flash briefly and stay on solid to let you know your air conditioning will come on. If the light on the A/C button turns off after the flashing has stopped your air conditioning will not come on. Your air conditioning will not come on for two reasons:

- The outside temperature is below 38°F (3.3°C).
- The refrigerant pressure is too low or too high. If the outside temperature is above 38°F (3.3°C). See “Air Conditioning Refrigerants” in the Index.

## Recirc Button

 : This button is used to recirculate much of the air inside your vehicle. This setting is not available in DEFOG or DEFROST. Operating the system in the RECIRC may cause the windows to fog up when the weather is cold and damp. To clear the fog, use the DEFOG or DEFROST modes and increase the fan speed. To avoid refogging of the windows, use the OUTSIDE AIR mode.

## Outside Air Button

 : This button is used to bring in outside air.

## Air Conditioning

On very hot days, open the windows long enough to let hot inside air escape. This reduces the time the compressor has to run, which should help fuel economy.

For quick cool-down on very hot days, use RECIRC with the temperature knob turned all the way to the blue area and the A/C button pushed. If this setting is used for long periods of time, the air in your vehicle may become too dry.

For normal cooling on hot days, use UPPER with the temperature knob turned to the blue area. With the A/C button and the outside air button pushed in, the system will bring in outside air and cool it.

On cool but sunny days, the sun may warm your upper body, but your lower body may not be warm enough. To remedy this, you can use BI-LEVEL with the temperature knob in the middle with the A/C button and the outside air button pushed in. The system will bring in outside air and direct it to your upper body, while sending slightly warmed air to your lower body. You may notice the temperature difference more at some times than others.

## Heating

On cold days use FLOOR and the outside air button pushed in with the temperature knob turned all the way to the red area. The system will bring in outside air, heat it and send it to the floor ducts.

If your vehicle has an engine coolant heater, you can use it to help your system provide warm air faster when it's cold outside (0°F (-18°C) or lower). An engine coolant heater warms the coolant your engine and heating system use to provide heat. See “Engine Coolant Heater” in the Index.

## Ventilation

For mild outside temperatures when little heating or cooling is needed, use UPPER and the outside air button to direct air through your vehicle. Your vehicle also has the flow-through ventilation system described later in this section.

## Defogging and Defrosting

Your system has two settings for clearing the front and side windows. To defrost the windows quickly, use DEFROST with the temperature knob turned all the way to the red area. To warm passengers while keeping the windows clear, use DEFOG.

## **Air Conditioning with Automatic and Auxiliary Temperature Control (If Equipped)**



With this system, you can control the temperature inside your vehicle. The temperature and fan speed can be adjusted manually or you can let the system make the adjustments for you. The system works best if you keep your windows closed while using it.

### **Driver Temperature Knob**

The DRIVER knob regulates the temperature for the entire system when the PASS knob is in the center or neutral position. Turn the DRIVER knob clockwise (toward red) to raise the temperature.

Turn it counterclockwise (toward blue) to lower the temperature. The display will show your selection for a few seconds, then it will show the outside temperature.

If you push the knob the set temperature will again be displayed for a few seconds, then the outside temperature will be displayed.

### **Passenger Temperature Knob**



The PASS knob adjusts the air temperature on the passenger's side so it is warmer or cooler than the temperature set by the driver.

Turn the PASS knob clockwise (toward red) to raise the temperature. Turn it counterclockwise (toward blue) to lower the temperature. The passenger temperature will not be shown in the display.

## Auto Button

For the most efficient operation you should press the AUTO button and set the system temperature. The system will select the best fan speed and airflow settings to keep you comfortable. The air conditioning compressor will run if the outside temperature is above 38°F (3.3°C). You may notice a delay of three to four minutes before the fan comes on. For the automatic system to function, the temperature must be set between 61°F (16°C) and 89°F (31°C).

**Hot Weather Example:** When you start the vehicle in hot weather, 80°F (27°C) or after being parked during the day in full sun, if your Driver Set Temperature is 73°F (23°C) and you are in full automatic mode, the system will automatically move the temperature doors to full cold. The fan will be at low speed momentarily and then go to high speed. The air intake will be recirculated for maximum cooling performance. As the interior of the vehicle cools down to the desired comfort point, the fan speed will decrease and the temperature door will move to a warmer position to maintain the desired comfort level. As the cabin cools down or the sun load decreases, the system could switch to air delivered to A/C vents and the floor (Bi-level mode).

**Cold Weather Example:** When you start the vehicle in cold weather, (below freezing), or after being parked overnight, if your Driver Set Temperature is 73°F (23°C) and you are in full automatic mode, the system will automatically move the temperature doors to full hot. The fan will start out at a low speed and the fan speed will increase as the engine warms up. The air will be delivered to the floor. As the interior of the vehicle warms up to the desired comfort level, the fan speed will decrease and the temperature door will move to a cooler position to maintain the desired comfort level. As the cabin warms up or the sun load increases, the system could switch to air delivered to the windshield and the floor (DEFOG mode).

## Off Button

Push the OFF button to turn the system off. The display will show OFF and outside temperature.

## Manual Control of the Automatic System

If you prefer to manually control the heating, cooling and ventilation in your vehicle, set the system to the temperature and fan speed you want. Next, push the mode button to select your desired airflow direction. The system will try to maintain the temperature you set using the mode you select. The following suggestions will help the system run more efficiently in manual mode.

### Fan Button



The button below the display is used to manually select the force of air you want. The display will show the fan speed. Fan control is no longer automatic, but the system remains in auto temperature control.

If the airflow seems very low when the fan knob is turned to the highest setting regardless of the mode setting, your passenger compartment air filter (if equipped) may need to be replaced. See “Maintenance Schedule” in the Index.

### Econ Button

Press the ECON button to turn the compressor on and off. The indicator light is illuminated when the compressor is off. AUTO will not be illuminated, but the system will maintain automatic air delivery and fan speed control. The system will attempt to control the temperature without the help of the compressor.

## Mode Button

The MODE button is used to control the direction of airflow when the system is not in AUTO. The first press will display the current airflow direction. Repeated pressing will cycle through the following air flow directions shown in the display.



**UPPER:** This setting directs air through the instrument panel outlets.



**BI-LEV:** This setting directs air two ways. Half of the air is directed through the instrument panel outlets. Most of the remaining air is directed through the floor ducts and a little to the defrost and side window vents.





**LOWER:** This setting sends most of the air through the ducts near the floor. The rest comes out of the defrost and side window vents. When using this mode and RECIRC, the windows may fog up when the weather is cold and damp. See “Recirculation” in the Index for more information.



**DEFOG:** This setting allows half of the air to go to the floor ducts and half to the defrost and side window vents. The air conditioning compressor will run automatically in this setting unless the outside temperature is below 38°F (3.3°C). (Even when the compressor is running, you can control the temperature).

 **DEFROST:** This setting directs most of the air through the defrost and side window vents. Some of the air goes to the floor ducts. The air conditioning compressor will run automatically in this setting unless the outside temperature is below 38°F (3.3°C). (Even when the compressor is running, you can control the temperature).

 **RECIRC:** This setting recirculates the air inside of your vehicle. This setting is not available in defog or defrost mode. When operating the system in the RECIRC mode, the windows may fog up when the weather is cold and damp. To clear the fog, select either the DEFOG or DEFROST mode and increase the fan speed. To avoid re-fogging of the windows, use the OUTSIDE AIR mode.

 **OUTSIDE AIR:** This setting brings in outside air.

### Air Conditioning

On very hot days, open the windows long enough to let hot, inside air escape. This reduces the time the compressor has to run, which should help fuel economy.

For quick cool-down on very hot days, use UPPER and RECIRC. If this setting is used for long periods of time, the air in your vehicle may become too dry.

For normal cooling on hot days, use UPPER and OUTSIDE AIR with the compressor on. The system will bring in outside air and cool it.

On cool but sunny days, the sun may warm your upper body, but your lower body may not be warm enough. To remedy this, you can use BI-LEV with the compressor on. The system will bring in outside air and direct it to your upper body, while sending slightly warmed air to your lower body. You may notice this temperature difference more at some times than others.

### Heating

On cold days use LOWER. The system will bring in outside air, heat it and send it to the floor ducts.

If your vehicle has an engine coolant heater, you can use it to help your system provide warm air faster when it's cold outside (0°F (-18°C) or lower). An engine coolant heater warms the coolant your engine and heating system use to provide heat. See “Engine Coolant Heater” in the Index.



## Ventilation

For mild outside temperatures when little heating or cooling is needed, use UPPER, ECON and OUTSIDE AIR to direct outside air through your vehicle. Your vehicle also has the flow-through ventilation system described later in this section.

## Defogging and Defrosting

Your system has two settings for clearing the front and side windows. To defrost the windows quickly, use your DEFROST button. To warm passengers while keeping the windows clean, use DEFOG by pressing the MODE button.

## Rear Window Defogger



The rear window defogger uses a warming grid to remove fog from the rear window. Press the button to turn the defogger on. It will turn itself off after about 15 minutes (automatic control) or 10 minutes (manual control).

If you turn it on again, the defogger will only run for about seven and one-half minutes (automatic control) or five minutes (manual control) before turning off. You can also turn it off by turning off the ignition or pressing the button again.

Do not attach anything like a temporary vehicle license or decal across the defogger grid.

### NOTICE:

**Don't use a razor blade or something else sharp on the inside of the rear window. If you do, you could cut or damage the warming grid, and the repairs wouldn't be covered by your warranty.**

## Ventilation System



Adjust the direction of airflow by moving the vents. To completely shut off airflow to the outlet move the thumbwheel down. To open the outlet for airflow move the thumbwheel up.

Your vehicle's flow-through ventilation system supplies outside air into the vehicle when it is moving. Outside air will also enter the vehicle when the air conditioning fan is running.

## Ventilation Tips

- Keep the hood and front air inlet free of ice, snow or any other obstruction, such as leaves. The heater and defroster will work far better, reducing the chance of fogging the inside of your windows.
- When you enter a vehicle in cold weather, set the mode to FLOOR or LOWER and the fan to the highest speed for a few moments before driving off. This helps clear the intake ducts of snow and moisture and reduces the chance of fogging the inside of your windows.
- Keep the air path under the front seats clear of objects. This helps air to circulate throughout your vehicle.

## Audio Systems

Your audio system has been designed to operate easily and give years of listening pleasure. You will get the most enjoyment out of it if you acquaint yourself with it first. Find out what your audio system can do and how to operate all its controls, to be sure you're getting the most out of the advanced engineering that went into it.

### Setting the Clock

Press and hold HR until the correct hour appears. The letter A or P may appear on the display for AM or PM. Then, press and hold MN until the correct minute appears. The clock may be set with the ignition on or off.

## AM-FM Stereo with Cassette Tape Player and Automatic Tone Control



### Playing the Radio

**PWR VOL:** Press this knob to turn the system on and off. To increase volume, turn the knob clockwise. Turn it counterclockwise to decrease volume.

**RCL:** Press this button briefly to recall the station being played or to display the clock. To change what is normally shown on the display (station or time), press the RCL button until you see the display you want, then hold the RCL button until the display flashes. If you press the button when the ignition is off, the clock will show for a few seconds.

### Finding a Station

**AM FM:** Press this button to switch between AM, FM1 and FM2. The display shows your selection.

**TUNE:** Press this knob lightly so it extends. Turn it to choose radio stations. Push the knob back into its stored position when you're not using it.

**SEEK:** Press the up or down arrow to go to the next higher or lower station and stay there. The sound will mute while seeking.

**SCAN:** Press this button and release it to listen to stations for a few seconds. The radio will go to a station, stop for a few seconds, then go on to the next station. Press the button again to stop scanning. The sound will mute while scanning, and SCAN will appear on the display. If you press SCAN for more than two seconds, the radio will change to P SCAN mode. P SCAN will appear on the display.

**PUSHBUTTONS:** The five numbered pushbuttons let you return to your favorite stations. You can set up to 15 stations (five AM, five FM1 and five FM2). Just do the following:

1. Turn the radio on.
2. Press AM FM to select the band.
3. Tune in the desired station.
4. Press TONE to select the equalization that best suits the type of station selected.
5. Press and hold one of the five numbered buttons. The sound will mute. When it returns, release the button. Whenever you press that numbered button, the station you set will return and the tone that you selected will also be automatically selected for that button.
6. Repeat the steps for each pushbutton.

**P SCAN:** Press SCAN for more than two seconds, and P SCAN will appear on the display. The radio will go to the first preset station stored on your pushbuttons, stop for a few seconds, then go on to the next preset station. Press SCAN again to stop scanning.

## Setting the Tone

**BASS:** Press this knob lightly so it extends. Turn the knob to increase or decrease bass. When you use this control, the radio's tone setting will switch to manual.

**TREB:** Press this knob lightly so it extends. Then pull the knob all the way out. Turn the knob to increase or decrease treble. When you use this control, the radio's tone setting will switch to manual. If a station is weak or noisy, you may want to decrease the treble.

Push the knob back into its stored position when you're not using it.

**TONE:** This feature allows you to choose preset bass and treble equalization settings designed for jazz, vocal, pop, rock and classical stations. JAZZ will appear on the display when you first press TONE. Each time you press it, another setting will appear on the display. Press it again after CLASSIC appears and MANUAL will appear. Manual tone control will return to the BASS and TREB knobs. Also, if you use the BASS and TREB knobs, control will return to them and MANUAL will appear.

## Adjusting the Speakers

**BAL:** Press this knob lightly so it extends. Turn the knob to move the sound to the left or right speakers. The middle position balances the sound between the speakers.

**FADE:** Press the knob lightly so it extends. Then pull the knob all the way out. Turn it to move the sound to the front or rear speakers. The middle position balances the sound between the speakers.

Push the knob back into its stored position when you're not using it.

## Playing a Cassette Tape

Your tape player is built to work best with tapes that are up to 30 to 45 minutes long on each side. Tapes longer than that are so thin they may not work well in this player.

The longer side with the tape visible should face to the right. If the ignition is on, but the radio is off, the tape can be inserted and will begin playing. If you hear nothing but a garbled sound, the tape may not be in squarely. Press EJECT to remove the tape and start over.

While the tape is playing, use the VOL, FADE, BAL, TREB, BASS, TONE, SEEK and SCAN controls just as you do for the radio. Other controls may have different functions when a tape is inserted. The display will show TP with a box around it and an arrow to show which side of the tape is playing.

Your tape bias is set automatically. When a metal or chrome tape is inserted, HI-BIAS appears on the display. If you want to insert a tape when the ignition is off, first press EJECT or RCL.

If E and a number appear on the radio display, the tape won't play because of an error.

- **E10:** The tape is tight and the player can't turn the tape hubs. Remove the tape. Hold the tape with the open end down and try to turn the right hub counterclockwise with a pencil. Turn the tape over and repeat. If the hubs do not turn easily, your tape may be damaged and should not be used in the player. Try a new tape to make sure your player is working properly.
- **E11:** The tape is broken. Try a new tape.

If any error occurs repeatedly or if an error can't be corrected, please contact your dealer. If your radio displays an error number, write it down and provide it to your dealer when reporting the problem.

**REV (1):** Press this button to reverse the tape rapidly. Press it again to return to playing speed. The radio will play the last selected station while the tape reverses. You may select stations during REV operation by using TUNE.

**FWD (2):** Press this button to advance quickly to another part of the tape. Press the button again to return to playing speed. The radio will play the last selected station while the tape advances. You may select stations during FWD operation by using TUNE.

**PROG (3):** Press this button to play the other side of the tape.

**DD (4):** Press this button to reduce background noise. The double-D symbol will appear on the display.

Dolby Noise Reduction is manufactured under a license from Dolby Laboratories Licensing Corporation. Dolby and the double-D symbol are trademarks of Dolby Laboratories Licensing Corporation.

**TONE:** Press this button to select a tone while playing a cassette. The tone that you set will be activated each time you play a cassette tape.

**SEEK:** Press the up or down arrow to search for the next or previous selection on the tape. Your tape must have at least three seconds of silence between each selection for SEEK to work.

**SCAN:** Press this button to listen to each selection for a few seconds. The tape will go to the next selection, stop for a few seconds, then go on to the next selection. Press this button again to stop scanning. The sound will mute, SCAN will appear on the display and the tape direction arrow will blink while scanning.

**AM FM:** Press this button to play the radio when a tape is in the player. The tape will stop but remain in the player.

**TAPE AUX:** If you have a tape inserted and the radio is playing, press TAPE AUX to play your tape. To return to the radio while a tape is playing, press AM FM. The inactive tape will remain safely inside the radio for future listening.

**EJECT:** Press this button to remove the tape. The radio will play. EJECT may be activated with either the ignition or radio off. Cassettes may be loaded with the radio and ignition off if this button is pressed first.

**CLN:** If this message appears on the display, the cassette tape player needs to be cleaned. It will still play tapes, but you should clean it as soon as possible to prevent damage to the tapes and player. See “Care of Your Cassette Tape Player” in the Index. After you clean the player, press and hold EJECT for five seconds to reset the CLN indicator. The radio will display --- to show the indicator was reset.

## AM-FM Stereo with Cassette Tape and Compact Disc Player with Automatic Tone Control (If Equipped)



If your vehicle is equipped with the Bose® AM FM Stereo with Cassette Tape and Compact Disc Player (not shown), automatic tone control is not available. Your radio will have a MUTE button rather than a TONE button.

## Playing the Radio

**PWR VOL:** Press this knob to turn the system on and off. To increase volume, turn the knob clockwise. Turn it counterclockwise to decrease volume.

**RCL:** Press this button briefly to recall the station being played or to display the clock. To change what is normally shown on the display (station or time), press the RCL button until you see the display you want, then hold the RCL button until the display flashes. If you press the button when the ignition is off, the clock will show for a few seconds.

**MUTE:** Press this button to silence the system. Press it again to turn on the sound. (This button is available on the Bose® radio only.)

## Finding a Station

**AM FM:** Press this button to switch between AM, FM1 and FM2. The display shows your selection.

**TUNE:** Press this knob lightly so it extends. Turn it to choose radio stations. Push the knob back into its stored position when you're not using it.

**SEEK:** Press the up or down arrow to go to the next higher or lower station and stay there. The sound will mute while seeking.

**SCAN:** Press this button and release it to listen to stations for a few seconds. The radio will go to a station, stop for a few seconds, then go on to the next station. Press the button again to stop scanning. The sound will mute while scanning, and SCAN will appear on the display. If you press SCAN for more than two seconds, the radio will change to P SCAN mode. P SCAN will appear on the display.

**PUSHBUTTONS:** The five numbered pushbuttons let you return to your favorite stations. You can set up to 15 stations (five AM, five FM1 and five FM2). Just do the following:

1. Turn the radio on.
2. Press AM FM to select the band.
3. Tune in the desired station.
4. Press TONE to select the equalization that best suits the type of station selected. (This function is not available on the Bose radio.)
5. Press and hold one of the five numbered buttons. The sound will mute. When it returns, release the button. Whenever you press that numbered button, the station you set will return and the tone that you selected will also be automatically selected for that button. (The tone will not automatically return on the Bose radio.)
6. Repeat the steps for each pushbutton.



**P SCAN:** Press SCAN for more than two seconds, and P SCAN will appear on the display. The radio will go to the first preset station stored on your pushbuttons, stop for a few seconds, then go on to the next preset station. Press SCAN again to stop scanning.

### Setting the Tone

**BASS:** Press this knob lightly so it extends. Turn the knob to increase or decrease bass. When you use this control, the radio's tone setting will switch to manual. (The radio's tone setting will not switch to manual on the Bose radio.)

**TREB:** Press this knob lightly so it extends. Then pull the knob all the way out. Turn the knob to increase or decrease treble. When you use this control, the radio's tone setting will switch to manual. (The radio's tone setting will not switch to manual on the Bose radio.) If a station is weak or noisy, you may want to decrease the treble.

Push the knob back into its stored position when you're not using it.

**TONE:** This feature allows you to choose preset bass and treble equalization settings designed for jazz, vocal, pop, rock and classical stations. JAZZ will appear on the display when you first press TONE. Each time you press it, another setting will appear on the display. Press it again after CLASSIC appears and MANUAL will appear. Tone control will return to the BASS and TREB knobs. Also, if you use the BASS and TREB knobs, control will return to them and MANUAL will appear. (This button is not available on the Bose radio.)

### Adjusting the Speakers

**BAL:** Press this knob lightly so it extends. Turn the knob to move the sound to the left or right speakers. The middle position balances the sound between the speakers.

**FADE:** Press the knob lightly so it extends. Then pull the knob all the way out. Turn it to move the sound to the front or rear speakers. The middle position balances the sound between the speakers.

Push the knob back into its stored position when you're not using it.

## Playing a Cassette Tape

Your tape player is built to work best with tapes that are up to 30 to 45 minutes long on each side. Tapes longer than that are so thin they may not work well in this player.

The longer side with the tape visible should face to the right. If the ignition is on, but the radio is off, the tape can be inserted and will begin playing. If you hear nothing but a garbled sound, the tape may not be in squarely. Press EJECT to remove the tape and start over.

While the tape is playing, use the VOL, FADE, BAL, TREB, BASS, TONE, SEEK and SCAN controls just as you do for the radio. (The TONE control is not available on the Bose radio.) Other controls may have different functions when a tape is inserted. The display will show TP with a box around it and an arrow to show which side of the tape is playing.

Your tape bias is set automatically. When a metal or chrome tape is inserted, HI-BIAS appears on the display. If you want to insert a tape when the ignition is off, first press EJECT or RCL.

If E and a number appear on the radio display and the tape won't play because of an error, it could be one of the following:

- **E10:** The tape is tight and the player can't turn the tape hubs. Remove the tape. Hold the tape with the open end down and try to turn the right hub counterclockwise with a pencil. Turn the tape over and repeat. If the hubs do not turn easily, your tape may be damaged and should not be used in the player. Try a new tape to make sure your player is working properly.

- **E11:** The tape is broken. Try a new tape.

If any error occurs repeatedly or if an error can't be corrected, please contact your dealer. If your radio displays an error number, write it down and provide it to your dealer when reporting the problem.

**REV (1):** Press this button to reverse the tape rapidly. Press it again to return to playing speed. The radio will play the last selected station while the tape reverses. You may select stations during REV operation by using TUNE.

**FWD (2):** Press this button to advance quickly to another part of the tape. Press the button again to return to playing speed. The radio will play the last selected station while the tape advances. You may select stations during FWD operation by using TUNE.

**PROG (3):** Press this button to play the other side of the tape.

**DD (4):** Press this button to reduce background noise. The double-D symbol will appear on the display.

Dolby Noise Reduction is manufactured under a license from Dolby Laboratories Licensing Corporation. Dolby and the double-D symbol are trademarks of Dolby Laboratories Licensing Corporation.

**TONE:** Press this button to select a tone while playing a cassette. The tone that you set will be activated each time you play a cassette tape. (This button is not available on the Bose radio.)

**SEEK:** Press the up or down arrow to search for the next or previous selection on the tape. Your tape must have at least three seconds of silence between each selection for SEEK to work.

**SCAN:** Press this button to listen to each selection for a few seconds. The tape will go to the next selection, stop for a few seconds, then go on to the next selection. Press this button again to stop scanning. The sound will mute while scanning, SCAN will appear on the display and the tape direction arrow will blink while scanning.

**AM FM:** Press this button to play the radio when a tape is in the player. The tape will stop but remain in the player.

**TAPE CD:** Press this button if you have a disc loaded in the CD player and the radio is playing, to play a compact disc. Press AM FM to return to the radio when a compact disc is playing. Press TAPE CD to switch between the tape and compact disc if both are loaded. The inactive tape or CD will remain safely inside the radio for future listening. The display will show TP and CD.

**EJECT:** Press this button to remove the tape. The radio will play. EJECT may be activated with either the ignition or radio off. Cassettes may be loaded with the radio and ignition off if this button is pressed first.

**CLN:** If this message appears on the display, the cassette tape player needs to be cleaned. It will still play tapes, but you should clean it as soon as possible to prevent damage to the tapes and player. See “Care of Your Cassette Tape Player” in the Index. After you clean the player, press and hold EJECT for five seconds to reset the CLN indicator. The radio will display --- to show the indicator was reset.

### Playing a Compact Disc

With the ignition on, insert a disc partway into the slot, label side up. The player will pull it in and the disc should begin playing. If you want to insert a CD when the ignition is off, first press EJECT or RCL.

The CD player will play either normal-size discs or the smaller 8 cm discs with an adapter.

When the disc is inserted, CD will be displayed. When the disc is playing, a box will appear around CD on the display. If you select a tone setting for your CD, it will be activated each time you play a CD. (The tone setting function is not available on the Bose radio.)

As each new track starts to play, the track number will appear in the display.

If E (error) and a number appear on the radio display and the disc comes out, it could be one of the following:

- **E20:** The road is too rough. The disc should play when the road is smoother.
- **E20:** The disc is dirty, scratched, wet or upside down.
- **E20:** The air is very humid. If so, wait about an hour and try again.

If any error occurs repeatedly or if an error can't be corrected, please contact your dealer. If your radio displays an error number, write it down and provide it to your dealer when reporting the problem.

**REV (1):** Press and hold this button to quickly reverse within a track. You will hear sound at a reduced volume. The display will show elapsed time.

**FWD (2):** Press and hold this button to quickly advance within a track. You will hear sound at a reduced volume. The display will show elapsed time.

**RDM (5):** Press this button to hear the tracks in random, rather than sequential, order. RDM will appear on the display when you press this button.

**TONE:** Press this button to select a tone while playing a compact disc. The tone that you set will be activated each time you play a compact disc. (This button is not available on the Bose radio.)

**SEEK:** Press the down arrow to go to the start of the current track if more than eight seconds have played. Press the up arrow to go to the next track. If you hold the button or press it more than once, the player will continue moving rearward or forward through the disc.

**SCAN:** Press this button to listen to each selection for a few seconds. The disc will go to the next selection, stop for a few seconds, then go on to the next selection. Press this button again to stop scanning. The sound will mute while scanning, SCAN will appear on the display.

**RCL:** Press this button to see which track is playing. Press it again within five seconds to see how long it has been playing. To change what is normally shown on the display (track or elapsed time), press the button until you see the display you want, then hold the button until the display flashes. While elapsed time is showing, EL TM will appear on the display.

**AM FM:** Press this button to play the radio when a disc is in the player.

**TAPE CD:** Press this button to change to the tape or disc function when the radio is on and either a tape or CD is inserted. Press AM FM to return to the radio while a CD or tape is playing. The inactive tape or CD will remain safely inside the radio for future listening.

**EJECT:** Press this button to remove the compact disc or cassette tape. The icon with the box around it on the display will eject and the radio will play. EJECT may be activated with either the ignition or radio off. Cassettes and compact discs may be loaded with the radio and ignition off if this button is pressed first.

## Theft-Deterrent Feature

THEFTLOCK<sup>®</sup> is designed to discourage theft of your radio. It works by using a secret code to disable all radio functions whenever battery power is removed.

The THEFTLOCK feature for the radio may be used or ignored. If ignored, the system plays normally and the radio is not protected by the feature. If THEFTLOCK is activated, your radio will not operate if stolen.

When THEFTLOCK is activated, the radio will display LOC to indicate a locked condition anytime battery power is removed. If your battery loses power for any reason, you must unlock the radio with the secret code before it will operate.

### Activating the Theft-Deterrent Feature

The instructions which follow explain how to enter your secret code to activate the THEFTLOCK system. It is recommended that you read through all nine steps before starting the procedure.

If you allow more than 15 seconds to elapse between any steps, the radio automatically reverts to time and you must start the procedure over at Step 4.

1. Write down any three or four-digit number from 000 to 1999 and keep it in a safe place separate from the vehicle.
2. Turn the ignition to ACC or ON.
3. Turn the radio off.
4. Press the 1 and 4 buttons together. Hold them down until --- shows on the display. Next you will use the secret code number which you have written down.
5. Press MN and 000 will appear on the display.
6. Press MN again to make the last two digits agree with your code.
7. Press HR to make the first one or two digits agree with your code.
8. Press AM FM after you have confirmed that the code matches the secret code you have written down. The display will show REP to let you know that you need to repeat Steps 5 through 7 to confirm your secret code.
9. Press AM FM and this time the display will show SEC to let you know that your radio is secure.

## Unlocking the Theft-Deterrent Feature After a Power Loss

Enter your secret code as follows; pause no more than 15 seconds between steps:

1. Turn the ignition on. LOC will appear on the display.
2. Press MN and 000 will appear on the display.
3. Press MN again to make the last two digits agree with your code.
4. Press HR to make the first one or two digits agree with your code.
5. Press AM FM after you have confirmed that the code matches the secret code you have written down. The display will show SEC, indicating the radio is now operable and secure.

If you enter the wrong code eight times, INOP will appear on the display. You will have to wait an hour with the ignition on before you can try again. When you try again, you will only have three chances to enter the correct code before INOP appears.

If you lose or forget your code, contact your dealer.

## Disabling the Theft-Deterrent Feature

Enter your secret code as follows; pause no more than 15 seconds between steps:

1. Turn the ignition to ACC or ON.
2. Turn the radio off.
3. Press the 1 and 4 buttons together. Hold them down until SEC shows on the display.
4. Press MN and 000 will appear on the display.
5. Press MN again to make the last two digits agree with your code.
6. Press HR to make the first one or two digits agree with your code.
7. Press AM FM after you have confirmed that the code matches the secret code you have written down. The display will show ---, indicating that the radio is no longer secured.

If the code entered is incorrect, SEC will appear on the display. The radio will remain secured until the correct code is entered.

When battery power is removed and later applied to a secured radio, the radio won't turn on and LOC will appear on the display.

To unlock a secured radio, see "Unlocking the Theft-Deterrent Feature After a Power Loss" earlier in this section.

## Audio Steering Wheel Controls (If Equipped)



If your vehicle has this feature, you can control certain radio functions using the buttons on your steering wheel.

**VOL:** Press the up or down arrow to increase or decrease volume.

**SEEK:** Press this button to tune to a higher radio station. When playing a cassette tape or compact disc, press SEEK to hear the next selection. There must be at least a three-second gap between selections on a cassette tape.

**PROG:** Press this button to tune in a higher preset radio station. When playing a cassette tape, press PROG to hear the other side of a tape that is playing. When playing a CD, this button will seek to the next selection.

## Understanding Radio Reception

### AM

The range for most AM stations is greater than for FM, especially at night. The longer range, however, can cause stations to interfere with each other. AM can pick up noise from things like storms and power lines. Try reducing the treble to reduce this noise if you ever get it.

### FM Stereo

FM stereo will give you the best sound, but FM signals will reach only about 10 to 40 miles (16 to 65 km). Tall buildings or hills can interfere with FM signals, causing the sound to come and go.

## Tips About Your Audio System

Hearing damage from loud noise is almost undetectable until it is too late. Your hearing can adapt to higher volumes of sound. Sound that seems normal can be loud and harmful to your hearing. Take precautions by adjusting the volume control on your radio to a safe sound level before your hearing adapts to it.



To help avoid hearing loss or damage:

- Adjust the volume control to the lowest setting.
- Increase volume slowly until you hear comfortably and clearly.

## **NOTICE:**

**Before you add any sound equipment to your vehicle -- like a tape player, CB radio, mobile telephone or two-way radio -- be sure you can add what you want. If you can, it's very important to do it properly. Added sound equipment may interfere with the operation of your vehicle's engine, Delphi Delco Electronics radio or other systems, and even damage them. Your vehicle's systems may interfere with the operation of sound equipment that has been added improperly.**

**So, before adding sound equipment, check with your dealer and be sure to check Federal rules covering mobile radio and telephone units.**

## **Care of Your Cassette Tape Player**

A tape player that is not cleaned regularly can cause reduced sound quality, ruined cassettes or a damaged mechanism. Cassette tapes should be stored in their cases away from contaminants, direct sunlight and extreme heat. If they aren't, they may not operate properly or may cause failure of the tape player.

Your tape player should be cleaned regularly after every 50 hours of use. Your radio may display CLN to indicate that you have used your tape player for 50 hours without resetting the tape clean timer. If this message appears on the display, your cassette tape player needs to be cleaned. It will still play tapes, but you should clean it as soon as possible to prevent damage to your tapes and player. If you notice a reduction in sound quality, try a known good cassette to see if it is the tape or the tape player at fault. If this other cassette has no improvement in sound quality, clean the tape player.

The recommended cleaning method for your cassette tape player is the use of a scrubbing action, non-abrasive cleaning cassette with pads which scrub the tape head as the hubs of the cleaner cassette turn. The recommended cleaning cassette is available through your dealer (GM Part No. 12344789).

When using a scrubbing action, non-abrasive cleaning cassette, it is normal for the cassette to eject because your unit is equipped with a broken tape detection feature and a cleaning cassette may appear as a broken tape. If the cleaning cassette ejects, insert the cassette at least three times to ensure thorough cleaning.

You may also choose a non-scrubbing action, wet-type cleaner which uses a cassette with a fabric belt to clean the tape head. This type of cleaning cassette will not eject on its own. A non-scrubbing action cleaner may not clean as thoroughly as the scrubbing type cleaner. The use of a non-scrubbing action, dry-type cleaning cassette is not recommended.

After you clean the player, press and hold EJECT for five seconds to reset the CLN indicator. The radio will display --- to show the indicator was reset.

Cassettes are subject to wear and the sound quality may degrade over time. Always make sure the cassette tape is in good condition before you have your tape player serviced.

## Care of Your Compact Discs

Handle discs carefully. Store them in their original cases or other protective cases and away from direct sunlight and dust. If the surface of a disc is soiled, dampen a clean, soft cloth in a mild, neutral detergent solution and clean it, wiping from the center to the edge.

Be sure never to touch the signal surface when handling discs. Pick up discs by grasping the outer edges or the edge of the hole and the outer edge.

## Care of Your Compact Disc Player

The use of CD lens cleaner discs is not advised, due to the risk of contaminating the lens of the CD optics with lubricants internal to the CD mechanism.

## Backglass Antenna

Your AM FM antenna is integrated with your rear window defogger, located in the rear window. Be sure that the inside surface of the rear window is not scratched and that the lines on the glass are not damaged. If the inside surface is damaged, it could interfere with radio reception.

### **NOTICE:**

**Do not try to clear frost or other material from the inside of the rear window with a razor blade or anything else that is sharp. This may damage the rear defogger grid and affect your radio's ability to pick up stations clearly. The repairs wouldn't be covered by your warranty.**

Because this antenna is built into your rear window, there is a reduced risk of damage caused by car washes and vandals.

If you choose to add a cellular telephone to your vehicle, and the antenna needs to be attached to the glass, be sure that you do not damage the grid lines for the AM FM antenna. There is enough space between the lines to attach a cellular telephone antenna without interfering with radio reception.



## Section 4 Your Driving and the Road

---

Here you'll find information about driving on different kinds of roads and in varying weather conditions. We've also included many other useful tips on driving.

4-2	Defensive Driving	4-19	Driving in Rain and on Wet Roads
4-3	Drunken Driving	4-22	City Driving
4-6	Control of a Vehicle	4-23	Freeway Driving
4-6	Braking	4-24	Before Leaving on a Long Trip
4-9	Traction Control System (Option)	4-25	Highway Hypnosis
4-12	Steering	4-25	Hill and Mountain Roads
4-14	Off-Road Recovery	4-27	Winter Driving
4-14	Passing	4-31	Recreational Vehicle Towing
4-16	Loss of Control	4-31	Loading Your Vehicle
4-17	Driving at Night	4-33	Towing a Trailer



## Defensive Driving

The best advice anyone can give about driving is:  
Drive defensively.

Please start with a very important safety device in your vehicle: Buckle up. See “Safety Belts” in the Index.

Defensive driving really means “be ready for anything.” On city streets, rural roads or freeways, it means “always expect the unexpected.”

Assume that pedestrians or other drivers are going to be careless and make mistakes. Anticipate what they might do. Be ready for their mistakes.

Rear-end collisions are about the most preventable of accidents. Yet they are common. Allow enough following distance. It’s the best defensive driving maneuver, in both city and rural driving. You never know when the vehicle in front of you is going to brake or turn suddenly.

Defensive driving requires that a driver concentrate on the driving task. Anything that distracts from the driving task -- such as concentrating on a cellular telephone call, reading, or reaching for something on the floor -- makes proper defensive driving more difficult and can even cause a collision, with resulting injury. Ask a passenger to help do things like this, or pull off the road in a safe place to do them yourself. These simple defensive driving techniques could save your life.

## Drunken Driving

Death and injury associated with drinking and driving is a national tragedy. It's the number one contributor to the highway death toll, claiming thousands of victims every year.

Alcohol affects four things that anyone needs to drive a vehicle:

- Judgment
- Muscular Coordination
- Vision
- Attentiveness.

Police records show that almost half of all motor vehicle-related deaths involve alcohol. In most cases, these deaths are the result of someone who was drinking and driving. In recent years, about 16,000 annual motor vehicle-related deaths have been associated with the use of alcohol, with more than 300,000 people injured.

Many adults -- by some estimates, nearly half the adult population -- choose never to drink alcohol, so they never drive after drinking. For persons under 21, it's against the law in every U.S. state to drink alcohol. There are good medical, psychological and developmental reasons for these laws.

The obvious way to solve the leading highway safety problem is for people never to drink alcohol and then drive. But what if people do? How much is "too much" if the driver plans to drive? It's a lot less than many might think. Although it depends on each person and situation, here is some general information on the problem.

The Blood Alcohol Concentration (BAC) of someone who is drinking depends upon four things:

- The amount of alcohol consumed
- The drinker's body weight
- The amount of food that is consumed before and during drinking
- The length of time it has taken the drinker to consume the alcohol.

According to the American Medical Association, a 180-lb. (82 kg) person who drinks three 12-ounce (355 ml) bottles of beer in an hour will end up with a BAC of about 0.06 percent. The person would reach the same BAC by drinking three 4-ounce (120 ml) glasses of wine or three mixed drinks if each had 1-1/2 ounces (45 ml) of a liquor like whiskey, gin or vodka.



It's the amount of alcohol that counts. For example, if the same person drank three double martinis (3 ounces or 90 ml of liquor each) within an hour, the person's BAC would be close to 0.12 percent. A person who consumes food just before or during drinking will have a somewhat lower BAC level.

There is a gender difference, too. Women generally have a lower relative percentage of body water than men.

Since alcohol is carried in body water, this means that a woman generally will reach a higher BAC level than a man of her same body weight when each has the same number of drinks.

The law in many U.S. states sets the legal limit at a BAC of 0.10 percent. In a growing number of U.S. states, and throughout Canada, the limit is 0.08 percent. In some other countries, it's even lower. The BAC limit for all commercial drivers in the United States is 0.04 percent.

The BAC will be over 0.10 percent after three to six drinks (in one hour). Of course, as we've seen, it depends on how much alcohol is in the drinks, and how quickly the person drinks them.

But the ability to drive is affected well below a BAC of 0.10 percent. Research shows that the driving skills of many people are impaired at a BAC approaching 0.05 percent, and that the effects are worse at night. All drivers are impaired at BAC levels above 0.05 percent. Statistics show that the chance of being in a collision increases sharply for drivers who have a BAC of 0.05 percent or above. A driver with a BAC level of 0.06 percent has doubled his or her chance of having a collision. At a BAC level of 0.10 percent, the chance of this driver having a collision is 12 times greater; at a level of 0.15 percent, the chance is 25 times greater!

The body takes about an hour to rid itself of the alcohol in one drink. No amount of coffee or number of cold showers will speed that up. "I'll be careful" isn't the right answer. What if there's an emergency, a need to take sudden action, as when a child darts into the street? A person with even a moderate BAC might not be able to react quickly enough to avoid the collision.

There's something else about drinking and driving that many people don't know. Medical research shows that alcohol in a person's system can make crash injuries worse, especially injuries to the brain, spinal cord or heart. This means that when anyone who has been drinking -- driver or passenger -- is in a crash, that person's chance of being killed or permanently disabled is higher than if the person had not been drinking.

 **CAUTION:**

**Drinking and then driving is very dangerous. Your reflexes, perceptions, attentiveness and judgment can be affected by even a small amount of alcohol. You can have a serious -- or even fatal -- collision if you drive after drinking. Please don't drink and drive or ride with a driver who has been drinking. Ride home in a cab; or if you're with a group, designate a driver who will not drink.**



## Control of a Vehicle

You have three systems that make your vehicle go where you want it to go. They are the brakes, the steering and the accelerator. All three systems have to do their work at the places where the tires meet the road.

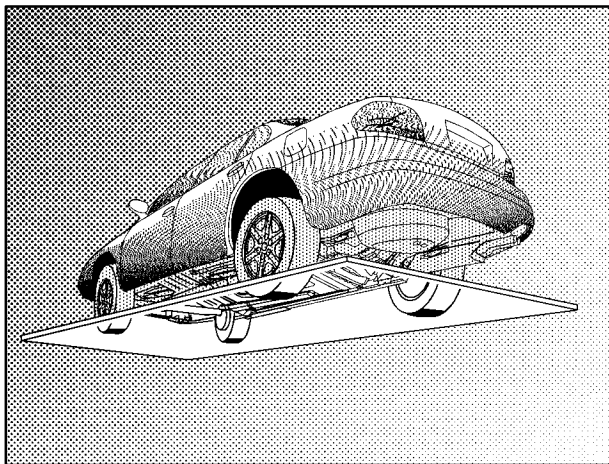

Sometimes, as when you're driving on snow or ice, it's easy to ask more of those control systems than the tires and road can provide. That means you can lose control of your vehicle. Also see "Traction Control System" in the Index.

## Braking

Braking action involves *perception time* and *reaction time*.

First, you have to decide to push on the brake pedal. That's *perception time*. Then you have to bring up your foot and do it. That's *reaction time*.

Average *reaction time* is about 3/4 of a second. But that's only an average. It might be less with one driver and as long as two or three seconds or more with another. Age, physical condition, alertness, coordination and eyesight all play a part. So do alcohol, drugs and frustration. But even in 3/4 of a second, a vehicle moving at 60 mph (100 km/h) travels 66 feet (20 m). That could be a lot of distance in an emergency, so keeping enough space between your vehicle and others is important.

And, of course, actual stopping distances vary greatly with the surface of the road (whether it's pavement or gravel); the condition of the road (wet, dry, icy); tire tread; the condition of your brakes; the weight of the vehicle and the amount of brake force applied.

Avoid needless heavy braking. Some people drive in spurts -- heavy acceleration followed by heavy braking -- rather than keeping pace with traffic. This is a mistake. Your brakes may not have time to cool between hard stops. Your brakes will wear out much faster if you do a lot of heavy braking. If you keep pace with the traffic and allow realistic following distances, you will eliminate a lot of unnecessary braking. That means better braking and longer brake life.

If your engine ever stops while you're driving, brake normally but don't pump your brakes. If you do, the pedal may get harder to push down. If your engine stops, you will still have some power brake assist. But you will use it when you brake. Once the power assist is used up, it may take longer to stop and the brake pedal will be harder to push.

## Anti-Lock Brakes (ABS)

Your vehicle has anti-lock brakes (ABS). ABS is an advanced electronic braking system that will help prevent a braking skid.

When you start your engine, or when you begin to drive away, your anti-lock brake system will check itself. You may hear a momentary motor or clicking noise while this test is going on, and you may even notice that your brake pedal moves or pulses a little. This is normal.

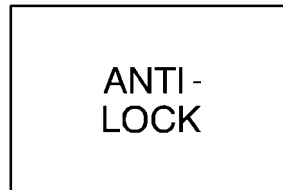

**United States**

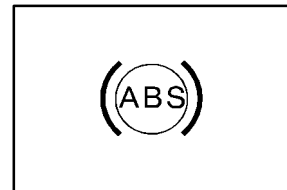

**Canada**

If there's a problem with the anti-lock brake system, this warning light will stay on. See "Anti-Lock Brake System Warning Light" in the Index.



Here's how anti-lock works. Let's say the road is wet. You're driving safely. Suddenly an animal jumps out in front of you.

You slam on the brakes and continue braking. Here's what happens with ABS.

A computer senses that wheels are slowing down. If one of the wheels is about to stop rolling, the computer will separately work the brakes at each front wheel and at both rear wheels.

The anti-lock system can change the brake pressure faster than any driver could. The computer is programmed to make the most of available tire and road conditions. This can help you steer around the obstacle while braking hard.



As you brake, your computer keeps receiving updates on wheel speed and controls braking pressure accordingly.

Remember: Anti-lock doesn't change the time you need to get your foot up to the brake pedal or always decrease stopping distance. If you get too close to the vehicle in front of you, you won't have time to apply your brakes if that vehicle suddenly slows or stops. Always leave enough room up ahead to stop, even though you have anti-lock brakes.

### Using Anti-Lock

Don't pump the brakes. Just hold the brake pedal down firmly and let anti-lock work for you. You may feel a slight brake pedal pulsation or notice some noise, but this is normal.

### Braking in Emergencies

With anti-lock, you can steer and brake at the same time. In many emergencies, steering can help you more than even the very best braking.

## Traction Control System (Option)

Your vehicle may have a traction control system that limits wheel spin. This is especially useful in slippery road conditions. The system operates only if it senses that one or both of the front wheels are spinning or beginning to lose traction. When this happens, the system works the front brakes, may upshift the transaxle, and reduces engine power to limit wheel spin.

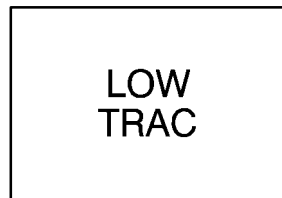

This light will come on when your traction control system is limiting wheel spin. See “Traction Control System Active Light” in the Index.

The low traction light will come on when the traction control system is limiting wheel spin. See “Low Traction Light” in the Index. You may feel or hear the system working, but this is normal.

The Traction Control System operates in all transaxle shift lever positions. But the system can upshift the transaxle only as high as the shift lever position you've chosen, so you should use the lower gears only when necessary. See "Automatic Transaxle" in the Index.

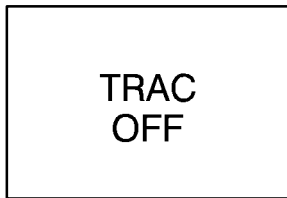

This warning light will come on to let you know if there's a problem with your traction control system.

See "Traction Control System Warning Light" in the Index. When this warning light is on, the system will not limit wheel spin. Adjust your driving accordingly.

The traction control system automatically comes on whenever you start your vehicle. To limit wheel spin, especially in slippery road conditions, you should always leave the system on. But you can turn the traction control system off if you ever need to. You should turn the system off if your vehicle ever gets stuck in sand, mud or snow and rocking the vehicle is required. See "Rocking Your Vehicle" in the Index.



To turn the system on or off, press the TRACTION CONTROL button on the console.

## Precision Control System (Option)

If your vehicle is equipped with the Precision Control System (PCS), the system helps your vehicle to go in the direction you are steering in difficult driving conditions. This is accomplished when the computer senses that your vehicle is starting to spin and assists the driver by selectively applying any one of the vehicle's brakes.

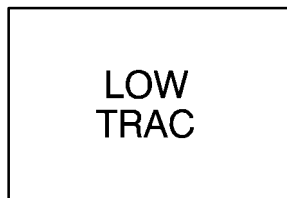

When the Precision Control System is active, the LOW TRAC light will come on.

Continue to steer in the direction you want the vehicle to go and apply the brakes normally to slow the vehicle as desired.

You may hear or feel the system working, but this is normal. You should adjust your driving accordingly. See “Low Traction Active (LOW TRAC) Light” in the Index.

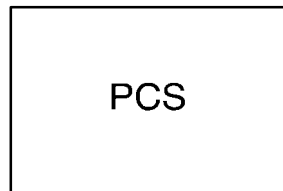

**United States**



**Canada**

When you first start the vehicle, the PCS light should come on briefly. If the light doesn't come on then, have your vehicle serviced so it will be ready to warn you if there is a problem.

If you ever see the PCS warning light come on, it means there is a problem with the Precision Control System. If both the PCS and TRAC OFF lights are on, neither of the systems are functioning. You can try resetting the system: stop, turn off the engine, wait a few seconds and then start the engine again. If both lights are still on, you should have your vehicle serviced.

## Steering

### Power Steering

If you lose power steering assist because the engine stops or the system is not functioning, you can steer but it will take much more effort.

### Magnetic Speed Sensitive Steering

This steering system provides lighter steering effort for parking and when driving at speeds below 20 mph (32 km/h). Steering effort will increase at higher speeds for improved road feel.

### Steering Tips

#### Driving on Curves

It's important to take curves at a reasonable speed.

A lot of the “driver lost control” accidents mentioned on the news happen on curves. Here's why:

Experienced driver or beginner, each of us is subject to the same laws of physics when driving on curves. The traction of the tires against the road surface makes it possible for the vehicle to change its path when you turn the front wheels. If there's no traction, inertia will keep the vehicle going in the same direction. If you've ever tried to steer a vehicle on wet ice, you'll understand this.

The traction you can get in a curve depends on the condition of your tires and the road surface, the angle at which the curve is banked, and your speed. While you're in a curve, speed is the one factor you can control.

Suppose you're steering through a sharp curve. Then you suddenly accelerate. Both control systems -- steering and acceleration -- have to do their work where the tires meet the road. Adding the sudden acceleration can demand too much of those places. You can lose control. Refer to “Traction Control System” in the Index.

What should you do if this ever happens? Ease up on the accelerator pedal, steer the vehicle the way you want it to go, and slow down.

If your vehicle is equipped with the Precision Control System, the LOW TRAC light may come on to indicate the system is engaged. See “Low Traction Active (LOW TRAC) Light” in the Index.

Speed limit signs near curves warn that you should adjust your speed. Of course, the posted speeds are based on good weather and road conditions. Under less favorable conditions you'll want to go slower.

If you need to reduce your speed as you approach a curve, do it before you enter the curve, while your front wheels are straight ahead.

Try to adjust your speed so you can “drive” through the curve. Maintain a reasonable, steady speed. Wait to accelerate until you are out of the curve, and then accelerate gently into the straightaway.

## Steering in Emergencies

There are times when steering can be more effective than braking. For example, you come over a hill and find a truck stopped in your lane, or a car suddenly pulls out from nowhere, or a child darts out from between parked cars and stops right in front of you. You can avoid these problems by braking -- if you can stop in time. But sometimes you can't; there isn't room. That's the time for evasive action -- steering around the problem.

Your vehicle can perform very well in emergencies like these. First apply your brakes. See “Braking in Emergencies” earlier in this section. It is better to remove as much speed as you can from a possible collision. Then steer around the problem, to the left or right depending on the space available.

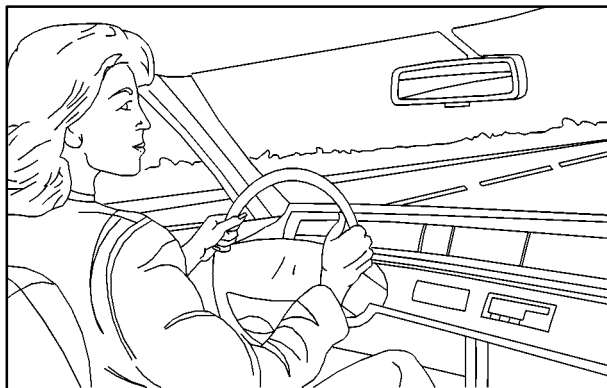

An emergency like this requires close attention and a quick decision. If you are holding the steering wheel at the recommended 9 and 3 o'clock positions, you can turn it a full 180 degrees very quickly without removing either hand. But you have to act fast, steer quickly, and just as quickly straighten the wheel once you have avoided the object.

The fact that such emergency situations are always possible is a good reason to practice defensive driving at all times and wear safety belts properly.



## Off-Road Recovery

You may find that your right wheels have dropped off the edge of a road onto the shoulder while you're driving.

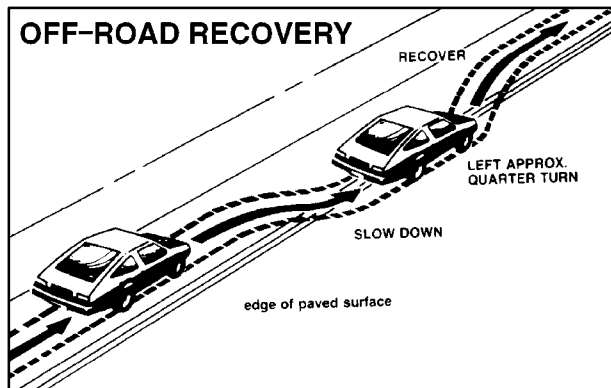

If the level of the shoulder is only slightly below the pavement, recovery should be fairly easy. Ease off the accelerator and then, if there is nothing in the way, steer so that your vehicle straddles the edge of the pavement. You can turn the steering wheel up to one-quarter turn until the right front tire contacts the pavement edge. Then turn your steering wheel to go straight down the roadway.

## Passing

The driver of a vehicle about to pass another on a two-lane highway waits for just the right moment, accelerates, moves around the vehicle ahead, then goes back into the right lane again. A simple maneuver?

Not necessarily! Passing another vehicle on a two-lane highway is a potentially dangerous move, since the passing vehicle occupies the same lane as oncoming traffic for several seconds. A miscalculation, an error in judgment, or a brief surrender to frustration or anger can suddenly put the passing driver face to face with the worst of all traffic accidents -- the head-on collision.

So here are some tips for passing:

- “Drive ahead.” Look down the road, to the sides and to crossroads for situations that might affect your passing patterns. If you have any doubt whatsoever about making a successful pass, wait for a better time.
- Watch for traffic signs, pavement markings and lines. If you can see a sign up ahead that might indicate a turn or an intersection, delay your pass. A broken center line usually indicates it's all right to pass (providing the road ahead is clear). Never cross a solid line on your side of the lane or a double solid line, even if the road seems empty of approaching traffic.

- Do not get too close to the vehicle you want to pass while you're awaiting an opportunity. For one thing, following too closely reduces your area of vision, especially if you're following a larger vehicle. Also, you won't have adequate space if the vehicle ahead suddenly slows or stops. Keep back a reasonable distance.
- When it looks like a chance to pass is coming up, start to accelerate but stay in the right lane and don't get too close. Time your move so you will be increasing speed as the time comes to move into the other lane. If the way is clear to pass, you will have a "running start" that more than makes up for the distance you would lose by dropping back. And if something happens to cause you to cancel your pass, you need only slow down and drop back again and wait for another opportunity.
- If other cars are lined up to pass a slow vehicle, wait your turn. But take care that someone isn't trying to pass you as you pull out to pass the slow vehicle. Remember to glance over your shoulder and check the blind spot.
- Check your mirrors, glance over your shoulder, and start your left lane change signal before moving out of the right lane to pass. When you are far enough ahead of the passed vehicle to see its front in your inside mirror, activate your right lane change signal and move back into the right lane. (Remember that your right outside mirror is convex. The vehicle you just passed may seem to be farther away from you than it really is.)
- Try not to pass more than one vehicle at a time on two-lane roads. Reconsider before passing the next vehicle.
- Don't overtake a slowly moving vehicle too rapidly. Even though the brake lamps are not flashing, it may be slowing down or starting to turn.
- If you're being passed, make it easy for the following driver to get ahead of you. Perhaps you can ease a little to the right.

## Loss of Control

Let's review what driving experts say about what happens when the three control systems (brakes, steering and acceleration) don't have enough friction where the tires meet the road to do what the driver has asked.

In any emergency, don't give up. Keep trying to steer and constantly seek an escape route or area of less danger.

### Skidding

In a skid, a driver can lose control of the vehicle. Defensive drivers avoid most skids by taking reasonable care suited to existing conditions, and by not "overdriving" those conditions. But skids are always possible.

The three types of skids correspond to your vehicle's three control systems. In the braking skid, your wheels aren't rolling. In the steering or cornering skid, too much speed or steering in a curve causes tires to slip and lose cornering force. And in the acceleration skid, too much throttle causes the driving wheels to spin.

A cornering skid is best handled by easing your foot off the accelerator pedal.

Remember: Any traction control system helps avoid only the acceleration skid.

If your traction control system is off, then an acceleration skid is also best handled by easing your foot off the accelerator pedal.

If your vehicle starts to slide, ease your foot off the accelerator pedal and quickly steer the way you want the vehicle to go. If you start steering quickly enough, your vehicle may straighten out. Always be ready for a second skid if it occurs.

If your vehicle is equipped with the Precision Control System, the LOW TRAC light may come on. See "Low Traction Active (LOW TRAC) Light" in the Index.

Of course, traction is reduced when water, snow, ice, gravel or other material is on the road. For safety, you'll want to slow down and adjust your driving to these conditions. It is important to slow down on slippery surfaces because stopping distance will be longer and vehicle control more limited.

While driving on a surface with reduced traction, try your best to avoid sudden steering, acceleration or braking (including engine braking by shifting to a lower gear). Any sudden changes could cause the tires to slide. You may not realize the surface is slippery until your vehicle is skidding. Learn to recognize warning clues -- such as enough water, ice or packed snow on the road to make a "mirrored surface" -- and slow down when you have any doubt.

Remember: Any anti-lock brake system (ABS) helps avoid only the braking skid.

## Driving at Night

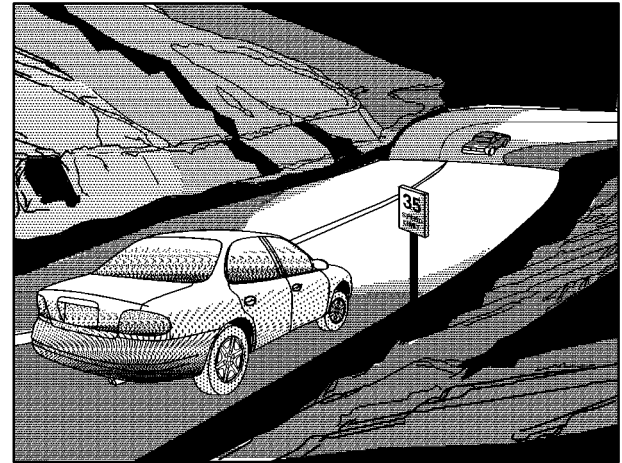

Night driving is more dangerous than day driving. One reason is that some drivers are likely to be impaired -- by alcohol or drugs, with night vision problems, or by fatigue.

Here are some tips on night driving.

- Drive defensively.
- Don't drink and drive.
- Adjust your inside rearview mirror to reduce the glare from headlamps behind you.
- Since you can't see as well, you may need to slow down and keep more space between you and other vehicles.
- Slow down, especially on higher speed roads. Your headlamps can light up only so much road ahead.
- In remote areas, watch for animals.
- If you're tired, pull off the road in a safe place and rest.

No one can see as well at night as in the daytime. But as we get older these differences increase. A 50-year-old driver may require at least twice as much light to see the same thing at night as a 20-year-old.

What you do in the daytime can also affect your night vision. For example, if you spend the day in bright sunshine you are wise to wear sunglasses. Your eyes will have less trouble adjusting to night. But if you're driving, don't wear sunglasses at night.

They may cut down on glare from headlamps, but they also make a lot of things invisible.

You can be temporarily blinded by approaching headlamps. It can take a second or two, or even several seconds, for your eyes to readjust to the dark. When you are faced with severe glare (as from a driver who doesn't lower the high beams, or a vehicle with misaimed headlamps), slow down a little. Avoid staring directly into the approaching headlamps.

Keep your windshield and all the glass on your vehicle clean -- inside and out. Glare at night is made much worse by dirt on the glass. Even the inside of the glass can build up a film caused by dust. Dirty glass makes lights dazzle and flash more than clean glass would, making the pupils of your eyes contract repeatedly.

Remember that your headlamps light up far less of a roadway when you are in a turn or curve. Keep your eyes moving; that way, it's easier to pick out dimly lighted objects. Just as your headlamps should be checked regularly for proper aim, so should your eyes be examined regularly. Some drivers suffer from night blindness -- the inability to see in dim light -- and aren't even aware of it.

## Driving in Rain and on Wet Roads

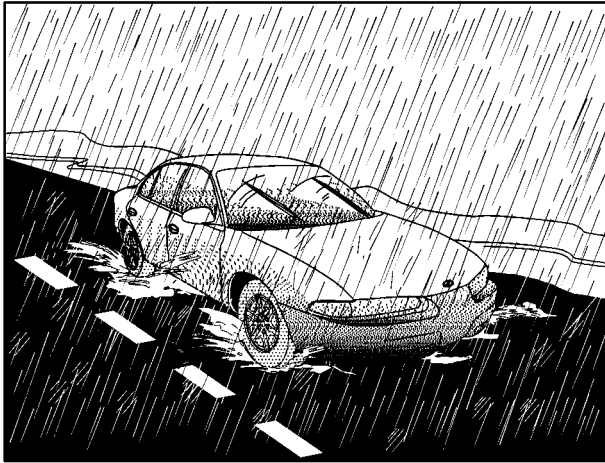

Rain and wet roads can mean driving trouble. On a wet road, you can't stop, accelerate or turn as well because your tire-to-road traction isn't as good as on dry roads. And, if your tires don't have much tread left, you'll get even less traction. It's always wise to go slower and be cautious if rain starts to fall while you are driving. The surface may get wet suddenly when your reflexes are tuned for driving on dry pavement.

The heavier the rain, the harder it is to see. Even if your windshield wiper blades are in good shape, a heavy rain can make it harder to see road signs and traffic signals, pavement markings, the edge of the road and even people walking.

It's wise to keep your windshield wiping equipment in good shape and keep your windshield washer tank filled with washer fluid. Replace your windshield wiper inserts when they show signs of streaking or missing areas on the windshield, or when strips of rubber start to separate from the inserts.

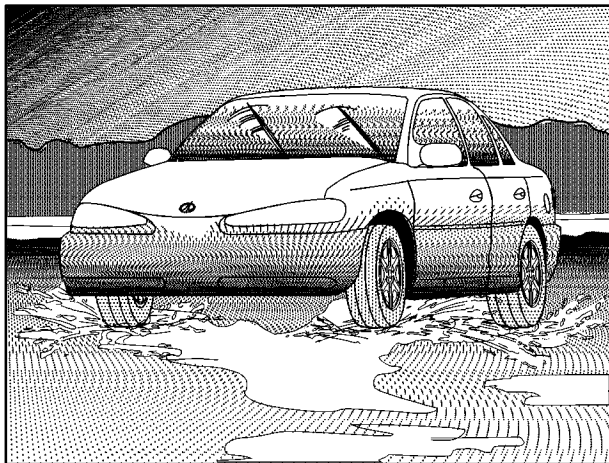

Driving too fast through large water puddles or even going through some car washes can cause problems, too. The water may affect your brakes. Try to avoid puddles. But if you can't, try to slow down before you hit them.

## CAUTION:

**Wet brakes can cause accidents. They won't work as well in a quick stop and may cause pulling to one side. You could lose control of the vehicle.**

**After driving through a large puddle of water or a car wash, apply your brake pedal lightly until your brakes work normally.**

## Hydroplaning

Hydroplaning is dangerous. So much water can build up under your tires that they can actually ride on the water. This can happen if the road is wet enough and you're going fast enough. When your vehicle is hydroplaning, it has little or no contact with the road.

Hydroplaning doesn't happen often. But it can if your tires do not have much tread or if the pressure in one or more is low. It can happen if a lot of water is standing on the road. If you can see reflections from trees, telephone poles or other vehicles, and raindrops "dimple" the water's surface, there could be hydroplaning.

Hydroplaning usually happens at higher speeds. There just isn't a hard and fast rule about hydroplaning. The best advice is to slow down when it is raining.

### Driving Through Deep Standing Water

#### **NOTICE:**

**If you drive too quickly through deep puddles or standing water, water can come in through your engine's air intake and badly damage your engine. Never drive through water that is slightly lower than the underbody of your vehicle. If you can't avoid deep puddles or standing water, drive through them very slowly.**

### Driving Through Flowing Water

#### **CAUTION:**

**Flowing or rushing water creates strong forces. If you try to drive through flowing water, as you might at a low water crossing, your vehicle can be carried away. As little as six inches of flowing water can carry away a smaller vehicle. If this happens, you and other vehicle occupants could drown. Don't ignore police warning signs, and otherwise be very cautious about trying to drive through flowing water.**

### Some Other Rainy Weather Tips

- Besides slowing down, allow some extra following distance. And be especially careful when you pass another vehicle. Allow yourself more clear room ahead, and be prepared to have your view restricted by road spray.
- Have good tires with proper tread depth. See "Tires" in the Index.



## City Driving



One of the biggest problems with city streets is the amount of traffic on them. You'll want to watch out for what the other drivers are doing and pay attention to traffic signals.

Here are ways to increase your safety in city driving:

- Know the best way to get to where you are going. Get a city map and plan your trip into an unknown part of the city just as you would for a cross-country trip.
- Try to use the freeways that rim and crisscross most large cities. You'll save time and energy. See the next part, "Freeway Driving."
- Treat a green light as a warning signal. A traffic light is there because the corner is busy enough to need it. When a light turns green, and just before you start to move, check both ways for vehicles that have not cleared the intersection or may be running the red light.

## Freeway Driving



Mile for mile, freeways (also called thruways, parkways, expressways, turnpikes or superhighways) are the safest of all roads. But they have their own special rules.

The most important advice on freeway driving is: Keep up with traffic and keep to the right. Drive at the same speed most of the other drivers are driving. Too-fast or too-slow driving breaks a smooth traffic flow. Treat the left lane on a freeway as a passing lane.

At the entrance, there is usually a ramp that leads to the freeway. If you have a clear view of the freeway as you drive along the entrance ramp, you should begin to check traffic. Try to determine where you expect to blend with the flow. Try to merge into the gap at close to the prevailing speed. Switch on your turn signal, check your mirrors and glance over your shoulder as often as necessary. Try to blend smoothly with the traffic flow.

Once you are on the freeway, adjust your speed to the posted limit or to the prevailing rate if it's slower. Stay in the right lane unless you want to pass.

Before changing lanes, check your mirrors. Then use your turn signal.

Just before you leave the lane, glance quickly over your shoulder to make sure there isn't another vehicle in your "blind" spot.

Once you are moving on the freeway, make certain you allow a reasonable following distance. Expect to move slightly slower at night.

When you want to leave the freeway, move to the proper lane well in advance. If you miss your exit, do not, under any circumstances, stop and back up. Drive on to the next exit.

The exit ramp can be curved, sometimes quite sharply.

The exit speed is usually posted.

Reduce your speed according to your speedometer, not to your sense of motion. After driving for any distance at higher speeds, you may tend to think you are going slower than you actually are.

## Before Leaving on a Long Trip

Make sure you're ready. Try to be well rested. If you must start when you're not fresh -- such as after a day's work -- don't plan to make too many miles that first part of the journey. Wear comfortable clothing and shoes you can easily drive in.

Is your vehicle ready for a long trip? If you keep it serviced and maintained, it's ready to go. If it needs service, have it done before starting out. Of course, you'll find experienced and able service experts in Oldsmobile dealerships all across North America. They'll be ready and willing to help if you need it.

Here are some things you can check before a trip:

- *Windshield Washer Fluid:* Is the reservoir full? Are all windows clean inside and outside?
- *Wiper Blades:* Are they in good shape?
- *Fuel, Engine Oil, Other Fluids:* Have you checked all levels?
- *Lamps:* Are they all working? Are the lenses clean?
- *Tires:* They are vitally important to a safe, trouble-free trip. Is the tread good enough for long-distance driving? Are the tires all inflated to the recommended pressure?
- *Weather Forecasts:* What's the weather outlook along your route? Should you delay your trip a short time to avoid a major storm system?
- *Maps:* Do you have up-to-date maps?

## Highway Hypnosis

Is there actually such a condition as “highway hypnosis”? Or is it just plain falling asleep at the wheel? Call it highway hypnosis, lack of awareness, or whatever.

There is something about an easy stretch of road with the same scenery, along with the hum of the tires on the road, the drone of the engine, and the rush of the wind against the vehicle that can make you sleepy. Don't let it happen to you! If it does, your vehicle can leave the road in *less than a second*, and you could crash and be injured.

What can you do about highway hypnosis?  
First, be aware that it can happen.

Then here are some tips:

- Make sure your vehicle is well ventilated, with a comfortably cool interior.
- Keep your eyes moving. Scan the road ahead and to the sides. Check your rearview mirrors and your instruments frequently.
- If you get sleepy, pull off the road into a rest, service or parking area and take a nap, get some exercise, or both. For safety, treat drowsiness on the highway as an emergency.

## Hill and Mountain Roads



Driving on steep hills or mountains is different from driving in flat or rolling terrain.

If you drive regularly in steep country, or if you're planning to visit there, here are some tips that can make your trips safer and more enjoyable.

- Keep your vehicle in good shape. Check all fluid levels and also the brakes, tires, cooling system and transaxle. These parts can work hard on mountain roads.
- Know how to go down hills. The most important thing to know is this: let your engine do some of the slowing down. Shift to a lower gear when you go down a steep or long hill.

 **CAUTION:**

**If you don't shift down, your brakes could get so hot that they wouldn't work well. You would then have poor braking or even none going down a hill. You could crash. Shift down to let your engine assist your brakes on a steep downhill slope.**

 **CAUTION:**

**Coasting downhill in NEUTRAL (N) or with the ignition off is dangerous. Your brakes will have to do all the work of slowing down. They could get so hot that they wouldn't work well. You would then have poor braking or even none going down a hill. You could crash. Always have your engine running and your vehicle in gear when you go downhill.**

- Know how to go uphill. You may want to shift down to a lower gear. The lower gears help cool your engine and transaxle, and you can climb the hill better.
- Stay in your own lane when driving on two-lane roads in hills or mountains. Don't swing wide or cut across the center of the road. Drive at speeds that let you stay in your own lane.
- As you go over the top of a hill, be alert. There could be something in your lane, like a stalled car or an accident.
- You may see highway signs on mountains that warn of special problems. Examples are long grades, passing or no-passing zones, a falling rocks area or winding roads. Be alert to these and take appropriate action.

## Winter Driving



Here are some tips for winter driving:

- Have your vehicle in good shape for winter.
- You may want to put winter emergency supplies in your trunk.



Include an ice scraper, a small brush or broom, a supply of windshield washer fluid, a rag, some winter outer clothing, a small shovel, a flashlight, a red cloth and a couple of reflective warning triangles. And, if you will be driving under severe conditions, include a small bag of sand, a piece of old carpet or a couple of burlap bags to help provide traction. Be sure you properly secure these items in your vehicle.

## Driving on Snow or Ice

Most of the time, those places where your tires meet the road probably have good traction.

However, if there is snow or ice between your tires and the road, you can have a very slippery situation.

You'll have a lot less traction or "grip" and will need to be very careful.

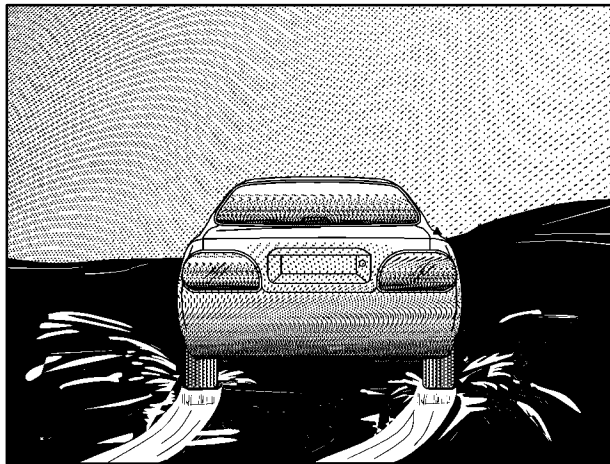

What's the worst time for this? "Wet ice." Very cold snow or ice can be slick and hard to drive on. But wet ice can be even more trouble because it may offer the least traction of all. You can get wet ice when it's about freezing (32°F; 0°C) and freezing rain begins to fall. Try to avoid driving on wet ice until salt and sand crews can get there.

Whatever the condition -- smooth ice, packed, blowing or loose snow -- drive with caution.

If you have traction control, keep the system on. It will improve your ability to accelerate when driving on a slippery road. Even though your vehicle has a traction control system, you'll want to slow down and adjust your driving to the road conditions. See "Traction Control System" in the Index.

If you don't have the traction control system, accelerate gently. Try not to break the fragile traction. If you accelerate too fast, the drive wheels will spin and polish the surface under the tires even more.

Your anti-lock brakes improve your vehicle's stability when you make a hard stop on a slippery road. Even though you have the anti-lock braking system, you'll want to begin stopping sooner than you would on dry pavement. See "Anti-Lock" in the Index.

- Allow greater following distance on any slippery road.
- Watch for slippery spots. The road might be fine until you hit a spot that's covered with ice. On an otherwise clear road, ice patches may appear in shaded areas where the sun can't reach: around clumps of trees, behind buildings or under bridges. Sometimes the surface of a curve or an overpass may remain icy when the surrounding roads are clear. If you see a patch of ice ahead of you, brake before you are on it. Try not to brake while you're actually on the ice, and avoid sudden steering maneuvers.

## If You're Caught in a Blizzard

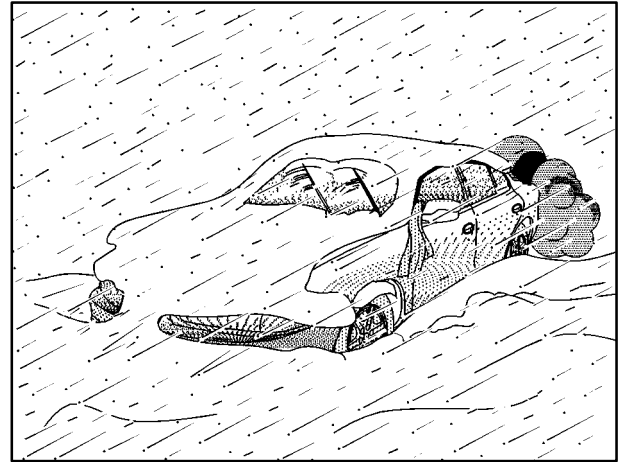

If you are stopped by heavy snow, you could be in a serious situation. You should probably stay with your vehicle unless you know for sure that you are near help and you can hike through the snow. Here are some things to do to summon help and keep yourself and your passengers safe:

- Turn on your hazard flashers.



- Tie a red cloth to your vehicle to alert police that you've been stopped by the snow.
- Put on extra clothing or wrap a blanket around you. If you have no blankets or extra clothing, make body insulators from newspapers, burlap bags, rags, floor mats -- anything you can wrap around yourself or tuck under your clothing to keep warm.

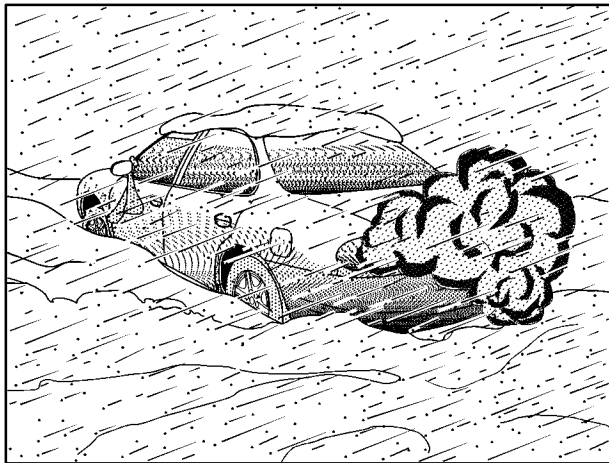

You can run the engine to keep warm, but be careful.

## CAUTION:

**Snow can trap exhaust gases under your vehicle. This can cause deadly CO (carbon monoxide) gas to get inside. CO could overcome you and kill you. You can't see it or smell it, so you might not know it is in your vehicle. Clear away snow from around the base of your vehicle, especially any that is blocking your exhaust pipe. And check around again from time to time to be sure snow doesn't collect there.**

**Open a window just a little on the side of the vehicle that's away from the wind. This will help keep CO out.**

Run your engine only as long as you must. This saves fuel. When you run the engine, make it go a little faster than just idle. That is, push the accelerator slightly. This uses less fuel for the heat that you get and it keeps the battery charged. You will need a well-charged battery to restart the vehicle, and possibly for signaling later on with your headlamps. Let the heater run for a while.

Then, shut the engine off and close the window almost all the way to preserve the heat. Start the engine again and repeat this only when you feel really uncomfortable from the cold. But do it as little as possible. Preserve the fuel as long as you can. To help keep warm, you can get out of the vehicle and do some fairly vigorous exercises every half hour or so until help comes.

## Recreational Vehicle Towing

Your vehicle was not designed to be towed with all four wheels on the ground. If your vehicle must be towed, see “Towing Your Vehicle” in the Index.

### NOTICE:

**Towing your vehicle with all four wheels on the ground will damage drivetrain components.**

## Loading Your Vehicle

**GM** TIRE-LOADING INFORMATION

OCCUPANTS VEHICLE CAP. WT.

FRT. CTR. RR. TOTAL KG LB

MAX. LOADING @ GVWR SAME AS VEHICLE CAP. ACT. WEIGHT

2000

MODEL: \_\_\_\_\_

TIRE SIZE SPEED RATING COLD TIRE PRESSURE

FRT. \_\_\_\_\_

RR. \_\_\_\_\_

PA \_\_\_\_\_

TIRES ARE HOT, ADD 28KPA(4PSI)

SEE OWNER'S MANUAL FOR MORE INFORMATION

Two labels on your vehicle show how much weight it may properly carry. The Tire-Loading Information label is inside the trunk lid. The label tells you the proper size, speed rating and recommended inflation pressures for the tires on your vehicle. It also gives you important information about the number of people that can be in your vehicle and the total weight you can carry. This includes the weight of all occupants, cargo and all nonfactory-installed options.

MFD BY GENERAL MOTORS CORP

DATE  GVWR  GAWR FRT  GVWR RR

THIS VEHICLE CONFORMS TO ALL APPLICABLE U.S. DEPARTMENT OF MOTOR VEHICLE SAFETY, BUMPER AND TRAFFIC PREVENTION STANDARDS IN EFFECT ON THE DATE OF MANUFACTURE SHOWN ABOVE.

200  TYPE: PASS CAR

**EXAMPLE**

The other label is the Certification label, found on the rear edge of the driver's door. It tells you the gross weight capacity of your vehicle, called the Gross Vehicle Weight Rating (GVWR). The GVWR includes the weight of the vehicle, all occupants, fuel and cargo. Never exceed the GVWR for your vehicle or the Gross Axle Weight Rating (GAWR) for either the front or rear axle.

If you do have a heavy load, spread it out. Don't carry more than 167 lbs. (75 kg) in your trunk.

**⚠ CAUTION:**

**Do not load your vehicle any heavier than the GVWR, or either the maximum front or rear GAWR. If you do, parts on your vehicle can break, and it can change the way your vehicle handles. These could cause you to lose control and crash. Also, overloading can shorten the life of your vehicle.**

## CAUTION:

Things you put inside your vehicle can strike and injure people in a sudden stop or turn, or in a crash.

- Put things in the trunk of your vehicle. In a trunk, put them as far forward as you can. Try to spread the weight evenly.
- Never stack heavier things, like suitcases, inside the vehicle so that some of them are above the tops of the seats.
- Don't leave an unsecured child restraint in your vehicle.
- When you carry something inside the vehicle, secure it whenever you can.
- Don't leave a seat folded down unless you need to.

## Towing a Trailer

### CAUTION:

If you don't use the correct equipment and drive properly, you can lose control when you pull a trailer. For example, if the trailer is too heavy, the brakes may not work well -- or even at all. You and your passengers could be seriously injured. You may also damage your vehicle; the resulting repairs would not be covered by your warranty. Pull a trailer only if you have followed all the steps in this section. Ask your dealer for advice and information about towing a trailer with your vehicle.

Your vehicle can tow a trailer if it is equipped with the proper trailer towing equipment. To identify what the vehicle trailering capacity is for your vehicle, you should read the information in “Weight of the Trailer” that appears later in this section. But trailering is different than just driving your vehicle by itself. Trailering means changes in handling, durability and fuel economy. Successful, safe trailering takes correct equipment, and it has to be used properly.

That’s the reason for this part. In it are many time-tested, important trailering tips and safety rules. Many of these are important for your safety and that of your passengers. So please read this section carefully before you pull a trailer.

Load-pulling components such as the engine, transaxle, wheel assemblies and tires are forced to work harder against the drag of the added weight. The engine is required to operate at relatively higher speeds and under greater loads, generating extra heat. What’s more, the trailer adds considerably to wind resistance, increasing the pulling requirements.

## **If You Do Decide To Pull A Trailer**

If you do, here are some important points:

- There are many different laws, including speed limit restrictions, having to do with trailering. Make sure your rig will be legal, not only where you live but also where you’ll be driving. A good source for this information can be state or provincial police.
- Consider using a sway control. You can ask a hitch dealer about sway controls.
- Don’t tow a trailer at all during the first 1,000 miles (1 600 km) your new vehicle is driven. Your engine, axle or other parts could be damaged.
- Then, during the first 500 miles (800 km) that you tow a trailer, don’t drive over 50 mph (80 km/h) and don’t make starts at full throttle. This helps your engine and other parts of your vehicle wear in at the heavier loads.
- Obey speed limit restrictions when towing a trailer. Don’t drive faster than the maximum posted speed for trailers, or no more than 55 mph (90 km/h), to save wear on your vehicle’s parts.

Three important considerations have to do with weight:

- the weight of the trailer,
- the weight of the trailer tongue
- and the total weight on your vehicle's tires.

## **Weight of the Trailer**

How heavy can a trailer safely be?

It should never weigh more than 1,000 lbs. (450 kg).  
But even that can be too heavy.

It depends on how you plan to use your rig. For example, speed, altitude, road grades, outside temperature and how much your vehicle is used to pull a trailer are all important. And, it can also depend on any special equipment that you have on your vehicle.

You can ask your dealer for our trailering information or advice, or you can write us at:

Oldsmobile Customer Assistance Center  
P.O. Box 33171  
Detroit, MI 48232-5171

In Canada, write to:

General Motors of Canada Limited  
Customer Communication Centre, 163-005  
1908 Colonel Sam Drive  
Oshawa, Ontario L1H 8P7

## **Weight of the Trailer Tongue**

The tongue load (A) of any trailer is an important weight to measure because it affects the total or gross weight of your vehicle. The Gross Vehicle Weight (GVW) includes the curb weight of the vehicle, any cargo you may carry in it, and the people who will be riding in the vehicle. And if you tow a trailer, you must add the tongue load to the GVW because your vehicle will be carrying that weight, too. See "Loading Your Vehicle" in the Index for more information about your vehicle's maximum load capacity.

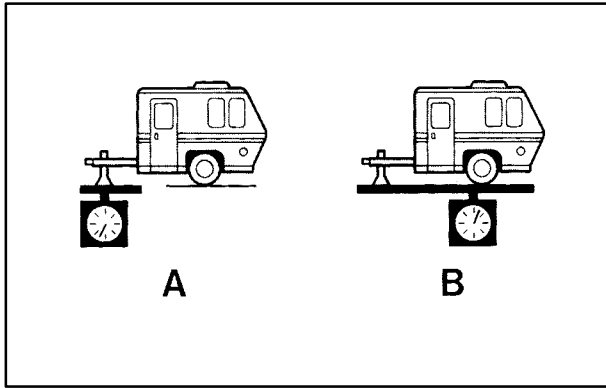

If you're using a weight-carrying hitch, the trailer tongue (A) should weigh 10 percent of the total loaded trailer weight (B). If you have a weight-distributing hitch, the trailer tongue (A) should weigh 12 percent of the total loaded trailer weight (B).

After you've loaded your trailer, weigh the trailer and then the tongue, separately, to see if the weights are proper. If they aren't, you may be able to get them right simply by moving some items around in the trailer.

## Total Weight on Your Vehicle's Tires

Be sure your vehicle's tires are inflated to the upper limit for cold tires. You'll find these numbers on the Tire-Loading Information label inside of the trunk lid or see "Loading Your Vehicle" in the Index. Then be sure you don't go over the GVW limit for your vehicle, including the weight of the trailer tongue.

## Hitches

It's important to have the correct hitch equipment. Crosswinds, large trucks going by and rough roads are a few reasons why you'll need the right hitch. Here are some rules to follow:

- The rear bumper on your vehicle is not intended for hitches. Do not attach rental hitches or other bumper-type hitches to it. Use only a frame-mounted hitch that does not attach to the bumper.
- Will you have to make any holes in the body of your vehicle when you install a trailer hitch? If you do, then be sure to seal the holes later when you remove the hitch. If you don't seal them, deadly carbon monoxide (CO) from your exhaust can get into your vehicle. See "Carbon Monoxide" in the Index. Dirt and water can, too.

## Safety Chains

You should always attach chains between your vehicle and your trailer. Cross the safety chains under the tongue of the trailer so that the tongue will not drop to the road if it becomes separated from the hitch. Instructions about safety chains may be provided by the hitch manufacturer or by the trailer manufacturer. Follow the manufacturer's recommendation for attaching safety chains and do not attach them to the bumper. Always leave just enough slack so you can turn with your rig. And, never allow safety chains to drag on the ground.

## Trailer Brakes

Because you have anti-lock brakes, do not try to tap into your vehicle's brake system. If you do, both brake systems won't work well, or at all.

## Driving with a Trailer

Towing a trailer requires a certain amount of experience. Before setting out for the open road, you'll want to get to know your rig. Acquaint yourself with the feel of handling and braking with the added weight of the trailer. And always keep in mind that the vehicle you are driving is now a good deal longer and not nearly as responsive as your vehicle is by itself.

Before you start, check the trailer hitch and platform (and attachments), safety chains, electrical connector, lamps, tires and mirror adjustment. If the trailer has electric brakes, start your vehicle and trailer moving and then apply the trailer brake controller by hand to be sure the brakes are working. This lets you check your electrical connection at the same time.

During your trip, check occasionally to be sure that the load is secure, and that the lamps and any trailer brakes are still working.



## Following Distance

Stay at least twice as far behind the vehicle ahead as you would when driving your vehicle without a trailer. This can help you avoid situations that require heavy braking and sudden turns.

## Passing

You'll need more passing distance up ahead when you're towing a trailer. And, because you're a good deal longer, you'll need to go much farther beyond the passed vehicle before you can return to your lane.

## Backing Up

Hold the bottom of the steering wheel with one hand. Then, to move the trailer to the left, just move that hand to the left. To move the trailer to the right, move your hand to the right. Always back up slowly and, if possible, have someone guide you.

## Making Turns

### **NOTICE:**

**Making very sharp turns while trailering could cause the trailer to come in contact with the vehicle. Your vehicle could be damaged. Avoid making very sharp turns while trailering.**

When you're turning with a trailer, make wider turns than normal. Do this so your trailer won't strike soft shoulders, curbs, road signs, trees or other objects. Avoid jerky or sudden maneuvers. Signal well in advance.

## Turn Signals When Towing a Trailer

When you tow a trailer, your vehicle may need a different turn signal flasher and/or extra wiring. Check with your dealer. The arrows on your instrument panel will flash whenever you signal a turn or lane change. Properly hooked up, the trailer lamps will also flash, telling other drivers you're about to turn, change lanes or stop.

When towing a trailer, the arrows on your instrument panel will flash for turns even if the bulbs on the trailer are burned out. Thus, you may think drivers behind you are seeing your signal when they are not. It's important to check occasionally to be sure the trailer bulbs are still working.

## Driving On Grades

Reduce speed and shift to a lower gear *before* you start down a long or steep downgrade. If you don't shift down, you might have to use your brakes so much that they would get hot and no longer work well.

On a long uphill grade, shift down and reduce your speed to around 45 mph (70 km/h) to reduce the possibility of engine and transaxle overheating.

If you have overdrive, you may have to drive in THIRD (3) instead of AUTOMATIC OVERDRIVE (D).

## Parking on Hills

### CAUTION:

**You really should not park your vehicle, with a trailer attached, on a hill. If something goes wrong, your rig could start to move. People can be injured, and both your vehicle and the trailer can be damaged.**

But if you ever have to park your rig on a hill, here's how to do it:

1. Apply your regular brakes, but don't shift into PARK (P) yet.
2. Have someone place chocks under the trailer wheels.
3. When the wheel chocks are in place, release the regular brakes until the chocks absorb the load.
4. Reapply the regular brakes. Then apply your parking brake, and then shift to PARK (P).
5. Release the regular brakes.

## **When You Are Ready to Leave After Parking on a Hill**

1. Apply your regular brakes and hold the pedal down while you:
  - Start your engine;
  - Shift into a gear; and
  - Release the parking brake.
2. Let up on the brake pedal.
3. Drive slowly until the trailer is clear of the chocks.
4. Stop and have someone pick up and store the chocks.

## **Maintenance When Trailer Towing**

Your vehicle will need service more often when you're pulling a trailer. See the Maintenance Schedule for more on this. Things that are especially important in trailer operation are automatic transaxle fluid (don't overfill), engine oil, drive belts, cooling system and brake system. Each of these is covered in this manual, and the Index will help you find them quickly. If you're trailering, it's a good idea to review this information before you start your trip.

Check periodically to see that all hitch nuts and bolts are tight.

## **Engine Cooling When Trailer Towing**

Your cooling system may temporarily overheat during severe operating conditions. See "Engine Overheating" in the Index.



## Section 5 Problems on the Road

---

Here you'll find what to do about some problems that can occur on the road.

5-2 Hazard Warning Flashers  
5-3 Other Warning Devices  
5-3 Jump Starting  
5-9 Towing Your Vehicle  
5-9 Engine Overheating

5-12 Cooling System  
5-18 If a Tire Goes Flat  
5-19 Changing a Flat Tire  
5-29 Compact Spare Tire  
5-30 If You're Stuck: In Sand, Mud, Ice or Snow

## Hazard Warning Flashers

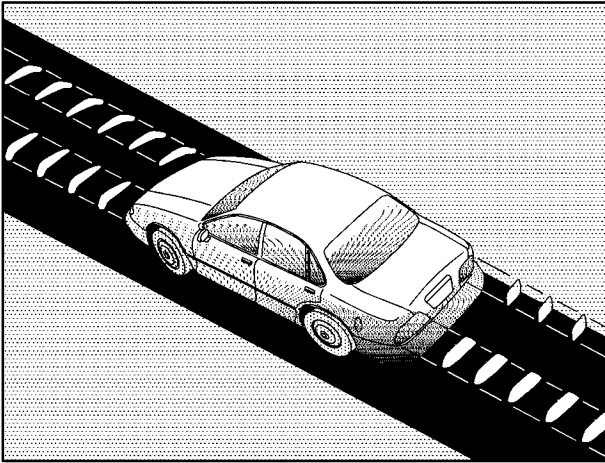

Your hazard warning flashers let you warn others. They also let police know you have a problem. Your front and rear turn signal lamps will flash on and off.



Press the switch located on your instrument panel to make your front and rear turn signal lamps flash on and off.

The hazard warning flashers work no matter what position your key is in, and even if the key isn't in.

To turn off the flashers, press the switch again. When the hazard warning flashers are on, your turn signals won't work.

## Other Warning Devices

If you carry reflective triangles, you can set one up at the side of the road about 300 feet (100 m) behind your vehicle.

## Jump Starting

If your battery has run down, you may want to use another vehicle and some jumper cables to start your vehicle. But please follow the steps below to do it safely.



### CAUTION:

**Batteries can hurt you. They can be dangerous because:**

- They contain acid that can burn you.
- They contain gas that can explode or ignite.
- They contain enough electricity to burn you.

**If you don't follow these steps exactly, some or all of these things can hurt you.**

### NOTICE:

**Ignoring these steps could result in costly damage to your vehicle that wouldn't be covered by your warranty.**

**The ACDelco<sup>®</sup> battery in your vehicle has a built-in hydrometer. Do not charge, test or jump start the battery if the hydrometer looks clear or light yellow. Replace the battery when there is a clear or light yellow hydrometer and a cranking complaint.**

**Trying to start your vehicle by pushing or pulling it won't work, and it could damage your vehicle.**

1. Check the other vehicle. It must have a 12-volt battery with a negative ground system.

### **NOTICE:**

**If the other system isn't a 12-volt system with a negative ground, both vehicles can be damaged.**

2. Get the vehicles close enough so the jumper cables can reach, but be sure the vehicles aren't touching each other. If they are, it could cause a ground connection you don't want. You wouldn't be able to start your vehicle, and the bad grounding could damage the electrical systems.

To avoid the possibility of the vehicles rolling, set the parking brake firmly on both vehicles involved in the jump start procedure. Put your automatic transaxle in PARK (P) or your manual transaxle in NEUTRAL.

3. Turn off the ignition on both vehicles. Turn off all lamps that aren't needed as well as radios. This will avoid sparks and help save both batteries. And it could save your radio.

### **NOTICE:**

**If you leave your radio on, it could be badly damaged. The repairs wouldn't be covered by your warranty.**

4. Open the hoods and locate the batteries.



### **CAUTION:**

**An electric fan can start up even when the engine is not running and can injure you. Keep hands, clothing and tools away from any underhood electric fan.**

5. Find the positive (+) and negative (-) terminals on each battery. Your vehicle has a remote positive (+) jump starting terminal. The terminal is on the same side of the engine compartment as your battery. See “Engine Compartment Overview” in the Index for more information on location. You should always use the remote positive (+) terminal instead of the positive (+) terminal on your battery.



To uncover the remote positive (+) terminal, squeeze the sides of the red plastic cap and pull the cap toward you.

## CAUTION:

**Using a match near a battery can cause battery gas to explode. People have been hurt doing this, and some have been blinded. Use a flashlight if you need more light.**

**Be sure the battery has enough water. You don't need to add water to the ACDelco<sup>®</sup> battery installed in every new GM vehicle. But if a battery has filler caps, be sure the right amount of fluid is there. If it is low, add water to take care of that first. If you don't, explosive gas could be present.**

**Battery fluid contains acid that can burn you. Don't get it on you. If you accidentally get it in your eyes or on your skin, flush the place with water and get medical help immediately.**



**⚠ CAUTION:**

**Fans or other moving engine parts can injure you badly. Keep your hands away from moving parts once the engine is running.**

6. Check that the jumper cables don't have loose or missing insulation. If they do, you could get a shock. The vehicles could be damaged, too.



Before you connect the cables, here are some basic things you should know. Positive (+) will go to positive (+) and negative (-) will go to a heavy, unpainted metal engine part. Don't connect positive (+) to negative (-), or you'll get a short that would damage the battery and maybe other parts, too. Don't connect negative (-) to negative (-) on the dead battery, either, as this can cause sparks.



7. Connect the red positive (+) cable to the positive (+) terminal of the vehicle with the dead battery. Use a remote positive (+) terminal if the vehicle has one.



8. Don't let the other end touch metal. Connect it to the positive (+) terminal of the good battery. Use a remote positive (+) terminal if the vehicle has one.



9. Now connect the black negative (-) cable to the good battery's negative (-) terminal. Don't let the other end touch anything until the next step. The other end of the negative cable *doesn't* go to the dead battery.

It goes to a heavy, unpainted metal part on the engine of the vehicle with the dead battery.



10. Attach the cable at least 18 inches (45 cm) away from the dead battery, but not near engine parts that move. The electrical connection is just as good there, but the chance of sparks getting back to the battery is much less.
11. Now start the vehicle with the good battery and run the engine for a while.
12. Try to start the vehicle with the dead battery. If it won't start after a few tries, it probably needs service.

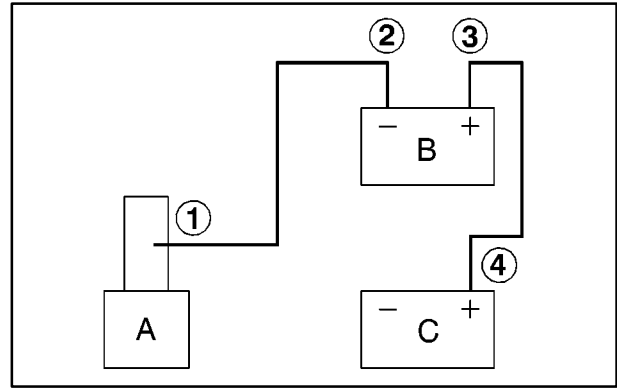

### Jumper Cable Removal Procedure

- A. Heavy, Unpainted Metal Engine Part
- B. Good Battery
- C. Dead Battery

To disconnect the jumper cables from both vehicles, do the following:

1. Disconnect the black negative (-) cable from the heavy, unpainted metal engine part on the vehicle that had the dead battery.
2. Disconnect the black negative (-) cable from the negative (-) terminal on the vehicle with the good battery.
3. Disconnect the red positive (+) cable from the vehicle with the good battery.
4. Disconnect the red positive (+) cable from the other vehicle.

## Towing Your Vehicle

Consult your dealer or a professional towing service if you need to have your vehicle towed. See “Roadside Assistance” and “Recreational Vehicle Towing” in the Index.

## Engine Overheating

You will find a coolant temperature gage and a warning light about a hot engine on your instrument panel cluster. See “Engine Coolant Temperature Gage” in the Index. You also have a low coolant light on your instrument panel cluster. See “Low Coolant Light” in the Index.

## Overheated Engine Protection Operating Mode

This emergency operating mode allows your vehicle to be driven to a safe place in an emergency situation. Should an overheated engine condition exist, an overheat protection mode which alternates firing groups of cylinders helps prevent engine damage. In this mode, you will notice a significant loss in power and engine performance. The low coolant light may come on and the temperature gage will indicate an overheat condition exists. Towing a trailer in the overheat protection mode should be avoided.

### **NOTICE:**

**After driving in the overheated engine protection operating mode, to avoid engine damage, allow the engine to cool before attempting any repair. The engine oil will be severely degraded. Repair the cause of coolant loss, change the oil and reset the oil life system. See “Engine Oil” in the Index.**

## If Steam Is Coming From Your Engine



### **⚠ CAUTION:**

Steam from an overheated engine can burn you badly, even if you just open the hood. Stay away from the engine if you see or hear steam coming from it. Just turn it off and get everyone away from the vehicle until it cools down. Wait until there is no sign of steam or coolant before you open the hood.

If you keep driving when your engine is overheated, the liquids in it can catch fire. You or others could be badly burned. Stop your engine if it overheats, and get out of the vehicle until the engine is cool. See “Overheated Engine Protection Operating Mode” in the Index.

## NOTICE:

**If your engine catches fire because you keep driving with no coolant, your vehicle can be badly damaged. The costly repairs would not be covered by your warranty. See “Overheated Engine Protection Operating Mode” in the Index.**

### If No Steam Is Coming From Your Engine

If you get an engine overheat warning but see or hear no steam, the problem may not be too serious. Sometimes the engine can get a little too hot when you:

- Climb a long hill on a hot day.
- Stop after high-speed driving.
- Idle for long periods in traffic.
- Tow a trailer.

If you get the overheat warning with no sign of steam, try this for a minute or so:

1. If your air conditioner is on, turn it off.
2. Turn on your heater to full hot at the highest fan speed and open the window as necessary.
3. If you're in a traffic jam, shift to NEUTRAL (N); otherwise, shift to the highest gear while driving -- AUTOMATIC OVERDRIVE (D) or THIRD (3).

If you no longer have the overheat warning, you can drive. Just to be safe, drive slower for about 10 minutes. If the warning doesn't come back on, you can drive normally.

If the warning continues, pull over, stop, and park your vehicle right away.

If there's still no sign of steam, idle the engine for three minutes while you're parked. If you still have the warning, *turn off the engine and get everyone out of the vehicle* until it cools down. Also, see “Overheated Engine Protection Operating Mode” listed previously in this section.

You may decide not to lift the hood but to get service help right away.

## Cooling System

When you decide it's safe to lift the hood, here's what you'll see:

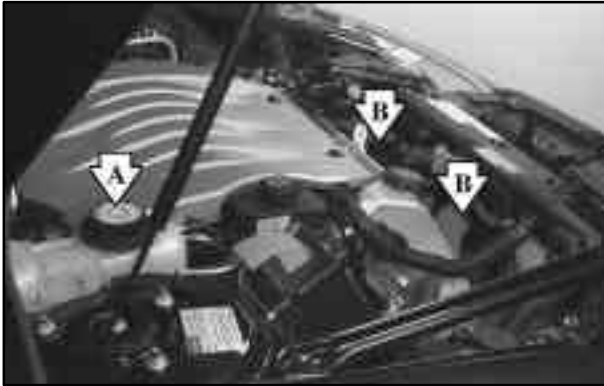

A. Coolant Surge Tank

B. Electric Engine Cooling Fans

### CAUTION:

**An electric engine cooling fan under the hood can start up even when the engine is not running and can injure you. Keep hands, clothing and tools away from any underhood electric fan.**

If the coolant inside the coolant surge tank is boiling, don't do anything else until it cools down.



When the engine is cold, the coolant level should be at or above the FULL COLD mark on the coolant surge tank. If it isn't, you may have a leak in the radiator hoses, heater hoses, radiator, water pump or somewhere else in the cooling system.

 **CAUTION:**

**Heater and radiator hoses, and other engine parts, can be very hot. Don't touch them. If you do, you can be burned.**

**Don't run the engine if there is a leak. If you run the engine, it could lose all coolant. That could cause an engine fire, and you could be burned. Get any leak fixed before you drive the vehicle.**

**NOTICE:**

**Engine damage from running your engine without coolant isn't covered by your warranty. See "Overheated Engine Protection Operating Mode" in the Index.**

**NOTICE:**

**When adding coolant, it is important that you use only DEX-COOL<sup>®</sup> (silicate-free) coolant. If coolant other than DEX-COOL is added to the system, premature engine, heater core or radiator corrosion may result. In addition, the engine coolant will require change sooner -- at 30,000 miles (50 000 km) or 24 months, whichever occurs first. Damage caused by the use of coolant other than DEX-COOL<sup>®</sup> is not covered by your new vehicle warranty.**

If there seems to be no leak, with the engine on, check to see if the electric engine cooling fans are running. If the engine is overheating, both fans should be running. If they aren't, your vehicle needs service.



## How to Add Coolant to the Coolant Surge Tank

If you haven't found a problem yet, but the coolant level isn't at the FULL COLD mark, add a 50/50 mixture of *clean, drinkable water* and DEX-COOL<sup>®</sup> coolant at the coolant surge tank, but be sure the cooling system, including the coolant surge tank pressure cap, is cool before you do it. See "Engine Coolant" in the Index for more information.

### CAUTION:

**Steam and scalding liquids from a hot cooling system can blow out and burn you badly. They are under pressure, and if you turn the coolant surge tank pressure cap -- even a little -- they can come out at high speed. Never turn the cap when the cooling system, including the coolant surge tank pressure cap, is hot. Wait for the cooling system and coolant surge tank pressure cap to cool if you ever have to turn the pressure cap.**



## **⚠ CAUTION:**

Adding only plain water to your cooling system can be dangerous. Plain water, or some other liquid like alcohol, can boil before the proper coolant mixture will. Your vehicle's coolant warning system is set for the proper coolant mixture. With plain water or the wrong mixture, your engine could get too hot but you wouldn't get the overheat warning. Your engine could catch fire and you or others could be burned. Use a 50/50 mixture of clean, drinkable water and DEX-COOL<sup>®</sup> coolant.

## **NOTICE:**

In cold weather, water can freeze and crack the engine, radiator, heater core and other parts. So use the recommended coolant.

## **⚠ CAUTION:**

You can be burned if you spill coolant on hot engine parts. Coolant contains ethylene glycol and it will burn if the engine parts are hot enough. Don't spill coolant on a hot engine.



1. You can remove the coolant surge tank pressure cap when the cooling system, including the coolant surge tank pressure cap and upper radiator hose, is no longer hot.

Turn the pressure cap slowly counterclockwise (left) about one-quarter turn and then stop.

If you hear a hiss, wait for that to stop. A hiss means there is still some pressure left.



2. Then keep turning the pressure cap slowly, and remove it.



3. Then fill the coolant surge tank with the proper mixture, to the FULL COLD mark.



4. With the coolant surge tank pressure cap off, start the engine and let it run until you can feel the upper radiator hose getting hot. Watch out for the engine cooling fans.

By this time, the coolant level inside the coolant surge tank may be lower. If the level is lower, add more of the proper mixture to the coolant surge tank until the level reaches the FULL COLD mark.



5. Then replace the pressure cap. Be sure the pressure cap is hand-tight.

## If a Tire Goes Flat

It's unusual for a tire to "blow out" while you're driving, especially if you maintain your tires properly. If air goes out of a tire, it's much more likely to leak out slowly. But if you should ever have a "blowout," here are a few tips about what to expect and what to do:

If a front tire fails, the flat tire will create a drag that pulls the vehicle toward that side. Take your foot off the accelerator pedal and grip the steering wheel firmly. Steer to maintain lane position, and then gently brake to a stop well out of the traffic lane.

A rear blowout, particularly on a curve, acts much like a skid and may require the same correction you'd use in a skid. In any rear blowout, remove your foot from the accelerator pedal. Get the vehicle under control by steering the way you want the vehicle to go. It may be very bumpy and noisy, but you can still steer. Gently brake to a stop -- well off the road if possible.

If a tire goes flat, the next part shows how to use your jacking equipment to change a flat tire safely.

## Changing a Flat Tire

If a tire goes flat, avoid further tire and wheel damage by driving slowly to a level place. Turn on your hazard warning flashers.

### CAUTION:

**Changing a tire can cause an injury. The vehicle can slip off the jack and roll over you or other people. You and they could be badly injured. Find a level place to change your tire. To help prevent the vehicle from moving:**

- 1. Set the parking brake firmly.**
- 2. Put the shift lever in PARK (P).**
- 3. Turn off the engine.**

**To be even more certain the vehicle won't move, you can put blocks at the front and rear of the tire farthest away from the one being changed. That would be the tire on the other side of the vehicle, at the opposite end.**

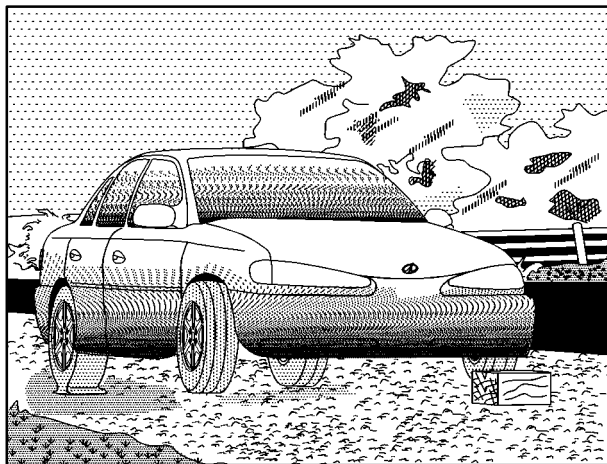

The following steps will tell you how to use the jack and change a tire.

## Removing the Spare Tire and Tools



The equipment you'll need is in the trunk.

Turn the center nut on the compact spare cover counterclockwise to remove it. Then lift and remove the cover.



Remove the spare tire. See “Compact Spare Tire” in the Index for more information about the compact spare.



Turn the nut holding the jack counterclockwise and remove it. Then remove the jack and wrench.



The tools you'll be using include the jack (A), extension and protector/guide (B) and wheel wrench (C).



## Removing the Flat Tire and Installing the Spare Tire



1. Using the wheel wrench, remove the plastic caps and loosen all of the wheel nuts. Don't remove them yet.

### CAUTION:

Getting under a vehicle when it is jacked up is dangerous. If the vehicle slips off the jack, you could be badly injured or killed. Never get under a vehicle when it is supported only by a jack.

### CAUTION:

Raising your vehicle with the jack improperly positioned can damage the vehicle and even make the vehicle fall. To help avoid personal injury and vehicle damage, be sure to fit the jack lift head into the proper location before raising the vehicle.

2. Turn the jack handle clockwise to raise the jack lift head a few inches.

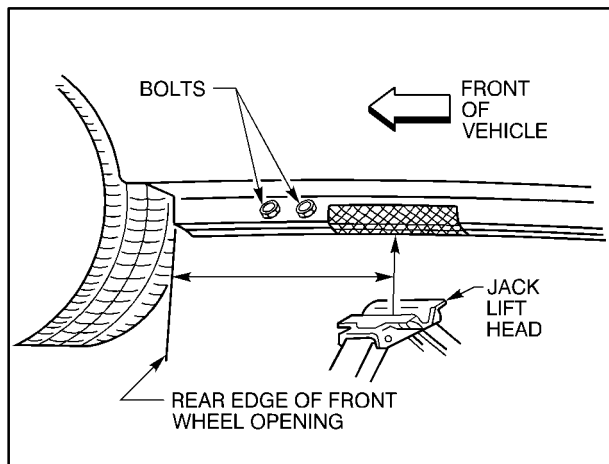

For jacking at the vehicle's front location, put the jack lift head about 8 inches (20 cm) from the rear edge of the front wheel opening or just behind the two bolts as shown.

Put the compact spare tire near you.

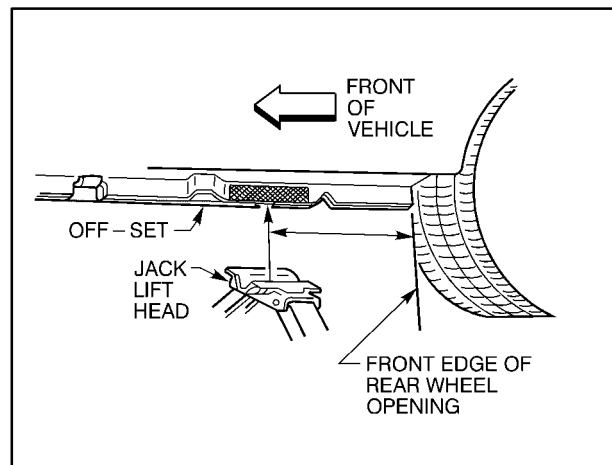

For jacking at the vehicle's rear location, put the jack lift head about 6 inches (15 cm) from the front edge of the rear wheel opening or just behind the off-set as shown.

Put the compact spare tire near you.



3. Raise the vehicle by turning the jack handle clockwise. Raise the vehicle far enough off the ground for the spare tire to fit under the vehicle.



4. Remove all wheel nuts and take off the flat tire.

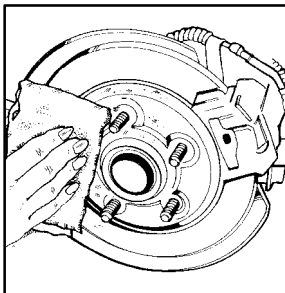

5. Remove any rust or dirt from the wheel bolts, mounting surfaces and spare wheel.

**⚠ CAUTION:**

Rust or dirt on the wheel, or on the parts to which it is fastened, can make the wheel nuts become loose after a time. The wheel could come off and cause an accident. When you change a wheel, remove any rust or dirt from the places where the wheel attaches to the vehicle. In an emergency, you can use a cloth or a paper towel to do this; but be sure to use a scraper or wire brush later, if you need to, to get all the rust or dirt off.

**⚠ CAUTION:**

Never use oil or grease on studs or nuts. If you do, the nuts might come loose. Your wheel could fall off, causing a serious accident.

6. Install the compact spare tire.



7. Reinstall the wheel nuts with the rounded end of the nuts toward the wheel. Tighten each nut by hand until the wheel is held against the hub.



8. Lower the vehicle by turning the jack handle counterclockwise. Lower the jack completely.

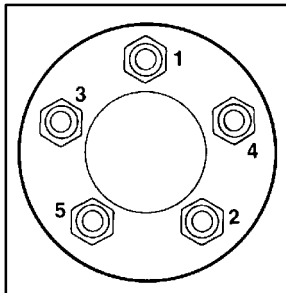

9. Tighten the wheel nuts firmly in a crisscross sequence as shown.

## CAUTION:

**Incorrect wheel nuts or improperly tightened wheel nuts can cause the wheel to become loose and even come off. This could lead to an accident. Be sure to use the correct wheel nuts. If you have to replace them, be sure to get new GM original equipment wheel nuts.**

**Stop somewhere as soon as you can and have the nuts tightened with a torque wrench to 100 lb-ft (140 N·m).**

## NOTICE:

**Improperly tightened wheel nuts can lead to brake pulsation and rotor damage. To avoid expensive brake repairs, evenly tighten the wheel nuts in the proper sequence and to the proper torque specification.**

10. Reinstall the plastic nut caps tightly by hand. Using the wheel wrench, tighten caps an additional one quarter turn.

## Storing the Flat Tire and Tools

### CAUTION:

Storing a jack, a tire or other equipment in the passenger compartment of the vehicle could cause injury. In a sudden stop or collision, loose equipment could strike someone. Store all these in the proper place.

After you've put the compact spare tire on your vehicle, you'll need to store the flat tire in your trunk. Use the following procedure to secure the flat tire in the trunk.



When storing a full-size tire, you must use the extension to help avoid wheel surface damage. Use the extension and protector/guide located in the foam holder. To store a full-size tire, place the tire in the trunk with the valve stem facing down and the protector/guide through a wheel bolt hole. Remove the protector and attach the retainer securely. When returning the compact spare to the trunk, put the protector/guide back in the foam holder. Store the cover as far forward as possible.

## Storing the Spare Tire and Tools

### CAUTION:

Storing a jack, a tire or other equipment in the passenger compartment of the vehicle could cause injury. In a sudden stop or collision, loose equipment could strike someone. Store all these in the proper place.

The compact spare is for temporary use only. Replace the compact spare tire with a full-size tire as soon as you can. See “Compact Spare Tire” in the Index. See the storage instructions label to replace your compact spare into your trunk properly.

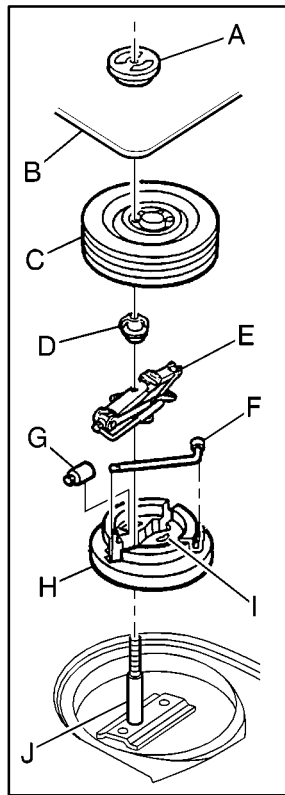

- A. Retainer
- B. Cover
- C. Compact Spare Tire
- D. Nut
- E. Jack
- F. Wrench
- G. Lock Nut Tool
- H. Foam Holder
- I. Extension and Protective Guide
- J. Bolt Screw

## Compact Spare Tire

Although the compact spare tire was fully inflated when your vehicle was new, it can lose air after a time. Check the inflation pressure regularly. It should be 60 psi (420 kPa).

After installing the compact spare on your vehicle, you should stop as soon as possible and make sure your spare tire is correctly inflated. The compact spare is made to perform well at speeds up to 65 mph (105 km/h) for distances up to 3,000 miles (5 000 km), so you can finish your trip and have your full-size tire repaired or replaced where you want. Of course, it's best to replace your spare with a full-size tire as soon as you can. Your spare will last longer and be in good shape in case you need it again.

### NOTICE:

**When the compact spare is installed, don't take your vehicle through an automatic car wash with guide rails. The compact spare can get caught on the rails. That can damage the tire and wheel, and maybe other parts of your vehicle.**

Don't use your compact spare on other vehicles.

And don't mix your compact spare tire or wheel with other wheels or tires. They won't fit. Keep your spare tire and its wheel together.

### NOTICE:

**Tire chains won't fit your compact spare. Using them can damage your vehicle and can damage the chains too. Don't use tire chains on your compact spare.**



## If You're Stuck: In Sand, Mud, Ice or Snow

In order to free your vehicle when it is stuck, you will need to spin the wheels, but you don't want to spin your wheels too fast. The method known as "rocking" can help you get out when you're stuck, but you must use caution.

### CAUTION:

**If you let your tires spin at high speed, they can explode, and you or others could be injured. And, the transaxle or other parts of the vehicle can overheat. That could cause an engine compartment fire or other damage. When you're stuck, spin the wheels as little as possible. Don't spin the wheels above 35 mph (55 km/h) as shown on the speedometer.**

### NOTICE:

**Spinning your wheels can destroy parts of your vehicle as well as the tires. If you spin the wheels too fast while shifting your transaxle back and forth, you can destroy your transaxle.**

For information about using tire chains on your vehicle, see "Tire Chains" in the Index.

## Rocking Your Vehicle To Get It Out

First, turn your steering wheel left and right. That will clear the area around your front wheels. If your vehicle has traction control, you should turn the system off. See "Traction Control System" in the Index. Then shift back and forth between REVERSE (R) and a forward gear, spinning the wheels as little as possible. Release the accelerator pedal while you shift, and press lightly on the accelerator pedal when the transaxle is in gear. By slowly spinning your wheels in the forward and reverse directions, you will cause a rocking motion that may free your vehicle. If that doesn't get you out after a few tries, you may need to be towed out. If you do need to be towed out, see "Towing Your Vehicle" in the Index.



## Section 6 Service and Appearance Care

---

Here you will find information about the care of your vehicle. This section begins with service and fuel information, and then it shows how to check important fluid and lubricant levels. There is also technical information about your vehicle, and a part devoted to its appearance care.

6-2	Service	6-33	Bulb Replacement
6-3	Fuel	6-42	Windshield Wiper Blade Replacement
6-5	Fuels in Foreign Countries	6-43	Tires
6-5	Filling Your Tank	6-51	Appearance Care
6-8	Filling a Portable Fuel Container	6-51	Cleaning the Inside of Your Vehicle
6-8	Checking Things Under the Hood	6-53	Care of Safety Belts
6-11	Engine Oil	6-55	Cleaning the Outside of Your Vehicle
6-16	Engine Air Cleaner/Filter	6-56	Cleaning Aluminum or Chrome-Plated Wheels (If Equipped)
6-18	Passenger Compartment Air Filter	6-57	Finish Damage
6-19	Automatic Transaxle Fluid	6-58	GM Vehicle Care/Appearance Materials
6-22	Engine Coolant	6-59	Vehicle Identification Number (VIN)
6-26	Cooling System Pressure Cap	6-59	Service Parts Identification Label
6-26	Power Steering Fluid	6-60	Electrical System
6-27	Windshield Washer Fluid	6-67	Replacement Bulbs
6-29	Brakes	6-67	Capacities and Specifications
6-32	Battery	6-68	Normal Maintenance Replacement Parts

## Service

Your dealer knows your vehicle best and wants you to be happy with it. We hope you'll go to your dealer for all your service needs. You'll get genuine GM parts and GM-trained and supported service people.

We hope you'll want to keep your GM vehicle all GM. Genuine GM parts have one of these marks:



## Doing Your Own Service Work

If you want to do some of your own service work, you'll want to use the proper service manual. It tells you much more about how to service your vehicle than this manual can. To order the proper service manual, see "Service and Owner Publications" in the Index.

Your vehicle has an air bag system. Before attempting to do your own service work, see "Servicing Your Air Bag-Equipped Vehicle" in the Index.

You should keep a record with all parts receipts and list the mileage and the date of any service work you perform. See "Maintenance Record" in the Index.

## CAUTION:

**You can be injured and your vehicle could be damaged if you try to do service work on a vehicle without knowing enough about it.**

- **Be sure you have sufficient knowledge, experience, the proper replacement parts and tools before you attempt any vehicle maintenance task.**
- **Be sure to use the proper nuts, bolts and other fasteners. “English” and “metric” fasteners can be easily confused. If you use the wrong fasteners, parts can later break or fall off. You could be hurt.**

## Adding Equipment to the Outside of Your Vehicle

Things you might add to the outside of your vehicle can affect the airflow around it. This may cause wind noise and affect windshield washer performance. Check with your dealer before adding equipment to the outside of your vehicle.

## Fuel

Use regular unleaded gasoline rated at 87 octane or higher. It is recommended that the gasoline meet specifications which were developed by the American Automobile Manufacturers Association (AAMA) and endorsed by the Canadian Motor Vehicle Manufacturers Association for better vehicle performance and engine protection. Gasolines meeting the AAMA specification could provide improved driveability and emission control system performance compared to other gasolines.



**Canada Only**

In Canada, look for the “Auto Makers’ Choice” label on the fuel pump.

Be sure the posted octane is at least 87. If the octane is less than 87, you may get a heavy knocking noise when you drive. If it's bad enough, it can damage your engine.

If you're using fuel rated at 87 octane or higher and you hear heavy knocking, your engine needs service. But don't worry if you hear a little pinging noise when you're accelerating or driving up a hill. That's normal, and you don't have to buy a higher octane fuel to get rid of pinging. It's the heavy, constant knock that means you have a problem.

If your vehicle is certified to meet California Emission Standards (indicated on the underhood emission control label), it is designed to operate on fuels that meet California specifications. If such fuels are not available in states adopting California emissions standards, your vehicle will operate satisfactorily on fuels meeting federal specifications, but emission control system performance may be affected. The malfunction indicator lamp on your instrument panel may turn on and/or your vehicle may fail a smog-check test. See "Malfunction Indicator Lamp" in the Index. If this occurs, return to your authorized Oldsmobile dealer for diagnosis to determine the cause of failure. In the event it is determined that the cause of the condition is the type of fuels used, repairs may not be covered by your warranty.

Some gasolines that are not reformulated for low emissions may contain an octane-enhancing additive called methylcyclopentadienyl manganese tricarbonyl (MMT); ask your service station operator whether or not the fuel contains MMT. General Motors does not recommend the use of such gasolines. If fuels containing MMT are used, spark plug life may be reduced and your emission control system performance may be affected. The malfunction indicator lamp on your instrument panel may turn on. If this occurs, return to your authorized Oldsmobile dealer for service.

To provide cleaner air, all gasolines in the United States are now required to contain additives that will help prevent deposits from forming in your engine and fuel system, allowing your emission control system to function properly. Therefore, you should not have to add anything to the fuel. In addition, gasolines containing oxygenates, such as ethers and ethanol, and reformulated gasolines may be available in your area to contribute to clean air. General Motors recommends that you use these gasolines, particularly if they comply with the specifications described earlier.

## NOTICE:

Your vehicle was not designed for fuel that contains methanol. Don't use it. It can corrode metal parts in your fuel system and also damage plastic and rubber parts. That damage wouldn't be covered under your warranty.

## Fuels in Foreign Countries

If you plan on driving in another country outside the United States or Canada, the proper fuel may be hard to find. Never use leaded gasoline or any other fuel not recommended in the previous text on fuel. Costly repairs caused by use of improper fuel wouldn't be covered by your warranty.

To check on fuel availability, ask an auto club, or contact a major oil company that does business in the country where you'll be driving.

## Filling Your Tank

### ⚠ CAUTION:

Gasoline vapor is highly flammable. It burns violently, and that can cause very bad injuries. Don't smoke if you're near gasoline or refueling your vehicle. Keep sparks, flames and smoking materials away from gasoline.



The tethered cap is located behind a hinged door on the driver's side of your vehicle.



While refueling, let the cap hang by the tether below the fuel fill opening.

To remove the cap, turn it slowly to the left (counterclockwise). The cap has a spring in it; if you let go of the cap too soon, it will spring back to the right.

**⚠ CAUTION:**

**If you get gasoline on yourself and then something ignites it, you could be badly burned. Gasoline can spray out on you if you open the fuel filler cap too quickly. This spray can happen if your tank is nearly full, and is more likely in hot weather. Open the fuel filler cap slowly and wait for any “hiss” noise to stop. Then unscrew the cap all the way.**

Be careful not to spill gasoline. Clean gasoline from painted surfaces as soon as possible. See “Cleaning the Outside of Your Vehicle” in the Index.

When you put the cap back on, turn it to the right (clockwise) until you hear a clicking sound. Make sure you fully install the cap. The diagnostic system can determine if the fuel cap has been left off or improperly installed. This would allow fuel to evaporate into the atmosphere. See “Malfunction Indicator Lamp” in the Index.

## **NOTICE:**

**If you need a new cap, be sure to get the right type. Your dealer can get one for you. If you get the wrong type, it may not fit properly. This may cause your malfunction indicator lamp to light and your fuel tank and emissions system may be damaged. See “Malfunction Indicator Lamp” in the Index.**



## Filling a Portable Fuel Container

### CAUTION:

Never fill a portable fuel container while it is in your vehicle. Static electricity discharge from the container can ignite the gasoline vapor. You can be badly burned and your vehicle damaged if this occurs. To help avoid injury to you and others:

- Dispense gasoline only into approved containers.
- Do not fill a container while it is inside a vehicle, in a vehicle's trunk, pickup bed or on any surface other than the ground.
- Bring the fill nozzle in contact with the inside of the fill opening before operating the nozzle. Contact should be maintained until the filling is complete.
- Don't smoke while pumping gasoline.

## Checking Things Under the Hood

### CAUTION:

An electric fan under the hood can start up and injure you even when the engine is not running. Keep hands, clothing and tools away from any underhood electric fan.

### CAUTION:

Things that burn can get on hot engine parts and start a fire. These include liquids like gasoline, oil, coolant, brake fluid, windshield washer and other fluids, and plastic or rubber. You or others could be burned. Be careful not to drop or spill things that will burn onto a hot engine.

## Hood Release



To open the hood, first pull the handle inside the vehicle. It is located below the instrument panel on the driver's side.

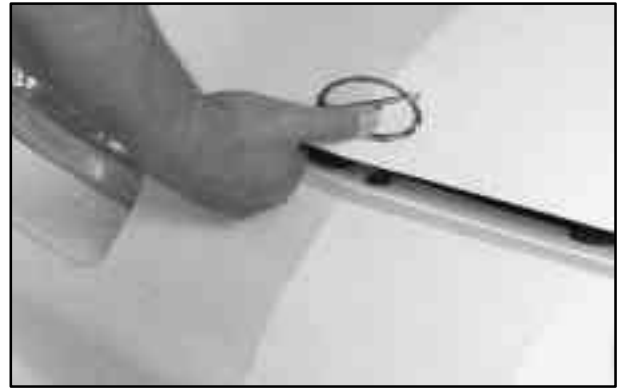

Then go to the front of the vehicle and release the secondary hood latch. Lift the hood.

## Engine Compartment Overview

When you open the hood of the 3.5L V6 engine, you'll see:

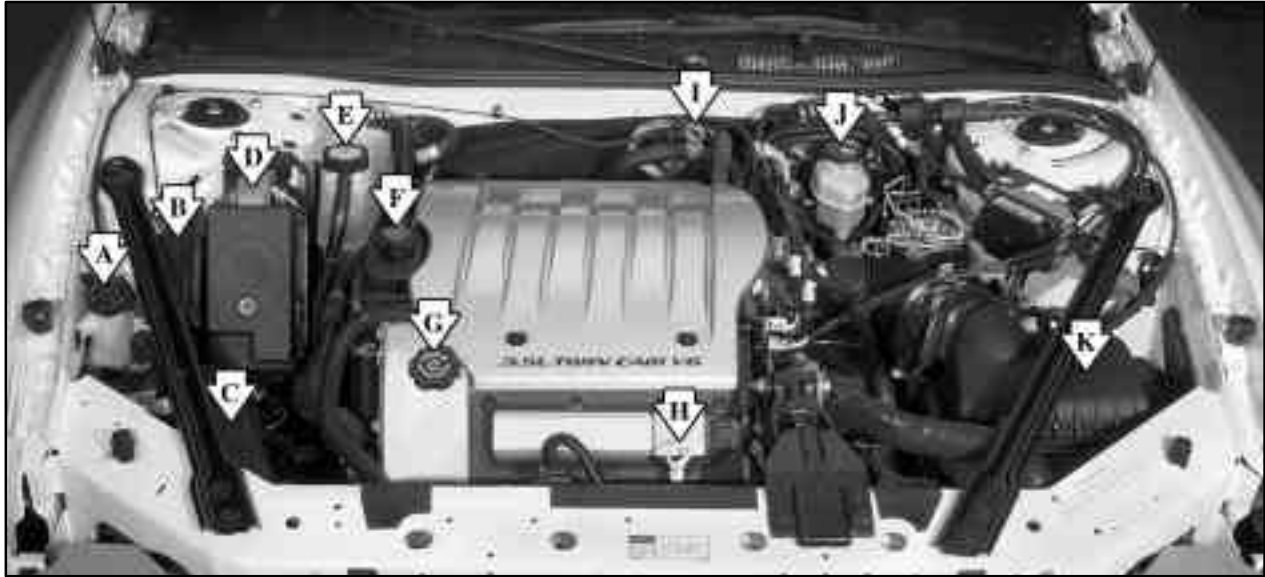

- A. Windshield Washer Fluid Reservoir
- B. Accessory Wiring Junction Fuse Block
- C. Battery

- D. Remote Positive (+) Terminal
- E. Engine Coolant Surge Tank
- F. Power Steering Fluid Reservoir
- G. Engine Oil Fill Cap
- H. Engine Oil Dipstick

- I. Automatic Transaxle Fluid Dipstick
- J. Brake Fluid Reservoir
- K. Engine Air Cleaner/Filter

Before closing the hood, be sure that all the filler caps are on properly. Then pull the hood down and close it firmly.

## Engine Oil



**LOW  
OIL**

If the LOW OIL message appears on the instrument panel, it means you need to check your engine oil level right away. For more information, see “Low Oil Light” in the Index.

You should check your engine oil level regularly; this is an added reminder.

## Checking Engine Oil

It's a good idea to check your engine oil every time you get fuel. In order to get an accurate reading, the oil must be warm and the vehicle must be on level ground.



The engine oil dipstick handle is the yellow loop located near the front of the engine. See “Engine Compartment Overview” in the Index for more information on location.

Turn off the engine and give the oil several minutes to drain back into the oil pan. If you don't, the oil dipstick might not show the actual level.

Pull out the dipstick and clean it with a paper towel or cloth, then push it back in all the way. Remove it again, keeping the tip down, and check the level.



## When to Add Engine Oil

If the oil is at or below the ADD mark, then you'll need to add at least one quart of oil. But you must use the right kind. This part explains what kind of oil to use. For crankcase capacity, see "Capacities and Specifications" in the Index.

## NOTICE:

**Don't add too much oil. If your engine has so much oil that the oil level gets above the FULL mark that shows the proper operating range, your engine could be damaged.**



The engine oil fill cap is located toward the front of the engine compartment near the yellow looped engine oil dipstick. See "Engine Compartment Overview" in the Index for more information on location.

Be sure to fill it enough to put the level somewhere in the proper operating range. Push the dipstick all the way back in when you're through.

## What Kind of Engine Oil to Use

Oils recommended for your vehicle can be identified by looking for the starburst symbol.

This symbol indicates that the oil has been certified by the American Petroleum Institute (API). Do not use any oil which does not carry this starburst symbol.



If you change your own oil, be sure you use oil that has the starburst symbol on the front of the oil container. If you have your oil changed for you, be sure the oil put into your engine is American Petroleum Institute certified for gasoline engines.

You should also use the proper viscosity oil for your vehicle, as shown in the following chart:

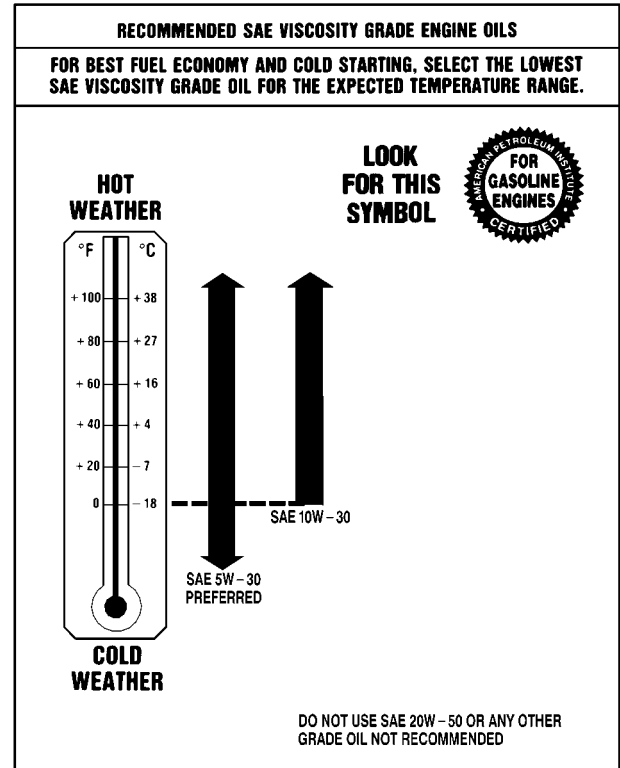

As in the chart shown previously, SAE 5W-30 is best for your vehicle. However, you can use SAE 10W-30 if it's going to be 0°F (-18°C) or above. These numbers on an oil container show its viscosity, or thickness. Do not use other viscosity oils, such as SAE 20W-50.

## NOTICE:

**Use only engine oil with the American Petroleum Institute Certified For Gasoline Engines starburst symbol. Failure to use the recommended oil can result in engine damage not covered by your warranty.**

GM Goodwrench<sup>®</sup> oil meets all the requirements for your vehicle.

If you are in an area where the temperature falls below -20°F (-29°C), consider using either an SAE 5W-30 synthetic oil or an SAE 0W-30 oil. Both will provide easier cold starting and better protection for your engine at extremely low temperatures.

## Engine Oil Additives

Don't add anything to your oil. The recommended oils with the starburst symbol are all you will need for good performance and engine protection.

## When to Change Engine Oil

Your vehicle has a computer that lets you know when to change your engine oil. This is not based on mileage, but on engine revolutions and engine operating temperature. When the computer has calculated that the oil needs changing, the GM Oil Life System™ will indicate that a change is necessary. The mileage between oil and filter changes will vary depending on how you drive your vehicle -- usually between 3,000 miles (5 000 km) and 10,000 miles (16 000 km) since your last oil and filter change. Under severe conditions, the system may come on before 3,000 miles (5 000 km). Never drive your vehicle more than 10,000 miles (16 000 km) or 12 months (whichever occurs first) without an oil change.

The system won't detect dust in the oil. So, if you drive in a dusty area, be sure to change your oil and filter every 3,000 miles (5 000 km) or sooner. Remember to reset the CHANGE OIL light whenever the oil is changed.

## How to Reset the CHANGE OIL Light

After changing the engine oil, the system must be reset. To reset the CHANGE OIL light after an oil change do the following:

1. With the ignition key turned to ON, but the engine off, fully push and release the accelerator pedal slowly three times within five seconds.  
If the CHANGE OIL light flashes, the system is resetting.
2. Turn the key to OFF after the light has finished flashing, then start the vehicle. If the CHANGE OIL light comes back on, the engine oil life system has not reset. Repeat the procedure.

## What to Do with Used Oil

Did you know that used engine oil contains certain elements that may be unhealthy for your skin and could even cause cancer? Don't let used oil stay on your skin for very long. Clean your skin and nails with soap and water, or a good hand cleaner. Wash or properly throw away clothing or rags containing used engine oil. See the manufacturer's warnings about the use and disposal of oil products.

Used oil can be a real threat to the environment. If you change your own oil, be sure to drain all free-flowing oil from the filter before disposal. Don't ever dispose of oil by putting it in the trash, pouring it on the ground, into sewers, or into streams or bodies of water. Instead, recycle it by taking it to a place that collects used oil. If you have a problem properly disposing of your used oil, ask your dealer, a service station or a local recycling center for help.



## Engine Air Cleaner/Filter

The engine air cleaner/filter is located on the driver's side near the front of the engine compartment. See "Engine Compartment Overview" in the Index for more information on location.

To check or replace the engine air cleaner/filter do the following:



1. Using a screwdriver, loosen the bolt on the air duct clamp from the throttle body.
2. Remove the air duct from the throttle body.



3. Unhook the two hold-down clips located on the air box cover.
4. Lift the air box cover and air duct assembly away from the air box, toward the engine.



5. Hold the air box cover and air duct assembly up in position while removing the old air filter element from the air box.
6. To install the new engine air cleaner/filter, reverse the steps.

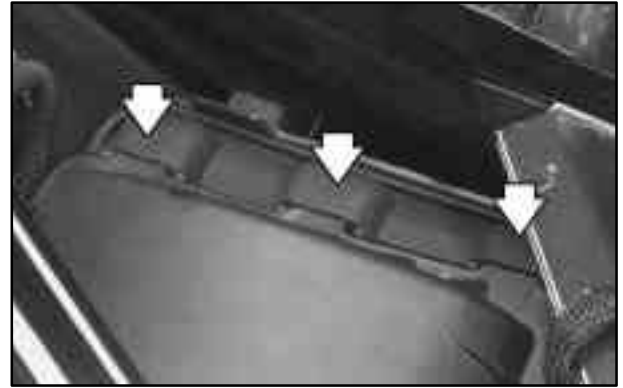

Be sure the tabs on the cover are inserted into the air box slots.

Refer to the Maintenance Schedule to determine when to replace the air filter.

See “Scheduled Maintenance Services” in the Index.

## **⚠ CAUTION:**

Operating the engine with the air cleaner/filter off can cause you or others to be burned. The air cleaner not only cleans the air, it stops flame if the engine backfires. If it isn't there, and the engine backfires, you could be burned. Don't drive with it off, and be careful working on the engine with the air cleaner/filter off.

## **NOTICE:**

If the air cleaner/filter is off, a backfire can cause a damaging engine fire. And, dirt can easily get into your engine, which will damage it. Always have the air cleaner/filter in place when you're driving.

## **Passenger Compartment Air Filter**

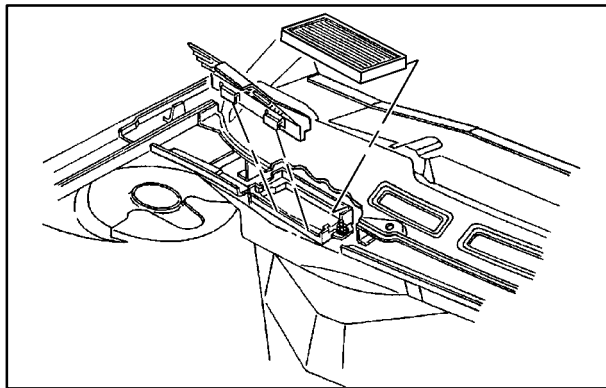

The passenger compartment air filter is located underneath the hood just below the windshield wiper arm on the passenger's side of the vehicle (underneath the air inlet grille).

The filter traps most of the pollen from air entering the module. Like your engine's air cleaner/filter, it may need to be changed periodically. For information on how often to change the passenger compartment air filter, see "Maintenance Schedule" in the Index.

To change the passenger compartment air filter, use the following steps:

1. Turn off the ignition when the windshield wipers are in the up position.
2. Raise the hood.
3. Disconnect the windshield washer pump hose from the fender rail and air inlet grille.
4. Peel back the hood weatherstrip on the right side of the vehicle halfway to center.
5. Remove the air inlet grille retainers.
6. Remove the air inlet grille.
7. Remove the air deflector grille in the compartment.
8. Remove the old passenger compartment air filter.
9. Then reverse the steps to install the new air filter.

## **Automatic Transaxle Fluid**

### **When to Check and Change**

A good time to check your automatic transaxle fluid level is when the engine oil is changed.

Change both the fluid and filter every 50,000 miles (83 000 km) if the vehicle is mainly driven under one or more of these conditions:

- In heavy city traffic where the outside temperature regularly reaches 90°F (32°C) or higher.
- In hilly or mountainous terrain.
- When doing frequent trailer towing.
- Uses such as found in taxi, police or delivery service.

If you do not use your vehicle under any of these conditions, change the fluid and filter at 100,000 miles (166 000 km).

See “Scheduled Maintenance Services” in the Index.

## How to Check

Because this operation can be a little difficult, you may choose to have this done at the dealership service department.

If you do it yourself, be sure to follow all the instructions here, or you could get a false reading on the dipstick.

### NOTICE:

**Too much or too little fluid can damage your transaxle. Too much can mean that some of the fluid could come out and fall on hot engine parts or exhaust system parts, starting a fire. Be sure to get an accurate reading if you check your transaxle fluid.**

Wait at least 30 minutes before checking the transaxle fluid level if you have been driving:

- When outside temperatures are above 90°F (32°C).
- At high speed for quite a while.

- In heavy traffic -- especially in hot weather.
- While pulling a trailer.

To get the right reading, the fluid should be at normal operating temperature, which is 180°F to 200°F (82°C to 93°C).

Get the vehicle warmed up by driving about 15 miles (24 km) when outside temperatures are above 50°F (10°C). If it's colder than 50°F (10°C), you may have to drive longer.

### Checking the Fluid Level

Prepare your vehicle as follows:

- Park your vehicle on a level place. Keep the engine running.
- With the parking brake applied, place the shift lever in PARK (P).
- With your foot on the brake pedal, move the shift lever through each gear range, pausing for about three seconds in each range. Then, position the shift lever in PARK (P).
- Let the engine run at idle for three to five minutes.

Then, without shutting off the engine, follow these steps:



The transaxle fluid dipstick handle is the red loop near the rear of the engine compartment. See “Engine Compartment Overview” in the Index for more information on location.

1. Pull out the dipstick and wipe it with a clean rag or paper towel.
2. Push it back in all the way, wait three seconds and then pull it back out again.



3. Check both sides of the dipstick, and read the lower level. The fluid level must be in the cross-hatched area.
4. If the fluid level is in the acceptable range, push the dipstick back in all the way.

## How to Add Fluid

Refer to the Maintenance Schedule to determine what kind of transaxle fluid to use. See “Recommended Fluids and Lubricants” in the Index.

If the fluid level is low, add only enough of the proper fluid to bring the level into the cross-hatched area on the dipstick.

1. Pull out the dipstick.
2. Using a long-neck funnel, add enough fluid at the dipstick hole to bring it to the proper level.

It doesn't take much fluid, generally less than one pint (0.5 L). *Don't overfill.*

### NOTICE:

**We recommend you use only fluid labeled DEXRON®-III, because fluid with that label is made especially for your automatic transaxle. Damage caused by fluid other than DEXRON®-III is not covered by your new vehicle warranty.**

3. After adding fluid, recheck the fluid level as described under “How to Check.”
4. When the correct fluid level is obtained, push the dipstick back in all the way.

## Engine Coolant

The cooling system in your vehicle is filled with DEX-COOL® engine coolant. This coolant is designed to remain in your vehicle for 5 years or 150,000 miles (240 000 km), whichever occurs first, if you add only DEX-COOL® extended life coolant.

The following explains your cooling system and how to add coolant when it is low. If you have a problem with engine overheating or if you need to add coolant to your radiator, see “Engine Overheating” in the Index.

A 50/50 mixture of clean, drinkable water and DEX-COOL<sup>®</sup> coolant will:

- Give freezing protection down to -34°F (-37°C).
- Give boiling protection up to 265°F (129°C).
- Protect against rust and corrosion.
- Help keep the proper engine temperature.
- Let the warning lights and gages work as they should.

## NOTICE:

**When adding coolant, it is important that you use only DEX-COOL<sup>®</sup> (silicate-free) coolant.**

**If coolant other than DEX-COOL is added to the system, premature engine, heater core or radiator corrosion may result. In addition, the engine coolant will require change sooner -- at 30,000 miles (50 000 km) or 24 months, whichever occurs first. Damage caused by the use of coolant other than DEX-COOL<sup>®</sup> is not covered by your new vehicle warranty.**

## What to Use

Use a mixture of one-half *clean, drinkable water* and one-half DEX-COOL<sup>®</sup> coolant which won't damage aluminum parts. If you use this coolant mixture, you don't need to add anything else.

### CAUTION:

**Adding only plain water to your cooling system can be dangerous. Plain water, or some other liquid like alcohol, can boil before the proper coolant mixture will. Your vehicle's coolant warning system is set for the proper coolant mixture. With plain water or the wrong mixture, your engine could get too hot but you wouldn't get the overheat warning. Your engine could catch fire and you or others could be burned. Use a 50/50 mixture of clean, drinkable water and DEX-COOL<sup>®</sup> coolant.**



## **NOTICE:**

**If you use an improper coolant mixture, your engine could overheat and be badly damaged. The repair cost wouldn't be covered by your warranty. Too much water in the mixture can freeze and crack the engine, radiator, heater core and other parts.**

If you have to add coolant more than four times a year, have your dealer check your cooling system.

## **NOTICE:**

**If you use the proper coolant, you don't have to add extra inhibitors or additives which claim to improve the system. These can be harmful.**

## Checking Coolant



The coolant surge tank is located in the engine compartment toward the rear of the engine on the passengers' side of the vehicle. See "Engine Compartment Overview" in the Index for more information on location.

 **CAUTION:**

**Turning the surge tank pressure cap when the engine and radiator are hot can allow steam and scalding liquids to blow out and burn you badly. Never turn the surge tank pressure cap -- even a little -- when the engine and radiator are hot.**

The vehicle must be on a level surface. When your engine is cold, the coolant level should be at the FULL COLD mark.



If the low coolant warning light comes on and stays on, it means you're low on engine coolant.

### Adding Coolant

If you need more coolant, add the proper DEX-COOL<sup>®</sup> coolant mixture *at the surge tank*, but only when the engine is cool.

 **CAUTION:**

**You can be burned if you spill coolant on hot engine parts. Coolant contains ethylene glycol, and it will burn if the engine parts are hot enough. Don't spill coolant on a hot engine.**

When replacing the pressure cap, make sure it is hand-tight.

## Cooling System Pressure Cap

The cooling system pressure cap is located on the surge tank.

### **NOTICE:**

**Your cooling system pressure cap is a 15 psi (105 kPa) pressure-type cap and must be tightly installed to prevent coolant loss and possible engine damage from overheating.**

## Power Steering Fluid



The power steering fluid reservoir is toward the middle of the engine compartment, on the passenger's side. See "Engine Compartment Overview" in the Index for more information on location.

### **When to Check Power Steering Fluid**

It is not necessary to regularly check power steering fluid unless you suspect there is a leak in the system or you hear an unusual noise. A fluid loss in this system could indicate a problem. Have the system inspected and repaired.

## How to Check Power Steering Fluid

Turn the key off, let the engine compartment cool down, wipe the cap and the top of the reservoir clean, then unscrew the cap and wipe the dipstick with a clean rag. Replace the cap and completely tighten it. Then remove the cap again and look at the fluid level on the dipstick.



The level should be at the the cross-hatched area. If necessary, add only enough fluid to bring the level up to the mark.

## What to Use

To determine what kind of fluid to use, see “Recommended Fluids and Lubricants” in the Index. Always use the proper fluid. Failure to use the proper fluid can cause leaks and damage hoses and seals.

## Windshield Washer Fluid

### What to Use

When you need windshield washer fluid, be sure to read the manufacturer’s instructions before use. If you will be operating your vehicle in an area where the temperature may fall below freezing, use a fluid that has sufficient protection against freezing.

### Adding Washer Fluid

**LOW  
WASHER  
FLUID**

If the windshield washer fluid level in your vehicle is low, the LOW WASHER FLUID warning light located on the instrument panel will come on. You will need to add fluid soon.



The windshield washer fluid reservoir is located on the passenger's side of the engine compartment near the diagonal cross brace. See "Engine Compartment Overview" in the Index for more information on location.

Open the cap labeled **WASHER FLUID ONLY**.  
Add washer fluid until the tank is full.

## **NOTICE:**

- **When using concentrated washer fluid, follow the manufacturer's instructions for adding water.**
- **Don't mix water with ready-to-use washer fluid. Water can cause the solution to freeze and damage your washer fluid tank and other parts of the washer system. Also, water doesn't clean as well as washer fluid.**
- **Fill your washer fluid tank only three-quarters full when it's very cold. This allows for expansion if freezing occurs, which could damage the tank if it is completely full.**
- **Don't use engine coolant (antifreeze) in your windshield washer. It can damage your washer system and paint.**

## Brakes

### Brake Fluid



Your brake master cylinder reservoir is on the driver's side of the engine compartment. See "Engine Compartment Overview" in the Index. It is filled with DOT-3 brake fluid.

There are only two reasons why the brake fluid level in the reservoir might go down. The first is that the brake fluid goes down to an acceptable level during normal brake lining wear. When new linings are put in, the fluid level

goes back up. The other reason is that fluid is leaking out of the brake system. If it is, you should have your brake system fixed, since a leak means that sooner or later your brakes won't work well, or won't work at all.

So, it isn't a good idea to "top off" your brake fluid. Adding brake fluid won't correct a leak. If you add fluid when your linings are worn, then you'll have too much fluid when you get new brake linings. You should add (or remove) brake fluid, as necessary, only when work is done on the brake hydraulic system.

#### CAUTION:

**If you have too much brake fluid, it can spill on the engine. The fluid will burn if the engine is hot enough. You or others could be burned, and your vehicle could be damaged. Add brake fluid only when work is done on the brake hydraulic system.**

When your brake fluid falls to a low level, your brake warning light will come on. See "Brake System Warning Light" in the Index.

## What to Add

When you do need brake fluid, use only DOT-3 brake fluid. Use new brake fluid from a sealed container only. Refer to “Recommended Fluids and Lubricants” in the Maintenance Schedule.

Always clean the brake fluid reservoir cap and the area around the cap before removing it. This will help keep dirt from entering the reservoir.

### CAUTION:

**With the wrong kind of fluid in your brake system, your brakes may not work well, or they may not even work at all. This could cause a crash. Always use the proper brake fluid.**

### NOTICE:

- **Using the wrong fluid can badly damage brake system parts. For example, just a few drops of mineral-based oil, such as engine oil, in your brake system can damage brake system parts so badly that they’ll have to be replaced. Don’t let someone put in the wrong kind of fluid.**
- **If you spill brake fluid on your vehicle’s painted surfaces, the paint finish can be damaged. Be careful not to spill brake fluid on your vehicle. If you do, wash it off immediately. See “Appearance Care” in the Index.**

## Brake Wear

Your vehicle has four-wheel disc brakes.

Disc brake pads have built-in wear indicators that make a high-pitched warning sound when the brake pads are worn and new pads are needed. The sound may come and go or be heard all the time your vehicle is moving (except when you are pushing on the brake pedal firmly).

### CAUTION:

**The brake wear warning sound means that soon your brakes won't work well. That could lead to an accident. When you hear the brake wear warning sound, have your vehicle serviced.**

### NOTICE:

**Continuing to drive with worn-out brake pads could result in costly brake repair.**

Some driving conditions or climates may cause a brake squeal when the brakes are first applied or lightly applied. This does not mean something is wrong with your brakes.

Properly torqued wheel nuts are necessary to help prevent brake pulsation. When tires are rotated, inspect brake pads for wear and evenly tighten wheel nuts in the proper sequence to GM torque specifications.

Brake linings should always be replaced as complete axle sets.

See “Brake System Inspection” in Section 7 of this manual under Part C “Periodic Maintenance Inspections.”

## Brake Pedal Travel

See your dealer if the brake pedal does not return to normal height, or if there is a rapid increase in pedal travel. This could be a sign of brake trouble.

## Brake Adjustment

Every time you apply the brakes, with or without the vehicle moving, your brakes adjust for wear.



## Replacing Brake System Parts

The braking system on a vehicle is complex. Its many parts have to be of top quality and work well together if the vehicle is to have really good braking. Your vehicle was designed and tested with top-quality GM brake parts. When you replace parts of your braking system -- for example, when your brake linings wear down and you have to have new ones put in -- be sure you get new approved GM replacement parts. If you don't, your brakes may no longer work properly. For example, if someone puts in brake linings that are wrong for your vehicle, the balance between your front and rear brakes can change -- for the worse. The braking performance you've come to expect can change in many other ways if someone puts in the wrong replacement brake parts.

## Battery

Your new vehicle comes with a maintenance free ACDelco® battery. When it's time for a new battery, get one that has the replacement number shown on the original battery's label. We recommend an ACDelco battery. See "Engine Compartment Overview" in the Index for battery location.

**WARNING:** Battery posts, terminals and related accessories contain lead and lead compounds, chemicals known to the State of California to cause cancer and reproductive harm. Wash hands after handling.

## Vehicle Storage

If you're not going to drive your vehicle for 25 days or more, remove the black, negative (-) cable from the battery. This will help keep your battery from running down.

### CAUTION:

**Batteries have acid that can burn you and gas that can explode. You can be badly hurt if you aren't careful. See "Jump Starting" in the Index for tips on working around a battery without getting hurt.**

Contact your dealer to learn how to prepare your vehicle for longer storage periods.

Also, for your audio system, see "Theft-Deterrent Feature" in the Index.

## Bulb Replacement

For any bulb changing procedure not listed in this section, contact the service department of your Oldsmobile dealer.

For the proper type of replacement bulb, see “Replacement Bulbs” in the Index.

## Halogen Bulbs

### CAUTION:

**Halogen bulbs have pressurized gas inside and can burst if you drop or scratch the bulb. You or others could be injured. Be sure to read and follow the instructions on the bulb package.**

## Headlamps

Follow these steps to replace the headlamps:

1. Open the hood.



2. Pull straight up on the two headlamp retainers to release the assembly locator tabs and take the retainers off. At the same time, hold the headlamp assembly in position by applying a little pressure against the headlamp lens. This prevents the lamp from falling out.



3. Slide the lamp assembly toward you.



4. Remove the rubber access cover from behind the bulb you are replacing.
5. Turn the bulb socket counterclockwise and remove it from the lamp.



6. Replace the bulb, making sure you don't touch the bulb with your bare hands.
7. Reverse Steps 1 through 5 to reinstall the headlamp assembly.
8. Close the hood. Then check the lamps.

## Headlamp Aiming



Your vehicle has a headlamp system equipped with horizontal and vertical aim indicators. The aim has been pre-set at the factory and should need no further adjustment. This is true even though your vertical and horizontal aim indicators may not fall exactly on the “0” (zero) marks on their scales.

If your vehicle is damaged in an accident, the headlamp aim may be affected. Aim adjustment may be necessary if it is difficult to see lane markers (for horizontal aim), or if oncoming drivers flash their high beams at you (for vertical aim). If you believe your headlamps need to be re-aimed, we recommend that you take it to your dealer for service; however, it is possible for you to re-aim your headlamps as described in the following procedure.

## **NOTICE:**

**To make sure your headlamps are aimed properly, read all the instructions before beginning. Failure to follow these instructions could cause damage to headlamp parts.**

To check the aim, the vehicle should be properly prepared as follows:

- The vehicle must have all four tires on a perfectly level surface.
- If necessary, pads may be used on an uneven surface.
- The vehicle should not have any snow, ice or mud attached to it.
- The vehicle should be fully assembled and all other work stopped while headlamp aiming is being done.
- There should not be any cargo or loading of the vehicle, except it should have a full tank of fuel and one person or 160 lbs. (75 kg) on the driver's seat.
- Close all doors.
- Tires should be properly inflated.
- Rock the vehicle to stabilize the suspension.



A. Horizontal Aim Adjustment Screw

B. Vertical Aim Adjustment Screw

Start with the horizontal aim. The adjustment screws can be turned with an E8 Torx<sup>®</sup> socket.

Once the horizontal aim is adjusted, then adjust the vertical aim.



A. Horizontal Aim Adjustment Screw (shown in previous photo)

B. Vertical Aim Adjustment Screw

C. Horizontal Block Index Plate

D. Vertical Aiming Level

1. Turn the horizontal aiming screw until the indicator is lined up with zero.
2. Turn the vertical aiming screw until the level bubble is lined up with zero.

## Front Parking, Sidemarkers and Turn Signal Cornering Lamps

1. Remove the headlamp assembly. Refer to the removal procedure listed under “Headlamps” earlier in this section.
2. Remove the rubber access cover.
3. Twist and pull the bulb socket from the headlamp assembly.
4. Holding the base of the bulb, pull the old bulb from the socket.
5. Push the new bulb into the socket.
6. Put the bulb socket back into the headlamp assembly and turn it clockwise until it is secure.
7. Reinstall the rubber access cover.

## Fog Lamps

1. Remove the deflector located below the front fascia by removing the two bolts.

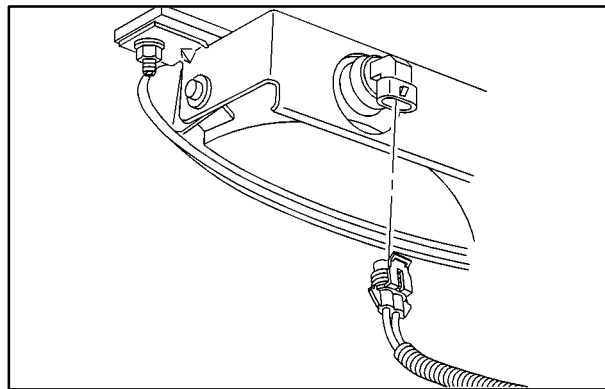

2. Reach up from underneath the front of the vehicle and remove the electrical connector from the bulb assembly.
3. Turn the bulb socket a quarter turn counterclockwise to remove.
4. Remove the old bulb from the socket.
5. Place the new bulb into the socket.
6. Reverse Steps 1 through 3 to reinstall.

## Center High-Mounted Stoplamp (CHMSL)

1. Open the trunk.



2. Reach through the access opening in the trunk.



3. Remove the old bulb from the socket by turning it one quarter turn counterclockwise.
4. Place the new bulb into the socket.
5. Turn the bulb one quarter turn clockwise to install.
6. Close the trunk.



## Tail/Stop/Turn Signal Lamps

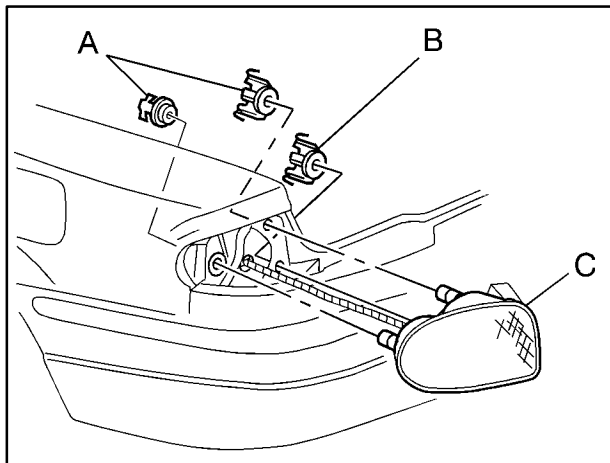

1. Unscrew the wing nut inside of the trunk (B) behind the taillamp to be changed. If equipped with a convenience net, unhook the net.
2. Pull back the carpeting.
3. Remove the other two plastic wing nuts (A). Pliers may be required to remove the wing nuts.
4. Pull the taillamp housing away from the body of the vehicle (C).
5. Squeeze the tab on the bulb socket and turn the socket counterclockwise.
6. Pull out the bulb socket.
7. Pull the old bulb out of the socket. (There are four bulbs on each taillamp.)
8. Push in a new bulb.
9. Reinstall the bulb socket into the housing and turn it clockwise.
10. Reinstall the taillamp housing to the body of the vehicle.
11. Reinstall all three wing nuts.
12. Tighten the plastic wing nuts.

## License Plate Lamp

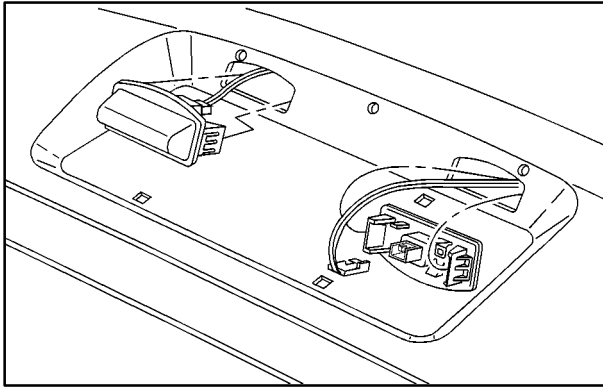

1. Remove the four screws to remove the name plate.
2. Reach your hand up through underside of the trunk into the slots.
3. Press the clip on one side of the bulb assembly and pull out the assembly from the front with your other hand.
4. Remove the old bulb from the socket.
5. Place the new bulb into the socket.
6. Reverse Steps 1 through 3 to reinstall.

When reinstalling bulb assembly, push in the assembly until you hear a snap. Make sure the assembly is tight.

## Windshield Wiper Blade Replacement

Windshield wiper blades should be inspected at least twice a year for wear or cracking. See “Windshield Wipers, Blade Check” in the Index for more information.

Replacement blades come in different types and are removed in different ways. For the proper type and length, see “Normal Maintenance Replacement Parts” in the Index.

Here’s how to remove the wiper blades:

1. Pull the windshield wiper arm away from the windshield.
2. Push the release lever and slide the wiper assembly toward the driver’s side of the vehicle.
3. Install a new blade by reversing Steps 1 and 2.



## Tires

Your new vehicle comes with high-quality tires made by a leading tire manufacturer. If you ever have questions about your tire warranty and where to obtain service, see your Oldsmobile Warranty booklet for details.

### CAUTION:

**Poorly maintained and improperly used tires are dangerous.**

- **Overloading your tires can cause overheating as a result of too much friction. You could have an air-out and a serious accident. See “Loading Your Vehicle” in the Index.**
- **Underinflated tires pose the same danger as overloaded tires. The resulting accident could cause serious injury. Check all tires frequently to maintain the recommended pressure. Tire pressure should be checked when your tires are cold.**
- **Overinflated tires are more likely to be cut, punctured or broken by a sudden impact -- such as when you hit a pothole. Keep tires at the recommended pressure.**
- **Worn, old tires can cause accidents. If your tread is badly worn, or if your tires have been damaged, replace them.**

## Inflation -- Tire Pressure

The Tire-Loading Information label, which is located on the inside of the trunk lid, shows the correct inflation pressures for your tires when they're cold. "Cold" means your vehicle has been sitting for at least three hours or driven no more than 1 mile (1.6 km).

### NOTICE:

**Don't let anyone tell you that underinflation or overinflation is all right. It's not. If your tires don't have enough air (underinflation), you can get the following:**

- Too much flexing
- Too much heat
- Tire overloading
- Bad wear
- Bad handling
- Bad fuel economy.

**NOTICE: (Continued)**

### NOTICE: (Continued)

**If your tires have too much air (overinflation), you can get the following:**

- Unusual wear
- Bad handling
- Rough ride
- Needless damage from road hazards.

### When to Check

Check your tires once a month or more.

Don't forget your compact spare tire. It should be at 60 psi (420 kPa).

### How to Check

Use a good quality pocket-type gage to check tire pressure. You can't tell if your tires are properly inflated simply by looking at them. Radial tires may look properly inflated even when they're underinflated.

Be sure to put the valve caps back on the valve stems. They help prevent leaks by keeping out dirt and moisture.

## Tire Inspection and Rotation

Tires should be rotated every 6,000 to 8,000 miles (10 000 to 13 000 km). Any time you notice unusual wear, rotate your tires as soon as possible and check wheel alignment. Also check for damaged tires or wheels. See “When It’s Time for New Tires” and “Wheel Replacement” later in this section for more information.

The purpose of regular rotation is to achieve more uniform wear for all tires on the vehicle. The first rotation is the most important. See “Scheduled Maintenance Services” in the Index for scheduled rotation intervals.

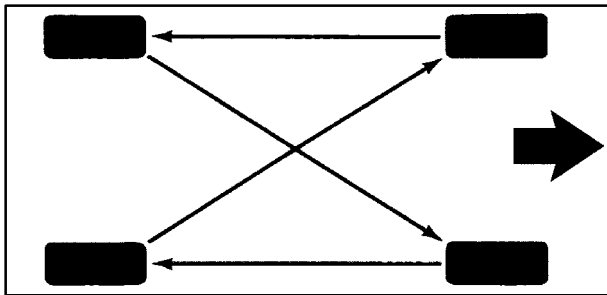

When rotating your tires, always use the correct rotation pattern shown here.

Don't include the compact spare tire in your tire rotation.

After the tires have been rotated, adjust the front and rear inflation pressures as shown on the Tire-Loading Information label. Make certain that all wheel nuts are properly tightened. See “Wheel Nut Torque” in the Index.

### CAUTION:

**Rust or dirt on a wheel, or on the parts to which it is fastened, can make wheel nuts become loose after a time. The wheel could come off and cause an accident. When you change a wheel, remove any rust or dirt from places where the wheel attaches to the vehicle. In an emergency, you can use a cloth or a paper towel to do this; but be sure to use a scraper or wire brush later, if you need to, to get all the rust or dirt off. See “Changing a Flat Tire” in the Index.**

## When It's Time for New Tires

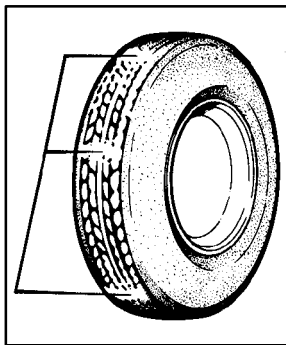

One way to tell when it's time for new tires is to check the treadwear indicators, which will appear when your tires have only 1/16 inch (1.6 mm) or less of tread remaining.

You need a new tire if any of the following statements are true:

- You can see the indicators at three or more places around the tire.
- You can see cord or fabric showing through the tire's rubber.
- The tread or sidewall is cracked, cut or snagged deep enough to show cord or fabric.

- The tire has a bump, bulge or split.
- The tire has a puncture, cut or other damage that can't be repaired well because of the size or location of the damage.

## Buying New Tires

To find out what kind and size of tires you need, look at the Tire-Loading Information label.

The tires installed on your vehicle when it was new had a Tire Performance Criteria Specification (TPC Spec) number on each tire's sidewall. When you get new tires, get ones with that same TPC Spec number. That way your vehicle will continue to have tires that are designed to give proper endurance, handling, speed rating, traction, ride and other things during normal service on your vehicle. If your tires have an all-season tread design, the TPC number will be followed by an "MS" (for mud and snow).

If you ever replace your tires with those not having a TPC Spec number, make sure they are the same size, load range, speed rating and construction type (bias, bias-belted or radial) as your original tires.



## CAUTION:

**Mixing tires could cause you to lose control while driving. If you mix tires of different sizes or types (radial and bias-belted tires), the vehicle may not handle properly, and you could have a crash. Using tires of different sizes may also cause damage to your vehicle. Be sure to use the same size and type tires on all wheels.**

**It's all right to drive with your compact spare, though. It was developed for use on your vehicle.**



## CAUTION:

**If you use bias-ply tires on your vehicle, the wheel rim flanges could develop cracks after many miles of driving. A tire and/or wheel could fail suddenly, causing a crash. Use only radial-ply tires with the wheels on your vehicle.**

## Uniform Tire Quality Grading

Quality grades can be found where applicable on the tire sidewall between tread shoulder and maximum section width. For example:

### Treadwear 200 Traction AA Temperature A

The following information relates to the system developed by the United States National Highway Traffic Safety Administration, which grades tires by treadwear, traction and temperature performance. (This applies only to vehicles sold in the United States.) The grades are molded on the sidewalls of most passenger car tires. The Uniform Tire Quality Grading system does not apply to deep tread, winter-type snow tires, space-saver or temporary use spare tires, tires with nominal rim diameters of 10 to 12 inches (25 to 30 cm), or to some limited-production tires.

While the tires available on General Motors passenger cars and light trucks may vary with respect to these grades, they must also conform to federal safety requirements and additional General Motors Tire Performance Criteria (TPC) standards.



## **Treadwear**

The treadwear grade is a comparative rating based on the wear rate of the tire when tested under controlled conditions on a specified government test course. For example, a tire graded 150 would wear one and a half (1 1/2) times as well on the government course as a tire graded 100. The relative performance of tires depends upon the actual conditions of their use, however, and may depart significantly from the norm due to variations in driving habits, service practices and differences in road characteristics and climate.

## **Traction -- AA, A, B, C**

The traction grades, from highest to lowest, are AA, A, B, and C. Those grades represent the tire's ability to stop on wet pavement as measured under controlled conditions on specified government test surfaces of asphalt and concrete. A tire marked C may have poor traction performance. Warning: The traction grade assigned to this tire is based on straight-ahead braking traction tests, and does not include acceleration, cornering, hydroplaning, or peak traction characteristics.

## **Temperature -- A, B, C**

The temperature grades are A (the highest), B, and C, representing the tire's resistance to the generation of heat and its ability to dissipate heat when tested under controlled conditions on a specified indoor laboratory test wheel. Sustained high temperature can cause the material of the tire to degenerate and reduce tire life, and excessive temperature can lead to sudden tire failure. The grade C corresponds to a level of performance which all passenger car tires must meet under the Federal Motor Vehicle Safety Standard No. 109. Grades B and A represent higher levels of performance on the laboratory test wheel than the minimum required by law.

Warning: The temperature grade for this tire is established for a tire that is properly inflated and not overloaded. Excessive speed, underinflation, or excessive loading, either separately or in combination, can cause heat buildup and possible tire failure.

## Wheel Alignment and Tire Balance

The wheels on your vehicle were aligned and balanced carefully at the factory to give you the longest tire life and best overall performance.

Scheduled wheel alignment and wheel balancing are not needed. However, if you notice unusual tire wear or your vehicle pulling one way or the other, the alignment may need to be reset. If you notice your vehicle vibrating when driving on a smooth road, your wheels may need to be rebalanced.

## Wheel Replacement

Replace any wheel that is bent, cracked, or badly rusted or corroded. If wheel nuts keep coming loose, the wheel, wheel bolts and wheel nuts should be replaced. If the wheel leaks air, replace it (except some aluminum wheels, which can sometimes be repaired). See your dealer if any of these conditions exist.

Your dealer will know the kind of wheel you need.

Each new wheel should have the same load-carrying capacity, diameter, width, offset and be mounted the same way as the one it replaces.

If you need to replace any of your wheels, wheel bolts or wheel nuts, replace them only with new GM original equipment parts. This way, you will be sure to have the right wheel, wheel bolts and wheel nuts for your vehicle.

### CAUTION:

**Using the wrong replacement wheels, wheel bolts or wheel nuts on your vehicle can be dangerous. It could affect the braking and handling of your vehicle, make your tires lose air and make you lose control. You could have a collision in which you or others could be injured. Always use the correct wheel, wheel bolts and wheel nuts for replacement.**

## **NOTICE:**

The wrong wheel can also cause problems with bearing life, brake cooling, speedometer or odometer calibration, headlamp aim, bumper height, vehicle ground clearance and tire or tire chain tire clearance to the body and chassis.

See “Changing a Flat Tire” in the Index for more information.

### **Used Replacement Wheels**

## **CAUTION:**

Putting a used wheel on your vehicle is dangerous. You can't know how it's been used or how far it's been driven. It could fail suddenly and cause an accident. If you have to replace a wheel, use a new GM original equipment wheel.

### **Tire Chains**

## **NOTICE:**

Use tire chains only where legal and only when you must. Use only SAE Class “S” type chains that are the proper size for your tires. Install them on the front tires and tighten them as tightly as possible with the ends securely fastened. Drive slowly and follow the chain manufacturer's instructions. If you can hear the chains contacting your vehicle, stop and retighten them. If the contact continues, slow down until it stops. Driving too fast or spinning the wheels with chains on will damage your vehicle.

## Appearance Care

Remember, cleaning products can be hazardous. Some are toxic. Others can burst into flame if you strike a match or get them on a hot part of the vehicle. Some are dangerous if you breathe their fumes in a closed space. When you use anything from a container to clean your vehicle, be sure to follow the manufacturer's warnings and instructions. And always open your doors or windows when you're cleaning the inside.

*Never* use these to clean your vehicle:

- Gasoline
- Benzene
- Naphtha
- Carbon Tetrachloride
- Acetone
- Paint Thinner
- Turpentine
- Lacquer Thinner
- Nail Polish Remover

They can all be hazardous -- some more than others -- and they can all damage your vehicle, too.

Don't use any of these unless this manual says you can. In many uses, these will damage your vehicle:

- Alcohol
- Laundry Soap
- Bleach
- Reducing Agents

## Cleaning the Inside of Your Vehicle

Use a vacuum cleaner often to get rid of dust and loose dirt. Wipe vinyl, leather, plastic and painted surfaces with a clean, damp cloth.

## Cleaning of Fabric/Carpet

Your dealer has two cleaners, Multi-Purpose Interior Cleaner and Capture Non-Solvent Dry Spot and Soil Remover for cleaning fabric and carpet. They will clean normal spots and stains very well. You can get GM-approved cleaning products from your dealer. See "Appearance Care and Materials" in the Index.

Here are some cleaning tips:

- Always read the instructions on the cleaner label.
- Clean up stains as soon as you can -- before they set.
- Carefully scrape off any excess stain.
- Use a clean cloth or sponge, and change to a clean area often. A soft brush may be used if stains are stubborn.
- If a ring forms on fabric after spot cleaning, clean the entire area immediately or it will set.

### **Using Multi-Purpose Interior Cleaner on Fabric**

1. Vacuum and brush the area to remove any loose dirt.
2. Always clean a whole trim panel or section. Mask surrounding trim along stitch or welt lines.
3. Mix powdered cleaner following the directions on the container label to form thick suds.
4. Use suds only and apply with a clean sponge. Don't saturate the material and don't rub it roughly.
5. As soon as you've cleaned the section, use a sponge to remove the suds.
6. Wipe cleaned area with a clean, damp towel or cloth.
7. Wipe with a clean cloth and let dry.

### **Special Fabric Cleaning Problems**

Stains caused by such things as catsup, coffee (black), egg, fruit, fruit juice, milk, soft drinks, vomit, urine and blood can be removed as follows:

1. Carefully scrape off excess stain, then sponge the soiled area with cool water.
2. If a stain remains, follow the Multi-Purpose Interior Cleaner instructions described earlier.
3. If an odor lingers after cleaning vomit or urine, treat the area with a water/baking soda solution: 1 teaspoon (5 ml) of baking soda to 1 cup (250 ml) of lukewarm water.
4. Let dry.

Stains caused by candy, ice cream, mayonnaise, chili sauce and unknown stains can be removed as follows:

1. Carefully scrape off excess stain.
2. First, clean with cool water and allow to dry completely.
3. If a stain remains, follow instructions for Multi-Purpose Interior Cleaner.

## Cleaning Vinyl

Use warm water and a clean cloth.

- Rub with a clean, damp cloth to remove dirt. You may have to do it more than once.
- Things like tar, asphalt and shoe polish will stain if you don't get them off quickly. Use a clean cloth and a vinyl/leather cleaner. See your dealer for this product.

## Cleaning Leather

Use a soft cloth with lukewarm water and a mild soap or saddle soap and wipe dry with a soft cloth. Then, let the leather dry naturally. Do not use heat to dry.

- For stubborn stains, use a leather cleaner. See your dealer for this product.
- *Never* use oils, varnishes, solvent-based or abrasive cleaners, furniture polish or shoe polish on leather.
- Soiled or stained leather should be cleaned immediately. If dirt is allowed to work into the finish, it can harm the leather.

## Cleaning the Top of the Instrument Panel

Use only mild soap and water to clean the top surfaces of the instrument panel. Sprays containing silicones or waxes may cause annoying reflections in the windshield and even make it difficult to see through the windshield under certain conditions.

## Cleaning Interior Plastic Components

Use only a mild soap and water solution on a soft cloth or sponge. Commercial cleaners may affect the surface finish.

## Care of Safety Belts

Keep belts clean and dry.

### CAUTION:

**Do not bleach or dye safety belts. If you do, it may severely weaken them. In a crash, they might not be able to provide adequate protection. Clean safety belts only with mild soap and lukewarm water.**

## Cleaning Glass Surfaces

Glass should be cleaned often. GM Glass Cleaner or a liquid household glass cleaner will remove normal tobacco smoke and dust films on interior glass. See “Appearance Care and Materials” in the Index.

Don’t use abrasive cleaners on glass, because they may cause scratches. Avoid placing decals on the inside rear window, since they may have to be scraped off later. If abrasive cleaners are used on the inside of the rear window, an electric defogger element may be damaged. Any temporary license should not be attached across the defogger grid.

## Cleaning the Outside of the Windshield and Wiper Blades

If the windshield is not clear after using the windshield washer, or if the wiper blade chatters when running, wax, sap or other material may be on the blade or windshield.

Clean the outside of the windshield with GM Windshield Cleaner, Bon Ami<sup>®</sup> Powder (non-scratching glass cleaning powder), GM Part No. 1050011. The windshield is clean if beads do not form when you rinse it with water.

Grime from the windshield will stick to the wiper blades and affect their performance. Clean the blade by wiping vigorously with a cloth soaked in full-strength windshield washer solvent. Then rinse the blade with water.

Check the wiper blades and clean them as necessary; replace blades that look worn.

## Weatherstrips

Silicone grease on weatherstrips will make them last longer, seal better, and not stick or squeak. Apply silicone grease with a clean cloth at least every six months. During very cold, damp weather more frequent application may be required. See “Recommended Fluids and Lubricants” in the Index.

## Cleaning the Outside of Your Vehicle

The paint finish on your vehicle provides beauty, depth of color, gloss retention and durability.

### Washing Your Vehicle

The best way to preserve your vehicle's finish is to keep it clean by washing it often with lukewarm or cold water.

Don't wash your vehicle in the direct rays of the sun. Use a car washing soap. Don't use strong soaps or chemical detergents. Be sure to rinse the vehicle well, removing all soap residue completely. You can get GM-approved cleaning products from your dealer. See "Appearance Care and Materials" in the Index. Don't use cleaning agents that are petroleum based, or that contain acid or abrasives. All cleaning agents should be flushed promptly and not allowed to dry on the surface, or they could stain. Dry the finish with a soft, clean chamois or an all-cotton towel to avoid surface scratches and water spotting.

High pressure car washes may cause water to enter your vehicle.

## Cleaning Exterior Lamps/Lenses

Use only lukewarm or cold water, a soft cloth and a car washing soap to clean exterior lamps and lenses. Follow instructions under "Washing Your Vehicle."

### Finish Care

Occasional waxing or mild polishing of your vehicle by hand may be necessary to remove residue from the paint finish. You can get GM-approved cleaning products from your dealer. See "Appearance Care and Materials" in the Index.

Your vehicle has a "basecoat/clearcoat" paint finish. The clearcoat gives more depth and gloss to the colored basecoat. Always use waxes and polishes that are non-abrasive and made for a basecoat/clearcoat paint finish.

### **NOTICE:**

**Machine compounding or aggressive polishing on a basecoat/clearcoat paint finish may dull the finish or leave swirl marks.**



Foreign materials such as calcium chloride and other salts, ice melting agents, road oil and tar, tree sap, bird droppings, chemicals from industrial chimneys, etc., can damage your vehicle's finish if they remain on painted surfaces. Wash the vehicle as soon as possible. If necessary, use non-abrasive cleaners that are marked safe for painted surfaces to remove foreign matter.

Exterior painted surfaces are subject to aging, weather and chemical fallout that can take their toll over a period of years. You can help to keep the paint finish looking new by keeping your vehicle garaged or covered whenever possible.

## **Cleaning Aluminum or Chrome-Plated Wheels (If Equipped)**

Keep your wheels clean using a soft clean cloth with mild soap and water. Rinse with clean water. After rinsing thoroughly, dry with a soft clean towel. A wax may then be applied.

The surface of these wheels is similar to the painted surface of your vehicle. Don't use strong soaps, chemicals, abrasive polishes, abrasive cleaners, cleaners with acid or abrasive cleaning brushes on them because you could damage the surface. Do not use chrome polish on aluminum wheels.

Use chrome polish only on chrome-plated wheels, but avoid any painted surface of the wheel, and buff off immediately after application.

Don't take your vehicle through an automatic car wash that has silicon carbide tire cleaning brushes. These brushes can also damage the surface of these wheels.

## **Cleaning Tires**

To clean your tires, use a stiff brush with a tire cleaner.

### **NOTICE:**

**When applying a tire dressing always take care to wipe off any overspray or splash from all painted surfaces on the body or wheels of the vehicle. Petroleum-based products may damage the paint finish and tires.**

## Sheet Metal Damage

If your vehicle is damaged and requires sheet metal repair or replacement, make sure the body repair shop applies anti-corrosion material to the parts repaired or replaced to restore corrosion protection.

Original manufacturer replacement parts will provide the corrosion protection while maintaining the warranty.

## Finish Damage

Any stone chips, fractures or deep scratches in the finish should be repaired right away. Bare metal will corrode quickly and may develop into a major repair expense.

Minor chips and scratches can be repaired with touch-up materials available from your dealer or other service outlets. Larger areas of finish damage can be corrected in your dealer's body and paint shop.

## Underbody Maintenance

Chemicals used for ice and snow removal and dust control can collect on the underbody. If these are not removed, accelerated corrosion (rust) can occur on the underbody parts such as fuel lines, frame, floor pan and exhaust system even though they have corrosion protection.

At least every spring, flush these materials from the underbody with plain water. Clean any areas where mud and other debris can collect. Dirt packed in closed areas of the frame should be loosened before being flushed. Your dealer or an underbody car washing system can do this for you.

## Chemical Paint Spotting

Some weather and atmospheric conditions can create a chemical fallout. Airborne pollutants can fall upon and attack painted surfaces on your vehicle. This damage can take two forms: blotchy, ringlet-shaped discolorations, and small irregular dark spots etched into the paint surface.

Although no defect in the paint job causes this, Oldsmobile will repair, at no charge to the owner, the surfaces of new vehicles damaged by this fallout condition within 12 months or 12,000 miles (20 000 km) of purchase, whichever occurs first.

## GM Vehicle Care/Appearance Materials

PART NUMBER	SIZE	DESCRIPTION	USAGE
994954	23 in. x 25 in.	Polishing Cloth – Wax Treated	Exterior polishing cloth
1050172	16 oz. (0.473 L)	Tar and Road Oil Remover	Removes tar, road oil and asphalt
1050173	16 oz. (0.473 L)	Chrome Cleaner and Polish	Use on chrome, stainless steel, nickel, copper and brass
1050174	16 oz. (0.473 L)	White Sidewall Tire Cleaner	Removes soil and black marks from whitewalls
1050214	32 oz. (0.946 L)	Vinyl Cleaner	Cleans vinyl tops, upholstery and convertible tops
1050427	23 oz. (0.680 L)	Glass Cleaner	Removes dirt, grime, smoke and fingerprints
1052918**	8 oz. (0.237 L)	Armor All™ Protectant	Protects leather, wood, acrylics, Plexiglas™, plastic, rubber and vinyl
1052925	16 oz. (0.473 L)	Multi-Purpose Interior Cleaner	Cleans carpets, seats, interior trim, door panels and floor mats
1052929	16 oz. (0.473 L)	Wheel Cleaner	Spray on and rinse with water
1052930	8 oz. (0.237 L)	Capture Dry Spot Remover	Attracts, absorbs and removes soils on fabric
12345721	2.5 sq. ft.	Synthetic Chamois	Shines vehicle without scratching
12345725	12 oz. (0.354 L)	Silicone Tire Shine	Spray on tire shine
12377964*	16 oz. (0.473 L)	Finish Enhancer	Removes dust, fingerprints and surface contaminants
12377966*	16 oz. (0.473 L)	Cleaner Wax	Removes light scratches and oxidation and protects finish
12377984*	16 oz. (0.473 L)	Surface Cleaner	Removes contaminants, blemishes and swirl marks
See your General Motors Parts Department for these products. See “Recommended Fluids and Lubricants” in the Index.		* For exterior use only. ** Not recommended for use on instrument panels.	

## Vehicle Identification Number (VIN)

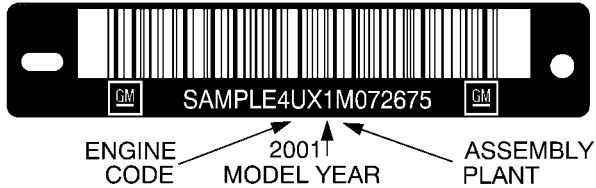

This is the legal identifier for your vehicle. It appears on a plate in the front corner of the instrument panel, on the driver's side. You can see it if you look through the windshield from outside your vehicle. The VIN also appears on the Vehicle Certification and Service Parts labels and the certificates of title and registration.

## Engine Identification

The 8th character in your VIN is the engine code. This code will help you identify your engine, specifications and replacement parts.

## Service Parts Identification Label

You'll find this label on the inside of your trunk lid. It's very helpful if you ever need to order parts. On this label is:

- your VIN,
- the model designation,
- paint information and
- a list of all production options and special equipment.

Be sure that this label is not removed from the vehicle.

## Electrical System

### Add-On Electrical Equipment

#### **NOTICE:**

**Don't add anything electrical to your vehicle unless you check with your dealer first. Some electrical equipment can damage your vehicle and the damage wouldn't be covered by your warranty. Some add-on electrical equipment can keep other components from working as they should.**

Your vehicle has an air bag system. Before attempting to add anything electrical to your vehicle, see “Servicing Your Air Bag-Equipped Vehicle” in the Index.

### Headlamp Wiring

The headlamp wiring is protected by separate left and right headlamp fuses in the underhood electrical center. An electrical overload will cause a lamp to go off and remain off. If this happens, have your headlamp system checked right away.

### Windshield Wipers

The windshield wiper motor is protected by a circuit breaker and a fuse. If the motor overheats due to heavy snow or ice, the wiper will stop until the motor cools. If the overload is caused by some electrical problem, have it fixed.

### Power Windows and Other Power Options

Circuit breakers in the fuse panel protect the power windows and other power accessories. When the current load is too heavy, the circuit breaker opens and closes, protecting the circuit until the problem is fixed.

### Fuses and Circuit Breakers

The wiring circuits in your vehicle are protected from short circuits by a combination of fuses, circuit breakers and fusible thermal links in the wiring itself. This greatly reduces the chance of fires caused by electrical problems.

Look at the silver-colored band inside the fuse. If the band is broken or melted, replace the fuse. Be sure you replace a bad fuse with a new one of the identical size and rating.

## Instrument Panel Fuse Block



These fuses are located in a fuse block on the passenger's side of the instrument panel. Pull off the passenger's side cover to expose the fuses.

### FUSE USAGE CHART

	CRANK SIGNAL BCM CLUSTER		IGN S CLUSTER PCM & BCM		CHIRP SPEAKERS
LOW BLOWER	HVAC	CRUISE			
	BTSI				FRONT WINDOWS PWR WINDOWP
TURN SIGNALS CORNER LPS	AIR BAG	CLUSTER		PCM BCM LH RELAY	
RADIO, HVAC, RFA CLUSTER DATA LINK	BCM	CIGAR LTR AUX POWER	READY POWER BUS		REAR SEATS
HIGH BLOWER	HAZARD	STOP LAMPS	DOOR LOCKS	POWER MIRRORS	POWER SEATS
RH HEATED SEAT	LH HEATED SEAT		ONSTAR		
	RED STRG HOL. SLIDE	FRT PARK LPS	TAIL LAMPS LCL LAMPS	PANEL DIMMING	
	WIPER	POWER DROP	RADIO, CRUISE		

#### Fuse

NOT USED

CRANK  
SIGNAL BCM,  
CLUSTER

NOT USED

#### Description

Not Used

CRANK -- Instrument Panel  
Cluster, Body Control Module,  
Powertrain Control Module

Not Used

<b>Fuse</b>	<b>Description</b>
IGN 0: CLUSTER PCM, & BCM	Instrument Panel Cluster, Powertrain Control Module, Body Control
NOT USED	Not Used
LOW BLOWER	HVAC Control Assembly, Blower Motor
HVAC	Air Temperature Valve Motor, HVAC Control Assembly, Solenoid Box, Compass Mirror
CRUISE	Cruise Control Module
NOT USED	Not Used
NOT USED	Not Used
NOT USED	Not Used
BTSI	Automatic Transaxle Shift Lock Control System
NOT USED	Not Used
NOT USED	Not Used
NOT USED	Not Used
TURN SIGNALS, CORN LPS	Turn Signals, Cornering Lamps

<b>Fuse</b>	<b>Description</b>
AIR BAG	Air Bag System
CLUSTER	Instrument Panel Cluster
NOT USED	Not Used
PCM, BCM, U/H RELAY	Powertrain Control Module, Body Control Module, Underhood Ignition/Relay
RADIO, HVAC, RFA CLUSTER, DATA LINK	Radio, HVAC Control Assembly, Instrument Panel Cluster, Remote Keyless Entry Module, Data Link Connector, Bose Amplifier
BCM	Body Control Module
CIGAR LTR, AUX POWER	Auxiliary Power, Cigarette Lighter, Power Drop
INADV POWER BUS	Vanity Mirrors, Instrument Panel Courtesy Lamps, Instrument Panel Compartment Lamps, Trunk Courtesy Lamp, Header Courtesy and Reading Lamps, I/S Lighted Rearview Mirror
NOT USED	Not Used
HIGH BLOWER	High Blower Relay
HAZARD	Hazard Switch

<b>Fuse</b>	<b>Description</b>
STOP LAMPS	Stoplamps Switch
DOOR LOCKS	Door Lock Relays (Internal to Body Control Module) and External Driver Door Lock Relay
POWER MIRRORS	Left-hand and Right-hand Power Mirrors
RH HEATED SEAT	Passenger's Side Heated Seat
LH HEATED SEAT	Driver's Side Heated Seat
NOT USED	Not Used
ONSTAR	OnStar <sup>®</sup> System
NOT USED	Not Used
NOT USED	Not Used
RED STRG WHL ILLUM	Steering Wheel Radio Switch Illumination
FRT PARK LPS	Front Parking Lamps, Sidemarkers Lamps

<b>Fuse</b>	<b>Description</b>
TAIL LAMPS, LIC LAMPS	Taillamps, License Lamps, Rear Sidemarkers Lamps, Rear Sidemarkers Lamps
PANEL DIMMING	Dimmable Instrument Panel Lamps
NOT USED	Not Used
WIPER	Wiper Switch
POWER DROP	Power Drop
RADIO, CRUISE	Radio, Steering Wheel Radio Controls, Cruise Control Switches
NOT USED	Not Used
<b>Circuit Breaker</b>	<b>Description</b>
NOT USED	Not Used
PWR WINDOWS, PWR SUNROOF	Power Windows, Power Sunroof
REAR DEFOG	Rear Defog
POWER SEATS	Power Seats
NOT USED	Not Used



## Underhood Electrical Center -- Passenger's Side

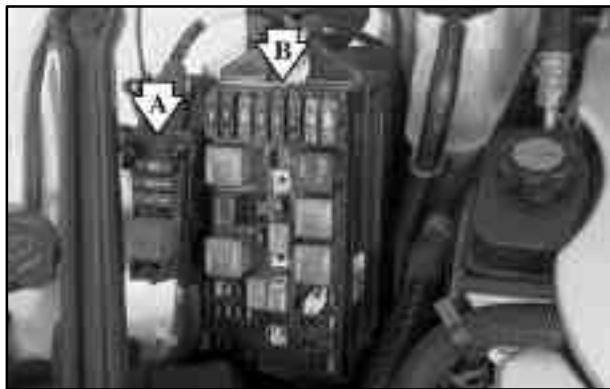

A. Accessory Wiring Junction Fuse Block

B. Main Underhood Fuse Block

Some fuses are in the underhood electrical center. The accessory wiring junction fuse block (A) is located next to the main underhood fuse block (B) on the passenger's side of the engine compartment. See "Engine Compartment Overview" in the Index for more information on location.

To see the fuses, remove the cover by following these steps:

1. Remove the remote positive terminal cap. See "Remote Positive Terminal" in the Index.
2. Turn the knob on the front of the fuse cover counterclockwise.
3. Pull off the cover.

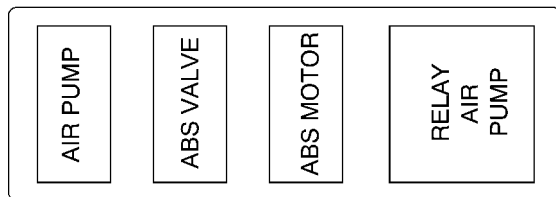

Fuse	Description
AIR PUMP	Air Pump
ABS VALVE	ABS
ABS MOTOR	ABS
RELAY AIR PUMP	Air Pump

The main underhood fuse block (B) contains the following fuses:

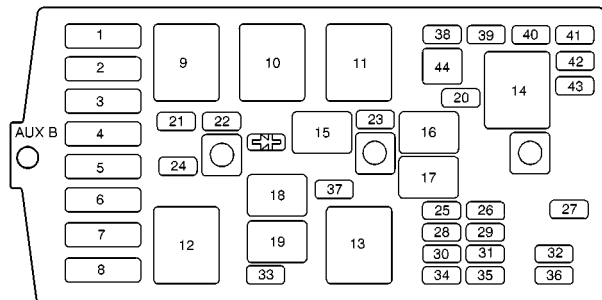

Maxi Fuses	Description
1	Cooling Fans
2	Crank
3	Power Seats, Rear Defog, Trunk Release
4	HVAC Controls, Hazard Flasher, CHMSL, Body Control Module, Stoplamps, Power Mirrors

Maxi Fuses	Description
5	HVAC Controls, Compass Mirror, Cruise Control, PRNDL Lamp, Powertrain Control Module (PCM)
6	Cooling Fans
7	Body Control Module, Cigar Lighter, Accessory Power Outlet, Audio Systems, Keyless Entry System, I/P Cluster, HVAC Controls
8	Turn Signals, Air Bag System, I/P Cluster, Body Control Module, Windshield Wipers

Mini Relays	Description
9	Cooling Fans
10	Cooling Fans
11	Crank
12	Cooling Fans
13	Ignition Main
14	Blank

<b>Micro Relays</b>	<b>Description</b>
15	Air Conditioning Compressor
16	Horn
17	Fog Lamps
18	Blank
19	Fuel Pump

<b>Mini Fuses</b>	<b>Description</b>
20	Blank
21	Generator
22	Powertrain Control Module
23	Air Conditioning Compressor
24	Blank
25	Fuel Injectors, Electronic Ignition
26	Transmission Solenoid
27	Horn
28	Fuel Injector, Electronic Ignition
29	Oxygen Sensor
30	PCM Devices/Engine Emissions Sensors

<b>Mini Fuses</b>	<b>Description</b>
31	Fog Lamps
32	Headlamp (Passenger's Side)
33	Trunk Release
34	Parking Lamp
35	Fuel Pump
36	Headlamp (Driver's Side)
37	ABS
38	Spare
39	Spare
40	Spare
41	Spare
42	Spare
43	Spare

<b>Diodes</b>	<b>Description</b>
	Air Conditioning Compressor Diode
44	Fuse Puller

## Replacement Bulbs

Center High-Mounted Stop Lamp (CHMSL) . . .	1141
Fog Lamp . . . . .	893
Front Parking/Turn Signal . . . . .	4157 NAK
Headlamp	
High Beam . . . . .	9005
Low Beam . . . . .	9006
License Plate Lamp . . . . .	194
Sidemarkers (Front/Rear) . . . . .	194
Stop/Tail/Turn Signal (Rear) . . . . .	3057
Cornering . . . . .	3156

## Capacities and Specifications

Please refer to “Recommended Fluids and Lubricants” in the Index for more information.

### Automatic Transaxle

After Complete Overhaul . . . . . 10.0 quarts (9.5 L)

Pan Removal and Replacement . . . 7.4 quarts (7.0 L)

When draining/replacing the converter, more fluid may be needed.

### Cooling System

  Including Reservoir . . . . . 10.0 quarts (9.5 L)

A/C Refrigerant . . . . . See refrigerant charge label under the hood.

### Engine Crankcase

(Oil and Filter Change) . . . . . 6.5 quarts (6.1 L)

Fuel Tank . . . . . 17.5 U.S. gallons (66.2 L)

Wheel Nut Torque . . . . . 100 lb-ft (140 N-m)

All capacities are approximate. When adding, be sure to fill to the appropriate level, as recommended in this manual. Recheck fluid level after filling.

## Engine Specifications

Type	V6
VIN Code	H
Displacement	212 cubic inches (3.5 L)
Compression Ratio	9.3:1
Firing Order	1-2-3-4-5-6
Thermostat Temperature	180°F (82°C)
Horsepower	215 @ 5600 rpm

## Normal Maintenance

### Replacement Parts

Engine Air Cleaner/Filter	A1096C*
Passenger Compartment Air Filter	10406026
Battery	19101812
Engine Oil Filter	25177917
PCV Valve	CV892C*
Cooling System Pressure Cap	22652695

Spark Plugs . . . . . Type PTR5C-13/12556183  
Gap: 0.050 inches (.127 cm)

Windshield Wiper Blade Replacement  
Length . . . . . 22 inches (56 cm)  
Type . . . . . Pin  
\*ACDelco® part number

## Vehicle Dimensions

Wheelbase . . . . . 109.0 inches (276.9cm)  
Front Tread Width . . . . . 62.1 inches (157.7 cm)  
Rear Tread Width . . . . . 61.7 inches (156.7 cm)  
Length . . . . . 195.9 inches (497.5 cm)  
Width . . . . . 73.6 inches (186.9 cm)  
Height . . . . . 56.6 inches (143.8 cm)



## Section 7 Maintenance Schedule

---

This section covers the maintenance required for your vehicle. Your vehicle needs these services to retain its safety, dependability and emission control performance.

7-2	Introduction	7-19	Part C: Periodic Maintenance Inspections
7-4	Part A: Scheduled Maintenance Services	7-21	Part D: Recommended Fluids and Lubricants
7-5	Scheduled Maintenance	7-22	Part E: Maintenance Record
7-15	Part B: Owner Checks and Services		

**IMPORTANT:**  
KEEP ENGINE OIL  
AT THE PROPER  
LEVEL AND CHANGE AS  
RECOMMENDED



***Protection  
Plan***

*Have you purchased the GM Protection Plan? The Plan supplements your new vehicle warranties. See your Warranty and Owner Assistance booklet or your dealer for details.*

## **Introduction**

### **Your Vehicle and the Environment**

Proper vehicle maintenance not only helps to keep your vehicle in good working condition, but also helps the environment. All recommended maintenance procedures are important. Improper vehicle maintenance can even affect the quality of the air we breathe. Improper fluid levels or the wrong tire inflation can increase the level of emissions from your vehicle. To help protect our environment, and to keep your vehicle in good condition, please maintain your vehicle properly.

### **Maintenance Requirements**

Maintenance intervals, checks, inspections and recommended fluids and lubricants as prescribed in this manual are necessary to keep your vehicle in good working condition. Any damage caused by failure to follow recommended maintenance may not be covered by warranty.

## How This Section is Organized

This maintenance schedule is divided into five parts:

**“Part A: Scheduled Maintenance Services”** shows what to have done and how often. Some of these services can be complex, so unless you are technically qualified and have the necessary equipment, you should let your dealer’s service department or another qualified service center do these jobs.

### CAUTION:

**Performing maintenance work on a vehicle can be dangerous. In trying to do some jobs, you can be seriously injured. Do your own maintenance work only if you have the required know-how and the proper tools and equipment for the job. If you have any doubt, have a qualified technician do the work.**

If you want to get the service information, see “Service and Owner Publications” in the Index.

**“Part B: Owner Checks and Services”** tells you what should be checked and when. It also explains what you can easily do to help keep your vehicle in good condition.

**“Part C: Periodic Maintenance Inspections”** explains important inspections that your dealer’s service department or another qualified service center should perform.

**“Part D: Recommended Fluids and Lubricants”** lists some recommended products necessary to help keep your vehicle properly maintained. These products, or their equivalents, should be used whether you do the work yourself or have it done.

**“Part E: Maintenance Record”** is a place for you to record and keep track of the maintenance performed on your vehicle. Keep your maintenance receipts. They may be needed to qualify your vehicle for warranty repairs.



## Part A: Scheduled Maintenance Services

### Using Your Maintenance Schedule

We at General Motors want to help you keep your vehicle in good working condition. But we don't know exactly how you'll drive it. You may drive very short distances only a few times a week. Or you may drive long distances all the time in very hot, dusty weather. You may use your vehicle in making deliveries. Or you may drive it to work, to do errands or in many other ways.

Because of all the different ways people use their vehicles, maintenance needs vary. You may need more frequent checks and replacements. So please read the following and note how you drive. If you have any questions on how to keep your vehicle in good condition, see your dealer.

This part tells you the maintenance services you should have done and when you should schedule them. If you go to your dealer for your service needs, you'll know that GM-trained and supported service people will perform the work using genuine GM parts.

The proper fluids and lubricants to use are listed in Part D. Make sure whoever services your vehicle uses these. All parts should be replaced and all necessary repairs done before you or anyone else drives the vehicle.

This schedule is for vehicles that:

- carry passengers and cargo within recommended limits. You will find these limits on your vehicle's Tire-Loading Information label. See "Loading Your Vehicle" in the Index.
- are driven on reasonable road surfaces within legal driving limits.
- use the recommended fuel. See "Fuel" in the Index.

## Scheduled Maintenance

The services shown in this schedule up to 100,000 miles (166 000 km) should be performed after 100,000 miles (166 000 km) at the same intervals. The services shown at 150,000 miles (240 000 km) should be performed at the same interval after 150,000 miles (240 000 km).

See “Owner Checks and Services” and “Periodic Maintenance Inspections” following.

### Footnotes

† *The U.S. Environmental Protection Agency or the California Air Resources Board has determined that the failure to perform this maintenance item will not nullify the emission warranty or limit recall liability prior to the completion of the vehicle’s useful life. We, however, urge that all recommended maintenance services be performed at the indicated intervals and the maintenance be recorded.*

+ *A good time to check your brakes is during tire rotation. See “Brake System Inspection” under “Periodic Maintenance Inspections” in Part C of this schedule.*

## Scheduled Maintenance

### Engine Oil Scheduled Maintenance

**Change engine oil and filter as indicated by the GM Oil Life System™ (or every 12 months, whichever occurs first). Reset the system.** The system will show you when to change the oil -- usually between 3,000 miles (5 000 km) and 10,000 miles (16 000 km) since your last oil change. Under severe conditions, the indicator may come on before 3,000 miles (5 000 km). Never drive your vehicle more than 10,000 miles (16 000 km) or 12 months without an oil and filter change.

The system won't detect dust in the oil. So if you drive in a dusty area, be sure to change your oil and filter every 3,000 miles (5 000 km) or sooner if the CHANGE OIL light appears. Remember to reset the Oil Life System when the oil and filter have been changed. See "Oil Life System" in the Index for information on resetting.

*An Emission Control Service.*

## Scheduled Maintenance

ENGINE OIL CHANGE		
DATE	ACTUAL MILEAGE	SERVICED BY:

ENGINE OIL CHANGE		
DATE	ACTUAL MILEAGE	SERVICED BY:

## Scheduled Maintenance

ENGINE OIL CHANGE		
DATE	ACTUAL MILEAGE	SERVICED BY:

ENGINE OIL CHANGE		
DATE	ACTUAL MILEAGE	SERVICED BY:

## Scheduled Maintenance

### 7,500 Miles (12 500 km)

- Rotate tires. See “Tire Inspection and Rotation” in the Index for proper rotation pattern and additional information. (See footnote +.)

### 15,000 Miles (25 000 km)

- Inspect engine air cleaner filter if you are driving in dusty conditions. Replace filter if necessary.  
*An Emission Control Service.* (See footnote †.)
- Replace passenger compartment air filter. If you drive regularly under dusty conditions, the filter may require replacement more often.
- Rotate tires. See “Tire Inspection and Rotation” in the Index for proper rotation pattern and additional information. (See footnote +.)

### 22,500 Miles (37 500 km)

- Rotate tires. See “Tire Inspection and Rotation” in the Index for proper rotation pattern and additional information. (See footnote +.)

DATE	
ACTUAL MILEAGE	SERVICED BY:

DATE	
ACTUAL MILEAGE	SERVICED BY:

DATE	
ACTUAL MILEAGE	SERVICED BY:

## Scheduled Maintenance

### 30,000 Miles (50 000 km)

- Replace passenger compartment air filter. If you drive regularly under dusty conditions, the filter may require replacement more often.
- Rotate tires. See “Tire Inspection and Rotation” in the Index for proper rotation pattern and additional information. (See footnote +.)
- Replace engine air cleaner filter.  
*An Emission Control Service.*

### 37,500 Miles (62 500 km)

- Rotate tires. See “Tire Inspection and Rotation” in the Index for proper rotation pattern and additional information. (See footnote +.)

### 45,000 Miles (75 000 km)

- Inspect engine air cleaner filter if you are driving in dusty conditions. Replace filter if necessary.  
*An Emission Control Service. (See footnote †.)*
- Replace passenger compartment air filter. If you drive regularly under dusty conditions, the filter may require replacement more often.
- Rotate tires. See “Tire Inspection and Rotation” in the Index for proper rotation pattern and additional information. (See footnote +.)

DATE	
ACTUAL MILEAGE	SERVICED BY:

DATE	
ACTUAL MILEAGE	SERVICED BY:

DATE	
ACTUAL MILEAGE	SERVICED BY:

## Scheduled Maintenance

### 50,000 Miles (83 000 km)

- Change automatic transaxle fluid and filter if the vehicle is mainly driven under one or more of these conditions:
  - In heavy city traffic where the outside temperature regularly reaches 90°F (32°C) or higher.
  - In hilly or mountainous terrain.
  - When doing frequent trailer towing.
  - Uses such as found in taxi, police or delivery service.

*If you do not use your vehicle under any of these conditions, change the fluid and filter at 100,000 miles (166 000 km).*

### 52,500 Miles (87 500 km)

- Rotate tires. See “Tire Inspection and Rotation” in the Index for proper rotation pattern and additional information. *(See footnote +.)*

DATE	
ACTUAL MILEAGE	SERVICED BY:

DATE	
ACTUAL MILEAGE	SERVICED BY:



## Scheduled Maintenance

### 60,000 Miles (100 000 km)

- Replace passenger compartment air filter. If you drive regularly under dusty conditions, the filter may require replacement more often.
- Rotate tires. See “Tire Inspection and Rotation” in the Index for proper rotation pattern and additional information. (See footnote +.)
- Inspect engine accessory drive belt.  
*An Emission Control Service.*
- Replace engine air cleaner filter.  
*An Emission Control Service.*

### 67,500 Miles (112 500 km)

- Rotate tires. See “Tire Inspection and Rotation” in the Index for proper rotation pattern and additional information. (See footnote +.)

### 75,000 Miles (125 000 km)

- Inspect engine air cleaner filter if you are driving in dusty conditions. Replace filter if necessary.  
*An Emission Control Service. (See footnote †.)*
- Replace passenger compartment air filter. If you drive regularly under dusty conditions, the filter may require replacement more often.
- Rotate tires. See “Tire Inspection and Rotation” in the Index for proper rotation pattern and additional information. (See footnote +.)

DATE	
ACTUAL MILEAGE	SERVICED BY:

DATE	
ACTUAL MILEAGE	SERVICED BY:

DATE	
ACTUAL MILEAGE	SERVICED BY:

## Scheduled Maintenance

### 82,500 Miles (137 500 km)

- Rotate tires. See “Tire Inspection and Rotation” in the Index for proper rotation pattern and additional information. (*See footnote +.*)

DATE	
ACTUAL MILEAGE	SERVICED BY:

### 90,000 Miles (150 000 km)

- Replace passenger compartment air filter. If you drive regularly under dusty conditions, the filter may require replacement more often.
- Replace engine air cleaner filter.  
*An Emission Control Service.*
- Rotate tires. See “Tire Inspection and Rotation” in the Index for proper rotation pattern and additional information. (*See footnote +.*)

DATE	
ACTUAL MILEAGE	SERVICED BY:

### 97,500 Miles (162 500 km)

- Rotate tires. See “Tire Inspection and Rotation” in the Index for proper rotation pattern and additional information. (*See footnote +.*)

DATE	
ACTUAL MILEAGE	SERVICED BY:

## Scheduled Maintenance

### *100,000 Miles (166 000 km)*

- Replace spark plugs.  
*An Emission Control Service.*
- Change automatic transaxle fluid and filter if the vehicle is mainly driven under one or more of these conditions:
  - In heavy city traffic where the outside temperature regularly reaches 90°F (32°C) or higher.
  - In hilly or mountainous terrain.
  - When doing frequent trailer towing.
  - Uses such as found in taxi, police or delivery service.
- If you haven't used your vehicle under severe service conditions listed previously and, therefore, haven't changed your automatic transaxle fluid, change both the fluid and filter.

### *150,000 Miles (240 000 km)*

- Drain, flush and refill cooling system (or every 60 months since last service, whichever occurs first). See "Engine Coolant" in the Index for what to use. Inspect hoses. Clean radiator, condenser, pressure cap and neck. Pressure test the cooling system and pressure cap.  
*An Emission Control Service.*

DATE	
ACTUAL MILEAGE	SERVICED BY:

DATE	
ACTUAL MILEAGE	SERVICED BY:

## **Part B: Owner Checks and Services**

Listed in this part are owner checks and services which should be performed at the intervals specified to help ensure the safety, dependability and emission control performance of your vehicle.

Be sure any necessary repairs are completed at once. Whenever any fluids or lubricants are added to your vehicle, make sure they are the proper ones, as shown in Part D.

### **At Each Fuel Fill**

*It is important for you or a service station attendant to perform these underhood checks at each fuel fill.*

#### **Engine Oil Level Check**

Check the engine oil level and add the proper oil if necessary. See “Engine Oil” in the Index for further details.

#### **Engine Coolant Level Check**

Check the engine coolant level and add DEX-COOL<sup>®</sup> coolant mixture if necessary. See “Engine Coolant” in the Index for further details.

#### **Windshield Washer Fluid Level Check**

Check the windshield washer fluid level in the windshield washer tank and add the proper fluid if necessary. See “Windshield Washer Fluid” in the Index for further details.

### **At Least Once a Month**

#### **Tire Inflation Check**

Make sure tires are inflated to the correct pressures. Don't forget to check your spare tire. See “Tires” in the Index for further details.

#### **Cassette Deck Service**

Clean cassette deck. Cleaning should be done every 50 hours of tape play. See “Audio Systems” in the Index for further details.

## **At Least Twice a Year**

### **Restraint System Check**

Make sure the safety belt reminder light and all your belts, buckles, latch plates, retractors and anchorages are working properly. Look for any other loose or damaged safety belt system parts. If you see anything that might keep a safety belt system from doing its job, have it repaired. Have any torn or frayed safety belts replaced.

Also look for any opened or broken air bag coverings, and have them repaired or replaced. (The air bag system does not need regular maintenance.)

### **Wiper Blade Check**

Inspect wiper blades for wear or cracking. Replace blade inserts that appear worn or damaged or that streak or miss areas of the windshield. Also see “Wiper Blades, Cleaning” in the Index.

### **Weatherstrip Lubrication**

Silicone grease on weatherstrips will make them last longer, seal better, and not stick or squeak. Apply silicone grease with a clean cloth. During very cold, damp weather more frequent application may be required. See “Recommended Fluids and Lubricants” in the Index.

## **Automatic Transaxle Check**

Check the transaxle fluid level; add if needed. See “Automatic Transaxle Fluid” in the Index. A fluid loss may indicate a problem. Check the system and repair if needed.

## **At Least Once a Year**

### **Key Lock Cylinders Service**

Lubricate the key lock cylinders with the lubricant specified in Part D.

### **Body Lubrication Service**

Lubricate all lock cylinders, hood latch assembly, secondary latch, pivots, spring anchor and release pawl and hood and door hinges, including those for the rear compartment, glove box door, console door and any folding seat hardware. Part D tells you what to use. More frequent lubrication may be required when exposed to a corrosive environment.

## Starter Switch Check

### CAUTION:

**When you are doing this check, the vehicle could move suddenly. If it does, you or others could be injured. Follow the steps below.**

1. Before you start, be sure you have enough room around the vehicle.
2. Firmly apply both the parking brake and the regular brake. See “Parking Brake” in the Index if necessary.

NOTE: Do not use the accelerator pedal, and be ready to turn off the engine immediately if it starts.

3. Try to start the engine in each gear. The starter should work only in PARK (P) or NEUTRAL (N). If the starter works in any other position, your vehicle needs service.

## Automatic Transaxle Shift Lock Control System Check

### CAUTION:

**When you are doing this check, the vehicle could move suddenly. If it does, you or others could be injured. Follow the steps below.**

1. Before you start, be sure you have enough room around the vehicle. It should be parked on a level surface.
2. Firmly apply the parking brake. See “Parking Brake” in the Index if necessary.

NOTE: Be ready to apply the regular brake immediately if the vehicle begins to move.

3. With the engine off, turn the key to the ON position, but don't start the engine. Without applying the regular brake, try to move the shift lever out of PARK (P) with normal effort. If the shift lever moves out of PARK (P), your vehicle needs service.

## Ignition Transaxle Lock Check

While parked, and with the parking brake set, try to turn the ignition key to OFF in each shift lever position.

- The key should turn to OFF only when the shift lever is in PARK (P).
- The key should come out only in OFF.

## Parking Brake and Automatic Transaxle PARK (P) Mechanism Check

### CAUTION:

**When you are doing this check, your vehicle could begin to move. You or others could be injured and property could be damaged. Make sure there is room in front of your vehicle in case it begins to roll. Be ready to apply the regular brake at once should the vehicle begin to move.**

Park on a fairly steep hill, with the vehicle facing downhill. Keeping your foot on the regular brake, set the parking brake.

- To check the parking brake's holding ability: With the engine running and transaxle in NEUTRAL (N), slowly remove foot pressure from the regular brake pedal. Do this until the vehicle is held by the parking brake only.
- To check the PARK (P) mechanism's holding ability: With the engine running, shift to PARK (P). Then release the parking brake followed by the regular brake.

## Underbody Flushing Service

At least every spring, use plain water to flush any corrosive materials from the underbody. Take care to clean thoroughly any areas where mud and other debris can collect.

## **Part C: Periodic Maintenance Inspections**

Listed in this part are inspections and services which should be performed at least twice a year (for instance, each spring and fall). *You should let your dealer's service department or other qualified service center do these jobs. Make sure any necessary repairs are completed at once.*

Proper procedures to perform these services may be found in a service manual. See "Service and Owner Publications" in the Index.

### **Steering, Suspension and Front Drive Axle Boot and Seal Inspection**

Inspect the front and rear suspension and steering system for damaged, loose or missing parts, signs of wear or lack of lubrication. Inspect the power steering lines and hoses for proper hook-up, binding, leaks, cracks, chafing, etc. Clean and then inspect the drive axle boot seals for damage, tears or leakage. Replace seals if necessary.

### **Exhaust System Inspection**

Inspect the complete exhaust system. Inspect the body near the exhaust system. Look for broken, damaged, missing or out-of-position parts as well as open seams, holes, loose connections or other conditions which could cause a heat build-up in the floor pan or could let exhaust fumes into the vehicle. See "Engine Exhaust" in the Index.

### **Engine Cooling System Inspection**

Inspect the hoses and have them replaced if they are cracked, swollen or deteriorated. Inspect all pipes, fittings and clamps; replace as needed. Clean the outside of the radiator and air conditioning condenser. To help ensure proper operation, a pressure test of the cooling system and pressure cap is recommended at least once a year.



## **Throttle System Inspection**

Inspect the throttle system for interference or binding, and for damaged or missing parts. Replace parts as needed. Replace any components that have high effort or excessive wear. Do not lubricate accelerator and cruise control cables.

## **Brake System Inspection**

Inspect the complete system. Inspect brake lines and hoses for proper hook-up, binding, leaks, cracks, chafing, etc. Inspect disc brake pads for wear and rotors for surface condition. Inspect other brake parts, including calipers, parking brake, etc. Check parking brake adjustment. You may need to have your brakes inspected more often if your driving habits or conditions result in frequent braking.

## Part D: Recommended Fluids and Lubricants

NOTE: Fluids and lubricants identified below by name, part number or specification may be obtained from your dealer.

USAGE	FLUID/LUBRICANT
Engine Oil	Engine oil with the American Petroleum Institute Certified for Gasoline Engines starburst symbol of the proper viscosity. To determine the preferred viscosity for your vehicle's engine, see "Engine Oil" in the Index.
Engine Coolant	50/50 mixture of clean, drinkable water and use only GM Goodwrench <sup>®</sup> DEX-COOL <sup>®</sup> or Havoline <sup>®</sup> DEX-COOL <sup>®</sup> Coolant. See "Engine Coolant" in the Index.
Hydraulic Brake System	Delco Supreme 11 <sup>®</sup> Brake Fluid (GM Part No. 12377967 or equivalent DOT-3 brake fluid).

USAGE	FLUID/LUBRICANT
Windshield Washer Solvent	GM Optikleen <sup>®</sup> Washer Solvent (GM Part No. 1051515) or equivalent.
Power Steering System	GM Power Steering Fluid (GM Part No. 1052884 - 1 pint, 1050017 - 1 quart, or equivalent).
Automatic Transaxle	DEXRON <sup>®</sup> -III Automatic Transmission Fluid.
Key Lock Cylinders	Multi-Purpose Lubricant, Superlube <sup>®</sup> (GM Part No. 12346241 or equivalent).
Hood Latch Assembly, Secondary Latch, Pivots, Spring Anchor and Release Pawl	Lubriplate <sup>®</sup> Lubricant Aerosol (GM Part No. 12346293 or equivalent) or lubricant meeting requirements of NLGI # 2, Category LB or GC-LB.
Hood and Door Hinges	Multi-Purpose Lubricant, Superlube <sup>®</sup> (GM Part No. 12346241 or equivalent).
Weatherstrip Conditioning	Dielectric Silicone Grease (GM Part No. 12345579 or equivalent).

## Part E: Maintenance Record

After the scheduled services are performed, record the date, odometer reading and who performed the service in the boxes provided after the maintenance interval. Any additional information from “Owner Checks and Services” or “Periodic Maintenance” can be added on the following record pages. Also, you should retain all maintenance receipts. Your owner information portfolio is a convenient place to store them.

<b>Maintenance Record</b>			
<b>DATE</b>	<b>ODOMETER READING</b>	<b>SERVICED BY</b>	<b>MAINTENANCE PERFORMED</b>

## Maintenance Record

DATE	ODOMETER READING	SERVICED BY	MAINTENANCE PERFORMED

## Maintenance Record

DATE	ODOMETER READING	SERVICED BY	MAINTENANCE PERFORMED



## Section 8 Customer Assistance Information

---

Here you will find out how to contact Oldsmobile if you need assistance. This section also tells you how to obtain service publications and how to report any safety defects.

- |     |  |      |  |
|-----|--|------|--|
| 8-2 | Customer Satisfaction Procedure                              | 8-7  | Canadian Roadside Assistance                             |
| 8-4 | Customer Assistance for Text Telephone (TTY) Users           | 8-7  | Courtesy Transportation                                  |
| 8-4 | Customer Assistance Offices                                  | 8-9  | Warranty Information                                     |
| 8-5 | GM Mobility Program for Persons with Disabilities            | 8-10 | Reporting Safety Defects to the United States Government |
| 8-6 | Oldsmobile Roadside Assistance Program Features and Benefits | 8-10 | Reporting Safety Defects to the Canadian Government      |
|     |  | 8-11 | Reporting Safety Defects to General Motors               |

## Customer Satisfaction Procedure



Your satisfaction and goodwill are important to your dealer and to Oldsmobile. Normally, any concerns with the sales transaction or the operation of your vehicle will be resolved by your dealer's sales or service departments. Sometimes, however, despite the best intentions of all concerned, misunderstandings can occur. If your concern has not been resolved to your satisfaction, the following steps should be taken:

**STEP ONE** -- Discuss your concern with a member of dealership management. Normally, concerns can be quickly resolved at that level. If the matter has already been reviewed with the sales, service or parts manager, contact the owner of the dealership or the general manager.

**STEP TWO** -- If after contacting a member of dealership management, it appears your concern cannot be resolved by the dealership without further help, contact the Oldsmobile Customer Assistance Center by calling 1-800-442-6537. In Canada, contact GM of Canada Customer Communication Centre in Oshawa by calling 1-800-263-3777 (English) or 1-800-263-7854 (French).

We encourage you to call the toll-free number in order to give your inquiry prompt attention. Please have the following information available to give the Customer Assistance Representative:

- Vehicle Identification Number (This is available from the vehicle registration or title, or the plate at the top left of the instrument panel and visible through the windshield.)
- Dealership name and location
- Vehicle delivery date and present mileage

When contacting Oldsmobile, please remember that your concern will likely be resolved at a dealer's facility. That is why we suggest you follow Step One first if you have a concern.

**STEP THREE** -- Both General Motors and your dealer are committed to making sure you are completely satisfied with your new vehicle. However, if you continue to remain unsatisfied after following the procedure outlined in Steps One and Two, you should file with the GM/BBB Auto Line Program to enforce any additional rights you may have. Canadian owners refer to your Warranty and Owner Assistance Information booklet for information on the Canadian Motor Vehicle Arbitration Plan (CAMVAP).



The BBB Auto Line Program is an out of court program administered by the Council of Better Business Bureaus to settle automotive disputes regarding vehicle repairs or the interpretation of the New Vehicle Limited Warranty. Although you may be required to resort to this informal dispute resolution program prior to filing a court action, use of the program is free of charge and your case will generally be heard within 40 days. If you do not agree with the decision given in your case, you may reject it and proceed with any other venue for relief available to you.

You may contact the BBB using the toll-free telephone number or write them at the following address:

BBB Auto Line  
Council of Better Business Bureaus, Inc.  
4200 Wilson Boulevard  
Suite 800  
Arlington, VA 22203-1804  
Telephone: 1-800-955-5100

This program is available in all 50 states and the District of Columbia. Eligibility is limited by vehicle age, mileage and other factors. General Motors reserves the right to change eligibility limitations and/or discontinue its participation in this program.

## Customer Assistance for Text Telephone (TTY) Users

To assist customers who are deaf, hard of hearing, or speech-impaired and who use Text Telephones (TTYs), Oldsmobile has TTY equipment available at its Customer Assistance Center. Any TTY user can communicate with Oldsmobile by dialing: 1-800-833-OLDS (6537). (TTY users in Canada can dial 1-800-263-3830.)

## Customer Assistance Offices

Oldsmobile encourages customers to call the toll-free number for assistance. If a U.S. customer wishes to write to Oldsmobile, the letter should be addressed to Oldsmobile's Customer Assistance Center.

### United States

Oldsmobile Customer Assistance Center  
P.O. Box 33171  
Detroit, MI 48232-5171  
1-800-442-6537  
1-800-833-6537 (For Text Telephone devices (TTYs))  
Roadside Assistance: 1-800-442-OLDS (6537)

**From:**  
Puerto Rico: 1-800-496-9992 (English)  
1-800-496-9993 (Spanish)

U.S. Virgin Islands: 1-800-496-9994

Fax Number: 313-381-0022

## Canada

General Motors of Canada Limited  
Customer Communication Centre, 163-005  
1908 Colonel Sam Drive  
Oshawa, Ontario L1H 8P7

1-800-263-3777 (English)

1-800-263-7854 (French)

1-800-263-3830 (For Text Telephone devices (TTYs))

Roadside Assistance: 1-800-268-6800

## Mexico, Central America and Caribbean Islands/Countries (Except Puerto Rico and U.S. Virgin Islands)

General Motors de Mexico, S. de R.L. de C.V.  
Customer Assistance Center  
Paseo de la Reforma # 2740  
Col. Lomas de Bezares  
C.P. 11910, Mexico, D.F.  
0-1-800-508-0000  
Long Distance: 011-52 - 53 29 0 800

## GM Mobility Program for Persons with Disabilities

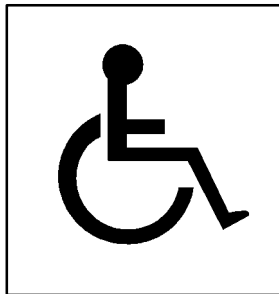

This program, available to qualified applicants, can reimburse you up to \$1,000 toward aftermarket driver or passenger adaptive equipment you may require for your vehicle (hand controls, wheelchair/scooter lifts, etc.).

This program can also provide you with free resource information, such as area driver assessment centers and mobility equipment installers. The program is available for a limited period of time from the date of vehicle purchase/lease. See your dealer for more details or call the GM Mobility Assistance Center at 1-800-323-9935. Text telephone (TTY) users, call 1-800-833-9935.

GM of Canada also has a Mobility Program. Call 1-800-GM-DRIVE (463-7483) for details. When calling from outside Canada, please dial 1-905-644-3063. All TTY users call 1-800-263-3830.

## Oldsmobile Roadside Assistance Program Features and Benefits

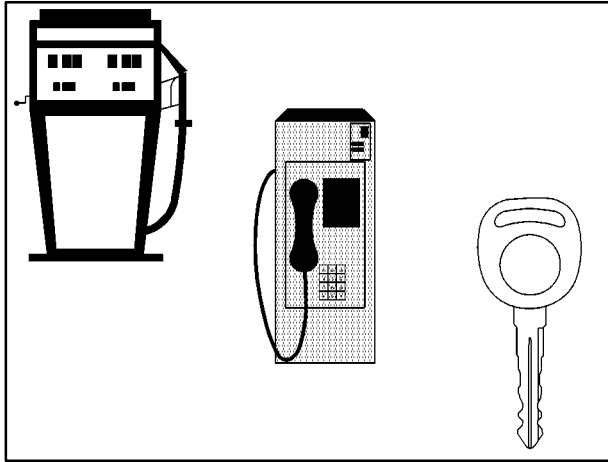

### Security While You Travel

1-800-442-OLDS (6537)

As the proud owner of a new Oldsmobile vehicle, you are automatically enrolled in the Oldsmobile Roadside Assistance program. This value-added service is intended to provide you with peace of mind as you drive in the city or travel the open road.

Oldsmobile's Roadside Assistance toll-free number is staffed by courteous and capable Roadside Assistance Representatives who are available 24 hours a day, 365 days a year.

We will provide the following services during the Bumper-to-Bumper warranty period, at no expense to you:

- Fuel delivery
- Lock-out service (identification required)
- Tow to the nearest dealership for warranty service or in the event of a vehicle-disabling accident
- Flat tire change
- Jump starts
- Minor repairs to disabled vehicles
- Assistance when vehicle is mired in sand, mud or snow
- Trip routing
- Trip interruption expense benefits
- Dealership locator service

Oldsmobile Roadside Assistance specifically excludes coverage for mounting, dismounting or changing of snow tires, chains or other traction devices.

In some cases, where service is impractical, the driver may be authorized to obtain other service for which reimbursement is provided.

In many instances, mechanical failures are covered under Oldsmobile's comprehensive warranty. However, when other services are utilized, our Roadside Assistance Representatives will explain any payment obligations you might incur.

For prompt and efficient assistance when calling, please provide the following to the Roadside Assistance Representative:

- Location of vehicle
- Telephone number of your location
- Vehicle model, year and color
- Mileage of vehicle
- Vehicle Identification Number (VIN)
- Vehicle license plate number

Oldsmobile reserves the right to limit services or reimbursement to an owner or driver when, in Oldsmobile's judgement, the claims become excessive in frequency or type of occurrence.

While we hope you never have the occasion to use our service, it is added security while traveling for you and your family. Remember, we're only a phone call away. Oldsmobile Roadside Assistance -- 1-800-442-OLDS (6537), text telephone (TTY) users, call 1-888-889-2438.

## **Canadian Roadside Assistance**

Vehicles purchased in Canada have an extensive roadside assistance program accessible from anywhere in Canada or the United States. Please refer to the separate brochure provided by the dealer or call 1-800-268-6800 for emergency services.

## **Courtesy Transportation**

Oldsmobile has always exemplified quality and value in its offering of motor vehicles. To enhance your ownership experience, we and our participating dealers are proud to offer Courtesy Transportation, a customer support program for new vehicles.

The Courtesy Transportation program is offered to retail purchase/lease customers in conjunction with the Bumper-to-Bumper coverage provided by the New Vehicle Limited Warranty. Several transportation options are available when warranty repairs are required. This will reduce your inconvenience during warranty repairs.

## **Plan Ahead When Possible**

When your vehicle requires warranty service, you should contact your dealer and request an appointment. By scheduling a service appointment and advising your service consultant of your transportation needs, your dealer can help minimize your inconvenience. If your vehicle cannot be scheduled into the service department immediately, keep driving it until it can be scheduled for service, unless, of course, the problem is safety-related. If it is, please call your dealership, let them know this, and ask for instructions.

If the dealer requests that you simply drop the vehicle off for service, you are urged to do so as early in the work day as possible to allow for same day repair.

## **Transportation Options**

Warranty service can generally be completed while you wait. However, if you are unable to wait, Oldsmobile helps minimize your inconvenience by providing several transportation options. Depending on the circumstances, your dealer can offer you one of the following:

### **Shuttle Service**

Participating dealers can provide you with shuttle service to get you to your destination with minimal interruption of your daily schedule. This includes a one way shuttle ride to a destination up to 10 miles from the dealership.

## **Public Transportation or Fuel Reimbursement**

If your vehicle requires overnight warranty repairs, reimbursement up to \$30 per day (five days maximum) may be available for the use of public transportation such as taxi or bus. In addition, should you arrange transportation through a friend or relative, reimbursement for reasonable fuel expenses up to \$10 per day (five day maximum) may be available. Claim amounts should reflect actual costs and be supported by original receipts.

## **Courtesy Rental Vehicle**

When your vehicle is unavailable due to overnight warranty repairs, your dealer may arrange to provide you with a courtesy rental vehicle or reimburse you for a rental vehicle you obtained, at actual cost, up to a maximum of \$30.00 per day supported by receipts. This requires that you sign and complete a rental agreement and meet state, local and rental vehicle provider requirements. Requirements vary and may include minimum age requirements, insurance coverage, credit card, etc. You are responsible for fuel usage charges and may also be responsible for taxes, levies, usage fees, excessive mileage or rental usage beyond the completion of the repair.

Generally it is not possible to provide a like-vehicle as a courtesy rental.

## **Additional Program Information**

Courtesy Transportation is available during the Bumper-to-Bumper warranty coverage period, but it *is not* part of the New Vehicle Limited Warranty. A separate booklet entitled “Warranty and Owner Assistance Information” furnished with each new vehicle provides detailed warranty coverage information.

Courtesy Transportation is available only at participating dealers and all program options, such as shuttle service, may not be available at every dealer. Please contact your dealer for specific information about availability. All Courtesy Transportation arrangements will be administered by appropriate dealer personnel.

**Canadian Vehicles:** For warranty repairs during the Complete Vehicle Coverage period of the General Motors of Canada New Vehicle Limited Warranty, alternative transportation may be available under the Courtesy Transportation Program. Please consult your dealer for details.

*General Motors reserves the right to unilaterally modify, change or discontinue Courtesy Transportation at any time and to resolve all questions of claim eligibility pursuant to the terms and conditions described herein at its sole discretion.*

## **Warranty Information**

Your vehicle comes with a separate warranty booklet that contains detailed warranty information.

## **REPORTING SAFETY DEFECTS TO THE UNITED STATES GOVERNMENT**

If you believe that your vehicle has a defect which could cause a crash or could cause injury or death, you should immediately inform the National Highway Traffic Safety Administration (NHTSA), in addition to notifying General Motors.

If NHTSA receives similar complaints, it may open an investigation, and if it finds that a safety defect exists in a group of vehicles, it may order a recall and remedy campaign. However, NHTSA cannot become involved in individual problems between you, your dealer or General Motors.

To contact NHTSA, you may either call the Auto Safety Hotline toll-free at 1-800-424-9393 (or 366-0123 in the Washington, D.C. area) or write to:

NHTSA, U.S. Department of Transportation  
Washington, D.C. 20590

You can also obtain other information about motor vehicle safety from the hotline.

## **REPORTING SAFETY DEFECTS TO THE CANADIAN GOVERNMENT**

If you live in Canada, and you believe that your vehicle has a safety defect, you should immediately notify Transport Canada, in addition to notifying General Motors of Canada Limited. You may write to:

Transport Canada  
330 Sparks Street  
Tower C  
Ottawa, Ontario K1A 0N5

## **REPORTING SAFETY DEFECTS TO GENERAL MOTORS**

In addition to notifying NHTSA (or Transport Canada) in a situation like this, we certainly hope you'll notify us. Please call us at 1-800-442-6537, or write:

Oldsmobile Customer Assistance Center  
P.O. Box 33171  
Detroit, MI 48232-5171

In Canada, please call us at 1-800-263-3777 (English) or 1-800-263-7854 (French). Or, write:

General Motors of Canada Limited  
Customer Communication Centre, 163-005  
1908 Colonel Sam Drive  
Oshawa, Ontario L1H 8P7



# 2001 OLDSMOBILE SERVICE PUBLICATIONS ORDERING INFORMATION

*The following publications covering the operation and servicing of your vehicle can be purchased by filling out the Service Publication Order Form in this book and mailing it in with your check, money order, or credit card information to Helm, Incorporated (address below.)*

## CURRENT PUBLICATIONS FOR 2001 OLDSMOBILE

### SERVICE MANUALS

Service Manuals have the diagnosis and repair information on engines, transmission, axle, suspension, brakes, electrical, steering, body, etc.  
RETAIL SELL PRICE: \$120.00

### TRANSMISSION, TRANSAXLE, TRANSFER CASE UNIT REPAIR MANUAL

This manual provides information on unit repair service procedures, adjustments and specifications for the 2001 GM transmissions, transaxles and transfer cases.  
RETAIL SELL PRICE: \$50.00

### SERVICE BULLETINS

Service Bulletins give technical service information needed to knowledgeable service General Motors cars and trucks. Each bulletin contains instructions to assist in the diagnosis and service of your vehicle.

### OWNER'S INFORMATION

Owner publications are written directly for Owners and intended to provide basic operational information about the vehicle. The owner's manual will include the Maintenance Schedule for all models.

In-Portfolio: Includes a Portfolio, Owner's Manual and Warranty Booklet.  
RETAIL SELL PRICE: \$20.00

Without Portfolio: Owner's Manual only.  
RETAIL SELL PRICE: \$15.00

### CURRENT & PAST MODEL ORDER FORMS

Service Publications are available for current and past model GM vehicles. To request an order form, please specify year and model name of the vehicle.

**PLEASE COMPLETE THE ORDER FORM SHOWN ON  
THE FOLLOWING PAGE AND MAIL TO:**

Helm, Incorporated • P.O. Box 07130 • Detroit, MI 48207

**OR ORDER TOLL FREE: 1-800-551-4123**

Monday-Friday 8:00 AM – 6:00 PM Eastern Time

Visit Helm, Inc. on the World Wide Web at: [www.helminc.com](http://www.helminc.com)

For Credit Card Orders Only (VISA–MasterCard–Discover)

**ORDER TOLL FREE***(NOTE: For Credit Card Holders Only)***1-800-551-4123**

(Monday-Friday 8:00 AM – 6:00 PM EST)

FAX Orders Only 1-313-865-5927

Orders will be mailed within 10 days of receipt. Please allow adequate time for postal service. If further information is needed, write to the address shown below or call 1-800-551-4123. Material cannot be returned for credit without packing slip with return information within 30 days of delivery. On returns, a re-stocking fee may be applied against the original order.

2 0 0 1 G M	PUBLICATION FORM NUMBER	ITEM DESCRIPTION	VEHICLE MODEL		QTY.	PRICE EACH*	TOTAL PRICE
			NAME	YEAR			
		Service Manual		2001		\$120.00	
		Car & Light Truck Transmission Unit Repair		2001		\$50.00	
		Owner's Manual In Portfolio		2001		\$20.00	
		Owner's Manual Without Portfolio		2001		\$15.00	

<b>S H I P T O</b>	<b>NOTE:</b> Dealers and Companies please provide dealer or company name, and also the name of the person to whose attention the shipment should be sent. Mail completed order form to: HELM, INCORPORATED • P.O. Box 07130 • Detroit, MI 48207 For purchases outside U.S.A. please write to the above address for quotation.		<b>P A Y M E N T</b>	<input type="checkbox"/> <b>Check or Money</b> Order payable to <b>Helm, Inc. (USA funds</b> only — <i>do not send cash.</i> )	<b>TOTAL MATERIAL</b>	
	_____			<input type="checkbox"/> MasterCard	Michigan Purchasers add 6% sales tax	
	(CUSTOMER'S NAME) (ATTENTION)			<input type="checkbox"/> VISA	U.S. Order Processing <b>\$6.00</b>	
	(STREET ADDRESS—NO P.O. BOX NUMBERS)			<input type="checkbox"/> Discover	Canadian Postage	
	(CITY) (STATE) (ZIP CODE)			Account Number: <input type="text"/> <input type="text"/> <input type="text"/> <input type="text"/> <input type="text"/> <input type="text"/> <input type="text"/> <input type="text"/> <input type="text"/> <input type="text"/> <input type="text"/> <input type="text"/> <input type="text"/> <input type="text"/> <input type="text"/> <input type="text"/> <input type="text"/> <input type="text"/> <input type="text"/> <input type="text"/>	<b>GRAND TOTAL</b>	
DAYTIME TELEPHONE NO. ( ) _____ AREA CODE		Expiration Date mo/yr: <input type="text"/> <input type="text"/> <input type="text"/> <input type="text"/>	Check here if your billing address is different from your shipping address shown. <input type="checkbox"/>			
		CUSTOMER SIGNATURE _____				

GM-OLD-ORD99

\*(Prices are subject to change without notice and without incurring obligation. Allow ample time for delivery.)

Note to Canadian Customers: All listed prices are quoted in U.S. funds. Canadian residents are to make checks payable in U.S. funds.