

OLD SMODBILE



1994 BRAVADA
OWNER'S MANUAL



ETR[®] AM/FM Stereo with Cassette Player and Equalizer

The following information is important if your vehicle is equipped with an ETR[®] AM/FM stereo with a cassette player and equalizer. This information replaces the existing information from "ETR[®] AM/FM Stereo with Cassette Player and Equalizer" on pages 96 and 97 of your Owner's Manual.

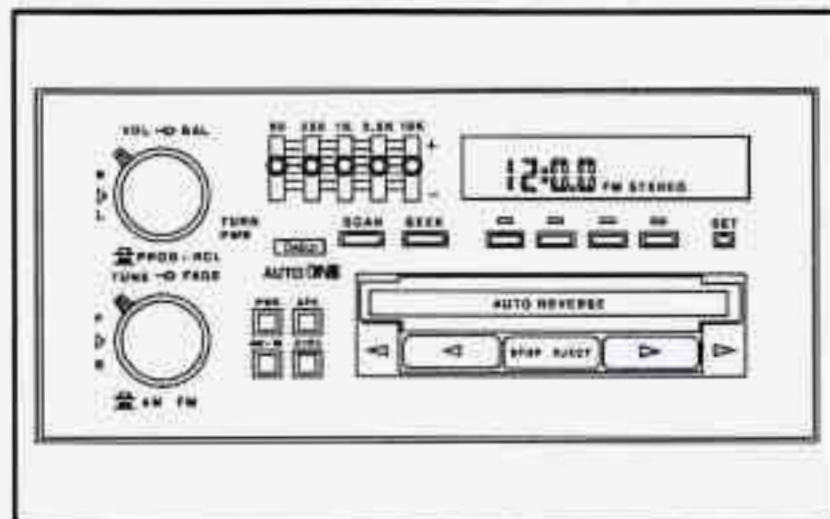

This part tells you how your ETR[®] AM-FM stereo audio cassette system with equalizer works:

The Upper Knob

The upper knob does these four things:

- It controls the volume. The **VOL** knob increases volume when rotated to the right.
- It lets you know what station you're listening to. (When the radio is on, push the knob to display the station.)
- It tells you the time. (When the ignition is off, push the knob to display the time.)
- It allows you to hear the other side of the tape. (Press the knob while the cassette is playing.)

The control behind the upper knob moves the sound between your left and right speakers.

The Lower Knob

Turn the lower knob to choose radio stations. Push it to get AM or FM. The control behind the lower knob moves the sound between your front and rear speakers.

Tone Levers (Equalizer)

The 5 levers near the upper knob control the tone of your radio.

Use the levers to set the bass, midrange, and treble until you get the sound you prefer. The **60** and **250** levers adjust the bass; **1K** is midrange; **3.5K** and **10K** adjust the treble.

PWR (Power)

The **PWR** button turns your system on and off.

AM-ST Button

Push this button if you want AM stereo. ("STEREO" will be displayed when you are receiving an AM stereo station.)

Cr02 Button

The **Cr02** button lets you set the system for the type of cassette being played. If you are playing chrome or metal tapes, push the **Cr02** button in. If you are playing standard tapes, make sure the button is out.

DNR[®]

Your audio system has automatic Dynamic Noise Reduction. It helps remove background hiss noise from the radio or tape player.

DNR[®] is a registered trademark of the National Semiconductor Corporation.

Pushbuttons

The four pushbuttons let you return to favorite stations.

You can set the pushbuttons for up to eight favorite stations (4 AM and 4 FM). Just:

- Tune in the station.
- Push **SET**. (**SET** appears in the VF display for a few seconds.)
- Within 5 seconds, push one of the four pushbuttons. Whenever you push the button, the preset station will appear.

Repeat the steps for each pushbutton.

NOTE: You can preset 3 more stations on each band by pushing a pair of buttons next to each other at the same time. Just:

- Tune in the station.
- Push **SET**. (**SET** appears in the VF display for a few seconds.)
- Within 5 seconds, push two buttons next to each other at the same time. Whenever you push that pair of buttons, the preset station will return.

Repeat these steps for each pair of buttons.

SCAN Button

When you push this button, the radio will scan to the first available station, pause a few seconds, and then scan to the next available station. The radio will continue to scan available stations until you press **SCAN** again.

SEEK Button

This chooses stations also, but it doesn't keep changing stations as **SCAN** does. When you push **SEEK**, the radio goes to the next available station and stays there.

To Play A Cassette

Your tape player is built to work best with tapes that are 30 to 45 minutes long on each side. Tapes longer than that are so thin they may not work well in this player.

To play a cassette tape:

- Have the radio on.
- Insert the tape squarely through the tape door.

The side with the tape visible goes in first. If you hear nothing or hear just garbled sound, the tape may not be inserted properly.

If this happens, push **STOP-EJECT** to remove the tape and insert the tape again.

Once the tape is playing, use the upper and lower knobs for volume and balance, just as you do for the radio. The arrows show which side of the tape is playing.

- To go **forward** to another part of the tape, push ►.
- To go **backward**, push ◀. To stop the tape, push the other button lightly.
- To go from one side of the tape to the other, push in the upper knob on your radio. To remove or stop the tape, push **STOP-EJECT**.

APS (Automatic Program Search)

Press this button to activate the automatic program search. When the ► button is pressed, the tape will rapidly advance to the beginning of the next selection. When the ◀ button is pressed, the tape will rapidly reverse to the beginning of the current selection.

PART # 94BRAVADA001

1994 OLDSMOBILE BRAVADA OWNER'S MANUAL SUPPLEMENT



Table of Contents

	<i>The Heritage of Oldsmobile</i>	<i>3</i>
	<i>How to Use this Manual</i>	<i>6</i>
Part 1	<i>Seats & Restraint Systems</i>	<i>11</i>
2	<i>Features & Controls</i>	<i>37</i>
3	<i>Comfort Controls & Audio Systems</i>	<i>91</i>
4	<i>Your Driving and the Road</i>	<i>105</i>
5	<i>Problems on the Road</i>	<i>139</i>
6	<i>Service & Appearance Care</i>	<i>161</i>
7	<i>Maintenance Schedule</i>	<i>203</i>
8	<i>Customer Assistance Information</i> <i>Includes "Reporting Safety Defects" on page 224</i>	<i>221</i>
9	<i>Index</i>	<i>233</i>
	<i>Service Station Information</i>	<i>Last Page</i>

Important Notes About this Manual

Please keep this manual in your Oldsmobile, so it will be there if you ever need it when you're on the road. If you sell the vehicle, please leave this manual in it so the new owner can use it.

This manual includes the latest information at the time it was printed. We reserve the right to make changes in the product after that time without further notice.

About Driving Your Bravada

As with other vehicles of this type, failure to operate this vehicle correctly may result in loss of control or an accident. Be sure to read the "on pavement" and "off-road" driving guidelines in this manual. (See the *Index* under *Driving Guidelines* and *Off-Road Driving*.)

Published by
Oldsmobile Division
General Motors
Corporation
920 Townsend Street
Lansing, Michigan 48921

The word *Oldsmobile* and the Oldsmobile rocket emblem are registered trademarks of General Motors Corporation.

The word *Delco* is a registered trademark of General Motors Corporation.

The Heritage of Oldsmobile

Engineering with a purpose. It's at the heart of every Oldsmobile. Your new Oldsmobile continues a 97-year tradition of engineering excellence.

That tradition was born in Lansing, Michigan, on August 21, 1897, when Ransom E. Olds began building a horseless carriage "in as nearly a perfect manner as possible." Soon, Oldsmobiles rolled off the nation's first assembly line.

Innovation and refinement have always set Oldsmobiles apart. In 1939, Oldsmobile introduced the celebrated Hydra-Matic transmission, a four-speed forerunner of today's advanced systems. In 1948, the high-spirited Rocket V8 engine set standards for performance.



1941

1931

A Step Ahead

In 1966, Toronado made front-wheel-drive news, including Motor Trend's "Car of the Year." Still breaking new ground, the 1974 "Toro" became the first car equipped with a production "air bag."

Recent Oldsmobile engineering has created exciting advancements like the responsive Quad 4 engine. Versions of the 4-cylinder, 16-valve Quad 4 propelled Oldsmobiles on roads and racetracks to new standards of economy and performance.

Today, the all-wheel-drive security of SmartTrak in the Oldsmobile Bravada continues that proud tradition of meaningful technology.



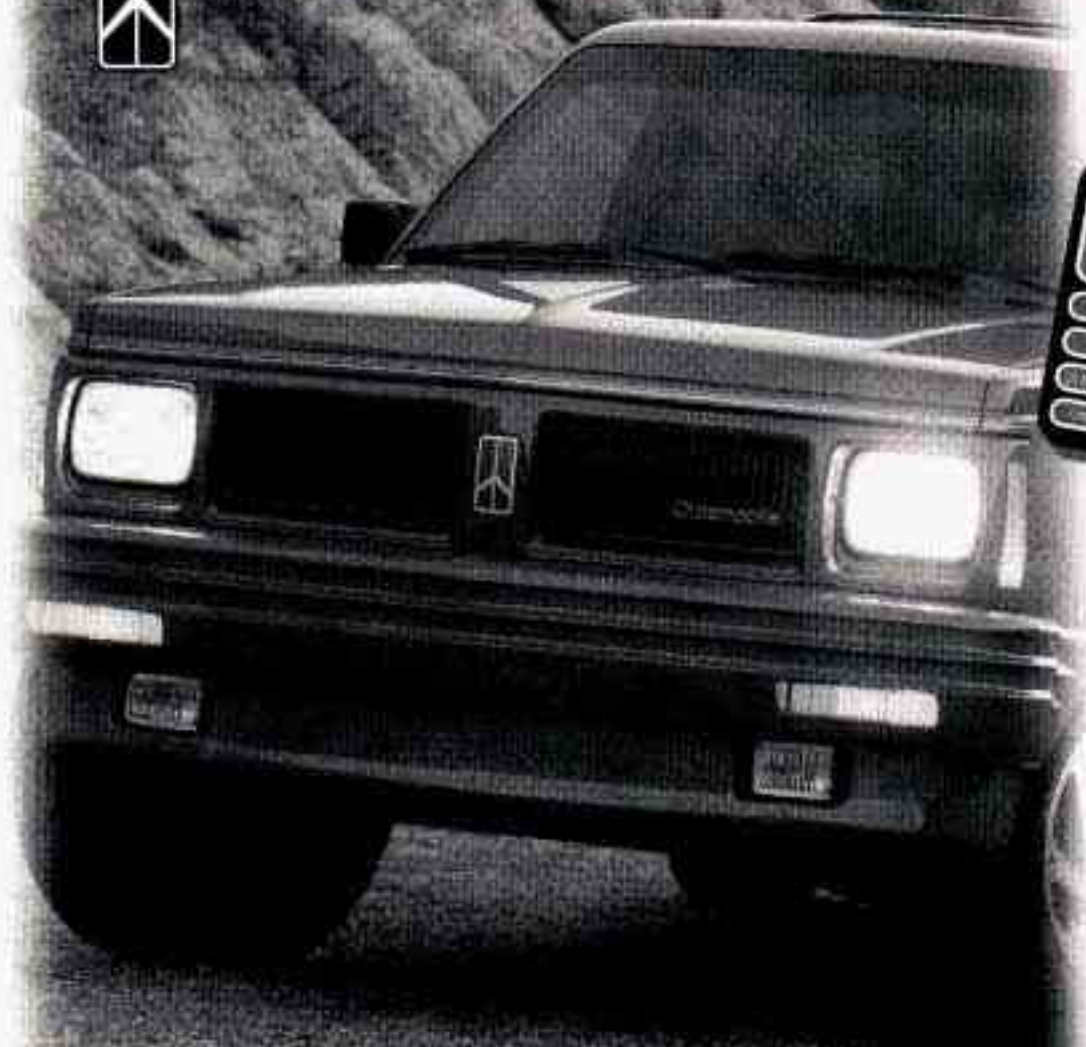

The Security of Owner Satisfaction

The quality we built into your new Oldsmobile gives us the confidence to back it with the Oldsmobile Edge—the most comprehensive owner satisfaction program in the industry. The Edge gives you 24-hour roadside assistance, Bumper-to-Bumper Warranty protection, even free transportation while your vehicle is in for warranty service. With the Oldsmobile Edge, we've pledged to make your ownership experience a great one.



J. D. Rock
General Manager

How to Use this Manual

MANY PEOPLE READ THEIR OWNER'S manual from beginning to end when they first receive their new vehicle. This will help you learn about the features and controls for your vehicle. In this manual, you'll find that pictures and words work together to explain things quickly.

There are nine parts with thumb-tabbed pages in this manual. Each part begins with a brief list of contents, so you can usually tell at a glance if that part contains the information you want.

You can bend the manual slightly to reveal the tabs that help you find a part.

Part 1: Seats & Restraint Systems

This part tells you how to use your seats and safety belts properly.

Part 2: Features & Controls

This part explains how to start and operate your Oldsmobile.

Part 3: Comfort Controls & Audio Systems

This part tells you how to adjust the ventilation and comfort controls and how to operate your audio system.

Part 4: Your Driving and the Road

Here you'll find helpful information and tips about the road and how to drive under different conditions.

Part 5: Problems on the Road

This part tells you what to do if you have a problem while driving, such as a flat tire or engine overheating.

Part 6: Service & Appearance Care

Here the manual tells you how to keep your Oldsmobile running properly and looking good.

Part 7: Maintenance Schedule

This part tells you when to perform vehicle maintenance and what fluids and lubricants to use.

Part 8: Customer Assistance Information

This part includes important information about reporting safety defects and gives you details about the "Roadside Assistance" program. You will also find customer satisfaction phone numbers (including customer satisfaction numbers for the hearing and speech impaired) as well as the mediation/arbitration procedure. We've also included ordering information for service publications in this part.

Part 9: Index

Here's an alphabetical listing of almost every subject in this manual. You can use it to quickly find something you want to read.

Service Station Information:

This is a quick reference of service information. You can find it on the last page of this manual.

How to Use this Manual

Safety Warnings and Symbols

You will find a number of safety cautions in this book. We use a box with gray background and the word CAUTION to tell you about things that could hurt you if you were to ignore the warning.

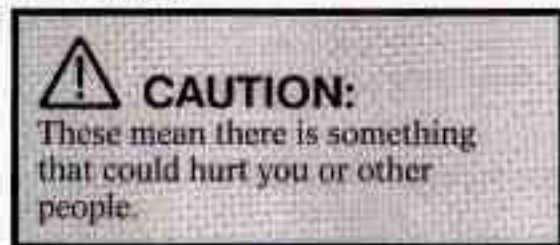

In the gray caution area, we tell you what the hazard is. Then we tell you what to do to help avoid or reduce the hazard. Please read these cautions. If you don't, you or others could be hurt.

You will also find a circle with a slash through it in this book. This safety symbol means:

Don't
Don't do this
Don't let this happen



Vehicle Damage Warnings

Also, in this book you will find these notices:

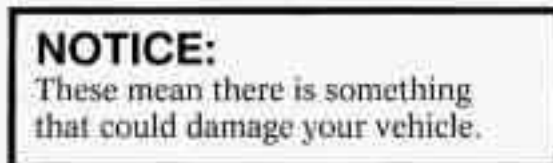

In the notice area, we tell you about something that can damage your vehicle. Many times, this damage would not be covered by your warranty, and it could be costly. But the notice will tell you what to do to help avoid the damage.

When you read other manuals, you might see CAUTION and NOTICE warnings in different colors or in different words.

You'll also see warning labels on your vehicle. They use yellow for cautions, blue for notices and the words CAUTION or NOTICE.

Vehicle Symbols

These are some of the symbols you will find on your vehicle. For example, these symbols are used on an original battery:

Caution Possible Injury



Protect Eyes by Shielding



Caustic Battery Acid Could Cause Burns



Avoid Sparks or Flames



Spark or Flame Could Explode Battery



These symbols are important for you and your passengers whenever your vehicle is driven:

Fasten Safety Belts



Door Lock/Unlock



These symbols have to do with your lights:

Master Lighting Switch



Turn Signal Direction



Hazard Warning Flashers



Headlight High Beam



Parking Lights

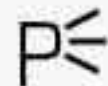

Fog Lights



How to Use this Manual

These symbols are on some of your controls:

Windshield Wipers



Windshield Washer



Windshield Defroster



Rear Window Defogger

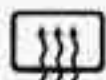

Rear Window Wiper

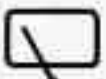

Rear Window Wiper/Washer



Ventilating Fan



Power Window



These symbols are used on warning and indicator lights:

Engine Coolant Temperature



Battery Charging System



Fuel



Engine Oil Pressure



Brake



Anti-Lock Brakes



Here are some other symbols you may see:

Fuse



Tailgate Window



Lighter



Horn



Speaker



Hood Release





Here you'll find information about the seats in your Oldsmobile and how to use your safety belts properly. You can also learn about some things you should not do with safety belts.

Part 1

Seats & Restraint Systems

Seats and Seat Controls	12
Folding Rear Seat	14
Safety Belts	14
How to Wear Safety Belts Properly	18
Driver Position	18
Safety Belt Use During Pregnancy	21
Right Front Passenger Position	21
Rear Seat Passengers	22
Children	25
Smaller Children and Babies	25
Child Restraints	26
Larger Children	32
Safety Belt Extender	34
Replacing Safety Belts After a Crash	34

Seats & Restraint Systems

■ Seats and Seat Controls

This section tells you about the seats—how to adjust them—and also about reclining seatbacks and the folding rear seat.

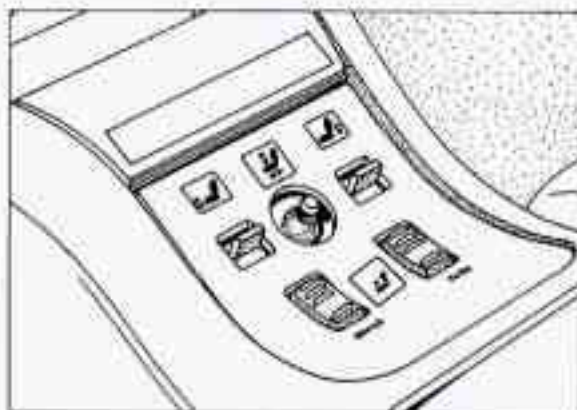

Power Seat

To adjust the driver's power seat:

 **(Left Control):** Raise the front of the seat by pressing the switch forward. Lower the front of the seat by pressing the switch back.

 **(Center Control):** Move the seat forward by pushing the control left. Move the seat back by pushing the control right.

Raise the seat by pushing the control forward. Lower the seat by pushing the control back.

 **(Right Control):** Raise the rear of the seat by pressing the switch forward. Lower the rear of the seat by pressing the switch back.

Lumbar Controls

To adjust lower back support on the driver's seat:

Press the front of the **DRIVER**  switch to increase support. Press the back of the switch to decrease support.

To adjust lower back support on the passenger's seat:

Press the front of the **PASS**  switch to increase support. Press the back of the switch to decrease support.

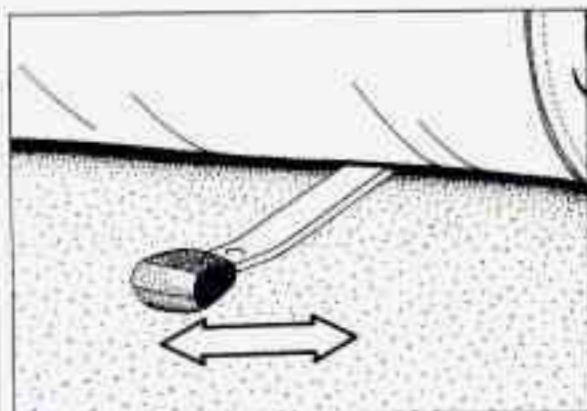

Manual Front Seat

Move the control lever under the front of the passenger's seat to unlock it. Slide the seat to where you want it. Then release the lever and try to move the seat with your body, to make sure the seat is locked into place.

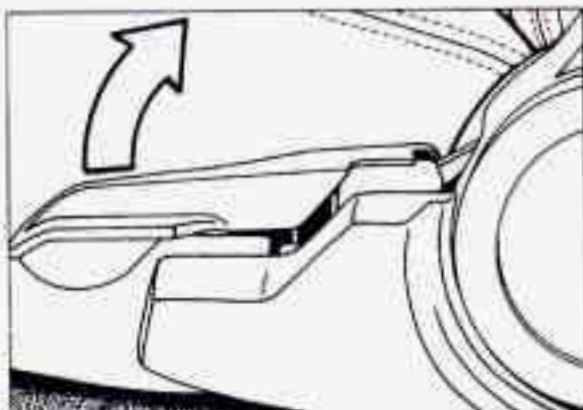

Reclining Front Seatbacks

To adjust the seatback, lift the lever on the outside of your seat. Move the seatback where you want it, then release the lever.

But don't have a seatback reclined if your vehicle is moving.

Pull up on the lever and the seatback will go to its original upright position.



CAUTION:

Sitting in a reclined position when your vehicle is in motion can be dangerous. Even if you buckle up, your safety belts can't do their job when you're reclined like this. The shoulder belt can't do its job because it won't be against your body. Instead, it will be in front of you. In a crash you could go into it, receiving neck or other injuries.

The lap belt can't do its job either. In a crash the belt could go up over your abdomen. The belt forces would be there, not at your pelvic

CAUTION (Continued)

Seats & Restraint Systems

CAUTION (Continued)

bones. This could cause serious internal injuries.

For proper protection when the vehicle is in motion, have the seatback upright. Then sit well back in the seat and wear your safety belt properly.

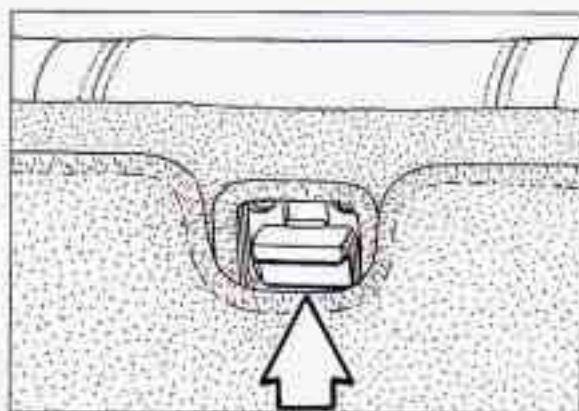

Folding Rear Seat

You can fold the rear seatback down for more cargo space. The latch is in the upper center of the rear of the seatback.

To lower the seatback, push it rearward as you pull up on the latch. Then fold the seatback forward to the down position.

To raise it, lift the seatback and push it back until it locks in the upright position.

Test to see that it is locked in place by pushing and pulling the seatback.

■ Safety Belts: They're For Everyone

This part of the manual tells you how to use safety belts properly. It also tells you some things you should not do with safety belts.



CAUTION:

Don't let anyone ride where they can't wear a safety belt properly. If you are in a crash and you're not wearing a safety belt, your injuries can be **much** worse. You can hit things inside the vehicle or be ejected from it. You can be seriously injured or killed. In the same crash, you might not be if you are buckled up. Always fasten your safety belt, and check that your passengers' belts are fastened properly too.



This figure lights up as a reminder to buckle up. (See *Safety Belt Reminder Light* in the *Index*.)

In many states and Canadian provinces, the law says to wear safety belts. Here's why: **They work.**



You never know if you'll be in a crash. If you do have a crash, you don't know if it will be a bad one.

A few crashes are mild, and some crashes can be so serious that even buckled up a person wouldn't survive. But most crashes are in between. In many of them, people who buckle up can survive and sometimes walk away. Without belts they could have been badly hurt or killed.

After more than 25 years of safety belts in vehicles, the facts are clear. In most crashes buckling up does matter... a lot!



Why Safety Belts Work

When you ride in or on anything, you go as fast as it goes.

1. For example, if the bike is going 10 mph (16 km/h), so is the child.

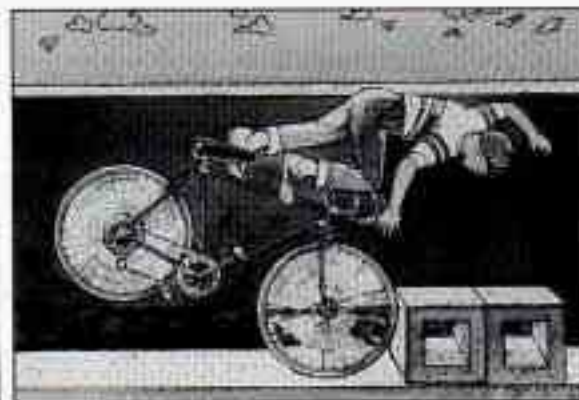

2. When the bike hits the block, it stops. But the child keeps going!

Seats & Restraint Systems

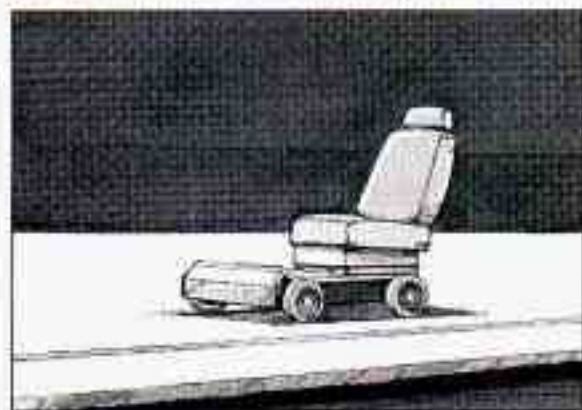

3. Take the simplest "vehicle." Suppose it's just a seat on wheels.



4. Put someone on it.

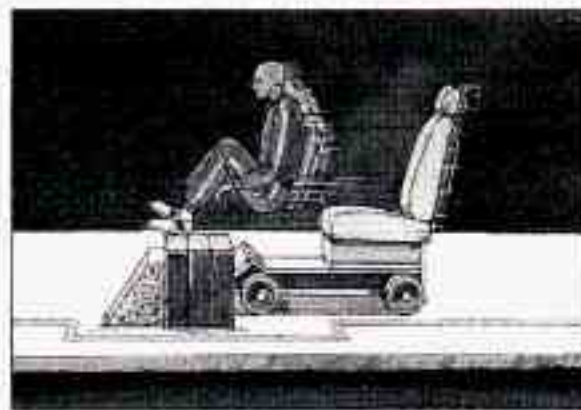

5. Get it up to speed. Then stop the "vehicle." The rider doesn't stop.



6. The person keeps going until stopped by something.

In a real vehicle, it could be the windshield...



7. or the instrument panel...



8. or the safety belts!

With safety belts, you slow down as the vehicle does. You get more time to stop. You stop over more distance, and your strongest bones take the forces. That's why safety belts make such good sense.

■ *Here Are Questions Many People Ask About Safety Belts — and the Answers*

Q: Won't I be trapped in the vehicle after an accident if I'm wearing a safety belt?

A: You **could** be — whether you're wearing a safety belt or not. But you can easily unbuckle a safety belt, even if you're upside down. And your chance of being conscious during and after an accident, so you **can** unbuckle and get out, is **much** greater if you are belted.

Q: Why don't they just put in air bags so people won't have to wear safety belts?

A: Air bags are in some vehicles today and will be in more of them in the future. But they are supplemental systems only — so they work **with** safety belts, not instead of them.

Every air bag system ever offered for sale has required the use of safety belts. Even if you're in a vehicle that has air bags, you still have to buckle up to get the most protection. That's true not only in frontal collisions, but especially in side and other collisions.

Q: If I'm a good driver, and I never drive far from home, why should I wear safety belts?

A: You may be an excellent driver, but if you're in an accident — even one that isn't your fault — you and your passengers can be hurt. Being a good driver doesn't protect you from things beyond your control, such as bad drivers. Most accidents occur within 25 miles (40 km) of home. And the greatest number of serious injuries and deaths occur at speeds of less than 40 mph (65 km/h). Safety belts are for everyone.



Safety Belt Reminder Light

When the key is turned to **Run** or **Start**, a light will come on for about eight seconds to remind people to fasten their safety belts. Unless the driver's safety belt is already buckled, a tone will also sound.

Seats & Restraint Systems

■ How To Wear Safety Belts Properly

Adults

This section is only for people of adult size.

Be aware that there are special things to know about safety belts and children. And there are different rules for smaller children and babies. If a child will be riding in your Oldsmobile, see the section after this one, called *Children*. Follow those rules for everyone's protection.

First, you'll want to know which restraint systems your vehicle has. We'll start with the driver position.

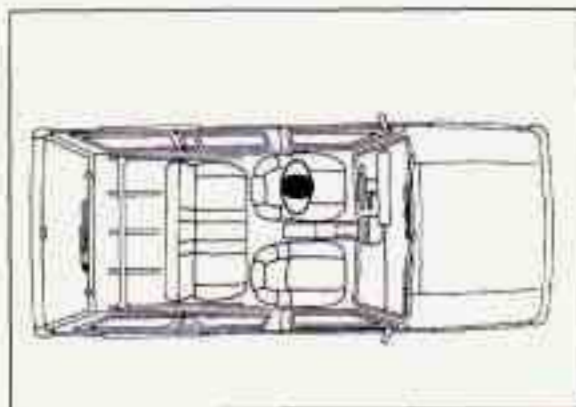

■ Driver Position

This section describes the driver's restraint system.



Lap-Shoulder Belt

The driver has a lap-shoulder belt. Here's how to wear it properly.

1. Close and lock the door.
2. Adjust the seat (to see how, see *Seats* in the *Index*) so you can sit up straight.



3. Pick up the latch plate and pull the belt across you. Don't let it get twisted.
4. Push the latch plate into the buckle until it clicks.

Pull up on the latch plate to make sure it is secure.

If the belt isn't long enough, see *Safety Belt Extender* at the end of this section.

Make sure the release button on the buckle is positioned so you would be able to unbuckle the safety belt quickly if you ever had to.

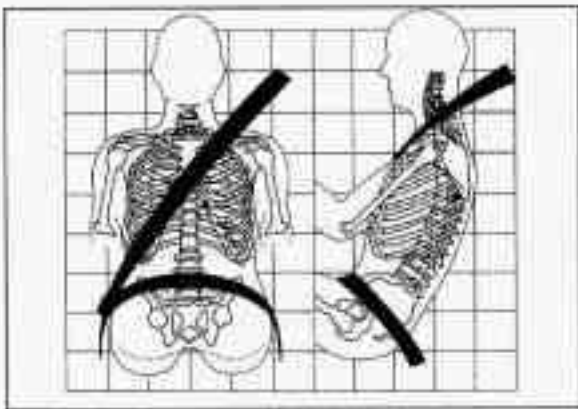

The lap part of the belt should be worn low and snug on the hips, just touching the thighs. In a crash, this applies force to the strong pelvic bones. And you'd be less likely to slide under the lap belt. If you slid under it, the belt would apply force at your abdomen. This could cause serious or even fatal injuries. The shoulder belt should go over the shoulder and across the chest. These parts of the body are best able to take belt restraining forces.

The safety belt locks if there's a sudden stop or a crash.

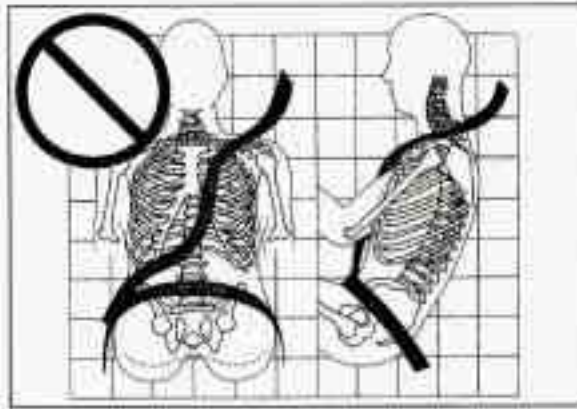

Q: What's wrong with this?

A: The shoulder belt is too loose. It won't give nearly as much protection this way.



CAUTION:

You can be seriously hurt if your shoulder belt is too loose. In a crash you would move forward too much, which could increase injury. The shoulder belt should fit against your body.

Seats & Restraint Systems

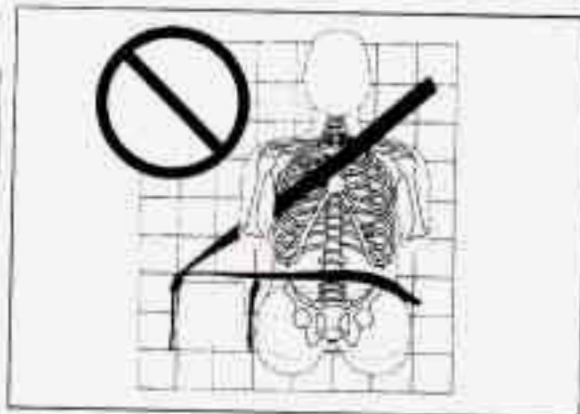

Q: What's wrong with this?

A: The belt is buckled in the wrong place.

CAUTION:

You can be seriously injured if your belt is buckled in the wrong place like this. In a crash, the belt would go up over your abdomen. The belt forces would be there, not at the pelvic bones. This could cause serious internal injuries. Always buckle your belt into the buckle nearest you.

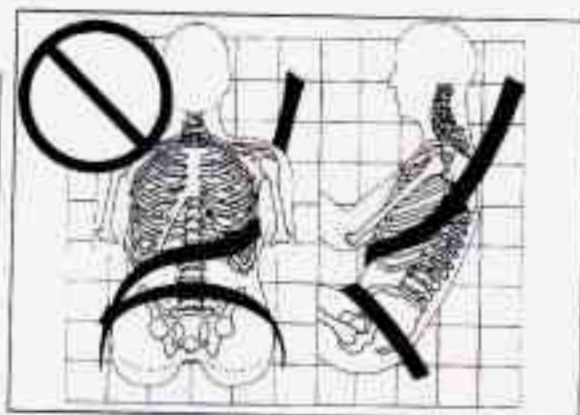

Q: What's wrong with this?

A: The shoulder belt is worn under the arm. It should be worn over the shoulder at all times.

CAUTION:

You can be seriously injured if you wear the shoulder belt under your arm. In a crash, your body would move too far forward, which would increase the chance of head and neck injury. Also, the belt would apply too much force to the ribs, which aren't as strong as shoulder bones. You could also severely injure internal organs like your liver or spleen.

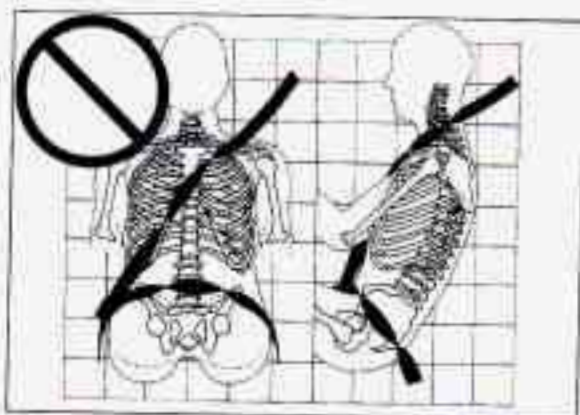

Q: What's wrong with this?

A: The belt is twisted across the body.

CAUTION:

You can be seriously injured by a twisted belt. In a crash, you wouldn't have the full width of the belt to spread impact forces. If a belt is twisted, make it straight so it can work properly, or ask your dealer to fix it.



To unfasten the belt, just push the button on the buckle. The belt should go back out of the way.

Before you close the door, be sure the belt is out of the way. If you slam the door on it, you can damage both the belt and your vehicle.



■ *Safety Belt Use During Pregnancy*

Safety belts work for everyone, including pregnant women. Like all occupants, they are more likely to be seriously injured if they don't wear safety belts.

A pregnant woman should wear a lap-shoulder belt, and the lap portion should be worn as low as possible throughout the pregnancy.

The best way to protect the fetus is to protect the mother. When a safety belt is worn properly, it's more likely that the fetus won't be hurt in a crash. For pregnant women, as for anyone, the key to making safety belts effective is wearing them properly.

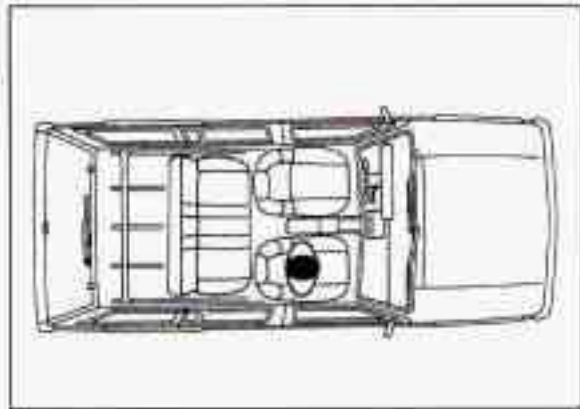

■ *Right Front Passenger Position*

The right front passenger's safety belt works the same way as the driver's safety belt. See *Driver Position*, earlier in this part.

When the lap portion of the belt is pulled out all the way, it will lock. If it does, let it go back all the way and start again.

Seats & Restraint Systems

■ *Rear Seat Passengers*

It's very important for rear seat passengers to buckle up! Accident statistics show that unbelted people in the rear seat are hurt more often in crashes than those who are wearing safety belts.

Rear passengers who aren't safety belted can be thrown out of the vehicle in a crash. And they can strike others in the vehicle who are wearing safety belts.

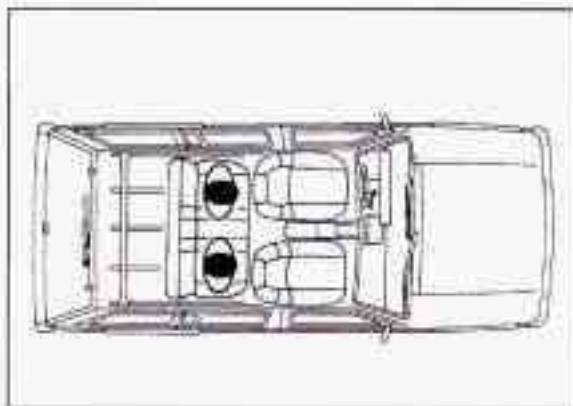

Rear Seat Outside Passenger Positions

Lap-Shoulder Belt

The positions next to the windows have lap-shoulder belts.



Here's how to wear one properly.

1. Pick up the latch plate and pull the belt across you. Don't let it get twisted.
2. Push the latch plate into the buckle until it clicks. Pull up on the latch plate to make sure it is secure.

When the shoulder belt is pulled out all the way, it will lock. If it does, let it go back all the way and start again.

If the belt is not long enough, see *Safety Belt Extender* at the end of this section.

Make sure the release button on the buckle is positioned so you would be able to unbuckle the safety belt quickly if you ever had to.



3. To make the lap part tight, pull down on the buckle end of the belt as you pull up on the shoulder part.

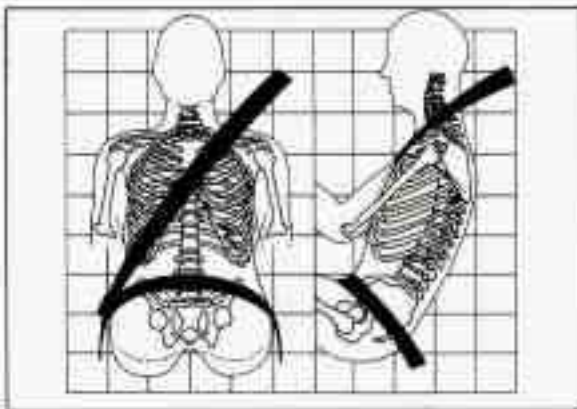

The lap part of the belt should be worn low and snug on the hips, just touching the thighs. In a crash, this applies force to the strong pelvic bones. And you'd be less likely to slide under the lap belt. If you slid under it, the belt would apply force at your abdomen. This could cause serious or even fatal injuries. The shoulder belt should go over the shoulder and across the chest. These parts of the body are best able to take belt restraining forces.

The safety belt locks if there's a sudden stop or a crash.



CAUTION:

You can be seriously hurt if your shoulder belt is too loose. In a crash you would move forward too much, which could increase injury. The shoulder belt should fit against your body.

Seats & Restraint Systems



To unlatch the belt, just push the button on the buckle.

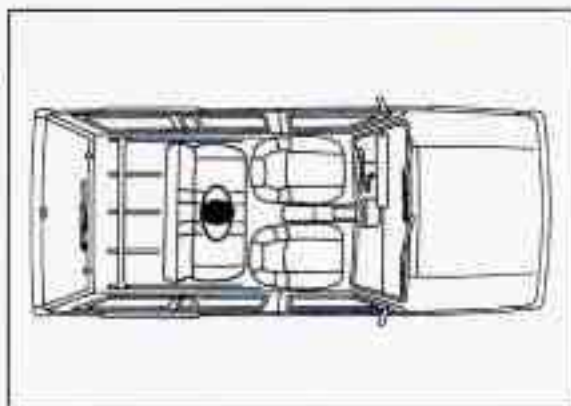

■ *Center Passenger Position Lap Belt*

If your vehicle has a rear bench seat, someone can sit in the center position.



When you sit in a center seating position, you have a lap safety belt, which has no retractor. To make the belt longer, tilt the latch plate and pull it along the belt.



To make the belt shorter, pull its free end as shown until the belt is snug.

Buckle, position and release it the same way as the lap part of a lap-shoulder belt. If the belt isn't long enough, see *Safety Belt Extender* at the end of this section.

Make sure the release button on the buckle is positioned so you would be able to unbuckle the safety belt quickly if you ever had to.



■ *Children*

Everyone in a vehicle needs protection! That includes infants and all children smaller than adult size. In fact, the law in every state in the United States and in every Canadian province says children up to some age must be restrained while in a vehicle.

Smaller Children and Babies



CAUTION:

Smaller children and babies should always be restrained in a child or infant restraint. The instructions for the restraint will say whether it is the right type and size for your child. A very young child's hip bones are so small that a regular belt might not stay low on the hips, as it should. Instead, the belt will likely be over the child's abdomen. In a crash the belt would apply force right on the child's abdomen, which could cause serious or fatal injuries. So, be sure that any child small enough for one is always properly restrained in a child or infant restraint.

Seats & Restraint Systems



CAUTION:

Never hold a baby in your arms while riding in a vehicle. A baby doesn't weigh much — until a crash. During a crash a baby will become so heavy you can't hold it. For example, in a crash at only 25 mph (40 km/h), a 12-pound (5.5 kg) baby will suddenly become a 240-pound (110 kg) force on your arms. The baby would be almost impossible to hold.

CAUTION (Continued)



CAUTION (Continued)

Secure the baby in an infant restraint.

■ *Child Restraints*

Be sure to follow the instructions for the restraint. You may find these instructions on the restraint itself or in a booklet, or both. These restraints use the belt system in your vehicle, but the child also has to be secured within the restraint to help reduce the chance of personal injury. The instructions that come with the infant or child restraint will show you how to do that.

Where to Put the Restraint

Accident statistics show that children are safer if they are restrained in the rear rather than the front seat. We at General Motors therefore recommend that you put your child restraint in the rear seat unless the child is an infant and you're the only adult in the vehicle. In that case, you might want to secure the restraint in the front seat where you can keep an eye on the baby.

Wherever you install it, be sure to secure the child restraint properly.

Keep in mind that an unsecured child restraint can move around in a collision or sudden stop and injure people in the vehicle. Be sure to properly secure any child restraint in your vehicle — even when no child is in it.



Top Strap

If your child restraint has a top strap, it should be anchored.

If you need to have an anchor installed, you can ask your Oldsmobile dealer to put it in for you. If you want to install an anchor yourself, your dealer can tell you how to do it.

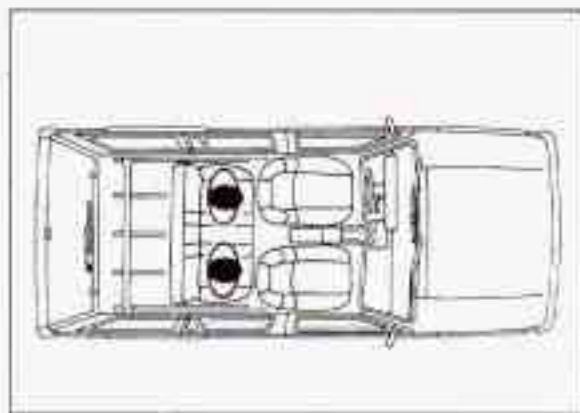

Securing a Child Restraint in a Rear Outside Position

You'll be using the lap-shoulder belt. See the earlier section about the top strap if the child restraint has one.

1. Put the restraint on the seat. Follow the instructions for the child restraint.
2. Secure the child in the child restraint as the instructions say.
3. Pick up the latch plate, and run the lap and shoulder portions of the vehicle's safety belt through or around the restraint. The child restraint instructions will show you how. If the shoulder belt goes in front of the child's face or neck, put it behind the child restraint.

Seats & Restraint Systems



4. Buckle the belt. Make sure the release button is positioned so you would be able to unbuckle the safety belt quickly if you ever had to.



5. Pull the rest of the shoulder belt all the way out of the retractor to set the lock.



6. To tighten the belt, feed the shoulder belt into the retractor while you push down on the child restraint.



7. Push and pull the child restraint in different directions to be sure it is secure.

To remove the child restraint, just unbuckle the vehicle's safety belt and let it go back all the way. The safety belt will move freely again and be ready to work for an adult or larger child passenger.

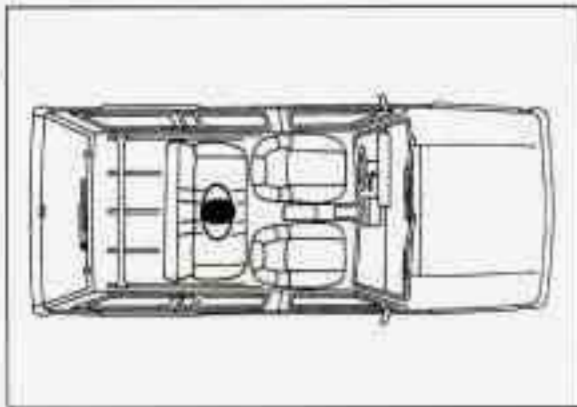

Securing a Child Restraint in a Center Seat Position

When you secure a child restraint in a center seating position, you'll be using the lap belt. But don't use the rear center seat, unless the base of the child restraint is small enough to let you reach the buckle and latch plate easily.

See the earlier section about the top strap if the child restraint has one.



1. Make the belt as long as possible by tilting the latch plate and pulling it along the belt.
2. Put the restraint on the seat. Follow the instructions for the child restraint.
3. Secure the child in the child restraint as the instructions say.

Seats & Restraint Systems



4. Run the vehicle's safety belt through or around the restraint. The child restraint instructions will show you how.
5. Buckle the belt. Make sure the release button is positioned so you would be able to unbuckle the safety belt quickly if you ever had to.
6. To tighten the belt, pull its free end while you push down on the child restraint.

7. Push and pull the child restraint in different directions to be sure it is secure. If the child restraint isn't secure, turn the latch plate over and buckle it again. Then see if it is secure. If it isn't, secure the restraint in a different place in the vehicle and contact the child restraint maker for their advice about how to attach the child restraint properly.

To remove the child restraint, just unbuckle the vehicle's safety belt. It will be ready to work for an adult or larger child passenger.

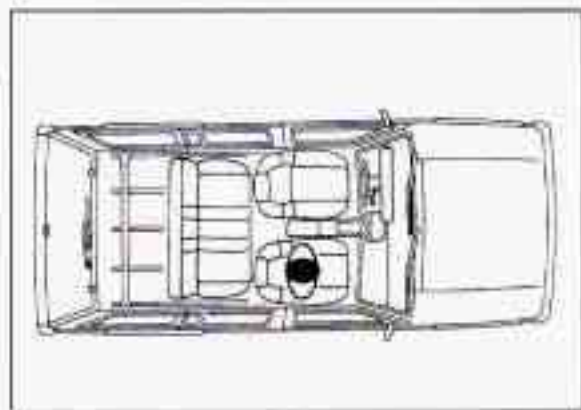

Securing a Child Restraint in the Right Front Seat

You'll be using the lap-shoulder belt. See the earlier section about the top strap if the child restraint has one.

1. Put the restraint on the seat. Follow the instructions for the child restraint.
2. Secure the child in the child restraint as the instructions say.



- 3.** Pick up the latch plate, and run the lap and shoulder portions of the vehicle's safety belt through or around the restraint. The child restraint instructions will show you how. If the shoulder belt goes in front of the child's face or neck, put it behind the child restraint.
- 4.** Buckle the belt. Make sure the release button is positioned so you would be able to unbuckle the safety belt quickly if you ever had to.



- 5.** Pull the rest of the lap belt all the way out of the retractor to set the lock.

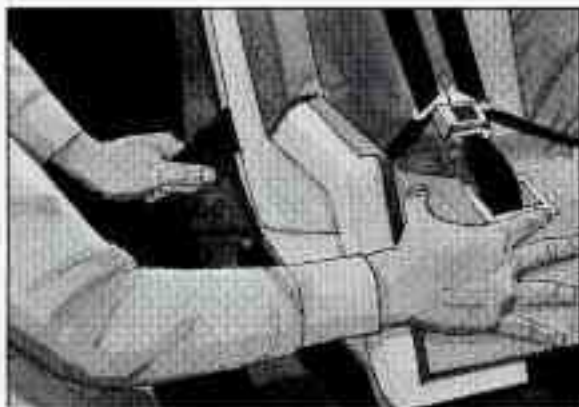

- 6.** To tighten the belt, feed the lap belt back into the retractor while you push down on the child restraint.

Seats & Restraint Systems



7. Push and pull the child restraint in different directions to be sure it is secure. Adjust the bucket seat forward until the lap portion of the safety belt holds the restraint firmly. But don't move it any more than needed to tighten the lap belt.

To remove the child restraint, just unbuckle the vehicle's safety belt and let it go back all the way.

The safety belt will move freely again and be ready to work for an adult or larger child passenger.



Larger Children

Children who have outgrown child restraints should wear the vehicle's safety belts.

If you have the choice, a child should sit next to a window so the child can wear a lap-shoulder belt and get the additional restraint a shoulder belt can provide.

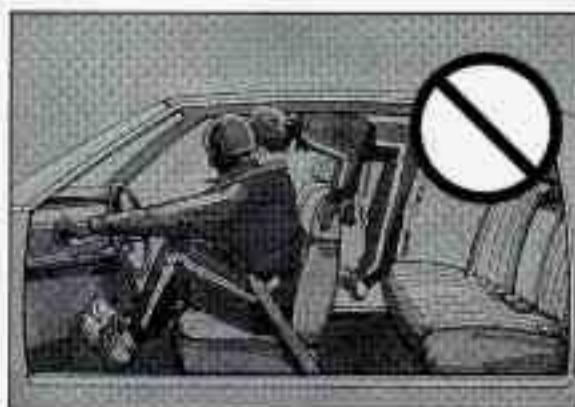

- Children who aren't buckled up can be thrown out in a crash.
- Children who aren't buckled up can strike other people who are.



CAUTION:

Never do this. Here two children are wearing the same belt. The belt can't properly spread the impact forces. In a crash, the two children can be crushed together and seriously injured. A belt must be used by only one person at a time.

Q: What if a child is wearing a lap-shoulder belt, but the child is so small that the shoulder belt is very close to the child's face or neck?

A: Move the child toward the center of the vehicle, but be sure that the shoulder belt still is on the child's shoulder, so that in a crash the child's upper body would have the restraint that belts provide. If the child is so small that the shoulder belt is still very close to the child's face or neck, you might want to place the child in a seat that has a lap belt, if your vehicle has one.



CAUTION:

Never do this. Here a child is sitting in a seat that has a lap-shoulder belt, but the shoulder part is behind the child. If the child wears the belt in this way, in a crash the child might slide under the belt. The belt's force would then be applied right on the child's abdomen. That could cause serious or fatal injuries.

Wherever the child sits, the lap portion of the belt should be worn low and snug on the hips, just touching the child's thighs. This applies belt force to the child's pelvic bones in a crash.

Seats & Restraint Systems

■ *Safety Belt Extender*

If the vehicle's safety belt will fasten around you, you should use it.

But if a safety belt isn't long enough to fasten, your dealer will order you an extender. It's free. When you go in to order it, take the heaviest coat you will wear, so the extender will be long enough for you. The extender will be just for you, and just for the seat in your vehicle that you choose. Don't let someone else use it, and use it only for the seat it is made to fit. To wear it, just attach it to the regular safety belt.

■ *Checking Your Restraint Systems*

Now and then, make sure all your belts, buckles, latch plates, retractors, anchorages and reminder systems are working properly. Look for any loose parts or damage. If you see anything that might keep a restraint system from doing its job, have it repaired.



■ *Replacing Safety Belts After a Crash*

If you've had a crash, do you need new belts?

After a very minor collision, nothing may be necessary. But if the belts were stretched, as they would be if worn during a more severe crash, then you need new belts.

If you ever see a label on a right front safety belt that says to replace the belt, be sure to do so. Then the new belt will be there to help protect you in an accident. You would see this label on the belt near the door opening.

If belts are cut or damaged, replace them. Collision damage also may mean you will need to have safety belt or seat parts repaired or replaced. New parts and repairs may be necessary even if the belt wasn't being used at the time of the collision.



Q: What's wrong with this?

A: The belt is torn.

Torn or frayed belts may not protect you in a crash. They can rip apart under impact forces. If a belt is torn or frayed, get a new one right away.

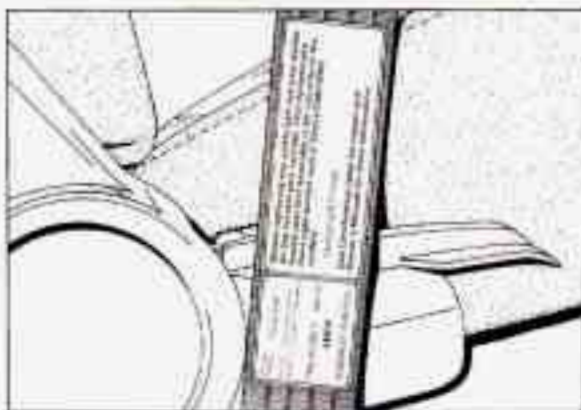

Before replacing any safety belt, see your dealer for the correct part number. You'll need the model year and model number for your vehicle. The model year is on your title and registration. And you can find the model number on the Certification/Tire label of your vehicle. See *Certification/Tire Label* in the *Index*.

The model number on the replacement belt must be listed on the safety belt you want to replace. Pull the shoulder belt all the way out to see this label.

Notes

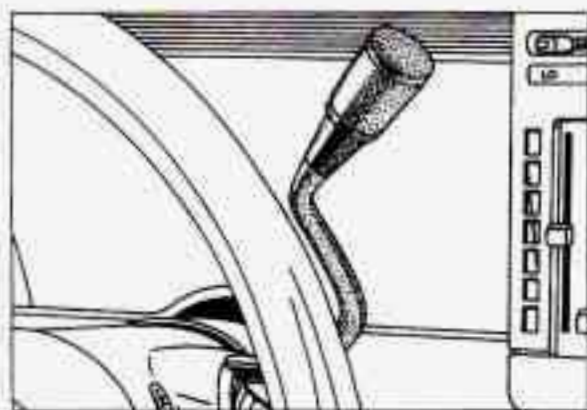

Here you can learn about the many standard and optional features on your Oldsmobile, and information on starting, shifting and braking. Also explained are the instrument panel and the warning systems that tell you if everything is working properly — and what to do if you have a problem.

Part 2

Features & Controls

Keys	38
Locks	39
Remote Lock Control	40
Tailgate	42
Ignition	45
Starting Your Engine	45
Shifting the Transmission	48
Parking Brake	51
Shifting into Park	51
Horn	54
Tilt Steering Wheel	55
Windows	55
Turn Signal/Multifunction Lever	55
Windshield Wipers and Washer	57
Cruise Control	59
Headlights	62
Fog Lights	63
Overhead Console	64
Sun Visors	69
Mirrors	69
Storage Compartments	71
Ashtrays and Lighter	73
Luggage Carrier	74
Instrument Panel	76
Warning Lights, Gages and Indicators	80

Features & Controls

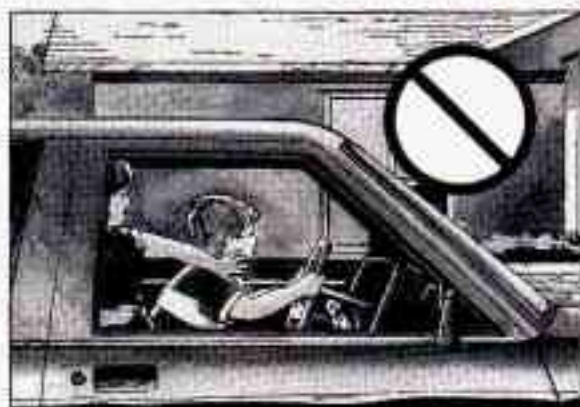

■ Keys



CAUTION:

Leaving young children in a vehicle with the ignition key is dangerous for many reasons. A child or others could be badly injured or even killed. They could operate power windows or other controls or even make the vehicle move. Don't leave the keys in a vehicle with young children.



The square-shaped keys are for the ignition only.



The oval-shaped keys are for the doors and all other locks.

When a new Oldsmobile is delivered, the dealer removes the plugs from the keys and gives them to the first owner. Each plug has a code on it that tells your dealer or a qualified locksmith how to make extra keys. Keep the plugs in a safe place. If you lose your keys, you'll be able to have new ones made easily using these plugs.

NOTICE:

Your Oldsmobile has a number of new features that can help prevent theft. But you can have a lot of trouble getting into your vehicle if you ever lock your keys inside. You may even have to damage your vehicle to get in. So be sure you have extra keys.

■ *Door Locks*



CAUTION:

Unlocked doors can be dangerous.

Passengers — especially children — can easily open the doors and fall out. When a door is locked, the inside handle won't open it.

Outsiders can easily enter through an unlocked door when you slow down or stop your vehicle.

This may not be so obvious: You increase the chance of being thrown out of the vehicle in a crash if the doors aren't locked. Wear safety belts properly, lock your doors, and you will be far better off whenever you drive your vehicle.

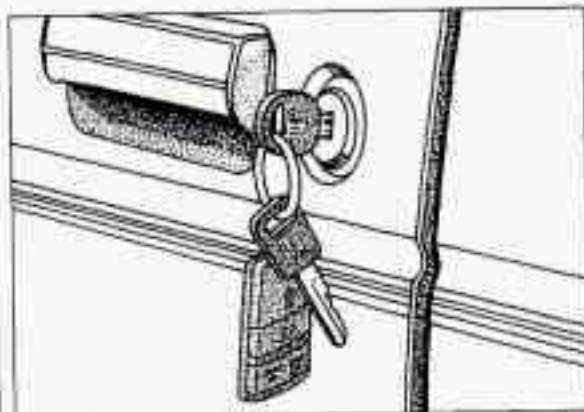

There are several ways to lock and unlock your vehicle.

From the Outside:

Use your door key or Remote Lock Control.

Features & Controls

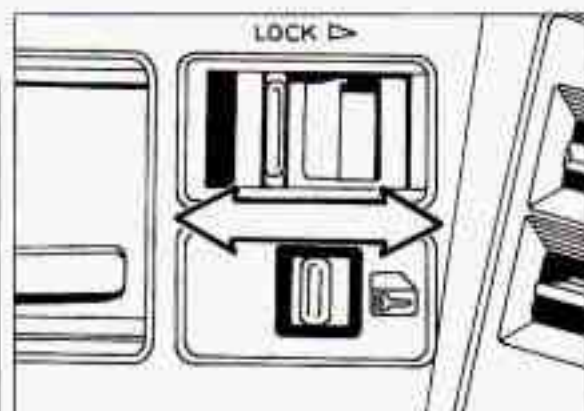

From the Inside:

To lock the door, push the manual locking lever forward. To unlock the door, push the lever back.

The rear doors have only a manual door lock lever.

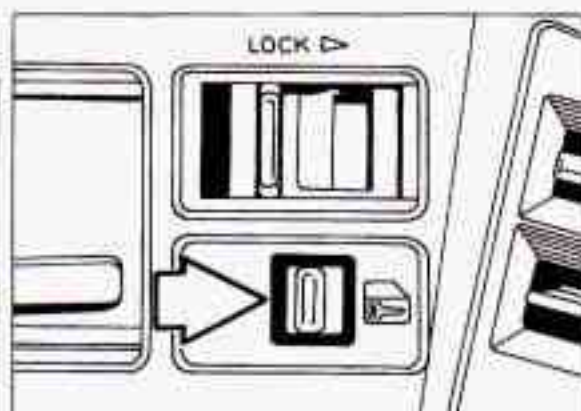

Power Door Locks

You can lock or unlock all doors at the same time from either front door. Push the switch forward to lock the doors.

Push it rearward to unlock them. This switch does not keep you from locking or unlocking a door with the key.

The switch on each rear door works only that door's lock. It won't lock (or unlock) all of the doors—that's a safety feature.

Leaving Your Vehicle

If you are leaving the vehicle, open your door and set the locks from the inside. Then get out and close the door.

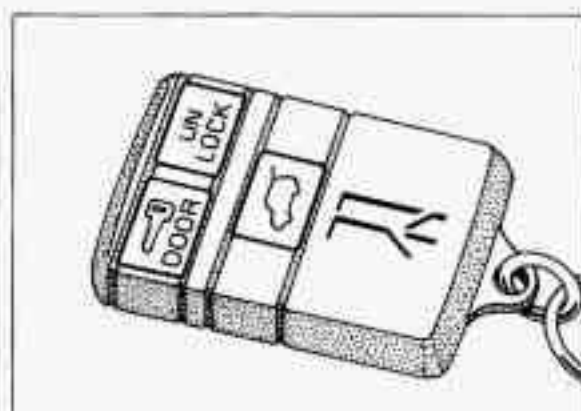

Remote Lock Control

You can lock and unlock your doors, or unlock your tailgate glass, from about 30 feet (9 m) away using the key chain transmitter supplied with your vehicle.

Your remote lock control operates on a radio frequency subject to Federal Communications Commission (FCC) Rules.

This device complies with Part 15 of the FCC Rules. Operation is subject to the following two conditions: (1) This device may not cause harmful interference, and (2) This device must accept any interference received, including interference that may cause undesired operation.

Should interference to this system occur, try this:

- Check to determine if battery replacement is necessary. See the instructions on battery replacement.
- Check the distance. You may be too far from your vehicle. This product has a maximum range.
- Check the location. Other vehicles or objects may be blocking the signal.
- See your Oldsmobile dealer or a qualified technician for service.

Changes or modifications to this system by other than an authorized service facility could void authorization to use this equipment.

Operation

When you press **UNLOCK**, the driver's door will unlock automatically. If you press **UNLOCK** again within five seconds, all doors will unlock. All doors will lock when **DOOR** is pressed.

The tailgate glass will unlock when  is pressed, but only when the transmission is in **P** (Park).

Matching Transmitter(s) To Your Vehicle

Each key chain transmitter is coded to prevent another transmitter from unlocking your vehicle. If a transmitter is lost or stolen, a replacement can be purchased through your dealer. Remember to bring the remaining transmitters with you when you go to your dealer. When the dealer matches the replacement transmitter to your vehicle, the remaining transmitters must also be matched. Once the new transmitter is coded, the lost transmitter will not unlock your vehicle.

You can match a transmitter to as many different vehicles as you own, provided they are equipped with **exactly the same model system**. (General Motors offers several different models of these systems on their vehicles.) Each vehicle can have only two transmitters matched to it.

See your dealer to match transmitters to another vehicle.

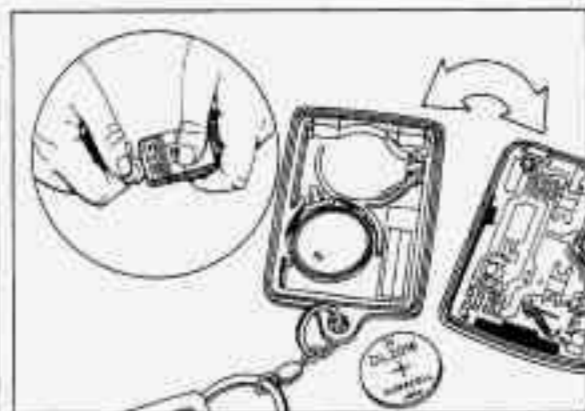

Battery Replacement

Under normal use, the batteries in your key chain transmitter should last about two years.

You can tell the batteries are weak if the transmitter won't work at the normal range in any location. If you have to get close to your vehicle before the transmitter works, it's probably time to change the batteries.

To Replace Batteries in the Remote Lock Control:

1. Pop the cover off by inserting a dime (or something similar) in the groove between the covers and twisting.

Features & Controls

2. Lift the front cover off, bottom half first.
3. Remove and replace the batteries (2016).
4. Reassemble the transmitter.
5. Check the transmitter operation.

■ Theft

Vehicle theft is big business, especially in some cities. Although your Oldsmobile has a number of theft deterrent features, we know that nothing we put on it can make it impossible to steal. However, there are ways you can help.

Key in the Ignition

If you walk away from your vehicle with the keys inside, it's an easy target for joy riders or professional thieves — so don't do it.

When you park your Oldsmobile and open the driver's door, you'll hear a tone reminding you to remove your key from the ignition and take it with you. Always do this. Your steering wheel will be locked, and so will your ignition and transmission. And remember to lock the doors.

Parking at Night

Park in a lighted spot, close all windows and lock your vehicle. Remember to keep your valuables out of sight. Put them in a storage area, or take them with you.

Parking Lots

If you park in a lot where someone will be watching your vehicle, it's best to lock it up and take your keys. But what if you have to leave your ignition key? What if you have to leave something valuable in your vehicle?

- Put your valuables in a storage area, like your glove box.
- Lock the glove box.
- Lock all the doors except the driver's.
- Then take the door key with you.



Tailgate Lock

From the outside, use the round key to open the tailgate. With the key in the lock, turn the lock handle to the left to unlock the window.

Raise the window, then turn the lock handle to the right to unlock the tailgate.

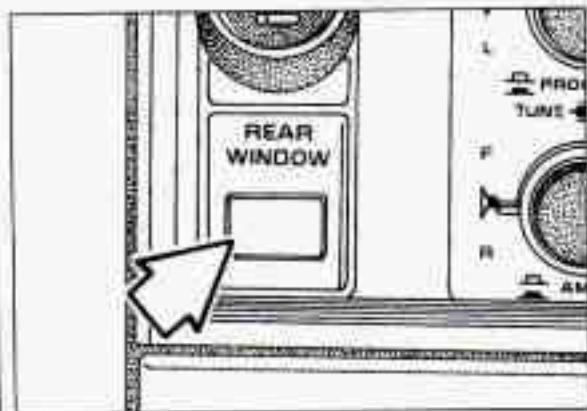

■ *Power Tailgate Window Release*

From inside the vehicle, press the **REAR WINDOW** button, located to the left of the radio, to unlock the tailgate window. Your shift lever must be in **P** (Park) or **N** (Neutral).

CAUTION:

It can be dangerous to drive with the tailgate window open because carbon monoxide (CO) gas can come into your vehicle. You can't see or smell CO. It can cause unconsciousness and even death. If you must drive with the tailgate window open or if electrical wiring or other cable connections must pass through the seal between the body and the tailgate window:

- Make sure all windows are shut.
- Turn the fan on your heating or cooling system to its highest speed with the setting on **VENT** or **BI-LEV A/C**. That will force outside air into your vehicle. See *Comfort Controls* in the *Index*.
- If you have air vents on or under the instrument panel, open them all the way.

See *Engine Exhaust* in the *Index*.



Tailgate-Mounted Spare Tire Carrier (OPTION)

You must move the carrier arm out of the way to open the tailgate window.

Features & Controls

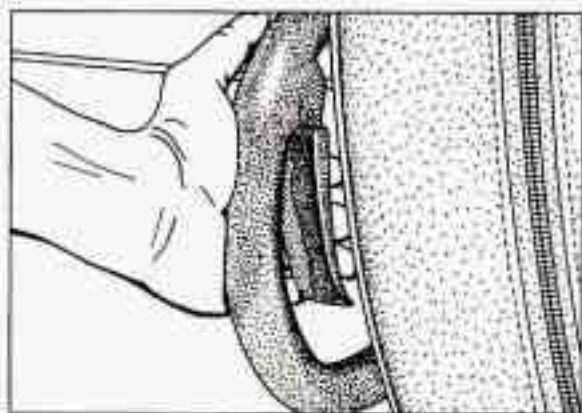

Here's How to Move the Arm:

1. Squeeze the release handle to free the carrier arm.
2. Swing the carrier arm away from the tailgate. You may need to give it a slight tug.

To latch the carrier arm, swing it hard toward the tailgate. The latch has one catch, so push hard on the carrier arm to make sure it has locked in place. If it is not securely latched, the carrier will swing freely.

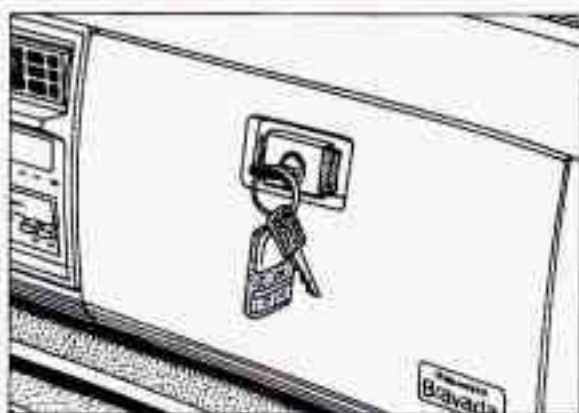

Glove Box

Use the door key to lock and unlock the glove box. To open, pinch the latch release.

■ New Vehicle "Break-In"

NOTICE:

Your modern Oldsmobile doesn't need an elaborate "break-in." But it will perform better in the long run if you follow these guidelines:

- Keep your speed at 55 mph (88 km/h) or less for the first 500 miles (804 km).
- Don't drive at any one speed — fast or slow — for the first 500 miles (804 km). Don't make full-throttle starts.
- Avoid making hard stops for the first 200 miles (322 km) or so. During this time your new brake linings aren't yet broken in. Hard stops with new linings can mean premature wear and earlier replacement. Follow this "breaking-in" guideline every time you get new brake linings.

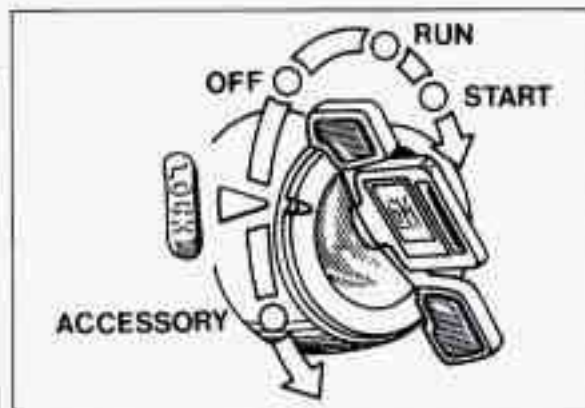

■ Ignition Switch

With the ignition key in the ignition switch, you can turn the switch to five positions:

Accessory: An “on” position in which you can operate your electrical power accessories. Press in the ignition switch as you turn the top of it toward you.

Lock: The only position in which you can remove the key. This locks your steering wheel, ignition and transmission.

Off: Unlocks the steering wheel, ignition, and transmission, but does not send electrical power to any accessories. Use this position if your vehicle must be pushed or towed, but never try to push-start your vehicle. A warning chime will sound if you open the driver’s door when the ignition is off and the key is in the ignition.

Run: An “on” position to which the switch returns after you start your engine and release the switch. The switch stays in the **Run** position when the engine is running. But even when the engine is not running, you can use **Run** to operate your electrical power accessories, and to display some instrument panel warning lights.

Start: Starts the engine. When the engine starts, release the key. The ignition switch will return to **Run** for normal driving.

Note that even if the engine is not running, the positions **Accessory** and **Run** are “on” positions that allow you to operate your electrical accessories, such as the radio.

NOTICE:

If your key seems stuck in **Lock** and you can’t turn it, be sure it is all the way in. If it is, then turn the steering wheel left and right while you turn the key hard. But turn the key only with your hand. Using a tool to force it could break the key or the ignition switch. If none of this works, then your vehicle needs service.

■ Starting Your Engine

Move your shift lever to **P** (Park) or **N** (Neutral). Your engine won’t start in any other position — that’s a safety feature. To restart when you’re already moving, use **N** (Neutral) only.

NOTICE:

Don’t try to shift to **P** (Park) if your Oldsmobile is moving. If you do, you could damage the transmission. Shift to **P** (Park) only when your vehicle is stopped.

Features & Controls

1. Without pushing the accelerator pedal, turn your ignition key to **Start**. When the engine starts, let go of the key. The idle speed will go down as your engine gets warm.

NOTICE:

Holding your key in **Start** for longer than 15 seconds at a time will cause your battery to be drained much sooner. And the excessive heat can damage your starter motor.

2. If it doesn't start right away, hold your key in **Start**. If it doesn't start in three seconds, push the accelerator pedal about one-quarter of the way down for 12 more seconds, or until it starts.
3. If your engine still won't start (or starts but then stops), it could be flooded with too much gasoline. Try this: Wait 15 seconds to let the starter motor cool down. Then push your accelerator pedal all the way to the floor. Hold it there. Then, hold the key in **Start** for no more than ten seconds. This clears the extra gasoline from the engine.

If the engine still doesn't start, wait another 15 seconds and do it all again. When the engine starts, let go of the key and the accelerator pedal.

NOTICE:

Your engine is designed to work with the electronics in your vehicle. If you add electrical parts or accessories, you could change the way the fuel injection system operates. Before adding electrical equipment, check with your dealer. If you don't, your engine might not perform properly. If you ever have to have your vehicle towed, see the part of this manual that tells how to do it without damaging your vehicle. See *Towing Your Truck* in the *Index*.

■ Driving Through Deep Standing Water

NOTICE:

If you drive too quickly through deep puddles or standing water, water can come in through your engine's air intake and badly damage your engine. If you can't avoid deep puddles or standing water, drive through them very slowly.

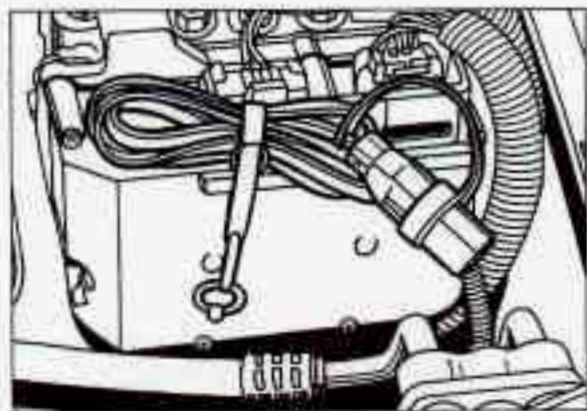

■ *Engine Coolant Heater* *(Engine Block Heater)* *(OPTION)*

In very cold weather, 0°F (-18°C) or colder, the engine coolant heater can help. You'll get easier starting and better fuel economy during engine warm-up. Usually, the coolant heater should be plugged in a minimum of four hours prior to starting your vehicle.

To use the coolant heater:

1. Turn off the engine.
2. Open the hood and unwrap the electrical cord.
3. Plug it into a normal, grounded 110-volt outlet.



CAUTION:

Plugging the cord into an ungrounded outlet could cause an electrical shock. Also, the wrong kind of extension cord could overheat and cause a fire. You could be seriously injured. Plug the cord into a properly grounded three-prong 110-volt outlet. If the cord won't reach, use a heavy-duty three-prong extension cord rated for at least 15 amps.

NOTICE:

After you've used the coolant heater, be sure to store the cord as it was before to keep it away from moving engine parts. If you don't, it could be damaged.

How long should you keep the coolant warmer plugged in? The answer depends on the weather, the kind of oil you have, and some other things. Instead of trying to list everything here, we ask that you contact an Oldsmobile dealer in the area where you'll be parking your vehicle. The dealer can give you the best advice for that particular area.

Features & Controls

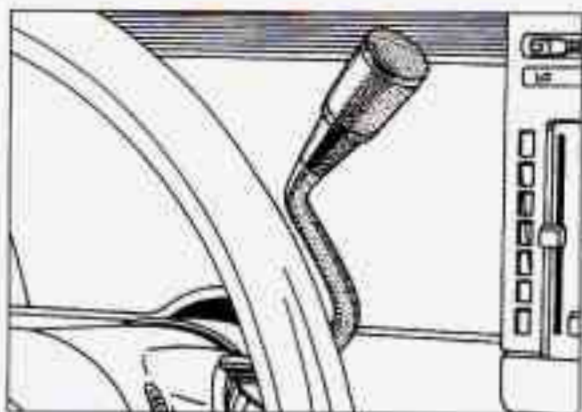

■ Automatic Transmission

There are several different positions for your shift lever.

Park	P
Reverse	R
Neutral	N
Overdrive	D
Drive	D
Second	2
First	1

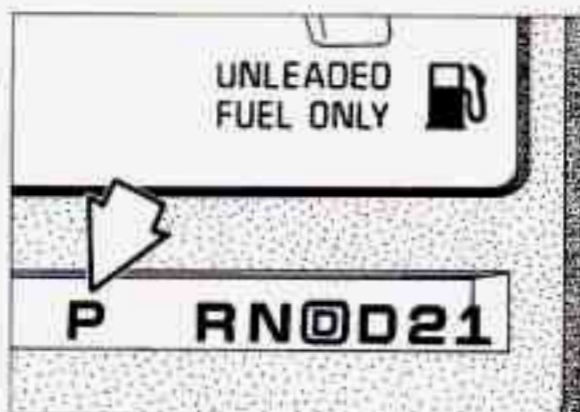

Park

P (Park): This locks your rear wheels. It's the best position to use when you start your engine because your vehicle can't move easily.

CAUTION:

It is dangerous to get out of your vehicle if the shift lever is not fully in **P** (Park) with the parking brake firmly set. Your vehicle can roll. Don't leave your vehicle when the engine is running unless you have to. If you have left the engine running, the vehicle can move suddenly. You or others could be injured. To be sure your vehicle won't move, even when you're on fairly level ground, always set your parking brake and move the shift lever to **P** (Park).

See *Shifting Into P (Park)* in the *Index*. If you're pulling a trailer, see *Towing a Trailer* in the *Index*.

UNLEADED
FUEL ONLY



P R N @ D 2 1

Reverse

R (Reverse): Use this gear to back up.

NOTICE:

Shifting to **R (Reverse)** while your vehicle is moving forward could damage your transmission. Shift to **R (Reverse)** only after your vehicle is stopped.

To rock your vehicle back and forth to get out of snow, ice or sand without damaging your transmission, see the *Index* under *If You're Stuck: In Sand, Mud, Ice or Snow*.

UNLEADED
FUEL ONLY



P R N @ D 2 1

Neutral

N (Neutral): In this position, your engine doesn't connect with the wheels. To restart when you're already moving, use **N (Neutral)** only.



CAUTION:

Shifting out of **P (Park)** or **N (Neutral)** while your engine is "racing" (running at high speed) is dangerous. Unless your foot is firmly on the brake pedal, your vehicle could move very rapidly. You could lose control and hit people or objects. Don't shift out of **P (Park)** or **N (Neutral)** while your engine is racing.

NOTICE:

Damage to your transmission caused by shifting out of **P (Park)** or **N (Neutral)** with the engine racing isn't covered by your warranty.

Features & Controls

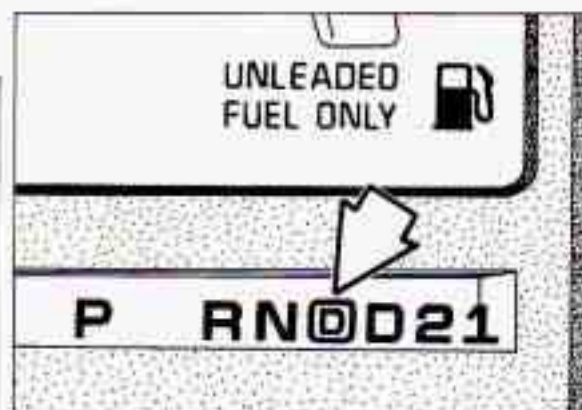

Forward Gears

D (Automatic Overdrive): This position is for normal driving. If you need more power for passing, and you're:

- Going less than 35 mph (56 km/h), push your accelerator pedal about halfway down.
- Going about 35 mph (56 km/h) or more, push the accelerator pedal all the way down.

You'll shift down to the next gear and have more power.

D (Third Gear): This position is like **D**, but you never go into Overdrive. Here are some times you might choose **D** instead of **D**:

- When driving on hilly, winding roads.
- When towing a trailer, so there is less shifting between gears.
- When going down a steep hill.

2 (Second Gear): This position gives you more power but lower fuel economy. You can use **2** on hills. It can help control your speed as you go down steep mountain roads, but then you would also want to use your brakes off and on.

1 (First Gear): This position gives you even more power (but lower fuel economy) than **2**. You can use it on very steep hills, or in deep snow or mud. If the shift lever is put in **1**, the transmission won't shift into first gear until the vehicle is going slowly enough.

NOTICE:

If your rear wheels can't rotate, don't try to drive. This might happen if you were stuck in very deep sand or mud or were up against a solid object. You could damage your transmission or transfer case or both. Also, if you stop when going uphill, don't hold your vehicle there with only the accelerator pedal. This could overheat and damage the transmission. Use your brakes or shift into **P** (Park) to hold your vehicle in position on a hill.

■ Locking Rear Axle

Your rear axle can give you additional traction on snow, mud, ice, sand or gravel. It works like a standard axle most of the time, but when one of the rear wheels has no traction and the other does, the locking feature will allow the wheel with traction to move the vehicle.

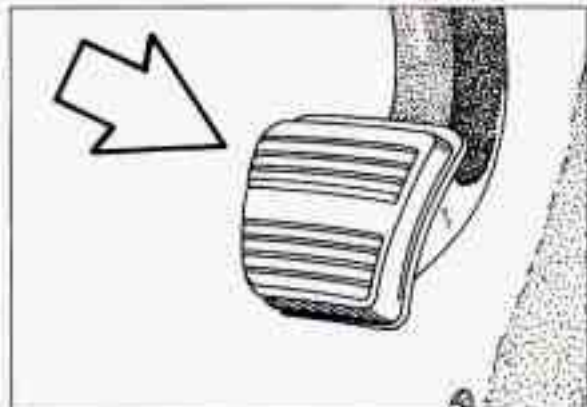

Parking Brake

To Set the Parking Brake:

Hold the regular brake pedal down with your right foot. Push down the parking brake pedal with your left foot. If the ignition is on, the brake system warning light will come on.

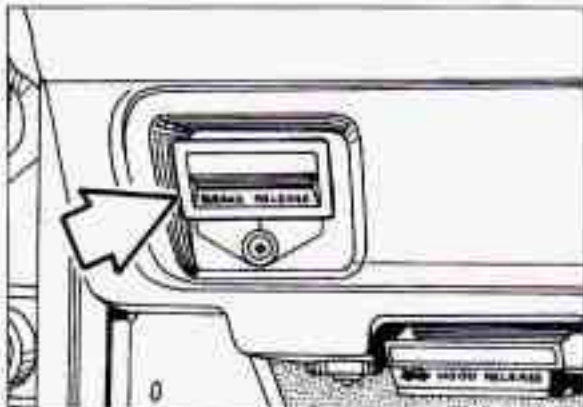

To Release the Parking Brake:

Hold the regular brake pedal down. Pull the **BRAKE RELEASE** lever.

NOTICE:

Driving with the parking brake on can cause your rear brakes to overheat. You may have to replace them, and you could also damage other parts of your vehicle.

If You Are Towing a Trailer and Are Parking on a Hill:

See the *Index* under *Towing a Trailer*. That section shows what to do first to keep the trailer from moving.

■ **Shifting Into P (Park)**



CAUTION:

It can be dangerous to get out of your vehicle if the shift lever is not fully in **P (Park)** with the parking brake firmly set. Your vehicle can roll. If you have left the engine running, the vehicle can move suddenly. You or others could be injured. To be sure your vehicle won't move, even when you're on fairly level ground, use the steps that follow. If you're pulling a trailer, see *Towing a Trailer* in the *Index*.

1. Hold the brake pedal down with your right foot and set the parking brake.

Features & Controls

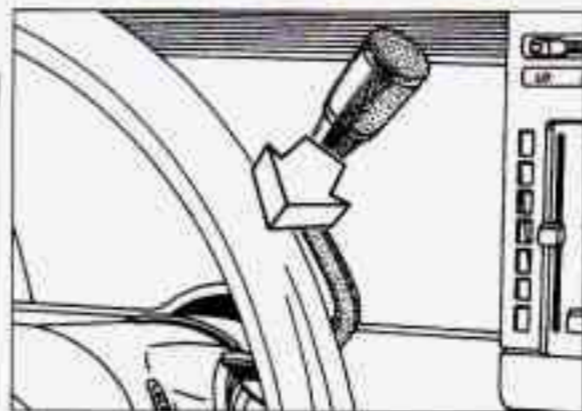

2. Move the shift lever into the **P** (Park) position like this:

- Pull the lever toward you.

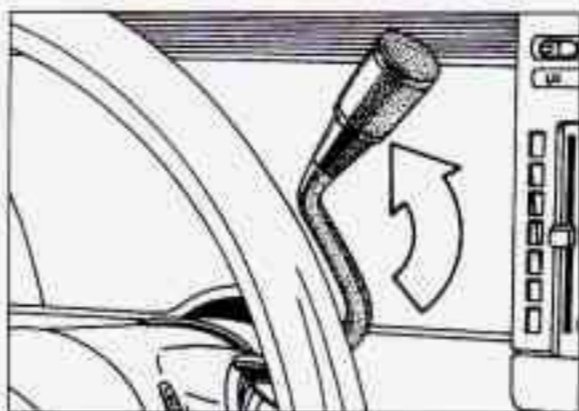

- Move the lever up as far as it will go.
3. Move the ignition key to **Lock**.
4. Remove the key and take it with you. If you can walk away from your vehicle with the ignition key in your hand, your vehicle is in **P** (Park).

Leaving Your Vehicle With the Engine Running



CAUTION:

It can be dangerous to leave your vehicle with the engine running. Your vehicle could move suddenly if the shift lever is not fully in **P** (Park) with the parking brake firmly set. And, if you leave the vehicle with the engine running, it could overheat and even catch fire. You or others could be injured. Don't leave your vehicle with the engine running unless you have to.

If you have to leave your vehicle with the engine running, be sure your vehicle is in **P** (Park) and your parking brake is firmly set before you leave it. After you've moved the shift lever into the **P** (Park) position, hold the regular brake pedal down. Then, see if you can move the shift lever away from **P** (Park) without first pulling it toward you.

If you can, it means that the shift lever wasn't fully locked into **P** (Park).

Torque Lock

If you are parking on a hill and you don't shift your transmission into **P** (Park) properly, the weight of the vehicle may put too much force on the parking pawl in the transmission. You may find it difficult to pull the shift lever out of **P** (Park). This is called "torque lock." To prevent torque lock, set the parking brake and then shift into **P** (Park) properly before you leave the driver's seat. To find out how, see *Shifting Into P (Park)* in the *Index*.

When you are ready to drive, move the shift lever out of **P** (Park) **BEFORE** you release the parking brake.

If "torque lock" does occur, you may need to have another vehicle push yours a little uphill to take some of the pressure from the transmission, so you can pull the shift lever out of **P** (Park).



■ Parking Over Things That Burn

CAUTION:

Things that can burn could touch hot exhaust parts under your vehicle and ignite. Don't park over papers, leaves, dry grass or other things that can burn.

■ Engine Exhaust

CAUTION:

Engine exhaust can kill. It contains the gas carbon monoxide (CO), which you can't see or smell. It can cause unconsciousness and death. You might have exhaust coming in if:

- Your exhaust system sounds strange or different.
- Your vehicle gets rusty underneath.
- Your vehicle was damaged in a collision.
- Your vehicle was damaged when driving over high points on the road or over road debris.
- Repairs weren't done correctly.
- Your vehicle or exhaust system had been modified improperly.

If you **ever** suspect exhaust is coming into your vehicle:

- Drive it only with all the windows down to blow out any CO; and
- Have your vehicle fixed **immediately**.

Features & Controls

■ *Running Your Engine While You're Parked*

It's better not to park with the engine running. But if you ever have to, here are some things to know.

CAUTION:

Idling the engine with the air system control off could allow dangerous exhaust into your vehicle (see the earlier *Caution* under *Engine Exhaust*). Also, idling in a closed-in place can let deadly carbon monoxide (CO) into your vehicle even if the fan switch is at the highest setting. One place this can happen is a garage. Exhaust — with CO — can come in easily. NEVER park in a garage with the engine running.

Another closed-in place can be a blizzard. (See *Blizzard* in the *Index*.)

CAUTION:

It can be dangerous to get out of your vehicle if the shift lever is not fully in **P** (Park) with the parking brake firmly set. Your vehicle can roll. Don't leave your vehicle when the engine is running unless you have to. If you've left the engine running, the vehicle can move suddenly. You or others could be injured. To be sure your vehicle won't move, even when you're on fairly level ground, always set your parking brake and move the shift lever to **P** (Park).

Follow the proper steps to be sure your vehicle won't move. See *Shifting Into P (Park)* in the *Index*.

If you are parking on a hill and pulling a trailer, also see *Towing a Trailer* in the *Index*.

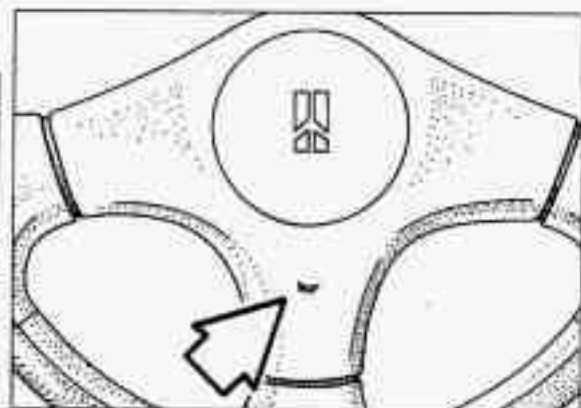

Horn

You can sound the horn by pressing the horn symbol on your steering wheel.

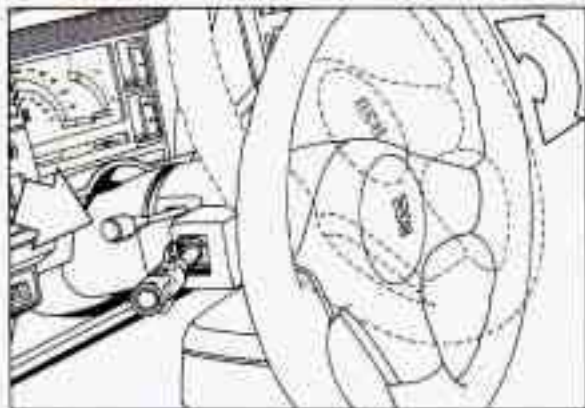

Tilt Steering Wheel

A tilt steering wheel allows you to adjust the steering wheel before you drive. You can also raise it to the highest level to give your legs more room when you exit and enter the vehicle.

To tilt the wheel, hold the steering wheel and pull the lever. Move the steering wheel to a comfortable level, then release the lever to lock the wheel in place.

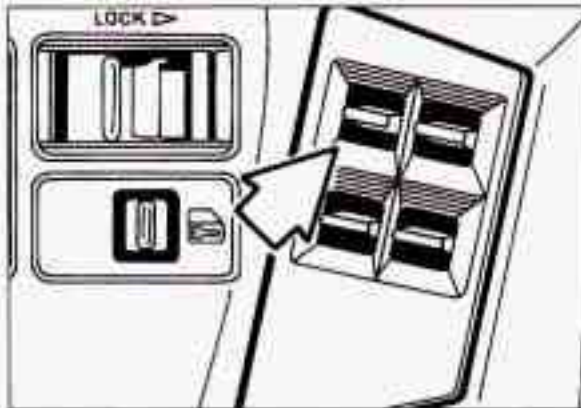

Power Windows

Switches on the driver's door control each of the windows when the ignition is on. In addition, each passenger door has a control switch for its own window.

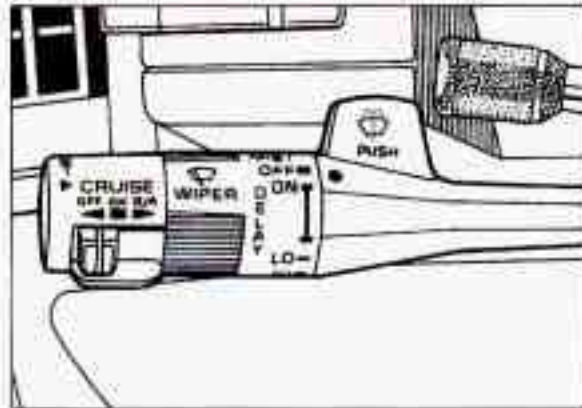

Turn Signal/Multifunction Lever

The lever on the left side of the steering column includes your:

- Turn Signal and Lane Change Indicator
- Cruise Control
- Headlight High-Low Beam
- Windshield Wipers
- Windshield Washer

The High-Low Beam feature is discussed under *Headlights*. See the *Index* under *Headlights*.

Features & Controls

Operation of Lights

Although your vehicle's lighting system (headlights, parking lights, fog lamps, side marker lights and taillights) meets all applicable federal lighting requirements, certain states and provinces may apply their own lighting regulations that may require special attention before you operate these lights.

For example, some jurisdictions may require that you operate your fog lamps only when your lower beam headlights are also on, or that headlights be turned on whenever you must use your windshield wipers. In addition, most jurisdictions prohibit driving solely with parking lights, especially at dawn or dusk. It is recommended that you check with your own state or provincial highway authority for applicable lighting regulations.

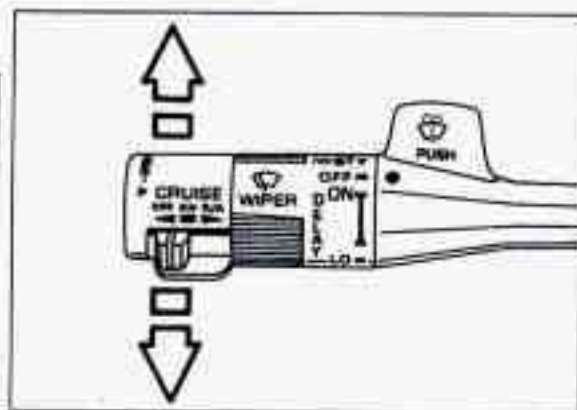

Turn Signal and Lane Change Indicator

The turn signal has two upward (for Right) and two downward (for Left) positions. These positions allow you to signal a turn or a lane change.

To signal a turn, move the lever all the way up or down. When the turn is finished, the lever will return automatically.

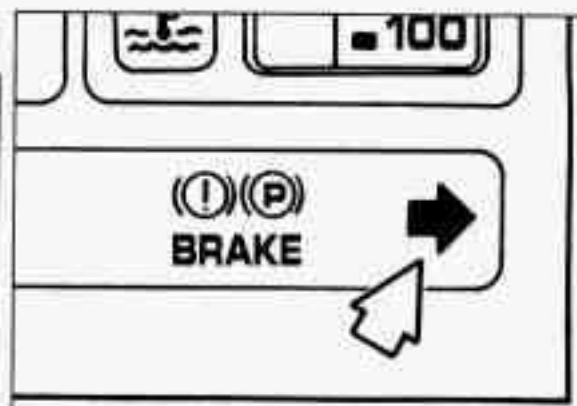

A green arrow on the instrument panel will flash in the direction of the turn or lane change.

To signal a lane change, just raise or lower the lever until the green arrow starts to flash. Hold it there until you complete your lane change. The lever will return by itself when you release it.

As you signal a turn or a lane change, if the arrows don't flash but just stay on, a signal bulb may be burned out and other drivers won't see your turn signal. If your vehicle has the electronic instrument cluster, the turn signal arrows will flash at a faster rate if a signal bulb is burned out.

If a bulb is burned out, replace it to help avoid an accident.

If the green arrows don't go on at all when you signal a turn, check the fuse (see the *Index* under *Fuses & Circuit Breakers*) and for burned-out bulbs.

If you have a trailer towing option with added wiring for the trailer lights, a different turn signal flasher is used. With this flasher installed, the signal indicator will flash even if a turn signal bulb is burned out. Check the front and rear turn signal lights regularly to make sure they are working.

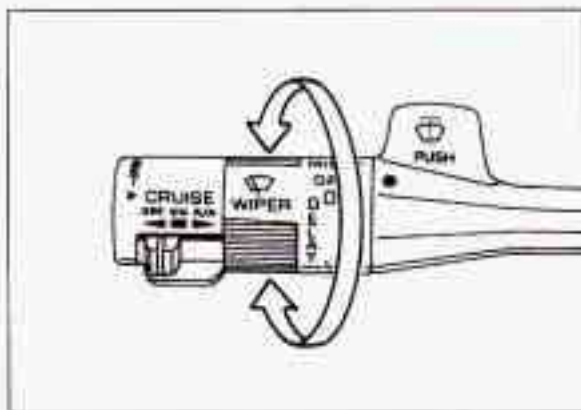

Windshield Wipers

You control the windshield wipers by turning the band marked **WIPER**.

For a single wiping cycle, turn the band to **MIST**. Hold it there until the wipers start, then let go. The wipers will stop after one cycle. If you want more cycles, hold the band on **MIST** longer.

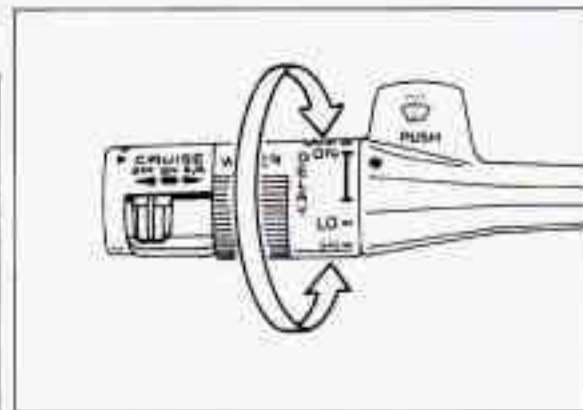

You can set the wiper speed for a long or short delay between wipes. This can be very useful in light rain or snow. Turn the band to choose the delay time. The closer to **LO**, the shorter the delay.

For steady wiping at low speed, turn the band away from you to the **LO** position. For high speed wiping, turn the band further, to **HI**. To stop the wipers, move the band to **OFF**.

Remember that damaged wiper blades may prevent you from seeing well enough to drive safely. To avoid damage, be sure to clear ice and snow from the wiper blades before using them. If they're frozen to the windshield, carefully loosen or thaw them. If your blades do become damaged, get new blades or blade inserts.

Features & Controls

Heavy snow or ice can overload your wipers. A circuit breaker will stop them until the motor cools. Clear away snow or ice to prevent an overload.

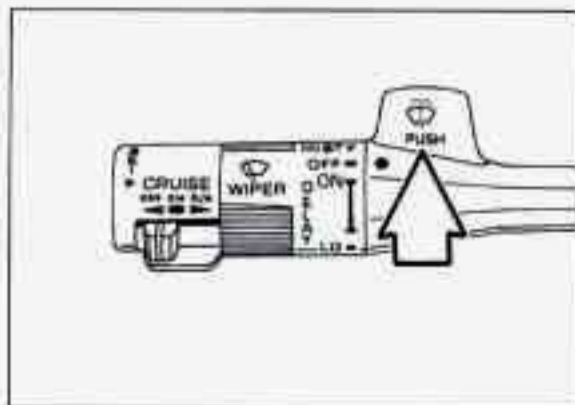

Windshield Washer

At the top of the turn signal/multifunction lever there's a paddle with the word **PUSH** on it. To spray washer fluid on the windshield, push the paddle.

The wipers will clear the window and then either stop or return to your preset speed.

See the *Index* under *Windshield Washer Fluid*.



CAUTION:

In freezing weather, don't use your washer until the windshield is warmed. Otherwise the washer fluid can form ice on the windshield, blocking your vision.

Driving without washer fluid can be dangerous. A bad mud splash can block your vision. You could hit another vehicle or go off the road. Check your washer fluid level often.

NOTICE:

- When using concentrated washer fluid, follow the manufacturer's instructions for adding water.
- Don't mix water with ready-to-use washer fluid. Water can cause the solution to freeze and damage your washer fluid tank and other parts of the washer system. Also, water doesn't clean as well as washer fluid.
- Fill your washer fluid tank only 3/4 full when it's very cold. This allows for expansion, which could damage the tank if it is completely full.
- Don't use radiator antifreeze in your windshield washer. It can damage your washer system and paint.

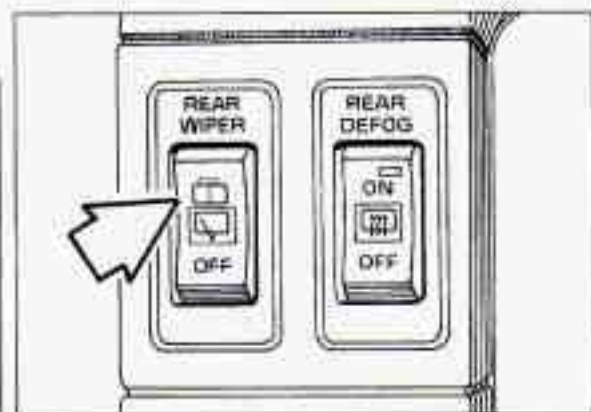

Rear Window Wiper and Washer

The switch to control the rear window wiper and washer is on the left side of the instrument panel.

To Turn the Wiper On:

Press the top of the switch to the first position.

To Wash the Window:

Press the top of the switch in all the way and hold it there. The wiper will continue to work after you release the switch.

To Turn the Wiper Off:

Press the bottom of the switch.

The rear window washer uses the same fluid reservoir as the windshield washer. However, the rear window washer will run out of fluid before the windshield washer, because fluid will not flow easily to the rear of the vehicle when the fluid reaches a low level. If you can wash your windshield but not your rear window, check your fluid level.

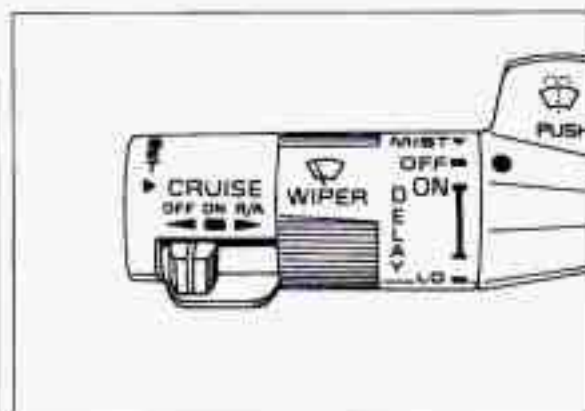

■ Cruise Control

With cruise control, you can maintain a speed of about 25 mph (40 km/h) or more without keeping your foot on the accelerator. This can really help on long trips.

Cruise control does not work at speeds below about 25 mph (40 km/h).

When you apply your brakes, the cruise control shuts off.

Features & Controls



CAUTION:

- Cruise Control can be dangerous where you can't drive safely at a steady speed. So, don't use your Cruise Control on winding roads or in heavy traffic.
- Cruise Control can be dangerous on slippery roads. On such roads, fast changes in tire traction can cause needless wheel spinning, and you could lose control. Don't use Cruise Control on slippery roads.

To Set Cruise Control

1. Move the cruise control switch to **ON**.



CAUTION:

If you leave your Cruise Control switch on when you're not using Cruise, you might hit a button and go into Cruise when you don't want to. You could be startled and even lose control. Keep the Cruise Control switch **OFF** until you want to use it.

2. Get up to the speed you want.

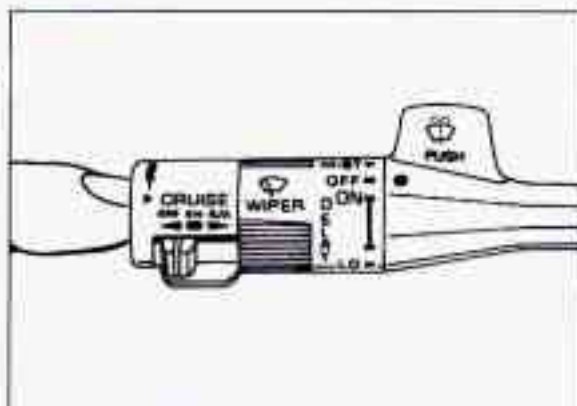

3. Push in the **SET** button at the end of the lever and release it.
4. Take your foot off the accelerator pedal.

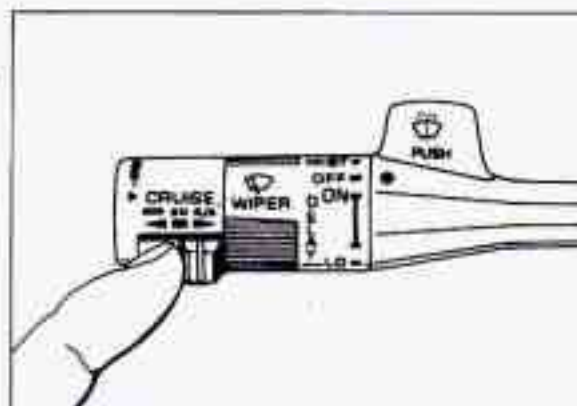

To Resume a Set Speed

Suppose you set your cruise control at a desired speed and then you apply the brake. This, of course, shuts off the cruise control. But you don't need to reset it. Once you're going about 25 mph (40 km/h) or more, you can move the cruise control switch from **ON** to **R/A** (which stands for Resume/Accelerate) for about half a second.

You'll go right back up to your chosen speed and stay there.

If you hold the switch at **R/A** longer than half a second, the vehicle will keep going faster until you release the switch or apply the brake. You could be startled and even lose control. So unless you want to go faster, don't hold the switch at **R/A**.

To Increase Speed While Using Cruise Control

There are two ways to go to a higher speed. Here's the first:

1. Use the accelerator pedal to get to the higher speed.
2. Push the button at the end of the lever, then release the button and the accelerator pedal. You'll now cruise at the higher speed.

Here's the second way to go to a higher speed:

- Move the cruise switch from **ON** to **R/A**. Hold it there until you get up to the speed you want, and then release the switch.
- To increase your speed in very small amounts, move the switch to **R/A** for less than half a second and then release it. Each time you do this, your vehicle will go about 1 mph (1.6 km/h) faster.

To Reduce Speed While Using Cruise Control

There are two ways to reduce your speed while using cruise control:

- Push in the button at the end of the lever until you reach the lower speed you want, then release it.
- To slow down in very small amounts, push the button for less than half a second. Each time you do this, you'll go 1 mph (1.6 km/h) slower.

Passing Another Vehicle While Using Cruise Control

Use the accelerator pedal to increase your speed. When you take your foot off the pedal, your vehicle will slow down to the cruise control speed you set earlier.

Using Cruise Control on Hills

How well your cruise control will work on hills depends upon your speed, load, and the steepness of the hills. When going up steep hills, you may have to step on the accelerator pedal to maintain your speed. When going downhill, you may have to brake or shift to a lower gear to keep your speed down. Of course, applying the brake takes you out of cruise control. Many drivers find this to be too much trouble and don't use cruise control on steep hills.

To Get Out of Cruise Control

There are two ways to turn off the cruise control:

- Step lightly on the brake pedal; OR
- Move the cruise switch to **OFF**.

To Erase Cruise Speed Memory

When you turn off the cruise control or the ignition, your cruise control set speed memory is erased.

Features & Controls

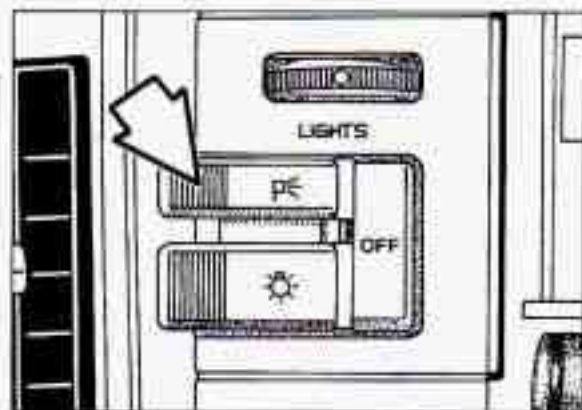

Headlights

Push the switch marked P to turn on:

- Parking Lights
- Side Marker Lights
- Taillights
- Instrument Panel Lights

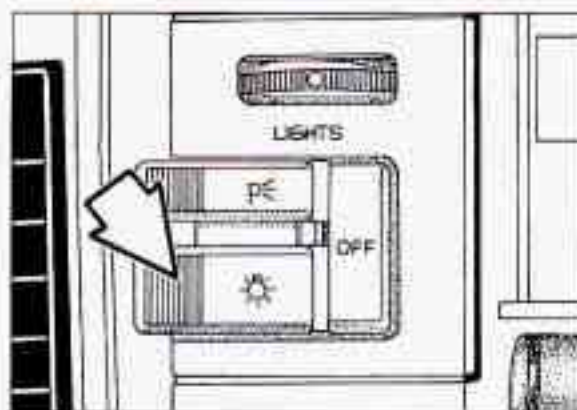

Push the \odot switch to turn on the headlights, together with:

- Parking Lights
- Side Marker Lights
- Taillights
- Instrument Panel Lights

Pull the switch or press **OFF** to turn off the lights.

Lights on Reminder

If you open the door while leaving the lights on, you will hear a warning tone.



Headlight High-Low Beam

To change the headlights from low beam to high or high to low, pull the turn signal lever all the way toward you. Then release it.

When the high beams are on, a blue light on the instrument panel also will be on.

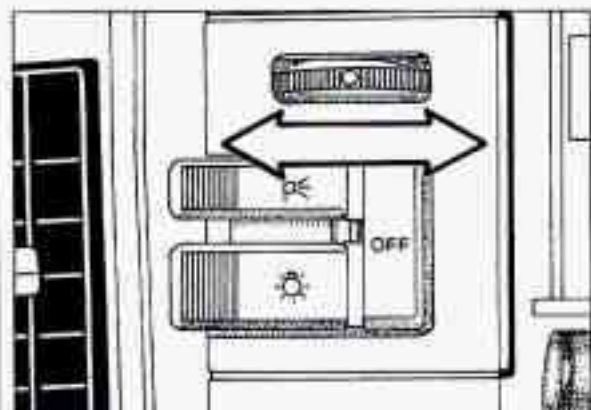

Instrument Panel Intensity Control

Turn the dial above the headlight switch to the left to dim your instrument panel lights. This will also silence your Lights On Reminder.

Turn the dial to the right to make your instrument panel lights brighter. If you turn the dial all the way to the right until it clicks, your interior lights will come on.

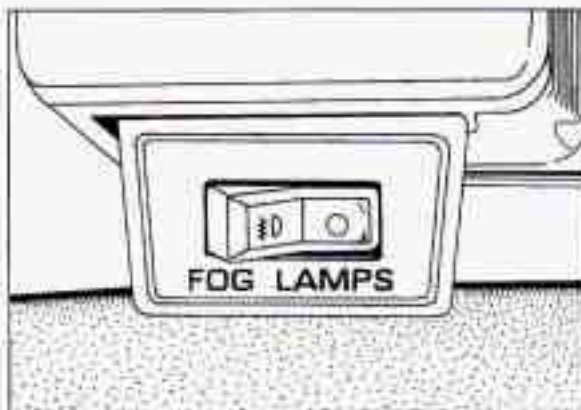

Fog Lights

Use your fog lights for better vision in foggy or misty conditions. Your parking lights or low beam headlights must be on for them to come on.

The fog light switch is on the instrument panel under the headlight switch. Press the right side of the switch to turn the fog lights on, and the left side of the switch to turn them off. An indicator light will glow in the right side of the switch when they are on.

Remember, fog lights alone will not give off as much light as your headlights. Never use your fog lights in the dark without turning on your headlights.

The fog lights will go off whenever your high beam headlights come on. When the high beams go off, the fog lights will come on again.

Features & Controls

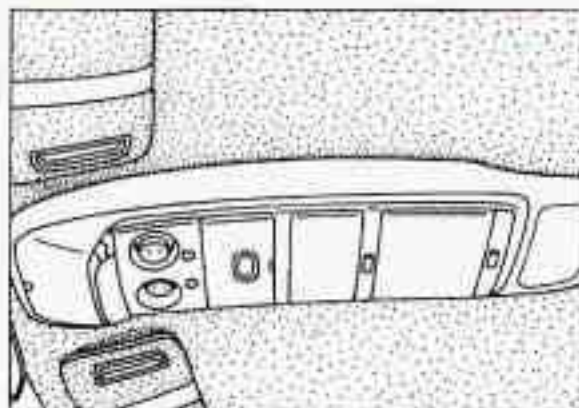

■ Overhead Console

The front overhead console has reading lights, a center dome light, a compass and outside temperature display, and storage compartments—including one for your garage door opener and one for sunglasses.

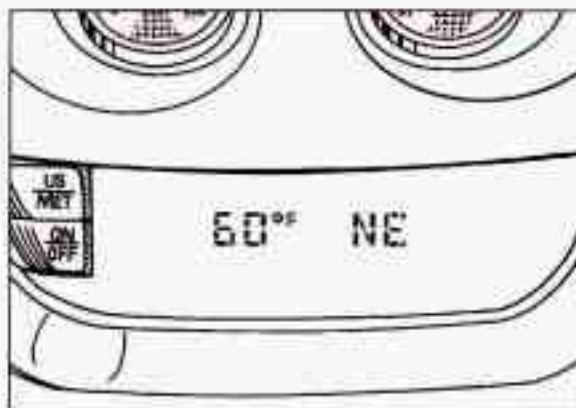

Temperature and Compass Display

The outside air temperature and the compass are displayed at the front of the overhead console. The control switches are located to the left of the display.

Turn the display on or off by pressing the **ON/OFF** switch. Display the temperature in either degrees Fahrenheit (English) or Celsius (metric) by pressing the **US/MET** switch.

Before you turn on the ignition and move the vehicle, the temperature indicated will be the last outside temperature recorded with the ignition on.

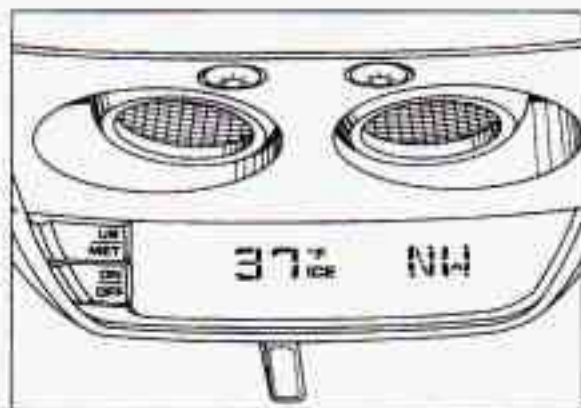

If the outside temperature is 37°F (3°C) or lower when you turn on the ignition, **ICE** will appear on the display. It's a caution to the driver that road conditions may be icy, and that appropriate precautions should be taken.

Compass Calibration:

The compass is self-calibrating, so it does not need to be manually set. However, when your Bravada is new, the compass may function erratically. If it does, **CAL** (Calibration) will appear on the display. To correct the problem, drive in a complete 360° circle three times, and the compass will function normally.



Compass Variance:

Variance is the difference between magnetic north and geographic north. In some areas the difference between the two can be great enough to cause false compass readings. If this happens, follow these instructions to set the variance for your particular location:

1. Locate your location on the zone map. Note your zone number.

2. Press and hold both the **ON/OFF** and the **US/MET** switches. The display will go off.
3. After 5 seconds, **VAR CAL** will appear on the display. When it does, release both buttons.
4. Press **US/MET** until your zone number appears on the display.
5. Press **ON/OFF** to enter your zone number. Your variance is now set.

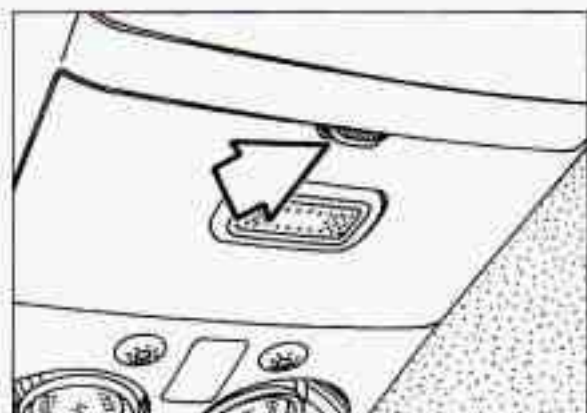

Garage Door Opener Compartment

You can store your garage door opener in the front compartment of your overhead console, and operate it from this position. To install your garage door opener, follow these instructions:

1. Open the compartment by pressing the compartment latch forward. Remove the piece of self-sticking Velcro[®].

Features & Controls

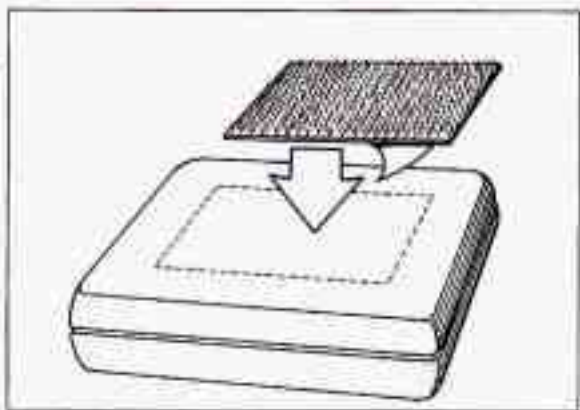

2. Then peel the protective backing from the Velcro[®] and press it firmly to the back of your garage door opener.

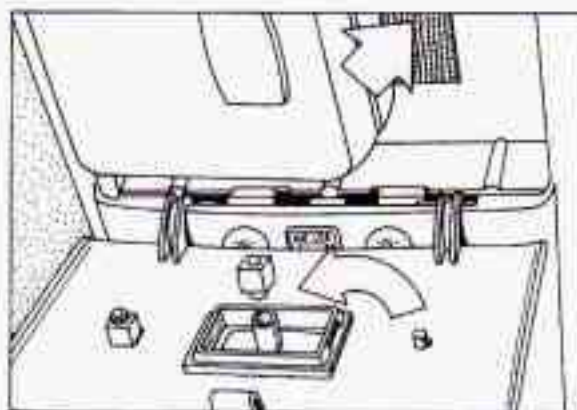

3. To make sure the button on your garage door opener is centered above the button on the compartment door, use the white intersecting lines inside the compartment as a guide. Center the control button of your garage door opener over the point where the lines intersect, and press the opener firmly into place. Make sure the button is facing down.

4. Once the opener is installed, the button on the compartment door must be adjusted so that it will contact the control button on your garage door opener. Use the pegs located inside the compartment door.

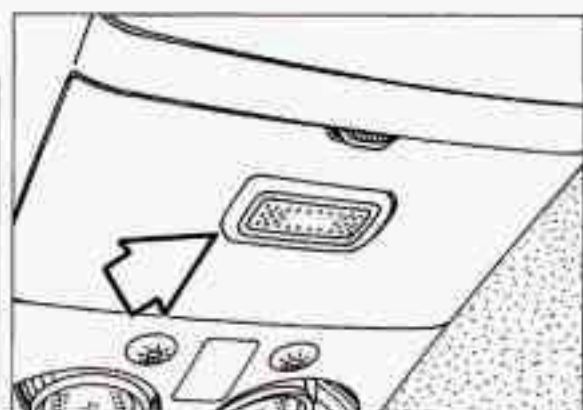

5. Add one peg at a time until your garage door opener operates when you press the button with the compartment door closed.

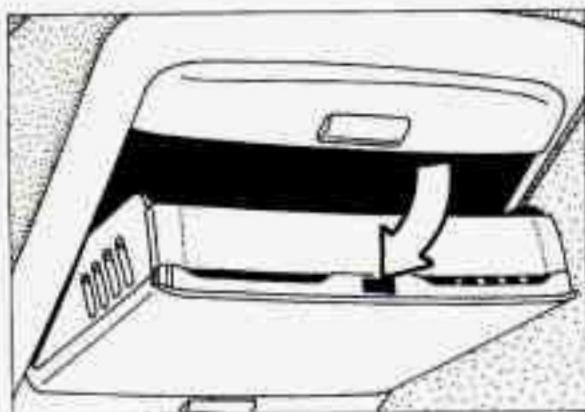

Overhead Storage Compartment

To open the rear storage compartment in the overhead console, press the release button.

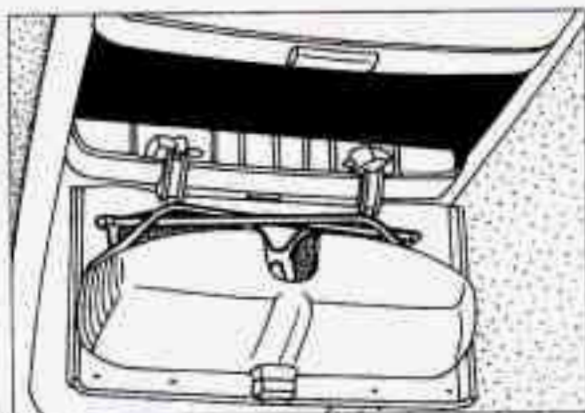

Sunglasses Storage Compartment

To open the sunglasses storage compartment in the overhead console, press the release button. Then pull the compartment down to the full open position, as shown.

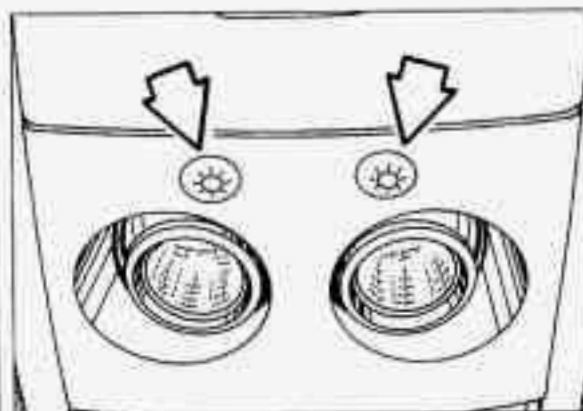

Console Reading Lights

To turn either reading light on or off, press the switch next to it. To adjust the aim of the lights, simply pivot the lamps in their sockets.

Features & Controls

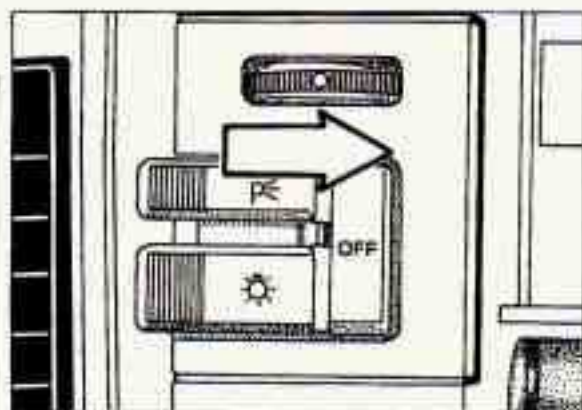

Center Dome Light

Located in the center of your vehicle, this light has no switch of its own. It will go on each time you open the doors. You can also turn it on by turning the Instrument Panel Intensity Control to the right until it clicks.

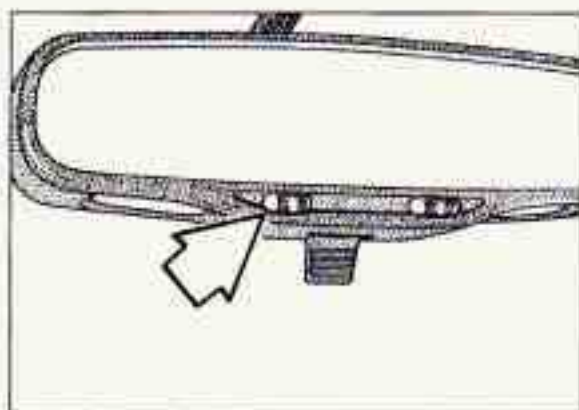

Front Reading Lights

These lights are part of the rearview mirror, and may be operated in two ways:

- With the ignition on, turn each light on and off with its switch.
- With the ignition off, open any door. These lights will come on for about 15 seconds, then turn off. If you turn on the ignition during this delay, the lights will turn off immediately.

To avoid draining your vehicle battery's power, be sure to turn off all interior lights when leaving your vehicle. But remember that the mirror reading lights will still come on for about 15 seconds, then turn off.

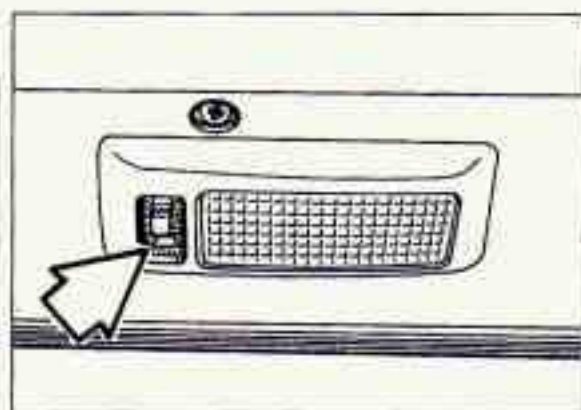

Rear Dome Light

The rear dome light will come on with the center dome light each time you open the doors. It also has a switch. Be sure to turn it off when you are finished using it.

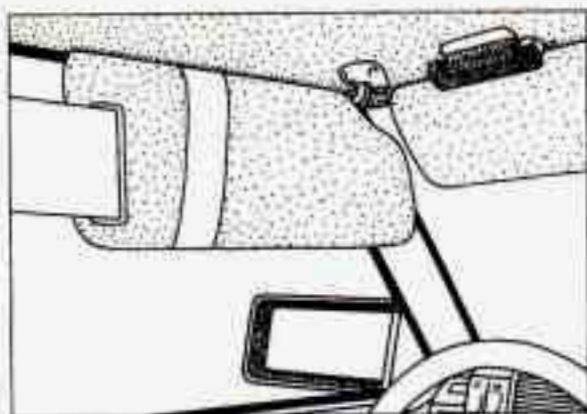

Sun Visors

To block out glare, you can swing down the visors. You can also remove them from the center mount and swing them to the side, while the auxiliary sunshade remains to block glare from the front. To extend the visors at the sides, pull out the sunshade.

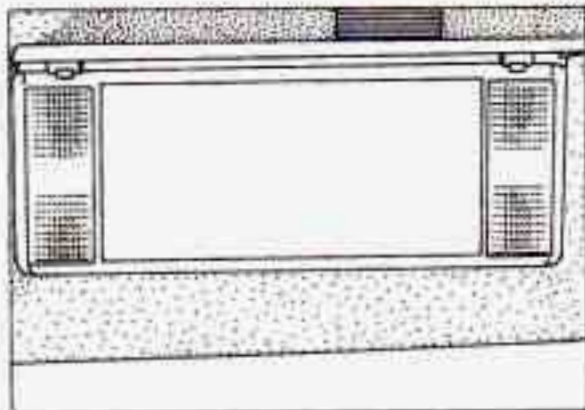

Lighted Visor Vanity Mirrors

Open the covers to expose the vanity mirror. The lights come on when you open the cover. These can even be used for reading.

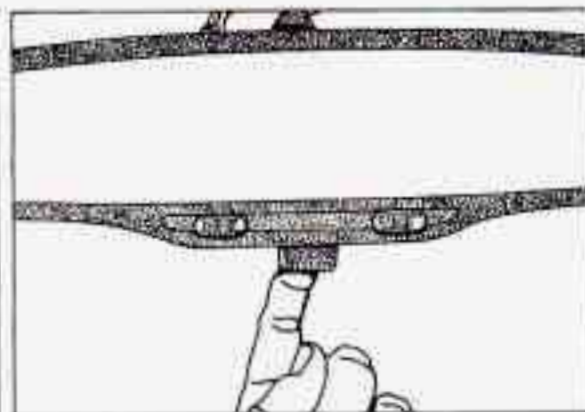

Inside Day/Night Rearview Mirror

To reduce glare from lights behind you, pull the lever toward you to the night position. For information on this mirror's reading lights, see the *Index* under *Front Reading Lights*.

Features & Controls

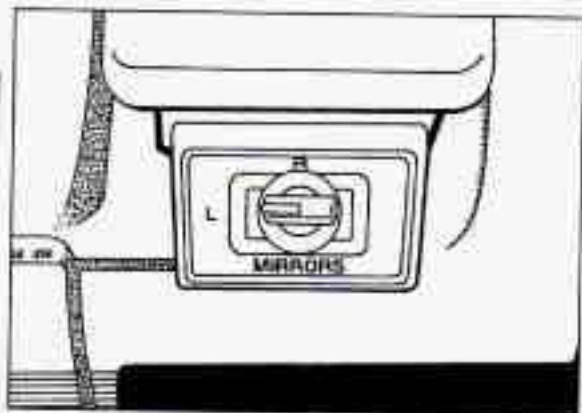

Power Remote Control Mirrors

Use the control on the instrument panel to adjust both outside rearview mirrors. Turn the control to the left to select the driver's side rearview mirror, or to the right to select the passenger side rearview mirror. Then use the control to adjust each mirror so that you can just see the side of your vehicle when you are sitting in a comfortable driving position.



■ **Convex Outside Mirror**

Your right side mirror is convex.

A convex mirror's surface is curved so you can see more from the driver's seat.



CAUTION:

If you aren't used to a convex mirror, you can hit another vehicle. A convex mirror can make things (like other vehicles) look farther away than they really are. If you cut too sharply into the right lane, you could hit a vehicle on your right. Check your inside mirror or glance over your shoulder before changing lanes.

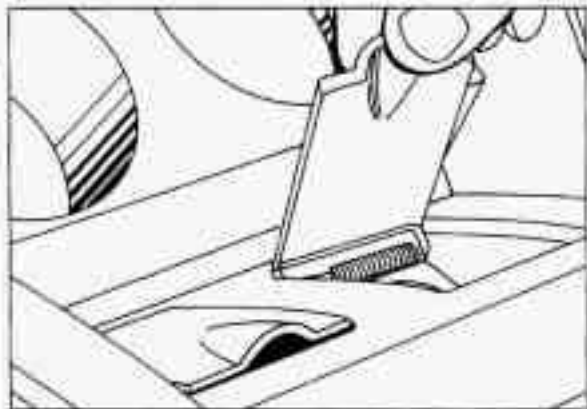

Accessory Power Outlets

The two power outlets on the center console can be used to plug in electrical equipment such as a cellular telephone, CB radio, etc. Follow the proper installation instructions that are included with any electrical equipment you install.

NOTICE:

When using the accessory power outlets:

- Maximum load of all electrical equipment should not exceed 8 amps.
- Be sure to turn off any electrical equipment when not in use. Leaving electrical equipment on for extended periods can drain your battery.

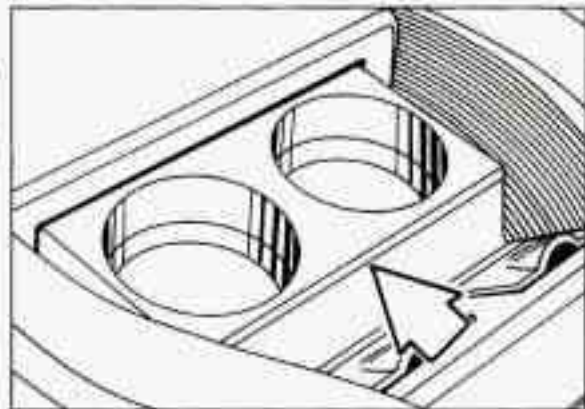

Storage Compartments

The center console has a cup holder and two storage compartments.

To open the cup holder, lightly press on the edge.

Push the cup holder back in until it clicks when it's not in use.

Features & Controls

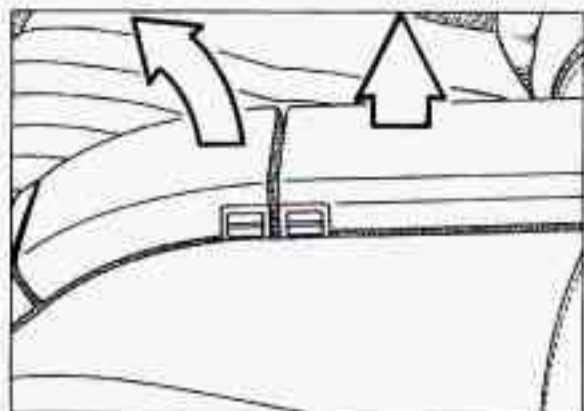

There are also two storage compartments with latching lids. Press the latch and lift the cover to open these. The smaller compartment has a molded rack for cassette tapes and compact discs. The larger one has a removable tray.

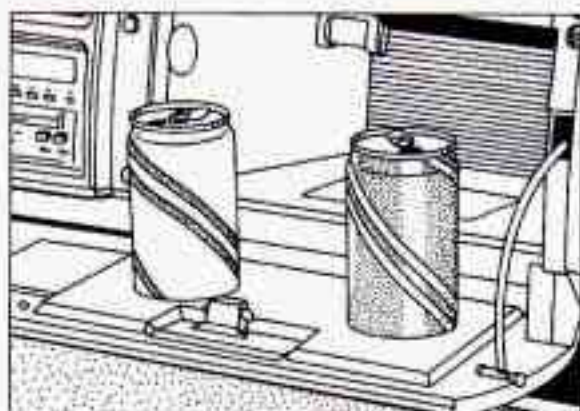

There are two cup holders inside the glove box door. Note that the glove box light will remain on while the door is open.

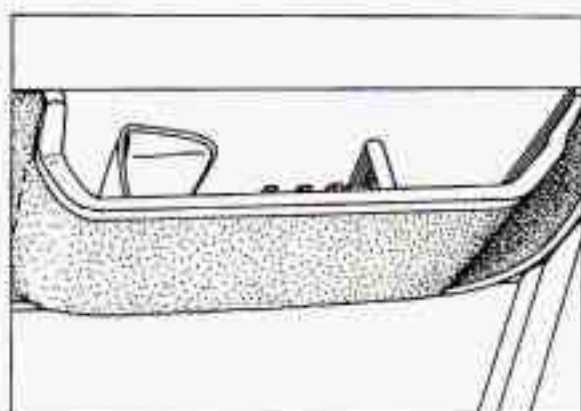

You will find a storage compartment on each of the front doors. The driver's door pocket contains a coin holder. A narrow storage shelf runs along the bottom of the instrument panel. It's handy for items such as gloves or small books.

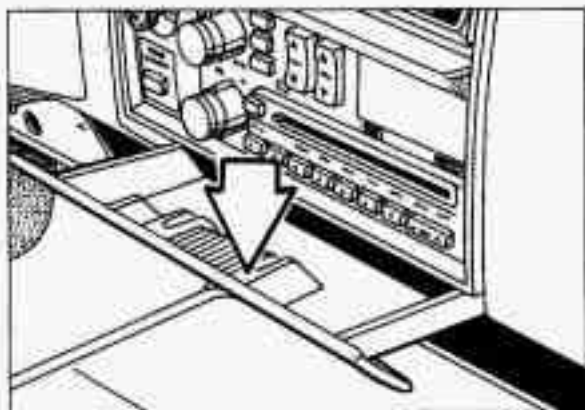

Ashtrays and Lighter

The front ashtray is located below the radio. To use the ashtray, pull it toward you.

To remove the ashtray for cleaning, press down on the front edge of the ashtray and pull the entire ashtray out of the instrument panel.

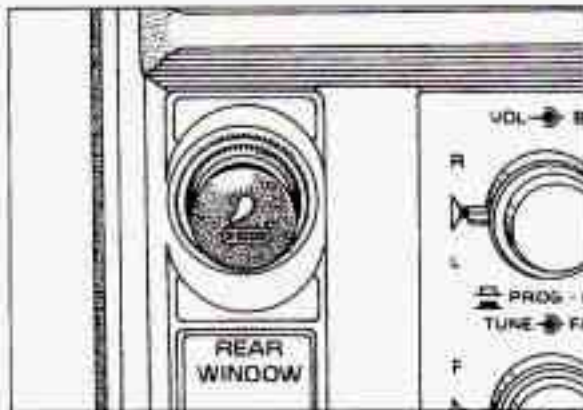

To use the lighter, push it in all the way and let go. When it's ready, it will pop back by itself.

NOTICE:

Don't hold a cigarette lighter in with your hand while it is heating. If you do, it won't be able to back away from the heating element when it's ready. That can make it overheat, damaging the lighter and the heating element.

Features & Controls

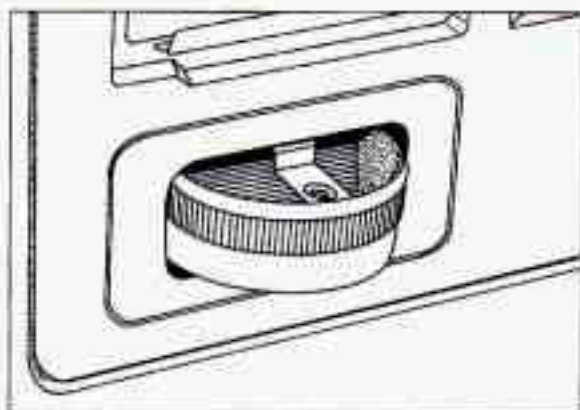

The rear ashtrays are located in the rear doors. To remove them for cleaning, press down on the snuffer and pull them out.

NOTICE:

Don't put papers and other things that burn into your ashtrays. If you do, cigarettes or other smoking materials could set them on fire, causing damage.

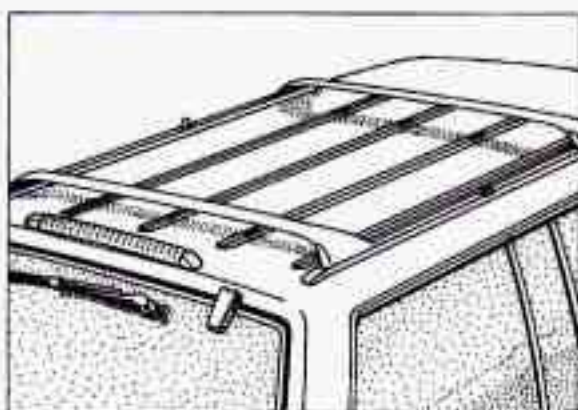

Luggage Carrier

You can load things on top of your vehicle. The luggage carrier has slats and side rails attached to the roof, and crossrails which can be moved forward and rearward in the side rails to secure cargo.

NOTICE:

Loading cargo that weighs more than 200 pounds (91 kg) on the luggage carrier may damage your vehicle. When you carry large things, never let them hang over the rear or the sides of your vehicle. Load your cargo so that it rests on the slats and does not scratch or damage the vehicle. Put the cargo against the side rails and fasten it securely to the luggage carrier. Put the main weight as far forward as you can.

Don't exceed the maximum vehicle capacity when loading your Oldsmobile. For more information on vehicle capacity and loading, see the *Index* under *Loading Your Vehicle*.

To prevent damage or loss of cargo as you're driving, check now and then to make sure the luggage carrier and cargo are still securely fastened.

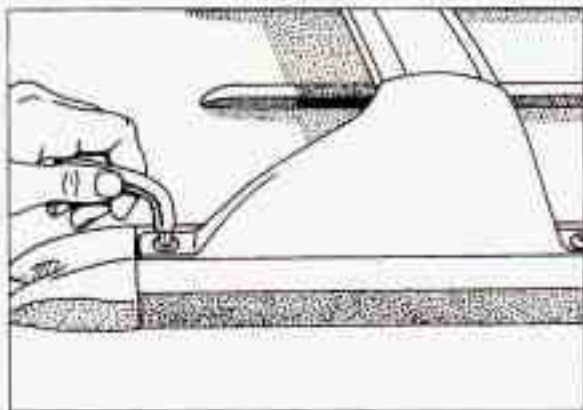

To adjust the front crossrail, loosen the screws (there are two on each side) with the Torx® head wrench provided in the glove box. Slide the crossrail back. After repositioning, be sure to retighten the screws and return the wrench to its storage place.

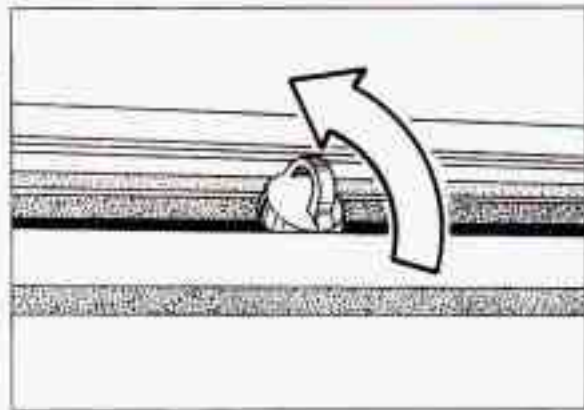

Use the tiedown loops to help secure large loads. To adjust them, turn them counterclockwise until they slide freely on the side rails. Tighten them in place by turning them clockwise.

Cargo Bed Liner

The removable cargo bed liner is washable. See the *Index* under *Cleaning Vinyl or Leather*.

Features & Controls

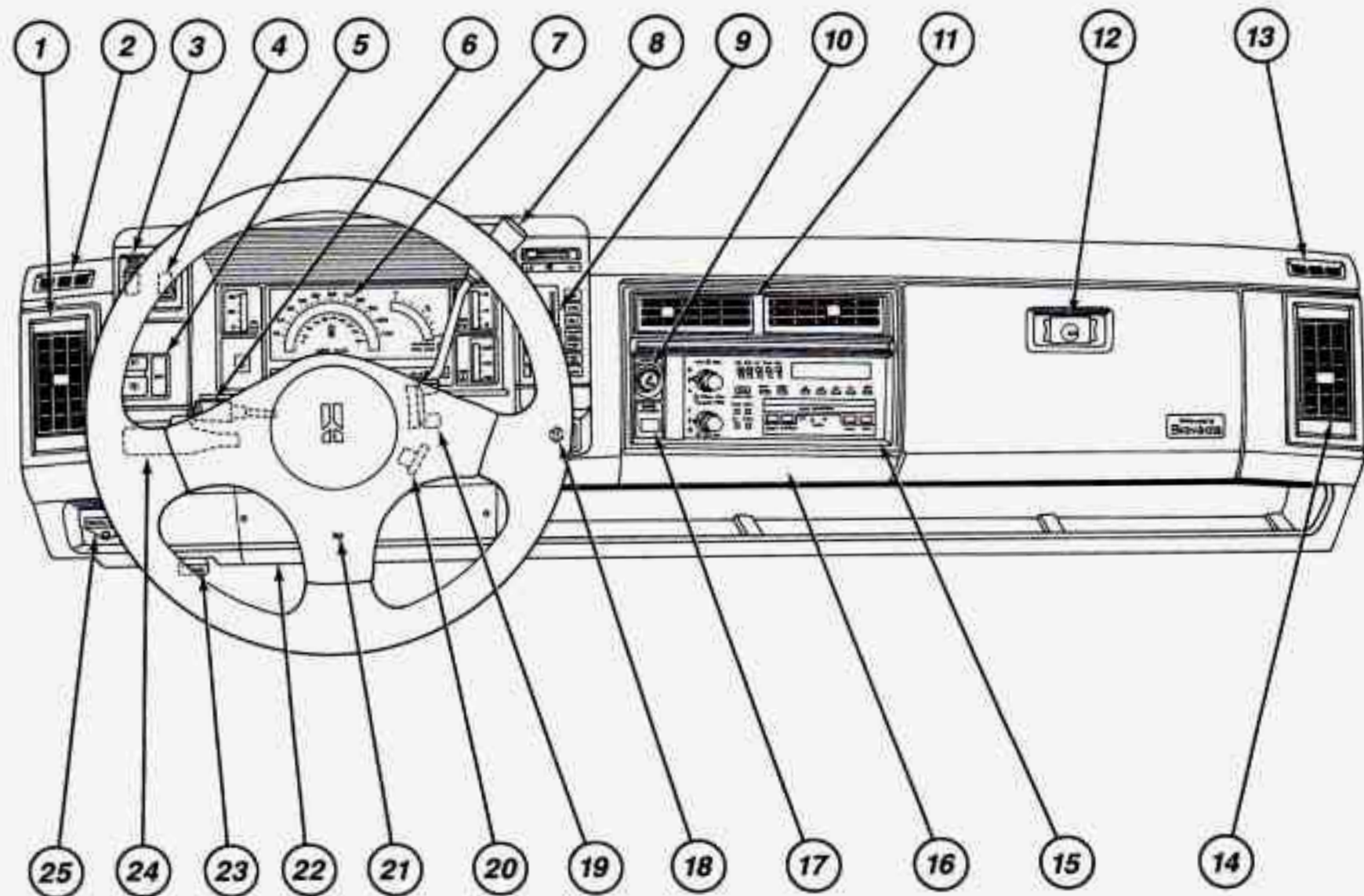

The Instrument Panel—Your Information System

Your instrument panel is designed to let you know at a glance how your vehicle is running. You'll know how fast you're going, how much fuel you're using, and many other things you'll need to drive safely and economically.

The main components of your instrument panel are:

1. Side Vents
2. Side Window Defogger
3. Rear Window Wiper/Washer
4. Rear Window Defogger
5. Light Controls
6. Tilt Steering Wheel Lever
7. Instrument Cluster
8. Gearshift Lever
9. Climate Controls
10. Lighter
11. Center Vents
12. Glove Box
13. Side Window Defogger
14. Side Vents
15. Audio System
16. Ashtray
17. Tailgate Window Release
18. Power Remote Control Mirrors
19. Ignition Switch
20. Hazard Warning Flashers Switch
21. Horn
22. Fuse Panel (under instrument panel)
23. Hood Release
24. Turn Signal/Multifunction Lever
25. Parking Brake Release

Features & Controls

■ Instrument Panel Clusters

You have one of these instrument panel clusters, which include indicator warning lights and gages that are explained on the following pages. Be sure to read about those that apply to the instrument panel cluster for your Oldsmobile.

STANDARD CLUSTER

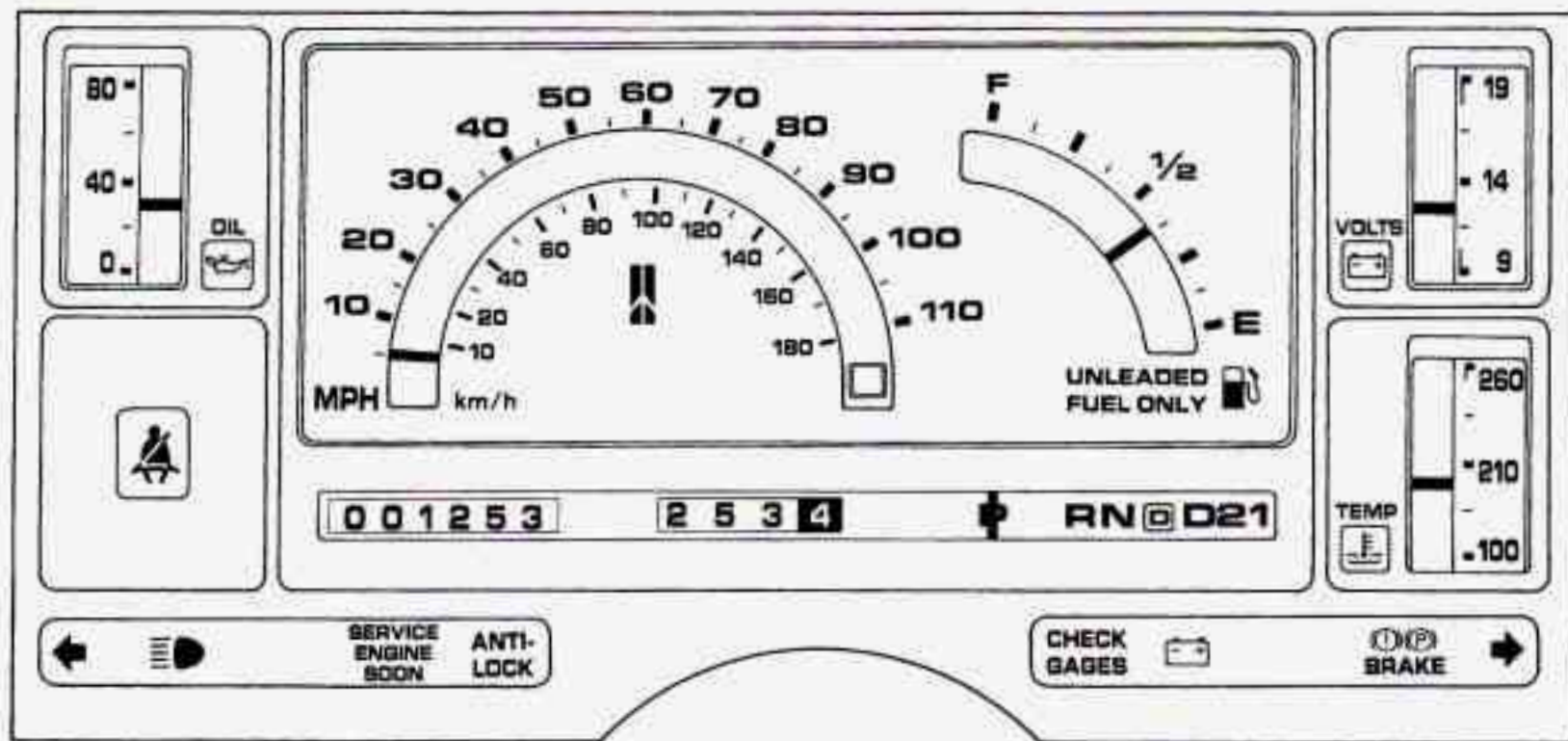

ELECTRONIC CLUSTER (OPTION)

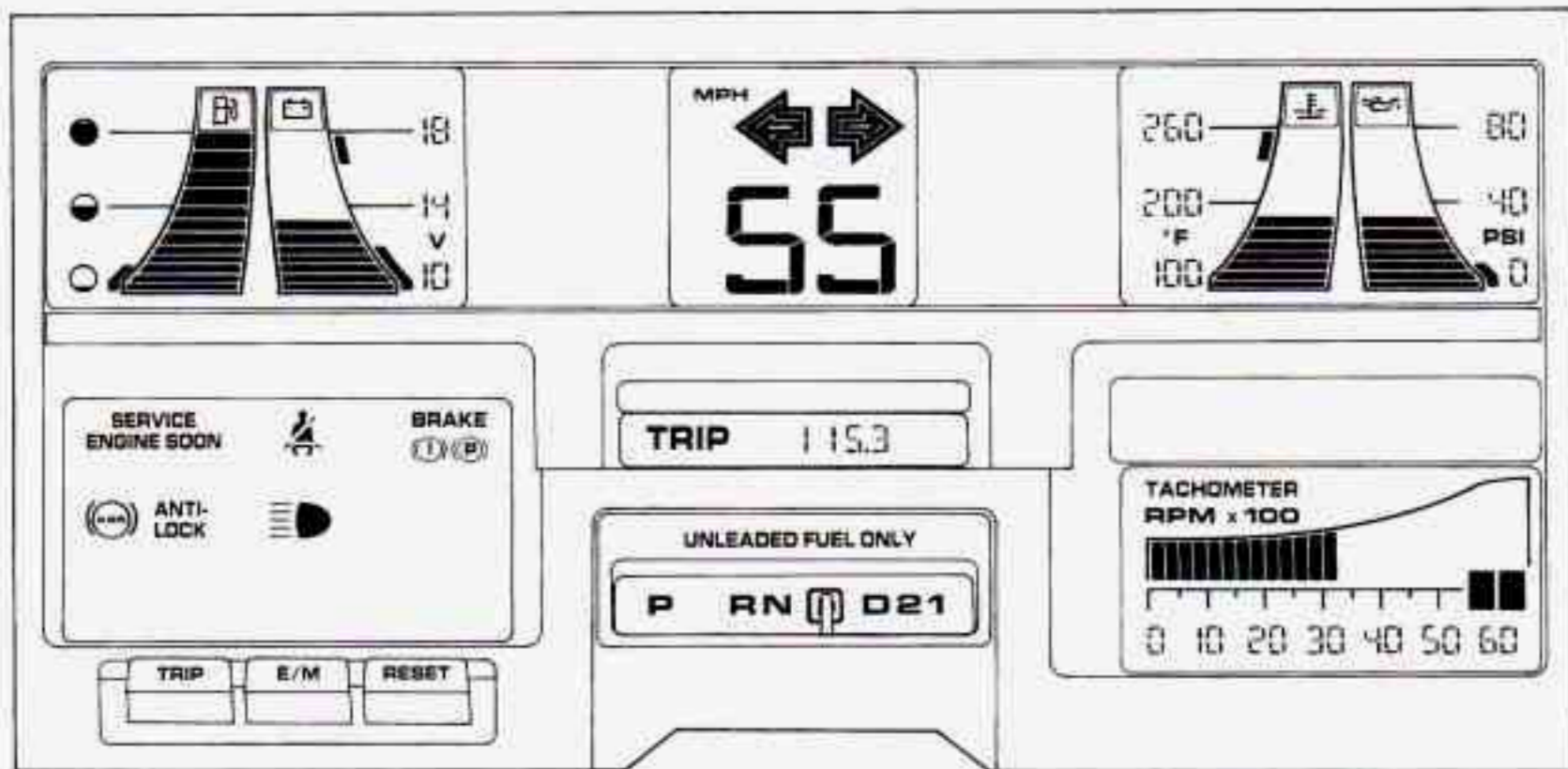

Features & Controls

■ *Warning Lights, Gages and Indicators*

This section describes the warning lights and gages that may be on your vehicle. The pictures will help you locate them.

Warning lights and gages can signal that something is wrong before it becomes serious enough to cause an expensive repair or replacement. Paying attention to your warning lights and gages could also save you or others from injury.

Warning lights go on when there may be or is a problem with one of your vehicle's functions. As you will see in the details on the next few pages, some warning lights come on briefly when you turn the ignition key just to let you know they're working. If you are familiar with this section, you should not be alarmed when this happens.

Gages can indicate when there may be or is a problem with one of your vehicle's functions. Often gages and warning lights work together to let you know when there's a problem with your vehicle.

When one of the warning lights comes on and stays on when you are driving, or when one of the gages shows there may be a problem, check the section that tells you what to do about it. Please follow the manual's advice. Waiting to do repairs can be costly — and even dangerous. So please get to know your warning lights and gages. They're a big help.

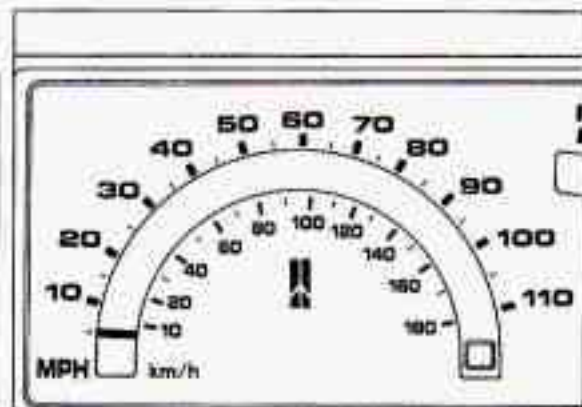

■ *Speedometer (STANDARD CLUSTER)*

Your speedometer lets you see your speed in both miles per hour (mph) and kilometers per hour (km/h).

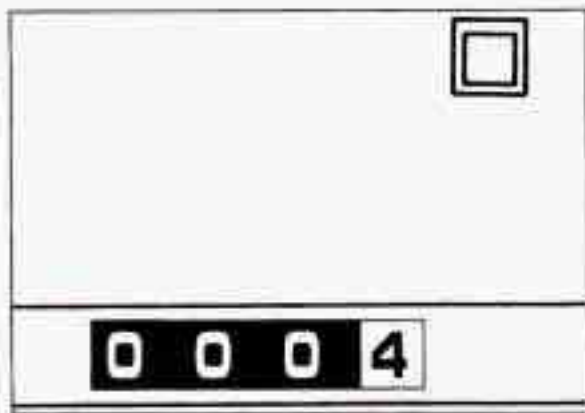

■ *Odometer and Trip*

Odometer (STANDARD CLUSTER)

Your odometer shows how far your vehicle has been driven, in either miles (used in the U.S.) or kilometers (used in Canada).

Your trip odometer tells how far you have driven since you last reset it. To set it to zero, press the reset button located in the right end of the speedometer.

Your Oldsmobile has a tamper resistant odometer. If you see silver lines between the numbers, you'll know someone has probably tampered with it and the numbers may not be true.

You may wonder what happens if your vehicle needs a new odometer installed. If the new one can be set to the mileage total of the old odometer, then it must be. But if it can't, then it's set at zero and a label must be put on the driver's door to show the old mileage reading when the new odometer was installed.

■ *Speedometer (ELECTRONIC CLUSTER)*

Displays your speed in miles per hour (mph) or kilometers per hour (km/h). See *E/M Switch* later in this section.

Features & Controls

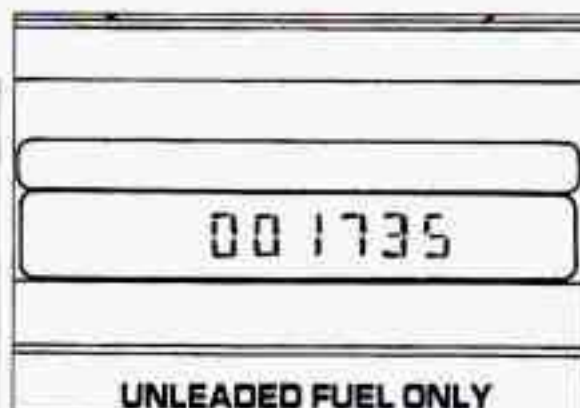

■ Odometer and Trip

Odometer (ELECTRONIC CLUSTER)

Your odometer shows how far your vehicle has been driven, in either miles (used in the U.S.) or kilometers (used in Canada). Your trip odometer tells how far you have driven since you last reset it.

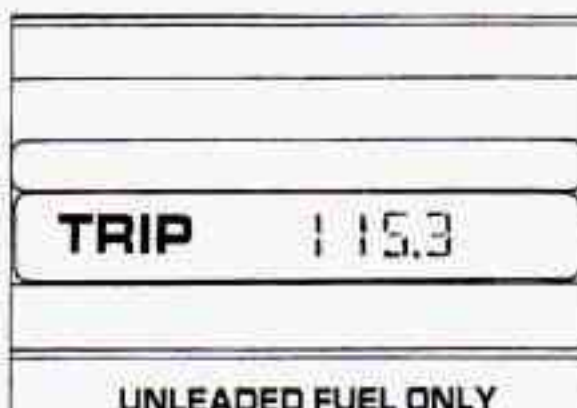

Trip mileage appears in place of the regular odometer reading when you press the **TRIP** switch down. To change back to the regular odometer, press the **TRIP** switch again.

Your Oldsmobile has a tamper resistant odometer. The odometer will read **ERROR** if someone has tampered with it.

You may wonder what happens if your vehicle needs a new odometer installed. If the new one can be set to the mileage total of the old odometer, then it must be. But if it can't, then it's set at zero and a label must be put on the driver's door to show the old mileage reading when the new odometer was installed.

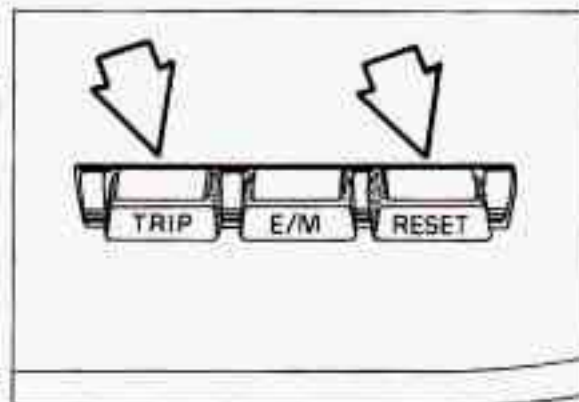

To set the trip odometer to zero, press the **TRIP** switch to display the trip odometer. Then, press the **RESET** switch.

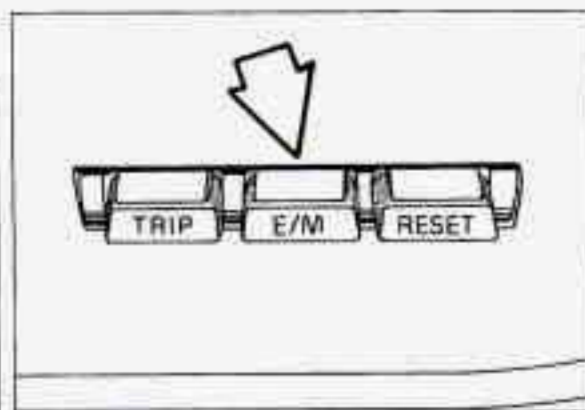

■ *E/M Switch* (ELECTRONIC CLUSTER)

To change your electronic display from English to metric units, or from metric to English, press this switch down. The gages affected are:

- Speedometer
- Odometer
- Trip Odometer
- Oil Pressure
- Engine Coolant Temperature

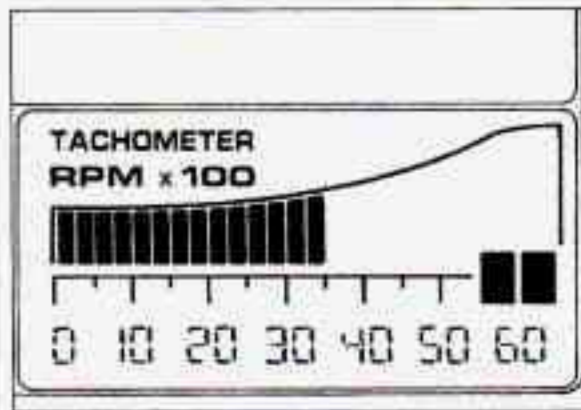

■ *Tachometer* (ELECTRONIC CLUSTER)

The tachometer displays the engine speed in revolutions per minute (rpm).

NOTICE:

Do not operate the engine with the tachometer in the red area, or engine damage may occur.

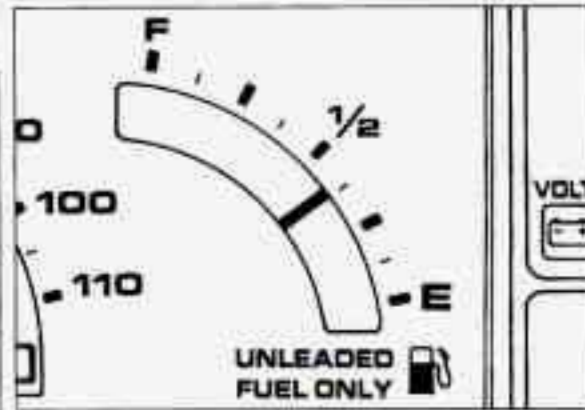

Fuel Gage (STANDARD CLUSTER)

Your fuel gage tells you about how much fuel you have left, when the ignition is on. When the indicator nears E (Empty), you will have a little fuel left but should get more soon.

Here are four things that some owners ask about. None of these show a problem with your fuel gage:

- At the service station, the gas pump shuts off before the gage reads F (Full).

Features & Controls

- It takes a little more or less fuel to fill up than the gage indicated. For example, the gage may have indicated the tank was half full, but it actually took a little more or less than half the tank's capacity to fill the tank.
- The gage moves a little when you turn a corner or speed up.
- The gage doesn't go back to E when you turn off the ignition.

For your fuel tank capacity, see *Service Station Information* on the last page of this manual.

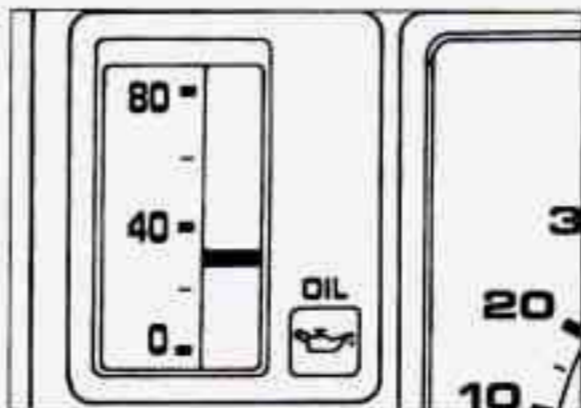

Oil Pressure Gage (STANDARD CLUSTER)

Your oil pressure gage shows the oil pressure in psi (pounds per square inch) when the engine is running. Oil pressure may vary with engine speed, outside temperature and oil viscosity.

Driving your vehicle with low oil pressure can cause extensive engine damage. Have your vehicle serviced immediately.



CAUTION:

Don't keep driving if the oil pressure is low. If you do, your engine can become so hot that it catches fire. You or others could be burned. Check your oil as soon as possible and have your vehicle serviced.

NOTICE:

Damage to your engine from neglected oil problems can be costly and is not covered by your warranty.

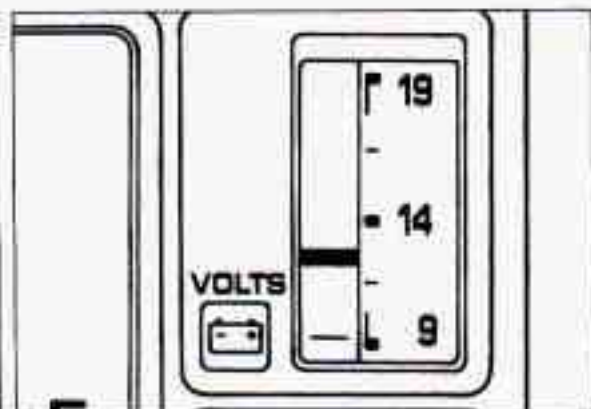

Voltmeter (STANDARD CLUSTER)

Your charging system gage will show the rate of charge when the engine is running. When the engine is not running but the ignition is on (in the **Run** position), the display measures the voltage output of your battery.

The reading will change as the rate of charge changes (with engine speed, etc.), but readings between the warning zones indicate the normal operating range. Readings in either warning zone indicate a possible problem with your charging system. Have your Oldsmobile serviced immediately.

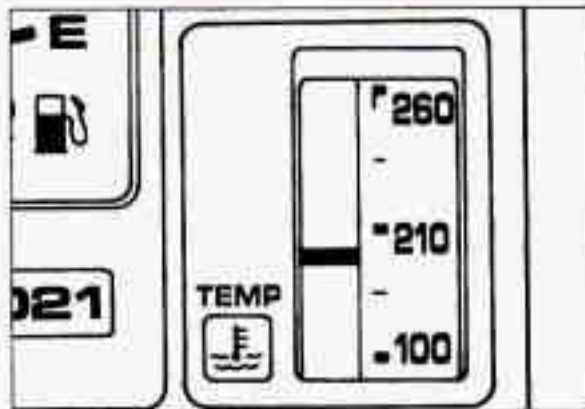

Engine Coolant Temperature Gage (STANDARD CLUSTER)

This gage shows the engine coolant temperature. If the gage pointer moves into the red area, your engine is too hot! It means that your engine coolant has overheated.

If you have been operating your vehicle under normal driving conditions, you should pull off the road, stop your vehicle and turn off the engine as soon as possible.

HOT COOLANT CAN BURN YOU BADLY!

In *Problems on the Road*, this manual shows what to do. See the *Index* under *Engine Overheating*.

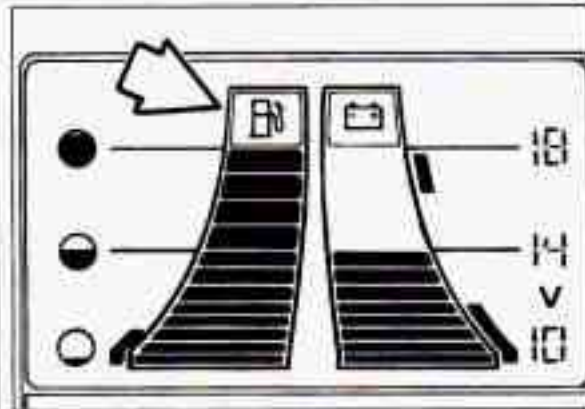

Fuel Gage (ELECTRONIC CLUSTER)

Your fuel gage bars light up when the ignition is on to show you about how much fuel you have left.

When the gage first indicates empty, you still have a little fuel left, but you should get more soon.

A box around the gas pump symbol will flash when your tank is 1/8 full or less.

Here are five things that some owners ask about. None of these show a problem with your fuel gage:

- At the service station, the gas pump shuts off before the gage reads full.
- The top bar does not go out until you have driven a long distance—about 30 miles (48 kilometers).

Features & Controls

- It takes a little more or less fuel to fill up than the gage indicated. For example, the gage may have indicated the tank was half full, but it actually took a little more or less than half the tank's capacity to fill the tank.
- The gage moves a little when you turn a corner or speed up.
- The tank is not necessarily empty when the last bar goes out. There is a 1 to 1.5 gallon (4 to 5.6 L) fuel reserve.

For your fuel tank capacity, see *Service Station Information* on the last page of this manual.

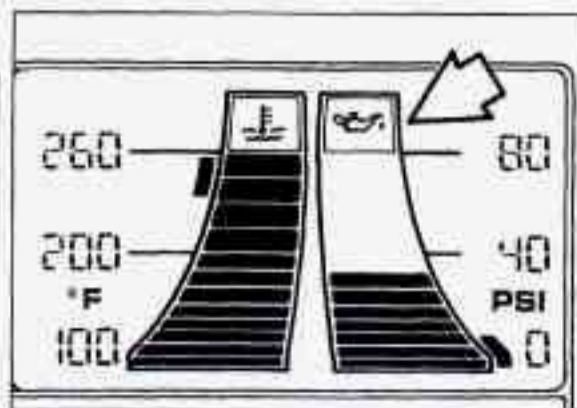

Oil Pressure Gage (ELECTRONIC CLUSTER)

Your oil pressure gage shows the oil pressure in psi (pounds per square inch) when the engine is running. Oil pressure may vary with engine speed, outside temperature and oil viscosity.

If you have a problem with your oil, the box around the oil pressure symbol may begin to flash after you start your engine, or when you are driving. This indicates that oil is not going through your engine quickly enough to keep it cool. The engine could be low on oil, or could have some other oil problem. Have it fixed right away.



CAUTION:

Don't keep driving if the oil pressure is low. If you do, your engine can become so hot that it catches fire. You or others could be burned. Check your oil as soon as possible and have your vehicle serviced.

NOTICE:

Damage to your engine from neglected oil problems can be costly and is not covered by your warranty.

The oil light could also flash on in three other situations:

- When the ignition is on (in the **Run** position) but the engine is not running, the light will come on as a test to show you it is working, but the light will go out when you turn the ignition to **Start**. If it doesn't come on with the ignition on, you may have a problem with the fuse. Have it fixed right away.
- Sometimes when the engine is idling at a stop, the light may flash on and off. This is normal.
- If you make a hard stop, the light may come on for a moment. This is normal.

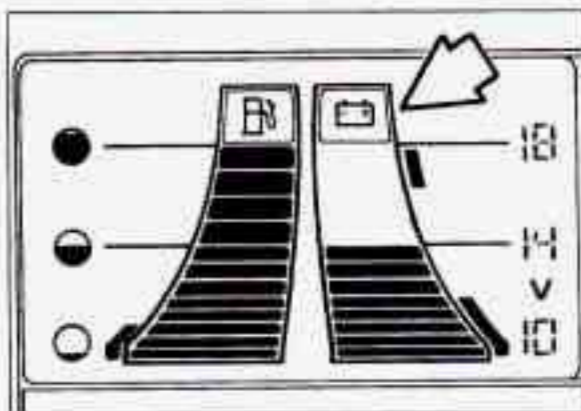

Voltmeter (ELECTRONIC CLUSTER)

Your charging system gage will show the rate of charge when the engine is running. When the engine is not running but the ignition is on (in the **Run** position), the display measures the voltage output of your battery, and will flash until you turn the ignition to **Start**.

The reading will change as the rate of charge changes (with engine speed, etc.), but readings between the warning zones indicate the normal operating range. Readings in either warning zone indicate a possible problem with your charging system. Have your Oldsmobile serviced immediately.

You also have a warning light. A box around the battery symbol will flash when the charging system needs service.

If it comes on while you are driving, you may have a loose belt or other problem with the electrical charging system. Have it checked right away. Driving while this light is on could drain your battery.

If you must drive a short distance with the light on, be certain to turn off all your accessories, such as the radio and air conditioner.

Features & Controls

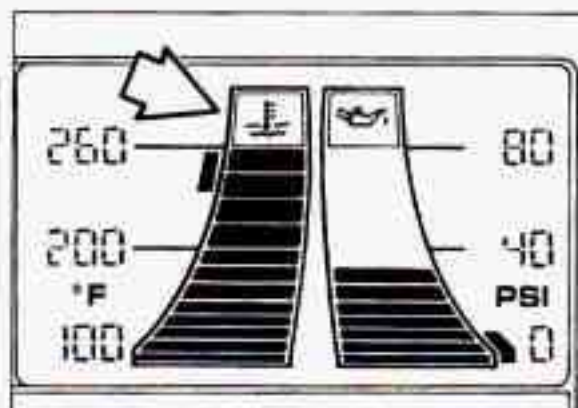

Engine Coolant Temperature Gage (ELECTRONIC CLUSTER)

This gage has bars that show the engine coolant temperature.

A box around the temperature symbol will flash when your engine is too hot. It means that your engine coolant has overheated. If you have been operating your vehicle under normal driving conditions, you should pull off the road, stop your vehicle and turn off the engine as soon as possible.

HOT COOLANT CAN BURN YOU BADLY!

In *Problems on the Road*, this manual shows what to do. See the *Index* under *Engine Overheating*.

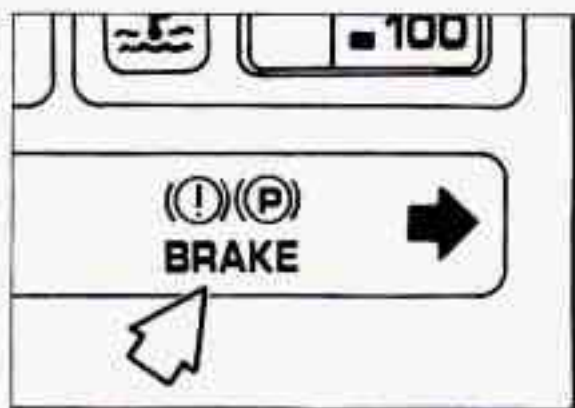

Brake System Warning Light

Your Oldsmobile's hydraulic brake system is divided into two parts. If one part isn't working, the other part can still work and stop you. For good braking, though, you need both parts working well.

If the warning light comes on, there could be a brake problem. Have your brake system inspected right away.

This light should come on as you start the vehicle. If it doesn't come on then, have it fixed so it will be ready to warn you if there's a problem.

If the light comes on while you are driving, pull off the road and stop carefully. You may notice that the pedal is harder to push. Or, the pedal may go

closer to the floor. It may take longer to stop. If the light is still on, have the vehicle towed for service. (See *Towing Your Truck* in the *Index*.)



CAUTION:

Your brake system may not be working properly if the brake system warning light is on. Driving with the brake system warning light on can lead to an accident. If the light is still on after you've pulled off the road and stopped carefully, have the vehicle towed for service.

The brake system warning light will also come on when you set your parking brake, and it will stay on if your parking brake doesn't release fully. If it stays on after your parking brake is fully released, it means you have a brake problem.

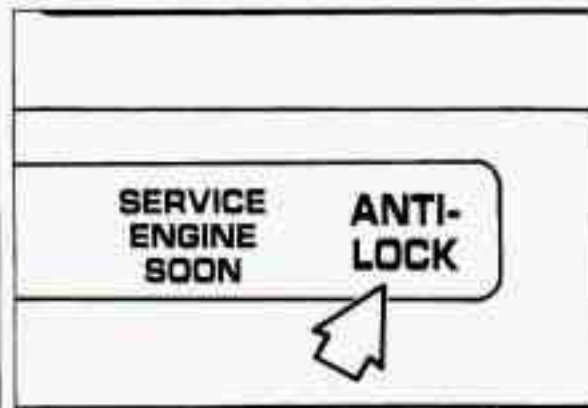

Anti-Lock Brake System Warning Light

With anti-lock, this light will go on when you start your engine and may stay on for several seconds. That's normal. If the light doesn't come on, have it fixed so it will be ready to warn you if there is a problem.

If the light stays on, or comes on when you're driving, your Oldsmobile needs service. If the regular brake system warning light isn't on, you still have brakes, but you don't have anti-lock brakes. If the regular brake system warning light is also on, you don't have anti-lock brakes and there's a problem with your regular brakes. See *Brake System Warning Light* earlier in this part.

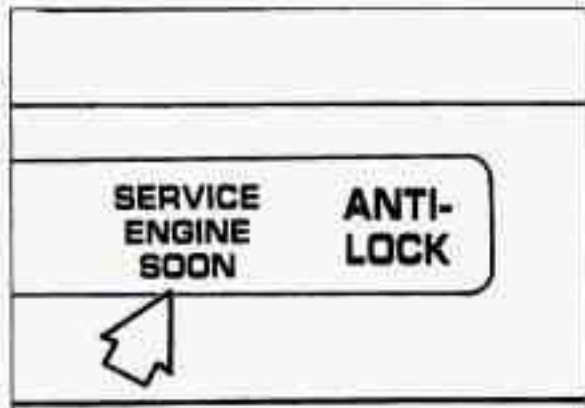

Malfunction Indicator Lamp (Service Engine Soon Light)

A computer monitors operation of your fuel, ignition and emission control systems. This light should come on when the ignition is on, but the engine is not running, as a check to show you it is working. If it does not come on at all, have it fixed right away. If it stays on, or it comes on while you are driving, the computer is indicating that you have a problem. You should take your vehicle in for service soon.

NOTICE:

If you keep driving your vehicle with this light on, after a while the emission controls won't work as well, your fuel economy won't be as good and your engine may not run as smoothly. This could lead to costly repairs not covered by your warranty.

Features & Controls

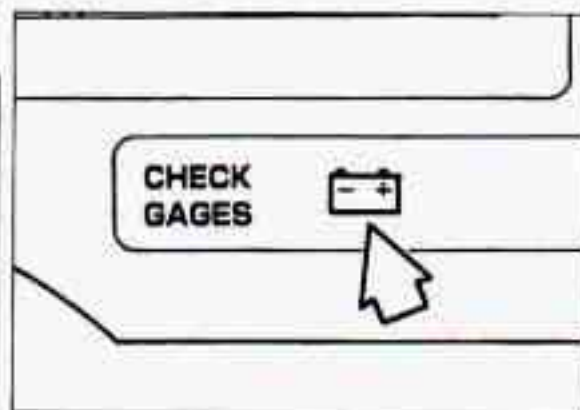

Battery Light (STANDARD CLUSTER)

The battery light will come on briefly when you turn on the ignition as a check to show you it is working. It should go out once the engine is running. If it stays on, or comes on while you are driving, you may have a loose belt or other problem with the electrical charging system. Have it checked right away. Driving while this light is on could drain your battery.

If you must drive a short distance with the light on, be certain to turn off all your accessories, such as the radio and air conditioner.

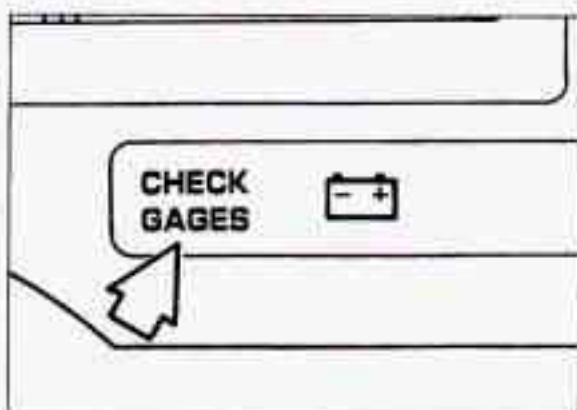

Check Gages Light

(STANDARD CLUSTER)

This light will come on briefly when you are starting the engine. If the light comes on and stays on while you are driving, check your various gages to see if they are in the warning zones.

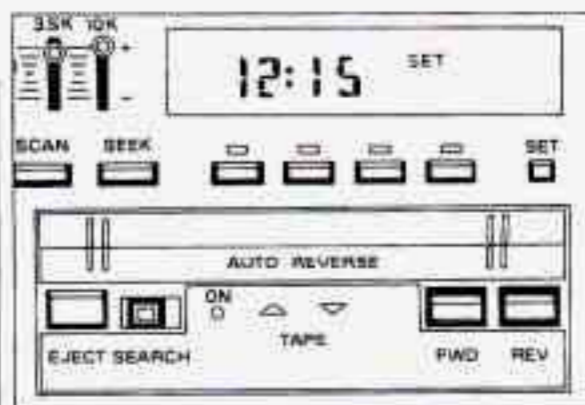

In this part you'll find out how to operate the comfort control systems and audio systems offered with your Oldsmobile. Be sure to read about the particular system supplied with your vehicle.

Part 3

Comfort Controls & Audio Systems

Climate Control System.....	92
Defogging and Defrosting.....	93
Rear Window Defogger.....	94
Setting the Clock.....	95
AM/FM Stereo with Cassette Player and Equalizer.....	96
AM/FM Stereo Radio with Compact Disc Player.....	98
Understanding Radio Reception.....	101
Care of Your Cassette Tape Player.....	102
Care of Your Compact Discs.....	102
Fixed Mast Antenna.....	103

Comfort Controls & Audio Systems

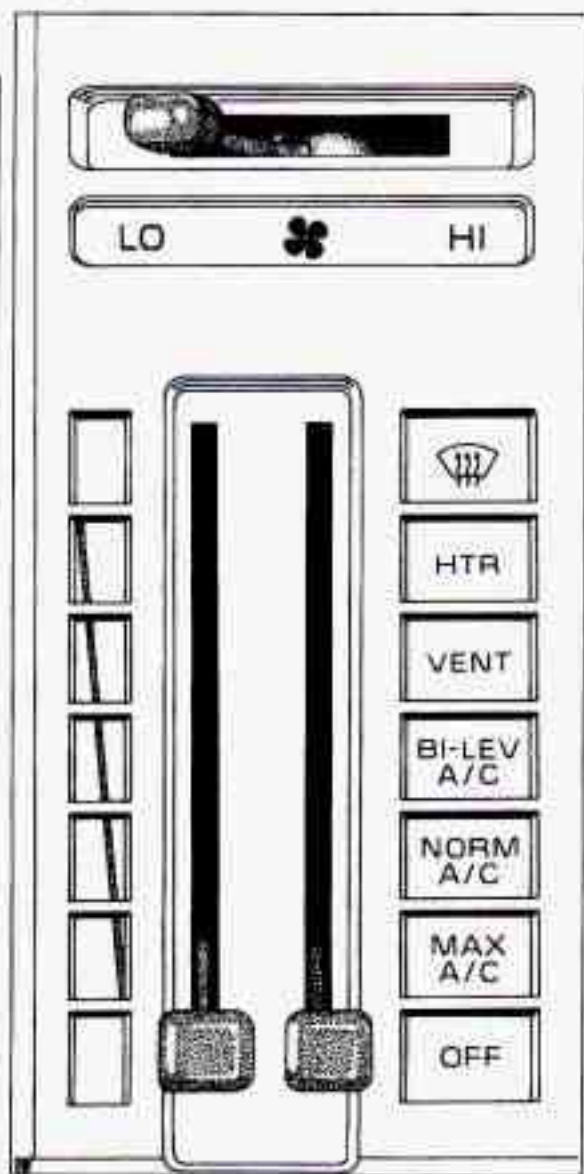

■ Climate Control System

Your vehicle's heater and air conditioner work best if you keep your windows closed. Your vehicle also has flow-through ventilation, described later in this section, to bring outside air into your vehicle.

Fan Lever: The lever at the top has four positions. Move it toward **HI** to increase the air flow. To decrease the air flow, move it toward **LO**.

Temperature Lever: Slide the lever on the left to control the temperature of the air flow into the vehicle. Move the lever up for warmer air, down for cooler air.

Function Lever: Slide the lever on the right to select the function desired. The air conditioner compressor will operate in all settings except **VENT** and **HTR** (Heater) when the outside temperature is above freezing. When the air conditioner compressor cycles on, you may sometimes notice slight changes in your vehicle's engine performance and power. This is normal, because the system is designed to keep the desired cooling level and help fuel economy.

There are three air conditioning settings: **MAX A/C**, **NORM A/C**, and **BI-LEV A/C**. On very hot days, your vehicle will cool down more quickly and economically in any of these settings if you open the windows long enough to let hot inside air escape. For all settings, adjust the temperature control lever and fan speed as desired.

MAX A/C: Select this setting to get maximum cooling or quick cool-down on very hot days. This setting recirculates much of the air inside your vehicle. It should not be used for long periods of time because the air may become too cold and dry.

Also slide the temperature control lever down to the coolest setting and adjust the fan speed as desired.

NORM A/C: Use this setting for normal cooling on hot days. This setting cools outside air and directs it through the instrument panel outlets.

BI-LEV A/C: Use on cool but sunny days. This setting brings in outside air, but directs it two ways—through the instrument panel outlets and the heater

ducts at your feet. At times this temperature difference may be more apparent than others.

VENT: The vent setting brings in outside air through the instrument panel outlets and at your front side windows.

HTR: The heater setting brings in most heated air through the heater ducts, and some through the defroster vents.

If you have the optional engine coolant heater and use it during cold weather, 20°F (-8°C) or lower, your heating system will more quickly provide heat because the engine coolant is already warmed. See the *Index* under *Engine Coolant Heater*.

 **(Defrost):** This setting directs most of the warmed air to the windshield and side windows. Some will also go to the floor vents.

The air conditioner will also run in this setting to remove moisture from the air when the temperature is above 40°F (4°C). Adjust the temperature control as desired.

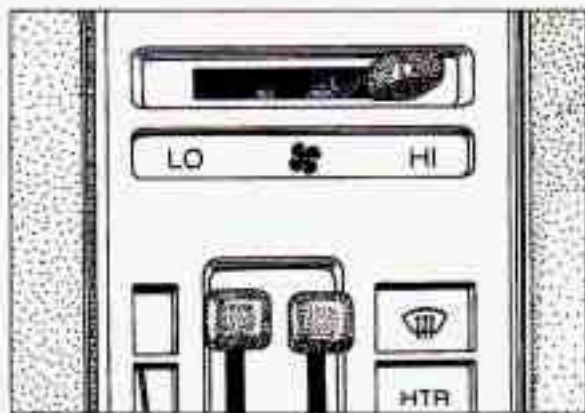

Defogging and Defrosting

To rapidly defrost the windshield, slide the temperature control lever all the way up and select the  setting. Adjust the fan to the highest speed.



To rapidly defog the side windows, select the **BI-LEV A/C** setting and adjust the fan to the highest speed. Aim the side vents toward the side windows. For increased air flow to the side vents, close the center vents.

Comfort Controls & Audio Systems

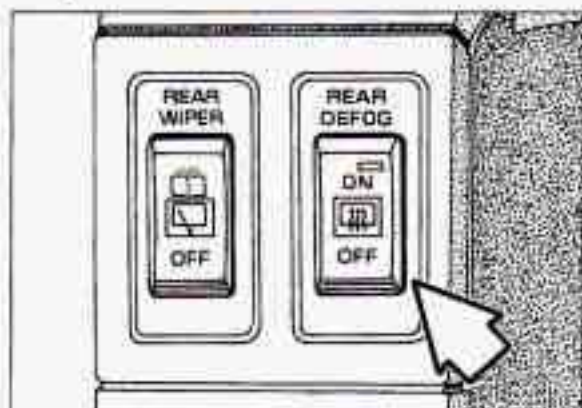

Rear Window Defogger

Press **ON** to warm the defogger grid on the rear window. The indicator light will glow while the rear window defogger is operating. The defogger will turn off automatically after about 10 minutes. If you turn it on again, the defogger will operate for about five minutes only. You can turn the defogger off by turning off the ignition or pressing **OFF**.

Do not attach a temporary vehicle license across the defogger grid on the rear window.

NOTICE:

Don't use a razor blade or something else sharp on the inside of the rear window. If you do, you could cut or damage the warming grid, and the repairs wouldn't be covered by your warranty.

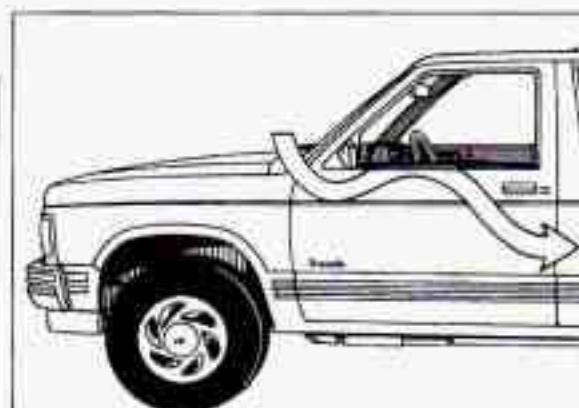

Flow-Through Ventilation System

Your vehicle's flow-through ventilation system supplies outside air into the vehicle when it is moving. Outside air will also enter the vehicle when the heater or the air conditioning fan is running.

Ventilation Tips

- Keep the hood and front air inlet free of ice, snow, or any other obstruction (such as leaves). The heater and defroster will work far better, reducing the chance of fogging the inside of your windows.
- When you enter a vehicle in cold weather, slide the function lever to **HTR** and turn the blower fan to **HI** for a few moments before driving off.

This helps clear the intake ducts of snow and moisture, and reduces the chance of fogging the inside of your windows.

- Keep the air path under the front seats and console clear of objects. This helps air to circulate throughout your vehicle.

■ *Audio Systems*

The following pages describe the audio systems available for your Oldsmobile, and how to get the best performance from them. Please read about the system in your vehicle.

Hearing damage from loud noise is almost undetectable until it is too late. Your hearing can adapt to higher volumes of sound. Sound that seems normal can be loud and harmful to your hearing. Take precautions by adjusting the volume control on your radio to a safe sound level before your hearing adapts to it.

To help avoid hearing loss or damage:

1. Adjust the volume control to the lowest setting.

2. Increase the volume slowly until you hear comfortably and clearly.

NOTICE:

Before you add any sound equipment to your vehicle — like a tape player, CB radio, mobile telephone or two-way radio — be sure you can add what you want. If you can, it's very important to do it properly. Added sound equipment may interfere with the operation of your vehicle's engine, Delco® radio or other systems, and even damage them. And, your vehicle's systems may interfere with the operation of sound equipment that has been added improperly. So, before adding sound equipment, check with your dealer and be sure to check federal rules covering mobile radio and telephone units.

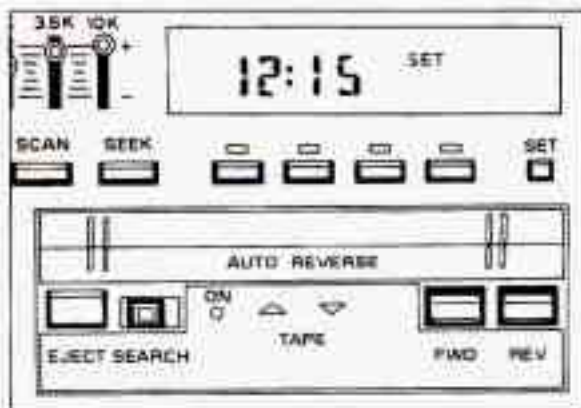

Setting the Clock

Setting the clock is easy.

1. With the radio on or off and the ignition on, press **SET**. The **SET** indicator will appear on the digital screen for five seconds.
2. You must begin to set the clock to the correct hour and minute during those five seconds. Press **SCAN** to set the correct hour. Press **SEEK** to set the correct minute.

Comfort Controls & Audio Systems

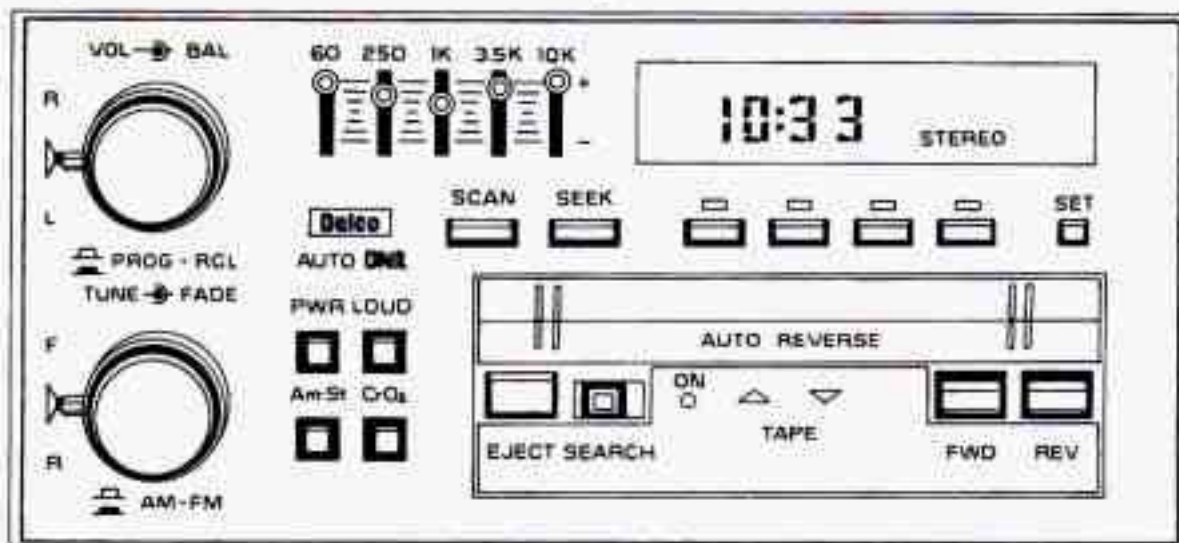

AM/FM Stereo with Cassette Player and Equalizer

The digital display indicates information on the time or radio station frequency, the AM or FM radio band, whether the station is in stereo, and many other radio functions.

PWR (Power): Press to turn the unit on and off when the ignition is on.

VOL-BAL (Volume-Balance): Turn the upper knob to adjust the volume, or press it to change the side of a tape that's playing. Press the knob to display the time when the ignition is off, or to

switch between time and radio station frequency while the radio is on.

The control ring behind the **VOL-BAL** knob adjusts the left/right speaker balance.

TUNE-FADE: This knob has two functions. Turn it to the left or right to tune in radio stations (the radio station frequency will be displayed on the digital screen). Press the knob to change between the AM and FM bands (the digital screen will momentarily display **AM** or **FM**, and if the station is in stereo, **STEREO** will be displayed).

Your radio has an AMAX-certified receiver. It can produce quality AM stereo sound and receive C-Quam® stereo broadcasts. AMAX reduces noise without reducing the high frequencies you need for the best sound. You don't have to do anything to your Delco/GM radio because AMAX is automatic.

The control ring behind the **TUNE-FADE** knob adjusts the front/rear speaker balance.

Equalizer Controls: Boost the bass, emphasize a voice in song, brighten the treble—your equalizer gives you freedom to adjust five separate frequencies of sound to your individual taste. Move a lever up to emphasize a frequency, move it down to de-emphasize. It's best to begin with the levers in the middle position, then adjust individual levers as you like.

LOUD: Press to increase the bass response. This is most helpful in producing a natural sound at low listening levels.

AUTO DNR (Dynamic Noise Reduction): This sound system automatically reduces background noises on AM, FM and cassette tapes.

AmSt: When you're tuned to an AM station that broadcasts in stereo, the **STEREO** light will come on. If the signal is weak, press **AmSt** to turn the feature off. You'll get better reception. Press **AmSt** again to turn the feature back on for strong signals.

SEEK: Each time you press **SEEK**, you will tune in the next station on the AM or FM radio band.

SCAN: Press to listen for a few seconds to the next station on the AM or FM band; the scan will continue every few seconds until you either press **SCAN** again or press the **VOL-BAL** knob to stop on a particular station.

To Preset Radio Stations:

The four pushbuttons can be used to preset up to 14 radio stations (seven AM and seven FM stations).

1. Turn the lower control knob (**TUNE**) to the station you want.
2. Press **SET**. The **SET** indicator will appear on the digital screen for five seconds.

3. While the **SET** indicator is displayed, press one of the four pushbuttons. The station is now preset. You can tune to it immediately by pressing the same button.
4. Repeat steps 1-3 for each of four AM and four FM stations.

Up to three additional stations on each band may be preset by "pairing" pushbuttons:

1. Tune in the desired station.
2. Press **SET**, and within five seconds press any two adjacent pushbuttons at the same time.
3. The station can be tuned in when the same two pushbuttons are pressed at the same time.

To Play a Cassette Tape:

Press **PWR (Power)** to turn the radio on. Then push a cassette into the cassette entry door (the tape side goes in first). Using tapes that are longer than 90 minutes (45 minutes on each side) is not recommended.

FWD (Fast Forward): Press to advance the tape rapidly; press again to play.

REV (Reverse): Press to reverse the tape rapidly; press again to play tape.

SEARCH: Push this switch to the right and the **FWD** and **REV** buttons will function as a "music search," stopping the tape at the next selection on the tape. (There must be at least a 3-second gap between selections on the tape.) The **ON** light will indicate the music search is selected.

Program: Press the **VOL-BAL** knob to change the side of tape being played. When the arrow pointing up is lighted, the selections listed on the top side of the tape are played. When the arrow pointing down is lighted, selections listed on the bottom side of the tape are played. The tape player automatically begins playing the other side when it reaches the end of the tape.

CrO₂: This button sets tape bias. When playing high bias chrome or metal tapes, press the button to turn the button light on. When playing standard tapes, press again to turn the light off.

EJECT: Press to have the cassette tape ejected (the radio will then play). The cassette tape will be ejected automatically when the radio is turned off.

Comfort Controls & Audio Systems

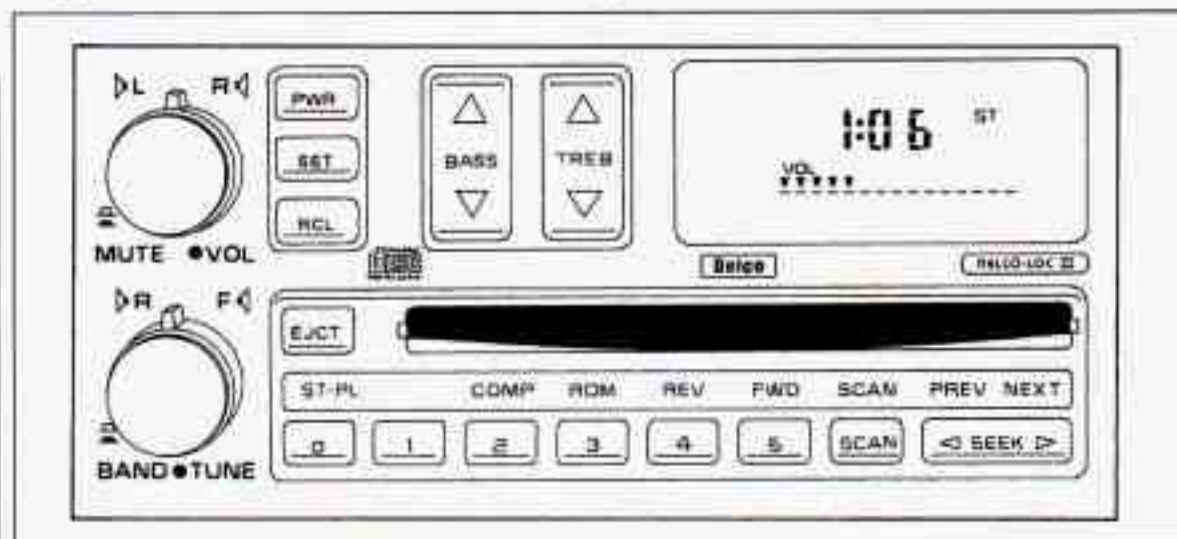

AM/FM Stereo Radio with Compact Disc Player

The digital display indicates information on the time or radio station frequency, the AM or FM radio band, whether the station is in stereo, and many other radio functions.

PWR (Power): Press to turn the unit on when the ignition is on. Press again to turn the unit off.

MUTE-VOL (Upper Knob): This control has three functions.

- Turn the knob to adjust volume up or down.

- Press the knob to silence the radio temporarily. Press again to restore original volume.
- Turn the ring behind the knob to adjust left/right speaker balance to your taste.

BAND-TUNE (Lower Knob): This control has three functions.

- Turn the knob to tune the radio.
- Press the knob to switch from the AM band to the FM band. Press again to switch from FM to AM.
- Turn the ring behind the knob to adjust the front-rear speaker balance (also called "fade") to your taste.

RCL (Recall): Press to switch the display from the time to radio station frequency. Press again to switch from the radio frequency to time.

BASS: Press the upper part to increase bass. Press the lower part to decrease bass.

TREB (Treble): Press the upper part to increase treble. Press the lower part to decrease treble.

SEEK: Press the left side to tune in the next station lower in frequency. Press the right side to tune in the next station higher in frequency.

SCAN: Press to listen for a few seconds to the next station on the AM or FM band; the scan will continue every few seconds until you press **SCAN** again at any time to stop on a particular station.

To Preset Radio Stations:

The five numbered pushbuttons are used to immediately select any of ten preset radio stations, five AM and five FM. Four of the pushbuttons are also used when you play a compact disc.

1. Tune the display to a station you want to preset.

2. Press **SET**. The **SET** indicator will appear on the digital screen for five seconds.
3. Press one of the numbered pushbuttons while the **SET** indicator is displayed. The station is now preset. You can tune to it immediately by pressing the same numbered pushbutton.
4. Repeat these steps for up to five AM and five FM stations.

To Play a Compact Disc:

Your compact disc player is designed for full-size compact discs only. Do not use the mini-discs that are called singles. They won't eject.

1. Press **PWR** to turn the unit on.
2. Insert a disc partway into the slot, label side up. The player will pull it in. In a few seconds, the disc should play.

If the disc comes back out without playing:

- The disc may be upside down.
- The disc may be dirty, scratched or wet.
- The road may be too rough.

- There may be too much moisture in the air. Wait about one hour and try again.
- The player may be too hot. If so, **HOT** will appear on the display. When the compact disc player cools, it should play again. Press **RCL** to remove **HOT** from the display.

In addition to the normal tone and volume controls, you can use the following controls while the compact disc player is playing:

RCL (Recall): Press to see which track is playing. Its number will be displayed. Press again to see how long it has been playing.

The track number will also be displayed whenever you change the volume or a new track begins to play.

EJCT (Eject): Press to eject the disc. The radio will play.

ST-PL (Stop-Play): Press to stop the compact disc player and play the radio. Press again to stop the radio and play the compact disc. It will begin playing at the point where you stopped it.

COMP (Compression): Press to make soft and loud passages more equal in volume. Press again to resume normal play.

RDM (Random): Press to play a disc's tracks in random order. Press again to play them in numbered sequence.

REV (Reverse): Press and hold to rapidly back up within a track. Release to play from that point.

FWD (Fast Forward): Press and hold to rapidly move forward within a track. Release to play from that point.

SCAN: Press to sample all tracks briefly, one at a time. Press again to continue the track that's playing.

PREV (Previous): Press to back up to the previous track. Pressing more than once backs up more than one track. Press and hold to scroll backward through the tracks.

NEXT: Press to move up to the next track. Pressing more than once moves up more than one track. Press and hold to scroll forward through the tracks.

Comfort Controls & Audio Systems

CD Player Security System

Delco LOC II® is a security feature for the compact disc player. You can turn it on or not, as you prefer. If you turn it on, your player won't work if it's ever stolen. When you turn on Delco LOC II,® you enter a secret code into the system to secure it. If your CD player loses battery power for any reason you must unlock the system with the secret code before the system will work again.

If you turn Delco LOC II® on and decide you don't want it on any longer, you can turn it off.

To Turn Delco LOC II® On:

1. Write down any 6-digit number and keep it in a safe place. This is your secret code.
2. Turn the ignition to the **Accessory** or **Run** position.
3. Make sure the radio is off.
4. Press and hold the **1** and **4** pushbuttons until --- shows on the display. You now have 15 seconds for each of the following steps. If you

take more than 15 seconds to complete any of them, you may need to start over.

5. Press **SET**. **000** will appear.
6. Press **SEEK** to the right and hold it until the second and third numbers of your secret code appear.
7. Press **SCAN** until the first number of your secret code appears.
8. Press **BAND-TUNE** and **000** will appear again.
9. Press **SEEK** to the right and hold it until the fifth and sixth numbers of your secret code appear.
10. Press **SCAN** until the fourth number of your secret code appears.
11. Press **BAND-TUNE**. **rEP** will appear for five seconds. Then **000** will appear.
12. Repeat steps 6-11. **SEC** will appear, indicating that the system is secure. If the display shows ---, the verification process was not successful. Repeat the entire sequence.

To Turn Delco LOC II® Off:

1. Turn the ignition to the **Accessory** or **Run** position.
2. Make sure the radio is off.
3. Press and hold the **1** and **4** pushbuttons until **SEC** shows on the display.
4. Press **SET**. The display will show **000**.
5. Press **SEEK** to the right and hold it until the second and third numbers of your secret code appear.
6. Press **SCAN** until the first number of your secret code appears.
7. Press **BAND-TUNE**. The display will show **000**.
8. Press **SEEK** to the right and hold it until the fifth and sixth numbers of your secret code appear.
9. Press **SCAN** until the fourth number of your secret code appears.
10. Press **BAND-TUNE**. If the display shows ---, the unit is no longer secured. If the display shows **SEC**, it is still secured (the numbers did not match either your secret code or the factory's back-up code).

To Unlock After a Power Loss:

When battery power is lost and then resupplied to a secured unit, **LOC** will appear on the display. Follow these steps to unlock the unit:

1. Turn the ignition to the **Accessory** or **Run** position.
2. Make sure the radio is off.
3. Press **SET**. The display will show **000**.
4. Press **SEEK** to the right and hold it until the second and third numbers of your secret code appear.
5. Press **SCAN** until the first number of your secret code appears.
6. Press **BAND-TUNE**. The display will show **000**.
7. Press **SEEK** to the right and hold it until the fifth and sixth numbers of your secret code appear.
8. Press **SCAN** until the fourth number of your secret code appears.

9. Press **BAND-TUNE**. If the display shows the time of day, the unit is no longer locked. If the display shows **LOC**, it is still secured (the numbers did not match either your secret code or the factory's back-up code).

Understanding Radio Reception

FM Stereo

FM Stereo will give you the best sound, but FM signals will reach only about 10 to 40 miles (16 to 65 km). Tall buildings or hills can interfere with FM signals, causing the sound to come and go.

AM

The range for most AM stations is greater than for FM, especially at night. The longer range, however, can cause stations to interfere with each other. AM can also pick up noise from things like storms and power lines. To lower this noise, try reducing the treble level.

AM Stereo

Your Delco® system may be able to receive C-Quam® stereo broadcasts. Many AM stations around the country use C-Quam® to produce stereo, though some do not. C-Quam® is a registered trademark of Motorola, Inc. If your Delco® system can get C-Quam® signals, your stereo indicator light will come on when you are receiving it.

Comfort Controls & Audio Systems



Care of Your Cassette Tape Player

A tape player that is not cleaned regularly is subject to reduced sound quality, ruining the cassette, or damaging the mechanism. Tape cassettes that are not properly stored in their plastic cases away from contaminants, direct sunlight, and extreme heat may not operate properly and could cause premature failure of the tape player.

Your tape player should be cleaned monthly or with every 15 hours of use, as regular maintenance. If you notice a reduction in sound quality, try a good cassette to see if the tape or the tape

player is at fault. If the second cassette results in no improvement in sound quality, try cleaning the tape player.

Proper tape player cleaning should be done with a **wiping action** nonabrasive cleaner cassette. To properly clean your tape player, you should follow the directions on the cleaning cassette.

Cassettes are subject to wear and the sound quality may degrade over time. Always verify that the cassette tape is in good condition before obtaining service on your tape player.



Care of Your Compact Discs

Handle discs carefully. Store them in their original cases or other protective cases and away from direct sunlight and dust. If the surface of a disc is soiled, dampen a clean, soft cloth in a mild, neutral detergent solution and clean it, wiping from the center to the edge.

Be sure never to touch the signal surface when handling discs. Pick up discs by grasping the outer edges or the edge of the hole and the outer edge.

Fixed Mast Antenna

The fixed mast antenna can withstand most car washes without being damaged. If the mast should ever become slightly bent, you can straighten it out by hand. If the mast is badly bent, as it might be by vandals, you should replace it.

Check every once in a while to be sure the mast is still tightened to the fender.

Notes



Here you'll find information about driving on different kinds of roads and in varying weather conditions. We've also included many other useful tips on driving.

Part 4

Your Driving and the Road

Defensive Driving.....	106
Drunken Driving.....	106
Control of a Vehicle	
What Is All-Wheel Drive?	108
Braking.....	109
Anti-Lock Brakes (ABS).....	110
Braking in Emergencies.....	111
Steering.....	111
Steering in Emergencies.....	112
Passing.....	113
Driving Guidelines.....	115
Operating Your Bravada Off Paved Roads.....	115
Driving at Night.....	124
Driving in the Rain.....	125
City Driving.....	126
Freeway Driving.....	127
Hill and Mountain Roads.....	129
Winter Driving.....	130
Towing a Trailer.....	132

Your Driving and the Road

■ *Defensive Driving*

The best advice anyone can give about driving is: Drive defensively.

Please start with a very important safety device in your Oldsmobile: Buckle up. (See *Safety Belts* in the *Index*.)

Defensive driving really means "be ready for anything." On city streets, rural roads, or freeways, it means "always expect the unexpected."

Assume that pedestrians or other drivers are going to be careless and make mistakes. Anticipate what they might do. Be ready for their mistakes.

Rear-end collisions are about the most preventable of accidents. Yet they are common. Allow enough following distance. It's the best defensive driving maneuver, in both city and rural driving. You never know when the vehicle in front of you is going to brake or turn suddenly.

■ *Drunken Driving*

Death and injury associated with drinking and driving is a national tragedy. It's the number one contributor to the highway death toll, claiming thousands of victims every year. Alcohol takes away three things that anyone needs to drive a vehicle:

- Judgment
- Muscular Coordination
- Vision

Police records show that almost half of all motor vehicle-related deaths involve alcohol — a driver, a passenger or someone else, such as a pedestrian, had been drinking. In most cases, these deaths are the result of someone who was drinking and driving. About 20,000 motor vehicle-related deaths occur each year because of alcohol, and thousands of people are injured.

Just how much alcohol is too much if a person plans to drive? Ideally, no one should drink alcohol and then drive. But if one does, then what's "too much"? It can be a lot less than many might think. Although it depends on each person and situation, here is some general information on the problem.

The Blood Alcohol Content (BAC) of someone who is drinking depends upon four things:

- How much alcohol is in the drink.
- The drinker's body weight.
- The amount of food that is consumed before and during drinking.
- The length of time it has taken the drinker to consume the alcohol.



According to the American Medical Association, a 180-pound (82 kg) person who drinks three 12-ounce (355 ml) bottles of beer in an hour will end up with a BAC of about 0.06 percent. The person would reach the same BAC by drinking three 4-ounce (120 ml) glasses of wine or three mixed drinks if each had 1-1/2 ounces (45 ml) of a liquor like whiskey, gin or vodka.

It's the amount of alcohol that counts. For example, if the same person drank three double martinis (3 ounces or 90 ml of liquor each) within an hour, the person's BAC would be close to 0.12 percent. A person who consumes food just before or during drinking will have a slightly lower BAC level.

Drinking That Will Result in a BAC of .05% in the Time Shown

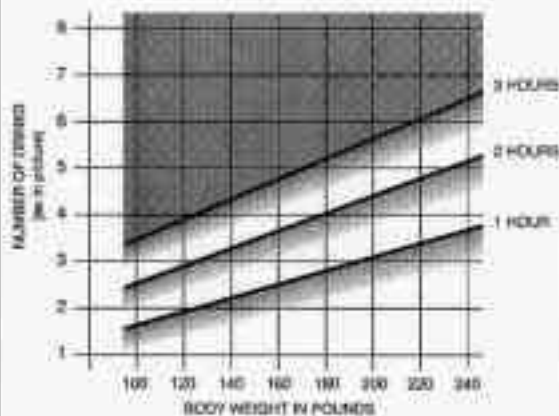

The law in most U.S. states sets the legal limit at a BAC of 0.10 percent. In Canada the limit is 0.08 percent, and in some other countries it's lower than that. The BAC will be over 0.10 percent after three to six drinks (in one hour). Of course, as we've seen, it depends on how much alcohol is in the drinks, and how quickly the person drinks them.

But it's very important to keep in mind that the ability to drive is affected well below a BAC of 0.10 percent. Research shows that the driving skills of many people are impaired at a BAC approaching 0.05 percent, and that the effects are worse at night. All drivers are impaired at BAC levels above 0.05 percent. Statistics show that the chance of being in an accident increases sharply for drivers who have a BAC of 0.05 percent or above. A driver with a BAC level of 0.06 percent (three beers in one hour for a 180-pound or 82 kg person) has doubled his or her chance of having an accident. At a BAC level of 0.10 percent, the chance of that driver having an accident is six times greater; at a level of 0.15 percent, the chances are twenty-five times greater! And, the body takes about an hour to rid itself of the alcohol in one drink. No amount of coffee or number of cold showers will speed that up.

Your Driving and the Road

"I'll be careful" isn't the right answer. What if there's an emergency, a need to take sudden action, as when a child darts into the street? A person with a higher BAC might not be able to react quickly enough to avoid the collision. There's something else about drinking and driving that many people don't know. Medical research shows that alcohol in a person's system can make crash injuries worse. That's especially true for brain, spinal cord and heart injuries. That means that if anyone who has been drinking — driver or passenger — is in a crash, the chance of being killed or permanently disabled is higher than if that person had not been drinking. And we've already seen that the chance of a crash itself is higher for drinking drivers.



CAUTION:

Drinking and then driving is very dangerous. Your reflexes, perceptions, and judgment will be affected by even a small amount of alcohol. You could have a serious — or even fatal — accident if you drive after drinking. Please don't drink and drive or ride with a driver who has been drinking. Ride home in a cab; or if you're with a group, designate a driver who will not drink.



■ *Control of a Vehicle*

You have three systems that make your vehicle go where you want it to go. They are the brakes, the steering and the accelerator. All three systems have to do their work at the places where the tires meet the road.

Sometimes, as when you're driving on snow or ice, it's easy to ask more of those control systems than the tires and road can provide. That means you can lose control of your vehicle.

■ *What Is All-Wheel Drive?*

All the Wheels, All the Time

Bravada has a unique system called all-wheel drive (AWD). Simply stated, AWD supplies power from the engine to all four wheels, all the time. It works in

all conditions—both on and off paved surfaces, no matter if the weather is fair or foul.

The heart of the AWD system is the transfer case. Here, engine power is divided by an interaxle differential. Under normal conditions, it sends 65 percent of the torque to the rear axle and the other 35 percent to the front axle.

But on a slippery surface, a viscous clutch in the transfer case adjusts the 65/35 proportion according to need, sending more power to the axle with traction.

Another feature of the AWD system that helps Bravada keep its grip is the limited-slip rear axle. In conditions where one rear wheel loses traction but the other still has some—as when one wheel hits an icy patch or slips onto a muddy road shoulder—this design provides power to the wheel with traction. And AWD is simple. It's always there—working.

■ *Braking*

Braking action involves **perception time** and **reaction time**.

First, you have to decide to push on the brake pedal. That's **perception time**. Then you have to bring up your foot and do it. That's **reaction time**.

Average **reaction time** is about 3/4 of a second. But that's only an average. It might be less with one driver and as long as two or three seconds or more with another. Age, physical condition, alertness, coordination, and eyesight all play a part. So do alcohol, drugs and frustration. But even in 3/4 of a second, a vehicle moving at 60 mph (100 km/h) travels 66 feet (20 m). That could be a lot of distance in an emergency, so keeping enough space between your vehicle and others is important.

And, of course, actual stopping distances vary greatly with the surface of the road (whether it's pavement or gravel); the condition of the road (wet, dry, icy); tire tread; and the condition of your brakes.

Avoid needless heavy braking. Some people drive in spurts — heavy acceleration followed by heavy braking — rather than keeping pace with traffic. This is a mistake. Your brakes may not have time to cool between hard stops. Your brakes will wear out much faster if you do a lot of heavy braking. If you keep pace with the traffic and allow realistic following distances, you will eliminate a lot of unnecessary braking. That means better braking and longer brake life.

If your engine ever stops while you're driving, brake normally but don't pump your brakes. If you do, the pedal may get harder to push down. If your engine stops, you will still have some power brake assist. But you will use it when you brake. Once the power assist is used up, it may take longer to stop and the brake pedal will be harder to push.

Your Driving and the Road

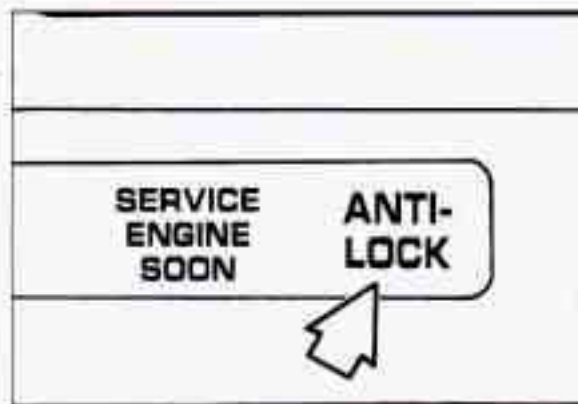

Anti-Lock Brakes (ABS)

Your vehicle has an advanced electronic braking system that can help you keep it under control. When you start your vehicle and begin to drive away, you may hear a momentary motor or clicking noise. This is the ABS system testing itself.



Here's how anti-lock works. Let's say the road is wet. You're driving safely. Suddenly an animal jumps out in front of you.

You slam on the brakes. Here's what happens with ABS.

A computer senses that the wheels are slowing down. If one of the wheels is about to stop rolling, the computer will separately work the brakes at each front wheel and at the rear wheels. The anti-lock system can change the brake pressure faster than any driver could. The computer is programmed to make the most of available tire and road conditions. You can steer around the obstacle while braking hard.



As you brake, your computer keeps receiving updates on wheel speed and controls braking pressure accordingly.

Remember: Anti-lock doesn't change the time you need to get your foot up to the brake pedal. If you get too close to the vehicle in front of you, you won't have time to apply your brakes if that vehicle suddenly slows or stops. Always leave enough room up ahead to stop, even though you have anti-lock brakes.

To Use Four-Wheel Anti-Lock

Don't pump the brakes. Just hold the brake pedal down and let anti-lock work for you. You may feel the brakes vibrate, or you may notice some noise, but this is normal.

Braking in Emergencies

Use your anti-lock braking system when you need to. With anti-lock, you can steer and brake at the same time. In many emergencies, steering can help you more than even the very best braking.

■ *Steering*

Power Steering

If you lose power steering assist because the engine stops or the system is not functioning, you can steer but it will take much more effort.

Steering Tips

Driving on Curves

It's important to take curves at a reasonable speed.

A lot of the "driver lost control" accidents mentioned on the news happen on curves. Here's why:

Experienced driver or beginner, each of us is subject to the same laws of physics when driving on curves. The traction of the tires against the road surface makes it possible for the vehicle to change its path when you turn the front wheels. If there's no traction, inertia will keep the

vehicle going in the same direction. If you've ever tried to steer a vehicle on wet ice, you'll understand this.

The traction you can get in a curve depends on the condition of your tires and the road surface, the angle at which the curve is banked, and your speed. While you're in a curve, speed is the one factor you can control.

Suppose you're steering through a sharp curve. Then you suddenly accelerate. Both control systems — steering and acceleration — have to do their work where the tires meet the road. Adding the sudden acceleration can demand too much of those places. You can lose control.

Suppose you're steering through a sharp curve. Then you suddenly accelerate. Both control systems — steering and acceleration — have to do their work where the tires meet the road. Unless you have traction control and the system is on, adding the sudden acceleration can demand too much of those places. You can lose control.

What should you do if this ever happens? Ease up on the accelerator pedal, steer the vehicle the way you want it to go, and slow down.

Speed limit signs near curves warn that you should adjust your speed. Of course, the posted speeds are based on good weather and road conditions. Under less favorable conditions you'll want to go slower.

If you need to reduce your speed as you approach a curve, do it before you enter the curve, while your front wheels are straight ahead.

Try to adjust your speed so you can "drive" through the curve. Maintain a reasonable, steady speed. Wait to accelerate until you are out of the curve, and then accelerate gently into the straightaway.

Your Driving and the Road



Steering in Emergencies

There are times when steering can be more effective than braking. For example, you come over a hill and find a truck stopped in your lane, or a car suddenly pulls out from nowhere, or a child darts out from between parked cars and stops right in front of you. You can avoid these problems by braking — if you can stop in time. But sometimes you can't; there isn't room. That's the time for evasive action — steering around the problem.

Your Oldsmobile can perform very well in emergencies like these. First apply your brakes. It is better to remove as much speed as you can from a possible

collision. Then steer around the problem, to the left or right depending on the space available.

An emergency like this requires close attention and a quick decision. If you are holding the steering wheel at the recommended 9 and 3 o'clock positions, you can turn it a full 180 degrees very quickly without removing either hand. But you have to act fast, steer quickly, and just as quickly straighten the wheel once you have avoided the object.

The fact that such emergency situations are always possible is a good reason to practice defensive driving at all times and wear safety belts properly.

OFF ROAD RECOVERY

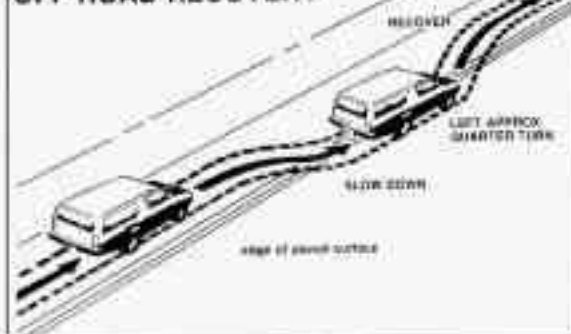

■ Off-Road Recovery

You may find sometime that your right wheels have dropped off the edge of a road onto the shoulder while you're driving.

If the level of the shoulder is only slightly below the pavement, recovery should be fairly easy. Ease off the accelerator and then, if there is nothing in the way, steer so that your vehicle straddles the edge of the pavement. You can turn the steering wheel up to 1/4 turn until the right front tire contacts the pavement edge. Then turn your steering wheel to go straight down the roadway.

■ *Passing*

The driver of a vehicle about to pass another on a two-lane highway waits for just the right moment, accelerates, moves around the vehicle ahead, then goes back into the right lane again. A simple maneuver?

Not necessarily! Passing another vehicle on a two-lane highway is a potentially dangerous move, since the passing vehicle occupies the same lane as oncoming traffic for several seconds. A miscalculation, an error in judgment, or a brief surrender to frustration or anger can suddenly put the passing driver face to face with the worst of all traffic accidents — the head-on collision.

So here are some tips for passing:

- “Drive ahead.” Look down the road, to the sides, and to crossroads for situations that might affect your passing patterns. If you have any doubt whatsoever about making a successful pass, wait for a better time.
- Watch for traffic signs, pavement markings, and lines. If you can see a sign up ahead that might indicate a turn or an intersection, delay your

pass. A broken center line usually indicates it's all right to pass (providing the road ahead is clear). Never cross a solid line on your side of the lane or a double solid line, even if the road seems empty of approaching traffic.

- Do not get too close to the vehicle you want to pass while you're awaiting an opportunity. For one thing, following too closely reduces your area of vision, especially if you're following a larger vehicle. Also, you won't have adequate space if the vehicle ahead suddenly slows or stops. Keep back a reasonable distance.
- When it looks like a chance to pass is coming up, start to accelerate but stay in the right lane and don't get too close. Time your move so you will be increasing speed as the time comes to move into the other lane. If the way is clear to pass, you will have a “running start” that more than makes up for the distance you would lose by dropping back. And if something happens to cause you to cancel your pass, you need only slow down and drop back again and wait for another opportunity.
- If other cars are lined up to pass a slow vehicle, wait your turn. But take care that someone isn't trying to pass you as you pull out to pass the slow vehicle. Remember to glance over your shoulder and check the blind spot.
- Check your mirrors, glance over your shoulder, and start your left lane change signal before moving out of the right lane to pass. When you are far enough ahead of the passed vehicle to see its front in your inside mirror, activate your right lane change signal and move back into the right lane. (Remember that your right outside mirror is convex. The vehicle you just passed may seem to be farther away from you than it really is.)
- Try not to pass more than one vehicle at a time on two-lane roads. Reconsider before passing the next vehicle.
- Don't overtake a slowly moving vehicle too rapidly. Even though the brake lights are not flashing, it may be slowing down or starting to turn.
- If you're being passed, make it easy for the following driver to get ahead of you. Perhaps you can ease a little to the right.

Your Driving and the Road

■ *Loss of Control*

Let's review what driving experts say about what happens when the three control systems (brakes, steering and acceleration) don't have enough friction where the tires meet the road to do what the driver has asked.

In any emergency, don't give up. Keep trying to steer and constantly seek an escape route or area of less danger.

Skidding

In a skid, a driver can lose control of the vehicle. Defensive drivers avoid most skids by taking reasonable care suited to existing conditions, and by not "overdriving" those conditions. But skids are always possible.

The three types of skids correspond to your Oldsmobile's three control systems. In the braking skid your wheels aren't rolling. In the steering or cornering skid, too much speed or steering in a curve causes tires to slip and lose cornering force. And in the acceleration skid too much throttle causes the driving wheels to spin.

A cornering skid and an acceleration skid are best handled by easing your foot off the accelerator pedal.

If your vehicle starts to slide, ease your foot off the accelerator pedal and quickly steer the way you want the vehicle to go. If you start steering quickly enough, your vehicle may straighten out. Always be ready for a second skid if it occurs.

Of course, traction is reduced when water, snow, ice, gravel, or other material is on the road. For safety, you'll want to slow down and adjust your driving to these conditions. It is important to slow down on slippery surfaces because stopping distance will be longer and vehicle control more limited.

While driving on a surface with reduced traction, try your best to avoid sudden steering, acceleration, or braking (including engine braking by shifting to a lower gear). Any sudden changes could cause the tires to slide. You may not realize the surface is slippery until your vehicle is skidding. Learn to recognize warning clues — such as enough water, ice or packed snow on the road to make a "mirrored surface" — and slow down when you have any doubt.

Remember: Any anti-lock braking system (ABS) helps avoid only the braking skid.

■ *Driving Guidelines*

This multipurpose passenger vehicle is defined as a utility vehicle in Consumer Information Regulations issued by the National Highway Traffic Safety Administration (NHTSA) of the United States Department of Transportation. Utility vehicles have higher ground clearance and a narrower track to make them capable of performing in a wide variety of off-road applications. Specific design characteristics give them a higher center of gravity than ordinary cars. An advantage of the higher ground clearance is a better view of the road allowing you to anticipate problems. They are not designed for cornering at the same speeds as conventional 2-wheel drive vehicles any more than low-slung sports cars are designed to perform satisfactorily under off-road conditions. If at all possible, avoid sharp turns or abrupt maneuvers. As with other vehicles of this type, failure to operate this vehicle correctly may result in loss of control or vehicle rollover.



Operating Your Bravada Off Paved Roads

Many of the same design features that help make Bravada responsive on paved roads during poor weather conditions — features like the locking rear axle and all-wheel drive — help make it much better suited for off-road use than a conventional passenger car. Its higher ground clearance also helps Bravada step over some off-road obstacles. But Bravada doesn't have features like special underbody shielding and a transfer case low gear range, things that are usually thought necessary for extended or severe off-road service. This guide is for operating your Bravada off paved roads. Also, see *Anti-Lock Brakes* in the *Index*.

Off-road driving can be great fun. But it does have some definite hazards. The greatest of these is the terrain itself.

“Off-roading” means you’ve left the great North American road system behind. Traffic lanes aren’t marked. Curves aren’t banked. There are no road signs. Surfaces can be slippery, rough, uphill or downhill. In short, you’ve gone right back to nature.

Off-road driving involves some new skills. And that’s why it’s very important that you read this guide. You’ll find many driving tips and suggestions. These will help make your off-road driving safer and more enjoyable.

Before You Go Off-Roading

There are some things to do before you go out. For example, be sure to have all necessary maintenance and service work done. Be sure you read all the information about your all-wheel drive vehicle in this manual. Is there enough fuel? Is the spare tire fully inflated? Are the fluid levels up where they should be? What are the local laws that apply to off-roading where you’ll be driving?

Your Driving and the Road

If you don't know, you should check with law enforcement people in the area. Will you be on someone's private land? If so, be sure to get the necessary permission.

Loading Your Vehicle for Off-Road Driving

There are some important things to remember about how to load your vehicle.

- The heaviest things should be on the load floor and forward of your rear axle. Put heavier items as far forward as you can.
- Be sure the load is secured properly, so driving on the off-road terrain doesn't toss things around.



CAUTION:

- Cargo on the load floor piled higher than the seatbacks can be thrown forward during a sudden stop. You or your passengers could be injured. Keep cargo below the top of the seatbacks.
- Unsecured cargo on the load floor can be tossed about when driving over rough terrain. You or your passengers can be struck by flying objects. Secure the cargo properly.
- Heavy loads on the roof raise the vehicle's center of gravity, making it more likely to roll over. You can be seriously or fatally injured if the vehicle rolls over. Put heavy loads inside the cargo area, not on the roof. Keep cargo in the cargo area as far forward and low as possible.

You'll find other important information in this manual. See *Vehicle Loading*, *Luggage Carrier* and *Tires* in the *Index*.

Traveling to Remote Areas

It makes sense to plan your trip, especially when going to a remote area. Know the terrain and plan your route. You are much less likely to get bad surprises. Get accurate maps of trails and terrain. Try to learn of any blocked or closed roads.

It's also a good idea to travel with at least one other vehicle. If something happens to one of them, the other can help quickly.

Getting Familiar with Off-Road Driving

It's a good idea to practice in an area that's safe and close to home before you go into the wilderness. Off-road driving does require some new and different driving skills. Here's what we mean.

Tune your senses to different kinds of signals. Your eyes, for example, need to constantly sweep the terrain for unexpected obstacles. Your ears need to listen for unusual tire or engine sounds. With your arms, hands, feet, and body you'll need to respond to vibrations and vehicle bounce.

Controlling your vehicle is the key to successful off-road driving. One of the best ways to control your vehicle is to control your speed. Here are some things to keep in mind. At higher speeds:

- you approach things faster and you have less time to scan the terrain for obstacles.
- you have less time to react.
- you have more vehicle bounce when you drive over obstacles.
- you'll need more distance for braking, especially since you're on an unpaved surface.



CAUTION:

When you're driving off road, bouncing and quick changes in direction can easily throw you out of position. This could cause you to lose control and crash. So, whether you're driving on or off the road, you and your passengers should wear safety belts.

Scanning the Terrain

Off-road driving can take you over many different kinds of terrain. You need to be familiar with the terrain and its many different features. Here are some things to consider.

Surface Conditions

Off-roading can take you over hard-packed dirt, gravel, rocks, grass, sand, mud, snow or ice. Each of these surfaces affects the steering, acceleration, and braking of your vehicle in different ways. Depending upon the kind of surface you are on, you may experience slipping, sliding, wheel spinning, delayed acceleration, poor traction, and longer braking distances.

Surface Obstacles

Unseen or hidden obstacles can be hazardous. A rock, log, hole, rut, or bump can startle you if you're not prepared for them. Often these obstacles are hidden by grass, bushes, snow or even the rise and fall of the terrain itself. Here are some things to consider:

- Is the path ahead clear?

- Will the surface texture change abruptly up ahead?
- Does the travel take you uphill or downhill? (There's more discussion of these subjects later.)
- Will you have to stop suddenly or change direction quickly?

When you drive over obstacles or rough terrain, keep a firm grip on the steering wheel. Ruts, troughs, or other surface features can jerk the wheel out of your hands if you're not prepared.

When you drive over bumps, rocks, or other obstacles, your wheels can leave the ground. If this happens, even with one or two wheels, you can't control the vehicle as well or at all.

Because you will be on an unpaved surface, it's especially important to avoid sudden acceleration, sudden turns, or sudden braking.

In a way, off-road driving requires a different kind of alertness from driving on paved roads and highways. There are no road signs, posted speed limits or signal lights. You have to use your own good judgment about what is safe and what isn't.

Your Driving and the Road

Drinking and driving can be very dangerous on any road. And this is certainly true for off-road driving. At the very time you need special alertness and driving skills, your reflexes, perceptions and judgment can be affected by even a small amount of alcohol. You could have a serious — or even fatal — accident if you drink and drive or ride with a driver who has been drinking. (See *Drunken Driving* in the *Index*.)

Driving On Off-Road Hills

Off-road driving often takes you up, down, or across a hill. Driving safely on hills requires good judgment and an understanding of what your vehicle can and can't do. There are some hills that simply can't be driven, no matter how well built the vehicle.



CAUTION:

Many hills are simply too steep for any vehicle. If you drive up them, you will stall. If you drive down them, you can't control your speed. If you drive across them, you will roll over. You could be seriously injured or killed. If you have any doubt about the steepness, don't drive the hill.

Approaching a Hill

When you approach a hill, you need to decide if it's one of those hills that's just too steep to climb, descend, or cross. Steepness can be hard to judge. On a very small hill, for example, there may be a smooth, constant incline with only a small change in elevation where you can easily see all the way to the top. On a large hill, the incline may get steeper as you near the top, but you may not see this because the crest of the hill is hidden by bushes, grass, or shrubs.

Here are some other things to consider as you approach a hill,

- Is there a constant incline, or does the hill get sharply steeper in places?
- Is there good traction on the hillside, or will the surface cause tire slipping?
- Is there a straight path up or down the hill so you won't have to make turning maneuvers?
- Are there obstructions on the hill that can block your path (boulders, trees, logs or ruts)?
- What's beyond the hill? Is there a cliff, an embankment, a drop-off, a fence? Get out and walk the hill if you don't know. It's the smart way to find out.
- Is the hill simply too rough? Steep hills often have ruts, gullies, troughs and exposed rocks because they are more susceptible to the effects of erosion.

Driving Uphill

Once you decide you can safely drive up the hill, you need to take some special steps.

- Use a low gear and get a firm grip on the steering wheel.
- Get a smooth start up the hill and try to maintain your speed. Don't use more power than you need, because you don't want your wheels to start spinning or sliding.
- Try to drive straight up the hill if at all possible. If the path twists and turns, you might want to find another route.



CAUTION:

Turning or driving across steep hills can be dangerous. You could lose traction, slide sideways, and possibly roll over. You could be seriously injured or killed. When driving up hills, always try to go straight up.

- Ease up on your speed as you approach the top of the hill.

- Attach a flag to the vehicle to make you more visible to approaching traffic on trails or hills.
- Sound the horn as you approach the top of the hill to let opposing traffic know you're there.
- Use your headlights even during the day. They make you more visible to oncoming traffic.



CAUTION:

Driving to the top (crest) of a hill at full speed can cause an accident. There could be a drop-off, embankment, cliff, or even another vehicle. You could be seriously injured or killed. As you near the top of a hill, slow down and stay alert.

Q: What should I do if my vehicle stalls, or is about to stall, and I can't make it up the hill?

A: If this happens, there are some things you should do, and there are some things you must not do. First, here's what you **should** do:

- Push the brake pedal to stop the vehicle and keep it from rolling backwards. Also, apply the parking brake.
- If your engine is still running, shift the transmission into reverse, release the parking brake, and slowly back down the hill in reverse.
- If your engine has stopped running, you'll need to restart it. With the brake pedal depressed and the parking brake still applied, shift the transmission to **P** (Park) and restart the engine. Then, shift to reverse, release the parking brake, and slowly back down the hill as straight as possible in reverse.
- As you are backing down the hill, put your left hand on the steering wheel at the 12 o'clock position. This way, you'll be able to tell if your wheels are straight and maneuver as you back down. It's best that you back down the hill with your wheels straight rather than in the left or right direction. Turning the wheel too far to the left or right will increase the possibility of a rollover.

Your Driving and the Road

Here are some things you **must not** do if you stall, or are about to stall, when going up a hill.

- Never attempt to prevent a stall by shifting into **N** (Neutral) to “rev-up” the engine and regain forward momentum. This won’t work. Your vehicle will roll backwards very quickly and you could go out of control. Instead, apply the regular brake to stop the vehicle. Then apply the parking brake. Shift into reverse, release the parking brake, and slowly back straight down.
- Never attempt to turn around if you are about to stall when going up a hill. If the hill is steep enough to stall your vehicle, it’s steep enough to cause you to roll over if you turn around. If you can’t make it up the hill, you must back straight down the hill.

Q: Suppose, after stalling, I try to back down the hill and decide I just can’t do it. What should I do?

A: Set the parking brake, put your transmission in **P** (Park), and turn off the engine. Leave the vehicle and go

get some help. Exit on the uphill side and stay clear of the path the vehicle would take if it rolled downhill.

Driving Downhill

When off-roading takes you downhill, you’ll want to consider a number of things:

- How steep is the downhill? Will I be able to maintain vehicle control?
- What’s the surface like? Smooth? Rough? Slippery? Hard-packed dirt? Gravel?
- Are there hidden surface obstacles? Ruts? Logs? Boulders?
- What’s at the bottom of the hill? Is there a hidden creek bank or even a river bottom with large rocks?

If you decide you can go down a hill safely, then try to keep your vehicle headed straight down, and use a low gear. This way, engine drag can help your brakes and they won’t have to do all the work. Descend slowly, keeping your vehicle under control at all times.



CAUTION:

Heavy braking when going down a hill can cause your brakes to overheat and fade. This could cause loss of control and a serious accident. Apply the brakes lightly when descending a hill and use a low gear to keep vehicle speed under control.

Q: Are there some things I should not do when driving down a hill?

A: Yes! These are important because if you ignore them you could lose control and have a serious accident.

- When driving downhill, avoid turns that take you across the incline of the hill. A hill that’s not too steep to drive down may be too steep to drive across. You could roll over if you don’t drive straight down.
- Never go downhill with the transmission in **N** (Neutral). This is called “free-wheeling.” Your brakes will have to do all the work and could overheat and fade.

Q: Am I likely to stall when going downhill?

A: It's much more likely to happen going uphill. But if it happens going downhill, here's what to do.

- Stop your vehicle by applying the regular brakes. Apply the parking brake.
- Shift to **P** (Park) and, while still braking, restart the engine.
- Shift back to a low gear, release the parking brake, and drive straight down.
- If the engine won't start, get out and get help.

Driving Across an Incline

Sooner or later, an off-road trail will probably go across the incline of a hill. If this happens, you have to decide whether to try to drive across the incline. Here are some things to consider:

- A hill that can be driven straight up or down may be too steep to drive across. When you go straight up or down a hill, the length of the wheel base (the distance from the front

wheels to the rear wheels) reduces the likelihood the vehicle will tumble end over end. But when you drive across an incline, the much more narrow track width (the distance between the left and right wheels) may not prevent the vehicle from tilting and rolling over. Also, driving across an incline puts more weight on the downhill wheels. This could cause a downhill slide or a rollover.

- Surface conditions can be a problem when you drive across a hill. Loose gravel, muddy spots, or even wet grass can cause your tires to slip sideways, downhill. If the vehicle slips sideways, it can hit something that will trip it (a rock, a rut, etc.) and roll over.
- Hidden obstacles can make the steepness of the incline even worse. If you drive across a rock with the uphill wheels, or if the downhill wheels drop into a rut or depression, your vehicle can tilt even more.

For reasons like these, you need to decide carefully whether to try to drive

across an incline. Just because the trail goes across the incline doesn't mean you have to drive it. The last vehicle to try it might have rolled over.



CAUTION:

Driving across an incline that's too steep will make your vehicle roll over. You could be seriously injured or killed. If you have any doubt about the steepness of the incline, don't drive across it. Find another route instead.

Q: What if I'm driving across an incline that's not too steep, but I hit some loose gravel and start to slide downhill. What should I do?

A: If you feel your vehicle starting to slide sideways, turn downhill. This should help straighten out the vehicle and prevent the side slipping. However, a much better way to prevent this is to get out and "walk the course" so you know what the surface is like before you drive it.

Your Driving and the Road



Stalling on an Incline

If your vehicle stalls when you're crossing an incline, be sure you (and your passengers) get out on the uphill side, even if the door there is harder to open. If you get out on the downhill side and the vehicle starts to roll over, you'll be right in its path.

If you have to walk down the slope, stay out of the path the vehicle will take if it does roll over.



CAUTION:

Getting out on the downhill (low) side of a vehicle stopped across an incline is dangerous. If the vehicle rolls over, you could be crushed or killed. Always get out on the uphill (high) side of the vehicle and stay well clear of the rollover path.

Driving In Mud, Sand, Snow, Or Ice

When you drive in mud, snow or sand, your wheels won't get good traction. You can't accelerate as quickly, turning is more difficult, and you'll need longer braking distances.

It's best to use a low gear when you're in mud — the deeper the mud, the lower the gear. In really deep mud, the idea is to keep your vehicle moving so you don't get stuck.

When you drive on sand, you'll sense a change in wheel traction. But it will depend upon how loosely packed the sand is. On loosely packed sand (as on beaches or sand dunes) your tires will

tend to sink into the sand. This has an effect on steering, accelerating, and braking. You may want to reduce the air pressure in your tires slightly when driving on sand. This will improve traction.

Hard packed snow and ice offer the worst tire traction. On these surfaces, it's very easy to lose control. On wet ice, for example, the traction is so poor that you will have difficulty accelerating. And if you do get moving, poor steering and difficult braking can cause you to slide out of control.



CAUTION:

Driving on frozen lakes, ponds or rivers can be dangerous. Underwater springs, currents under the ice, or sudden thaws can weaken the ice. Your vehicle could fall through the ice and you and your passengers could drown. Drive your vehicle on safe surfaces only.

Driving In Water

Light rain causes no special off-road driving problems. But heavy rain can mean flash flooding, and flood waters demand extreme caution.

Find out how deep the water is before you drive through it. If it's deep enough to cover your wheel hubs, axles, or exhaust pipe, don't try it — you probably won't get through. Also, water that deep can damage your axle and other vehicle parts.

If the water isn't too deep, then drive through it slowly. At fast speeds, water splashes on your ignition system and your vehicle can stall. Stalling can also occur if you get your tailpipe under water. And, as long as your tailpipe is under water, you'll never be able to start your engine. When you go through water, remember that when your brakes get wet, it may take you longer to stop.



CAUTION:

Driving through rushing water can be dangerous. Deep water can sweep your vehicle downstream and you and your passengers could drown. If it's only inches deep, it can still wash away the ground from under your tires, and you could lose traction and roll the vehicle over. Don't drive through rushing water.

After Off-Road Driving

Remove any brush or debris that has collected on the underbody, chassis or under the hood. These accumulations can be a fire hazard.

After operation in mud or sand, have the brake linings cleaned and checked. These substances can cause glazing and uneven braking. Check the body structure, steering, suspension, wheels, tires, and exhaust system for damage. Also, check the fuel lines and cooling system for any leakage.

Your vehicle will require more frequent service due to off-road use. Refer to the Maintenance Schedule for additional information.

Your Driving and the Road



■ *Driving at Night*

Night driving is more dangerous than day driving. One reason is that some drivers are likely to be impaired — by alcohol or drugs, with night vision problems, or by fatigue.

Here are some tips on night driving.

- Drive defensively.
- Don't drink and drive.
- Adjust your inside rearview mirror to reduce the glare from headlights behind you.
- Since you can't see as well, you may need to slow down and keep more space between you and other vehicles.

- Slow down, especially on higher speed roads. Your headlights can light up only so much road ahead.
- In remote areas, watch for animals.
- If you're tired, pull off the road in a safe place and rest.

Night Vision

No one can see as well at night as in the daytime. But as we get older these differences increase. A 50-year-old driver may require at least twice as much light to see the same thing at night as a 20-year-old.

What you do in the daytime can also affect your night vision. For example, if you spend the day in bright sunshine you are wise to wear sunglasses. Your eyes will have less trouble adjusting to night. But if you're driving, don't wear sunglasses at night. They may cut down on glare from headlights, but they also make a lot of things invisible.

You can be temporarily blinded by approaching lights. It can take a second or two, or even several seconds, for

your eyes to readjust to the dark. When you are faced with severe glare (as from a driver who doesn't lower the high beams, or a vehicle with misaimed headlights), slow down a little. Avoid staring directly into the approaching lights.

Keep your windshield and all the glass on your vehicle clean — inside and out. Glare at night is made much worse by dirt on the glass. Even the inside of the glass can build up a film caused by dust. Dirty glass makes lights dazzle and flash more than clean glass would, making the pupils of your eyes contract repeatedly.

Remember that your headlights light up far less of a roadway when you are in a turn or curve. Keep your eyes moving; that way, it's easier to pick out dimly lighted objects. Just as your headlights should be checked regularly for proper aim, so should your eyes be examined regularly. Some drivers suffer from night blindness — the inability to see in dim light — and aren't even aware of it.



■ *Driving in the Rain*

Rain and wet roads can mean driving trouble. On a wet road you can't stop, accelerate or turn as well because your tire-to-road traction isn't as good as on dry roads. And, if your tires don't have much tread left, you'll get even less traction. It's always wise to go slower and be cautious if rain starts to fall while you are driving. The surface may get wet suddenly when your reflexes are tuned for driving on dry pavement.

The heavier the rain, the harder it is to see. Even if your windshield wiper blades are in good shape, a heavy rain can make it harder to see road signs and traffic signals, pavement markings, the edge of the road, and even people walking.

It's wise to keep your wiping equipment in good shape and keep your windshield washer tank filled. Replace your windshield wiper inserts when they show signs of streaking or missing areas on the windshield, or when strips of rubber start to separate from the inserts.



Driving too fast through large water puddles or even going through some car washes can cause problems, too. The water may affect your brakes. Try to avoid puddles. But if you can't, try to slow down before you hit them.



CAUTION:

Wet brakes can cause accidents. They won't work well in a quick stop and may cause pulling to one side. You could lose control of the vehicle. After driving through a large puddle of water or a car wash, apply your brake pedal lightly until your brakes work normally.

Your Driving and the Road

Hydroplaning

Hydroplaning is dangerous. So much water can build up under your tires that they can actually ride on the water. This can happen if the road is wet enough and you're going fast enough. When your vehicle is hydroplaning, it has little or no contact with the road.

Hydroplaning doesn't happen often. But it can if your tires haven't much tread or if the pressure in one or more is low. It can happen if a lot of water is standing on the road. If you can see reflections from trees, telephone poles, or other vehicles, and raindrops "dimple" the water's surface, there could be hydroplaning.

Hydroplaning usually happens at higher speeds. There just isn't a hard and fast rule about hydroplaning. The best advice is to slow down when it is raining.

Some Other Rainy Weather Tips

- Turn on your low-beam headlights — not just your parking lights — to help make you more visible to others.
- Besides slowing down, allow some extra following distance. And be especially careful when you pass another vehicle. Allow yourself more clear room ahead, and be prepared to have your view restricted by road spray.
- Have good tires with proper tread depth. (See *Tires* in the *Index*.)



■ City Driving

One of the biggest problems with city streets is the amount of traffic on them. You'll want to watch out for what the other drivers are doing and pay attention to traffic signals.

Here are ways to increase your safety in city driving:

- Know the best way to get to where you are going. Get a city map and plan your trip into an unknown part of the city just as you would for a cross-country trip.

- Try to use the freeways that rim and crisscross most large cities. You'll save time and energy. (See the next section, *Freeway Driving*.)
- Treat a green light as a warning signal. A traffic light is there because the corner is busy enough to need it. When a light turns green, and just before you start to move, check both ways for vehicles that have not cleared the intersection or may be running the red light.



■ *Freeway Driving*

Mile for mile, freeways (also called thruways, parkways, expressways, turnpikes, or superhighways) are the safest of all roads. But they have their own special rules.

The most important advice on freeway driving is: Keep up with traffic and keep to the right. Drive at the same speed most of the other drivers are driving. Too-fast or too-slow driving breaks a smooth traffic flow. Treat the left lane on a freeway as a passing lane.

At the entrance there is usually a ramp that leads to the freeway. If you have a clear view of the freeway as you drive along the entrance ramp, you should

begin to check traffic. Try to determine where you expect to blend with the flow. Try to merge into the gap at close to the prevailing speed. Switch on your turn signal, check your mirrors and glance over your shoulder as often as necessary. Try to blend smoothly with the traffic flow.

Once you are on the freeway, adjust your speed to the posted limit or to the prevailing rate if it's slower. Stay in the right lane unless you want to pass.

Before changing lanes, check your mirrors. Then use your turn signal.

Just before you leave the lane, glance quickly over your shoulder to make sure there isn't another vehicle in your "blind" spot.

Once you are moving on the freeway, make certain you allow a reasonable following distance. Expect to move slightly slower at night.

When you want to leave the freeway, move to the proper lane well in advance. If you miss your exit do not, under any circumstances, stop and back up. Drive on to the next exit.

Your Driving and the Road

The exit ramp can be curved, sometimes quite sharply.

The exit speed is usually posted.

Reduce your speed according to your speedometer, not to your sense of motion. After driving for any distance at higher speeds, you may tend to think you are going slower than you actually are.

■ *Before Leaving on a Long Trip*

Make sure you're ready. Try to be well rested. If you must start when you're not fresh — such as after a day's work — don't plan to make too many miles that first part of the journey. Wear comfortable clothing and shoes you can easily drive in.

Is your vehicle ready for a long trip? If you keep it serviced and maintained, it's ready to go. If it needs service, have it done before starting out. Of course, you'll find experienced and able service experts in Oldsmobile dealerships all across North America. They'll be ready and willing to help if you need it.

Here are some things you can check before a trip:

- **Windshield Washer Fluid:** Is the reservoir full? Are all windows clean inside and outside?
- **Wiper Blades:** Are they in good shape?
- **Fuel, Engine Oil, Other Fluids:** Have you checked all levels?
- **Lights:** Are they all working? Are the lenses clean?
- **Tires:** They are vitally important to a safe, trouble-free trip. Is the tread good enough for long-distance driving? Are the tires all inflated to the recommended pressure?
- **Weather Forecasts:** What's the weather outlook along your route? Should you delay your trip a short time to avoid a major storm system?
- **Maps:** Do you have up-to-date maps?

■ *Highway Hypnosis*

Is there actually such a condition as "highway hypnosis"? Or is it just plain falling asleep at the wheel? Call it highway hypnosis, lack of awareness, or whatever.

There is something about an easy stretch of road with the same scenery,

along with the hum of the tires on the road, the drone of the engine, and the rush of the wind against the vehicle that can make you sleepy. Don't let it happen to you! If it does, your vehicle can leave the road in **less than a second**, and you could crash and be injured.

What can you do about highway hypnosis? First, be aware that it can happen.

Then here are some tips:

- Make sure your vehicle is well ventilated, with a comfortably cool interior.
- Keep your eyes moving. Scan the road ahead and to the sides. Check your mirrors and your instruments frequently.
- If you get sleepy, pull off the road into a rest, service, or parking area and take a nap, get some exercise, or both. For safety, treat drowsiness on the highway as an emergency.



■ *Hill and Mountain Roads*

Driving on steep hills or mountains is different from driving in flat or rolling terrain.

If you drive regularly in steep country, or if you're planning to visit there, here are some tips that can make your trips safer and more enjoyable. (See *Off-Road Driving* in the *Index* for information about driving off-road.)

- Keep your vehicle in good shape. Check all fluid levels and also the brakes, tires, cooling system and transmission. These parts can work hard on mountain roads.
- Know how to go down hills. The most important thing to know is this: let your engine do some of the slowing

down. Shift to a lower gear when you go down a steep or long hill.



CAUTION:

If you don't shift down, your brakes could get so hot that they wouldn't work well. You would then have poor braking or even none going down a hill. You could crash. Shift down to let your engine assist your brakes on a steep downhill slope.



CAUTION:

Coasting downhill in N (Neutral) or with the ignition off is dangerous. Your brakes will have to do all the work of slowing down. They could get so hot that they wouldn't work well. You could crash. Always have your engine running and your vehicle in gear when you go downhill.

- Know how to go uphill. You may want to shift down to a lower gear. The lower gears help cool your engine and transmission, and you can climb the hill better.
- Stay in your own lane when driving on two-lane roads in hills or mountains. Don't swing wide or cut across the center of the road. Drive at speeds that let you stay in your own lane.
- As you go over the top of a hill, be alert. There could be something in your lane, like a stalled car or an accident.
- You may see highway signs on mountains that warn of special problems. Examples are long grades, passing or no-passing zones, a falling rocks area, or winding roads. Be alert to these and take appropriate action.

Your Driving and the Road



■ Winter Driving

Here are some tips for winter driving:

- Have your Oldsmobile in good shape for winter. Be sure your engine coolant mix is correct.
- You may want to put winter emergency supplies in your vehicle.

Include an ice scraper, a small brush or broom, a supply of windshield washer fluid, a rag, some winter outer clothing, a small shovel, a flashlight, a red cloth, and a couple of reflective warning triangles. And, if you will be driving under severe conditions, include a small bag of sand, a piece of old carpet or a couple of burlap bags to help provide traction. Be sure you properly secure these items in your vehicle.



Driving on Snow or Ice

Most of the time, those places where your tires meet the road probably have good traction.

However, if there is snow or ice between your tires and the road, you can have a very slippery situation. You'll have a lot less traction or "grip" and will need to be very careful.

What's the worst time for this? "Wet ice." Very cold snow or ice can be slick and hard to drive on. But wet ice can be even more trouble because it may offer the least traction of all. You can get "wet ice" when it's about freezing (32°F; 0°C) and freezing rain begins to fall. Try to avoid driving on wet ice until salt and sand crews can get there.

Whatever the condition — smooth ice, packed, blowing or loose snow — drive with caution.

Accelerate gently. Try not to break the fragile traction. If you accelerate too fast, the drive wheels will spin and polish the surface under the tires even more.

Your anti-lock brakes improve your ability to make a hard stop on a slippery road. Even though you have an anti-lock braking system, you'll want to begin stopping sooner than you would on dry pavement. See *Anti-Lock* in the *Index*.

- Allow greater following distance on any slippery road.
- Watch for slippery spots. The road might be fine until you hit a spot that's covered with ice. On an otherwise clear road, ice patches may appear in shaded areas where the sun can't reach: around clumps of trees, behind buildings, or under bridges. Sometimes the surface of a curve or an overpass may remain icy when the surrounding roads are clear. If you see a patch of ice ahead of you, brake before you are on it. Try not to brake while you're actually on the ice, and avoid sudden steering maneuvers.



If You're Caught in a Blizzard

If you are stopped by heavy snow, you could be in a serious situation. You should probably stay with your vehicle unless you know for sure that you are near help and you can hike through the snow. Here are some things to do to summon help and keep yourself and your passengers safe: Turn on your hazard flashers. Tie a red cloth to your vehicle to alert police that you've been stopped by the snow. Put on extra clothing or wrap a blanket around you. If you have no blankets or extra clothing, make body insulators from newspapers, burlap bags, rags, floor mats — anything you can wrap around yourself or tuck under your clothing to keep warm.

You can run the engine to keep warm, but be careful.



CAUTION:

Snow can trap exhaust gases under your vehicle. This can cause deadly CO (carbon monoxide) gas to get inside. CO could overcome you and kill you. You can't see it or smell it, so you might not know it is in your vehicle. Clear away snow from around the base of your vehicle, especially any that is blocking your exhaust pipe. And check around again from time to time to be sure snow doesn't collect there. Open a window just a little on the side of the vehicle that's away from the wind. This will help keep CO out.

Run your engine only as long as you must. This saves fuel. When you run the engine, make it go a little faster than just idle. That is, push the accelerator slightly. This uses less fuel for the heat that you get and it keeps the battery charged. You will need a well-charged battery to restart the vehicle, and possibly for signaling later on with your headlights. Let the heater run for awhile.

Then, shut the engine off and close the window almost all the way to preserve the heat. Start the engine again and repeat this only when you feel really uncomfortable from the cold. But do it as little as possible. Preserve the fuel as long as you can. To help keep warm, you can get out of the vehicle and do some fairly vigorous exercises every half hour or so until help comes.

Your Driving and the Road

■ *Towing a Trailer*



CAUTION:

If you don't use the correct equipment and drive properly, you can lose control when you pull a trailer. For example, if the trailer is too heavy, the brakes may not work well — or even at all. You and your passengers could be seriously injured. Pull a trailer only if you have followed all the steps in this section. Ask your Oldsmobile dealer for advice and information about towing a trailer with your vehicle.

NOTICE:

Pulling a trailer improperly can damage your vehicle and result in costly repairs not covered by your warranty. To pull a trailer correctly, follow the advice in this section, and see your Oldsmobile dealer for important information about towing a trailer with your vehicle.

Every Bravada is ready for some trailer towing. If it was built with trailering options, as many are, it's ready for heavier trailers. But trailering is different than just driving your vehicle by itself. Trailering means changes in handling, durability, and fuel economy. Successful, safe trailering takes correct equipment, and it has to be used properly.

That's the reason for this section. In it are many time-tested, important trailering tips and safety rules. Many of these are important for your safety and that of your passengers. So please read this section carefully before you pull a trailer.

If You Do Decide To Pull A Trailer

If you do, here are some important points.

- There are many different laws having to do with trailering. Make sure your rig will be legal, not only where you live but also where you'll be driving. A good source for this information can be state or provincial police.
- Consider using a sway control if your trailer will weigh 2,000 pounds (900 kg) or less. You should always use a sway control if your trailer will weigh more than 2,000 pounds (900 kg).

You can ask a hitch dealer about sway controls.

- Don't tow a trailer at all during the first 500 miles (800 km) your new vehicle is driven. Your engine, axle or other parts could be damaged.
- Then, during the first 500 miles (800 km) that you tow a trailer, don't drive over 50 mph (80 km/h) and don't make starts at full throttle. This helps your engine and other parts of your vehicle wear in at the heavier loads.

Three important considerations have to do with weight:

Weight of the Trailer

How heavy can a trailer safely be?

It should never weigh more than 5,250 pounds (2 380 kg). But even that can be too heavy.

It depends on how you plan to use your rig. For example, speed, altitude, road grades, outside temperature and how much your vehicle is used to pull a trailer are all important. And, it can also depend on any special equipment that you have on your vehicle.

You can ask your dealer for our trailering information or advice, or you can write us at:

Oldsmobile Customer Assistance
Network
P.O. Box 30095
Lansing, MI 48909

In Canada, write to:

General Motors of Canada Limited
Customer Assistance Center
1908 Colonel Sam Drive
Oshawa, Ontario L1H 8P7

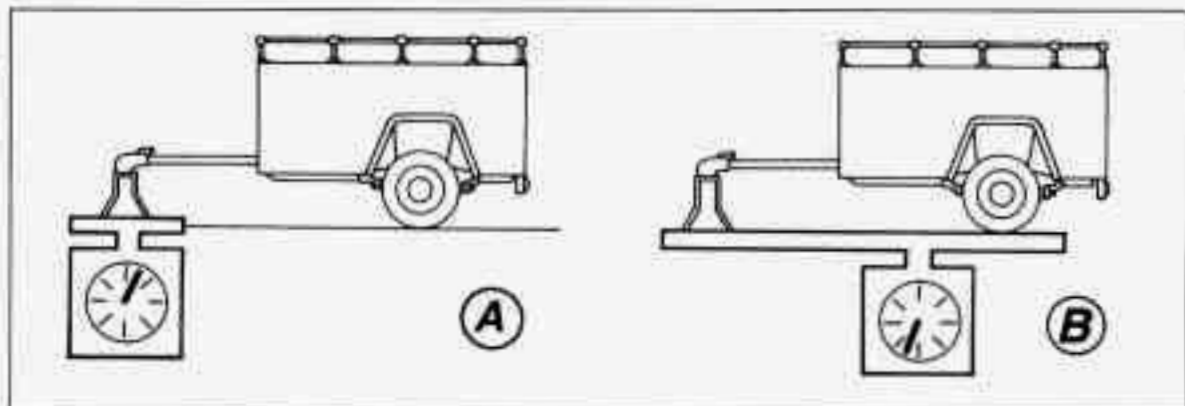

Weight of the Trailer Tongue

The tongue load (A) of any trailer is an important weight to measure because it affects the total or gross weight of your vehicle. The gross vehicle weight (GVW) includes the curb weight of the vehicle, any cargo you may carry in it, and the people who will be riding in the vehicle. And if you will tow a trailer, you must add the tongue load to the GVW because your vehicle will be carrying that weight, too. See *Loading Your Vehicle* in the *Index* for more information about your vehicle's maximum load capacity.

If you're using a "dead-weight" hitch, the trailer tongue (A) should weigh 10% of the total loaded trailer weight (B). If you have a "weight-distributing"

hitch, the trailer tongue (A) should weigh 12% of the total loaded trailer weight (B).

After you've loaded your trailer, weigh the trailer and then the tongue, separately, to see if the weights are proper. If they aren't, you may be able to get them right simply by moving some items around in the trailer.

Total Weight on Your Vehicle's Tires

Be sure your vehicle's tires are inflated to the limit for cold tires. You'll find these numbers on the Certification label at the rear edge of the driver's door or see *Tire Loading* in the *Index*. Then be sure you don't go over the GVW limit for your vehicle.

Your Driving and the Road

Hitches

It's important to have the correct hitch equipment. Crosswinds, large trucks going by, and rough roads are a few reasons why you'll need the right hitch. Here are some rules to follow:

- If you'll be pulling a trailer that, when loaded, will weigh more than 2,000 pounds (900 kg), be sure to use a properly mounted, weight-distributing hitch and sway control of the proper size. This equipment is very important for proper vehicle loading and good handling when you're driving.
- Will you have to make any holes in the body of your vehicle when you install a trailer hitch? If you do, then be sure to seal the holes later when you remove the hitch. If you don't seal them, deadly carbon monoxide (CO) from your exhaust can get into your vehicle (see *Carbon Monoxide* in the *Index*). Dirt and water can, too.
- The bumpers on your vehicle are not intended for hitches. Do not attach rental hitches or other bumper-type hitches to them. Use only a frame-mounted hitch that does not attach to the bumper.

If your vehicle has a deadweight hitch and a tailgate-mounted spare tire, and your trailer has a winch or tongue jack, you could have interference between them.

Safety Chains

You should always attach chains between your vehicle and your trailer. Cross the safety chains under the tongue of the trailer so that the tongue will not drop to the road if it becomes separated from the hitch. Instructions about safety chains may be provided by the hitch manufacturer or by the trailer manufacturer. Follow the manufacturer's recommendation for attaching safety chains. Always leave just enough slack so you can turn with your rig. And, never allow safety chains to drag on the ground.

Trailer Brakes

If your trailer weighs more than 1,000 pounds (450 kg) loaded, then it needs its own brakes — and they must be adequate. Be sure to read and follow the instructions for the trailer brakes so you'll be able to install, adjust and maintain them properly.

Don't tap into your vehicle's brake system if the trailer's brake system will use more than 0.02 cubic inch (0.3 cc) of fluid from your vehicle's master cylinder. If it does, both braking systems won't work well. You could even lose your brakes.

- Will the trailer brake parts take 3,000 psi (20 650 kPa) of pressure? If not, the trailer brake system must not be used with your vehicle.
- If everything checks out this far, then make the brake fluid tap at the port on the master cylinder that sends fluid to the rear brakes. But don't use copper tubing for this. If you do, it will bend and finally break off. Use steel brake tubing.

Driving with a Trailer

Towing a trailer requires a certain amount of experience. Before setting out for the open road, you'll want to get to know your rig. Acquaint yourself with the feel of handling and braking with the added weight of the trailer. And always keep in mind that the vehicle you are driving is now a good

deal longer and not nearly so responsive as your vehicle is by itself.

Before you start, check the trailer hitch and platform, safety chains, electrical connector, lights, tires and mirror adjustment. If the trailer has electric brakes, start your vehicle and trailer moving and then apply the trailer brake controller by hand to be sure the brakes are working. This lets you check your electrical connection at the same time.



CAUTION:

If you have a rear-most window open and you pull a trailer with your vehicle, carbon monoxide (CO) could come into your vehicle. You can't see or smell CO. It can cause unconsciousness or death (See *Engine Exhaust* in the *Index*.) To maximize your safety when towing a trailer:

- Have your exhaust system inspected for leaks, and make necessary repairs before starting on your trip.

CAUTION (Continued)

CAUTION (Continued)

- Keep the rear-most windows closed.
- If exhaust does come into your vehicle through a window in the rear or another opening, drive with your front, main heating or cooling system **on** and with the fan on any speed. This will bring fresh, outside air into your vehicle. Do not use **MAX A/C** because it only recirculates the air inside your vehicle. (See *Comfort Controls* in the *Index*.)

During your trip, check occasionally to be sure that the load is secure, and that the lights and any trailer brakes are still working.

Following Distance

Stay at least twice as far behind the vehicle ahead as you would when driving your vehicle without a trailer. This can help you avoid situations that require heavy braking and sudden turns.

Passing

You'll need more passing distance up ahead when you're towing a trailer. And, because you're a good deal longer, you'll need to go much farther beyond the passed vehicle before you can return to your lane.

Backing Up

Hold the bottom of the steering wheel with one hand. Then, to move the trailer to the left, just move that hand to the left. To move the trailer to the right, move your hand to the right. Always back up slowly and, if possible, have someone guide you.

Making Turns

When you're turning with a trailer, make wider turns than normal. Do this so your trailer won't strike soft shoulders, curbs, road signs, trees, or other objects. Avoid jerky or sudden maneuvers. Signal well in advance.

Your Driving and the Road

Turn Signals When Towing a Trailer

When you tow a trailer, your vehicle has to have a different turn signal flasher and extra wiring. The green arrows on your instrument panel will flash whenever you signal a turn or lane change. Properly hooked up, the trailer lights will also flash, telling other drivers you're about to turn, change lanes or stop.

When towing a trailer, the green arrows on your instrument panel will flash for turns even if the bulbs on the trailer are burned out. Thus, you may think drivers behind you are seeing your signal when they are not. It's important to check occasionally to be sure the trailer bulbs are still working.

Driving On Grades

Reduce speed and shift to a lower gear **before** you start down a long or steep downgrade. If you don't shift down, you might have to use your brakes so much that they would get hot and no longer work well.

On a long uphill grade, shift down and reduce your speed to around 45 mph (70 km/h) to reduce the possibility of engine and transmission overheating.

If you are towing a trailer that weighs more than 3,000 pounds (1 350 kg), it's best to drive in **D** instead of Overdrive (or, as you need to, a lower gear). This will minimize heat build-up and extend the life of your transmission.

Parking on Hills

You really should not park your vehicle, with a trailer attached, on a hill. If something goes wrong, your rig could start to move. People can be injured, and both your vehicle and the trailer can be damaged.

But if you ever have to park your rig on a hill, here's how to do it:

1. Apply your regular brakes, but don't shift into **P** (Park) yet.
2. Have someone place chocks under the trailer wheels.
3. When the wheel chocks are in place, release the regular brakes until the chocks absorb the load.

4. Reapply the regular brakes. Then apply your parking brake and then shift to **P** (Park).

5. Release the regular brakes.

When You Are Ready to Leave After Parking on a Hill

1. Apply your regular brakes and hold the pedal down while you:
 - Start your engine;
 - Shift into a gear; and
 - Release the parking brake.
2. Let up on the brake pedal.
3. Drive slowly until the trailer is clear of the chocks.
4. Stop and have someone pick up and store the chocks.

Maintenance When Trailer Towing

Your vehicle will need service more often when you're pulling a trailer. See the Maintenance Schedule for more on this. Things that are especially important in trailer operation are automatic transmission fluid (don't overfill), engine oil, axle lubricant, belt, cooling system, and brake adjustment. Each of these is covered in this manual,

and the Index will help you find them quickly. If you're trailering, it's a good idea to review these sections before you start your trip.

Check periodically to see that all hitch nuts and bolts are tight.

Trailer Light Wiring

See the next section, *Trailer Wiring Harness*.



Trailer Wiring Harness (OPTION)

Your Bravada is equipped with a 7-wire trailer harness with a 30-amp battery feed wire. It's stored under the vehicle along the rear frame crossmember.

Since connectors for trailers vary, no connector is provided. You will need to obtain one for the trailer you want to pull. Have it wired to the harness by a qualified service technician.

When wiring the harness to a connector, disconnect the battery before removing the tape from the wire.

The wire applications are:

- White—Ground
- Dark green—Right turn signal
- Yellow—Left turn signal
- Brown—Rear lamps
- Light green—Back-up lamps
- Red—Battery charging
- Blue—Trailer brakes, auxiliary

In use, tape or tie the harness to your vehicle's frame rail. Leave enough slack so the wiring doesn't bend or break, but not so much that it drags on the ground.

When it's not in use, fold the harness neatly and wrap or tie it. Store in the original place along the frame crossmember.



Here you'll find what to do about some problems that can occur on the road.

Part 5

Problems on the Road

Hazard Warning Flashers	140
Jump Starting	140
Towing Your Bravada	144
Engine Overheating	145
If a Tire Goes Flat	151
Changing a Flat Tire	151
If You're Stuck: In Sand, Mud, Ice or Snow	158

Problems on the Road



■ Hazard Warning Flashers

Your hazard warning flashers let you warn others. They also let police know you have a problem. Your front and rear turn signal lights will flash on and off. But they won't flash if you're braking.



Press the button in to make your front and rear turn signal lights flash on and off.

Your hazard warning flashers work no matter what position your key is in, and even if the key isn't in.



To turn off the flashers, pull out on the collar.

When the hazard warning flashers are on, your turn signals won't work.

Other Warning Devices

If you carry reflective triangles, you can set one up at the side of the road about 300 feet (100 m) behind your vehicle.

■ Jump Starting

If your battery has run down, you may want to use another vehicle and some jumper cables to start your Oldsmobile. But please follow the steps below to do it safely.



CAUTION:

Batteries can hurt you. They can be dangerous because:

- They contain **acid** that can burn you.
- They contain **gas** that can explode or ignite.
- They contain enough **electricity** to burn you.

If you don't follow these steps exactly, some or all of these things can hurt you.

NOTICE:

Ignoring these steps could result in costly damage to your vehicle that wouldn't be covered by your warranty. Trying to start your Oldsmobile by pushing or pulling it won't work, and it could damage your vehicle.

To Jump Start Your Oldsmobile:

1. Check the other vehicle. It must have a 12-volt battery with a negative ground system.

NOTICE:

If the other system isn't a 12-volt system with a negative ground, both vehicles can be damaged.

2. Get the vehicles close enough so the jumper cables can reach, but be sure the vehicles aren't touching each other. If they are, it could cause a ground connection you don't want. You wouldn't be able to start your Oldsmobile, and the bad grounding could damage the electrical systems.

You could be injured if the vehicles roll. Set the parking brake firmly on each vehicle. Put an automatic transmission in **P** (Park) or a manual transmission in **N** (Neutral).

3. Turn off the ignition on both vehicles. Turn off all lights that aren't needed, and radios. This will avoid sparks and help save both batteries. And it could save your radio!

NOTICE:

If you leave your radio on, it could be badly damaged. The repairs wouldn't be covered by your warranty.

4. Open the hoods and locate the batteries. Find the positive (+) and negative (-) terminals on each battery.

Problems on the Road



CAUTION:

Using a match near a battery can cause battery gas to explode. People have been hurt doing this, and some have been blinded. Use a flashlight if you need more light. Be sure the battery has enough water. You don't need to add water to the Delco Freedom[®] battery installed in every new GM vehicle. But if a battery has filler caps, be sure the right amount of fluid is there. If it is low, add water to take care of that first. If you don't, explosive gas could be present.

Battery fluid contains acid that can burn you. Don't get it on you. If you accidentally get it in your eyes or on your skin, flush the place with water and get medical help immediately.

5. Check that the jumper cables don't have loose or missing insulation. If they do, you could get a shock. The vehicles could be damaged, too. Before you connect the cables, here are some basic things you should know. Positive (+) will go to positive (+) and negative (-) will go to negative (-) or a metal engine part. Don't connect (+) to (-) or you'll get a short that would damage the battery and maybe other parts, too.



CAUTION:

Fans or other moving engine parts can injure you badly. Keep your hands away from moving parts once the engines are running.

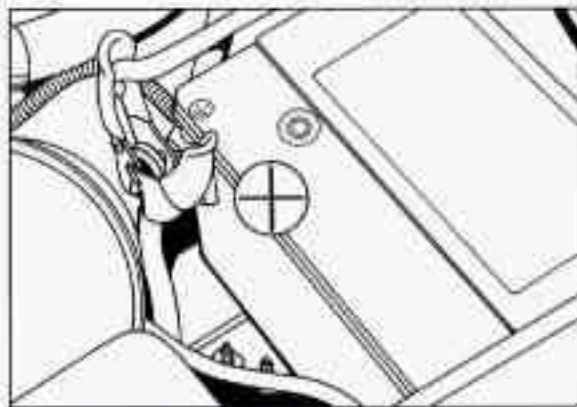

6. Connect the red positive (+) cable to the positive (+) terminal of the vehicle with the dead battery. Use a remote positive (+) terminal if the vehicle has one.

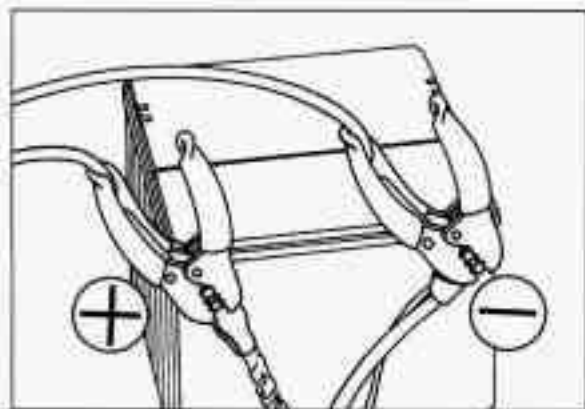

7. Don't let the other end touch metal. Connect it to the positive (+) terminal of the good battery. Use a remote positive (+) terminal if the vehicle has one.

8. Now connect the black negative (-) cable to the good battery's negative (-) terminal. Don't let the other end touch anything until the next step. The other end of the negative cable **doesn't** go to the dead battery. It goes to a heavy unpainted metal part on the engine of the vehicle with the dead battery.

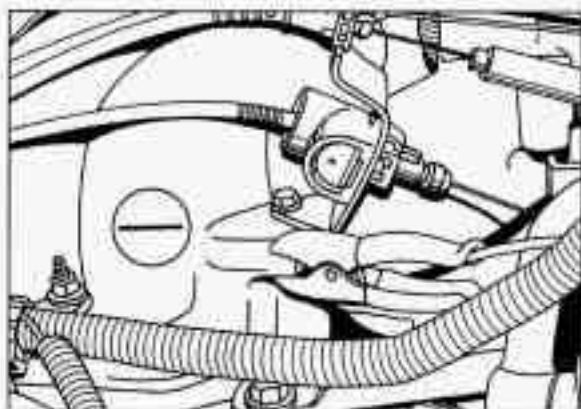

9. Attach the cable at least 18 inches (45 cm) away from the dead battery, but not near engine parts that move. The electrical connection is just as good there, but the chance of sparks getting back to the battery is much less.

10. Now start the vehicle with the good battery and run the engine for a while.

11. Try to start the vehicle with the dead battery. If it won't start after a few tries, it probably needs service.

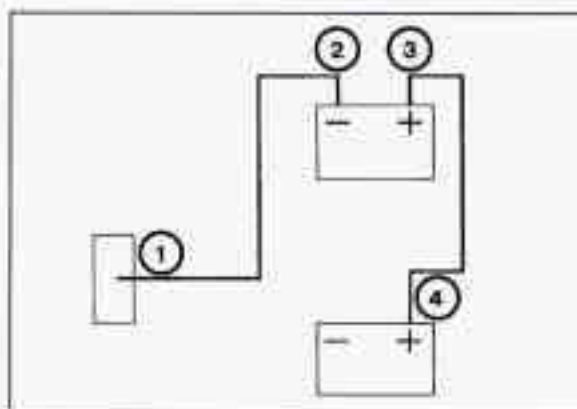

12. Remove the cables in reverse order to prevent electrical shorting. Take care that they don't touch each other or any other metal.

Problems on the Road

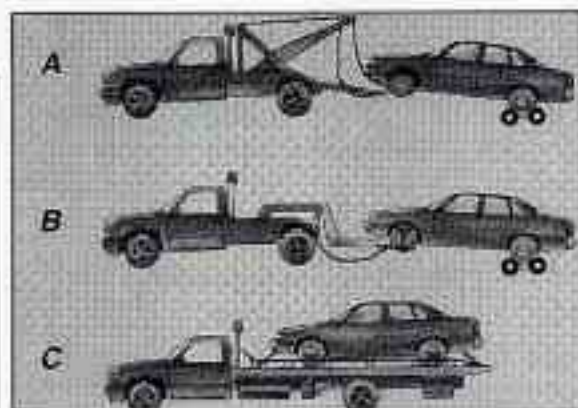

■ Towing Your Bravada

Try to have a GM dealer or a professional towing service tow your vehicle. The usual towing equipment is:

- (A) Sling-type tow truck
- (B) Wheel-lift tow truck
- (C) Car carrier

If your vehicle has been changed or modified since it was factory-new by adding aftermarket items like aero skirting or special tires and wheels, these instructions may not be correct.

Before you do anything, turn on the hazard warning flashers.

NOTICE:

Dollies must be used on ground wheels or vehicle damage will occur.

When you call, tell the towing service:

- That your vehicle has all-wheel drive and cannot be towed with any wheels in contact with the ground. Your vehicle requires dollies with sling-type or wheel-lift equipment, or a car carrier.
- The make, model, and year of your vehicle.
- Whether you can still move the shift lever.
- If there was an accident, what was damaged.

When the towing service arrives, let the tow operator know that this manual contains towing instructions. The operator may want to see them.



CAUTION:

To help avoid injury to you or others:

- Never let passengers ride in a vehicle that is being towed.
- Never tow faster than safe or posted speeds.
- Never tow with damaged parts not fully secured.
- Never get under your vehicle after it has been lifted.
- Always use separate safety chains on each side when towing a vehicle.

When your vehicle is being towed, have the ignition key off. The steering wheel should be clamped in a straight-ahead position, with a clamping device designed for towing service. Do not use the vehicle's steering column lock for this. The transmission should be in **P** (Park) and the parking brake released.

Don't have your Bravada towed with the wheels in contact with the ground. If your vehicle is being towed with sling-type or wheel-lift equipment, either the front or rear wheels must be supported on a dolly.

If towing your Bravada with a car carrier, block supports may be required to prevent damage to the vehicle.



CAUTION:

A vehicle can fall from a car carrier if it isn't adequately secured. This can cause a collision, serious personal injury and vehicle damage. The vehicle should be tightly secured with chains or steel cables before it is transported. Don't use substitutes (ropes, leather straps, canvas webbing, etc.) that can be cut by sharp edges underneath the towed vehicle. Always use T-hooks inserted in the T-hook slots. Never use J-hooks. They will damage drivetrain and suspension components.

■ *Engine Overheating*

You will find a coolant temperature gage and the warning light about a hot engine on your Oldsmobile's instrument panel.



If Steam Is Coming From Your Engine



CAUTION:

Steam from an overheated engine can burn you badly, even if you just open the hood. Stay away from the engine if you see or hear steam coming from it. Just turn it off and get everyone away from the vehicle until it cools down. Wait until there is no sign of steam or coolant before opening the hood. If you keep driving when your engine is overheated, the liquids in it can catch fire. You or others could be badly burned. Stop your engine if it overheats, and get out of the vehicle until the engine is cool.

Problems on the Road

NOTICE:

If your engine catches fire because you keep driving with no coolant, your vehicle can be badly damaged. The costly repairs would not be covered by your warranty.

If No Steam Is Coming From Your Engine

If you get the overheat warning but see or hear no steam, the problem may not be too serious. Sometimes the engine can get a little too hot when you:

- Climb a long hill on a hot day.
- Stop after high speed driving.
- Idle for long periods in traffic.
- Tow a trailer.

If you get the overheat warning with no sign of steam, try this for a minute or so:

1. Turn off your air conditioner.
2. Turn on your heater to full hot at the highest fan speed and open the window as necessary.
3. If you're in a traffic jam, shift to **N** (Neutral).

If you no longer have the overheat warning, you can drive. Just to be safe, drive slower for about ten minutes. If the warning doesn't come back on, you can drive normally.

If the warning continues, pull over, stop, and park your vehicle right away.

If there's still no sign of steam, push the accelerator until the engine speed is about twice as fast as normal idle speed. Bring the engine speed back to normal idle speed after two or three minutes. Now see if the warning stops. But then, if you still have the warning, **TURN OFF THE ENGINE AND GET EVERYONE OUT OF THE VEHICLE** until it cools down.

You may decide not to lift the hood but to get service help right away.

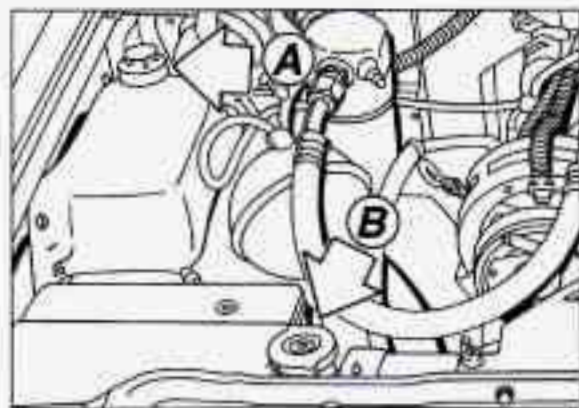

■ Cooling System

When you decide it's safe to lift the hood, here's what you'll see:

- (A) Coolant recovery tank
- (B) Radiator pressure cap

If the coolant inside the coolant recovery tank is boiling, don't do anything else until it cools down.



The coolant level should be at or above the **FULL HOT** mark. If it isn't, you may have a leak in the radiator hoses, heater hoses, radiator, water pump or somewhere else in the cooling system.

 **CAUTION:**

Heater and radiator hoses, and other engine parts, can be very hot. Don't touch them. If you do, you can be burned. Don't run the engine if there is a leak. If you run the engine, it could lose all coolant. That could cause an engine fire, and you could be burned. Get any leak fixed before you drive the vehicle.

NOTICE:

Engine damage from running your engine without coolant isn't covered by your warranty.

If there seems to be no leak, start the engine again. See if the fan speed increases when idle speed is doubled by pushing the accelerator pedal down. If it doesn't, your vehicle needs service. Turn off the engine.

How to Add Coolant to the Coolant Recovery Tank

If you haven't found a problem yet, but the coolant level isn't at or above the **FULL HOT** mark, add a 50/50 mixture of **clean water** (preferably distilled) and a proper antifreeze at the coolant recovery tank. (See *Engine Coolant* in the *Index* for more information about the proper coolant mix.)



CAUTION:

Adding only plain water to your cooling system can be dangerous. Plain water, or some other liquid like alcohol, can boil before the proper coolant mix will. Your vehicle's coolant warning system is set for the proper coolant mix. With plain water or the wrong mix, your engine could get too hot but you wouldn't get the overheat warning. Your engine could catch fire and you or others could be burned. Use a 50/50 mix of **clean water** and a proper antifreeze.

NOTICE:

In cold weather, water can freeze and crack the engine, radiator, heater core and other parts. Use the recommended coolant.

Problems on the Road

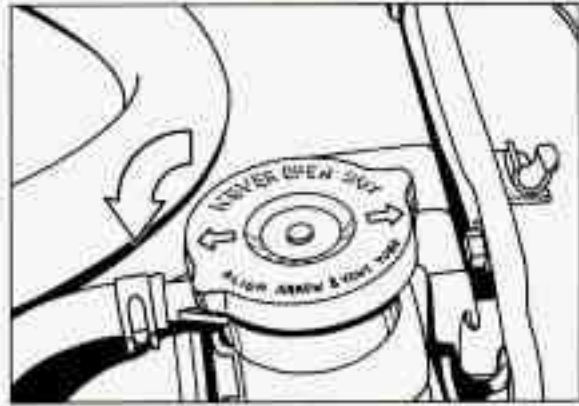

CAUTION:

You can be burned if you spill coolant on hot engine parts. Coolant contains ethylene glycol and it will burn if the engine parts are hot enough. Don't spill coolant on a hot engine.

When the coolant in the coolant recovery tank is at or above the **FULL HOT** mark, start your vehicle.

If the overheat warning continues, there's one more thing you can try. You can add the proper coolant mix directly to the radiator, but be sure the cooling system is cool before you do it.



CAUTION:

Steam and scalding liquids from a hot cooling system can blow out and burn you badly. They are under pressure, and if you turn the radiator pressure cap — even a little — they can come out at high speed. Never turn the cap when the cooling system, including the radiator pressure cap, is hot. Wait for the cooling system and radiator pressure cap to cool if you ever have to turn the pressure cap.

How to Add Coolant to the Radiator:

1. You can remove the radiator pressure cap when the cooling system, including the radiator pressure cap and upper radiator hose, is no longer hot. Turn the pressure cap slowly to the left until it first stops. (Don't press down while turning the pressure cap.) If you hear a hiss, wait for that to stop. A hiss means there is still some pressure left.

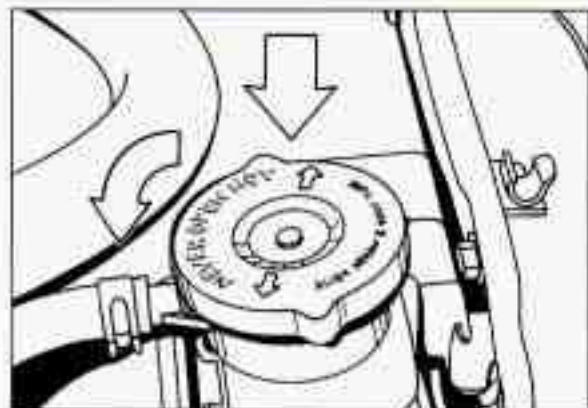

2. Then keep turning the pressure cap, but now push down as you turn it. Remove the pressure cap.



3. Fill the radiator with the proper mix, up to the base of the filler neck.

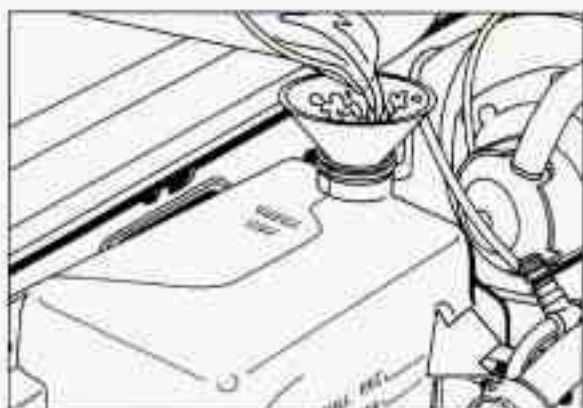

4. Then fill the coolant recovery tank to the **ADD** mark.

Problems on the Road

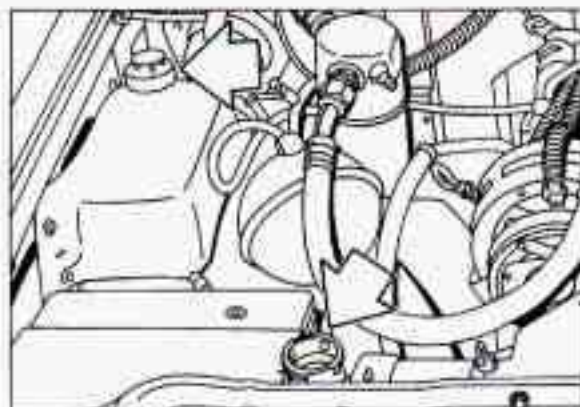

5. Put the cap back on the coolant recovery tank, but leave the radiator pressure cap off.

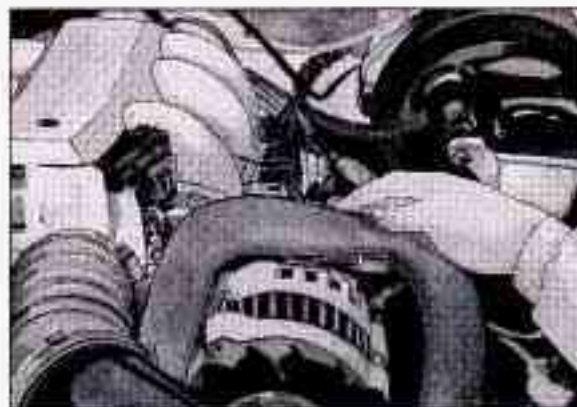

6. Start the engine and let it run until you can feel the upper radiator hose getting hot. Watch out for the engine fan.
7. By this time the coolant level inside the radiator filler neck may be lower. If the level is lower, add more of the proper mix through the filler neck until the level reaches the base of the filler neck.

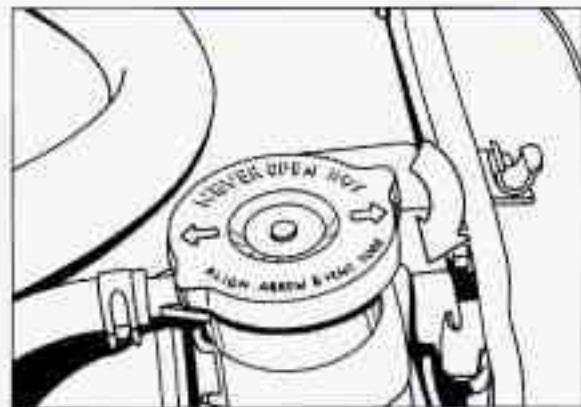

8. Then replace the pressure cap. At any time during this procedure if coolant begins to flow out of the filler neck, reinstall the pressure cap. Be sure the arrows on the pressure cap line up like this.

Engine Fan Noise

This vehicle has a clutched engine cooling fan. When the clutch is engaged, the fan spins faster to provide more air to cool the engine. In most everyday driving conditions the clutch is not engaged. This improves fuel economy and reduces fan noise. Under heavy vehicle loading, trailer towing and/or high outside temperatures, the fan speed increases when the clutch engages. So you may hear an increase in fan noise. This is normal and should not be mistaken as the transmission slipping or making extra shifts. It is merely the cooling system functioning properly.

The fan will slow down when additional cooling is not required and the clutch disengages. You may also hear this fan noise when you start the engine. It will go away as the fan clutch disengages.

■ If a Tire Goes Flat

It's unusual for a tire to "blow out" while you're driving, especially if you maintain your tires properly. If air goes out of a tire, it's much more likely to leak out slowly. But if you should ever have a "blowout," here are a few tips about what to expect and what to do:

If a front tire fails, the flat tire will create a drag that pulls the vehicle toward that side. Take your foot off the accelerator pedal and grip the steering wheel firmly. Steer to maintain lane position, then gently brake to a stop well out of the traffic lane.

A rear blowout, particularly on a curve, acts much like a skid and may require the same correction you'd use in a skid. In any rear blowout, remove your foot from the accelerator pedal. Get the vehicle under control by steering the way you want the vehicle to go. It may be very bumpy and noisy, but you can still steer. Gently brake to a stop, well off the road if possible.

If a tire goes flat, the next section shows how to use your jacking equipment to change a flat tire safely.

■ Changing a Flat Tire

If a tire goes flat, avoid further tire and wheel damage by driving slowly to a level place. Turn on your hazard warning flashers.

Problems on the Road



CAUTION:

Changing a tire can cause an injury. The vehicle can slip off the jack and roll over you or other people. You and they could be badly injured. Find a level place to change your tire. To help prevent the vehicle from moving:

1. Set the parking brake firmly.
2. Put the shift lever in **P** (Park).
3. Turn off the engine.

CAUTION (Continued)

CAUTION (Continued)

To be even more certain the vehicle won't move, you can put chocks at the front and rear of the tire farthest away from the one being changed. That would be the tire on the other side of the vehicle, at the opposite end.

The following steps will tell you how to use the jack and change a tire.

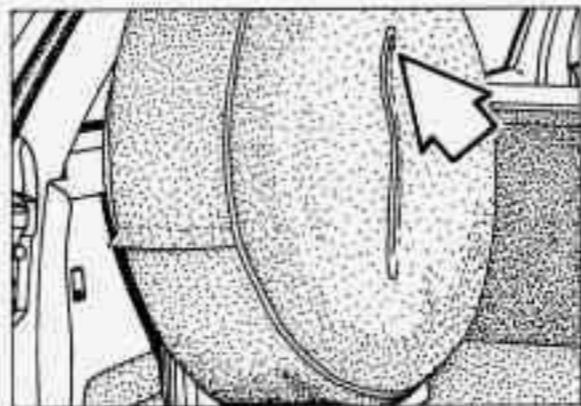

If You Have an Inside-Mounted Spare Tire:

1. Unzip the cover.

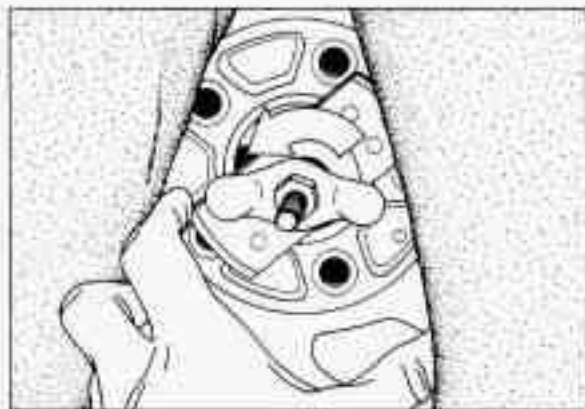

2. Reach inside, and unscrew the wing nut at the center of the wheel. Remove it and the hold-down plate just behind the wing nut. Lift the tire off the mounting shoe and remove the cover. Also remove the bolt hooked to the ring inside the jack storage compartment.

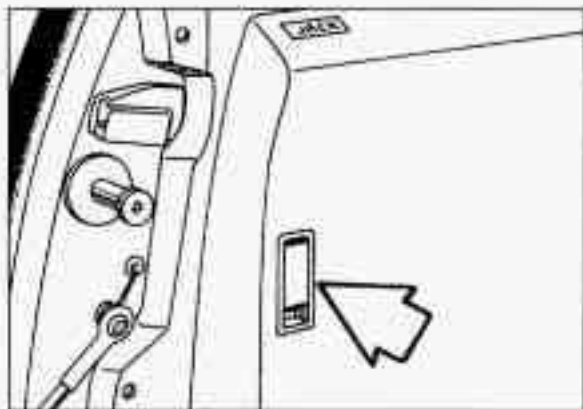

3. Open the jack storage compartment by lifting the latch and removing the cover.

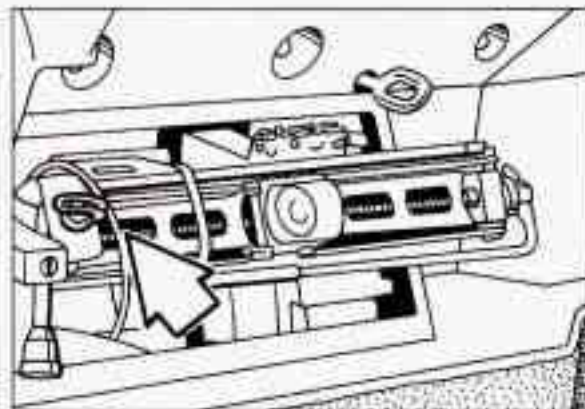

4. Unscrew the wing nut and remove the jack and wheel wrench. Proceed to step 5.

Problems on the Road

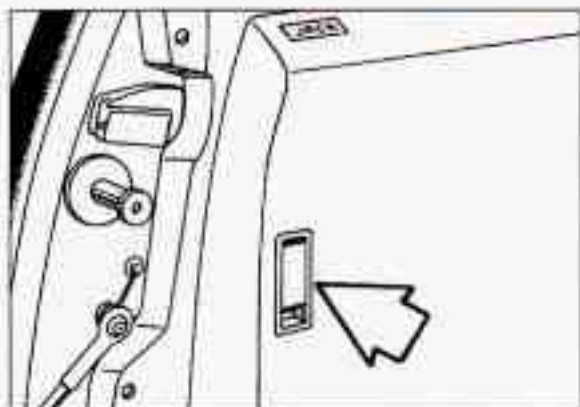

If You Have a Tailgate-Mounted Spare Tire:

1. Open the jack storage compartment by lifting the latch and removing the cover.

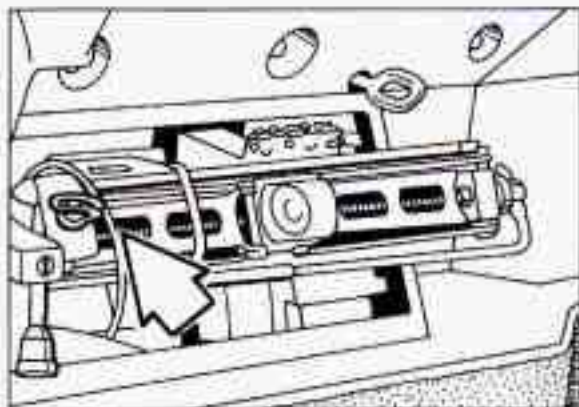

2. Unscrew the wing nut and remove the jack and wheel wrench.

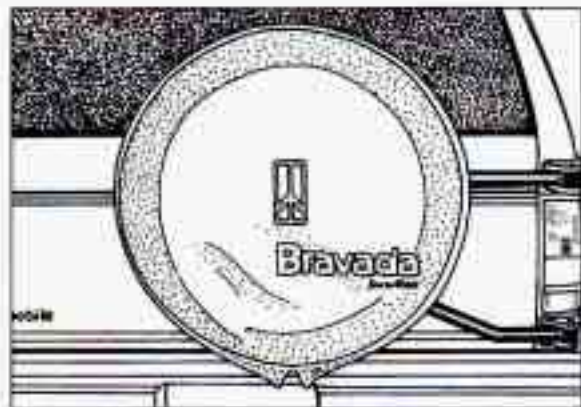

3. Outside the vehicle, make sure the spare tire carrier arm is fully latched to the tailgate. Unzip the tire cover and push it back.

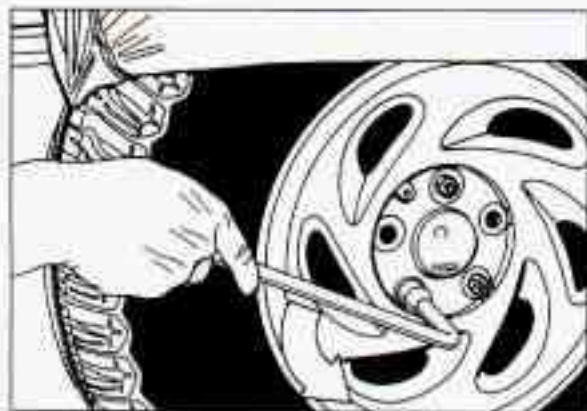

4. Use the wheel wrench to remove the wheel nuts that secure the tire to the carrier. Then lift the tire off the mounting bracket.

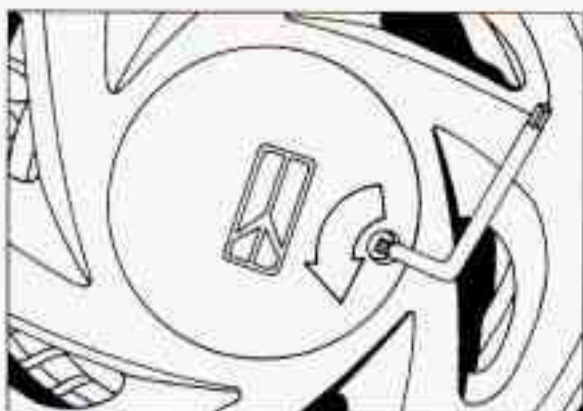

For Both Mounting Systems:

5. Put the spare tire near the flat one.
6. Using the Torx® head wrench supplied with the vehicle and stored in the glove box, remove the wheel nut cover.

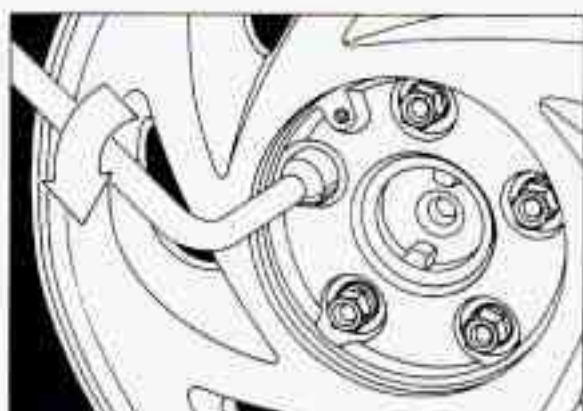

7. Using the wheel wrench, loosen all the wheel nuts. Don't remove them yet.

Problems on the Road

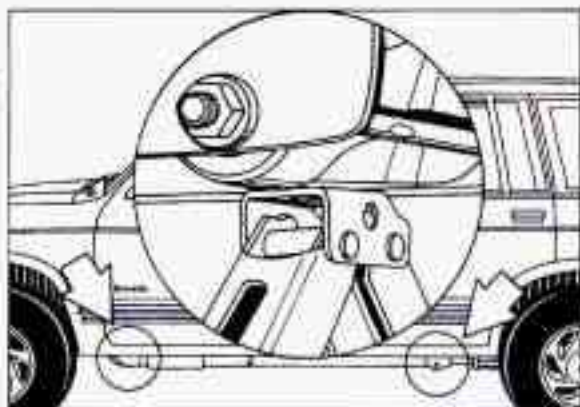

8. Rotate the jack handle clockwise to raise the jack head a little.
9. There is a hole in the vehicle's frame for the head of the jack to fit into, near the wheel to be removed. Position the jack there.



CAUTION:

Getting under a vehicle when it is jacked up is dangerous. If the vehicle slips off the jack, you could be badly injured or killed. Never get under a vehicle when it is supported only by a jack.

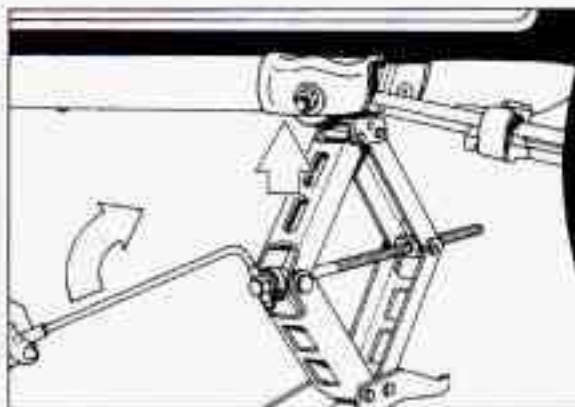

10. Raise the vehicle by rotating the jack handle clockwise. Raise the vehicle far enough off the ground so there is enough room for the spare tire to fit.

NOTICE:

Raising your vehicle with the jack improperly positioned will damage the vehicle or may allow the vehicle to fall off the jack. Be sure to fit the jack lift head into the proper location before raising your vehicle.

11. Remove all wheel nuts and take off the flat tire.



CAUTION:

Rust or dirt on the wheel, or on the parts to which it is fastened, can make the wheel nuts become loose after a time. The wheel could come off and cause an accident. When you change a wheel, remove any rust or dirt from the places where the wheel attaches to the vehicle. In an emergency, you can use a cloth or a paper towel to do this; but be sure to use a scraper or wire brush later, if you need to, to get all the rust or dirt off.

12. Remove any rust or dirt from the wheel bolts, mounting surfaces and spare wheel. Place the spare on the wheel mounting surface.

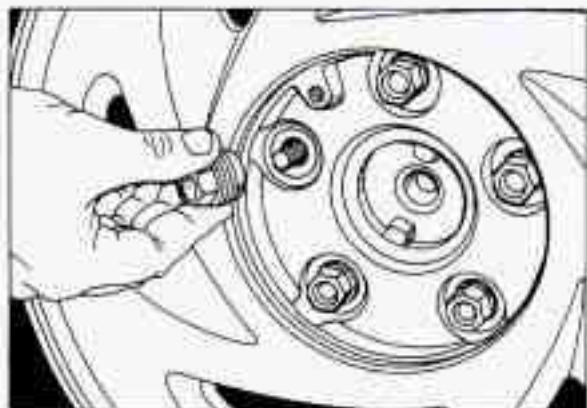

⚠ CAUTION:

Never use oil or grease on studs or nuts. If you do, the nuts might come loose. Your wheel could fall off, causing a serious accident.

13. Replace the wheel nuts with the rounded end of the nuts toward the wheel. Tighten each nut by hand until the wheel is held against the hub.

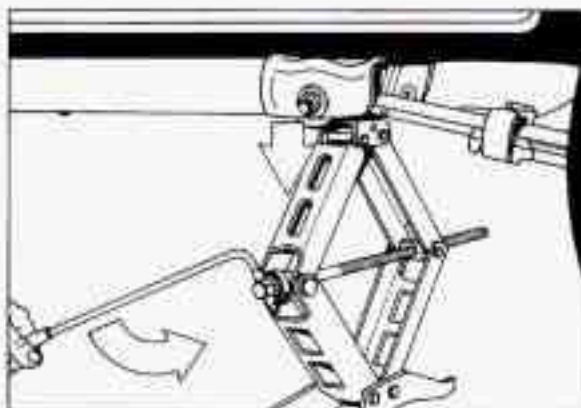

14. Lower the vehicle by rotating the jack handle counterclockwise. Lower the jack completely.

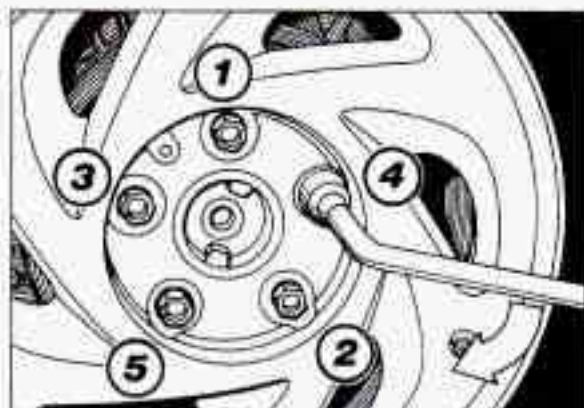

15. Tighten the wheel nuts firmly in a crisscross sequence as shown.

⚠ CAUTION:

Incorrect wheel nuts or improperly tightened wheel nuts can cause the wheel to become loose and even come off. This could lead to an accident. Be sure to use the correct wheel nuts. If you have to replace them, be sure to get the right kind. Stop somewhere as soon as you can and have the nuts tightened with a torque wrench to 90 pound-feet (130 N•m).

Problems on the Road

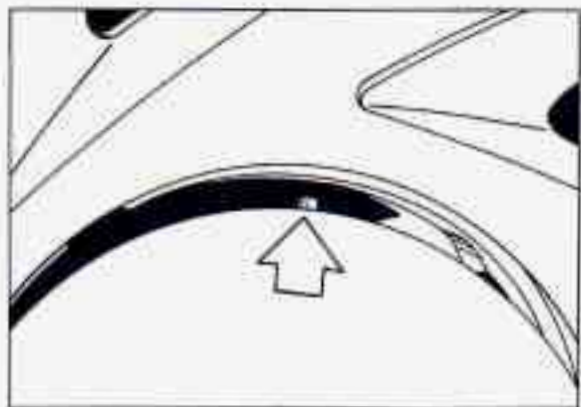

16. Replace the wheel nut cover on the spare wheel. Be sure to insert the pin on the wheel cover into the hole in the wheel. Screw the cover in place using the Torx® head wrench.
17. Lower the jack head completely by rotating the jack handle counterclockwise. If you have an inside-mounted spare tire, return the jack and wheel wrench to their storage compartment and secure them with the wing nut. Replace the jack storage compartment cover.
18. Fasten the flat tire where the spare was stored. If you have a tailgate-mounted spare tire carrier, tighten firmly. Push and pull to make sure it is not loose. As soon as possible, tighten the nuts to 22-32 pound-feet (30-40 N•m) torque.

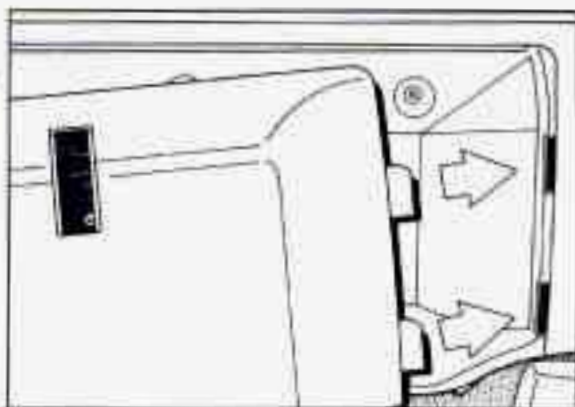

19. If you have a tailgate-mounted spare tire, return the jack and wheel wrench to their storage compartment and replace the jack storage compartment cover. Insert the cover tabs into the trim panel, align the cover and fasten the latch.



CAUTION:

Storing a jack, a tire or other equipment in the passenger compartment of the vehicle could cause injury. In a sudden stop or collision, loose equipment could strike someone. Store all these in the proper place.

■ *If You're Stuck: In Sand, Mud, Ice or Snow*

What you **don't** want to do when your vehicle is stuck is to spin your wheels. The method known as "rocking" can help you get out when you're stuck, but you must use caution.



CAUTION:

If you let your tires spin at high speed, they can explode and you or others could be injured. And, the transmission or other parts of the vehicle can overheat. That could cause an engine compartment fire or other damage. When you're stuck, spin the wheels as little as possible. Don't spin the wheels above 35 mph (55 km/h) as shown on the speedometer.

NOTICE:

Spinning your wheels can destroy parts of your vehicle as well as the tires. If you spin the wheels too fast while shifting your transmission back and forth, you can destroy your transmission.

Rocking Your Vehicle to Get it Out:

First, turn your steering wheel left and right. That will clear the area around your front wheels. Then shift back and forth between **R** (Reverse) and a forward gear, spinning the wheels as little as possible. Release the accelerator pedal while you shift, and press lightly on the accelerator pedal when the transmission is in gear. If that doesn't get you out after a few tries, you may need to be towed out. If you do need to be towed out, see *Towing Your Truck* in the *Index*.

Notes



Here you will find information about the care of your Oldsmobile. This part begins with service and fuel information, and then it shows how to check important fluid and lubricant levels. There is also technical information about your vehicle, and a section devoted to its appearance care.

Part 6

Service & Appearance Care

Service	162
Fuel	163
Hood Release	165
Engine Oil	168
Air Cleaner	171
Transmission Fluid	172
Axles/Transfer Case	174
Engine Coolant	174
Power Steering Fluid	176
Windshield Washer Fluid	177
Brakes	178
Battery	180
Bulb Replacement	181
Windshield Wiper Blade Replacement	182
Loading Your Vehicle	183
Tires	185
Appearance Care	190
Vehicle Identification Number (VIN)	195
Add-On Electrical Equipment	196
Fuses & Circuit Breakers	196
Capacities & Specifications	199
Normal Maintenance Replacement Parts	200
Fluids & Lubricants	201
Replacement Bulbs	202

Service & Appearance Care



■ Service

Your Oldsmobile dealer knows your vehicle best and wants you to be happy with it. We hope you'll go to your dealer for all your service needs. You'll get genuine GM parts and GM-trained and supported service people.

We hope you'll want to keep your GM vehicle all GM. Genuine GM parts have one of these marks.

Doing Your Own Service Work

If you want to do some of your own service work, you'll want to get the proper Oldsmobile Service Manual. It tells you much more about how to service your Oldsmobile than this manual can. To order the proper service manual, see *Service Publications* in the *Index*.

You should keep a record with all parts receipts and list the mileage and the date of any service work you perform. See *Maintenance Record* in the *Index*.



CAUTION:

You can be injured if you try to do service work on a vehicle without knowing enough about it.

- Be sure you have sufficient knowledge, experience, and the proper replacement parts and tools before you attempt any vehicle maintenance task.
- Be sure to use the proper nuts, bolts and other fasteners. "English" and "metric" fasteners can be easily confused. If you use the wrong fasteners, parts can later break or fall off. You could be hurt.

NOTICE:

If you try to do your own service work without knowing enough about it, your vehicle could be damaged.

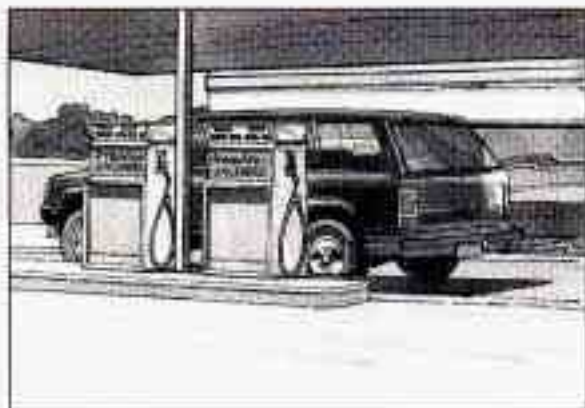

■ Fuel

Use regular unleaded gasoline rated at 87 octane or higher. Use premium unleaded gasoline rated at 91 octane or higher for high power performance, when towing a trailer or with a high payload requirement. But when operating with a light load as a normal condition, you may use middle grade or regular unleaded gasolines.

The gasoline you use should meet specifications ASTM D4814 in the U.S. and CGSB 3.5-92 in Canada. These fuels should have the proper additives, so you should not have to add anything to the fuel.

In the U.S. and Canada, it's easy to be sure you get the right kind of gasoline (unleaded). You'll see "UNLEADED"

right on the pump. And only unleaded nozzles will fit into your vehicle's filler neck.

Be sure the posted octane is at least 91 for premium, 89 for middle grade and 87 for regular. If the octane is less than 87, you may get a heavy knocking noise when you drive. If it's bad enough, it can damage your engine.

If you're using fuel rated at 91 octane or higher and you still hear heavy knocking, your engine needs service. But don't worry if you hear a little pinging noise when you're accelerating or driving up a hill. That's normal, and you don't have to buy a higher octane fuel to get rid of it. It's the heavy, constant knock that means you have a problem.

What about gasoline with blending materials that contain oxygen (oxygenates), such as MTBE or alcohol?

MTBE is "methyl tertiary-butyl ether." Fuel that is no more than 15% MTBE is fine for your vehicle.

Ethanol is ethyl or grain alcohol. Properly-blended fuel that is no more

than 10% **ethanol** is fine for your vehicle.

Methanol is methyl or wood alcohol.

NOTICE:

Fuel that is more than 5% **methanol** is bad for your vehicle. Don't use it. It can corrode metal parts in your fuel system and also damage plastic and rubber parts. That damage wouldn't be covered under your warranty. And even at 5% or less, there must be "cosolvents" and corrosion preventers in this fuel to help avoid these problems.

Gasolines for Cleaner Air

Your use of gasoline with deposit control additives will help prevent deposits from forming in your engine and fuel system. That helps keep your engine in tune and your emission control system working properly. It's good for your vehicle, and you'll be doing your part for cleaner air.

Many gasolines are now blended with oxygenates. General Motors

Service & Appearance Care

recommends that you use gasolines with these blending materials, such as MTBE and ethanol. By doing so, you can help clean the air, especially in those parts of the country that have high carbon monoxide levels.

In addition, some gasoline suppliers are now producing reformulated gasolines. These gasolines are specially designed to reduce vehicle emissions. General Motors recommends that you use reformulated gasoline. By doing so, you can help clean the air, especially in those parts of the country that have high ozone levels.

You should ask your service station operators if their gasolines contain deposit control additives and oxygenates, and if they have been reformulated to reduce vehicle emissions.



■ *Fuels in Foreign Countries*

If you plan on driving in another country outside the U.S. or Canada, unleaded fuel may be hard to find. Do not use leaded gasoline. If you use even one tankful, your emission controls won't work well or at all. With continuous use, spark plugs can get fouled, the exhaust system can corrode, and your engine oil can deteriorate quickly. Your vehicle's oxygen sensor will be damaged. All of that means costly repairs that wouldn't be covered by your warranty.

To check on fuel availability, ask an auto club, or contact a major oil company that does business in the country where you'll be driving.

You can also write us at the following address for advice. Just tell us where you're going and give your Vehicle Identification Number (VIN).

General Motors Overseas Distribution
Corporation
North American Export Sales (NAES)
1908 Colonel Sam Drive
Oshawa, Ontario
L1H 8P7

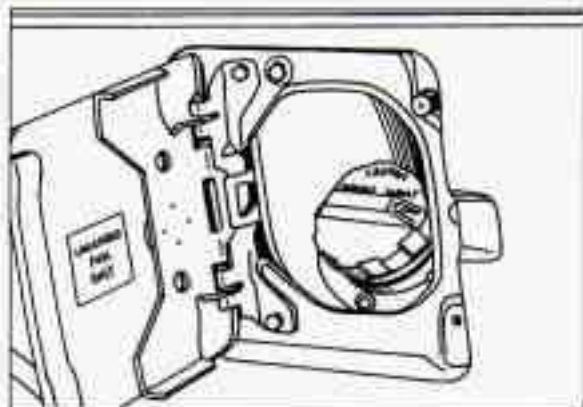

■ *Filling Your Tank*

Fuel Capacity: 20 U.S. Gallons (76 L).
Use unleaded fuel only.

CAUTION:

Gasoline vapor is highly flammable. It burns violently, and that can cause very bad injuries. Don't smoke if you're near gasoline or refueling your vehicle. Keep sparks, flames, and smoking materials away from gasoline.

The cap is behind a hinged door on the left side of your vehicle.
To take off the cap, turn it slowly to the left (counterclockwise).

CAUTION:

If you get gasoline on you and then something ignites it, you could be badly burned. Gasoline can spray out on you if you open the fuel filler cap too quickly. This spray can happen if your tank is nearly full, and is more likely in hot weather. Open the fuel filler cap slowly and wait for any "hiss" noise to stop. Then unscrew the cap all the way.

Be careful not to spill gasoline. Clean gasoline from painted surfaces as soon as possible. See *Cleaning the Outside of Your Oldsmobile* in the *Index*.

When you put the cap back on, turn it to the right until you hear a clicking noise.

NOTICE:

If you need a new cap, be sure to get the right type. Your dealer can get one for you. If you get the wrong type, it may not fit or have proper venting, and your fuel tank and emissions system might be damaged.

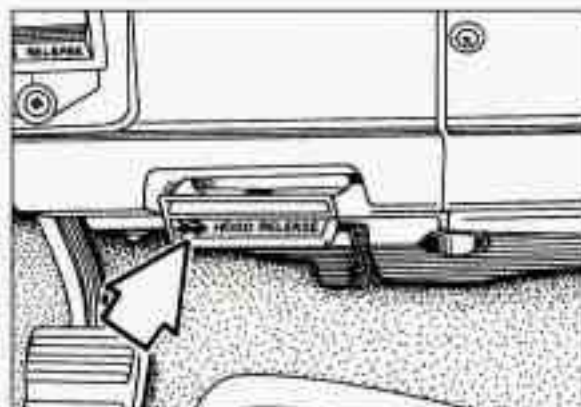

■ *Checking Things Under the Hood*

The following sections tell you how to check fluids, lubricants and important parts under the hood.

■ *Hood Release*

To open the hood, first pull the **HOOD RELEASE** handle inside the vehicle.

Service & Appearance Care

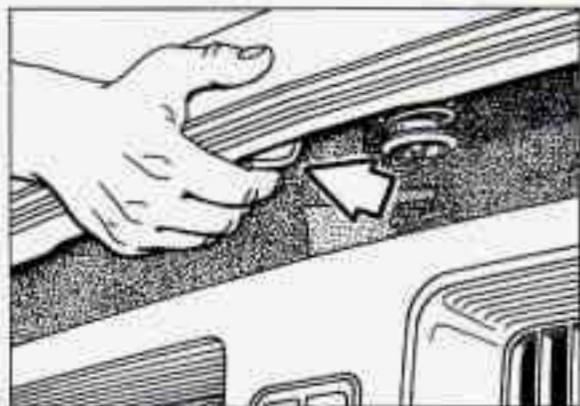

Then go to the front of the vehicle and pull up on the underhood release. Lift the hood.

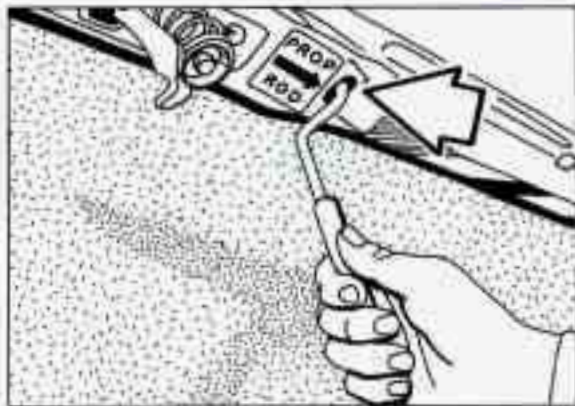

The prop rod may be hot due to increased engine temperatures under the hood. Use the prop rod sleeve when handling the prop rod.

Press down on the prop rod to release it from its storage clip. Then put the end of the prop rod into the slot in the underside of the hood.



CAUTION:

Things that burn can get on hot engine parts and start a fire. These include liquids like gasoline, oil, coolant, brake fluid, windshield washer and other fluids, and plastic or rubber. You or others could be burned. Be careful not to drop or spill things that will burn onto a hot engine.

Before closing the hood, be sure all the filler caps are on properly. Then lift the hood to relieve pressure on the prop rod. Remove the prop rod from the slot in the hood and return the prop to its retainer. Then just let the hood down and close it firmly.

Underhood Light

Your underhood light will come on whenever you open the hood.

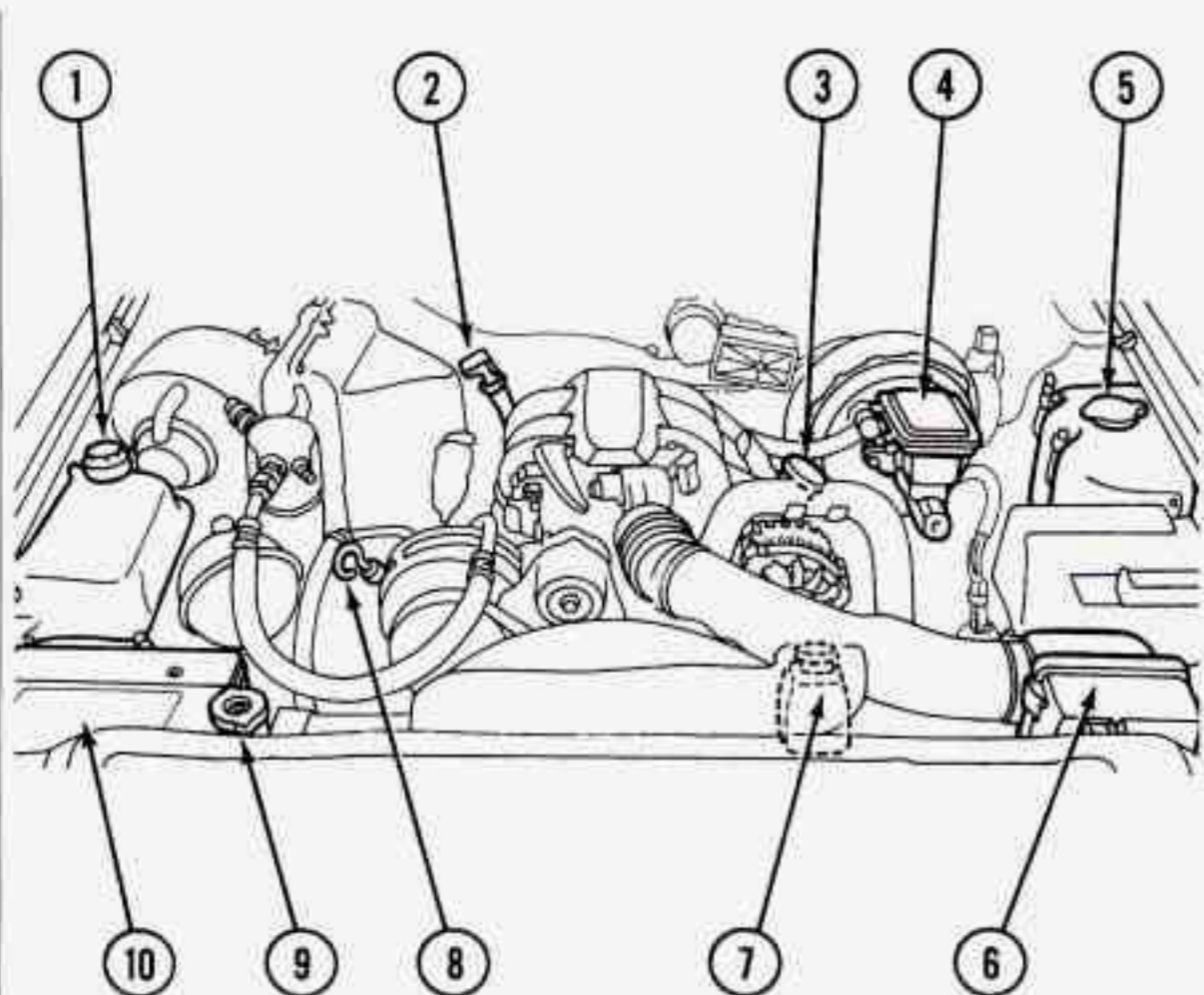

4.3L V6 Engine (CODE W)

When you open the hood, you'll see:

1. Engine Coolant Recovery Tank
2. Automatic Transmission Dipstick
3. Engine Oil Fill Cap
4. Brake Fluid Reservoir
5. Windshield Washer Fluid Reservoir
6. Air Cleaner
7. Power Steering Fluid Reservoir
8. Engine Oil Dipstick
9. Radiator Pressure Cap
10. Battery

Service & Appearance Care

■ Engine Oil

It's a good idea to check your engine oil every time you get fuel. In order to get an accurate reading, the oil must be warm and the vehicle must be on level ground.

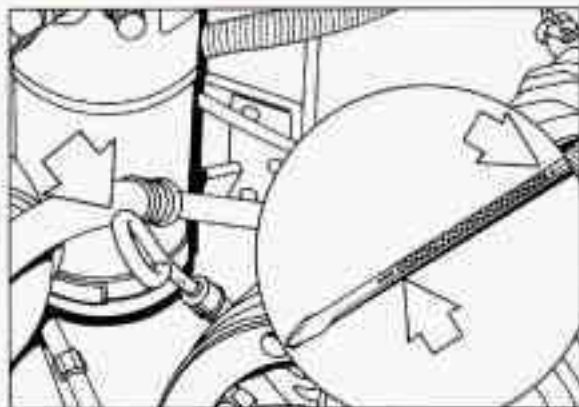

Turn off the engine and give the oil a few minutes to drain back into the oil pan. If you don't, the oil dipstick might not show the actual level.

To Check Engine Oil

Pull out the dipstick and clean it with a paper towel or cloth, then push it back in all the way. Remove it again, keeping the tip lower.

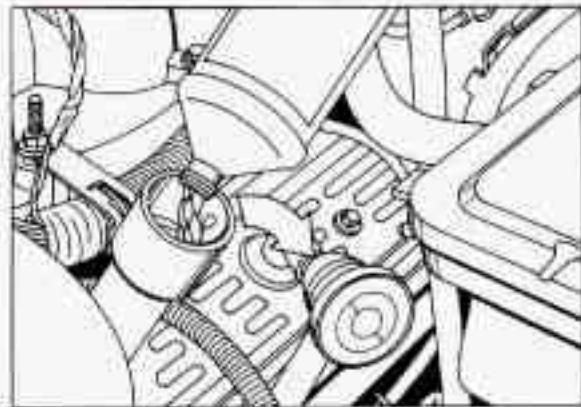

When to Add Oil

If the oil is at or below the **ADD** line, then you'll need to add some oil. But you must use the right kind. This section explains what kind of oil to use. For crankcase capacity, see *Capacities & Specifications* in the *Index*.

NOTICE:

Don't add too much oil. If your engine has so much oil that the oil level gets above the cross-hatched area that shows the proper operating range, your engine could be damaged.

Just fill it enough to put the level somewhere in the proper operating range. Push the dipstick all the way back in when you're through.



What Kind of Oil to Use

Beginning midyear 1993, oils of the proper quality for your vehicle will be identified with this new "starburst" symbol. The "starburst" symbol indicates that the oil has been certified by the American Petroleum Institute (API), and is preferred for use in your gasoline engine.

You should look for this on the front of the oil container, and use only oils that display this new symbol.

You should also use the proper viscosity oil for your vehicle, as shown in the following chart:

RECOMMENDED SAE VISCOSITY GRADE ENGINE OILS

FOR BEST FUEL ECONOMY AND COLD STARTING, SELECT THE LOWEST SAE VISCOSITY GRADE OIL FOR THE EXPECTED TEMPERATURE RANGE.

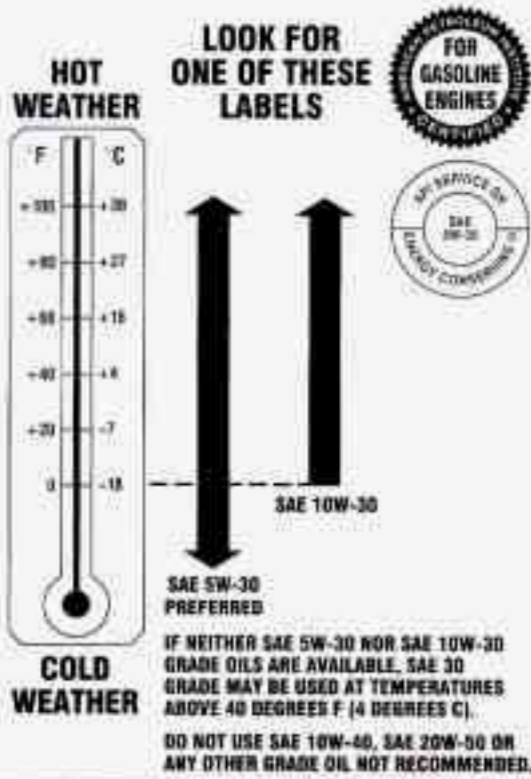

As shown in the chart, SAE 5W-30 is best for your vehicle. However, you can use SAE 10W-30 if it's going to be 0°F (-18°C) or above. These numbers on an oil container show its viscosity, or

thickness. Do not use other viscosity oils, such as SAE 10W-40 or SAE 20W-50.

If you cannot find oils with the new "starburst" symbol on the front of the container, you should look for and use oils containing the following three things:

- **SH or SG**

"SH" or "SG" must be on the oil container, either by itself or combined with other quality designations, such as "SH/CD," "SH,SG,CD," "SG/CD," etc. These letters show American Petroleum Institute (API) levels of quality.

- **SAE 5W-30**

- **Energy Conserving II**

Oils with these words on the container will help you save fuel.

These three things are usually included in a doughnut shaped logo (symbol) on most containers. If you cannot find oils with the "starburst" symbol, you should look for oils with the doughnut shaped symbol, containing the three things noted above.

Service & Appearance Care



NOTICE:

If you use oils that do not have either the "starburst" symbol or an API SH or SG designation, you can cause engine damage not covered by your warranty.

GM Goodwrench® oil (in Canada, GM Engine Oil) meets all the requirements for your vehicle.

Engine Oil Additives

Don't add anything to your oil. Your Oldsmobile dealer is ready to advise if you think something should be added.

When to Change Engine Oil

See if any one of these is true for you:

- Most trips are less than 4 miles (6 km).
- It's below freezing outside and most trips are less than 10 miles (16 km).
- The engine is at low speed most of the time (as in door-to-door delivery, or in stop-and-go traffic).
- You tow a trailer often.
- Most trips are through dusty places.
- The vehicle is frequently operated off-road.

If any one of these is true for your vehicle, then you need to change your **oil and filter** every 3,000 miles (5 000 km) or 3 months — whichever comes first.

Engine Coolant Heater (Engine Block Heater)

An engine coolant heater can be a big help if you have to park outside in very cold weather, 0°F (-18°C) or colder. If your vehicle has this option, see *Engine Coolant Heater* in the *Index*.

What to Do with Used Oil

Did you know that used engine oil contains certain elements that may be unhealthy for your skin and could even cause cancer? Don't let used oil stay on your skin for very long. Clean your skin and nails with soap and water, or a good hand cleaner. Wash or properly throw away clothing or rags containing used engine oil. (See the manufacturer's warnings about the use and disposal of oil products.)

Used oil can be a real threat to the environment. If you change your own oil, be sure to drain all free-flowing oil from the filter before disposal. Don't ever dispose of oil by putting it in the trash, pouring it on the ground, into sewers, or into streams or bodies of water. Instead, recycle it by taking it to a place that collects used oil. If you have a problem properly disposing of your used oil, ask your dealer, a service station or a local recycling center for help.

■ Air Cleaner

Refer to the Maintenance Schedule to determine when to replace the air filter and the crankcase ventilation filter.

See *Scheduled Maintenance Services* in the *Index*.



CAUTION:

Operating the engine with the air cleaner off can cause you or others to be burned. The air cleaner not only cleans the air, it stops flame if the engine backfires. If it isn't there, and the engine backfires, you could be burned. Don't drive with it off, and be careful working on the engine with the air cleaner off.

NOTICE:

If the air cleaner is off, a backfire can cause a damaging engine fire. And, dirt can easily get into your engine, which will damage it. Always have the air cleaner in place when you're driving.

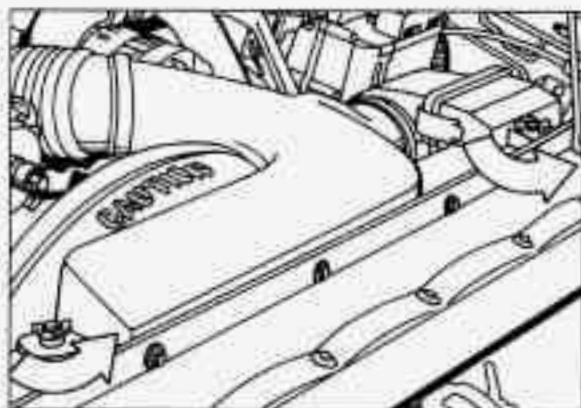

To Check or Replace the Air Cleaner Filter:

1. Loosen the two wing screws.
2. Lift the air cleaner filter housing.

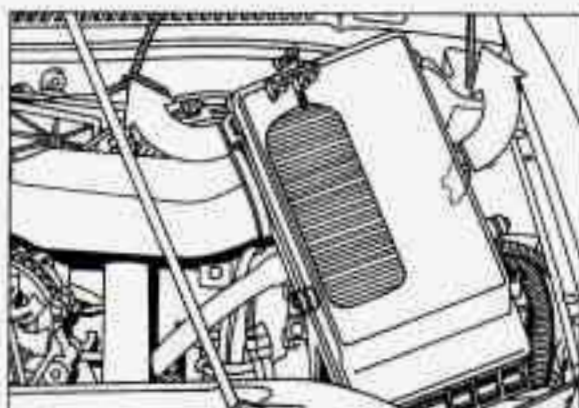

3. Unsnap the two clips on the housing cover and remove the cover.

Service & Appearance Care

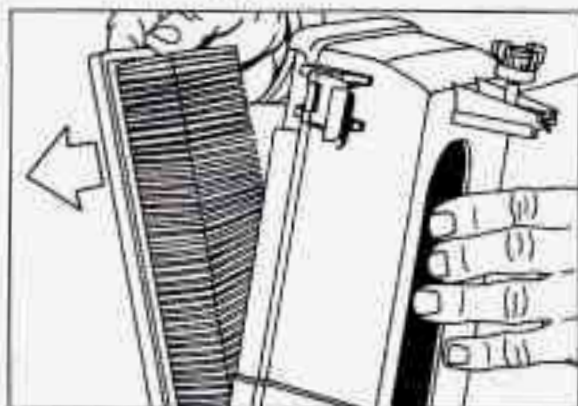

4. Remove the air cleaner filter from the housing.
5. Install a new air cleaner filter and reverse steps 1-3.

■ Automatic Transmission Fluid

When to Check and Change

A good time to check your automatic transmission fluid level is when the engine oil is changed. Refer to the Maintenance Schedule to determine when to change your fluid. See *Scheduled Maintenance Services* in the *Index*.

How to Check

Because this operation can be a little difficult, you may choose to have this done at an Oldsmobile dealership Service Department.

If you do it yourself, be sure to follow all the instructions here, or you could get a false reading on the dipstick.

NOTICE:

Too much or too little fluid can damage your transmission. Too much can mean that some of the fluid could come out and fall on hot engine parts or exhaust system, starting a fire. Be sure to get an accurate reading if you check your transmission fluid.

Wait at least 30 minutes before checking the transmission fluid level if you have been driving:

- When outside temperatures are above 90°F (32°C).
- At high speed for quite a while.
- In heavy traffic — especially in hot weather.

- While pulling a trailer.

To get the right reading, the fluid should be at normal operating temperature, which is 180°F to 200°F (82°C to 93°C).

To Check Transmission Fluid Hot:

Get the vehicle warmed up by driving about 15 miles (24 km) when outside temperatures are above 50°F (10°C). If it's colder than 50°F (10°C), drive the vehicle in **D** (3rd Gear) until the engine temperature gage moves and then remains steady for ten minutes. Then follow the hot check procedures.

To Check Transmission Fluid Cold:

A cold check is made after the vehicle has been sitting for eight hours or more with the engine off and is used only as a reference. Let the engine run at idle for five minutes if outside temperatures are 50°F (10°C) or more. If it's colder than 50°F (10°C), you may have to idle the engine longer. Should the fluid level be low during a cold check, you **must** perform a hot check before adding fluid. This will give you a more accurate reading of the fluid level.

To Check the Fluid Hot or Cold:

- Park your vehicle on a level place.
- With the parking brake applied, place the shift lever in **P** (Park).
- With your foot on the brake pedal, move the shift lever through each gear range, pausing for about three seconds in each range. Then, position the shift lever in **P** (Park).
- Let the engine run at idle for three minutes or more.

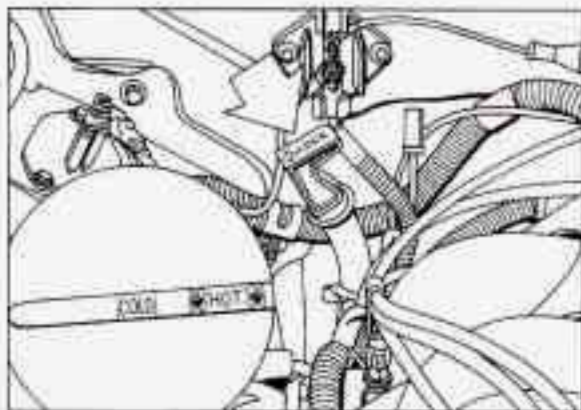

Then, Without Shutting off the Engine, Follow These Steps:

1. Flip the handle up and then pull out the dipstick and wipe it with a clean rag or paper towel.
2. Push it back in all the way, wait three seconds and then pull it back out again.
3. Check both sides of the dipstick, and read the lower level. The fluid level must be in the **COLD** area for a cold check or in the **HOT** area or cross-hatched area for a hot check.
4. If the fluid level is in the acceptable range, push the dipstick back in all the way; then flip the handle down to lock the dipstick in place.

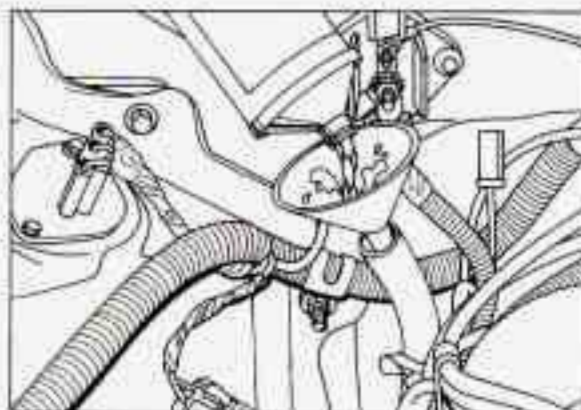

How to Add Fluid

Refer to the Maintenance Schedule to determine what kind of transmission fluid to use. See *Recommended Fluids & Lubricants* in the *Index*.

If the fluid level is low, add only enough of the proper fluid to bring the level up to the **COLD** area for a cold check or the **HOT** area for a hot check. It doesn't take much fluid, generally less than a pint (0.5L). **Don't overfill.** We recommend you use only fluid labeled DEXRON[®]-III or DEXRON[®]-III-E, because fluids with that label are made especially for your automatic transmission. Damage caused by fluid other than DEXRON[®]-III or DEXRON[®]-III-E is not covered by your new vehicle warranty.

Service & Appearance Care

- After adding fluid, recheck the fluid level as described under *How to Check*.
- When the correct fluid level is obtained, push the dipstick back in all the way.

■ Rear Axle

When to Check and Change Lubricant

Refer to the Maintenance Schedule to determine how often to check the lubricant and when to change it. See *Scheduled Maintenance Services* in the *Index*.

How to Check Lubricant

If the level is below the bottom of the filler plug hole, you'll need to add some lubricant. Add enough lubricant to raise the level to the bottom of the filler plug hole.

What to Use

Refer to the Maintenance Schedule to determine what kind of lubricant to use. See *Recommended Fluids & Lubricants* in the *Index*.

■ All-Wheel Drive

Transfer Case

When to Check Lubricant

Refer to the Maintenance Schedule to determine how often to check the lubricant. See *Periodic Maintenance Inspections* in the *Index*.

How to Check Lubricant

If the level is below the bottom of the filler plug hole, you'll need to add some lubricant. Add enough lubricant to raise the level to the bottom of the filler plug hole.

What to Use

Refer to the Maintenance Schedule to determine what kind of lubricant to use. See *Recommended Fluids & Lubricants* in the *Index*.

Front Axle

When to Check and Change Lubricant

Refer to the Maintenance Schedule to determine how often to check the lubricant and when to change it. See *Scheduled Maintenance Services* in the *Index*.

How to Check Lubricant

If the level is below the bottom of the filler plug hole, you'll need to add some lubricant. Add enough lubricant to raise the level to the bottom of the filler plug hole.

What to Use

Refer to the Maintenance Schedule to determine what kind of lubricant to use. See *Recommended Fluids & Lubricants* in the *Index*.

■ Engine Coolant

The following explains your cooling system and how to add coolant when it is low. If you have a problem with engine overheating, see *Engine Overheating* in the *Index*.

The proper coolant for your Oldsmobile will:

- Give freezing protection down to -34°F (-37°C).
- Give boiling protection up to 258°F (125°C).
- Protect against rust and corrosion.
- Help keep the proper engine temperature.

- Let the warning lights and gages work as they should.

What to Use

Use a mixture of one-half **clean water** (preferably distilled) and one-half antifreeze that meets "GM Specification 6038-M," which won't damage aluminum parts. If you use this mixture, you don't need to add anything else.



CAUTION:

Adding only plain water to your cooling system can be dangerous. Plain water, or some other liquid like alcohol, can boil before the proper coolant mix will. Your vehicle's coolant warning system is set for the proper coolant mix. With plain water or the wrong mix, your engine could get too hot but you wouldn't get the overheat warning. Your engine could catch fire and you or others could be burned. Use a 50/50 mix of clean water and a proper antifreeze.

NOTICE:

If you use an improper coolant mix, your engine could overheat and be badly damaged. The repair cost wouldn't be covered by your warranty. Too much water in the mix can freeze and crack the engine, radiator, heater core and other parts.

Some conditions, such as air trapped in the cooling system, can affect the coolant level in the radiator. Check the coolant level when the engine is cold and follow the steps under *Adding Coolant* for the proper way to add coolant.

If you have to add coolant more than four times a year, have your dealer check your cooling system.

NOTICE:

If you use the proper coolant, you don't have to add extra inhibitors or additives which claim to improve the system. These can be harmful.

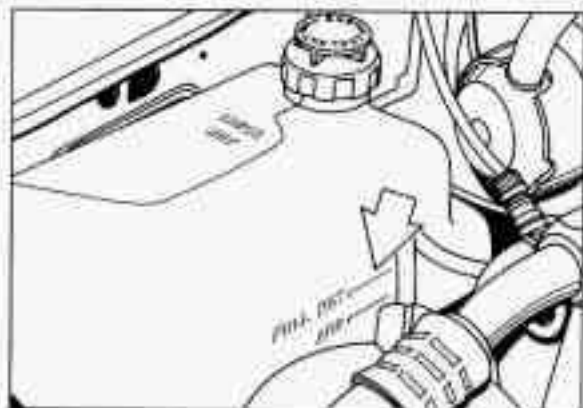

Adding Coolant

To Check Coolant

When your engine is cold, the coolant level should be at **ADD**, or a little higher. When your engine is warm, the level should be up to **FULL HOT**, or a little higher.

Service & Appearance Care

To Add Coolant

If you need more coolant, add the proper mix at the coolant recovery tank.



CAUTION:

Turning the radiator pressure cap when the engine and radiator are hot can allow steam and scalding liquids to blow out and burn you badly. With the coolant recovery tank, you will almost never have to add coolant at the radiator. Never turn the radiator pressure cap — even a little — when the engine and radiator are hot.

Add coolant mix at the recovery tank, but be careful not to spill it.



CAUTION:

You can be burned if you spill coolant on hot engine parts. Coolant contains ethylene glycol, and it will burn if the engine parts are hot enough. Don't spill coolant on a hot engine.

■ Radiator Pressure Cap

NOTICE:

Your radiator cap is a 15 psi (105 kPa) pressure-type cap and must be tightly installed to prevent coolant loss and possible engine damage from overheating. Be sure the arrows on the cap line up with the overflow tube on the radiator filler neck.

When you replace your radiator pressure cap, an AC[®] cap is recommended.

■ Thermostat

Engine coolant temperature is controlled by a thermostat in the engine coolant system. The thermostat stops the flow of coolant through the radiator until the coolant reaches a preset temperature.

When you replace your thermostat, an AC[®] thermostat is recommended.



■ Power Steering Fluid

How To Check Power Steering Fluid

Unscrew the cap and wipe the dipstick with a clean rag. Replace the cap and completely tighten it. Then remove the cap again and look at the fluid level on the dipstick.

- When the engine compartment is hot, the level should be at the **HOT** mark.
- When the engine compartment is cool, the level should be at the **FULL COLD** mark.

What to Add

Refer to the Maintenance Schedule to determine what kind of fluid to use. See *Recommended Fluids & Lubricants* in the *Index*.

NOTICE:

When adding power steering fluid or making a complete fluid change, always use the proper fluid. Failure to use the proper fluid can cause leaks and damage hoses and seals.

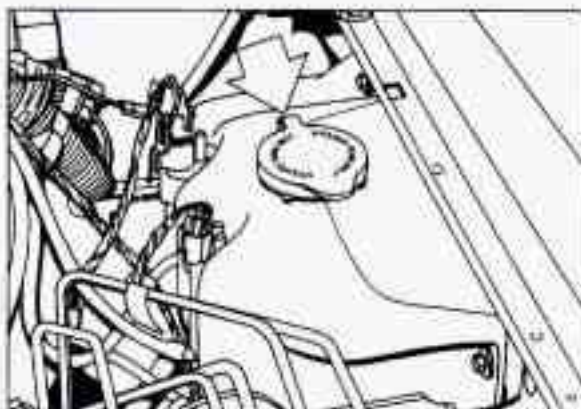

■ Windshield Washer Fluid

To Add

Open the cap labeled **WASHER FLUID ONLY**. Add washer fluid until the bottle is full.

NOTICE:

- When using concentrated washer fluid, follow the manufacturer's instructions for adding water.
- Don't mix water with ready-to-use washer fluid. Water can cause the solution to freeze and damage your washer fluid tank and other parts of the washer system. Also, water doesn't clean as well as washer fluid.
- Fill your washer fluid tank only $\frac{3}{4}$ full when it's very cold. This allows for expansion, which could damage the tank if it is completely full.
- Don't use radiator antifreeze in your windshield washer. It can damage your washer system and paint.

Service & Appearance Care

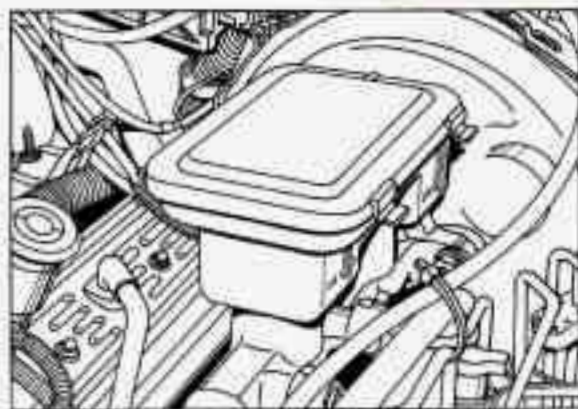

■ Brakes

Brake Master Cylinder

Your brake master cylinder is here. It is filled with DOT-3 brake fluid.

There are only two reasons why the brake fluid level in your master cylinder might go down. The first is that the brake fluid goes down to an acceptable level during normal brake lining wear. When new linings are put in, the fluid level goes back up. The other reason is that fluid is leaking out of the brake system. If it is, you should have your brake system fixed, since a leak means that sooner or later your brakes won't work well, or won't work at all. So, it isn't a good idea to "top off" your brake fluid. Adding brake fluid won't correct a

leak. If you add fluid when your linings are worn, then you'll have too much fluid when you get new brake linings. You should add (or remove) brake fluid, as necessary, only when work is done on the brake hydraulic system.



CAUTION:

If you have too much brake fluid, it can spill on the engine. The fluid will burn if the engine is hot enough. You or others could be burned, and your vehicle could be damaged. Add brake fluid only when work is done on the brake hydraulic system.

Refer to the Maintenance Schedule to determine when to check your brake fluid. See *Periodic Maintenance Inspections* in the *Index*.

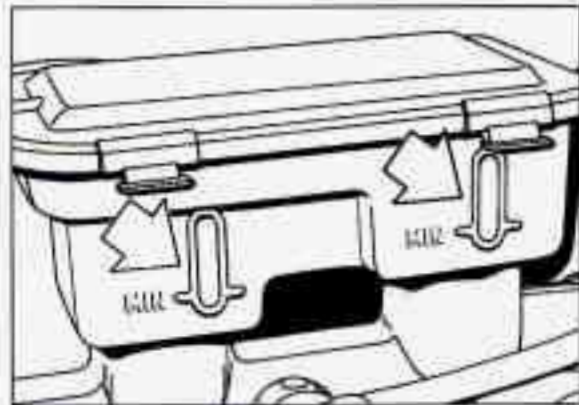

To Check Brake Fluid

You can check the brake fluid without taking off the cap. Just look at the windows on the brake fluid reservoir. The fluid levels should be above **MIN**. If they aren't, have your brake system checked to see if there is a leak.

After work is done on the brake hydraulic system, make sure the levels are above **MIN** and below the top of each window.

What to Add

When you do need brake fluid, use only DOT-3 brake fluid — such as Delco Supreme 11® (GM Part No.1052535). Use new brake fluid from a sealed container only, and always clean the brake fluid reservoir cap before removing it.

NOTICE:

- DOT-5 silicone brake fluid can damage your vehicle. Don't use it.
- Don't let someone put in the wrong kind of fluid. For example, just a few drops of mineral-based oil, such as engine oil, in your brake system can damage brake system parts so badly that they'll have to be replaced.
- Brake fluid can damage paint, so be careful not to spill brake fluid on your vehicle. If you do, wash it off immediately. See *Appearance Care* in the *Index*.

Brake Wear

Your Oldsmobile has front disc brakes and rear drum brakes.

Disc brake pads have built-in wear indicators that make a high-pitched warning sound when the brake pads are worn and new pads are needed. The sound may come and go or be heard all the time your vehicle is moving (except when you are pushing on the brake pedal firmly).



CAUTION:

The brake wear warning sound means that sooner or later your brakes won't work well. That could lead to an accident. When you hear the brake wear warning sound, have your vehicle serviced.

NOTICE:

Continuing to drive with worn-out brake pads could result in costly brake repair.

Some driving conditions or climates may cause a brake squeal when the brakes are first applied or lightly applied. This does not mean something is wrong with your brakes.

Your rear drum brakes don't have wear indicators, but if you ever hear a rear brake rubbing noise, have the rear brake linings inspected. Also, the rear brake drums should be removed and inspected each time the tires are removed for rotation or changing. When

you have the front brakes replaced, have the rear brakes inspected, too.

Brake linings should always be replaced as complete axle sets.

Brake Pedal Travel

See your dealer if the brake pedal does not return to normal height, or if there is a rapid increase in pedal travel. This could be a sign of brake trouble.

Brake Adjustment

Every time you make a brake stop, your disc brakes adjust for wear.

If your brake pedal goes down farther than normal, your rear drum brakes may need adjustment. Adjust them by backing up and firmly applying the brakes a few times.

Replacing Brake System Parts

The braking system on a modern vehicle is complex. Its many parts have to be of top quality and work well together if the vehicle is to have really good braking. Vehicles we design and test have top-quality GM brake parts in them, as your Oldsmobile does when it is new. When you replace parts of your braking system — for example, when your brake linings

Service & Appearance Care

wear down and you have to have new ones put in — be sure you get new genuine GM replacement parts. If you don't, your brakes may no longer work properly. For example, if someone puts in brake linings that are wrong for your vehicle, the balance between your front and rear brakes can change, for the worse. The braking performance you've come to expect can change in many other ways if someone puts in the wrong replacement brake parts.



■ **Battery**

Every new Oldsmobile has a Delco Freedom® battery. You never have to add water to one of these. When it's time for a new battery, we recommend a Delco Freedom® battery. Get one that has the catalog number shown on the original battery's label.

Vehicle Storage

If you're not going to drive your vehicle for 25 days or more, take off the black, negative (-) cable from the battery. This will help keep your battery from running down.



CAUTION:

Batteries have acid that can burn you and gas that can explode. You can be badly hurt if you aren't careful. See *Jump Starting* in the *Index* for tips on working around a battery without getting hurt.

Contact your dealer to learn how to prepare your vehicle for longer storage periods.

■ Halogen Bulbs



CAUTION:

Halogen bulbs have pressurized gas inside and can burst if you drop or scratch the bulb. You or others could be injured. Take special care when handling and disposing of halogen bulbs.

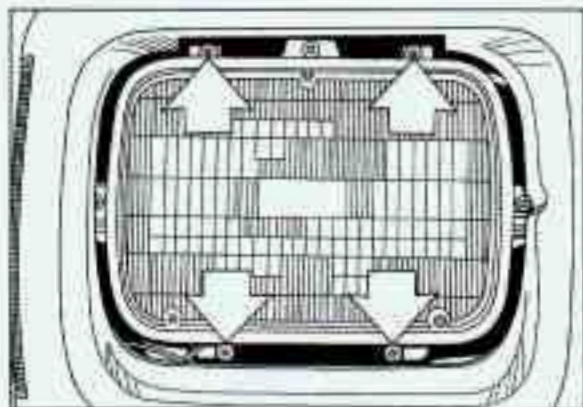

Headlight Bulb Replacement

For the type of bulb, see the *Index* under *Replacement Bulbs*.

1. Remove the four Phillips-head screws from the headlight retainer.
2. Pull the headlight out and remove the retainer.
3. Unplug the headlight.
4. Plug in the new bulb and put it in place.
5. Install the retainer to the headlight.
6. Install the screws.

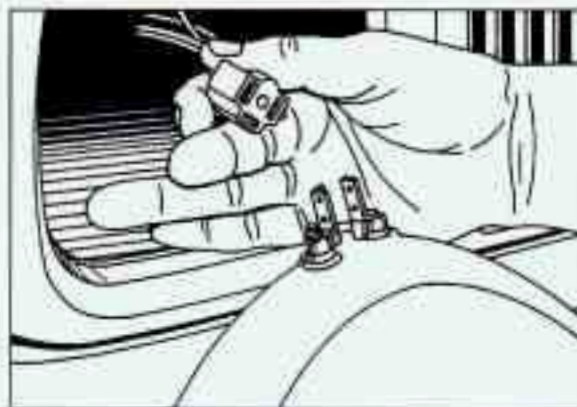

Service & Appearance Care

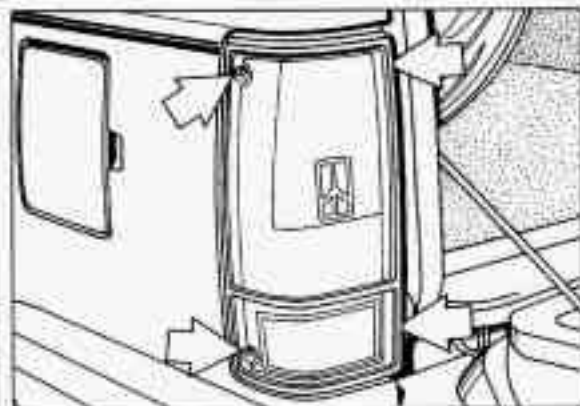

Taillight Bulb Replacement

For the type of bulb, see the *Index* under *Replacement Bulbs*.

1. Open the tailgate.
2. Remove the T15 Torx®-head screws from the light assembly.
3. Pull the assembly away from the fender.

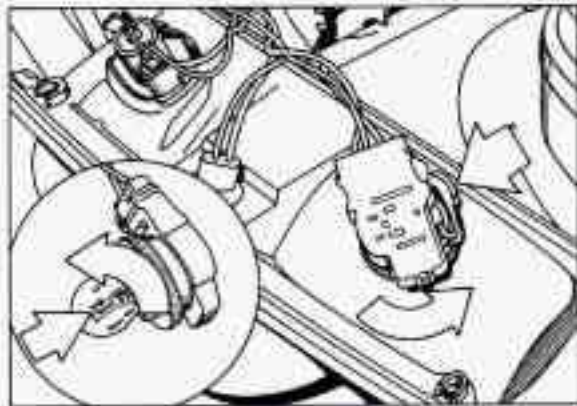

4. Turn the socket counterclockwise to remove it. If the socket has a tab, push the tab in while you turn the socket.
5. Turn the bulb counterclockwise to remove it.
6. Put the new bulb into the socket and turn the bulb clockwise.
7. Put the socket into the light assembly and turn the socket clockwise until it locks in place.
8. Install the light assembly and screws.
9. Close the tailgate.

Fog Light Bulb Replacement

Don't change your fog light bulbs unless you have the proper aiming equipment. See your Oldsmobile dealer if you have any further questions.

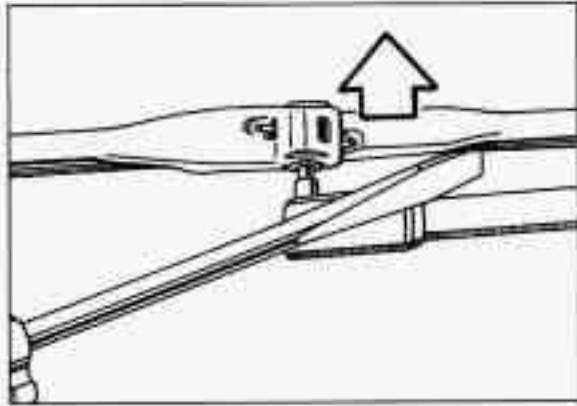

Windshield Wiper Blade Replacement

Replacement blades come in different types and are removed in different ways. Here's how to remove the type without a release clip:

1. Pull the windshield wiper arm away from the windshield.
2. With a screwdriver, pry the blade assembly off the wiper arm.
3. Push the new wiper blade securely on the wiper arm.

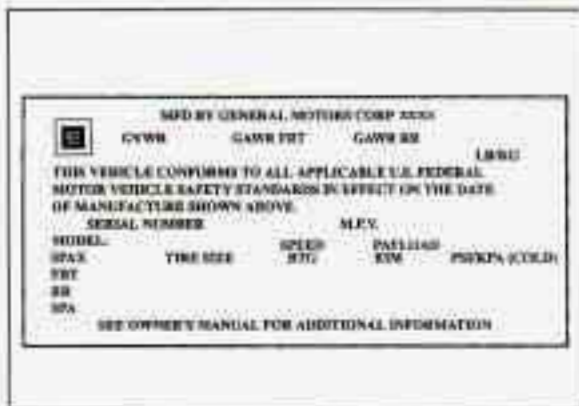

■ Loading Your Vehicle

The Certification/Tire label is found on the rear edge of the driver's door. The label shows the size of your original tires and the inflation pressures needed to obtain the gross weight capacity of your vehicle. This is called the GVWR (Gross Vehicle Weight Rating). The GVWR includes the weight of the vehicle, all occupants, fuel and cargo.

The Certification/Tire label also tells you the maximum weights for the front and rear axles, called Gross Axle Weight Rating (GAWR). To find out the actual loads on your front and rear axles, you need to go to a weigh station and weigh your vehicle. Your dealer can help you with this. Be sure to spread

out your load equally on both sides of the centerline.

Never exceed the GVWR for your vehicle, or the Gross Axle Weight Rating (GAWR) for either the front or rear axle.

And, if you do have a heavy load, you should spread it out.



CAUTION:

Do not load your vehicle any heavier than the GVWR or the maximum front and rear GAWRs. If you do, parts on your vehicle can break, or it can change the way your vehicle handles. These could cause you to lose control. Also, overloading can shorten the life of your vehicle.

Using heavier suspension components to get added durability might not change your weight ratings. Ask your dealer to help you load your vehicle the right way.

NOTICE:

Your warranty does not cover parts or components that fail because of overloading.

If you put things inside your vehicle — like suitcases, tools, packages, or anything else — they will go as fast as the vehicle goes. If you have to stop or turn quickly, or if there is a crash, they'll keep going.

Service & Appearance Care



CAUTION:

Things you put inside your vehicle can strike and injure people in a sudden stop or turn, or in a crash.

- Put things in the cargo area of your vehicle. Try to spread the weight evenly.
- Never stack heavier things, like suitcases, inside the vehicle so that some of them are above the tops of the seats.
- When you carry something inside the vehicle, secure it whenever you can.
- Don't leave a seat folded down unless you need to.

Payload

The Payload Capacity is shown on the Certification/Tire label. This is the maximum load capacity that your vehicle can carry. Be sure to include the weight of the people inside as part of your load. If you added any accessories or equipment after your vehicle left the factory, remember to subtract the

weight of these things from the payload. Your dealer can help you with this.

Trailer Package

If your vehicle comes with the trailer package, there is also a load rating which includes the weight of the vehicle **and** the trailer it tows. This rating is called the Gross Combination Weight Rating (GCWR).

When you weigh your trailer, be sure to include the weight of everything you put in it. And, remember to figure the weight of the people inside as part of your load.

Your dealer can help you determine your GCWR.

Add-On Equipment

When you carry removable items, you may need to put a limit on how many people you carry inside your vehicle. Be sure to weigh your vehicle before you buy and install the new equipment.

NOTICE:

Your warranty doesn't cover parts or components that fail because of overloading.

■ *Single Belt Accessory Drive*

Your new vehicle uses a serpentine belt that is lighter, more durable and fuel efficient than systems with several belts. The belt runs over or around the pulleys on the engine. A tensioner is used to keep the belt tight at all times. The tensioner also makes replacing the belt easier. If you need to replace the belt, be sure to get the correct replacement belt. Your dealership or parts supplier can help you with this. The Accessory Drive Belt Routing label on your vehicle will show you how to route the belt your vehicle uses.

■ *Air Conditioning*

Every now and then have your dealership check your air conditioning system to be sure it has not lost any cooling ability. If you think the system is not working properly, have your dealership check it out as soon as possible.

The air conditioning will not work when the temperature is below 40°F (4°C).

■ *Accelerator Control System*

Your Maintenance Schedule will tell you how often the accelerator linkage pivot points must be lubricated and what type of lubricant to use.

Accelerator cables and cruise control cables should not be lubricated. Any cables that are worn or are hard to pull should be replaced.

■ *Hood Latches and Hood Hinge*

Your Maintenance Schedule will tell you how to lubricate the hood latch and hood hinge assembly.

■ *Lock Cylinders*

To be sure your locks operate properly, they must be lubricated. Your Maintenance Schedule will tell you how often to lubricate them and what type of lubricant to use.

You should not use penetrating oils because they could wash out the factory installed lubricant and cause the lock to bind. De-icers which contain alcohol

could also wash away the lubricant, so be sure to lubricate the lock after using a de-icer of this type.

■ *Tailgate-Mounted Spare Tire Carrier*

The spare tire carrier must be lubricated to keep it operating smoothly. Your Maintenance Schedule will tell you what type of lubricant to use.

■ *Tires*

We don't make tires. Your new vehicle comes with high quality tires made by a leading tire manufacturer. These tires are warranted by the tire manufacturers and their warranties are delivered with every new Oldsmobile. If your spare tire is a different brand than your road tires, you will have a tire warranty folder from each of these manufacturers.



CAUTION:

Poorly maintained and improperly used tires are dangerous.

- Overloading your tires can cause overheating as a result of too much friction. You could have an air-out and a serious accident. See *Loading Your Vehicle in the Index*.
- Underinflated tires pose the same danger as overloaded tires. The resulting accident could cause serious injury. Check all tires frequently to maintain the recommended pressure. Tire pressure should be checked when your tires are cold.
- Overinflated tires are more likely to be cut, punctured, or broken by a sudden impact, such as when you hit a pothole. Keep tires at the recommended pressure.
- Worn, old tires can cause accidents. If your tread is badly worn, or if your tires have been damaged, replace them.

Service & Appearance Care

Inflation–Tire Pressure

The Certification/Tire label which is on the rear edge of the driver's door shows the correct inflation pressures for your tires, when they're cold. "Cold" means your vehicle has been sitting for at least three hours or driven no more than a mile. Also see *Capacities & Specifications* in the *Index*.

NOTICE:

Don't let anyone tell you that underinflation **or** overinflation is all right. It's not. If your tires don't have enough air (underinflation) you can get:

- Too much flexing
- Too much heat
- Tire overloading
- Bad wear
- Bad handling
- Bad fuel economy.

If your tires have too much air (overinflation), you can get:

- Unusual wear
- Bad handling
- Rough ride
- Needless damage from road hazards.

When to Check

Check your tires once a month or more. Also, check the tire pressure of the spare tire.

How to Check

Use a good quality pocket-type gage to check tire pressure. Simply looking at the tires will not tell you the pressure, especially if you have radial tires — which may look properly inflated even if they're underinflated.

If your tires have valve caps, be sure to put them back on. They help prevent leaks by keeping out dirt and moisture.

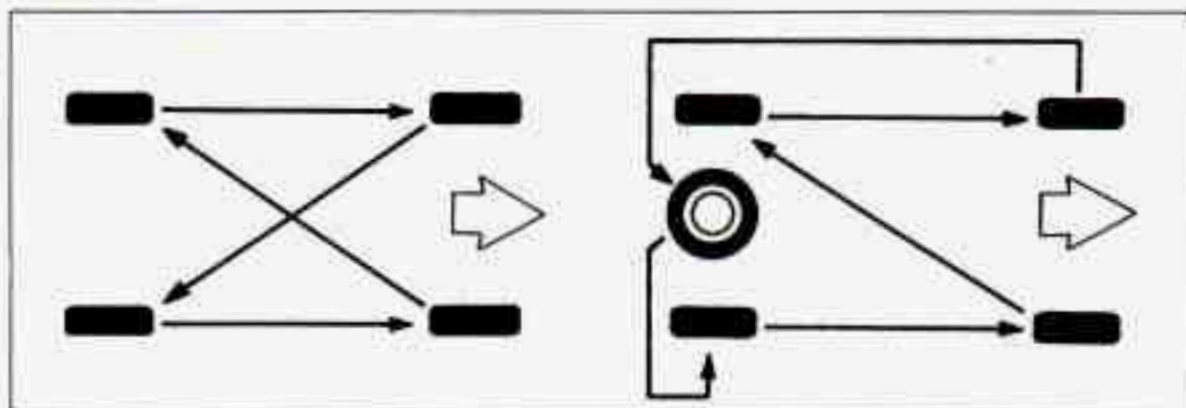

Tire Inspection and Rotation

To make your tires last longer, have them inspected and rotated at the mileages recommended in the Maintenance Schedule. See *Scheduled Maintenance Services* in the *Index*.

Use this rotation pattern.

If your vehicle has front tires with different load ratings or tread designs (such as all season vs. on/off road) than the rear tires, don't rotate your tires front to rear.

After the tires have been rotated, adjust the front and rear inflation pressure as shown on the Certification/Tire label. Make certain that all wheel nuts are properly tightened. See *Wheel Nut Torque* in the *Index*.



CAUTION:

Rust or dirt on a wheel, or on the parts to which it is fastened, can make wheel nuts become loose after a time. The wheel could come off and cause an accident. When you change a wheel, remove any rust or dirt from places where the wheel attaches to the vehicle. In an emergency, you can use a cloth or a paper towel to do this, but be sure to use a scraper or wire brush later, if you need to, to get all the rust or dirt off. (See *Changing a Flat Tire* in the *Index*.)



TREAD WEAR INDICATORS

When It's Time for New Tires

One way to tell when it's time for new tires is to check the treadwear indicators, which will appear when your tires have only 2/32 inch (1.6 mm) or less of tread remaining.

You need a new tire if:

- You can see the indicators at three or more places around the tire.
- You can see cord or fabric showing through the tire's rubber.
- The tread or sidewall is cracked, cut or snagged deep enough to show cord or fabric.
- The tire has a bump, bulge or split.

Service & Appearance Care

- The tire has a puncture, cut, or other damage that can't be repaired well because of the size or location of the damage.

Buying New Tires

To find out what kind and size of tires you need, look at the Certification/Tire label.

The tires installed on your vehicle when it was new had a Tire Performance Criteria Specification (TPC Spec) number on each tire's sidewall. When you get new tires, get ones with that same TPC Spec number. That way, your vehicle will continue to have tires that are designed to give proper endurance, handling, speed rating, traction, ride and other things during normal service on your vehicle. If your tires have an all-season tread design, the TPC number will be followed by a "MS" (for mud and snow).

If you ever replace your tires with those not having a TPC Spec number, make sure they are the same size, load range, speed rating and construction type (bias, bias-belted or radial) as your original tires.



CAUTION:

Mixing tires could cause you to lose control while driving. If you mix tires of different sizes or types (radial and bias-belted tires), the vehicle may not handle properly, and you could have a crash. Be sure to use the same size and type tires on all four wheels.

Uniform Tire Quality Grading

The following information relates to the system developed by the United States National Highway Traffic Safety Administration which grades tires by treadwear, traction and temperature performance. (This applies only to vehicles sold in the United States.)

Treadwear

The treadwear grade is a comparative rating based on the wear rate of the tire when tested under controlled conditions on a specified government test course. For example, a tire graded 150 would wear one and a half (1 1/2) times as well on the government course

as a tire graded 100. The relative performance of tires depends upon the actual conditions of their use, however, and may depart significantly from the norm due to variations in driving habits, service practices and differences in road characteristics and climate.

Traction - A, B, C

The traction grades, from highest to lowest are: A, B, and C. They represent the tire's ability to stop on wet pavement as measured under controlled conditions on specified government test surfaces of asphalt and concrete. A tire marked C may have poor traction performance.

Warning: The traction grade assigned to this tire is based on braking (straight-ahead) traction tests and does not include cornering (turning) traction.

Temperature - A, B, C

The temperature grades are A (the highest), B, and C, representing the tire's resistance to the generation of heat and its ability to dissipate heat when tested under controlled conditions on a specified indoor laboratory test wheel. Sustained high

temperature can cause the material of the tire to degenerate and reduce tire life, and excessive temperature can lead to sudden tire failure. The grade C corresponds to a level of performance which all passenger car tires must meet under the Federal Motor Vehicle Safety Standard No. 109. Grades B and A represent higher levels of performance on the laboratory test wheel than the minimum required by law.

Warning: The temperature grade for this tire is established for a tire that is properly inflated and not overloaded. Excessive speed, underinflation, or excessive loading, either separately or in combination, can cause heat buildup and possible tire failure.

These grades are molded on the sidewalls of passenger car tires.

While the tires available as standard or optional equipment on General Motors vehicles may vary with respect to these grades, all such tires meet General Motors performance standards and have been approved for use on General Motors vehicles. All passenger type (P Metric) tires must conform to Federal safety requirements in addition to these grades.

Wheel Alignment and Tire Balance

The wheels on your vehicle were aligned and balanced carefully at the factory to give you the longest tire life and best overall performance.

In most cases, you will not need to have your wheels aligned again. However, if you notice unusual tire wear or your vehicle pulling one way or the other, the alignment may need to be reset. If you notice your vehicle vibrating when driving on a smooth road, your wheels may need to be rebalanced.

Wheel Replacement

Replace any wheel that is bent, cracked or badly rusted. If wheel nuts keep coming loose, the wheel, wheel bolts, and wheel nuts should be replaced. If the wheel leaks air, replace it (except some aluminum wheels, which can sometimes be repaired). See your Oldsmobile dealer if any of these conditions exist.

Your dealer will know the kind of wheel you need.

Each new wheel should have the same load carrying capacity, diameter, width, offset, and be mounted the same way as the one it replaces.

If you need to replace any of your wheels, wheel bolts, or wheel nuts, replace them only with new GM original equipment parts. This way, you will be sure to have the right wheel, wheel bolts, and wheel nuts for your Oldsmobile model.



CAUTION:

Using the wrong replacement wheels, wheel bolts, or wheel nuts on your vehicle can be dangerous. It could affect the braking and handling of your vehicle, make your tires lose air and make you lose control. You could have a collision in which you or others could be injured. Always use the correct wheel, wheel bolts, and wheel nuts for replacement.

Service & Appearance Care

NOTICE:

The wrong wheel can also cause problems with bearing life, brake cooling, speedometer/odometer calibration, headlight aim, bumper height, vehicle ground clearance, and tire clearance to the body and chassis.

Used Replacement Wheels



CAUTION:

Putting a used wheel on your vehicle is dangerous. You can't know how it's been used or how many miles it's been driven. It could fail suddenly and cause an accident. If you have to replace a wheel use a **new GM original equipment wheel**.

Tire Chains

NOTICE:

Don't use tire chains; they can damage your vehicle.

■ Appearance Care

Remember, cleaning products can be hazardous. Some are toxic. Others can burst into flame if you strike a match or get them on a hot part of the vehicle. Some are dangerous if you breathe their fumes in a closed space. When you use anything from a container to clean your Oldsmobile, be sure to follow the manufacturer's warnings and instructions. And always open your doors or windows when you're cleaning the inside.

Never use these to clean your vehicle:

- Gasoline
- Benzene
- Naphtha
- Carbon Tetrachloride
- Acetone
- Paint Thinner

- Turpentine
- Lacquer Thinner
- Nail Polish Remover

They can all be hazardous — some more than others — and they can all damage your vehicle, too.

NOTICE:

Don't use any of these unless this manual says you can. In many uses, these will damage your vehicle:

- Laundry Soap
- Bleach
- Reducing Agents

■ *Cleaning the Inside of Your Oldsmobile*

Use a vacuum cleaner often to get rid of dust and loose dirt. Wipe vinyl or leather with a clean, damp cloth.

Your Oldsmobile dealer has two GM cleaners, a solvent-type spot lifter and a foam-type powdered cleaner. They will clean normal spots and stains very well. Do not use them on vinyl or leather.

Here are some cleaning tips:

- Always read the instructions on the cleaner label.
- Clean up stains as soon as you can — before they set.
- Use a clean cloth or sponge, and change to a clean area often. A soft brush may be used if stains are stubborn.
- Use solvent-type cleaners in a well-ventilated area only. If you use them, don't saturate the stained area.
- If a ring forms after spot cleaning, clean the entire area immediately or it will set.

Using Foam-Type Cleaner on Fabric

- Vacuum and brush the area to remove any loose dirt.
- Always clean a whole trim panel or section. Mask surrounding trim along stitch or welt lines.
- Mix Multi-Purpose Powdered Cleaner following the directions on the container label.
- Use suds only and apply with a clean

sponge.

- Don't saturate the material.
- Don't rub it roughly.
- As soon as you've cleaned the section, use a sponge to remove the suds.
- Rinse the section with a clean, wet sponge.
- Wipe off what's left with a slightly damp paper towel or cloth.
- Then dry it immediately with a blow dryer or a heat lamp.

NOTICE:

Be careful with a hair dryer or heat lamp. You could scorch the fabric.

- Wipe with a clean cloth.

Using Solvent-Type Cleaner on Fabric

First, see if you have to use solvent-type cleaner at all. Some spots and stains will clean off better with just water and mild soap.

If you need to use a solvent:

- Gently scrape excess soil from the trim

material with a clean, dull knife or scraper. Use very little cleaner, light pressure and clean cloths (preferably cheesecloth). Cleaning should start at the outside of the stain, "feathering" toward the center. Keep changing to a clean section of the cloth.

- When you clean a stain from fabric, immediately dry the area with an air hose, hair dryer, or heat lamp to help prevent a cleaning ring. (See the previous NOTICE.)

Special Cleaning Problems

Greasy or Oily Stains

Such as grease, oil, butter, margarine, shoe polish, coffee with cream, chewing gum, cosmetic creams, vegetable oils, wax crayon, tar and asphalt.

- Carefully scrape off excess stain.
- Follow the solvent-type instructions described earlier.
- Shoe polish, wax crayon, tar and asphalt will stain if left on a vehicle seat fabric. They should be removed as soon as possible. Be careful, because the cleaner will dissolve them and may cause them to spread.

Service & Appearance Care

Non-Greasy Stains

Such as catsup, coffee (black), egg, fruit, fruit juice, milk, soft drinks, wine, vomit, urine and blood.

- Carefully scrape off excess stain, then sponge the soiled area with cool water.
- If a stain remains, follow the foam-type instructions described earlier.
- If an odor lingers after cleaning vomit or urine, treat the area with a water/baking soda solution: 1 teaspoon (5 ml) of baking soda to 1 cup (250 ml) of lukewarm water.
- If needed, clean lightly with solvent-type cleaner.

Combination Stains

Such as candy, ice cream, mayonnaise, chili sauce and unknown stains.

- Carefully scrape off excess stain, then clean with cool water and allow to dry.
- If a stain remains, clean it with solvent-type cleaner.

Cleaning Vinyl

Use warm water and a clean cloth.

- Rub with a clean, damp cloth to remove dirt. You may have to do it more than once.
- Things like tar, asphalt and shoe polish will stain if you don't get them off quickly. Use a clean cloth and a solvent-type vinyl cleaner.

Cleaning Leather

Use a soft cloth with lukewarm water and a mild soap or saddle soap.

- For stubborn stains, use a mild solution of 10% isopropyl alcohol (rubbing alcohol) and 90% water.
- **Never** use oils, varnishes, solvent-based or abrasive cleaners, furniture polish or shoe polish on leather.
- Soiled leather should be cleaned immediately. If dirt is allowed to work into finish, it can harm the leather.

Cleaning the Top of the Instrument Panel

Use only mild soap and water to clean the top surfaces of the instrument panel. Sprays containing silicones or

waxes may cause annoying reflections in the windshield and even make it difficult to see through the windshield under certain conditions.

■ Care of Safety Belts

Keep belts clean and dry.



CAUTION:

Do not bleach or dye safety belts. If you do, it may severely weaken them. In a crash they might not be able to provide adequate protection. Clean safety belts only with mild soap and lukewarm water.

■ Glass

Glass should be cleaned often. GM Glass Cleaner (GM Part No. 1050427) or a liquid household glass cleaner will remove normal tobacco smoke and dust films.

Don't use abrasive cleaners on glass, because they may cause scratches. Avoid placing decals on the inside rear window, since they may have to be scraped off later. If abrasive cleaners are

used on the inside of the rear window, an electric defogger element may be damaged. Any temporary license should not be attached across the defogger grid.

■ *Cleaning the Outside of the Windshield, Backglass and Wiper Blades*

If the windshield is not clear after using the windshield washer, or if the wiper blade chatters when running, wax or other material may be on the blade or windshield.

Clean the outside of the windshield with GM Windshield Cleaner, Bon-Ami Powder® (GM Part No. 1050011). The windshield is clean if beads do not form when you rinse it with water.

Clean the blade by wiping vigorously with a cloth soaked in full strength windshield washer solvent. Then rinse the blade with water.

Wiper blades should be checked on a regular basis and replaced when worn.

■ *Cleaning the Outside of Your Oldsmobile*

The paint finish on your vehicle provides beauty, depth of color, gloss retention and durability.

Washing Your Vehicle

The best way to preserve your vehicle's finish is to keep it clean by washing it often with lukewarm or cold water.

Don't wash your vehicle in the direct rays of the sun. Don't use strong soaps or chemical detergents. Use liquid hand, dish or car washing (mild detergent) soaps. Don't use cleaning agents that contain acid or abrasives. All cleaning agents should be flushed promptly and not allowed to dry on the surface, or they could stain. Dry the finish with a soft, clean chamois or a 100% cotton towel to avoid surface scratches and water spotting.

High pressure truck washes may cause water to enter your vehicle.

Finish Care

Occasional waxing or mild polishing of your Oldsmobile may be necessary to remove residue from the paint finish. You can get GM approved cleaning products from your dealer.

Protecting Exterior Bright Metal Parts

Bright metal parts should be cleaned regularly to keep their luster. Washing with water is all that is usually needed. However, you may use GM Chrome Polish on chrome or stainless steel trim, if necessary.

Use special care with aluminum trim. To avoid damaging protective trim, never use auto or chrome polish, steam or caustic soap to clean aluminum. A coating of wax, rubbed to high polish, is recommended for all bright metal parts.

Service & Appearance Care

■ *Aluminum Wheels*

Your aluminum wheels have a protective coating similar to the painted surface of your truck. Don't use strong soaps, chemicals, chrome polish, abrasive cleaners or abrasive cleaning brushes on them because you could damage this coating. After rinsing thoroughly, a wax may be applied.

NOTICE:

Don't use an automatic vehicle wash that has hard silicon carbide cleaning brushes. These brushes can take off the protective coating.

■ *Weatherstrips*

Silicone grease on weatherstrips will make them last longer, seal better, and not stick or squeak. Apply silicone grease with a clean cloth at least every six months. During very cold, damp weather more frequent application may be required. (See *Recommended Fluids & Lubricants* in the *Index*.)

■ *Sheet Metal Damage*

If your vehicle is damaged and requires sheet metal repair or replacement, make sure the body repair shop applies anti-corrosion material to the parts repaired or replaced to restore corrosion protection.

■ *Foreign Material*

Calcium chloride and other salts, ice melting agents, road oil and tar, tree sap, bird droppings, chemicals from industrial chimneys, and other foreign matter can damage your vehicle's finish if they remain on painted surfaces. Use cleaners that are marked safe for painted surfaces to remove foreign matter.

■ *Finish Damage*

Any stone chips, fractures or deep scratches in the finish should be repaired right away. Bare metal will corrode quickly and may develop into a major repair expense.

Minor chips and scratches can be repaired with touch-up materials

available from your dealer or other service outlets. Larger areas of finish damage can be corrected in your dealer's body and paint shop.

■ *Underbody Maintenance*

Chemicals used for ice and snow removal and dust control can collect on the underbody. If these are not removed, accelerated corrosion (rust) can occur on the underbody parts such as fuel lines, frame, floor pan, and exhaust system even though they have corrosion protection.

At least every spring, flush these materials from the underbody with plain water. Clean any areas where mud and other debris can collect. Dirt packed in closed areas of the frame should be loosened before being flushed. Your dealer or an underbody vehicle washing system can do this for you.

■ *Chemical Paint Spotting*

Some weather and atmospheric conditions can create a chemical fallout. Airborne pollutants can fall upon and attack painted surfaces on your vehicle. This damage can take two forms:

blotchy, ringlet-shaped discolorations, and small irregular dark spots etched into the paint surface.

Although no defect in the paint job causes this, Oldsmobile will repair, at no charge to the owner, the surfaces of new vehicles damaged by this fallout condition within 12 months or 12,000 miles (20 000 km) of purchase, whichever comes first.

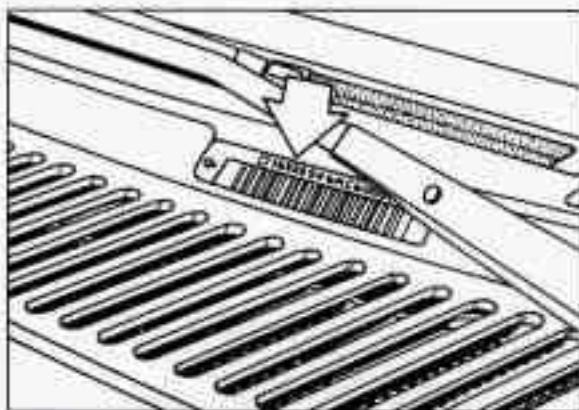

■ *Vehicle Identification Number (VIN)*

This is the legal identifier for your Oldsmobile. It appears on a plate in the front corner of the instrument panel, on the driver's side. You can see it if you look through the windshield from outside your vehicle. The VIN also appears on the Vehicle Certification and Service Parts labels and the certificates of title and registration.

■ *Engine Identification*

The eighth character in your VIN is the engine code. This code will help you identify your engine, specifications, and replacement parts.

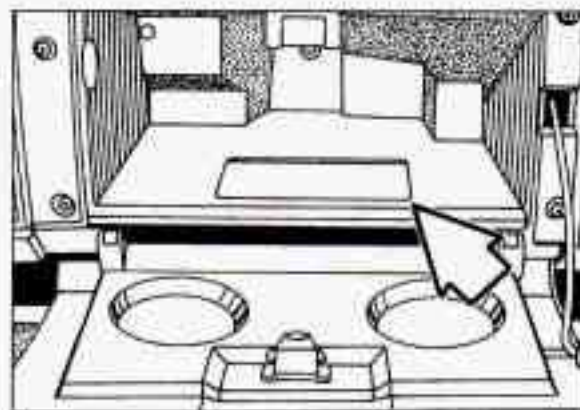

■ *Service Parts Identification Label*

You'll find this label inside the glove box. It's very helpful if you ever need to order parts. On this label is:

- your VIN,
- the model designation,
- paint information, and
- a list of all production options and special equipment.

Be sure that this label is not removed from the vehicle.

Service & Appearance Care

■ Add-On Electrical Equipment

NOTICE:

Don't add anything electrical to your Oldsmobile unless you check with your dealer first. Some electrical equipment can damage your vehicle and the damage wouldn't be covered by your warranty. Some add-on electrical equipment can keep other components from working as they should.

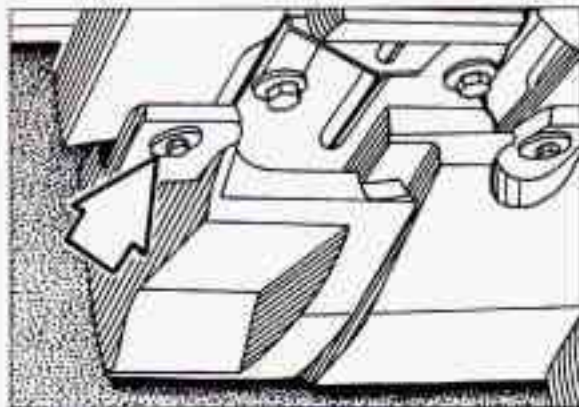

■ Fuses & Circuit Breakers

The fuse block is under the instrument panel on the driver's side. It is covered by an access panel.

The wiring circuits in your vehicle are protected from short circuits by a combination of fuses, circuit breakers, and fusible thermal links in the wiring itself. This greatly reduces the chance of damage caused by electrical problems.

To Remove the Access Panel:

1. Remove the hex-head screw.
2. Pull down and out on the access panel.

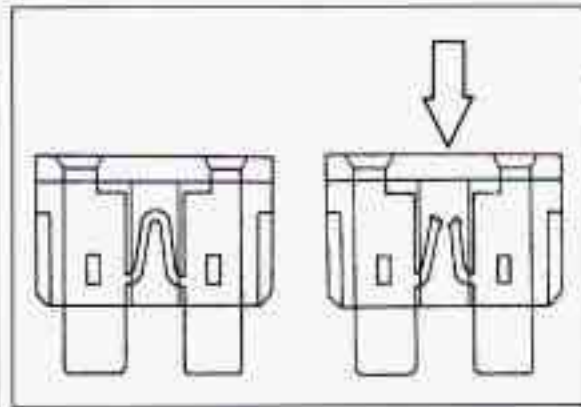

Look at the silver-colored band inside the fuse. If the band is broken or melted, replace the fuse. Be sure you replace a bad fuse with a new one of the correct size.

To Install the Access Panel:

1. Put the access panel tab into the slot below the fuse block.
2. Install the screw.

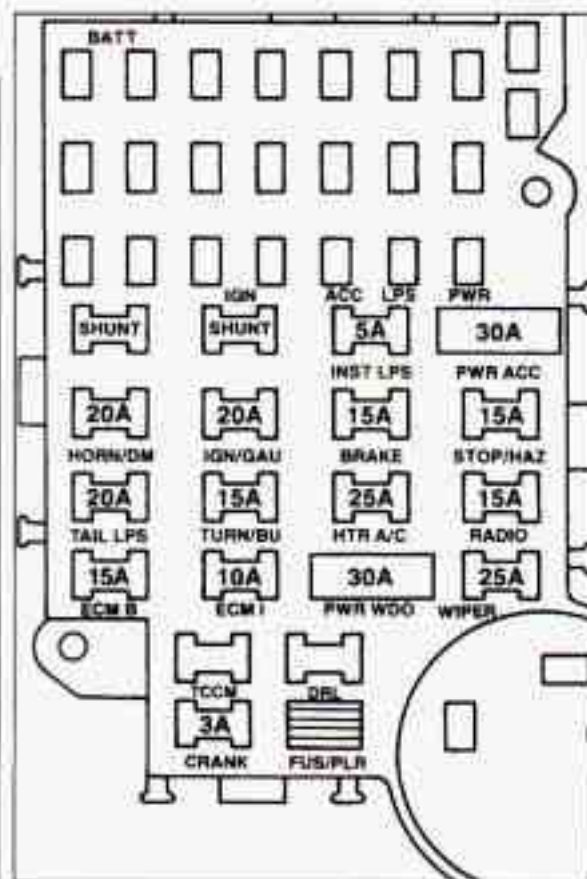

Fuse Usage

Position	Rating (AMP.)	Circuitry
INST LPS	5	Instrument Panel Lights, Headlight Warning Buzzer, Heater Light, Ashtray Light, Radio Illumination Light, Rear Wiper Switch Light
PWR ACC	30	Power Door Locks, Rear Defogger, Console Accessory Receptacles, CD Player
HORN/DM	20	Horn, Dome Lights, Glove Box Light, Clock, Lighter, Lighted Vanity Mirror, Outside Rearview Mirror, Courtesy Lights
IGN/GAU	20	Indicator Lights and Gages, Rear Defogger Relay, Cruise Control, Rear Defogger Switch, Seat Belt Timer
BRAKE	15	Four Wheel Anti-lock Brake Module, Digital Ratio Adapter Module (Speedometer)
STOP/HAZ	15	Stop Lights, Hazard Warning Lights, Chime Module, Center High Mounted Stop Light (CHMSL)
TAIL LPS	20	Light Switch, Tail/Park Lights, Electronic Cluster, License Light
TURN/BU	15	Turn Signals & Back-up Lights
HTR A/C	25	Heating and Air Conditioning
RADIO	15	Radio, Inside Rearview Mirror Map Lights, Rear Wiper, Rear Washer, Compass
ECM B	15	Electronic Control Module, Fuel Pump
ECM I	10	Electronic Control Module
PWR WDO	30	Power Windows
WIPER	25	Windshield Wipers and Washer
CRANK	3	Electronic Control Module
TRAILER*	30	Trailer Wiring Harness
UNDERHOOD*	4	Underhood Light
CD PLAYER	10	CD Player (attached to fuse block)

*In-line fuse.

Service & Appearance Care

Headlight Wiring

The headlight wiring is protected by a circuit breaker in the light switch. An electrical overload will cause the lights to go on and off, or in some cases to remain off. If this happens, have your headlight system checked right away.

Trailer Wiring Harness

The seven-wire trailer wiring harness is protected by an in-line fuse in the battery feed wire. This fuse is near the junction block. See the *Index* under *Trailer Wiring Harness*.

Windshield Wipers

The windshield wiper motor is protected by a circuit breaker and a fuse. If the motor overheats due to heavy snow, etc., the wiper will stop until the motor cools. If the overload is caused by some electrical problem, have it fixed.

Power Windows and Other Power Accessories

Circuit breakers in the fuse panel protect the power windows and other power accessories. When the current load is too heavy, the circuit breaker opens and closes, protecting the circuit until the problem is fixed or goes away.

Before you wire any other electrical accessories into your fuse block, please check with your Oldsmobile dealer.

Capacities & Specifications

Automatic Transmission

Pan Removal and Replacement	5 quarts	4.7 L
After Complete Overhaul	10.5 quarts	9.9 L
Cooling System	11.8 quarts	11.2 L
Refrigerant (R-12), Air Conditioning	2 lb, 5 oz.	1.13 kg

Not all air conditioning refrigerants are the same. If the air conditioning system in your vehicle needs refrigerant, be sure the proper refrigerant is used. If you're not sure, ask your Oldsmobile dealer. For additional information, see your "Warranty and Owner Assistance Information" booklet.

Engine Crankcase

Without filter	4 quarts	3.8 L
With filter	4.5 quarts	4.3 L
Fuel Tank	20 gallons	76 L
Tire Pressure, All	35 psi	240 kPa
Wheel Nut Torque	95 pound-feet	130 N•m

NOTE: All capacities are approximate. When adding, be sure to fill to the appropriate level on the dipstick, or as recommended in this manual.

Service & Appearance Care

Engine Specifications

4.3L V6 Engine

VIN Engine Code	W
Type	V6
Displacement	4.3 Liters
Compression Ratio	9.1:1
Firing Order	1-6-5-4-3-2
Thermostat Temperature Specification	195°F (91°C)

Normal Maintenance Replacement Parts

Air Cleaner Element	AC Type A1163C
Engine Oil Filter	AC Type PF-51
Fuel Filter	GF481
PCV Valve	AC Type CV-892C
Spark Plugs	AC Type •CR45TSM Gap: 0.045 inch (1.14 mm)

Fluids & Lubricants

ITEM	APPLICATION	GM PART NUMBER	SIZE
Antifreeze Coolant (Ethylene Glycol Base)	Year-round antifreeze for coolant mixtures	1052103	1 gal. (3.8 L)
Chassis Lubricant (Grease Gun Insert)	General chassis lube, etc.	12346003 or 1052497	14 oz. (397 g)
Delco Supreme 11 [®] Brake Fluid	Brake System	1052535	16 oz. (0.5 L)
Automatic Transmission Fluid	Automatic Transmission, Transfer Case		
DEXRON [®] -III		12346143	32 oz. (1.0 L)
DEXRON [®] -IIIE		12345881	32 oz. (1.0 L)
Engine Oil	Engine lubrication	See the <i>Index</i> under <i>Engine Oil</i> .	
Gear Lubricant 80W-90	Limited Slip Differential, Front Differential	1052271	
GM Engine Oil Supplement (E.O.S.) ...	See your dealer for advice	1052367	16 oz. (0.5 L)
Engine Oil	Hood, tailgate and door hinges		
Windshield Washer Solvent	Windshield washer fluid		
Power Steering Fluid	Power Steering System	1050017 1052884	32 oz. (1.0 L) 16 oz. (0.5 L)
Silicone Grease	Weatherstrips	12345579	1 oz. (28 g)
Spray-A-Squeak Silicone Lubricant ...	General purpose silicone lubricant, weatherstrips	1052276 (aerosol) 1052277	4.5 oz. (127 g) 12 oz. (0.35 L)

Service & Appearance Care

Replacement Bulbs

OUTSIDE LIGHTS	BULB
Back-up Lights	1156
Front Parking/Turn Signal Lights	2057
License Plate Light	67
Halogen Headlights	H6054
Front Sidemarker Lights	194
Stop/Tail/Turn Signal Lights	2057
Underhood	95
Fog	11513798H3
INSIDE LIGHTS	
Courtesy Light	1003
Reading Lights	
Front	562
Dome Lights	
Center	561
Rear	561
Glove Box Light	1003
Indicator Lights	174
Turn Signal Indicators	174
Ashtray Light	161
Heater Light	194
Windshield Wiper Switch Light	194
Cargo Light	28
Instrument Cluster Illumination	168, 194

IMPORTANT
KEEP ENGINE OIL
AT THE PROPER
LEVEL AND CHANGE AS
RECOMMENDED

This part covers the maintenance required for your Oldsmobile. Your vehicle needs these services to retain its safety, dependability and emission control performance.



Have you purchased the
GM Protection Plan?
The Plan supplements your
new vehicle warranties.
See your Oldsmobile dealer for details.

Part 7

Maintenance Schedule

Section

Introduction

A Word About Maintenance.....	204
Your Vehicle and the Environment.....	204
How This Part is Organized.....	204

A. Scheduled Maintenance Services

Using Your Maintenance Schedules.....	205
Selecting the Right Schedule.....	205
Schedule I.....	206
Schedule II.....	208
Explanation of Scheduled Maintenance Services.....	210

B. Owner Checks & Services

At Each Fuel Fill.....	212
At Least Once a Month.....	212
At Least Once a Year.....	213

C. Periodic Maintenance Inspections.....

D. Recommended Fluids & Lubricants.....

E. Maintenance Record.....

Maintenance Schedule

■ Introduction

A Word About Maintenance

We at General Motors want to help you keep your vehicle in good working condition. But we don't know exactly how you'll drive it. You may drive very short distances only a few times a week. Or you may drive long distances all the time in very hot, dusty weather. You may use your vehicle in making deliveries. Or you may drive it to work, to do errands or in many other ways.

Because of all the different ways people use their GM vehicles, maintenance needs vary. You may even need more frequent checks and replacements than you will find in the schedules in this part. So please read this part and note how you drive. If you have any questions on how to keep your vehicle in good condition, see your Oldsmobile dealer, the place many GM owners choose to have their maintenance work done. Your dealer can be relied upon to use proper parts and practices.

Your Vehicle and the Environment

Proper vehicle maintenance not only helps to keep your vehicle in good working condition, but also helps the environment. All recommended maintenance procedures are important. Improper vehicle maintenance or the removal of important components can significantly affect the quality of the air we breathe. Improper fluid levels or even the wrong tire inflation can increase the level of emissions from your vehicle. To help protect our environment, and to help keep your vehicle in good condition, please maintain your vehicle properly.

How This Part is Organized

The remainder of this part is divided into five sections:

"Section A: Scheduled Maintenance Services" shows what to have done and how often. Some of these services can be complex, so unless you are technically qualified and have the necessary equipment, you should let your dealer's service department or another qualified service center do these jobs.



CAUTION:

Performing maintenance work on a vehicle can be dangerous. In trying to do some jobs, you can be seriously injured. Do your own maintenance work only if you have the required know-how and the proper tools and equipment for the job. If you have any doubt, have a qualified technician do the work.

If you are skilled enough to do some work on your vehicle, you will probably want to get the service information GM publishes. You will find a list of publications and how to get them in this manual. See *Service Publications* in the *Index*.

"Section B: Owner Checks and Services" tells you what should be checked whenever you stop for fuel. It also explains what you can easily do to help keep your vehicle in good condition.

"Section C: Periodic Maintenance Inspections" explains important inspections that your Oldsmobile dealer's service department or another qualified service center should perform.

"Section D: Recommended Fluids & Lubricants" lists some products GM recommends to help keep your vehicle properly maintained. These products, or their equivalents, should be used whether you do the work yourself or have it done.

"Section E: Maintenance Record" provides a place for you to record the maintenance performed on your vehicle. Whenever any maintenance is performed, be sure to write it down in this section. This will help you determine when your next maintenance should be done. In addition, it is a good idea to keep your maintenance receipts. They may be needed to qualify your vehicle for warranty repairs.

■ *Section A: Scheduled Maintenance Services*

Using Your Maintenance Schedules

This section tells you the maintenance services you should have done and when you should schedule them. Your Oldsmobile dealer knows your vehicle best and wants you to be happy with it. If you go to your dealer for your service needs, you'll know that GM-trained and supported service people will perform the work using genuine GM parts.

These schedules are for vehicles that:

- carry passengers and cargo within recommended limits. You will find these limits on your vehicle's Certification/Tire label. See the *Index* under *Loading Your Vehicle*.
- are driven on reasonable road surfaces within legal driving limits.
- use the recommended unleaded fuel. See the *Index* under *Fuel*.

Selecting the Right Schedule

First you'll need to decide which of the two schedules is right for your vehicle. Here's how to decide which schedule to follow:

Schedule I

Is any one of these true for your vehicle?

- Most trips are less than 4 miles (6 km).
- Most trips are less than 10 miles (16 km) when outside temperatures are below freezing.
- The engine is at low speed most of the time (as in door-to-door delivery, or in stop-and-go traffic).
- You operate your vehicle in dusty areas or off-road frequently.
- You tow a trailer.

If any one (or more) of these is true for your driving, follow Schedule I.

Schedule II

Follow Schedule II **only** if none of the above conditions is true.

Maintenance Schedule

Schedule I

Follow Schedule I if your vehicle is **MAINLY** driven under one or more of the following conditions:

- When most trips are less than 4 miles (6 km).
- When most trips are less than 10 miles (16 km) and outside temperatures remain below freezing.
- When most trips include extended idling and/or frequent low-speed operation, as in stop-and-go traffic.
- When towing a trailer.
- When operating in dusty areas or off-road frequently.

Schedule I should also be followed if the vehicle is used for delivery service, police, taxi or other commercial applications.

ITEM NO.	TO BE SERVICED <i>See Explanation of Scheduled Maintenance Services following Schedules I and II.</i>	WHEN TO PERFORM <i>Miles (kilometers) or Months (whichever occurs first).</i>
1	Engine Oil Change & Oil Filter Change*	Every 3,000 Miles (5 000 km) or 3 Months.
2	Chassis Lubrication	Every 3,000 Miles (5 000 km) or 12 Months.
3	Tire and Wheel Inspection & Rotation	At 6,000 Miles (10 000 km) and every 15,000 Miles (25 000 km) or as necessary.
4	Engine Accessory Drive Belt Inspection	Every 60,000 Miles (100 000 km).
5	Cooling System Service*	Every 30,000 Miles (50 000 km) or 24 Months.
6	Transmission Service	<i>See Explanation of Scheduled Maintenance Services following Schedules I and II.</i>
7	Spark Plug Replacement*	Every 30,000 Miles (50 000 km).
8	Spark Plug Wire Inspection*†	Every 60,000 Miles (100 000 km).
9	Air Cleaner Filter Replacement*	Every 30,000 Miles (50 000 km).
10	Fuel Tank, Cap & Lines Inspection*†	Every 60,000 Miles (100 000 km).
11	PCV System Inspection*†	Every 60,000 Miles (100 000 km).
12	Fuel Filter Replacement*†	Every 30,000 Miles (50 000 km).
13	Engine Timing and Distributor Check*†	Every 60,000 Miles (100 000 km).
14	Differential (Axle) Service	Every 3,000 Miles (5 000 km). Also change locking rear differential fluid at first oil change.
15	Brake Systems Inspection	<i>See Explanation of Scheduled Maintenance Services following Schedules I and II.</i>
16	Transfer Case Fluid Change	<i>See Explanation of Scheduled Maintenance Services following Schedules I and II.</i>

The services shown on this chart up to 60,000 miles (100 000 km) should be performed after 60,000 miles at the same intervals.

MILES (000)

3 6 9 12 15 18 21 24 27 30 33 36 39 42 45 48 51 54 57 60

KILOMETERS (000)

5 10 15 20 25 30 35 40 45 50 55 60 65 70 75 80 85 90 95 100

*	*	*	*	*	*	*	*	*	*	*	*	*	*	*	*	*	*	*	*	*
*	*	*	*	*	*	*	*	*	*	*	*	*	*	*	*	*	*	*	*	*
	*					*					*					*				
																				*
										*										*
																				*
										*										*
																				*
										*										*
																				*
*	*	*	*	*	*	*	*	*	*	*	*	*	*	*	*	*	*	*	*	*

* = An Emission Control Service.

† = The U.S. Environmental Protection Agency or the California Air Resources Board has determined that the failure to perform this maintenance item will not nullify the emission warranty or limit recall liability prior to the completion of vehicle useful life. General Motors, however, urges that all recommended maintenance services be performed at the indicated intervals and the maintenance be recorded in "Section E-Maintenance Record."

Maintenance Schedule

Schedule II

Follow Schedule II ONLY if none of the driving conditions specified in Schedule I apply.

ITEM NO.	TO BE SERVICED <i>See Explanation of Scheduled Maintenance Services following Schedules I and II.</i>	WHEN TO PERFORM <i>Miles (kilometers) or Months (whichever occurs first).</i>
1	Engine Oil Change*	Every 7,500 Miles (12,500 km) or 12 Months
	Oil Filter Change*	At first and every other oil change.
2	Chassis Lubrication	Every 7,500 Miles (12,500 km) or 12 Months.
3	Tire and Wheel Inspection & Rotation	At 7,500 Miles (12,500 km) and every 15,000 Miles (25,000 km) or as necessary.
4	Engine Accessory Drive Belt Inspection	Every 60,000 Miles (100,000 km).
5	Cooling System Service*	Every 30,000 Miles (50,000 km) or 24 Months.
6	Transmission Service	<i>See Explanation of Scheduled Maintenance Services following Schedules I and II.</i>
7	Spark Plug Replacement*	Every 30,000 Miles (50,000 km).
8	Spark Plug Wire Inspection*†	Every 60,000 Miles (100,000 km).
9	Air Cleaner Filter Replacement*	Every 30,000 Miles (50,000 km).
10	Fuel Tank, Cap & Lines Inspection*†	Every 60,000 Miles (100,000 km).
11	PCV System Inspection*†	Every 60,000 Miles (100,000 km).
12	Fuel Filter Replacement*†	Every 30,000 Miles (50,000 km).
13	Engine Timing and Distributor Check*†	Every 60,000 Miles (100,000 km).
14	Differential (Axle) Service	Every 7,500 Miles (12,500 km). Also change locking rear differential fluid at first oil change.
15	Brake Systems Inspection	<i>See Explanation of Scheduled Maintenance Services following Schedules I and II.</i>
16	Transfer Case Fluid Change	<i>See Explanation of Scheduled Maintenance Services following Schedules I and II.</i>

Maintenance Schedule

Explanation of Scheduled Maintenance Services

Below are explanations of the services listed in Schedule I and Schedule II.

The proper fluids and lubricants to use are listed in Section D. Make sure whoever services your vehicle uses these. All parts should be replaced and all necessary repairs done before you or anyone else drives the vehicle.

ITEM SERVICE NO.

- 1. Engine Oil and Filter Change*** — Always use SH or SG Energy Conserving II oils of proper viscosity. The "SH" or "SG" designation may be shown alone or in combination with others, such as "SH/CD," "SH, SG, CD," "SG/CD," etc. To determine the preferred viscosity for your vehicle's engine (e.g., SAE 5W-30 or SAE 10W-30), see the *Index* under *Engine Oil*.
- 2. Chassis Lubrication** — Lubricate the transmission shift linkage, parking brake cable guides, underbody contact points and linkage. Lubricate the front suspension and steering linkage.

- 3. Tire and Wheel Rotation and Inspection** — For proper wear and maximum tire life, rotate your tires following the instructions in this manual. See *Tires, Inspection & Rotation* in the *Index*. Check the tires for uneven wear or damage. If you see irregular or premature wear, check the wheel alignment. Check for damaged wheels also.
- 4. Engine Accessory Drive Belt Inspection** — Inspect the drive belt for cracks, fraying, wear and proper tension. Replace as needed.
- 5. Cooling System Service*** — Drain, flush and refill the system with new or approved recycled coolant conforming to GM Specification 6038-M. Keep coolant at the proper mixture as specified. See *Coolant* in the *Index*. This provides proper freeze and boil protection, corrosion inhibitor level and maintains proper engine operating temperature. Inspect hoses and replace if they are cracked, swollen or deteriorated. Tighten screw-type hose clamps. Clean the outside of the radiator and air conditioning condenser. Wash the pressure cap and neck.

To help ensure proper operation, we recommend a pressure test of both the cooling system and the pressure cap.

- 6. Transmission Service** — Change both the fluid and filter every 15,000 miles (25 000 km) if the vehicle is mainly driven under one or more of these conditions:
 - In heavy city traffic where the outside temperature regularly reaches 90°F (32°C) or higher.
 - In hilly or mountainous terrain.
 - When doing frequent trailer towing.
 - Uses such as found in taxi, police car or delivery service.

If you do not use your vehicle under any of these conditions, change both the fluid and filter every 100,000 miles (166 000 km).

- 7. Spark Plug Replacement*** — Replace spark plugs with the proper type. See *Replacement Parts* in the *Index*.
- 8. Spark Plug Wire Inspection*†** — Inspect for burns, cracks or other damage. Check the boot fit at the coils and at the spark plugs. Replace wires as needed.

9. Air Cleaner Filter Replacement* — Replace every 30,000 miles (50 000 km) or more often under dusty conditions. Ask your dealer for the proper replacement intervals for your driving conditions.

10. Fuel Tank, Cap and Lines

Inspection*† — Inspect fuel tank, cap and lines (including fuel rails and injection assembly) for damage or leaks. Inspect fuel cap gasket for an even filler neck imprint or any damage. Replace parts as needed.

11. Positive Crankcase Ventilation (PCV) System Inspection*† —

Inspect the system for proper function. Replace any worn, plugged or collapsed hoses and seals. Replace valve only if necessary.

12. Fuel Filter Replacement*† —

Replace the fuel filter every 30,000 miles (50 000 km), or sooner if clogged.

13. Engine Timing and Distributor

Check*† — Adjust the timing to the underhood label specifications. Inspect the inside and outside of the distributor cap and rotor for cracks,

carbon tracking and corrosion. Clean or replace as needed.

14. Differential (Axle) Service—Check rear/front differential fluid level and add as needed. Check constant velocity joints and axle seals for leaking.

Locking Rear Differential —Drain fluid at first engine oil change and refill. Check fluid level and add as needed at subsequent oil changes. In dusty areas, or trailer towing applications, drain fluid at every 15,000 miles (25 000 km) and refill. More frequent lubrication may be required during heavy-duty or off-road use. A fluid loss in this system may indicate a problem. Have it inspected and repaired at once.

15. Brake Systems Inspection—When the engine oil is changed, inspect the lines and hoses for proper hookup, binding, leaks, cracks, chafing, etc. Check the parking brake adjustment and the fluid level in the master cylinder. A low brake fluid level can indicate worn disc brake pads which may need to be serviced. A fluid loss in this system

may indicate a problem. See the *Index* under *Brake System Warning Light*. When the wheels are removed for rotation, inspect disc brake pads for wear and rotors for surface condition. Also inspect drum brake linings for wear and cracks. Inspect other brake parts, including drums, wheel cylinders, calipers, parking brake, etc. at the same time.

You may need to have your brakes inspected more often if your driving habits or conditions result in frequent braking.

16. Transfer Case Fluid Change —In heavy or frequent trailer towing applications, drain fluid and refill every 30,000 miles (50 000 km).

* = An Emission Control Service.

† = The U.S. Environmental Protection Agency or the California Air Resources Board has determined that the failure to perform this maintenance item will not nullify the emission warranty or limit recall liability prior to the completion of vehicle useful life. General Motors, however, urges that all recommended maintenance services be performed at the indicated intervals and the maintenance be recorded in "Section E: Maintenance Record."

Maintenance Schedule

■ Section B: Owner Checks and Services

Listed below are owner checks and services which should be performed at the intervals specified to help ensure the safety, dependability and emission control performance of your vehicle.

Be sure any necessary repairs are completed at once. Whenever any fluids or lubricants are added to your vehicle, make sure they are the proper ones, as shown in Section D.

At Each Fuel Fill (It is important for you or a service station attendant to perform these underhood checks at each fuel fill.)

CHECK OR SERVICE	WHAT TO DO
Engine Oil Level	Check the engine oil level and add the proper oil if necessary. See <i>Engine Oil</i> in the <i>Index</i> for further details.
Engine Coolant Level	Check the engine coolant level and add the proper coolant mix if necessary. See <i>Coolant</i> in the <i>Index</i> for further details.
Windshield Washer Fluid Level	Check the windshield washer fluid level in the windshield washer tank and add the proper fluid if necessary. See <i>Windshield Washer Fluid</i> in the <i>Index</i> for further details.

At Least Once a Month

CHECK OR SERVICE	WHAT TO DO
Tire Inflation	Check tire inflation. Make sure they are inflated to the pressures specified on the Certification/Tire label located on the rear edge of the driver's door. See <i>Tires</i> in the <i>Index</i> for further details.
Cassette Deck	Clean cassette deck. Cleaning should be done every 15 hours of tape play. See <i>Audio Systems</i> in the <i>Index</i> for further details.

At Least Once a Year

CHECK OR SERVICE	WHAT TO DO
Key Lock Cylinders	Lubricate the key lock cylinders with the lubricant specified in Section D.
Body Lubrication	Lubricate all body door hinges including the tailgate. Also lubricate all hinges and latches, including those for the hood, rear compartment, glove box door, console door and any folding seat hardware. Section D tells you what to use.
Starter Switch	<p>CAUTION: When you are doing this check, the vehicle could move suddenly. If it does, you or others could be injured. Follow the steps below.</p> <ol style="list-style-type: none">1. Before you start, be sure you have enough room around the vehicle.2. Firmly apply both the parking brake (see <i>Parking Brake</i> in the <i>Index</i> if necessary) and the regular brake. <p>NOTE: Do not use the accelerator pedal, and be ready to turn off the engine immediately if it starts.</p> <ol style="list-style-type: none">3. Try to start the engine in each gear. The starter should work only in P (Park) or N (Neutral). If the starter works in any other position, your vehicle needs service.
Steering Column Lock	<p>While parked, and with the parking brake set, try to turn the key to LOCK in each shift lever position.</p> <ul style="list-style-type: none">• The key should turn to LOCK only when the shift lever is in P (Park).• The key should come out only in LOCK.

Maintenance Schedule

At Least Once a Year (Cont.)

CHECK OR SERVICE	WHAT TO DO
Parking Brake and Automatic Transmission P (Park) Mechanism Check	<p>CAUTION: When you are doing this check, your vehicle could begin to move. You or others could be injured and property could be damaged. Make sure there is room in front of your vehicle in case it begins to roll. Be ready to apply the regular brake at once should the vehicle begin to move.</p> <p>Park on a fairly steep hill, with the vehicle facing downhill. Keeping your foot on the regular brake, set the parking brake.</p> <ul style="list-style-type: none">• To check the parking brake: With the engine running and transmission in N (Neutral), slowly remove foot pressure from the regular brake pedal. Do this until the vehicle is held by the parking brake only.• To check the P (Park) mechanism's holding ability: Shift to P (Park). Then release all brakes.
Underbody Flushing	At least every spring, use plain water to flush any corrosive materials from the underbody. Take care to clean thoroughly any areas where mud and other debris can collect.
Differential Service	Check rear/front differential fluid level and add as needed. Check constant velocity joints and axle seals for leaking.
Transfer Case	Check transfer case fluid level. Check vent hose at transfer case for kinks and proper installation. More frequent lubrication may be required on heavy-duty off-road use. A fluid loss may indicate a problem. Have it inspected and repaired at once.

■ Section C: Periodic Maintenance Inspections

Listed below are inspections and services which should be performed at least twice a year (for instance, each spring and fall). You should let your GM dealer's service department or other qualified service center do these jobs. Make sure any necessary repairs are completed at once.

INSPECTION OR SERVICE	WHAT SHOULD BE DONE
Restraint Systems	Now and then, make sure all your belts, buckles, latch plates, retractors, anchorages and reminder systems are working properly. Look for any loose parts or damage. If you see anything that might keep a restraint system from doing its job, have it repaired.
Steering, Suspension and Rear-Wheel-Drive Axle Boot and Seal Inspection	Inspect the front and rear suspension and steering system for damaged, loose or missing parts, signs of wear, or lack of lubrication. Inspect the power steering lines and hoses for proper hook-up, binding, leaks, cracks, chafing, etc. Clean and then inspect the drive axle boot seals for damage, tears or leakage. Replace seals if necessary.
Exhaust System Inspection	Inspect the complete exhaust system. Inspect the body near the exhaust system. Look for broken, damaged, missing or out-of-position parts as well as open seams, holes, loose connections, or other conditions which could cause a heat build-up in the floor pan or could let exhaust fumes into the vehicle. See <i>Engine Exhaust</i> in the <i>Index</i> .

Maintenance Schedule

INSPECTION OR SERVICE	WHAT SHOULD BE DONE
Throttle Linkage Inspection	Inspect the throttle linkage for interference or binding, and for damaged or missing parts. Replace parts as needed.
Brake System Inspection	Inspect the complete system. Inspect brake lines and hoses for proper hook-up, binding, leaks, cracks, chafing, etc. Inspect disc brake pads for wear and rotors for surface condition. Also inspect drum brake linings for wear and cracks. Inspect other brake parts, including drums, wheel cylinders, calipers, parking brake, etc. Check parking brake adjustment. You may need to have your brakes inspected more often if your driving habits or conditions result in frequent braking. NOTE: A low brake fluid level can indicate worn disc brake pads which may need to be serviced. Also, if the brake system warning light stays on or comes on, something may be wrong with the brake system. See the <i>Index</i> under <i>Brake System Warning Light</i> . If your anti-lock brake system warning light stays on or comes on, something may be wrong with the anti-lock brake system. See the <i>Index</i> under <i>Anti-Lock Brake System Warning Light</i> .

■ Section D: Recommended Fluids & Lubricants

NOTE: Fluids and lubricants identified below by name, part number or specification may be obtained from your GM dealer.

USAGE	FLUID/LUBRICANT
Engine Oil	API service SH or SG Energy Conserving II oils of the proper viscosity. The "SH" or "SG" designation may be shown alone or in combination with others, such as "SH/CD," "SH,SG,CD," "SG/CD," etc. To determine the preferred viscosity for your vehicle's engine, see <i>Engine Oil</i> in the <i>Index</i> .
Engine Coolant	A 50/50 mixture of water (preferably distilled) and good quality ethylene glycol base antifreeze (GM Part No. 1052103 or equivalent) conforming to GM Specification 6038-M.
Hydraulic Brake System	Delco Supreme 11 [®] Brake Fluid (GM Part No. 1052535 or equivalent DOT-3 brake fluid).
Parking Brake Guides	Chassis lubricant (GM Part No. 1052497 or equivalent) or lubricant meeting requirements of NLGI Grade 2, Category LB or GC-LB.
Power Steering System	GM Hydraulic Power Steering Fluid (GM Part No. 1052884 or equivalent).
Automatic Transmission	DEXRON [®] -III or DEXRON [®] -IIE Automatic Transmission Fluid.
Locking Differential	SAE 80W-90 Gear Lubricant (GM Part No. 1052271).
Key Lock Cylinders	Lubricate with Multi-Purpose Lubricant (GM Part No. 12345120), synthetic SAE 5W-30 engine oil.
Automatic Transmission Shift Linkage	Engine oil.

Maintenance Schedule

USAGE	FLUID/LUBRICANT
Transfer Case	DEXRON [®] -III or DEXRON [®] -III-E Automatic Transmission Fluid (GM Part No. 12345881).
Chassis Lubrication	Chassis lubricant (GM Part No. 1052497 or equivalent) or lubricant meeting requirements of NLGI Grade 2, Category LB or GC-LB.
Windshield Washer Solvent	GM Optikleen [®] Washer Solvent (GM Part No. 1051515) or equivalent.
Hood Latch Assembly a. Pivots and Spring Anchor b. Release Pawl	a. Engine oil. b. Chassis lubricant meeting requirements of NLGI Grade 2, Category LB (GM Part No. 1052497 or equivalent) or GC-LB.
Hood, Door and Tailgate Hinges, Rear Folding Seat, Fuel Door Hinge, Rear Compartment Lid Hinges	Engine oil or Lubriplate Lubricant (GM Part No. 1050109).
Weatherstrips	Dielectric Silicone Grease (GM Part No. 12345579 or equivalent).
Tailgate Mounted Spare Tire Carrier (if equipped)	Multi-purpose lubricant meeting requirements of GM Part No. 12345120.

See *Replacement Parts* in the *Index* for recommended replacement filters, valves and spark plugs.

■ *Section E: Maintenance Record*

After the scheduled services are performed, record the date, odometer reading and who performed the service in the columns indicated. When completing the Maintenance Performed column, insert the numbers from the Schedule I or Schedule II maintenance charts which correspond to the maintenance performed. Also, you should retain all maintenance receipts. Your owner information portfolio is a convenient place to store them.

<i>DATE</i>	<i>ODOMETER READING</i>	<i>SERVICED BY</i>	<i>MAINTENANCE PERFORMED</i>



Here you will find out how to contact Oldsmobile if you need assistance. This part also tells you how to obtain service publications and how to report any safety defects.

Part 8

Customer Assistance Information

Customer Satisfaction Procedure.....	222
Customer Assistance for the Hearing or Speech Impaired	223
BBB Auto Line Program.....	223
Reporting Safety Defects	224
Oldsmobile Roadside Assistance Program.....	225
Service Publications	225

Customer Assistance Information



■ Customer Satisfaction Procedure

Your satisfaction and goodwill are important to your dealer and Oldsmobile. Normally, any concern with the sales transaction or the operation of your vehicle will be resolved by your dealer's Sales or Service Departments. Sometimes, however, despite the best intentions of all concerned, misunderstandings can occur. If your concern has not been resolved to your satisfaction, the following steps should be taken:

STEP ONE — Discuss your concern with a member of dealership management. Complaints can often be quickly resolved at that level. If the

matter has already been reviewed with the Sales, Service, or Parts Manager, contact the owner of the dealership or the General Manager.

STEP TWO — If after contacting a member of dealership management, it appears your concern cannot be resolved by the dealership without further help, contact the Oldsmobile Customer Assistance Network by calling 1-800-442-6537. In Canada, contact GM of Canada Customer Assistance Center in Oshawa by calling 1-800-263-3777 (English) or 1-800-263-7854 (French).

In Mexico, call (525) 254-3777. In Puerto Rico or U.S. Virgin Islands, call 1-809-763-1315. In all other overseas locations, contact GM North American Export Sales in Canada by calling 1-416-644-4112.

For prompt assistance, please have the following information available to give the Customer Assistance Representative:

- Your name, address, telephone number
- Vehicle Identification Number (This is available from the vehicle registration or title, or the plate at the

left top of the instrument panel and visible through the windshield.)

- Dealership name and location
- Vehicle delivery date and present mileage
- Nature of concern

We encourage you to call the toll free number listed previously in order to give your inquiry prompt attention. However, if you wish to write Oldsmobile, write to

United States

Customer Assistance Representative
Oldsmobile Central Office
920 Townsend St.
P.O. Box 30095
Lansing, MI 48909

Canada

Customer Assistance Center
General Motors of Canada Limited
1908 Colonel Sam Drive
Oshawa, Ontario L1H 8P7

When contacting Oldsmobile, please remember that your concern will likely be resolved in the dealership, using the dealership's facilities, equipment and personnel. That is why we suggest you follow Step One first if you have a concern.

■ *Customer Assistance for the Hearing or Speech Impaired (TDD)*

To assist owners who have hearing difficulties, Oldsmobile has installed special TDD (Telecommunication Devices for the Deaf) equipment at its Customer Assistance Center. Any hearing or speech impaired customer who has access to a TDD or a conventional teletypewriter (TTY) can communicate with Oldsmobile by dialing: 1-800-TDD-OLDS. (TDD users in Canada can dial 1-800-263-3850.)

■ *GM Participation in BBB AUTO LINE- Alternative Resolution Program**

Both Oldsmobile and your Oldsmobile dealer are committed to making sure you are completely satisfied with your new vehicle. If a situation arises where you feel your concern has not been adequately addressed, our experience has shown that the Customer Satisfaction Procedure described earlier

in this section is very successful at resolving problems.

There may be instances where an impartial third-party can assist in arriving at a solution to a disagreement regarding vehicle repairs or interpretation of the New Vehicle Limited Warranty. To assist in resolving these disagreements Oldsmobile voluntarily participates in BBB AUTO LINE.

BBB AUTO LINE is an out-of-court program administered by the Better Business Bureau system to settle disputes between customers and automobile manufacturers. This program is available free of charge to customers who currently own or lease a GM vehicle.

If you are not satisfied after following the Customer Satisfaction Procedure, you may contact the BBB using the toll-free telephone number, or write them at the following address:

BBB AUTO LINE
Council of Better Business Bureaus
4200 Wilson Boulevard
Suite 800
Arlington, VA 22203
Telephone: 1-800-955-5100

To file a claim, you will be asked to provide your name and address, your vehicle identification number (VIN), and a statement of the nature of your complaint. Eligibility is limited by vehicle age and mileage, and other factors.

We prefer you utilize the Customer Satisfaction Procedure before you resort to AUTO LINE, but you may contact the BBB at any time. The BBB will attempt to resolve the complaint serving as an intermediary between you and Oldsmobile. If this mediation is unsuccessful, an informal hearing will be scheduled where eligible customers may present their case to an impartial third-party arbitrator.

The arbitrator will make a decision which you may accept or reject. If you accept the decision, GM will be bound by that decision. The entire dispute resolution procedure should ordinarily take about forty days from the time you file a claim until a decision is made.

Customer Assistance Information

Some state laws may require you to use this program before filing a claim with a state-run arbitration program or in the courts. For further information, contact the BBB or the Oldsmobile Customer Assistance Center at **1-800-442-6537**.

** This program may not be available in all states, depending on state law. Canadian owners refer to your Warranty and Owner Assistance information booklet. General Motors reserves the right to change eligibility limitations and/or to discontinue its participation in this program.*

■ **REPORTING SAFETY DEFECTS TO THE UNITED STATES GOVERNMENT**

If you believe that your vehicle has a defect which could cause a crash or could cause injury or death, you should immediately inform the National Highway Traffic Safety Administration (NHTSA), in addition to notifying General Motors.

If NHTSA receives similar complaints, it may open an investigation, and if it finds that a safety defect exists in a group of vehicles, it may order a recall and remedy campaign. However,

NHTSA cannot become involved in individual problems between you, your dealer, or General Motors.

To contact NHTSA, you may either call the Auto Safety Hotline toll-free at 1-800-424-9393 (or 366-0123 in the Washington, D.C. area) or write to:

NHTSA
U.S. Department of Transportation
Washington, D.C. 20590

You can also obtain other information about motor vehicle safety from the Hotline.

■ **REPORTING SAFETY DEFECTS TO THE CANADIAN GOVERNMENT**

If you live in Canada, and you believe that your vehicle has a safety defect, you should immediately notify Transport Canada, in addition to notifying General Motors of Canada Limited. You may write to:

Transport Canada
Box 8880
Ottawa, Ontario K1G 3J2.

■ **REPORTING SAFETY DEFECTS TO GENERAL MOTORS**

In addition to notifying NHTSA (or Transport Canada) in a situation like this, we certainly hope you'll notify us. Please call us at **1-800-442-6537**, or write:

Oldsmobile Customer Assistance
Network
P.O. Box 30095
Lansing, MI 48909

In Canada, please call us at 1-800-263-3777 (English) or 1-800-263-7854 (French). Or, write:
General Motors of Canada Limited
Customer Assistance Center
1908 Colonel Sam Drive
Oshawa, Ontario L1H 8P7



■ *Oldsmobile Roadside Assistance Program Features & Benefits*

The Oldsmobile Roadside Assistance program means help is just a toll-free call away—24 hours a day, 365 days a year.

Courteous and capable Customer Assistance Advisors are on-call to provide you with prompt assistance.

24-Hour Oldsmobile Roadside Assistance Number

1-800-442-OLDS (6537) is the one number to call for assistance in the United States. Trained Customer Assistance Advisors, on-call to render assistance to Oldsmobile drivers, can

dispatch roadside assistance and towing service, locate the nearest Oldsmobile dealership, take your request for an Oldsmobile computerized trip routing or simply answer any questions the Oldsmobile driver may have about the coverage provided by your Oldsmobile Roadside Assistance Program. The Oldsmobile Roadside Assistance number is fully staffed and operational 24 hours a day, 365 days a year.

Who is Covered?

Oldsmobile Roadside Assistance covers all 1994 Oldsmobile vehicles.

Coverage is for the Oldsmobile vehicle, *regardless of the driver*, and is concurrent with the Bumper-to-Bumper warranty period.

Oldsmobile reserves the right to limit services or reimbursement to an owner or driver when in Oldsmobile's judgement the claims become excessive in frequency or type of occurrence.

■ *Service Publications*

Information on how to obtain Product Service Publications, Subscriptions and Indexes and Service Manuals as described below is applicable only in the fifty U.S. states (and the District of Columbia) and only for cars and light trucks with GVWR less than 10,000 pounds (4 536 kg).

In Canada, information pertaining to Product Service Bulletins and Indexes can be obtained by writing to:

General Motors of Canada Limited
Service Publications Department
1908 Colonel Sam Dr.
Oshawa, Ontario L1H 8P7

Oldsmobile regularly sends its dealers useful service bulletins about Oldsmobile products. Oldsmobile monitors product performance in the field. We then prepare bulletins for servicing our products better. Now, you can get these bulletins too.

Customer Assistance Information

Bulletins cover various subjects. Some pertain to the proper use and care of your vehicle. Some describe costly repairs. Others describe inexpensive repairs which, if done on time with the latest parts, may avoid future costly repairs. Some bulletins tell a technician how to repair a new or unexpected condition. Others describe a quicker way to fix your vehicle. They can help a technician service your vehicle better.

Most bulletins apply to conditions affecting a small number of cars or trucks. Your Oldsmobile dealer or a qualified technician may have to determine if a specific bulletin applies to your vehicle.

You can subscribe to all Oldsmobile bulletins. This way you'll get them as they come out. You can wait a while and get an index to the bulletins. You can also get individual bulletins. However, you'll need the index to identify them.

Subscriptions

You can subscribe to all Oldsmobile Product Service Publications (PSP's). This will include bulletins for all vehicles sold by Oldsmobile and will not be limited to PSP's applicable to any particular model.

For subscription costs and ordering information call the toll-free number shown in the following text.

What You'll Find in the Index

- A list of all PSP's published by Oldsmobile in a model year (1990 or later). PSP's covering all models of Oldsmobile vehicles are listed in the same index.
- Price information for the PSP's you may want to buy.

How You Can Get an Index

Indexes are published periodically. Most of the PSP's which could potentially apply to the most recent Oldsmobile models will be listed in the most recent publication for that model year. This means you may want to wait until the end of the model year before ordering an index, if you are interested in buying PSP's pertaining to a current model year car or truck.

Some PSP's pertaining to a particular model year vehicle may be published in later years, and these would be listed in the later year's index. When you order an index for a model year that is not over yet, we'll send you the most recently published issue.

Toll-Free Telephone Number

If you want an ordering form for an index or a subscription, just call toll-free and we'll be happy to send you one. Automated recording equipment will take your name and mailing address. The number to call is 1-800-551-4123.

Copies at Participating Dealers

Copies of Indexes and PSP's are at your participating Oldsmobile dealer. You can ask to see them.

A VERY IMPORTANT REMINDER:
These PSP's are meant for technicians. They are not meant for the "do-it-yourselfer." Technicians have the equipment, tools, safety instructions, and know-how to do a job quickly and safely.

Oldsmobile Service Manuals

For Service Manual cost and ordering information call 1-800-551-4123.

Product Service Publication Ordering Information

Oldsmobile Division service publications are intended for use by professional, qualified technicians. Attempting repairs or service without the appropriate training, tools, and equipment could cause injury to you or others and damage to your vehicle that may cause it not to operate properly.

Available publications include Service Manuals, Product Service Publication indexes, quarterly and model year PSP's and binders. For 1994 Product Service Publication pricing information and orders call 1-800-551-4123.

Notes

Notes

Notes

Index

- A**BS Warning Light 88
Accelerator Control System 185
Accessory Belt Drive 184
Accessory Power Outlets 71
Adding
 Automatic Transmission
 Fluid 176, 199, 201
 Brake Fluid 178, 201
 Electrical Equipment 46, 95, 196
 Engine Coolant 174, 177, 199, 201
 Engine Oil 168, 199, 201
 Power Steering Fluid 176, 201
 Windshield Washer Fluid 177, 201
Add-On Equipment 184
Air Cleaner 171, 200
Air Conditioner 92, 184
Alcohol, Driving Under the
 Influence of 106
Alcohol in Gasoline 163
All-Wheel Drive 108
Aluminum Wheels, Cleaning 194
Antenna 103
Antifreeze 174, 199, 201
Anti-Lock Brakes (ABS)
 Using ABS 110
 Warning Light 88
Appearance Care 190
Ashtrays and Lighter 73
Audio Systems 95
 AM/FM Stereo Radio with
 Cassette Player & Equalizer 96
 AM/FM Stereo Radio with
 Compact Disc Player 98
 Care of Compact Discs 102
 Care of Cassette Player 102
 Radio Reception, For the Best 101
 Setting the Clock 95
Automatic Transmission
 Adding Fluid 173
 Checking Fluid 172
 Shifting 48
Battery 180
 Jump Starting 140
 Light 87, 90
Belt, Accessory Drive 184
Blizzard 131
Block Heater, Engine 47, 170
Blowout, Tire 151
Brake
 Adjustment 179
 Fluid 178, 201
 Master Cylinder 178
 Parking 51
 Rear Drum 179
 Replacing Brake System Parts 179
 Warning Light 88
 Wear Indicators 179
Brake System Warning Light 88
Brakes, Anti-Lock 110
Braking 109
Braking in Emergencies 111
Braking Technique 109
Break-In, New Vehicle 44, 132
Buckling Up (see *Safety Belts*)
Bulb Replacement
 Fog Light 182
 Headlight 181
 Taillight 182
Bulbs, Replacement 202
Capacities & Specifications 199
Carbon Monoxide in
 Exhaust 53, 54, 131, 135
Cargo Bed Liner 75
Cassette Tape Player
 (see *Audio Systems*)
CD Player (see *Audio Systems*)
Center Passenger Position
 (see *Safety Belts*)
Certification/Tire Label 186
Chains, Tire 190
Changing a Flat Tire 151
Checking
 Brake Fluid 178
 Engine Coolant 174
 Engine Oil 168

Index

- Power Steering Fluid 176
Safety Belt Systems 34
Transmission Fluid 172
Checking Things Under the Hood ... 165
Child Restraints 26
Children and Safety Belts 25
Cigarette Lighter 73
Circuit Breakers & Fuses 196
City Driving 126
Cleaner, Air 171, 200
Cleaning
 Aluminum Wheels 194
 Antenna 103
 Cassette Player 102
 Fabric 191
 Glass 192
 Inside of Your Vehicle 190
 Outside of Your Vehicle 193
 Safety Belts 192
 Special Problems 191
 Underbody Maintenance 194
 Vinyl or Leather 192
 Warnings 192, 193, 194, 196
 Weatherstrips 194
 Windshield 193
Climate Controls 92
Clock, Setting the 95
Clusters, Instrument Panel 78
Coin Holder 72
Comfort Controls 92
Air Conditioner 92, 184
 Heater 92
 Ventilation 94
Compass 64
Console Storage 64, 71
Control of a Vehicle 108
Convex Outside Mirror 70
Coolant 176, 203
 Checking & Adding 149, 177
 Proper Mixture to Use 149, 177
 Safety Warnings About 149, 177, 178
 Temperature Gage 85, 88
Cruise Control 59
Cup Holder 71
Curves, Driving on 111
Customer Assistance Information 221
Dead Battery: What to Do 140
Defensive Driving 106
Defogger, Rear Window 94
Defrosting 93
Dome Lights 68
Door Locks 39
Driver Position 18
Driving
 At Night 124
 City 126
 Controlling a Skid 114
 Defensively 106
 Drunken 106
Freeway 127
Guidelines 115
Hill and Mountain 118, 129
In a Foreign Country 164
In Mud, Sand, Snow, or Ice 122
In the Rain 125
In Water 123
Long Distance 128
Loss of Control 114
Off-Road 115, 123
On Curves 111
On Inclines 121
Passing 113
Through Deep Standing Water 46
Winter Driving 130
 With a Trailer 132
Drunken Driving 106
Electric Outside Mirror Control 70
Electrical Equipment,
 Adding 46, 95, 196
Electronic Cluster 79
Emergencies, Braking in 111
Emergencies on the Road 139
Emergencies, Steering in 112
Emergency Starting 140
Emergency Towing 144
E/M Switch 83
Engine Block Heater 47, 170
Engine Coolant 174, 201

Engine Coolant Heater.....	47, 170	Filling the Fuel Tank.....	165	Fuse Panel.....	197
Engine Coolant Temperature		Filter		Fuses & Circuit Breakers.....	196
Gage.....	85, 88	Air Cleaner.....	171, 200	G ages	
Engine Exhaust.....	53, 54, 131, 135	Fuel.....	200	Coolant Temperature.....	85, 88
Engine Identification.....	195	Oil.....	170, 200	Fuel.....	83, 85
Engine Oil.....	168	Flashers, Hazard Warning.....	140	Oil Pressure.....	84, 86
Additives.....	170	Flat Tire.....	151	Voltmeter.....	85, 87
Capacity.....	199	Flooded Engine.....	46	Gasoline.....	163
Checking & Adding.....	168	Fluid		Gasoline Tank, Filling Your.....	165
Disposing of Used Oil.....	170	Brake.....	178, 201	Gas Station Information.....	240
Energy Conserving.....	169	Capacities.....	199	Gear Positions	
Pressure Gage.....	84, 86	Power Steering.....	176, 201	(see <i>Shifting the Transmission</i>)	
When to Change.....	170	Transmission.....	174, 201, 203	Gearshift Lever	
Engine Overheating.....	145	Windshield Washer.....	177, 201	(see <i>Shifting the Transmission</i>)	
Engine Specifications.....	200	Fluids & Lubricants.....	201	Glove Box.....	44
Engine, Starting.....	45	Fog Lights.....	63	Graphic Equalizer	
Ethanol in Gasoline.....	163	Folding Rear Seat.....	14	(see <i>Audio Systems</i>)	
Exhaust		Foreign Countries, Fuel In.....	164	Freeway Driving.....	127
Dangerous Gas in.....	53, 54, 131, 135	Front Axle.....	174	Front Reading Lights.....	68
Parking with the Engine Running...	54	Front Reading Lights.....	68	Fuel.....	163
Expectant Mothers, Use of		Fuel.....	163	Alcohol in Fuel.....	163
Safety Belts.....	21	Capacity.....	199, 240	Exhaust Warnings.....	53, 54, 131, 135
Expressway Driving.....	127	Filling Your Tank.....	165	Fuels with Alcohol.....	163
Extender, Safety Belt.....	34	Filling the Fuel Tank.....	165	Gage.....	83, 85
Exterior Appearance		Requirements.....	163	In Foreign Countries.....	164
(see <i>Appearance Care</i>)				Requirements.....	163
F abric Cleaning					
(see <i>Appearance Care</i>)					
Fan Warning.....	142				

Index

- Replacement Bulb 202
Wiring 198
Heater (see *Comfort Controls*)
Heater, Engine Block 47, 170
High Beams 62
Highway Hypnosis 128
Hill and Mountain Roads 118, 129
Hood Release 165
 Safety Warning 166
 Warning, Overheated
 Engine 145, 147, 148
Horn 54
Hot Engine, Safety
 Warnings 145, 147, 148
Hydroplaning 126
- I**dentification Number, Vehicle 195
Idling Your Engine 52, 54
If You're Stuck in Sand, Mud,
 Ice or Snow 158
Ignition
 Key 38
 Positions 45
Indicator Lights (see *Warning Lights*)
Infant Restraint (see *Child Restraints*)
Inflation, Tires 186
Inside Rearview Mirror 69
Instrument Panel 77
Instrument Panel Clusters 78
Instrument Panel Intensity Control 63
- Instrument Panel Warning Lights 80
- J**ack, Tire 152
Jump Starting 140
- K**eys 38
- L**ane Change Indicator 56
Lap-Shoulder Belt 18
 Front 18, 21
 Rear 22
 Use by Children 25
Lighter 73
Lights
 Center Dome 68
 Fog 63
 Headlights 62
 Interior 67
 Reading 67, 68
 Rear Dome 68
 Removing & Replacing Bulbs 181
 Replacement Bulbs 202
 Taillights 182
 Turn Signal 56
 Underhood 166
 Warning 80
Loading Your Vehicle 116, 183
Lock, Tailgate 42, 185
Locks, Door 39, 185
Locks, Power 40
- Long Distance Driving 128
Low Battery 140
Low Oil Pressure Warning 84, 86
Luggage Carrier 74
Lumbar Controls 12
- M**aintenance Record 219
Maintenance Schedule 206
Malfunction Indicator Lamp 89
Manual Front Seat 13
Methanol in Gasoline 163
Mileage Indicator
 (see *Odometer*)
Mirrors
 Convex Outside 70
 Inside Manual Day/Night 69
 Power Remote Control 70
 Visor Vanity 69
Mountain Driving 118, 129
- N**ew Vehicle "Break-In" 44, 132
Night Driving 124
- O**ctane Requirements
 (see *Fuel Requirements*)
Odometer and Trip Odometer 81, 82
Off-Road Driving 115, 123
Oil, Engine 168
 Capacity 199
 Disposing of Used Oil 170

Pressure Gage.....	84, 86	Power Steering.....	111	Replacing Wheels.....	189
Quality.....	169	Power Steering Fluid.....	176, 201	Restraints, Child.....	26
Thickness.....	169	Power Windows.....	55, 198	Roads, Hill and Mountain.....	129
When to Change.....	170	Pregnancy, Use of Safety Belts		Roadside Assistance Program.....	225
Operating Off-Road.....	115	During.....	21	Rocking Your Vehicle.....	158, 159
Operation of Lights.....	56	Problems on the Road.....	139	Rotation, Tire.....	187
Outside Rearview Mirrors.....	70	Publications		S afety Belts.....	14
Outside Temperature Display.....	64	(see <i>Service Publications</i>)		Adults.....	18
Overhead Console.....	64	R adiator Overheating		Center Passenger Position.....	24
Overheated Engine		(see <i>Overheated Engine</i>)		Checking.....	34
Warnings.....	145, 147, 148, 175, 176	Radiator Pressure Cap.....	146, 148, 176	Children.....	25, 32
Overheated Engine Coolant		Radio (see <i>Audio Systems</i>)		Child Restraints.....	26
Warning.....	145, 147, 148, 175, 176	Rain, Driving in the.....	125	Child Restraints, How to Install.....	26
Owner Checks & Services.....	212	Reading Lights.....	67, 68	Child Restraints, Where to Put.....	27
P ark, Shifting Into.....	51	Rear Axle.....	174	Cleaning.....	192
Parking		Rear Seat, Folding.....	14	Driver Position.....	18
Over Things That Burn.....	53	Rear Window Defogger.....	94	Extender.....	34
With the Engine Running.....	52, 54	Rear Window Wiper and Washer.....	59	How to Wear.....	18
Parking Brake.....	51	Rearview Mirror.....	69	Lap-Shoulder Belt.....	18
Passenger Belts (see <i>Safety Belts</i>)		Reclining Front Seatbacks.....	13	Larger Children.....	32
Passing.....	113	Recommended Fluids		Passenger Belts.....	21
Payload.....	184	& Lubricants.....	201, 217	Pregnancy, Use During.....	21
Periodic Maintenance Inspections.....	215	Remote Lock Control.....	40	Questions & Answers.....	17, 19, 20, 35
Polishing and Waxing		Replacement Bulbs.....	202	Rear Safety Belts.....	22
(see <i>Appearance Care</i>)		Replacement Fuses.....	197	Rear Seat Passengers.....	22
Power Door Locks.....	40	Replacement Parts.....	200	Reminder Light.....	17
Power Mirrors.....	70	Replacing Bulbs.....	181, 182	Replacement.....	34
Power Outlets, Accessory.....	71	Replacing Safety Belts.....	34	Right Front, Adult Passenger.....	21
Power Seat, Driver's.....	12	Replacing Tires.....	188	Smaller Children and Babies.....	25

Index

- | | | | | | |
|-------------------------------------------|--------|--------------------------------------------|---------|-----------------------------------------|-------------|
| Top Strap | 27 | Spare Tire | 43, 152 | Stuck, If You Are | 158 |
| Torn | 35 | Inside-Mounted | 152 | Sun Visors | 69 |
| Twisted | 20 | Tailgate-Mounted | 154 | T achometer | 83 |
| Why You Should Wear | | Spare Tire Carrier | 43 | Tailgate | 42, 43 |
| Safety Belts | 14 | Spark Plugs | 200 | Tape Player (see <i>Audio Systems</i>) | |
| Safety Defects, Reporting | 224 | Specifications & Capacities | 199 | Technical Facts & Specifications | |
| Scheduled Maintenance Services | 205 | Speed Control (see <i>Cruise Control</i>) | | Bulbs | 202 |
| Seat Adjustment | 12 | Speedometer | 80, 81 | Electrical Equipment, | |
| Seat Belts (see <i>Safety Belts</i>) | | Stains, Removing | 193 | Add-On | 46, 95, 196 |
| Seat Controls | 12 | Stalling on an Incline | 122 | Fluid Capacities & Types | 199, 201 |
| Lumbar Controls | 12 | Starting Your Engine | 45 | Fuses & Circuit Breakers | 196 |
| Manual Front Seat | 13 | Starting Your Vehicle if the Battery | | Service Parts Identification | |
| Power Front Seat | 12 | is "Dead" (see <i>Jump Starting</i>) | | Label | 195 |
| Rear Seat, Folding | 14 | Steering | | Vehicle Identification Number | |
| Reclining Seatback | 13 | In Emergencies | 112 | (VIN) | 195 |
| Service Engine Soon Light | 89 | Off-Road Recovery | 112 | Temperature Warning | 85, 88 |
| Service Information | 162 | Tips | 111 | Theft | 42 |
| Service Parts Identification Label | 195 | Steering Wheel, Tilt | 55 | Thermostat | 176 |
| Service Publications | 225 | Stereo Sound System | | Tilt Steering Wheel | 55 |
| Service Station Information | 240 | (see <i>Audio Systems</i>) | | Time, Setting the | 95 |
| Setting the Clock | 95 | Storage | | Tires | 185 |
| Setting the Trip Odometer | 81, 82 | Console | 71 | Blow Out | 151 |
| Shifting Into Park | 51 | Cup Holder | 71 | Buying New | 188 |
| Shifting the Automatic Transmission | 48 | Door Compartment/Coin Holder | 72 | Chains | 190 |
| Single Belt Accessory Drive | 184 | Garage Door Opener | 65 | Flat, Changing | 151 |
| Skidding | 114 | Glove Box | 44 | Inflation | 186 |
| Snowstorm, If You're Caught in a ... | 131 | Luggage Carrier | 74 | Inspection & Rotation | 187 |
| Sockets, Accessory Power | 71 | Overhead | 67 | Loading | 185 |
| Sound Equipment, Adding | 95 | Sunglasses | 67 | Pressure | 186 |
| Sound System (see <i>Audio Systems</i>) | | Storing Your Vehicle | 180 | | |

Quality Grading.....	188
Spare.....	152, 154
Wear Indicators.....	187
Wheel Alignment & Tire Balance.....	189
Wheel Nut Torque.....	157, 199
Wheel Replacement.....	189
When to Replace Wheels.....	189
Winter Driving.....	122
Top Strap.....	27
Torque Lock.....	53
Towing a Trailer.....	132
Towing Your Bravada.....	144
Trailer Towing.....	152, 184
Trailer Wiring Harness.....	137, 198
Trailer Package.....	184
Transmission, Automatic (see <i>Automatic Transmission</i>)	
Trip Odometer.....	81, 82
Turn Signal and Lane Change Indicator.....	56
Turn Signal/Multifunction Lever.....	55
Cruise Control.....	59
Headlight High-Low Beam Changer.....	62
Turn & Lane Change Indicator.....	56
Turn Signal Indicator.....	56
Windshield Washer.....	58
Windshield Wipers.....	57

U nderhood Light.....	166
Unleaded Gasoline.....	163
Upholstery Care.....	191
Urban Driving.....	126
V ehicle Identification Number (VIN).....	195
Vehicle Loading.....	116, 185
Vehicle Storage.....	180
Ventilation.....	94
VIN.....	195
Visor Vanity Mirror.....	69
Voltmeter.....	85, 87
W arning Flashers, Hazard.....	140
Warning Lights	
Anti-Lock Brake System.....	89
Battery.....	90
Brake.....	88
Check Gages.....	90
Malfunction Indicator Lamp (Service Engine Soon).....	89
Washer, Windshield.....	58
Weight (GAWR).....	183
Weight (GVWR).....	183
Wheel Alignment & Tire Balance.....	189
Wheel Nut Torque.....	157, 199
Wheel Replacement.....	189
Window, Tailgate.....	43

Windows, Power.....	55, 198
Windshield Washer Fluid... ..	58, 177, 201
Windshield Wiper Replacement.....	182
Windshield Wipers.....	57, 198
Winter Driving.....	130
If Your Vehicle is Stuck in Deep Snow.....	158
If You're Caught in a Blizzard.....	131
Wiper/Washer, Rear Window.....	59
Wiring Harness, Trailer.....	137, 198
Wrecker Towing.....	144

Service Station Information

