



Contents A - Z

OWNER'S MANUAL

MINI

MINI CLUBMAN



**COOPER
COOPER S
JOHN COOPER
WORKS**

Congratulations on your new MINI!

This Owner's Manual should be considered a permanent part of this vehicle. It should stay with the vehicle when sold to provide the next owner with important operating, safety and maintenance information.

We wish you an enjoyable driving experience.

© 2012 Bayerische Motoren Werke
Aktiengesellschaft
Munich, Germany

Reprinting, including excerpts, only with the
written consent of BMW AG, Munich.
US English II/12, 03 12 500

Printed on environmentally friendly paper,
bleached without chlorine, suitable for recycling.

CONTENTS

The fastest way to find information on a particular topic or item is by using the index, refer to page 254.

- 4 Notes
- 6 Reporting safety defects

AT A GLANCE 9

- 10 Cockpit
- 17 Onboard computer
- 21 Letters and numbers
- 22 Voice activation system

CONTROLS 27

- 28 Opening and closing
- 40 Adjustments
- 46 Transporting children safely
- 49 Driving
- 59 Controls overview
- 70 Technology for driving comfort and safety
- 83 Lamps
- 87 Climate
- 92 Practical interior accessories

DRIVING TIPS 101

- 102 Things to remember when driving

NAVIGATION 111

- 112 Navigation system
- 114 Destination entry
- 123 Route guidance
- 131 What to do if...

ENTERTAINMENT 133

- 134 On/off and tone
- 137 Radio
- 145 CD player
- 147 External devices

COMMUNICATIONS 157

- 158 Hands-free device Bluetooth
- 168 Mobile phone preparation Bluetooth
- 181 Office
- 189 MINI Connected

MOBILITY 193

- 194 Refueling
- 197 Wheels and tires
- 209 Engine compartment
- 213 Maintenance
- 215 Care
- 219 Replacing components
- 233 Giving and receiving assistance

REFERENCE 239

- 240 Technical data
- 247 Short commands for the voice activation system
- 254 Everything from A to Z

NOTES

USING THIS OWNER'S MANUAL

We have tried to make all the information in this Owner's Manual easy to find. The fastest way to find specific topics is to refer to the detailed index at the back of the manual. If you wish to gain an initial overview of your vehicle, you will find this in the first chapter.

Should you wish to sell your MINI at some time in the future, remember to hand over this Owner's Manual to the new owner; it is an important part of the vehicle.

Additional sources of information

Should you have any other questions, your MINI dealer will be glad to advise you at any time.

You can find more information about the MINI, for example on its technology, on the Internet at www.MINI.com.

SYMBOLS USED

 Indicates precautions that must be followed precisely in order to avoid the possibility of personal injury and serious damage to the vehicle. ◀

 Indicates information that will assist you in gaining the optimum benefit from your vehicle and enable you to care more effectively for your vehicle. ◀

 Refers to measures that can be taken to help protect the environment. ◀

◀ Marks the end of a specific item of information.

"..." Identifies Control Display texts used to select individual functions.

>...< Verbal instructions to use with the voice activation system.

>...< Identifies the answers generated by the voice activation system.

Symbols on vehicle components

 Indicates that you should consult the relevant section of this Owner's Manual for information on a particular part or assembly.

VEHICLE EQUIPMENT

The manufacturer of your MINI is the Bayerische Motoren Werke Aktiengesellschaft, BMW AG.

This Owner's Manual describes all models as well as all production, country and special equipment that is offered in the model range. Equipment is also described that is not available because of, for example, selected options or country version. This also applies to safety related functions and systems. For equipment and models that are not described in this Owner's Manual, please see the supplementary Owner's Manuals that are provided.

STATUS OF THIS OWNER'S MANUAL AT TIME OF PRINTING

The high level of safety and quality of the MINI vehicles is ensured through continuous development. In rare cases, there may be differences between the description and the vehicle.

FOR YOUR SAFETY

Maintenance and repair

 Advanced technology, e.g. the use of modern materials and high-performance electronics, requires specially adapted maintenance and repair methods. Therefore, have the necessary work on your MINI only carried out by a MINI dealer or a workshop that has specially trained personnel working in accordance with the specifications of the MINI manufacturer. If this work is not carried out properly, there is a danger of subsequent damage and related safety hazards. ◀

Parts and accessories

 For your own safety, use genuine parts and accessories approved by the manufacturer of the MINI.

When you purchase accessories tested and approved by the manufacturer of the MINI and Original MINI Parts, you simultaneously acquire the assurance that they have been thoroughly tested by the manufacturer of the MINI to ensure optimum performance when installed on your vehicle.

The manufacturer of the MINI warrants these parts to be free from defects in material and workmanship.

The manufacturer of the MINI will not accept any liability for damage resulting from installation of parts and accessories not approved by the manufacturer of the MINI.

The manufacturer of the MINI cannot test every product made by other manufacturers to verify if it can be used on a MINI safely and without risk to either the vehicle, its operation, or its occupants.

Original MINI Parts, MINI Accessories and other products approved by the manufacturer of the MINI, together with professional advice on using these items, are available from all MINI dealers.

Installation and operation of accessories that have not been approved by the manufacturer of your MINI, such as alarms, radios, amplifiers, radar detectors, wheels, suspension components, brake dust shields, telephones, including operation of any mobile phone from within the vehicle without using an externally mounted antenna, or transceiver equipment, for instance, CBs, walkie-talkies, ham radios or similar accessories, may cause extensive damage to the vehicle, compromise its safety, interfere with the vehicle's electrical system or affect the validity of the MINI Limited Warranty. See your MINI dealer for additional information. ◀

 Maintenance, replacement, or repair of the emission control devices and systems may be performed by any automotive repair establishment or individual using any certified automotive part. ◀

California Proposition 65 warning

California law requires us to issue the following warning:

 Engine exhaust and a wide variety of automobile components and parts, including components found in the interior furnishings in a vehicle, contain or emit chemicals known to the State of California to cause cancer and birth defects and reproductive harm. In addition, certain fluids contained in vehicles and certain products of component wear contain or emit chemicals known to the State of California to cause cancer and birth defects or other reproductive harm.

Battery posts, terminals and related accessories contain lead and lead compounds. Wash your hands after handling.

Used engine oil contains chemicals that have caused cancer in laboratory animals. Always protect your skin by washing thoroughly with soap and water. ◀

SERVICE AND WARRANTY

We recommend that you read this publication thoroughly.

Your MINI is covered by the following warranties:

- ▷ New Vehicle Limited Warranty
- ▷ Rust Perforation Limited Warranty
- ▷ Federal Emissions System Defect Warranty
- ▷ Federal Emissions Performance Warranty
- ▷ California Emission Control System Limited Warranty

Detailed information about these warranties is listed in the Service and Warranty Information Booklet for US models or in the Warranty and Service Guide Booklet for Canadian models.

Your vehicle has been specifically adapted and designed to meet the particular operating conditions and registration requirements in your country and continental region in order to deliver the full driving pleasure while the vehicle is operated under those conditions. If you wish to operate your vehicle in another country or region, you may be required to adapt your vehicle to meet different prevailing operating conditions and registration requirements. You should also be aware of any applicable warranty limitations or exclusions for such country or region. In such a case, please contact Customer Relations for further information.

Maintenance

Maintain the vehicle regularly to sustain road safety, operational reliability and the New Vehicle Limited Warranty.

Specifications for required maintenance measures:

- ▷ MINI Maintenance System
- ▷ Service and Warranty Information Booklet for US models
- ▷ Warranty and Service Guide Booklet for Canadian models

If the vehicle is not maintained according to these specifications, this could result in serious damage to the vehicle. Such damage is not covered by the MINI New Vehicle Limited Warranty.

REPORTING SAFETY DEFECTS

For US customers

The following applies only to vehicles owned and operated in the US.

If you believe that your vehicle has a defect that could cause a crash or could cause injury or death, you should immediately inform the National Highway Traffic Safety Administration, NHTSA, in addition to notifying MINI of North America, LLC, P.O. Box 1227, Westwood, New Jersey 07675-1227, Telephone 1-800-831-1117.

If NHTSA receives similar complaints, it may open an investigation, and if it finds that a safety defect exists in a group of vehicles, it may order a recall and remedy campaign. However, NHTSA cannot become involved in individual problems between you, your dealer, or MINI of North America, LLC.

To contact NHTSA, you may call the Vehicle Safety Hotline toll-free at 1-888-327-4236 (TTY: 1-800-424-9153); go to <http://www.safercar.gov>; or write to: Administrator, NHTSA, 400 Seventh Street, SW., Washington, DC 20590. You can also obtain other information about motor vehicle safety from <http://www.safercar.gov>

For Canadian customers

Canadian customers who wish to report a safety-related defect to Transport Canada, Defect Investigations and Recalls, may telephone the toll-free hotline 1-800-333-0510. You can also obtain other information about motor vehicle safety from <http://www.tc.gc.ca/roadsafety>



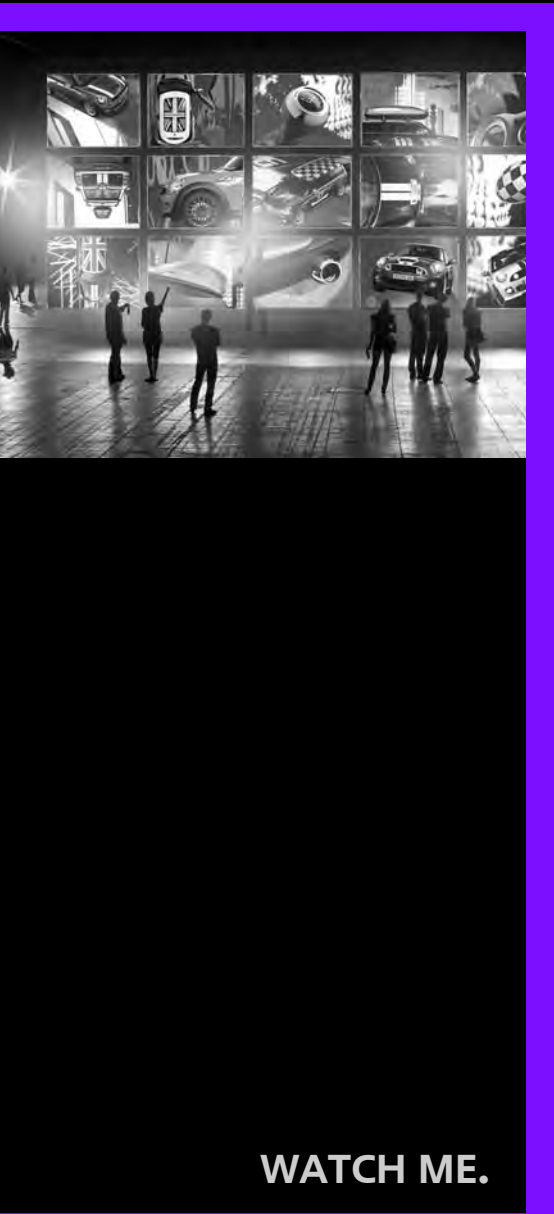

WATCH ME.



AT A GLANCE

CONTROLS

DRIVING TIPS

NAVIGATION

ENTERTAINMENT

COMMUNICATIONS

MOBILITY

REFERENCE

COCKPIT









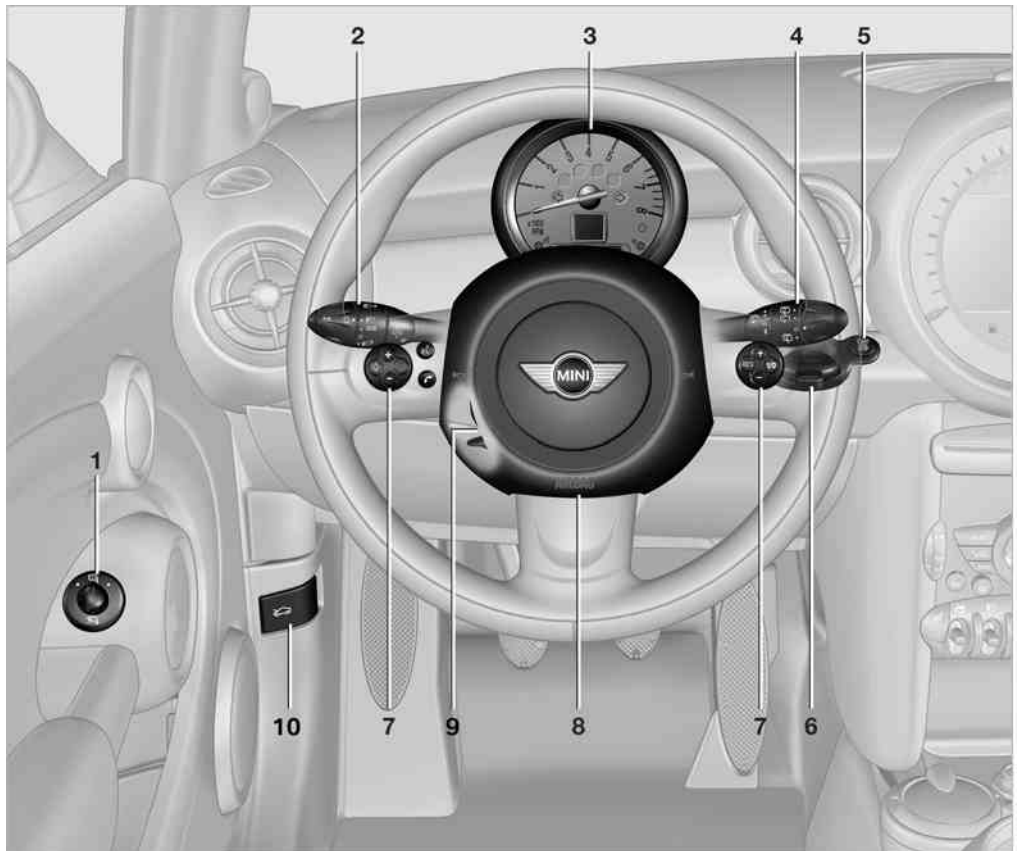









VEHICLE EQUIPMENT

In this chapter, all production, country, and optional equipment that is offered in the model range is described. Equipment is also described

that is not available because of, for example, selected options or country version. This also applies to safety related functions and systems.

AROUND THE STEERING WHEEL



- 1** Adjusting the exterior mirrors, folding them in and out [44](#)
- 2**  Parking lamps [83](#)
-  Low beams [83](#)
-  Automatic headlamp control [83](#)
Adaptive Light Control [84](#)
-  Turn signals [54](#)
-  High beams [85](#)
-  Headlamp flasher [54](#)
-  Roadside parking lamps [85](#)
- BC** Computer [60](#)
- 3** Tachometer [12](#)
-  Instrument lighting [85](#)
- TRIP 0.0** Resetting the trip odometer [59](#)
- 4**  Wiper system [55](#)
- 5**  Switching the ignition on/off and starting/stopping the engine [49](#)
- 6** Ignition lock [49](#)
- 7** Buttons on steering wheel, Right side
- RES** Resuming cruise control [57](#)
-  Storing speed and accelerating or decelerating
- I/O** Activating/deactivating cruise control [57](#)
- or
- 
- Left side
-  Increasing or reducing volume
-  Telephone:
Press: accepting and ending a call, starting dialing of selected phone number and redialing if no phone number is selected
-  Activating/deactivating voice activation system [22](#)
-  Changing the radio station
-  Selecting a music track
-  Scrolling through the redial list
- 8** Horn: the entire surface
- 9** Adjusting the steering wheel [45](#)
- 10** Releasing the hood [210](#)

DISPLAYS

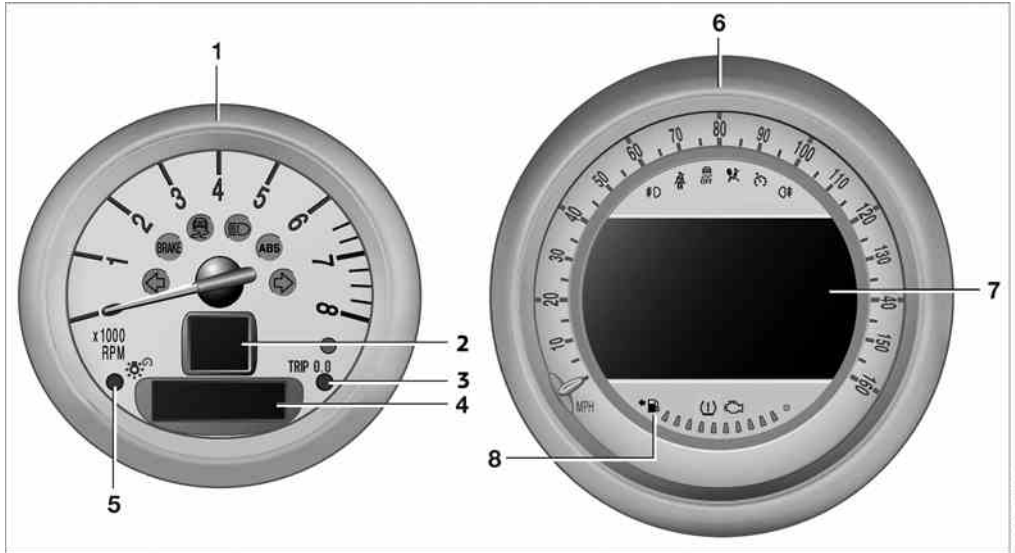

- 1 Tachometer 59
with indicator and warning lamps 13
- 2 Display for
 - ▷ Current vehicle speed 59
 - ▷ Indicator and warning lamps 13
- 3 Resetting the trip odometer 59
- 4 Display for
 - ▷ Position of automatic transmission 51
 - ▷ Computer 60
 - ▷ Date of next scheduled service, and remaining distance to be driven 63
 - ▷ Odometer and trip odometer 59
 - ▷ Initializing the Flat Tire Monitor 74
 - ▷ Resetting the Tire Pressure Monitor 77
 - ▷ Settings and information 62
 - ▷ Personal Profile settings 28
- 5 Instrument lighting 85
- 6 Speedometer
with indicator and warning lamps 13
- 7 Control Display 18
- 8 Fuel gauge 59

INDICATOR AND WARNING LAMPS

The concept

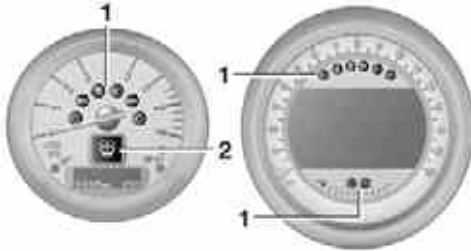

Indicator and warning lamps can light up in various combinations and colors in indicator area 1 or 2.

Some lamps will be tested for proper functioning when the engine is started or the ignition is switched on and will therefore light up briefly.

Explanatory text messages



Text messages at the upper edge of the Control Display explain the meaning of the displayed indicator and warning lamps.

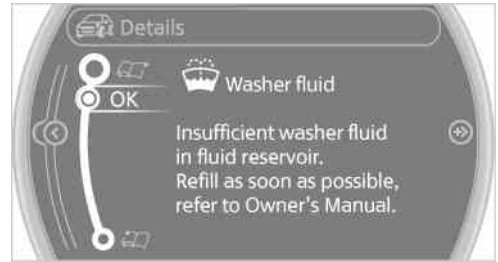









You can call up more information, e.g. on the cause of a malfunction and on how to respond, via Check Control, page 65.

In urgent cases, this information will be shown as soon as the corresponding lamp lights up.

Indicator lamps without text messages

The following indicator lamps in display area 1 indicate certain functions:

-  High beams/headlamp flasher 85
-  Front fog lamps 85
-  Rear fog lamp 85
-  Lamp flashes:
DSC or DTC is regulating the drive forces in order to maintain driving stability 71
-  Parking brake applied 51
-  Engine malfunction with adverse effect on exhaust emissions 214
-  Cruise control 57
-  Turn signals 54

AROUND THE CENTER CONSOLE

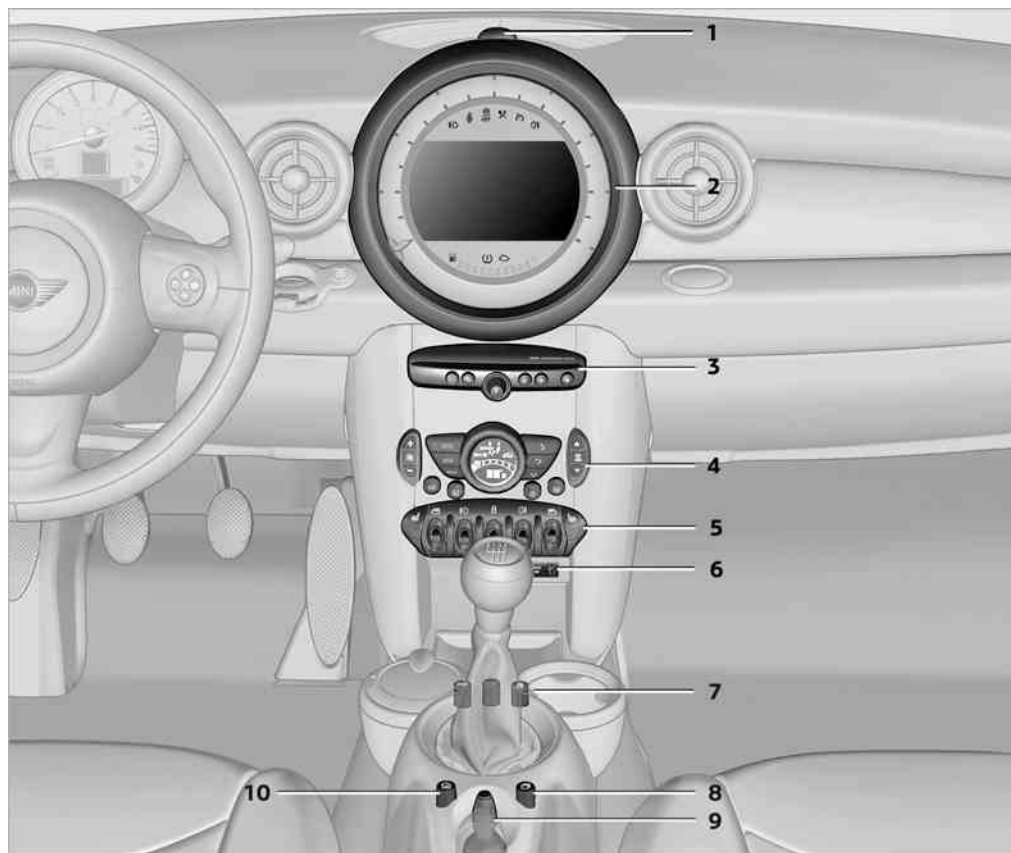

- 1 Hazard warning flashers
- 2 Speedometer with Control Display [12](#)
- 3 Radio/CD
 - AM Selecting waveband
 - FM
 - Changing the audio source
 - Changing the radio station or track
 - Ejecting CD

- 4 Air conditioner or automatic climate control [87](#)
 - Temperature
 - Recirculated-air mode
 - Air distribution for air conditioner
 - Air distribution to the windshield
 - Air distribution to the upper body area



Air distribution to the footwell

AUTO

Automatic air distribution and flow rate

MAX

Maximum cooling



or

Cooling function

A/C



Defrosting windows



Rear window defroster



Windshield heating



Air flow rate

5 Switches in the center console



Seat heating 43



Power windows 38



Rear fog lamp 85



Front fog lamps 85



Central locking system, inside 32

6 USB audio interface 148

7 Buttons on the center console

SPORT

Sport button 73



Driving stability control systems
Dynamic Stability Control DSC 71
Dynamic Traction Control DTC 72

8 Changing to a different menu on the Control Display

9 MINI joystick 17

Move in four directions, turn or press

10 Accessing the main menu on the Control Display 18

AROUND THE HEADLINER



1 Microphone for voice activation system and for telephone in hands-free mode

2 Indicator/warning lamp for front passenger airbags 81

3 Switch panel



Reading lamps 86



Color of ambient lighting 86



Glass roof, electric 37



Interior lamps 86

ONBOARD COMPUTER

VEHICLE EQUIPMENT

In this chapter, all production, country, and optional equipment that is offered in the model range is described. Equipment is also described that is not available because of, for example, selected options or country version. This also applies to safety related functions and systems.

THE CONCEPT

The onboard computer integrates the functions of a large number of switches. This allows these functions to be operated from a single central position. The following section provides an introduction to basic menu navigation. The control of the individual functions is described in connection with the relevant equipment.

 Make entries only when traffic and road conditions permit; otherwise, you may endanger vehicle occupants and other road users by being distracted. ◀

OVERVIEW OF OPERATING ELEMENTS

Controls



- 1 Control Display
- 2 MINI joystick with buttons

Control Display

Notes

- ▷ When cleaning the Control Display, follow the care instructions.
- ▷ Do not place any objects in the area of the Control Display; otherwise, the Control Display can be damaged.

Switching Control Display off/on

1. Move the MINI joystick to the right repeatedly until the "Options" menu is displayed.
2. "Switch off control display"

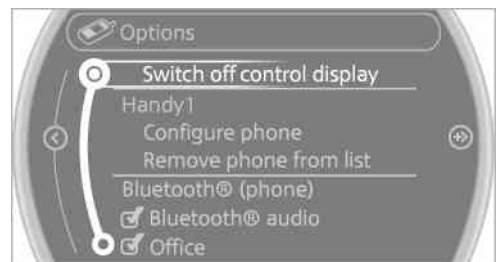

To switch on, press the MINI joystick.

MINI joystick with buttons

Selecting menu items and carrying out settings.

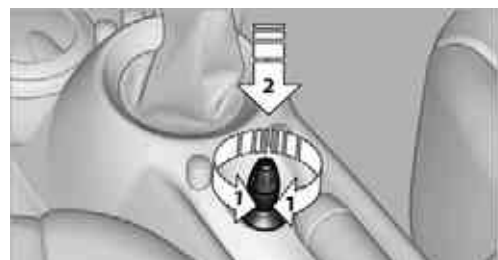

1. Turning 1 and pressing 2.



2. Tilting in four directions.



Buttons on MINI joystick

Button	Function
	Accessing the main menu
	Changing to another menu

OPERATING PRINCIPLE

As of radio readiness, the following message appears on the Control Display:

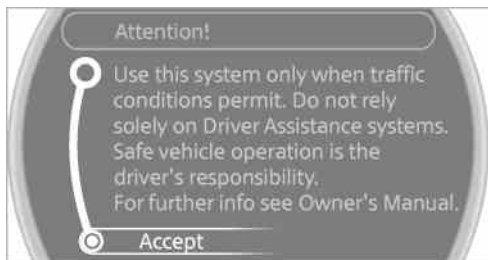

To hide the message:
Press the MINI joystick.

The main menu is displayed.

The message is automatically hidden after approx. 10 seconds.

Opening the main menu

Press the  button.



All functions of the onboard computer can be accessed via the main menu.

Selecting a menu item

Menu items displayed in white can be selected.

1. Turn the MINI joystick until the desired menu item is highlighted.



2. Press the MINI joystick.

A new menu is displayed or the function is executed.

Using the button on the MINI joystick:

Press the  button.

Each time that the button is pressed, the menu items "Navigation", "Radio", "CD/Multimedia" and "Telephone" are called up, one after another.

Menu items in the Owner's Manual

In the Owner's Manual, the menu items that should be selected are depicted in quotation marks, e.g. "Settings".

Changing between panels

After selecting a menu item, e.g. "Radio", a new menu is displayed on a panel. The panels can overlap.

- ▷ Move the MINI joystick to the left.
Current panel is closed and the previous panel is displayed.
- ▷ Move the MINI joystick to the right.
The new panel is opened and placed on top.



Arrows pointing left or right indicate that additional panels can be accessed.

View of a menu that has been called up

In general, when a menu is called up, the panel that was last selected in the menu is displayed. To display the first panel of the menu:

Move the MINI joystick as often to the left as necessary until the first panel is displayed.

Opening the Options menu

Move the MINI joystick to the right repeatedly until the "Options" menu is displayed.



The following is displayed in the "Options" menu:

- ▷ Screen settings.
- ▷ Control options for the selected menu.

Adjusting settings

1. Select a field.
2. Turn the MINI joystick until the desired setting is displayed.

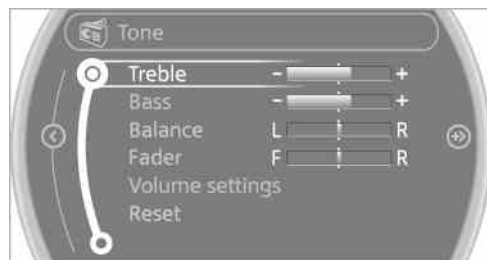

3. Press the MINI joystick to confirm the setting.

Activating/deactivating functions

Some menu items are preceded by a check box. It indicates whether the function is activated or deactivated.

Selecting the menu item activates or deactivates the function.

- Function is activated.
- Function is deactivated.

Example: setting the clock

1. Press the  button.
The main menu is displayed.
2. Turn the MINI joystick until "Settings" is selected, and press the MINI joystick.



3. Turn the MINI joystick until "Time/Date" is selected, and press the MINI joystick.

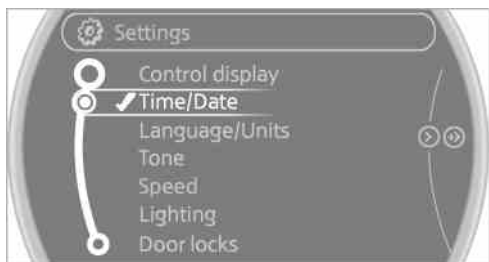

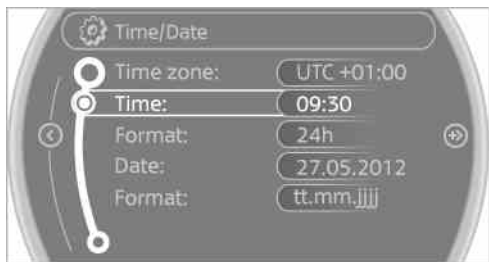

4. Turn the MINI joystick until "Time:" is selected, and press the MINI joystick.



5. Turn the MINI joystick to set the hours and press the MINI joystick.
6. Turn the MINI joystick to set the minutes and press the MINI joystick.

STATUS INFORMATION

- 1 Time
- 2 Telephone status
 - ▷ Incoming, outgoing or missed call
 - ▷ ▲ Roaming active
 - ▷ ✉ Text message received
- 3  Reception strength of the wireless network, depends on the mobile phone
- 4 Display for:
 - ▷ Entertainment: Radio, CD, external devices
 - ▷ Telephone: Name of the mobile phone paired with the vehicle
- 5  Sound output is switched off or display for traffic bulletins:
 - ▷ "TI": Traffic bulletins are switched on.
 - ▷ No display: Traffic bulletins are switched off.

Other displays:

Status information is temporarily hidden during Check Control message displays or entries via the voice activation system.

LETTERS AND NUMBERS

VEHICLE EQUIPMENT

In this chapter, all production, country, and optional equipment that is offered in the model range is described. Equipment is also described that is not available because of, for example, selected options or country version. This also applies to safety related functions and systems.

ENTERING LETTERS AND NUMBERS

1. Turn the MINI joystick: select the letters or numbers.
2. Select additional letters or numbers if needed.
3. "OK": confirm entry.

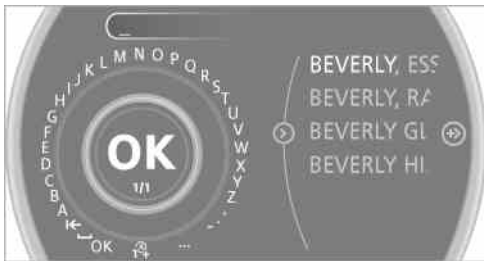

Symbol	Function
←	Press the MINI joystick: delete one letter or number
←	Press and hold the MINI joystick: delete all letters or numbers
⏏	Enter a blank space

Switching between letters and numbers

Depending on the menu, you can switch between entering letters and numbers:

Symbol	Function
ABC	Entering letters
1@+	Entering numbers

Switching between uppercase and lowercase letters

Depending on the menu, you can switch between entering uppercase letters and lowercase letters:

Symbol	Function
▲ abc	Move the MINI joystick forward: to switch from uppercase letters to lowercase letters
▲ ABC	Move the MINI joystick forward: to switch from lowercase letters to uppercase letters

Wordmatch concept

Entry of names and addresses: the selection is narrowed down every time a letter is entered and letters may be added automatically.

The entries are continuously compared to the data stored in the vehicle.

- ▷ The only letters offered for entry are those for which data are available.
- ▷ Destination search: town/city names can be entered with the spelling used in any of the languages available on the Control Display.

VOICE ACTIVATION SYSTEM

VEHICLE EQUIPMENT

In this chapter, all production, country, and optional equipment that is offered in the model range is described. Equipment is also described that is not available because of, for example, selected options or country version. This also applies to safety related functions and systems.

THE CONCEPT

- ▷ By using the voice activation system, individual functions that are displayed on the Control Display can be operated via voice commands. The system supports the entry process by means of announcements.
- ▷ Functions that can only be used while the vehicle is not moving cannot be operated via the voice activation system.
- ▷ The system includes a special microphone in the vicinity of the rearview mirror.

Prerequisite

So that voice commands can be identified, set a language on the Control Display that is supported by the voice activation system.

To set the language, see page 68.

Symbols in the Owner's Manual

- ›...‹ Say the specified commands word for word.
- ››...‹‹ Indicates responses of the voice activation system.

SAYING COMMANDS

Activating voice activation system

1. Press the  button on the steering wheel.

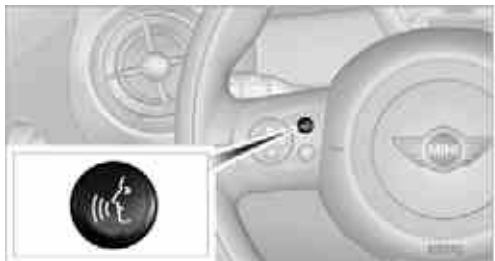



-  This symbol on the Control Display and an acoustic signal indicate that the voice activation system is ready to receive spoken commands.



2. Say the command.
The command appears on the Control Display.
-  This symbol is displayed on the Control Display when you can enter additional commands.

Terminating or canceling voice activation system

Press the  button on the steering wheel or

-  ›Cancel‹

Commands

Individual menu items on the Control Display can be voiced as commands.

The commands that are possible depend upon which menu is currently shown on the Control Display.

There are short commands for functions in the main menu.

Some list items, for example telephone book listings, can also be selected using the voice activation system. In particular, say the list items exactly as they are displayed in the respective list.

Having the possible commands read aloud

Having the possible commands read aloud:

 ›Voice commands‹

For example if you have selected "CD" the system will read aloud the possible commands for operating the CD player.

Help for the voice activation system

Calling up Help:

 ›Help‹

Additional commands for Help:

- ▷ ›Help with examples‹: information about the current operating options and the most important commands for them are announced.
- ▷ ›Help with voice activation‹: information regarding the principles behind the voice activation system is announced.

Using alternative commands

There are often a number of commands to run a function, e.g.:

 ›Radio‹ or ›Radio on‹

Carrying out functions through short commands

Main menu functions can be executed immediately by short commands, almost regardless of which menu item is selected, e.g., ›Vehicle status‹.

List of voice activation system short commands, see page 247.

Opening the main menu

 ›Main menu‹

Example: selecting the track of a CD

1. Switch on Entertainment sound output if necessary.
2. Press the  button on the steering wheel.
3. Select the music track, e.g.:
›C D track ...‹
The system replies:
››Track ...‹‹

Setting the voice dialog

You can set whether the voice activation system uses the standard dialog or the short version. With the short version of the spoken dialog, the requests and responses of the voice activation system are shortened.

1. "Settings"
2. "Language/Units"
3. "Speech mode:"

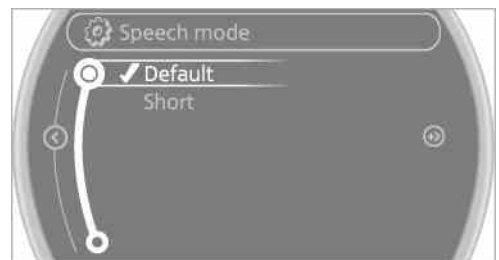

4. Select a setting:
 - ▷ "Default"
 - ▷ "Short"

NOTES

For voice commands, bear in mind the following:

- ▷ Do not use the voice activation system to initiate an emergency call. In stressful situations, the voice and vocal pitch can change. This can unnecessarily delay the establishment of a telephone connection.
- ▷ Pronounce the commands and digits smoothly and at normal volume, avoiding excessive emphases and pauses. The same applies to spelling when entering a destination for navigation.
- ▷ Always speak the commands in the language of the voice activation system.
- ▷ When selecting a radio station, use the standard pronunciation of the station name.
›Select station‹ e.g. WPLJ
- ▷ Keep the doors, windows and glass roof closed to prevent interference from outside noise.
- ▷ Avoid ambient noise in the vehicle while speaking.

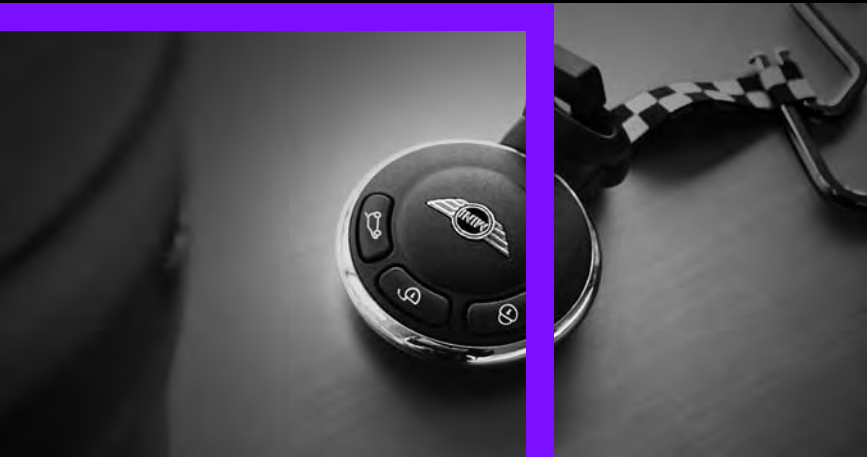

HANDLE ME.

AT A GLANCE

CONTROLS

DRIVING TIPS

NAVIGATION

ENTERTAINMENT

COMMUNICATIONS

MOBILITY

REFERENCE

OPENING AND CLOSING

VEHICLE EQUIPMENT

In this chapter, all production, country, and optional equipment that is offered in the model range is described. Equipment is also described that is not available because of, for example, selected options or country version. This also applies to safety related functions and systems.

KEYS/REMOTE CONTROLS

Buttons on the remote control



- 1 Opening the tailgate/Split Rear Barn Doors
- 2 Unlocking
- 3 Locking

General information

Each remote control contains a rechargeable battery that is recharged when it is in the ignition lock while the car is being driven. You should therefore use each remote control at least twice a year to maintain the charge status. In vehicles equipped with Comfort Access, the remote control contains a replaceable battery, page 37.

If more than one remote control unit is used, the settings called up and implemented depend on which remote control is recognized when the car is unlocked, refer to Personal Profile, page 28.

In addition, information about service requirements is stored in the remote control, refer to Service data in the remote control, page 213.

New remote controls

Your MINI dealer can supply new remote controls as additional units or as replacements in the event of loss.

Integrated key

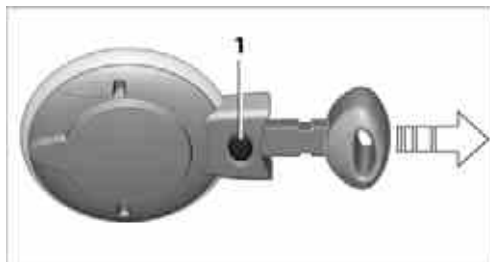

Press button 1 to release the key.

The integrated key fits the following locks:

- ▷ Driver's door, page 31

PERSONAL PROFILE

The concept

The functions of your MINI can be set individually. By means of Personal Profiles, most of these settings are stored for the remote control currently in use. When you unlock the car, the remote control is recognized and the settings stored for it are called up and implemented.

This means that your settings will be activated for you, even if in the meantime your car was used by someone else with another remote control and the corresponding settings.

At most three remote controls can be set for three different people. A prerequisite is that each person uses a separate remote control.

Personal Profile settings

For more information on specific settings, refer to the specified pages.

- ▷ Response of the central locking system when the car is being unlocked 29
- ▷ Automatic locking of the vehicle 32
- ▷ Triple turn signal activation 54
- ▷ Settings for the displays on the onboard computer, in the speedometer and in the tachometer:
 - ▷ 12 h/24 h mode of the clock 65
 - ▷ Date format 65
 - ▷ Brightness of the Control Display 68
 - ▷ Language on the Control Display 68
 - ▷ Units of measure for fuel consumption, distance covered/remaining distances and temperature 62
- ▷ Light settings:
 - ▷ Pathway lighting 84
 - ▷ Daytime running lights 84
- ▷ Automatic climate control: activating/deactivating the AUTO program, setting the temperature, air volume and air distribution 89
- ▷ Entertainment:
 - ▷ Tone control 135
 - ▷ Adjusting volume levels 135

CENTRAL LOCKING SYSTEM

The concept

The central locking system is ready for operation whenever the driver's door is closed.

The system simultaneously engages and releases the locks on the following:

- ▷ Doors
- ▷ MINI: Tailgate
- ▷ MINI Clubman: Split Rear Barn Doors
- ▷ Fuel filler flap

Operating from outside

- ▷ Via the remote control
- ▷ Using the door lock
- ▷ In cars with Comfort Access, via the door handles on the driver's and passenger's sides

The anti-theft system is also operated at the same time. It prevents the doors from being unlocked using the lock buttons or door handles. The remote control can also be used to switch on/off the welcome lamps and interior lamps. The alarm system is also activated or deactivated, page 34.

Operating from inside

Button for central locking system, page 32.

In the event of a sufficiently severe accident, the central locking system unlocks automatically. In addition, the hazard warning flashers and interior lamps come on.

OPENING AND CLOSING: FROM OUTSIDE

 Persons or animals in a parked vehicle could lock the doors from the inside. Take the key with you when you leave the vehicle so that the vehicle can be opened from the outside. ◀

Using the remote control

Unlocking

Press the  button.

The welcome lamps and interior lamps come on.

Unlocking mode

You can also set which parts of the car are unlocked. The setting is stored for the remote control in use.

1. "Settings"

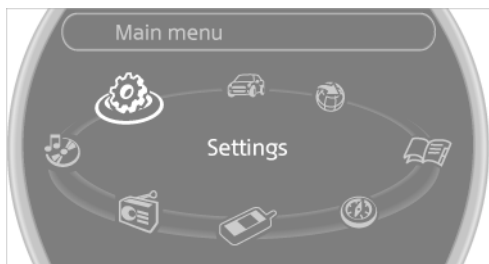

2. "Door locks"

3. "Unlock button"

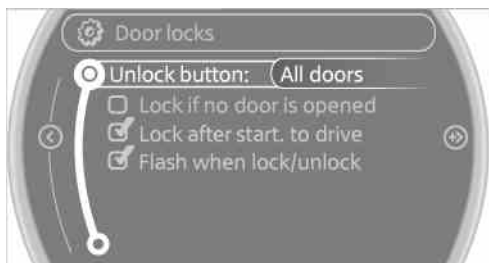

4. Select a menu item:

▷ "All doors"

Press the  button once to unlock the entire vehicle.

▷ "Driver's door only"

Press the  button once to unlock only the driver's door and the fuel filler flap.

Press the button twice to unlock the entire vehicle.

Convenient opening

Press and hold the  button.

The power windows are opened and the glass roof is tilted.

 Convenient closing is not possible by means of the remote control. ◀

Locking

Press the  button.

 Do not lock the vehicle from the outside if there is any person inside, because the vehicle cannot be unlocked from inside without special knowledge. ◀

Setting confirmation signals

To have the vehicle confirm when it has been locked or unlocked.

▷ off

The function is deactivated.

1. "Settings"

2. "Door locks"

3. "Flash when lock/unlock"

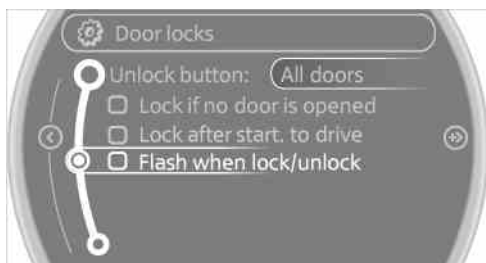

4. Press the MINI joystick.

Switching on interior lamps

While the car is locked:

Press the  button.

You can also use this function to locate your vehicle in parking garages, etc.

Unlocking the tailgate/Split Rear Barn Doors

Press the  button for approx. 1 second and then release it.

 When they are opened, the tailgate/Split Rear Barn Doors swing upward and outward to the rear. Make sure that adequate clearance is available before opening.

To prevent accidentally locking yourself out, do not place the key down in the cargo area. If the tailgate/Split Rear Barn Doors were locked before opening, they will be locked again after it is closed.

Before and after each trip, check that the tailgate/Split Rear Barn Doors have not been inadvertently unlocked. ◀

Malfunctions

The remote control may malfunction due to local radio waves. If this occurs, unlock and lock the car at the door lock with the integrated key. If the car can no longer be locked with a remote control, the battery in the remote control is discharged. Use this remote control during an extended drive; this will recharge the battery, page 28.

For US owners only

The transmitter and receiver units comply with part 15 of the FCC/Federal Communications Commission regulations. Operation is governed by the following:

FCC ID:
LX8766S
LX8766E
LX8CAS

Compliance statement:

This device complies with part 15 of the FCC Rules. Operation is subject to the following two conditions:

- ▶ This device must not cause harmful interference, and
- ▶ this device must accept any interference received, including interference that may cause undesired operation.

 Any unauthorized modifications or changes to these devices could void the user's authority to operate this equipment. ◀

Using the door lock

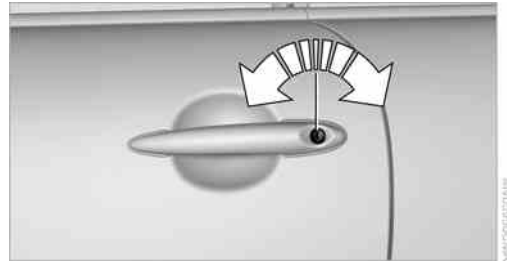

You can set which parts of the car are unlocked, page 29.

 Do not lock the vehicle from the outside if there is any person inside, because the vehicle cannot be unlocked from inside without special knowledge. ◀

 When there is no alarm system or Comfort Access, only the driver's door is locked with the door lock. ◀

To lock all doors, the fuel filler flap, and the tailgate/Split Rear Barn Doors together:

With the doors closed, press the interior central locking button, page 32, to lock the vehicle.

Unlocking and opening the driver or passenger door, page 32.

Lock the vehicle.

- ▶ Lock the driver's door with the integrated key via the door lock, or
- ▶ press the safety lock button on the passenger's door and close the door from the outside.

Convenience operation

With an alarm system or Comfort Access, the windows and glass roof can be operated via the door lock.

Opening/closing

Hold the key in the position for unlocking or locking.

 Watch during the closing process to be sure that no one is injured. Releasing the key stops the operation. ◀

Manual operation

In the event of an electrical malfunction, the driver's door can be unlocked or locked by turning the integrated key in the door lock to the end positions.

OPENING AND CLOSING: FROM INSIDE

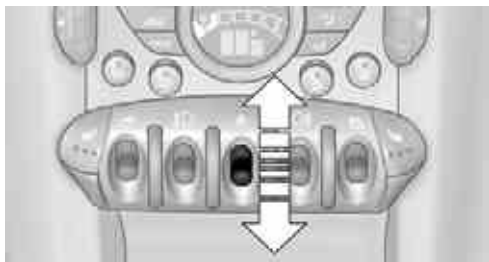

The switch locks or unlocks the doors and tail-gate/Split Rear Barn Doors when the doors are closed, but the anti-theft system is not activated. The fuel filler flap remains unlocked.

Unlocking and opening

- ▷ Either unlock the doors together using the switch for the central locking system and then pull the door handle above the armrest or
- ▷ pull on the door handle of either door twice: the first time unlocks the door, the second time opens it.

Locking

- ▷ Press the switch or
- ▷ press down the safety lock button of a door. To prevent you from being locked out, the open driver's door cannot be locked using the lock button.

 Persons or animals in a parked vehicle could lock the doors from the inside. Take the key with you when you leave the vehicle so that the vehicle can be opened from the outside. ◀

Automatic locking

You can also set the situations in which the car locks. The setting is stored for the remote control in use.

1. "Settings"
2. "Door locks"
3. Select a menu item:
 - ▷ "Lock if no door is opened"
The central locking system automatically locks the vehicle after a short time if no door has been opened.
 - ▷ "Lock after start. to drive"
The central locking system locks the vehicle as soon as you begin to drive.

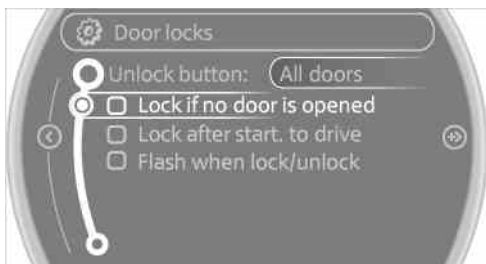

MINI CLUBMAN: CLUB DOOR

To facilitate entry into the rear seat, insert the safety belt into the belt receptacle, arrow.



Opening

The Club Door can only be opened using the handle on the inside. The right-hand front door must be open when opening the Club Door.

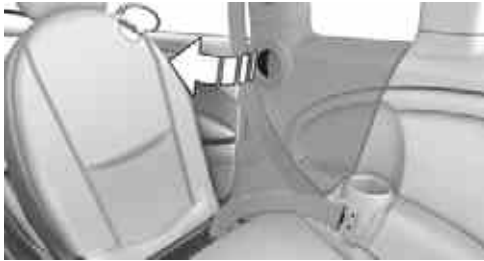

Closing

First close the Club Door, followed by the right-hand front door.

TAILGATE/SPLIT REAR BARN DOORS

! While driving, sharp objects or objects with edges may strike against the rear window and damage the heating element for the rear window. Assure that there are no objects with sharp edges near the rear window. ◀

▷ To avoid damage, make sure there is sufficient clearance before opening the tailgate/Split Rear Barn Doors. ◀

Opening

▷ In some market-specific versions, the tailgate/Split Rear Barn Doors cannot be unlocked using the remote control unless the vehicle is unlocked first.

Only drive with the Split Rear Barn Doors fully closed; otherwise, the tail lamps will be obscured and driving safety will be compromised. ◀

MINI



Press the button in the handle, arrow, or the  button of the remote control, for an extended period. The tailgate is unlocked and can be opened.

MINI Clubman



Press and hold the button in the handle or the  button for the remote control for approx. 1 second. The Split Rear Barn Doors are unlocked.

Using the button in the handle, fully open first the right side, arrow 1, and then the left side of the Split Rear Barn Doors, arrow 2.

Closing

! Make sure that the closing path of the tailgate/Split Rear Barn Doors is clear; otherwise, injuries may occur. ◀

! Take the remote control with you and do not put it into the luggage compartment; otherwise, the remote control can be locked in the vehicle when the tailgate/Split Rear Barn Doors are closed. ◀

MINI



The handle recesses on the interior trim panel of the tailgate make it easier to pull it down.

MINI Clubman

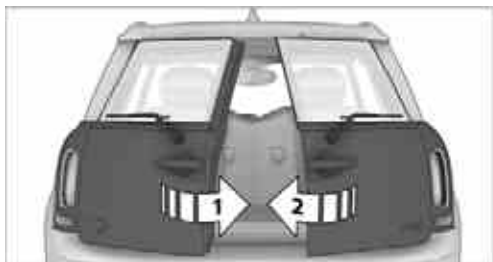

Close the left side, arrow 1, and then the right side of the Split Rear Barn Doors, arrow 2.

ALARM SYSTEM

The concept

The alarm system, when activated, reacts if:

- ▷ A door, the engine compartment lid or the tailgate is opened
- ▷ There is movement inside the car
- ▷ The car's inclination changes, for example if an attempt is made to jack it up and steal the wheels or to raise it prior to towing it away
- ▷ There is an interruption in the power supply from the battery

The alarm system briefly indicates unauthorized entry or tampering by means of:

- ▷ An acoustic alarm
- ▷ Switching on the hazard warning flashers

Arming and disarming

General information

Whenever the car is locked or unlocked, the alarm system is armed or disarmed.

Door lock with armed alarm system

Because of the design, unlocking the door lock may trigger the alarm in some countries.

To turn off the alarm, unlock the vehicle using the remote control or switch on the ignition.

Tailgate/Split Rear Barn Doors with armed alarm system

Even when the alarm system is armed, you can open the tailgate by means of the  button on the remote control.

When you subsequently close the tailgate it is again locked and monitored.

Panic mode

You can activate the alarm system if you find yourself in a dangerous situation.

Press the  button for at least two seconds.

Switching off the alarm:

Press any button.

Switching off an alarm

- ▷ Unlock the car with the remote control.
- ▷ Insert the key fully into the ignition lock.
- ▷ In cars with Comfort Access, press the button on the door lock.

Display on the revolution counter

When the system is armed, all LEDs pulse. After approx. 16 minutes one LED flashes.

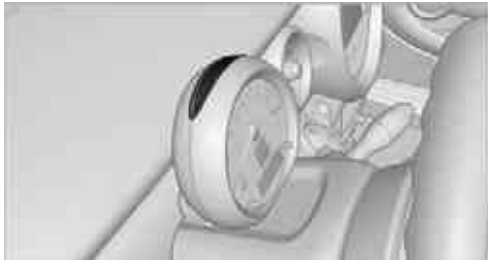

- ▷ LEDs pulse or LED flashes: system is armed.
- ▷ One LED flashes at short intervals: Doors, the hood or the tailgate are not properly closed. Even if these are not closed fully, the remaining items are deadlocked and the LEDs pulse after approx. 10 seconds for approx. 16 minutes. Afterwards, one LED flashes. The interior movement detector is not activated.
- ▷ LEDs go out after the vehicle is unlocked: No attempt was made to tamper with the car.
- ▷ LEDs flash after unlocking until the key is inserted in the ignition, but for no longer than approx. 5 minutes: an attempt was made to tamper with the vehicle.

Tilt alarm sensor

The vehicle's inclination is monitored. The alarm is triggered, for instance, if an attempt is made to steal the vehicle's wheels or tow it away.

Interior movement detector

Before the interior movement detector can operate correctly, the windows and glass roof must be closed.

Avoiding false alarms

The tilt alarm sensor and the interior movement detector can be switched off together.

This prevents false alarms, e.g. in the following situations:

- ▷ In duplex garages
- ▷ When being transported on car-carrying trains, ferries or trailers
- ▷ If pets are to remain inside the car

Switching off the tilt alarm sensor and interior movement detector

- ▷ Press the  button on the remote control twice in succession.
- ▷ Lock the vehicle twice with the integrated key.

LEDs flash in short succession for approx. 2 seconds.

The tilt alarm sensor and the interior movement detector are switched off until the car is next unlocked and locked.

COMFORT ACCESS

The concept

Access to the vehicle is possible without the use of the remote control. All you need to do is wear the remote control close to your body, e.g. in your jacket pocket. The vehicle automatically detects the remote control within the immediate vicinity or in the passenger compartment.

Comfort Access supports the following functions:

- ▷ Unlocking/locking the vehicle
- ▷ Unlocking the tailgate/Split Rear Barn Doors separately
- ▷ Starting the engine

Functional requirements

- ▷ There are no external malfunction sources in the vicinity.
- ▷ For locking, the remote control must be outside of the vehicle.
- ▷ The vehicle cannot be locked or unlocked again until after approx. 2 seconds.

- ▷ The engine can only be started if the remote control is in the vehicle.
- ▷ The doors and tailgate/Split Rear Barn Doors must be closed to be able to operate the windows and glass roof.

Comparison to standard remote controls

The indicated function can be operated by pressing the buttons or via Comfort Access.

Instructions on opening and closing are found starting on page 28.

- ▷ If you notice a brief delay while opening or closing the windows or glass roof, the system is checking whether a remote control is inside the vehicle. Repeat the opening or closing procedure, if necessary. ◀

Unlocking

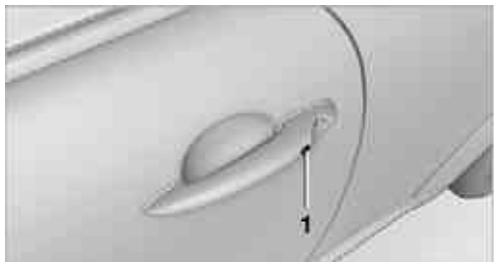

Press button 1.

Depending on the setting, refer to Unlocking mode on page 29, only the driver's door or the entire vehicle is unlocked.

- ▷ Press the button again to lock the vehicle again. ◀

Convenient opening with the remote control, refer to page 30.

Locking

Press button 1.

Unlocking the tailgate/Split Rear Barn Doors separately

Press the button on the outside of the tailgate/Split Rear Barn Doors.

Corresponds to pressing the  button.

- ▷ If the vehicle detects that a remote control has been accidentally left inside the locked vehicle's cargo area after the tailgate/Split Rear Barn Doors are closed, the tailgate/Split Rear Barn Doors will reopen slightly. The hazard warning flashers flash and an acoustic signal sounds. ◀

Windows and glass roof, electric

If the engine is switched off, you can still operate the windows and glass sunroof so long as a door or the tailgate/Split Rear Barn Doors have not been opened.

If the doors and tailgate/Split Rear Barn Doors are closed again and the remote control is located inside the vehicle, the windows and the glass roof can be operated again.

Insert the remote control into the ignition lock to be able to operate the windows or glass roof when the engine is switched off and the doors are open.

Switching on radio readiness

Switch on radio readiness by pressing the Start/Stop button, page 49.

- ▷ Do not depress the brake or the clutch; otherwise, the engine will start. ◀

Starting the engine

The engine can be started or the ignition can be switched on when a remote control is inside the vehicle. It is not necessary to insert a remote control into the ignition lock, page 49.

Switching off the engine in cars with automatic transmission

The engine can only be switched off when the selector lever is in position P, page 51.

To switch the engine off when the selector lever is in position N, the remote control must be in the ignition lock.

Before driving a vehicle with automatic transmission into a car wash

1. Insert remote control into ignition lock.
2. Depress the brake.
3. Move the selector lever to position N.
4. Switch off the engine.

The vehicle can roll.

Malfunction

Comfort Access may malfunction due to local radio waves, e.g. due to the presence of a mobile phone in the immediate vicinity of the remote control or the charging of a mobile phone in the vehicle.

If this happens, open or close the vehicle via the buttons on the remote control or using the integrated key.

Insert the remote control into the ignition lock and start the engine.

Warning lamps



The warning lamp lights up when an attempt is made to start the engine: the engine cannot be started. The remote control is not inside the vehicle or is malfunctioning. Take the remote control with you inside the vehicle or have it checked. If necessary, insert another remote control into the ignition lock.



The warning lamp lights up when the engine is running: the remote control is no longer inside the vehicle. After the engine is switched off, the engine can only be restarted within approx. 10 seconds.



The indicator lamp comes on and a message appears on the Control Display: replace the battery in the remote control.

Replacing the battery

The remote control for Comfort Access contains a battery that will need to be replaced from time to time.

1. Remove the cover.



2. Insert the new battery with the plus side facing up.
3. Press the cover on to close.



Take the old battery to a recycling center or to your MINI dealer. ◀

GLASS ROOF, ELECTRIC



To prevent injuries, exercise care when closing the glass roof and keep it in your field of vision until it is shut.

Take the key with you when you leave the car; otherwise, children could operate the roof and possibly injure themselves. ◀

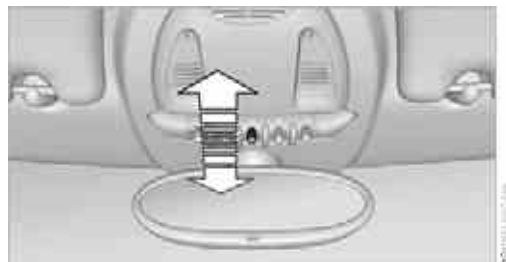

Tilting

- ▷ Press the switch backward to the resistance point and hold it there. Both glass roofs are tilted. Releasing the switch stops the movement.
- ▷ With the ignition switched on, press the switch backward beyond the resistance point. Both closed roofs are tilted fully. Pressing again stops the movement.

Opening, closing

With the ignition switched on and the glass roof tilted, press the switch backward and hold it there.

The front glass roof opens.

The rear glass roof is closed.

Releasing the switch stops the movement.

The glass roof can be closed in the same way by pressing the switch forward.

The front glass roof remains in a tilted position.

The rear glass roof is tilted. Pressing on the switch again closes both roofs completely.

Convenience operation via door lock or Comfort Access, refer to page 30, 31, 36.

Roller sunblind

The roller sunblind can be opened and closed independently of the glass roof.

Following interruptions in electrical power supply

After a power failure, there is a possibility that the glass roof can only be tilted. In this case, have the system initialized. The manufacturer of your MINI recommends that you have this work done by your MINI dealer.

WINDOWS

 To prevent injuries, exercise care when closing the windows.

Take the remote control with you when you leave the car; otherwise, children could operate the electric windows and possibly injure themselves. ◀

 If, after a window is opened and closed several times in close succession, the window can only be closed and not opened, the system is overheated. Let the system cool for several minutes with the ignition switched on or the engine running. ◀

Opening

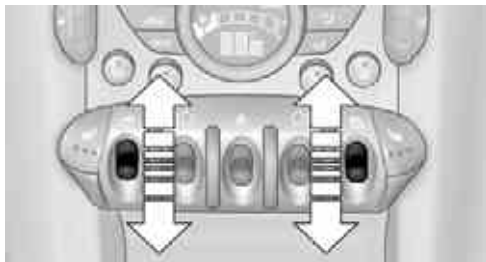

- ▷ Press the switch downward.
The window opens until you release the switch.
- ▷ Push the switch downward.
As of radio readiness, the windows will open automatically. Push the switch again to stop the opening movement.

To open the window a crack, press the switch down twice in quick succession.

Closing

The window can be closed in the same way by pressing the switch up.

Initializing electric power windows

 If the battery was disconnected, e.g. for changing batteries or vehicle storage, reinitialize the power windows; otherwise, the windows will not be lowered. ◀

1. Close the doors.
2. Open both windows.
3. Close both windows.

In the event of a system malfunction, please contact your MINI dealer.

After switching off the ignition

When the ignition is switched off, the windows can still be operated for approx. 1 minute as long as no door is opened.

 Take the key with you when you leave the car; otherwise, children could operate the electric windows and possibly injure themselves. ◀

Pinch protection system

If the closing force rises beyond a predefined threshold during closing, the system will stop moving the window prior to lowering it again slightly.



Even though there is the pinch protection system, always ensure that the window's travel path is clear; otherwise, the safety system might fail to detect certain kinds of obstructions, such as thin objects, and the window would continue closing.

Do not install any accessories that might interfere with window movement. Otherwise, the pinch protection system could be impaired. ◀

Closing without pinch protection

If there is an external danger, or if ice on the windows, etc., prevents you from closing the windows normally, the window can be closed manually.

1. Press the switch upward and hold it there. Pinch protection is limited and the window reopens slightly if the closing force exceeds a certain value.
2. Press the switch upward again within approx. 4 seconds and hold it there. The window closes without pinch protection.

ADJUSTMENTS

VEHICLE EQUIPMENT

In this chapter, all production, country, and optional equipment that is offered in the model range is described. Equipment is also described that is not available because of, for example, selected options or country version. This also applies to safety related functions and systems.

SITTING SAFELY

The ideal sitting position can make a vital contribution to relaxed, fatigue-free driving. In conjunction with the safety belts, the head restraints and the airbags, the seated position has a major influence on your safety in the event of an accident. To ensure that the safety systems operate with optimal efficiency, we strongly urge you to observe the instructions contained in the following section.

For additional information on transporting children safely, refer to page 46.

Airbags

 Always maintain an adequate distance between yourself and the airbags. Always grip the steering wheel on the rim, with your hands in the 3 o'clock and 9 o'clock positions, to minimize the risk of injury to the hands or arms in the event of the airbag being deployed.

No one and nothing should come between the airbags and the seat occupant.

Do not use the cover of the front airbag on the front passenger side as a storage area. Ensure that the front passenger is correctly seated, e.g. that no feet or legs are propped against the dashboard. Otherwise, leg injury could result if the front airbag suddenly deployed.

Make sure that passengers keep their heads away from the side airbag and do not lean against the cover of the head airbag; otherwise

injuries can occur when the airbags are deployed. ◀

Even if you follow all the instructions, injuries resulting from contact with airbags cannot be fully excluded, depending on the circumstances. The ignition and inflation noise may provoke a mild hearing loss in extremely sensitive individuals. This effect is usually only temporary.

For airbag locations as well as additional information, refer to page 80.

Head restraint

A correctly adjusted head restraint reduces the risk of neck injury in the event of an accident.

 Adjust the head restraint in such a way that its center is at approx. ear level. Otherwise, there is an increased risk of injury in the event of an accident. ◀

Head restraints, refer to page 42.

Safety belt

Before every drive, make sure that all occupants wear their safety belts. Airbags complement the safety belt as an additional safety device, but they do not represent a substitute.

Number of safety belts

 Never allow more than one person to wear a single safety belt. Never allow infants or small children to ride in a passenger's lap.

Make sure that the belt in the lap area sits low across the hips and does not press against the abdomen. The safety belt must not rest against the throat, run across sharp edges, pass over hard or fragile objects or be pinched. Fasten the safety belt so that it is pulled taut across the lap and shoulder, fitting the body snugly without any twists. Otherwise, the belt could slide over the hips in the event of a frontal collision and injure the abdomen. Avoid wearing bulky cloth-

ing and regularly pull the belt in the upper-body area taut; otherwise, its restraining effect could be impaired. ◀

Safety belts, refer to page 43.

SEATS

Note before adjusting

! Never attempt to adjust your seat while the vehicle is moving. The seat could respond with unexpected movement, and the ensuing loss of vehicle control could lead to an accident.

On the front passenger seat as well, do not incline the backrest too far to the rear while the vehicle is being driven; otherwise, there is a danger in the event of an accident of sliding under the safety belt, eliminating the protection normally provided by the belt. ◀

Comply with the instructions on head restraint height on page 42 and on damaged safety belts on page 44.

Seat adjustment

! Observe the instructions on page 41 to ensure the best possible personal protection. ◀



Longitudinal adjustment

Pull the lever, arrow 1, and slide the seat into the desired position, arrows 2.

After releasing the lever, move the seat slightly forward or back so that it engages properly.

Height

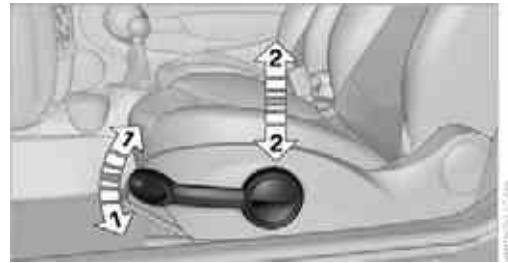

Pull up or push down the lever repeatedly, arrows 1, until the desired height is reached, arrows 2.

Backrest



Pull the lever, arrow 1, and apply your weight to the backrest or lift it off, as necessary, arrows 2.

Lumbar support

You can also adjust the contour of the backrest to obtain additional support in the lumbar region.

The upper hips and spinal column receive supplementary support to help you maintain a relaxed, upright sitting position.

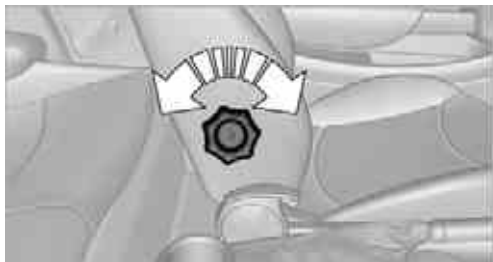

Turn the wheel to increase or decrease the curvature.

Getting in back

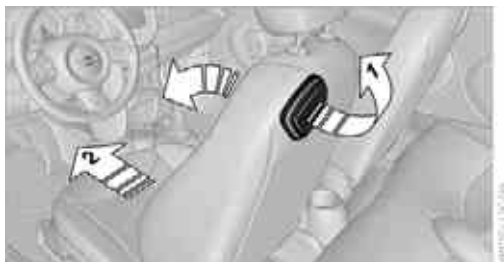

1. Pull up the lever on the seat backrest, arrow 1.
The backrest folds forward.
2. Move the seat forward by pushing on the backrest, arrow 2.

Return seat to original position

The driver's seat has a mechanical memory function for the forward/back setting and the backrest adjustment.

1. Slide the seat to return to its starting position.
 -  Do not fold the backrest up until the seat is in its previous position. Otherwise, the seat will engage in its current position. In this case, adjust the longitudinal position manually, page 41. ◀
2. Fold the backrest back up to lock the seat.

 When moving the seat backward, ensure that you do not cause personal injury or property damage.

Before driving off, engage the front seats and seat backrests. Otherwise, there is a risk of accident due to unexpected movement. ◀

HEAD RESTRAINTS

Correctly adjusted head restraint

A correctly adjusted head restraint reduces the risk of neck injury in the event of an accident.

 Correctly adjust the head restraints of all occupied seats; otherwise, there is an increased risk of injury in an accident. ◀

Height

Adjust the head restraint so that its center is approximately at ear level.

Distance

Adjust the distance so that the head restraint is as close as possible to the back of the head.

Height adjustment

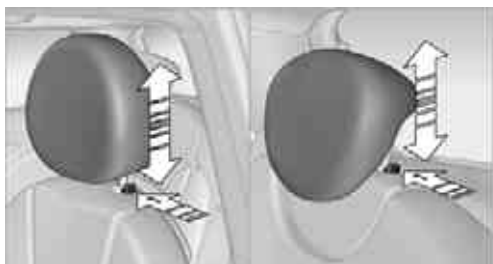

To raise: pull up.

To lower: press the button, arrow 1, and slide the head restraint down.

Removing

Only remove a head restraint if no one will be sitting on the seat in question.

 Reinstall the head restraint before transporting passengers, as otherwise the head restraint cannot provide its protective function. ◀

Front

1. Pull up as far as it will go.
2. Fold the backrest forward slightly.
3. Press button **1** and pull the head restraint out as far as it will go.
4. Fold back the backrest.

Rear

1. Pull up as far as it will go.
2. Press button **1** and pull the head restraint out completely.

SEAT HEATING

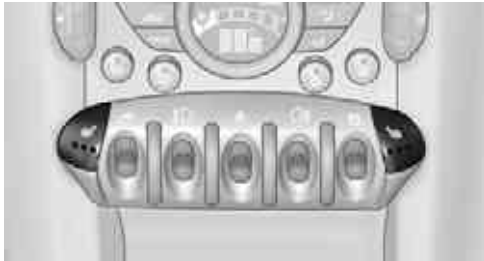

Switching on

Press once for each temperature level. Three LEDs indicate the highest temperature. If you continue driving within the next 15 minutes, the seat heating is automatically activated at the previously set temperature.

The temperature is lowered or the heating is switched off entirely to reduce the drain on the battery.

The LEDs stay lit.

Switching off

Press button longer.

SAFETY BELTS



Observe the instructions on page 41 to ensure the best possible personal protection. ◀

Before every drive, make sure that all occupants wear their safety belts. Airbags complement the safety belt as an additional safety device, but they do not represent a substitute.

Front and rear seats

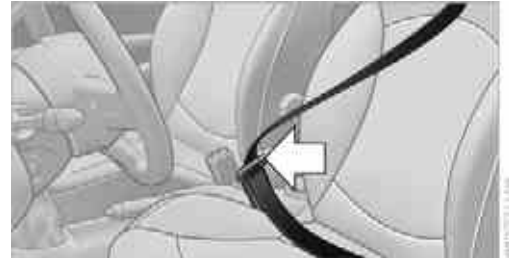

Closing

Make sure you hear the lock engage in the belt buckle.

The upper belt anchor is suitable for adults of any stature as long as the seat is adjusted properly, page 41.

Opening

1. Grasp the belt firmly.
2. Press the red button in the buckle.
3. Guide the belt into its reel.

Safety Belt Reminder

Front seats



The indicator lamps come on and an acoustic signal sounds. In addition, a message appears on the Control Display. Check whether the safety belt has been fastened correctly. The Safety Belt Reminder is issued when the driver's safety belt has not been fastened. The Safety Belt Reminder is also activated at road speeds above approx. 5 mph or 8 km/h if the front passenger's safety belt has not been fastened, if objects are placed on the front passenger seat, or if driver or front passenger unfasten their safety belts.

Damage to safety belts

 If the safety belts are damaged or stressed in an accident: have the safety belt system and its seat-belt tensioners replaced and the belt anchors checked. Have this work carried out only by a MINI dealer or by a workshop that has specially trained personnel working in accordance with the specifications of the MINI manufacturer; otherwise, correct operation of these safety systems is not ensured. ◀

MIRRORS

Exterior mirrors

 The front passenger's mirror is more convex than the driver's mirror. The objects seen in the mirror are closer than they appear. Do not gauge your distance from traffic behind you on the basis of what you see in the mirror; otherwise, there is an increased risk of an accident. ◀



- 1 Adjusting the left or right exterior mirror
- 2 Tilting mirrors in and out

Manual adjustment

The mirrors can also be adjusted manually: press the edge of the glass.

Tilting mirrors in and out

Turn the knob beyond the pressure point in direction **2**. The mirrors can be folded in at road speeds up to approx. 20 mph/30 km/h.

This can be beneficial in narrow streets, for example, or for moving mirrors that were folded in by hand back out into their correct positions.

Automatic heating

At external temperatures below a certain limit, both exterior mirrors are automatically heated while the engine is running or the ignition switched on.

Interior rearview mirror



To reduce glare from vehicles behind you when you are driving at night:

Turn the knob.

Interior and exterior mirrors, automatic dimming feature

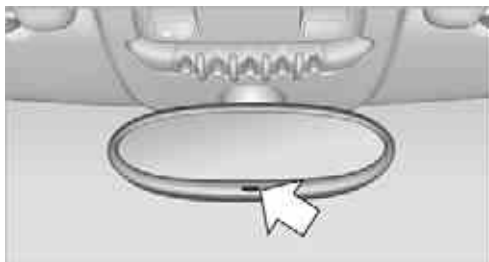

It is controlled by two photosensors:

- ▷ Inside the interior rearview mirror, arrow
- ▷ On the back of the mirror.

For proper function:

- ▷ Keep the photosensors clean
- ▷ Do not cover the area between the interior rearview mirror and the windshield
- ▷ Do not place stickers or decals on the windshield in front of the mirror.

STEERING WHEEL

Adjustments

 Do not adjust the steering wheel position while the car is in motion; otherwise, there is a risk of accident due to an unexpected movement. ◀

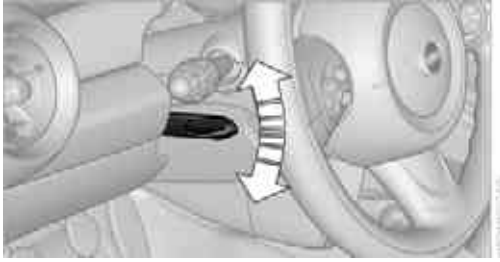

1. Fold the lever down.
2. Move the steering wheel to the preferred distance and angle to suit your seated position.
3. Swing the lever back up.

 Do not use force to swing the lever back up; otherwise, the mechanism will be damaged. ◀

TRANSPORTING CHILDREN SAFELY

VEHICLE EQUIPMENT

In this chapter, all production, country, and optional equipment that is offered in the model range is described. Equipment is also described that is not available because of, for example, selected options or country version. This also applies to safety related functions and systems.

THE RIGHT PLACE FOR CHILDREN

 Do not leave children unattended in the vehicle; otherwise, they could endanger themselves and/or other persons by opening the doors, for example. ◀

Children should always sit in the rear

Accident research has shown that the safest place for children is on the rear seat.

 Only transport children under the age of 13 or smaller than 5 ft/150 cm in the rear in a child restraint system suitable for their age, weight and size. Otherwise, there is an increased risk of injury in the event of an accident. ◀

Children 13 years of age or older must be buckled in with a safety belt as soon as there no longer is any child restraint system that is appropriate for their age, size and weight.

 Only install child seats in the rear when the rear seat backrest is folded all the way back and engaged. Otherwise, there is an increased risk of injury in the event of an accident. ◀

Exception for front passenger seat

Front passenger airbags

 Should it be necessary to use a child restraint system on the front passenger seat, the front and side airbags must be deactivated. Otherwise, there is an increased risk of injury to the child if the airbags deploy, even if the child is seated in a child restraint system. ◀

For more information on automatic deactivation of the front passenger airbags, refer to page 80.

CHILD RESTRAINT SYSTEMS, INSTALLATION

 Observe the child restraint system manufacturer's instructions when selecting, installing and using child restraint systems. Otherwise, the protective effect may be diminished. ◀

On the front passenger seat

 After installing a child restraint system on the front passenger seat, make sure that the front and side airbags for the front passenger are deactivated; otherwise, there is an increased risk of injury if the airbags deploy. ◀

Seat position

Before installing a child restraint system, move the front passenger seat as far back and up as possible to obtain the best possible position for the belt. Do not change the seat position after this.

Child seat security



All rear safety belts and the safety belt for the front passenger can be prevented from being pulled out in order to secure child restraint systems.

Locking the safety belt

1. Secure the child restraint system with the belt.
2. Pull the belt strap all the way out.
3. Allow the belt strap to retract and pull it taut against the child restraint system.

The safety belt is locked.

Unlocking the safety belt

1. Open the belt buckle.
2. Remove the child restraint system.
3. Allow the safety belt strap to retract all the way.

LATCH CHILD RESTRAINT FIXING SYSTEM

LATCH: Lower Anchors and Tethers for Children.

 To install and use the LATCH child restraint system, follow the operating and safety instructions provided by the manufacturer of the system; otherwise, the protective function of the seat may be compromised. ◀

Anchor points for LATCH anchors

Before installing the child seat, pull the belt out of the area for the child restraint fixing system.



The anchor points for the lower LATCH anchors are located behind the labeled protective caps.

 Make sure that both lower LATCH anchors are properly engaged and that the child restraint system rests firmly against the seat backrest; otherwise, the protective function of the seat may be compromised. ◀

Child restraint system with tether strap

 Use the tether strap anchors to secure child restraint systems only; otherwise, the anchors could be damaged. ◀

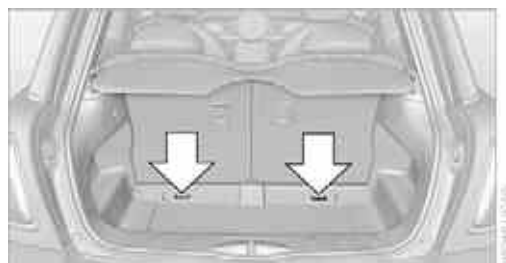

By way of example, the illustration shows the cargo area in the MINI.

There are two additional anchors for child restraint systems with tether straps, arrows.

MINI Clubman:

When the vehicle is equipped with a flat load floor, the anchors are covered. Their positions are labeled.

Placement of the tether strap

! Make sure the upper tether strap does not run over sharp edges and is not twisted as it passes to the top anchor. Otherwise, the strap will not properly secure the child restraint system in the event of an accident. ◀

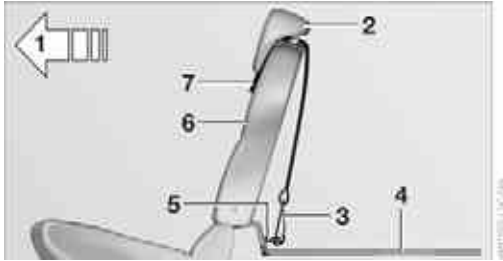

- 1 Direction of travel
- 2 Head restraint
- 3 Tether strap hook
- 4 Rear cargo well
- 5 Anchor
- 6 Seat backrest
- 7 Tether strap of the child restraint system

Attaching upper tether strap to the attachment point

1. Slide the head restraint upward.
2. Guide the tether strap between the head restraint holders.
3. Attach the tether strap to the anchor using the hook.
4. Push the head restraint into its lowermost position.
5. Pull the tether strap tight.

DRIVING

VEHICLE EQUIPMENT

In this chapter, all production, country, and optional equipment that is offered in the model range is described. Equipment is also described that is not available because of, for example, selected options or country version. This also applies to safety related functions and systems.

IGNITION LOCK

Inserting the key into the ignition lock



Insert the key all the way into the ignition lock.

Radio readiness

Individual electrical consumers can operate.

Removing the key from the ignition lock

Press in the key briefly. It is ejected slightly.

At the same time:

- ▷ The ignition is switched off if it was on beforehand.

Automatic transmission

The key can only be removed if the selector lever is in position P: interlock.

START/STOP BUTTON



Press the Start/Stop button to switch radio readiness or the ignition on and off. Do not depress the brake or clutch while doing so.

- ▷ If the Start/Stop button is pressed while the clutch is depressed in the manual transmission or the brake pedal is depressed in the automatic transmission, the engine starts. ◀

Radio readiness

Individual electrical consumers can operate. The time and external temperature are displayed in the tachometer.

Radio readiness is switched off automatically:

- ▷ When the key is removed from the ignition lock
- ▷ When using Comfort Access by pressing the button on the door handle or the  button on the remote control, refer to Locking on page 36
- ▷ After a certain has elapsed

Ignition on

Most indicator and warning lamps in indicator area 1, page 13, light up for varying lengths of time.

- ▷ When the engine is off, switch off the ignition and any unnecessary electrical consumers in order to preserve the battery. ◀

Radio readiness and ignition off

All indicator and warning lamps in the displays go out.

The ignition switches off automatically if the driver's door is opened. Pressing the Start/Stop button again switches the ignition back on.

The ignition is not switched off in situations such as the following:

- ▷ The clutch or brake is depressed
- ▷ The low beams are switched on

STARTING THE ENGINE

 Do not allow the engine to run in enclosed areas; otherwise, inhalation of the noxious exhaust gases can lead to loss of consciousness and death. Exhaust gases contain carbon monoxide, an odorless and colorless, but highly toxic gas. Never leave an unattended vehicle with the engine running; otherwise, such a vehicle represents a potential safety hazard.

Before leaving the car while the engine is running, place the transmission in neutral or move the selector lever to position P and forcefully apply the parking brake to prevent the car from moving. ◀

 Avoid frequent starting in quick succession or repeated start attempts in which the engine does not start. Otherwise, the fuel is not burned or inadequately burned and there is a danger of overheating and damaging the catalytic converter. ◀

Do not let the engine warm up with the vehicle at a standstill. Move off immediately at a moderate engine speed.

When starting the engine, do not depress the accelerator pedal.



Manual transmission

Key in ignition lock or inside vehicle with Comfort Access, refer to page 35.

1. Depress the brake.
2. Depress the clutch.
3. Press the Start/Stop button.

Automatic transmission

Key in ignition lock or inside vehicle with Comfort Access, refer to page 35.

1. Depress the brake.
2. Shift the selector lever into position P or N.
3. Press the Start/Stop button.

The starter operates automatically for a certain time, and stops automatically as soon as the engine has started.

SWITCHING OFF THE ENGINE

 Always take the key with you when you leave the vehicle.

When parking, apply the parking brake forcefully; otherwise, the vehicle could begin to roll. Secure the vehicle on steep upward and downward slopes, for example, turn the steering wheel towards the curb. ◀

Manual transmission

1. With the car at a standstill, press the Start/Stop button.
2. Shift into first gear or reverse.
3. Forcefully apply the parking brake.

Automatic transmission

1. With the car at a stop, move the selector lever to position P.
2. Press the Start/Stop button.
3. Forcefully apply the parking brake.

Before driving into a car wash

By following these steps, the vehicle is able to roll:

1. Place the remote control, even with Comfort Access, in the ignition lock.
2. Depress the brake.
3. Move the selector lever to position N.
4. Switch off the engine.

PARKING BRAKE

The parking brake is primarily intended to prevent the vehicle from rolling while parked; it brakes the rear wheels.

In addition, follow the instructions on page 50 under Switching off the engine.

Applying

The lever locks in position automatically.

Releasing

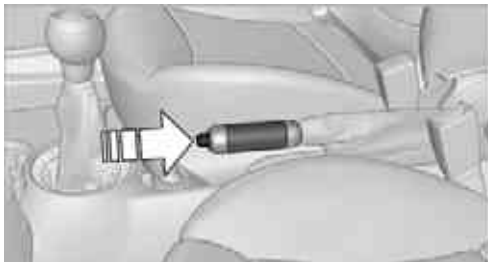

Pull slightly upward, press the button and lower the lever.

! In exceptional cases, if the parking brake has to be used to slow or stop the car, do not pull the lever up too hard. In doing so, continuously press the button of the parking brake lever.

Otherwise, excessive force could lead to over-braking and loss of traction, i.e. fishtailing, at the rear axle. ◀

MANUAL TRANSMISSION

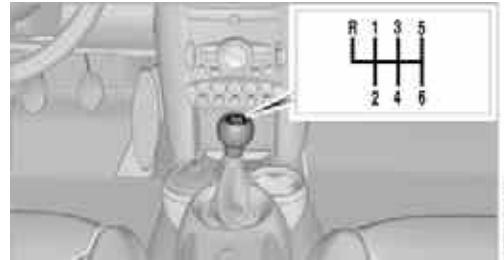

! When shifting into 5th or 6th gear, press the gearshift lever to the right. Otherwise, the engine could be damaged if you inadvertently shift into 3rd or 4th gear. ◀

Reverse gear

Select this only when the vehicle is stationary. When the gearshift lever is pressed to the left, a slight resistance has to be overcome.

AUTOMATIC TRANSMISSION WITH STEPTRONIC

In addition to the fully automatic mode, you can shift gears manually using Steptronic, page 53.

Parking the vehicle

! To prevent the vehicle from rolling, always select position P and apply the parking brake before leaving the vehicle with the engine running. ◀

Removing the key

To remove the key from the ignition lock, first move the selector lever into position P and then switch off the engine: interlock. Remove the key from the ignition lock, refer to page 49.

Selector lever positions

P R N D M/S + -

Displays in the tachometer



P R N D DS M1 to M6

The selector lever position is displayed, or the current gear in the manual mode.

Changing selector lever positions

- ▷ The selector lever can only be moved out of position P when the ignition is switched on or the engine is running.
- ▷ Before moving the lever away from P or N with the vehicle stationary, first depress the brake; otherwise, the selector lever will refuse to move: shiftlock.



To prevent the vehicle from creeping after you select a driving position, depress the brake until you are ready to start. ◀

A lock prevents accidental shifting into selector lever positions R and P.

Overriding the selector lever lock



Press the button on the front of the selector lever, arrow.

P Park

Select this only when the vehicle is stationary. The front wheels are blocked.

R Reverse

Select this only when the vehicle is stationary.

N Neutral

Select this when you are in a car wash, for example. The vehicle can roll.

D Drive, automatic position

Position for normal vehicle operation. All forward gears are selected automatically.

Under normal operation conditions, fuel consumption is lowest when you drive in position D.

Kickdown

Kickdown enables you to achieve maximum performance.

Depress the accelerator pedal beyond the full-throttle resistance point.

Sport program and manual mode M/S



Move the selector lever from position D to the left into the M/S shifting slot:

The Sport program is activated and DS is displayed. This position is recommended for a performance-oriented driving style.

To deactivate the Sport program or manual mode M/S, move the selector lever to the right into position D.

Shifting with the selector lever

Push the selector lever forward or pull it back to activate manual operation. Steptronic shifts the gear.

- ▷ Pull the selector lever in the + direction. Transmission shifts up.
- ▷ Push the selector lever in the – direction. Transmission shifts down.

The selected gear is displayed in the tachometer, e.g. M1.

To use the automatic mode again, move the selector lever to the right into position D.

Upshifts and downshifts are executed only when they will result in a plausible combination of engine and vehicle speed; thus, for example, a downshift that would cause the engine to over-rev will not be executed by the system. The selected gear is displayed briefly, followed by the current gear.

Shifting on the steering wheel

With the selector lever in position D, automatic drive, you can shift gears using the shift paddles on the steering wheel. The transmission automatically switches to manual mode.

If you do not shift gears with the shift paddles or accelerate for a certain amount of time, the transmission automatically returns to D, automatic drive.



- ▷ Pull one of the shift paddles. Transmission shifts up.
- ▷ Push one of the shift paddles. Transmission shifts down.

M1 through M6 are displayed in the tachometer.

Manually releasing the selector lever lock

Should the selector lever refuse to move out of position P even though the ignition is switched on, the brake is depressed and the button on the selector lever is pressed, the selector lever lock can be overridden:

1. Unclip the sleeve of the selector lever.
2. Pull the sleeve up over the selector lever until the sleeve is inside out. Disconnect the cable connector if necessary.

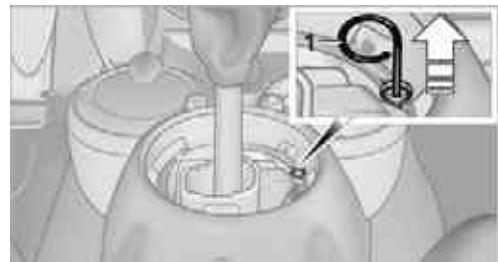

3. Insert extractor hook 1 from the toolkit into the loop on the passenger's side.
4. Pull the loop up.

5. Move the selector lever into the desired position by pressing the button on the front of the selector lever.

 Before manually unlocking the selector lever lock, firmly set the parking brake to prevent the vehicle from rolling away. ◀

TURN SIGNALS/ HEADLAMP FLASHER

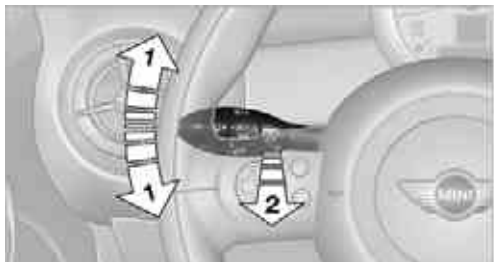

- 1 Turn signal
- 2 Headlamp flasher

Using turn signals

Press the lever beyond the resistance point.

To turn off manually, press the lever to the resistance point.

 Unusually rapid flashing of the indicator lamp indicates that an indicator bulb has failed. ◀

Signaling a turn briefly

Press the lever as far as the resistance point for as long as you wish to signal a turn.

Triple turn signal activation

Press the lever as far as the resistance point.

You can set whether the turn signal flashes once or three times.

1. "Settings"
2. "Lighting"
3. "Triple turn signal"

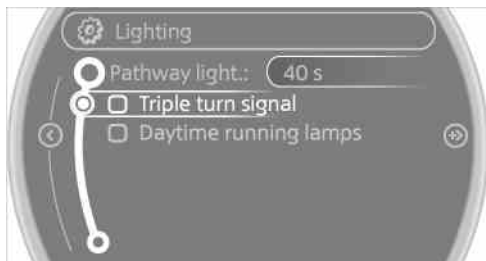

The setting is stored for the remote control currently in use.

WIPER SYSTEM

! Do not turn on the wipers when they are frozen; otherwise, the wiper blades and the windshield wiper motor may be damaged. ◀

! Do not use the windshield wipers when the windshield is dry; otherwise the wiper blades may wear out faster or be damaged. ◀



- 1 Switching on wipers
- 2 Switching off wipers or brief wipe
- 3 Activating/deactivating intermittent wipe or rain sensor
- 4 Cleaning windshield and headlamps

Switching on wipers

Press the lever upward, arrow 1.

The lever automatically returns to its initial position when released.

Normal wiper speed

Press once.

The system switches to intermittent operation when the vehicle is stationary.

Fast wiper speed

Press twice or press beyond the resistance point. The system switches to normal speed when the vehicle is stationary.

Intermittent wipe or rain sensor

If the car is not equipped with a rain sensor, the intermittent-wipe time is preset.

If the car is equipped with a rain sensor, the time between wipes is controlled automatically and

depends on the intensity of the rainfall. The rain sensor is mounted on the windshield, directly in front of the interior rearview mirror.

Activating intermittent wipe or rain sensor

Press button, arrow 3.



This symbol is displayed in the tachometer.

! Deactivate the rain sensor before entering an automatic car wash. Failure to do so could result in damage caused by undesired wiper activation. ◀

Adjusting the sensitivity of the rain sensor

1. Switch on the ignition, refer to page 49.
2. Press the button in the turn signal indicator as often as necessary until "SET/INFO" is displayed.



3. Press and hold the button until the display changes.
4. Press the button as often as necessary until the symbol and "SET" are displayed.



- Press and hold the button until the display changes.



- Press the button to select the desired sensitivity.
- Wait, or press and hold the button until the display changes. The settings are stored.

Deactivating intermittent wipe or rain sensor

Press the button again, arrow **3**.

Brief wipe

Press the lever downward once, arrow **2**.

Cleaning windshield and headlamps

Pull the lever, arrow **4**.

Washer fluid is sprayed onto the windshield and the wipers are operated briefly.

When the vehicle lighting system is switched on, the headlamps are cleaned at regular and appropriate intervals.

In cars equipped with an alarm system, the headlamps cannot be cleaned when the hood is open.

 Do not use the washers when the washer fluid reservoir is empty; otherwise, you will damage the washer pump.

Only use the washers if the hood has been completely closed; otherwise, the headlamp washer system may be damaged. Do not use the washers if there is any danger that the fluid will freeze on the windshield. If you do, your vision could be obscured. For this reason, use antifreeze. ◀

Window washer nozzles

The window washer nozzles are heated automatically while the engine is running or the ignition is switched on.

Rear window wiper



0 Rear wipers parked

1 To switch on intermittent wipe :

Turn the cap to level **1**.

Operation is continuous in reverse gear.

The rear wiper does not move if the cap is in interval stage **1** before the ignition is switched on.

Cleaning the rear window

2 To clean the rear window during intermittent wipe :

Turn the cap further to level **2** and hold it there.

3 To clean the rear window when wipers are parked :

Turn the cap to level **3** and hold it there.

 Do not use the washers when the washer fluid reservoir is empty; otherwise, you will damage the washer pump. ◀

WASHER FLUID

 Washer fluid is flammable. Keep it away from ignition sources, only store it in the closed, original container, and keep out of reach of children; otherwise, there is a danger of injury. Comply with the instructions on the container. ◀

Washer fluid reservoir

! Only refill washer fluid that contains anti-freeze when the engine is cool, to avoid contact with hot engine parts. Otherwise, fluid spills constitute a fire hazard and a risk to personal safety. ◀



Fill with water and, if required, with a washer antifreeze, according to manufacturer's recommendations.

▷ Mix the water and antifreeze before filling the washer fluid reservoir to make sure the correct concentration is maintained. ◀

Capacity

Approx. 2.6 US quarts/2.5 liters.

With headlamp washer system:
Approx. 4.8 US quarts/4.5 liters.

CRUISE CONTROL

The concept

Cruise control is available at vehicle speeds of at least approx. 20 mph or 30 km/h. The car then stores and maintains the speed that you specify using the button on the steering wheel.

! Do not use cruise control when driving at constant speed is prevented by adverse conditions, e.g. winding roads, dense traffic or poor road conditions due to, e.g. snow, rain, ice or loose surfaces. Otherwise, you could lose control of the vehicle and cause an accident as a result. ◀

Activating

Depending on the features with which your vehicle is equipped, you have one of the two buttons indicated **2** in your vehicle.

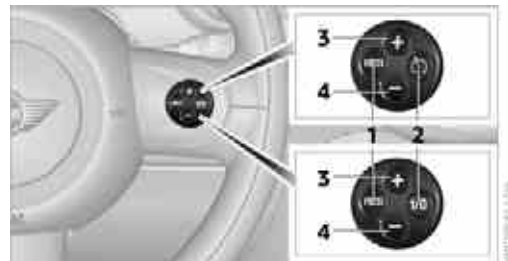

- 1** Resuming cruise control
- 2** Activating/deactivating cruise control
- 3** Maintaining, storing and increasing speed
- 4** Maintaining, storing and decreasing speed

Indicator lamp in the speedometer lights up. The cruise control system is ready and can be activated.

Activating/deactivating cruise control

Press button **2**.

The system is automatically deactivated if:

- ▷ Braking takes place
- ▷ The clutch is engaged
- ▷ The transmission is set on N
- ▷ The stability control system is on

Cruise control is not deactivated by depressing the accelerator pedal. Once the accelerator pedal is released, the stored speed is achieved again and maintained.

The stored speed is cleared when the ignition is switched off.

Maintaining current speed

Press button **3**.

The system maintains and stores the current vehicle speed.

If, on a downhill grade, the engine braking effect is not sufficient, the controlled speed may be

exceeded. On uphill grades vehicle speed may drop if the engine output is insufficient.

Increasing speed

Press button **3** repeatedly until the desired speed is reached. Every time you press the button, the speed increases by approx. 1 mph or 1 km/h.

Accelerating using the button

Press and hold button **3**.

The vehicle accelerates without pressure on the accelerator pedal. After the button is released, the driving speed is maintained and stored.

Decreasing speed

Press button **4** repeatedly until the desired speed is reached.

The functions here are the same as for increasing the speed or accelerating, except that the speed will be decreased.

Resuming a speed stored beforehand

Press button **1**.

The last speed stored is achieved again and maintained.

The stored speed is cleared when the ignition is switched off.

Display on tachometer



Selected speed is displayed briefly.

 If --- mph or --- km/h is displayed briefly in the tachometer, the conditions necessary for operation may not be fulfilled. ◀

Malfunction



The warning lamp in the tachometer lights up if the system fails. A message appears on the Control Display.

CONTROLS OVERVIEW

VEHICLE EQUIPMENT

In this chapter, all production, country, and optional equipment that is offered in the model range is described. Equipment is also described that is not available because of, for example, selected options or country version. This also applies to safety related functions and systems.

FUEL GAUGE

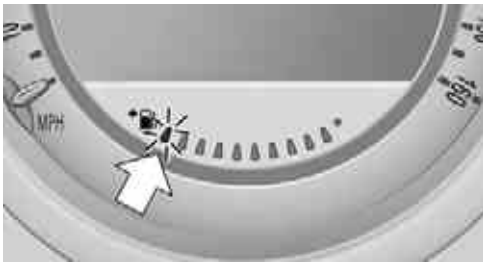

Fuel tank capacity

Approx. 13.2 US gal/50 liters.

You can find information on refueling on page 195.

If the tilt of the vehicle varies for a longer period, when you are driving in mountainous areas, for example, the indicator may fluctuate slightly.

The arrow next to the gas pump symbol of the fuel gauge points toward the side of the vehicle with the fuel filler flap.

Reserve

Once the fuel level has fallen to the reserve zone of approx. 2.1 US gal/8 liters the remaining indicator lamps change from orange to red, arrow, and a message is displayed briefly on the Control Display. The tachometer displays the remaining cruising range. When the range is less than approx. 30 miles/50 km, the message remains in the Control Display.



If the range displayed is less than 30 miles/50 km, be sure to refuel; otherwise, engine functions are not guaranteed and damage may occur. ◀

With a dynamic driving style, e.g. rapid cornering, engine functions are not always assured.

TACHOMETER



Never operate the engine with the needle in the red overspeed zone of the gauge. In this range, the fuel supply is interrupted to protect the engine.

Displays in tachometer



- 1 Current vehicle speed
- 2 Odometer in kilometers, trip recorder, external temperature, time
- 3 Resetting the trip odometer

Press button on turn signal indicator to call up information in the display area 2.

The following information is displayed sequentially:

- ▷ Trip odometer
- ▷ Time
- ▷ External temperature

Trip odometer

To display trip recorder:
Briefly press button **3**.

Resetting the trip odometer:
While the trip recorder is displayed and the ignition is switched on, press button **3**.

Time

To set time, see page [64](#).

External temperature, external temperature warning

When the displayed temperature sinks to approx. +37 °F /+3 °C, a signal sounds and a warning lamp lights up. There is an increased risk of black ice.

 Even at temperatures above +37 °F /+3 °C ice can form. Therefore, drive carefully, e.g. on bridges and sections of road in the shade; otherwise, there is an increased accident risk. ◀

Units of measure

Select the respective units of measure, miles or km for the odometer as well as °F or °C for the external temperature, page [62](#).

COMPUTER

Displays in tachometer



Press the button in the turn signal lever repeatedly to call up various items of information.

The following information is displayed sequentially:

- ▷ Cruising range
- ▷ Average fuel consumption
- ▷ Current fuel consumption
- ▷ Average speed

To set the corresponding units of measure, refer to Units of measure on page [62](#).

Cruising range

Displays the estimated cruising range available with the remaining fuel. The range is calculated on the basis of the way the car has been driven over the last 18 miles/30 km and the amount of fuel currently in the tank.

 If the range displayed is less than 30 miles/50 km, be sure to refuel; otherwise, engine functions are not guaranteed and damage could occur. ◀

Average fuel consumption

Calculated for the time the engine has been running.

With the trip computer, page [61](#), you can have the average fuel consumption for another trip displayed.

To reset average fuel consumption: press the button in the turn signal lever for approx. 2 seconds.

Current fuel consumption

Displays the current fuel consumption to allow you to see whether your current driving style is conducive to fuel economy with minimum exhaust emissions.

Average speed

Periods with the vehicle parked and the engine switched off are not included in the calculations of average speed.

With the trip computer, page 61, you can have the average speed for another trip displayed.

To reset average speed: press the button in the turn signal lever for approx. 2 seconds.

Displays on the Control Display

1. "Vehicle Info"
2. "Onboard info" or "Trip computer"



Displays in the "Onboard info":

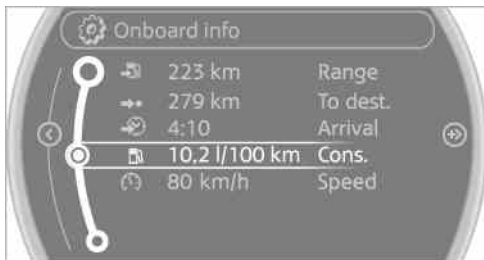

- ▷ Cruising range
- ▷ Distance from destination

- ▷ Probable arrival time when a destination has been input into the navigation system, page 114.

Displays in the "Trip computer":



- ▷ Departure time
- ▷ Trip duration
- ▷ Trip distance

Both displays show the following:

- ▷ Average fuel consumption
- ▷ Average speed

Reset fuel consumption and speed on the onboard computer

To reset the values for the average speed and average fuel consumption:

1. Select the respective menu entry.
2. Press the MINI joystick to confirm the message.

Resetting the trip computer

To reset all values:

1. "Vehicle Info"
2. "Trip computer"
3. "Reset"

SETTINGS AND INFORMATION

Operating principle

Certain settings and information are only available when the ignition is switched on, the vehicle is at a standstill and the doors are closed.



1 Button for:

- ▷ Selecting display
- ▷ Setting values
- ▷ Confirming selected display or set values
- ▷ Calling up computer information [60](#)

Exiting displays



1. Press the button in the turn signal lever repeatedly until "HOME" is displayed.
2. Press the button for a longer period.
Current vehicle speed is once again displayed.
Displays are also exited if no entries are made for approx. 8 seconds.

Next setting or item of information



1. While in a setting or information item, press the button in the turn signal indicator repeatedly until "NEXT" is displayed.
2. Press the button for a longer period.
The display changes directly to the next setting or item of information.

UNITS OF MEASURE

To set the units of measure. The settings are stored for the remote control currently in use, refer also to Personal Profile on page [28](#).

Symbol

Function

Adjusting rain sensor [55](#)Calling up Check Control [65](#)

Exiting the menu



1. "Settings"
2. "Language/Units"

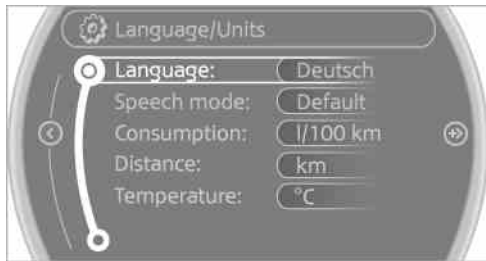

3. Select the desired menu item.
4. Select the desired unit.

SERVICE REQUIREMENTS



The remaining driving distance and the date of the next scheduled service are briefly displayed immediately after you start the engine or switch on the ignition.

 The extent of service work required can be read out from the remote control by your MINI dealer. ◀

More information on the MINI Maintenance System can be found on page 213.

More information

Detailed information on service requirements

You can have further information on the scope of maintenance displayed on the Control Display, refer to page 17.

1. "Vehicle Info"
2. "Vehicle status"



3. "Service required"

Required maintenance procedures and legally mandated inspections are displayed.

You can request more detailed information on every entry:

Select an entry and press the MINI joystick.

To exit from the menu:

Move the MINI joystick to the left. A list of selected maintenance schedules and, if required, legally mandated inspections, is shown.

Symbols



No service is currently required.



The deadline for service or a legally mandated inspection is approaching. Please schedule a service appointment.



The service deadline has already passed.

Entering deadlines for legally required inspections

Make sure the date on the Control Display is always set correctly, page 65; otherwise, the effectiveness of Condition Based Service CBS is not ensured.

1. "Vehicle Info"
2. "Vehicle status"

3. "Service required"



4. "§ Vehicle inspection"

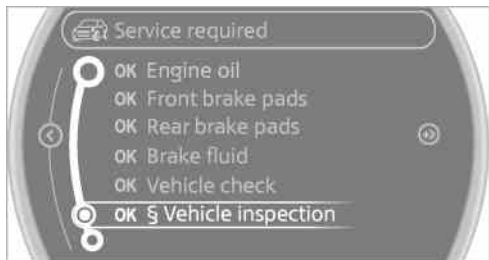

5. Open the deadline entry menu.
6. "Date:"
7. Create the settings.
8. Press the MINI joystick to apply the setting. The year is highlighted.
9. Turn the MINI joystick to make the adjustment.
10. Press the MINI joystick to apply the setting. The date entry is stored.

To exit from the menu:

Move the MINI joystick to the left.

CLOCK

Setting the time

1. "Settings"

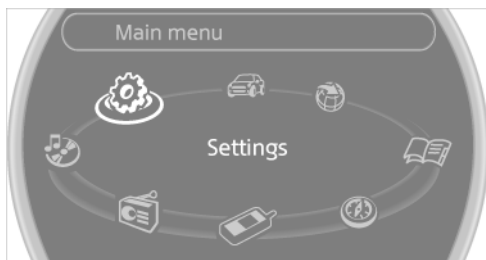

2. "Time/Date"

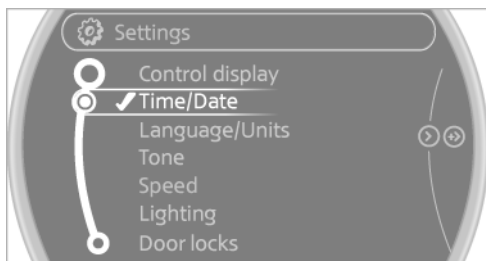

3. "Time:"

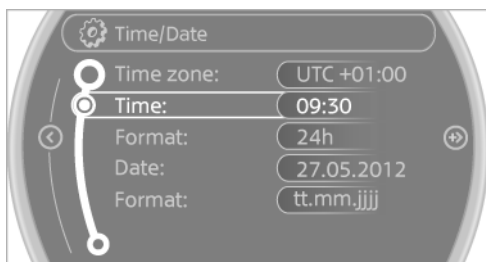

4. Turn the MINI joystick to set the hours and press the MINI joystick.
5. Turn the MINI joystick to set the minutes and press the MINI joystick.

The system accepts the new time.

Setting the time format

The settings are stored for the remote control currently in use, refer also to Personal Profile on page 28.

1. "Settings"
2. "Time/Date"
3. "Format:"
4. Select the desired format and press the MINI joystick.

The time format is stored.

Setting time zone

1. "Settings"
2. "Time/Date"
3. "Time zone:"
4. Turn MINI joystick until the desired time zone is set and press the MINI joystick.

The time zone is stored.

DATE

Setting date

1. "Settings"
2. "Time/Date"
3. "Date:"
4. Turn MINI joystick until the desired day is displayed and press the MINI joystick.
5. Create the necessary settings for the month and year.

The date is stored.

Setting the date format

1. "Settings"
2. "Time/Date"

3. "Format:"



4. Select the desired format.

The settings are stored for the remote control currently in use, refer also to Personal Profile on page 28.

CHECK CONTROL

The concept

The Check Control monitors vehicle functions and alerts you to any malfunctions in the systems monitored. Check Control messages involve indicator and warning lamps in the display and, in some circumstances, an acoustic signal as well as text messages at the bottom of the Control Display.

Indicator and warning lamps



Indicator and warning lamps can light up in various combinations and colors in the indicator areas 1 and 2.

Text messages

Text messages at the upper edge of the Control Display explain the meaning of the displayed indicator and warning lamps.

Supplemental text messages

For most Check Control messages, you can view more information later, e.g. regarding the cause of a malfunction and how to respond, refer to page 67.

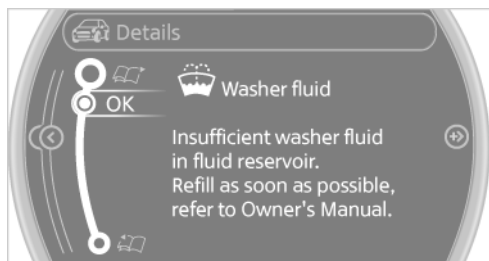

In urgent cases, this information will be shown as soon as the corresponding lamp comes on.

Exit display:
"OK"

Hiding Check Control messages

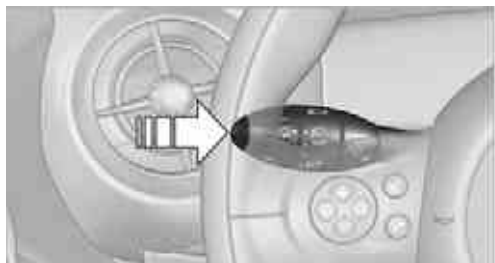

Press the button in the turn signal lever.

- ▶ Some Check Control messages are displayed until the malfunctions have been rectified. They cannot be hidden. If several malfunctions occur at the same time, they are displayed in succession.

▶ They are marked with the symbol shown here.

- ▶ Other Check Control messages are automatically hidden after approx. 20 seconds, but remain stored.

▶ They are marked with the symbol shown here.

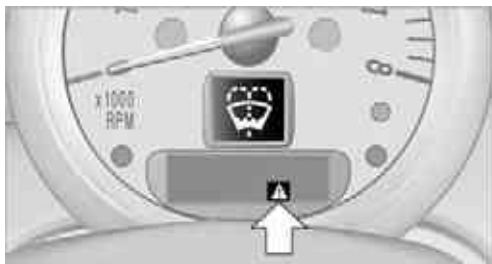

⚠ The symbol indicates that Check Control messages have been stored. Check Control messages can be viewed whenever it is convenient.

Viewing stored Check Control messages

Stored Check Control messages can only be displayed if the driver's door is closed.

1. Press the button in the turn signal indicator as often as necessary until "SET/INFO" is displayed.



2. Press and hold the button until the display changes.

- Press the button repeatedly until the corresponding symbol and "CHECK INFO" appear in the display.



- Press and hold the button. If there are no Check Control messages, then "CHECK OK" is displayed. If a Check Control message has been stored, the corresponding message is displayed. In addition, the text message appears on the Control Display.
- Press the button to check for other messages.

Displaying on the onboard computer

- "Vehicle Info"
- "Vehicle status"
- "Check Control"

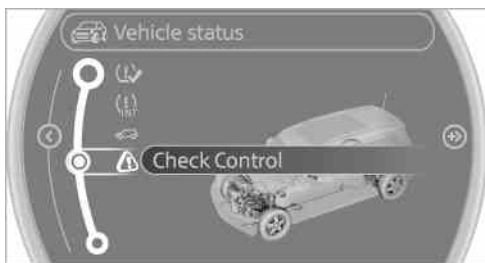

- Select the text message.
- Select a text message.

SPEED LIMIT

Enter a speed, and a Check Control message will indicate when you reach this speed. This enables

you, for example, to receive warnings if you exceed a speed limit in an urban area. You are only warned of reaching this speed a second time if your vehicle speed falls below it again by at least 3 mph or 5 km/h.

Displaying, setting or changing the limit

- "Settings"
- "Speed"
- "Warning at:"



- Turn the MINI joystick to set the limit.
- Press the MINI joystick to apply the setting. The limit is stored.

Applying your current speed as limit

- "Settings"
- "Speed"
- "Select current speed"



- Press the MINI joystick.

The system adopts your current speed as the limit.

Activating/deactivating the limit

1. "Settings"
2. "Speed"
3. "Warning"



4. Press the MINI joystick.

ALTERING SETTINGS

Language on the Control Display

You can set the language on the Control Display.

1. "Settings"

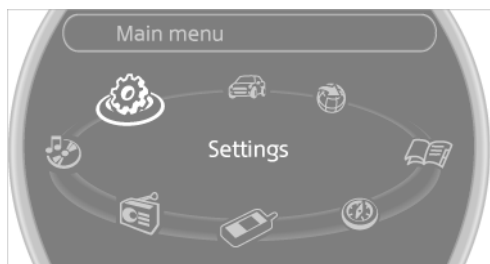

2. "Language/Units"
3. "Language:"

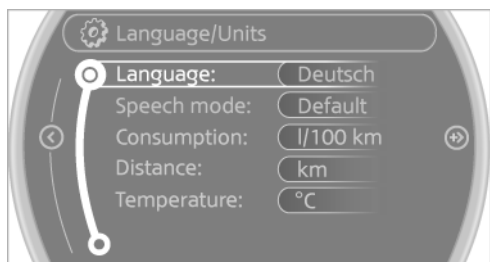

4. Select the desired language.

The setting is stored for the remote control currently in use.

Setting the voice dialog

Switch between a standard dialog and a short dialog.

1. "Settings"
2. "Language/Units"
3. "Speech mode:"
4. Select the desired dialog.

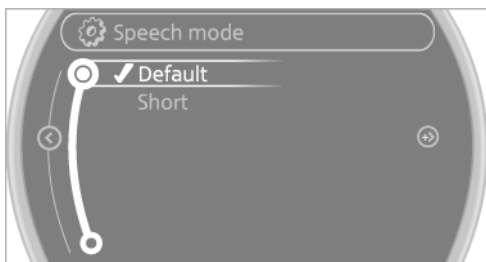

The setting is stored for the remote control currently in use.

Brightness of the Control Display

The brightness is automatically adapted to the ambient lighting conditions. Note, however, that you can change the basic setting while the low beams are switched on. The setting is stored for the remote control currently in use.

1. "Settings"
2. "Control display"
3. "Brightness"

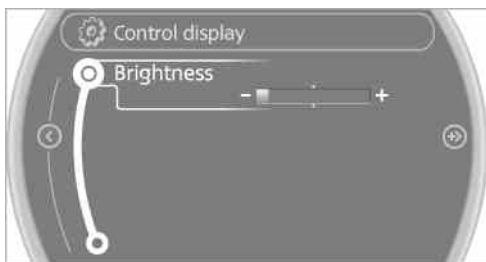

4. Turn the MINI joystick until the desired setting is reached.
5. Press the MINI joystick.

The setting is stored for the remote control currently in use. In bright conditions, for example, the brightness control may not be clearly visible.

TECHNOLOGY FOR DRIVING COMFORT AND SAFETY

VEHICLE EQUIPMENT

In this chapter, all production, country, and optional equipment that is offered in the model range is described. Equipment is also described that is not available because of, for example, selected options or country version. This also applies to safety related functions and systems.

PARK DISTANCE CONTROL PDC

The concept

PDC assists you with parking in reverse. Acoustic signals and a visual indicator warn you of the presence of an object behind the vehicle. To measure the distance, there are four ultrasonic sensors in either bumper.



These sensors have a range of approx. 6.5 ft/2 m. However, an acoustic warning does not sound until an object is approx. 24 in/60 cm from the rear corner sensors, or approx. 5 ft/1.50 m from the rear center sensors. PDC is a parking aid that can indicate objects when they are approached slowly, as is usually the case when parking. Avoid approaching an object at high speed; otherwise, physical circumstances may lead to the system warning being issued too late. ◀

Automatic mode

With the engine running or the ignition switched on, the system is activated automatically after approx. 1 second when you engage reverse gear or move the automatic transmission selector lever to position R. Wait this short period before driving.

Acoustic signals

As the distance between vehicle and object decreases, the intervals between the tones become shorter. If the distance to the nearest object falls to below roughly 1 ft/30 cm, then a continuous tone sounds.

If the distance remains constant, e.g. when driving parallel to a wall, the acoustic signal stops after approx. 3 seconds.

Malfunction



Indicator lamp lights up. PDC has failed. A message appears on the Control Display. Have the system checked.

To avoid this problem, keep the sensors clean and free of ice or snow in order to ensure that they will continue to operate effectively. When using a high-pressure cleaner, do not direct the jet toward the sensors for lengthy periods and only spray from a distance of at least 4 in/10 cm.

PDC with visual warning

To have the system show distances to objects on the Control Display. The contours of distant objects are shown on the Control Display even before the acoustic signal sounds. The display appears on the Control Display as soon as the transmission is shifted into reverse or the selector lever is moved into the R position.

System limitations



Even with PDC, final responsibility for estimating the distance between the vehicle and any obstructions always remains with the driver. Sensors, too, have blind spots in which objects cannot be detected. Moreover, ultrasonic detection can reach its physical limits with objects such as trailer tow bars and couplings, thin and wedge-shaped objects, etc. Low objects already indicated, such as curbs, may

enter the sensors' blind spots before or after a continuous audible signal is given. Higher, protruding objects, such as wall ledges, may not be detectable. Therefore, always drive cautiously; otherwise, there is a risk of personal injury or property damage. Loud sound sources outside or inside the car can drown out the PDC signal. ◀

DRIVING STABILITY CONTROL SYSTEMS

Your MINI has a number of systems that help to maintain the vehicle's stability even in adverse driving conditions.

 The laws of physics cannot be repealed, even with driving stability control systems. An appropriate driving style always remains the responsibility of the driver. Therefore do not reduce the additional safety margin by engaging in hazardous driving thereby running the risk of an accident. ◀

Antilock Brake System ABS

ABS prevents locking of the wheels during braking. Safe steering response is maintained even during full braking. Active safety is thus increased.

Braking safely, refer to page 103.

ABS is operational every time you start the engine.

Cornering Brake Control CBC

Driving stability and steering characteristics are further enhanced while braking in turns or during a lane change.

Electronic brake-force distribution EBV

The system controls the brake pressure in the rear wheels to ensure stable braking behavior.

Brake Assist

Rapidly depressing the brake causes this system to automatically develop maximum braking force. Thus, the system helps keep braking distance to a minimum. At the same time, all the benefits provided by ABS are exploited.

Do not reduce the pressure on the brake for the duration of the full braking application.

Dynamic Stability Control DSC

The concept

DSC prevents the driving wheels from losing traction when you pull away from rest or accelerate.

DSC also detects unstable driving conditions such as when the vehicle's rear end fishtails or the vehicle is sliding on its front wheels. In these cases, DSC helps the vehicle maintain a safe course within physical limits by reducing engine output and through braking actions at the individual wheels.

Every time that the engine is started, DSC is ready to operate.

Deactivating DSC



Press the button until the DSC OFF indicator lamp on the speedometer is on and DSC OFF is displayed on the tachometer. DSC is deactivated. Stabilizing and propulsion promoting actions are no longer executed.

When driving with snow chains or to 'rock free' in snow, it can be helpful to switch off DSC for a brief period.

To increase vehicle stability, activate DSC again as soon as possible.

Activating DSC

Press the button again: the DSC indicator lamps in the display elements go out.

For better control



The indicator lamp on the tachometer is flashing:

DSC controls the driving and braking forces.



The indicator lamp DSC OFF on the speedometer is on and DSC OFF is displayed on the tachometer:

DSC is deactivated.



Dynamic Traction Control DTC

The concept

DTC is a type of DSC that is propulsion optimized for special road conditions such as uncleared snowy roads. The system ensures maximum propulsion though with restricted driving stability. You therefore need to drive with suitable caution.

In the following exceptional situations, it can be useful to briefly activate DTC:

- ▷ When driving on snow-covered inclines, in slush, or on uncleared snowy roads.
- ▷ When rocking the vehicle free, driving out of deep snow or on loose surfaces.
- ▷ When driving with snow chains.

Activating DTC



Press the button; the indicator lamp DSC OFF on the speedometer comes on and TRACTION is displayed on the tachometer. The Dynamic Stability Control DSC is deactivated; the Dynamic Traction Control DTC is activated.

For better control



The indicator lamp on the tachometer is flashing:

DTC controls the driving and braking forces.



The indicator lamp on the speedometer is on and TRACTION is displayed on the tachometer:

DTC is activated.

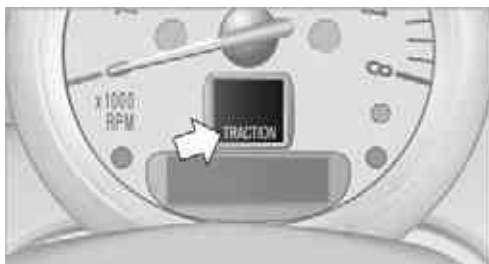

Deactivating DTC

Press button again, the indicator lamp DSC OFF on the speedometer and TRACTION on the tachometer go out.

Deactivating both DTC and DSC



Press the button for at least 3 seconds; the indicator lamp DSC OFF on the speedometer comes on and DSC OFF is displayed on the tachometer. The Dynamic Traction Control DTC and Dynamic Stability Control DSC are both deactivated. There will be no more stabilizing interventions.

Interventions (differential lock) in braking occur to improve propulsion when drive wheels are rotating unevenly, even when DSC is deactivated.

Activating DSC

Press the button again: the indicator lamps go out.

Hill Assist

Hill Assist aids you in comfortably driving off on inclines. It is not necessary to use the parking brake for this.

1. Hold the MINI with the brake.
2. Release the brake and immediately drive off.

Hill Assist holds the car in place for approx. 2 seconds after the brake is released.

 Depending on the load and gradient, the vehicle can roll backward slightly during this period. After you release the brake, immediately start driving since the Hill Assist only holds the vehicle for about 2 seconds, and it will start to roll backward. ◀

SPORT BUTTON

Pressing the button causes your MINI to respond even more sportily.

- ▷ Engine responds more spontaneously to movements of the accelerator.
- ▷ Steering response is more direct.
- ▷ Cooper S, John Cooper Works: the engine sounds more sporty in coasting mode.

With automatic transmission:

- ▷ More rapid gear shifting in Sport program.

Activating the system



Press the button.
The LED lights up.

SPORT is briefly displayed in the tachometer.

Deactivating the system

- ▷ Press the button again.
- ▷ Switch off the engine.

FLAT TIRE MONITOR FTM

The concept

The system does not measure the actual inflation pressure in the tires.

The system detects a pressure loss in a tire by comparing the rotational speeds of the individual wheels while moving.

In the event of a pressure loss, the diameter and therefore the rotational speed of the corresponding wheel change. This is detected and reported as a flat tire.

Functional requirement

The system must have been initialized while the tire inflation pressure was correct; otherwise, reliable signaling of a flat tire is not ensured.

Initialize the system after every correction of the tire inflation pressure and after every tire or wheel change.

System limitations

 Sudden serious tire damage caused by external influences cannot be indicated in advance. ◀

A natural, even pressure loss in all four tires cannot be detected. Therefore, check the tire inflation pressure regularly.

In the following situations, the system could be delayed or malfunction:

- ▷ System has not been initialized.
- ▷ Driving on snowy or slippery road surface.
- ▷ Performance-oriented style of driving: slip in the drive wheels, high lateral acceleration.
- ▷ Snow chains are attached.

When the vehicle is driven with a space-saver spare tire, page 230, the Flat Tire Monitor cannot function.

Status display

The current status of the Flat Tire Monitor can be displayed on the Control Display, e.g. whether or not the FTM is active.

1. "Vehicle Info"
2. "Vehicle status"

3. "Flat Tire Monitor"



The status is displayed.

Initializing the system

The initialization process adopts the set inflation tire pressures as reference values for the detection of a flat tire. Initialization is started by confirming the inflation pressures.

Do not initialize the system when driving with snow chains.

1. "Vehicle Info"
2. "Vehicle status"
3. "Reset"

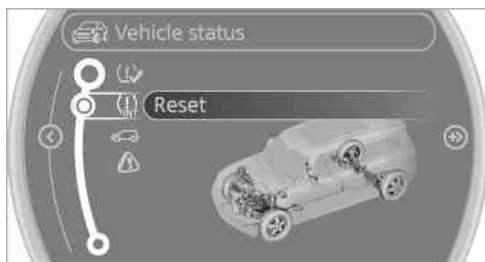

4. Start the engine, but do not start driving.
5. Select "Reset" to start the initialization.
6. Start to drive.

 The initialization is completed during driving, which can be interrupted at any time. When driving resumes, the initialization is continued automatically. ◀

Indication of a flat tire

 The warning lamps come on in yellow and red. A message appears on the Control Display. An acoustic signal also sounds. There is a flat tire or a major loss in tire inflation pressure.

1. Reduce speed and stop the vehicle with caution. Avoid sudden braking and steering maneuvers.
2. Check whether the vehicle is equipped with normal tires or with run-flat tires.

Run-flat tires, refer to page 207, are identified by a circular symbol containing the letters RSC on the tire sidewall.

 If the vehicle is not equipped with run-flat tires, do not continue driving; continuing to drive can result in serious accidents. ◀

When a flat tire is reported, the Dynamic Stability Control DSC is activated.

Actions in the event of a flat tire

Normal tires

1. Identify the damaged tire.

To do so, check the inflation pressure in all four tires.

The inflation pressure display of the Mobility Kit, page 226, can be used for this purpose.

If the inflation pressure in all four tires is correct, the Flat Tire Monitor might not have been initialized. The system must then be initialized.

If it is not possible to identify the damaged tire, contact your MINI dealer.

2. Use the Mobility Kit to remedy the flat tire on the damaged wheel, refer to page 226, or to replace the damaged wheel, refer to page 228.

Run-flat tires

You can continue driving with a damaged tire at speeds up to 50 mph or 80 km/h.

Continued driving with a flat tire

When driving with a damaged tire:

1. Avoid sudden braking and steering maneuvers.
2. Do not exceed a speed of 50 mph or 80 km/h.
3. At the next opportunity, check the air pressure in all four tires.

If the inflation pressure in all four tires is correct, the Flat Tire Monitor might not have been initialized. The system must then be initialized.

Possible driving distance with complete loss of tire inflation pressure:

The distance it is possible to drive with a flat tire depends on the load and the stress on the vehicle while driving.

With an average load, it may be possible to drive for approx. 50 miles/80 km.

When driving with damaged tires, the handling characteristics change, e.g. the vehicle will skid sooner when braking, braking distances will be longer, or self-steering response will change. Adapt your driving style accordingly. Avoid turning abruptly and driving over obstacles such as curbs, potholes, etc.

Since the possible driving distance depends to a considerable degree on the strain exerted on the vehicle while driving, it can be shorter or, with a gentle driving style, can also be longer, depending on the speed, road condition, external temperature, vehicle load, etc.

 Drive cautiously and do not exceed a speed of 50 mph/80 km/h.

A loss of tire inflation pressure results in a change in the handling characteristics, e.g. reduced lane stability during braking, a longer braking distance and altered self-steering properties. ◀

 Vibrations or loud noises while driving can indicate final failure of the tire. Reduce your speed and bring the vehicle to a stop; otherwise, pieces of tire may come off, which could

result in an accident. Do not continue driving and contact your MINI dealer. ◀

TIRE PRESSURE MONITOR TPM

The concept

Measuring the inflation pressure in the four mounted tires. The system notifies you if there is a significant loss of pressure in one or more tires.

Functional requirement

The system must have been reset while the inflation pressure was correct; otherwise, reliable signaling of a flat tire is not ensured.

Always use wheels with TPM electronics to ensure that the system will operate properly.

Reset the system again after each correction of the tire inflation pressure and after every tire or wheel change.

System limitations

 Sudden, serious tire damage caused by external influences cannot be indicated in advance. ◀

The system does not operate correctly if it has not been reset. For example, a flat tire may be indicated despite correct tire inflation pressures.

The system is inactive and cannot indicate a flat tire:

- ▷ If a wheel without TPM electronics, e.g. a compact spare wheel, is mounted.
- ▷ Interference with TPM by other systems or devices with the same transmission frequency.

Status display

The current status of the Tire Pressure Monitor can be displayed by the onboard computer, e.g. whether or not the TPM is activated.

1. "Vehicle Info"
2. "Vehicle status"
3. "Tire Pressure Monitor - TPM"



The status is displayed.

Status indicator on the onboard computer

The tire and system condition is indicated by the color of the tires.

A change in the tire inflation pressure during driving is taken into account.

A correction is only required when this is indicated by the TPM.

Green wheels

The inflation pressure corresponds to the desired state.

"TPM active" is displayed on the onboard computer.

One wheel yellow

There is a flat tire or substantial loss of tire pressure in the indicated tire.

All wheels yellow

- ▷ There is a flat tire or substantial loss of tire pressure in several tires.
- ▷ The system was not reset after a wheel change and thus issues a warning based on the inflation pressures initialized last.

Gray wheels

The system cannot detect a puncture.

Reasons for this may be:

- ▷ TPM is being reset.
- ▷ Interference from systems or devices with the same transmission frequency.
- ▷ Malfunction.

Resetting the system

Reset the system again after each correction of the tire inflation pressure and after every tire or wheel change.

1. "Vehicle Info"
2. "Vehicle status"
3. "Reset"

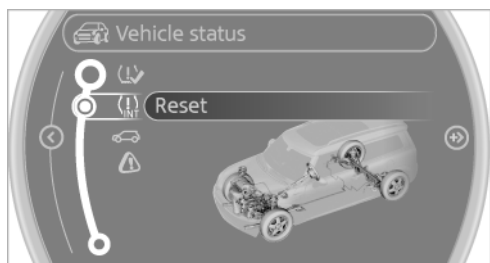

4. Start the engine – do not drive away.
5. Select "Reset" to start the initialization.
6. Start to drive.

The tires are shown in gray and "Resetting TPM..." is displayed.

After driving a few minutes, the set inflation pressures in the tires are accepted as the target values to be monitored. The resetting process is completed automatically as you drive. The tires are depicted in green on the Control Display and "Status: TPM active" is displayed again.

The trip can be interrupted at any time. When driving resumes, resetting is continued automatically.

 If a flat tire is detected while the system is resetting, all tires on the Control Display are displayed in yellow. The message "Low tire!" is displayed. ◀

Message for low tire inflation pressure



The warning lamps come on in yellow and red. A message appears on the onboard computer. An acoustic signal also sounds.

- ▷ There is a flat tire or substantial loss of tire pressure in the indicated wheel.
 - ▷ The system was not reset after a wheel change and thus issues a warning based on the inflation pressures initialized last.
1. Reduce speed and stop the vehicle with caution. Avoid sudden braking and steering maneuvers.
 2. Check whether the vehicle is equipped with normal tires or with run-flat tires.

Run-flat tires, refer to page 207, are identified by a circular symbol containing the letters RSC on the tire sidewall.

When a low inflation pressure is reported, the Dynamic Stability Control DSC is activated.

Actions in the event of a flat tire

Normal tires

1. Identify the damaged tire.

To do so, check the inflation pressure in all four tires. The inflation pressure display of the Mobility Kit, refer to page 226, can be used for this.

If the inflation pressure is correct in all four tires, then the Tire Pressure Monitor may not have been reset. The system must then be reset.

If it is not possible to identify the damaged tire, contact your MINI dealer.

2. Use the Mobility Kit to remedy the flat tire on the damaged wheel, refer to page 226, or to replace the damaged wheel, refer to page 228.

The use of tire sealant, e.g. Mobility Kit, can damage the TPM wheel electronics. In this case, have the electronics checked and replaced if necessary at your earliest opportunity.

Run-flat tires

You can continue driving with a damaged tire at speeds up to 50 mph/80 km/h.

 If the vehicle is not equipped with run-flat tires, do not continue driving; continuing to drive can result in serious accidents. ◀

Continued driving with a flat tire

When driving with a damaged tire:

1. Avoid sudden braking and steering maneuvers.
2. Do not exceed a speed of 50 mph/80 km/h.
3. At the next opportunity, check the air pressure in all four tires.

If the inflation pressure is correct in all four tires, then the Tire Pressure Monitor may not have been reset. The system must then be reset.

Possible driving distance with complete loss of tire inflation pressure:

The distance it is possible to drive with a flat tire depends on the load and the stress on the vehicle while driving.

With an average load, it may be possible to drive for approx. 50 miles/80 km.

When driving with damaged tires, the handling characteristics change, e.g. the vehicle will skid sooner when braking, braking distances will be longer, or self-steering response will change. Adapt your driving style accordingly. Avoid turning abruptly and driving over obstacles such as curbs, potholes, etc.

Since the possible driving distance depends to a considerable degree on the strain exerted on the vehicle while driving, it can be shorter or, with a gentle driving style, can also be longer, depending on the speed, road condition, external temperature, vehicle load, etc.

 Drive cautiously and do not exceed a speed of 50 mph/80 km/h.

A loss of tire inflation pressure results in a change in the handling characteristics, e.g. reduced lane stability during braking, a longer

braking distance and altered self-steering properties. ◀

 Vibrations or loud noises while driving can indicate complete failure of the tire. Reduce your speed and bring the vehicle to a stop; otherwise, pieces of tire may come off, which could result in an accident. Do not continue driving and contact your MINI dealer. ◀

Malfunction

 The small warning lamp flashes in yellow and then lights up continuously; the larger warning lamp lights up in yellow. On the onboard computer, the tires are shown in gray and a message appears.

No punctures can be detected.

Display in the following situations:

- ▷ Wheel without TPM electronics is mounted: If need be, have it checked by your MINI dealer.
- ▷ Malfunction: Have the system checked.
- ▷ TPM was unable to complete the resetting procedure; reset the system again.

 The small warning lamp flashes in yellow and then lights up continuously; the larger warning lamp lights up in yellow. On the onboard computer, the tires are shown in gray and a message appears.

No punctures can be detected.

Display in the following situation:

- ▷ Malfunction because of other equipment or devices, same radio frequency: After leaving the interference area, the system is again active automatically.

Message for unsuccessful system reset

 Yellow warning lamp comes on. A message appears on the onboard computer.

The system has detected a wheel change, but has not yet been reset. It is not possible to pro-

vide a reliable warning about the current inflation pressure.

Check the tire inflation pressure and reset the system, page 77.

Declaration according to NHTSA/ FMVSS 138 Tire Pressure Monitoring Systems

Each tire, including the spare, should be checked monthly when cold and inflated to the inflation pressure recommended by the vehicle manufacturer on the vehicle placard or tire inflation pressure label. If your vehicle has tires of a different size than the size indicated on the vehicle placard or tire inflation pressure label, you should determine the proper tire inflation pressure for those tires. As an added safety feature, your vehicle has been equipped with a tire pressure monitoring system TPMS that illuminates a low tire pressure telltale when one or more of your tires are significantly underinflated.

Accordingly, when the low tire pressure telltale illuminates, you should stop and check your tires as soon as possible, and inflate them to the proper pressure. Driving on a significantly underinflated tire causes the tire to overheat and can lead to tire failure. Underinflation also reduces fuel efficiency and tire tread life and may affect the vehicle's handling and stopping ability. Please note that the TPMS is not a substitute for proper tire maintenance, and it is the driver's responsibility to maintain correct tire pressure, even if underinflation has not reached the level sufficient to trigger illumination of the TPMS low tire pressure telltale.

The TPMS malfunction indicator is combined with the low tire pressure telltale. When the system detects a malfunction, the telltale will flash for approximately one minute and then remain continuously lit. This sequence will continue upon subsequent vehicle startups as long as the malfunction exists. When the malfunction indicator is illuminated, the system may not be able to detect or signal low tire pressure as intended. TPMS malfunctions may occur for a variety of reasons, including the installation of replace-

ment or alternate tires or wheels on the vehicle that prevent the TPMS from functioning properly. Always check the TPMS malfunction telltale after replacing one or more tires or wheels on your vehicle to ensure that the replacement or alternate tires and wheels allow the TPMS to continue to function properly.

AIRBAGS

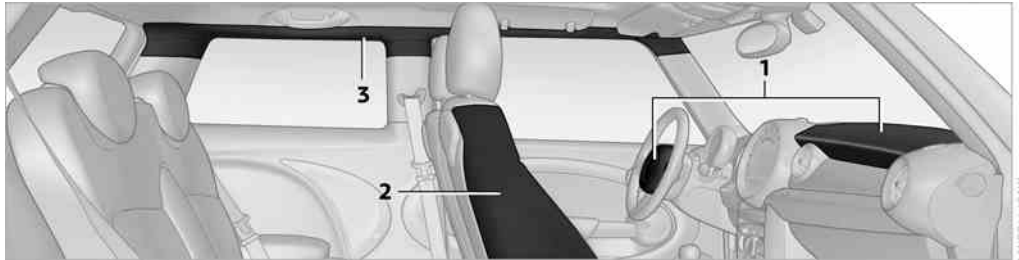

The following airbags are located under the marked covers:

- 1 Front airbags
- 2 Side airbags in backrests
- 3 Head airbags at the front and rear

Protective action

! Observe the instructions on page 40 to ensure the best possible personal protection. ◀

The front airbags help protect the driver and front passenger by responding to frontal impacts in which safety belts alone cannot provide adequate restraint. When needed, the head and side airbags help provide protection in the event of side impact. The relevant side airbag supports the side upper body area. The respective head airbag supports the head.

The airbags are designed to not be triggered in every type of collision, e.g. not in minor accidents, certain rollover situations or rear impacts.

! Do not apply adhesive materials to the cover panels of the airbags, cover them or modify them in any other way.

Keep the dashboard and window on the passenger side free from obstruction, i.e. do not cover it with adhesive film or coverings, and do not affix any holders such as for a navigation device or a mobile phone.

Do not attach seat covers, cushions or other objects not specifically approved for seats with integral side airbags to the front seats. Do not hang items of clothing such as coats or jackets over the backrests. Do not attempt to remove the airbag retention system from the vehicle. Do not modify the individual components of the

system or its wiring in any way. This includes the upholstery in the center of the steering wheel, on the instrument cluster, the doors, and the roof pillars as well as the sides of the headliner. Do not attempt to remove or dismantle the steering wheel.

Do not touch the individual components immediately after the system has been triggered, because there is a danger of burns.

In the event of malfunctions, deactivation, or triggering of the airbag restraint system, have the testing, repair, removal, and disposal of airbag generators executed only by a MINI dealer or a workshop that works according to repair procedures of the manufacturer of your MINI with correspondingly trained personnel and has the required explosives licenses. Otherwise, unprofessional attempts to service the system could lead to failure in an emergency or undesired airbag activation, either of which could result in personal injury. ◀

Warning notices and information about the airbags can also be found on the sun visors.

Automatic deactivation of the front passenger airbags

An analysis of the impression in the front passenger seat cushion determines whether and how the seat is occupied. The front and side air-

bags for the front passenger are activated or deactivated by the system accordingly.

 The indicator lamp above the interior rear-view mirror shows the current status of the front passenger airbags, deactivated or activated, refer to Status of front passenger airbags below. ◀

 Before transporting a child on the front passenger seat, read the safety precautions and handling instructions under Transporting children safely, page 46.

The front and side airbags can also be deactivated by adolescents and adults sitting in certain positions; the indicator lamp for the front passenger airbags comes on. In such cases, the passenger should change his or her sitting position so that the front passenger airbags are activated and the indicator lamp goes out. If the desired airbag status cannot be achieved by changing the sitting position, transport the relevant passenger on a rear seat. Do not attach covers, cushions, ball mats or other items to the front passenger seat unless they are specifically recommended by the manufacturer of your MINI. Do not place items under the seat which could press against the seat from below. Otherwise, a correct analysis of the seat cushion is not ensured. ◀

Status of front passenger airbags



The indicator lamp for the front passenger airbags shows the functional status of the front passenger's front and side airbags in accordance with whether and how the front passenger seat is occupied. The indicator lamp shows whether

the front passenger airbags are activated or deactivated.

▷ The indicator lamp comes on as intended when a child in a specially designated child restraint system is detected on the seat. The front and side airbags for the front passenger are not activated.

 Most child seats are detected by the system. This particularly applies to child seats that were required by NHTSA at the time of manufacture of the vehicle. After installing a child seat, check that the indicator lamp for the front passenger airbags lights up. It indicates that the child seat has been detected and that the front passenger airbags are deactivated. ◀

▷ The indicator lamp does not come on as long as a person of sufficient size and in a correct sitting position is detected on the seat. The front and side airbags for the front passenger are activated.

▷ The indicator lamp does not come on if the seat is empty. The front and side airbags for the front passenger are not activated.

Operational readiness of airbag system



As of radio readiness, page 49, the warning lamp lights up briefly to indicate that the entire airbag system and the belt tensioners are operational.

Airbag system malfunction

- ▷ The warning lamp does not come on when radio readiness is switched on.
- ▷ The warning lamp stays lit continuously.



In the event of a fault in the airbag system, have it checked without delay; otherwise, there is the risk that the system will not function as intended even if a severe accident occurs. ◀

LAMPS

VEHICLE EQUIPMENT

In this chapter, all production, country, and optional equipment that is offered in the model range is described. Equipment is also described that is not available because of, for example, selected options or country version. This also applies to safety related functions and systems.

PARKING LAMPS/LOW BEAMS

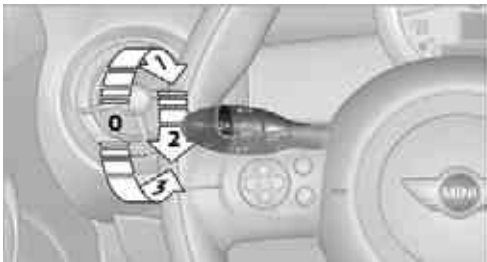

- 0** Lamps off / daytime running lights
- 1** Parking lamps and daytime running lights
- 2** Low-beam headlamps and welcome lamps
- 3** Automatic headlamp control, daytime running lights, welcome lamps, and Adaptive Light Control

When you open the driver's door with the ignition switched off, the exterior lighting is automatically switched off if the light switch is in position **0**, **2** or **3**.

Switch on the parking lamps if necessary, switch position **1**.

Parking lamps

Turn the light switch to position **1**. The front, rear and side vehicle lighting is switched on.

Activation of lights on one side of the vehicle for parking, page [85](#).



The parking lamps will discharge the battery. Therefore, do not leave them on for unduly long periods of time; otherwise, the battery might not have enough power to start the engine. ◀

Low beams

Turn the light switch to position **2**.

The low beams come on when the ignition is on.

Automatic headlamp control

When the switch is in position **3**, the low beams are switched on and off automatically depending on ambient light conditions, e.g. in a tunnel, in twilight, or if there is precipitation. Adaptive Light Control is active.

The headlamps may also come on when the sun is sitting low on a blue sky.

When driving into tunnels with bright overhead lights, there may be a delay before the headlamps come on.

The low beams remain switched on independent of the ambient lighting conditions when you switch on the fog lamps.

If the daytime running lights are activated, page [84](#), the low beams are always switched on with the light switch in position **3** and the ignition on. The exterior lamps are automatically switched off after the vehicle is parked.



The automatic headlamp control cannot serve as a substitute for your personal judgment in determining when the lamps should be switched on in response to ambient lighting conditions. For example, the system cannot detect fog or hazy weather. To avoid safety risks, you should respond to these kinds of low-visibility situations by switching the headlamps on manually. ◀

Welcome lamps

If you leave the light switch in the low beam or automatic headlamp control position when you switch off the ignition, the parking lamps and interior lamps come on for a certain time as soon as the vehicle is unlocked.

Pathway lighting

If you activate the headlamp flasher after switching off the ignition with the lamps switched off, the low beams come on and remain on for a certain time.

The setting is stored for the remote control in use, refer to Personal Profile, page 28.

Setting the duration or deactivating the function

1. "Settings"
2. "Lighting"
3. "Pathway light.:"
4. Set a time of duration or deactivate the function.

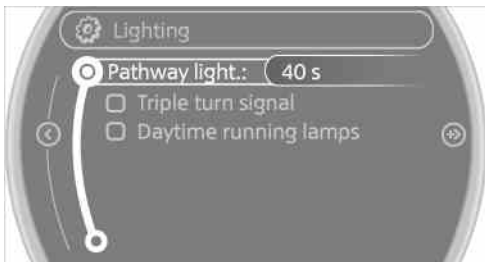

The setting is stored for the remote control currently in use.

Daytime running lights

The light switch can remain in the lamps off, parking lamps or automatic headlamp control position.

In the lamps off position, the exterior lighting is automatically switched off after the vehicle is parked. In the parking lamps position, the parking lamps will stay on after the ignition is switched off.

Switch on the parking lamps separately if needed.

Activating/deactivating daytime running lights

The setting is stored for the remote control in use, refer to Personal Profile, page 28.

1. "Settings"
2. "Lighting"
3. "Daytime running lamps"

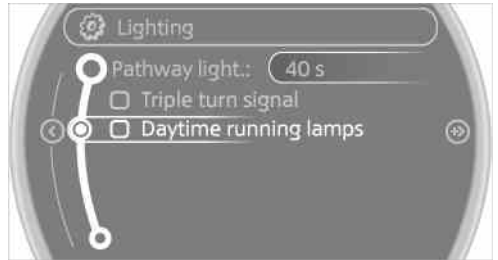

The setting is stored for the remote control currently in use.

ADAPTIVE LIGHT CONTROL

The concept

Adaptive Light Control is a variable headlamp control system that enables better illumination of the road surface. Depending on the steering angle and other parameters, the light from the headlamp follows the course of the road.

Activating Adaptive Light Control

With the ignition switched on, turn the light switch to position 3, refer to page 83.

Standstill function: to avoid blinding oncoming traffic, the Adaptive Light Control does not pivot toward the driver's side when the vehicle is at a standstill.

In reverse, the Adaptive Light Control is not activated.

Malfunction

A message is displayed.

The Adaptive Light Control is malfunctioning or failed. Have the system checked as soon as possible.

HIGH BEAMS/ ROADSIDE PARKING LAMPS

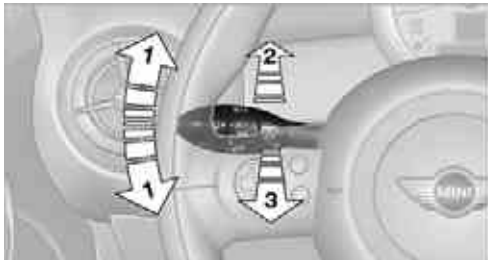

- 1 Turn signals/roadside parking lamps
- 2 Switching on high beams
- 3 Switching off high beams/headlamp flasher

Roadside parking lamps, left or right

The vehicle can be illuminated on one side for parking. Comply with local regulations when doing so.

Switching on

After parking the vehicle, press the lever up or down, arrow 1.

 The roadside parking lamps drain the battery. Therefore, do not leave them on for unduly long periods of time; otherwise, the battery might not have enough power to start the engine. ◀

Switching off

Press the lever up or down to the pressure point.

FRONT FOG LAMPS

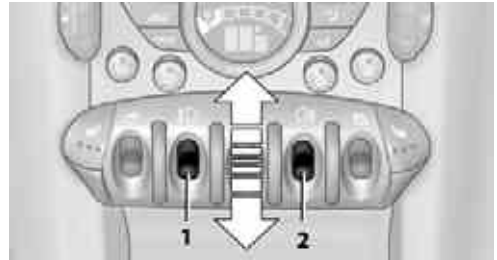

- 1 Front fog lamps
- 2 Rear fog lamp

Press the respective switch to turn the lamps on/off.

Front fog lamps

The parking lamps or low beams must be switched on for the fog lamps to operate. The green indicator lamp lights up when the fog lamps are switched on.

Depending on your vehicle's equipment, the fog lamps are switched off when you activate the headlamp flasher or switch on the high beams.

 If the automatic headlamp control is activated, the low beams will come on automatically when you switch on the fog lamps. ◀

Rear fog lamp

The low beams or parking lamps with fog lamps must be switched on. The yellow indicator lamp comes on when the rear fog lamp is switched on.

INSTRUMENT LIGHTING

You can adjust the brightness of the instrument lighting only when the parking lamps or the low beams are on.

The intensity of the brightness changes up to a predetermined end point, and then decreases.



Adjusting brightness

- ▷ Briefly press button: brightness changes in stages.
- ▷ Press and hold the button. Brightness changes in a continuous manner.

INTERIOR LAMPS

The interior lighting, the footwell lamps and the luggage compartment lighting are automatically controlled.

 To reduce the drain on the battery, a short while after the ignition is switched off, refer to Start/Stop button on page 49, all lights in the vehicle's passenger compartment are switched off. ◀

Switching interior lamps on/off manually

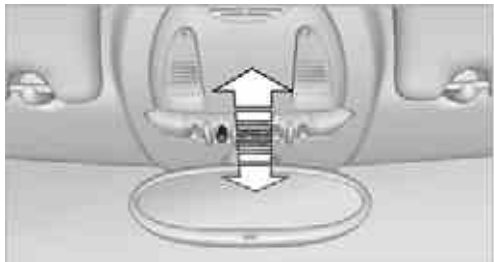

To switch the interior lamps on/off.

Press the switch.

To switch off the interior lamps permanently, press the switch for about 3 seconds.

Reading lamps

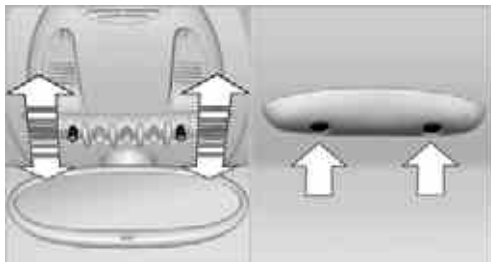

To switch the reading lamps on and off.

In the front: press the switch.

In the rear: press the button.

Ambient lighting

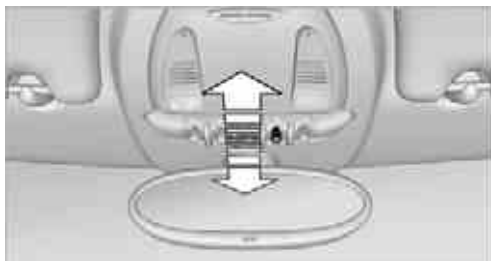

The color and brightness of the ambient lighting can be changed.

- ▷ Press the switch forward.
The color changes in stages.
- ▷ Press the switch toward the rear.
The brightness changes in stages.

Intermediate settings and colors are possible.

 For a continuous color change in the ambient lighting, press and hold the switch forward for longer than 10 seconds. ◀

CLIMATE

VEHICLE EQUIPMENT

In this chapter, all production, country, and optional equipment that is offered in the model range is described. Equipment is also described

that is not available because of, for example, selected options or country version. This also applies to safety related functions and systems.

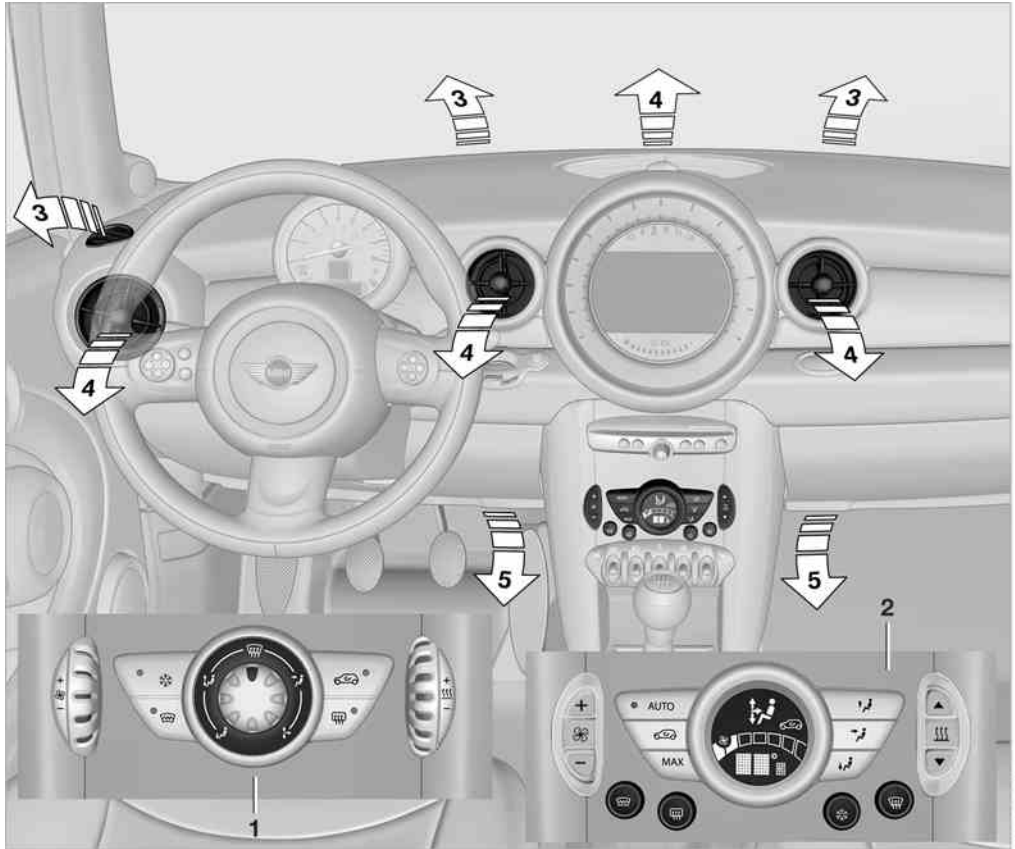

Equipment versions

Depending on your vehicle's equipment, your MINI contains an air conditioner or an automatic climate control.

- 1 Air conditioner
- 2 Automatic climate control

Air vents

- 3 Airflow directed toward the windshield and side windows
- 4 Air to the upper body area, draft-free ventilation
- 5 Air to the footwell

AIR CONDITIONER

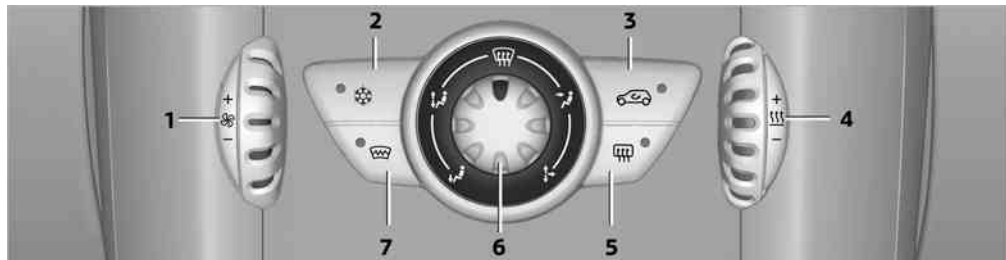

- | | |
|--|--|
| <p>1 Air flow rate</p> <p>2 Cooling function</p> <p>3 Recirculated-air mode</p> <p>4 Temperature</p> | <p>5 Rear window defroster</p> <p>6 Air distribution</p> <p>7 Windshield heating</p> |
|--|--|

Air flow rate



Adjust the air flow rate. The higher the rate, the more effective the heating or cooling will be.

The air flow rate is lowered or switched off entirely to reduce the drain on the battery.

Switching the system on/off

Turn the air flow rate rotary switch to 0. Blower and air conditioner are completely switched off and the air supply is cut off.

Set any desired air flow rate to switch on the air conditioner.

Cooling function

Button	Function
	When the cooling function is on, the air is cooled, dried, then reheated according to the temperature setting. The passenger compartment can only be cooled while the engine is running.
or 	



or



The cooling function helps prevent condensation on the windows or removes it quickly.

Depending on the weather, the windshield may fog over briefly when the engine is started.



To cool the air more quickly and intensely when the external temperature is high, you can switch on the recirculated-air mode. ◀

Recirculated-air mode



If the air outside the car has an unpleasant odor or contains pollutants, shut off the supply to the interior of the car temporarily. The system then recirculates the air currently within the vehicle.



If condensation starts to form on the inside window surfaces, press the AUTO button or switch off the recirculated-air mode and, if necessary, increase the air flow rate. The recirculated-air mode should not be used over an extended period of time; otherwise, the air quality in the passenger compartment will deteriorate continuously. ◀

Temperature



Turn upward, red, to increase the temperature.

Turn downward, blue, to decrease the temperature.

Rear window defroster





The defroster is switched off automatically after a certain time.

The rear window heating is lowered or switched off entirely to reduce the drain on the battery.

Air distribution



Direct the flow of air to the windows , to the upper body area  or to the footwell . Intermediate settings are possible.

Windshield heating



The windshield heating is switched off automatically after a short time.

The front window heating is lowered or switched off entirely to reduce the drain on the battery.

Defrosting windows and removing condensation

1. Set air flow rate to the maximum level.
2. Set air distribution to position . Condensation is removed from the windows more quickly when the cooling function is also activated.
3. Set to the highest temperature, red.
4. Deactivate recirculated-air mode.
5. Turn on windshield heating if necessary.
6. Turn on rear window defroster if necessary.

Microfilter

The microfilter captures dust and pollen. The microfilter is changed by your MINI dealer during routine maintenance work.

AUTOMATIC CLIMATE CONTROL



- | | | | |
|---|--------------------------|----|--|
| 1 | Air flow rate, manual | 6 | Temperature |
| 2 | AUTO program | 7 | Defrosting windows and removing condensation |
| 3 | Recirculated-air mode | 8 | Cooling function |
| 4 | Maximum cooling | 9 | Rear window defroster |
| 5 | Air distribution, manual | 10 | Windshield heating |

Comfortable interior climate

AUTO program **2** offers the ideal air distribution and air flow rate for almost all conditions, refer to AUTO program below. All you need to do is select an interior temperature which is comfortable for you.

The following sections inform you in detail about how to adjust the settings.

Most settings are stored for the remote control currently in use, refer also to Personal Profile settings on page 29.

Air flow rate, manual



Press the – button to reduce air flow. Press the + button to increase it.

You can reactivate the automatic mode for the air flow rate with the AUTO button.

The air flow rate is lowered or switched off entirely to reduce the drain on the battery. The display remains the same.

Switching the system on/off

Reduce the air flow by pressing the – button repeatedly until the system is switched off. All displays go out.

Press the AUTO button to switch the automatic climate control back on.

AUTO program



The AUTO program adjusts the air distribution to the windshield and side windows, toward the upper body area and into the footwell for you. The air flow rate and your temperature specifications will be adapted to outside influences in accordance with seasonal changes, e.g. sunlight.

The cooling function is automatically switched on along with the AUTO program.

The program is switched off if the air distribution is manually adjusted or if the button is pressed again.

Recirculated-air mode



Recirculated-air mode: the supply of outside air is permanently shut off. The system then recirculates the air currently within the vehicle.



If condensation starts to form on the inside window surfaces, press the AUTO button or switch off the recirculated-air mode and, if necessary, increase the air flow rate. The recirculated-air mode should not be used over an extended period of time; otherwise, the air quality in the passenger compartment will deteriorate continuously. ◀

Maximum cooling



You will receive maximally cooled air as quickly as possible when the outside temperature is above 32 °F / 0 °C and while the engine is running.

The automatic climate control goes into recirculated-air mode at the lowest temperature. Air flows at maximum rate from the vents for the upper body area. You should therefore open them for maximum cooling.

Air distribution, manual



The flow of air is directed to the windows, to the upper body area or to the footwell as selected.

You can switch the automatic air distribution back on by pressing the AUTO button.

Temperature



Set the desired temperature individually.

The automatic climate control achieves this temperature as quickly as possible regardless of the season, using maximum cooling or heating power if necessary, and then maintains it.



If you switch between different temperature settings in quick succession, the automatic climate control does not have enough time to achieve the set temperature. ◀

Rear window defroster



The defroster is switched off automatically after a certain time.

Defrosting windows and removing condensation



Quickly removes ice and condensation from the windshield and front side windows.

For this purpose, also switch on the cooling function. The windshield heating is switched on automatically.

Windshield heating



The windshield heating is switched off automatically after a certain time.

Cooling function

Button	Function
	When the cooling function is on, the air is cooled, dried, then reheated according to the temperature setting. The passenger compartment can only be cooled while the engine is running.
or 	

The cooling function helps prevent condensation on the windows or removes it quickly.

Depending on the weather, the windshield may fog over briefly when the engine is started. The recirculated-air mode may be switched on automatically.

When the AUTO button is pressed, the cooling function switches on automatically.

Microfilter/activated-charcoal filter

The microfilter captures dust and pollen. The activated-charcoal filter provides additional protection by filtering gaseous pollutants from the outside air. Your MINI dealer replaces this combined filter as a standard part of your scheduled maintenance.

You can call up further information in the service requirements display, page 63.

VENTILATION

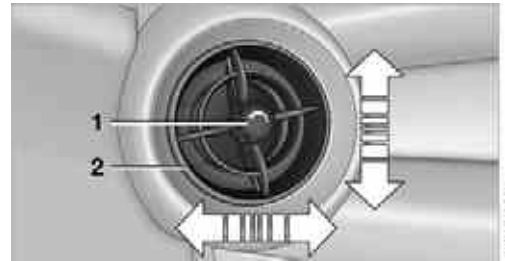

- 1 Knob for continuous opening and closing
- 2 Jet for direction of air flow

Opening/closing

Turn the knob.

Direction of air flow

Swivel the entire jet.

PRACTICAL INTERIOR ACCESSORIES

VEHICLE EQUIPMENT

In this chapter, all production, country, and optional equipment that is offered in the model range is described. Equipment is also described that is not available because of, for example, selected options or country version. This also applies to safety related functions and systems.

INTEGRATED UNIVERSAL REMOTE CONTROL

The concept

By using the integrated universal remote control, up to 3 functions of remote controlled devices, e.g., garage door openers or lighting systems, can be operated. As a result, the universal remote control can replace up to 3 different remote controls. To operate, the buttons on the rearview mirror must be programmed with the desired functions. For programming, the remote control for each device is needed.

 To prevent possible damage or injury, before programming or using the integrated universal remote control, always inspect the immediate area to make certain that no people, animals or objects are within the travel range of the device.

Comply also with the safety instructions supplied with the original hand-held transmitter. ◀

Before selling the vehicle, delete the stored functions as a safety precaution, page 94.

Compatibility

 Depending on your vehicle's equipment, the glove compartment can be ventilated and, if the cooling function is switched on, can also be cooled.

For additional information, please contact your MINI dealer or call: 1-800-355-3515.

A list of compatible remote controls is available on the Internet at www.homelink.com.

HomeLink is a registered trademark of Johnson Controls, Inc.

Operating elements on the rearview mirror



- 1 LED
- 2 Buttons
- 3 The original remote control will be required for the programming.

Programming

General information

1. Switch on ignition.
2. Initial startup:

Press and hold the right and left buttons on the rearview mirror for approx. 20 seconds until the LED on the rearview mirror starts flashing quickly. All the programming for the buttons on the rearview mirror is deleted.
3. Hold the original hand-held transmitter at a distance of approx. 1 in/2.5 cm to 3 in/8 cm from the buttons on the rearview mirror. The required distance depends on the hand-held transmitter.
4. Press both the desired function on the remote and the button to be programmed on the rearview mirror at the same time. The LED flashes slowly at first.

- As soon as the LED flashes rapidly, release both buttons. The quick flashing indicates that the button on the rearview mirror has been programmed.

If the LED does not flash rapidly after approx. 60 seconds, alter the distance between the rearview mirror and hand-held transmitter and repeat this step. Several attempts at different distances may be necessary. Wait at least 15 seconds before each attempt.

Canada: if the programming was interrupted by the hand-held transmitter, press and hold the memory button and press the button on the hand-held transmitter for 2 seconds and release several times.

- To program other functions on other buttons, repeat steps 3 to 5.

You can operate the system with the engine running or with the ignition switched on.

Special features of hopping-code transmitter systems

If the device cannot be operated after being programmed repeatedly, then check if the device to be operated is equipped with a hopping-code system. In addition, check in the operating instructions for the device or press the programmed button on the rearview mirror for a longer period of time. If the LED on the rearview mirror first flashes quickly and then is on for 2 seconds, then the device is equipped with a hopping-code system. The flashing and the LED being on repeats itself for approx. 20 seconds.

In addition, for devices with hopping-code systems, the integrated universal remote control and the device must be synchronized.

Information about synchronizing can be found in the operating instructions for the device to be set.

Programming will be easier with the aid of a second person.

Synchronizing:

- Park your vehicle within the range of the remote-controlled device.
Do not exceed the 164 ft/50 m range of the remote-controlled device.
- Program the particular button on the rearview mirrors as described.
- Find and press the button for synchronizing the device to be set. There remain approx. 30 seconds for the next step.
- Press and hold the programmed button on the rearview mirror for approx. 3 seconds and then release. Repeat this step, possibly up to three times, to complete the synchronization. After the synchronization is completed, the programmed function is implemented.

To reprogram individual buttons

- Switch on ignition.
- Press and hold the button to be programmed on the rearview mirror.
- As soon as the LED on the rearview mirror starts flashing slowly, hold the hand-held transmitter of the device to be operated approx. 1 in/2.5 cm to 3 in/8 cm from the buttons on the rearview mirror. The required distance depends on the hand-held transmitter.
- Press and also hold the button with the desired function on the hand-held transmitter.
- As soon as the LED on the rearview mirror starts blinking faster, release both buttons. The quick flashing indicates that the button on the rearview mirror has been programmed. The device can now be operated using the button on the rearview mirror.
Canada: if the LED is not flashing rapidly after 60 seconds, change the distance and repeat the step or, if the programming was interrupted by the hand-held transmitter, press and hold the memory button and press the button on the hand-held transmitter for 2 seconds and release several times.

Operation

⚠ Before using the integrated universal remote control, always inspect the immediate area to make certain that no people, animals or objects are within the travel range of the device.

Comply also with the safety instructions supplied with the original hand-held transmitter. ◀

The device, for example a garage door, can be operated while the engine is running or when the ignition is on by using the button on the rearview mirror. In addition, while within the reception range of the device, press the button until the function is deleted. The LED on the rearview mirror is constantly on while the signal is being transmitted.

Deleting stored functions

Press and hold the right and left buttons on the rearview mirror for approx. 20 seconds until the LED on the rearview mirror starts flashing quickly. All stored functions are deleted. The functions can not be deleted individually.

Operating principle

By pressing the setting button with a thin, sharp object, e.g., a pen or a similar object, various functions can be called up. The following setting options are displayed one after the other, depending on how long the setting button is pressed down:

- ▷ Quick press: display switches on/off
- ▷ 3 to 6 seconds: compass zone setting
- ▷ 6 to 9 seconds: compass calibration
- ▷ 9 to 12 seconds: left/right-hand drive setting
- ▷ 12 to 15 seconds: setting the language

Setting the compass zones

Set the appropriate compass zone on your vehicle so that the compass operates properly; see world map with compass zones.

DIGITAL COMPASS

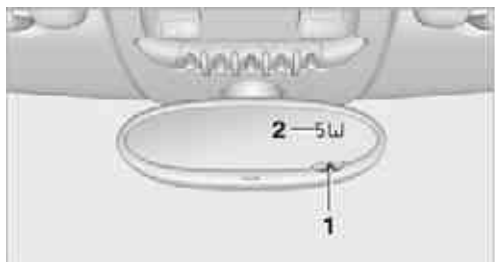

- 1 Setting button on the back of the mirror
- 2 Display

The cardinal or ordinal direction in which the vehicle is moving is shown on the display.

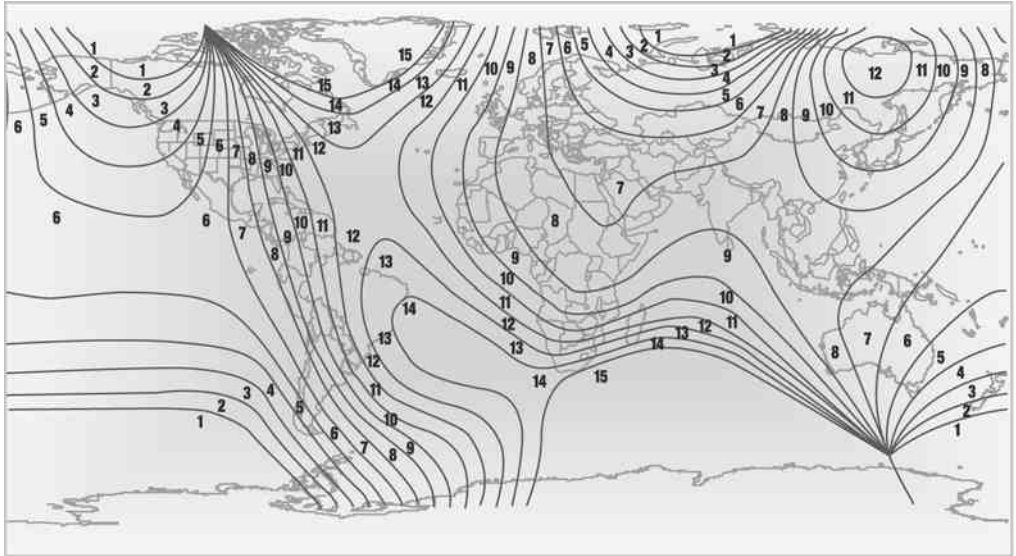

To set the compass zones, press the setting button for approx. 3-4 seconds. The number of the compass zones that have been set are shown on the display.

To change the zone setting, quickly press the setting button as often as necessary until the number of the compass zone for your location is displayed.

The compass is again ready to use after approx. 10 seconds.

Calibrating the digital compass

The digital compass must be calibrated in the following situations:

- ▷ The incorrect cardinal direction is displayed.
- ▷ The direction that is displayed does not change even though the driving direction changes.
- ▷ Not all cardinal directions are displayed.

Procedure

1. Make sure that there are no large metal objects or overhead power lines near your

vehicle, and that you have enough space to drive in circles.

2. Set the compass zone that currently applies.
3. Press the setting button approx. 6-7 seconds to call up C. Then drive in a complete circle at a maximum speed of 4 mph/7 km/h. If the calibration is successful, the C will be replaced by the directions.

Setting right/left-hand drive

Your digital compass is already set to right-hand drive or left-hand drive at the factory, depending upon your vehicle.

Setting the language

You can set the language on the display:

Press the setting button for approx. 12-13 seconds. Briefly press the setting button again to switch between English "E" and German "O".

The setting is automatically stored after approx. 10 seconds.

GLOVE COMPARTMENT

Opening

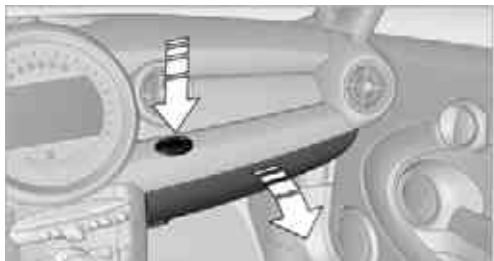

Press the button to open the cover.
The light in the glove compartment comes on.

Closing

Fold cover up.

 To prevent injury in the event of an accident, close the glove compartment after use while the vehicle is being driven. ◀

Ventilation

Depending on your vehicle's equipment, the glove compartment can be ventilated and, if the cooling function is switched on, can also be cooled.



Opening

Rotate the switch in the direction of the arrow.

Closing

Rotate the switch in the opposite direction of the arrow until it is in the vertical position.

Depending on the temperature setting of the air conditioner or the automatic climate control, high temperatures may result in the glove compartment.

USB interface for data transfer

Connection for importing data from a USB storage device, e.g. software update, refer to page 154.

The USB interface is located on the right side of the glove compartment, toward the top.

Observe the following when connecting:

- ▷ Do not forcibly connect the plug to the USB interface.
- ▷ Do not connect devices such as fans or lamps to the USB interface.
- ▷ Do not connect USB hard drives.
- ▷ Do not use the USB interface to recharge external devices.

CONNECTION FOR EXTERNAL AUDIO DEVICE

You can connect an external audio device such as a CD or MP3 player and play audio tracks over the vehicle's speaker system, refer to the Entertainment chapter starting on page 147.

CENTER ARMREST

The center armrest between the front seats contains either a compartment or the cover for the snap-in adapter, see page 168.



Opening

The cover slides along guide rails and can be opened fully by pushing it back and lifting it.

Closing

Push the cover forward.

STORAGE COMPARTMENTS

 Do not put any unsecured objects into the interior of the vehicle; otherwise these may endanger the occupants, e.g., during braking and evasive maneuvers. ◀

 Do not use the instrument panel as a shelf, for example with non-slip mats; otherwise, it could be damaged. ◀

In the vehicle interior

Depending on your vehicle's equipment, you will find storage compartments in the doors, next to the rear seats and in the center console. Nets are located in the passenger footwell and on the backs of the front seat backrests.

Storage compartment on the front passenger side

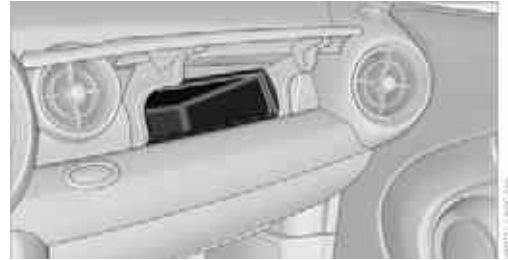

Opening

Briefly press the bottom edge of the cover.

Closing

Push the cover back into its original position.

 To prevent injury in the event of an accident, close the storage compartment after use while the vehicle is being driven. ◀

Clothes hooks

There are clothes hooks on the grab handles in the rear passenger compartment.

 Items of clothing hung from the hooks must not obstruct the driver's view. Do not hang heavy objects from the hooks; otherwise, they could endanger the car's occupants, e.g. in case of heavy braking or sudden swerving. ◀

In the cargo area

Depending on your vehicle's equipment, you have the following storage options:

- ▷ Umbrella holder under the loading sill in front of the warning triangle
- ▷ MINI Clubman: bag hooks for hanging, for example, shopping bags or tote bags left and right on the luggage compartment side wall
- ▷ Storage compartment under the flat load floor
- ▷ Removable box with lid under the flat load floor, e.g., for wet or dirty items

- ▷ Storage compartment in the Split Rear Barn Doors
- ▷ Net on the rear cargo well for smaller objects; for attaching to the lashing eyes

CUPHOLDERS AND ASHTRAY



Cupholders

Two cupholders are located in the front of the center console; another is in the rear at the back of the center console.

 Use lightweight, nonbreakable containers and do not transport hot beverages. Otherwise, there is an increased risk of injury in the event of an accident. ◀

 Do not push unsuitable containers forcibly into the cupholder. Otherwise, you may damage it. ◀

MINI Clubman

There are two additional cupholders in the arm rests in the rear.



Ashtray

The ashtray is located in one of the cupholders in the center console.

Emptying

Remove the entire ashtray.

Lighter



With the engine running or the ignition switched on, press in the cigarette lighter.

The lighter can be pulled out as soon as it pops back out.

 Hold or touch the hot cigarette lighter by the knob only. Holding or touching it in other areas could result in burns.

When leaving the car, always remove the key so that children cannot operate the cigarette lighter and burn themselves. ◀

CONNECTING ELECTRICAL APPLIANCES

In your MINI, when the engine is running or if the ignition is switched on, you can use electrical devices such as flashlights, car vacuum cleaners, etc., up to approx. 140 watts at 12 volts, as long as one of the following sockets is available. Avoid damaging the sockets by attempting to insert plugs of unsuitable shape or size.

 Do not connect battery chargers to the sockets installed in the vehicle at the factory; otherwise you may cause damage to the vehicle. ◀

Cigarette lighter socket

Remove the lighter or cover from the socket.

Power socket in cargo area



By way of example, the illustration shows the cargo area in the MINI.

Pull out the cover.



DRIVE ME.

AT A GLANCE

CONTROLS

DRIVING TIPS

NAVIGATION

ENTERTAINMENT

COMMUNICATIONS

MOBILITY

REFERENCE

THINGS TO REMEMBER WHEN DRIVING

VEHICLE EQUIPMENT

In this chapter, all production, country, and optional equipment that is offered in the model range is described. Equipment is also described that is not available because of, for example, selected options or country version. This also applies to safety related functions and systems.

BREAK-IN PERIOD

Moving parts need breaking-in time to adjust to each other. Please follow the instructions below in order to achieve the optimal service life and economy of operation for your vehicle.

Engine and differential

Always obey all official speed limits.

Up to 1,200 miles/2,000 km

Drive at varying engine and road speeds, but do not exceed the following:

- ▷ Gasoline engine
4,500 rpm or 100 mph/160 km/h

Avoid full-throttle operation and use of the transmission's kickdown mode.

After driving 1,200 miles/2,000 km

Engine and vehicle speeds can be gradually increased.

Tires

Due to technical factors associated with their manufacture, tires do not achieve their full traction potential until after an initial break-in period. Therefore, drive cautiously during the first 200 miles/300 km.

Brake system

Brakes require an initial break-in period of approx. 300 miles/500 km to achieve optimized contact and wear patterns between brake pads and rotors. Drive cautiously during this break-in period.

Clutch

The function of the clutch reaches its optimal level only after a distance driven of approx. 300 miles/500 km. During this break-in period, engage the clutch gently.

Following part replacement

The same break-in procedures should be observed if any of the components mentioned above have to be renewed in the course of the vehicle's operating life.

GENERAL DRIVING NOTES

Close tailgate/Split Rear Barn Doors



Only drive with the tailgate/Split Rear Barn Doors closed. Failure to do so may endanger passengers or other road users or may damage the vehicle in the event of an accident or a braking and evasive maneuver. In addition, exhaust gas may flow into the passenger compartment. ◀

If special circumstances make it absolutely necessary to drive with the tailgate/Split Rear Barn Doors open:

1. Close all windows and the glass sunroof.
2. Switch off the recirculated-air mode and switch the airflow control of the heating, air conditioner, or automatic climate control to high, refer to page 88 or 90.

Hot exhaust system

 As in all vehicles, extremely high temperatures are generated on the exhaust system. Do not remove the heat shields installed adjacent to various sections of the exhaust system, and never apply undercoating to them. Make sure that when driving, idling or when parking, no easily flammable materials, such as hay, leaves, grass, etc. come into contact with the hot exhaust system. Such contact could lead to a fire, with the risk of serious personal injuries and property damage. Do not touch hot exhaust tail pipes. Otherwise, there is a risk of burns. ◀

Hydroplaning

 When driving on wet or slushy roads, reduce road speed. If you do not, a wedge of water can form between tires and road surface. This situation, known as hydroplaning, can cause partial or complete loss of tire contact with the road surface, so that the car cannot be steered or braked properly. ◀

The risk of hydroplaning increases with declining tread depth on the tires, refer also to Tread depth on page 206.

Driving through water

 Drive through water on the road only if it is not deeper than 1 ft/30 cm, and then only at walking speed at the most. Otherwise, the vehicle's engine, the electrical systems and the transmission may be damaged. ◀

Parking brake on inclines

 On inclines, do not hold the vehicle with the clutch; use the parking brake. Otherwise, greater clutch wear will result. ◀

For information on driving off using Hill Assist, refer to page 73.

Braking safely

Your MINI is equipped with ABS. If you are in a situation which requires full braking, it is best to brake using maximum brake pressure. Since the vehicle maintains steering responsiveness, you

can still avoid possible obstacles with a minimum of steering effort.

The pulsation of the brake pedal, together with the sound of hydraulic regulation, indicates that ABS is functioning properly.

Objects in the movement range of the pedals

 Keep floor mats, carpet, and other objects out of the movement range of the pedals; otherwise, they may inhibit the function of the pedals during driving. Do not place additional floor mats onto an existing one or onto other objects. Only use floor mats that have been approved for the vehicle and can be appropriately fastened. Make sure that the floor mats are securely fastened again after they have been removed, e.g. for cleaning. ◀

Driving in wet conditions

When roads are wet or there is heavy rain, briefly exert gentle pressure on the brake pedal every few miles. Monitor traffic conditions to ensure that this maneuver does not endanger other road users. The heat generated in this process helps dry the pads and rotors to ensure that. Then full braking force will be immediately available when it is needed.

Hills

 To prevent overheating and the resulting reduced efficiency of the brake system, drive long or steep downhill gradients in the gear in which the least braking is required. Even light but consistent brake pressure can lead to high temperatures, brake wear and possibly even brake failure. ◀

You can increase the engine's braking effect by shifting down, all the way to first gear if necessary. This strategy helps you avoid placing excessive loads on the brake system. Downshifting in manual mode of the automatic transmission, page 53.

 Never drive with the clutch held down, with the transmission in neutral or with the engine switched off; otherwise, engine braking action will not be present or there will be no power assistance to the brakes or steering. Never allow floor mats, carpets or any other objects to protrude into the area around the pedals; otherwise, pedal function could be impaired. ◀

Corrosion on brake rotors

When the vehicle is driven only occasionally, during extended periods when the vehicle is not used at all, and in operating conditions where brake applications are less frequent, there is an increased tendency for corrosion to form on rotors, while contaminants accumulate on the brake pads. This occurs because the minimum pressure which must be exerted by the pads during brake applications to clean the rotors is not reached.

Should corrosion form on the brake rotors, the brakes will tend to respond with a pulsating effect that even extended application will fail to cure.

When the vehicle is parked

Condensation forms while the automatic climate control is in operation, and then exits under the vehicle. Traces of condensed water under the vehicle are therefore normal.

In the MINI Cooper S, the coolant pump may continue to run for some time after the engine is switched off. This will generate noise in the engine compartment.

CARGO LOADING

 To avoid loading the tires beyond their approved carrying capacity, never overload the vehicle. Overloading can lead to overheating and increases the rate at which damage develops inside the tires. The ultimate result can assume the form of a sudden blowout. ◀

 Avoid fluid spills in the cargo area as they could damage the vehicle. ◀

MINI: cargo area cover

 Do not place any objects on the cover; otherwise, they could endanger the car's occupants, e.g. in the case of braking or sudden swerving, or they may damage the cover. ◀

When you open the tailgate, the roll-up cover is raised.

To load bulky luggage, the cover can be removed.

1. Unhook the lift straps from the tailgate.
2. Pull the cover out of the holders toward the rear.

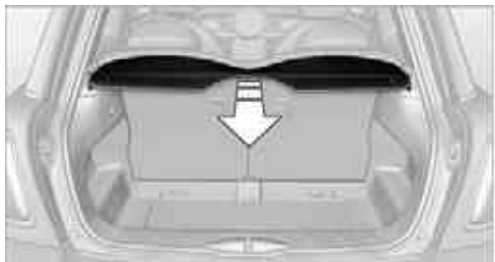

MINI Clubman: luggage compartment roller cover

 Do not place heavy or hard objects on the luggage compartment roller cover. If you do so, they may already pose a danger to vehicle occupants during braking or evasive maneuvers. Do not allow the luggage compartment roll-up cover to snap back, otherwise it can be damaged. ◀

The roll-up cover can be locked in place at the intermediate positions **1** to **3**.

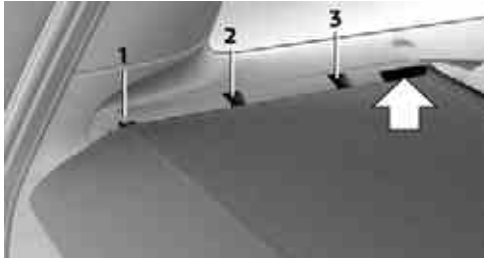

The roll-up cover can be removed to load bulky luggage.

Removing

1. Pull on the handle to roll the cover up.
2. Pivot the roll-up cover upward at both ends, arrow **1** and move it up out of the holders, arrow **2**.

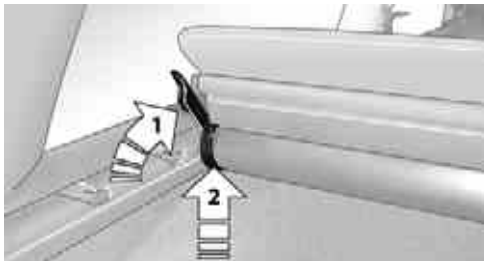

Installing

1. Insert the left and right ends of the roll-up cover into the mounts.
2. Push down until the roll-up cover is resting on the holders.

Expanding cargo area

The rear set backrest is split. Both sides can be folded separately to expand the cargo area.

If necessary, remove the third head restraint, refer to Head restraints, Removing page 42.

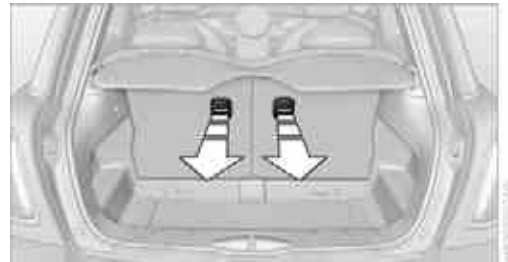

By way of example, the illustration shows the cargo area in the MINI.

1. Pull the lever.
2. Fold rear seat backrests forward.

! When folding the backrest back up, make sure that the seat's locking mechanisms engage properly. Otherwise, cargo could be thrown around in the event of sharp braking or swerving and endanger the occupants. ◀

Adjusting rear seat backrest

Expand the cargo area by raising the rear seat backrests to a steeper angle.



By way of example, the illustration shows the cargo area in the MINI.

1. Pull the lever, arrow **1**, and fold the rear seat backrest forward.
2. Fold up the lever of the backrest lock until it audibly engages, arrow **2**.
3. Fold back the backrest until it engages.

! If the rear seat backrests are positioned at a steeper angle, do not install child restraint systems in the rear of the vehicle as their protective features may be ineffective. ◀

MINI Clubman: cargo net

 Ensure that the cargo net is firmly attached; otherwise, injuries may occur. ◀

The cargo net can be mounted in the cargo area or behind the front seats.

In the cargo area

1. Fold the rear seat backrest forward if necessary, page 105.



2. Insert each cargo net mounting pin all the way into its respective rear mount in the headliner, arrow 1, and push it forward.
3. Hang the hooks of the cargo net into the eyelets on the rear cargo well, arrow 2.

Behind the front seats



1. Fold down the rear seat backrests, refer to Expanding cargo area.
2. Insert each cargo net mounting pin all the way into its respective front mount in the headliner, arrow 1, and push it forward.
3. Fold up the eyelets on the rear seat and hook the cargo net into them, arrow 2.

MINI Clubman: flat load floor

 The maximum load for the flat load floor is 165 lbs/75 kg. Do not exceed a maximum permissible load of 55 lbs/25 kg for the storage compartment beneath the flat load floor; otherwise, damage can occur. ◀



Raise the flat load floor and fold it up toward the front, arrow.

Removing

1. Fold up the flat load floor.
2. Pull the load floor back slightly.
3. Then take it out toward the top.

Determining cargo limit



1. Locate the following statement on your vehicle's placard:

 The combined weight of occupants and cargo should never exceed XXX kg or YYY lbs. Otherwise, this could damage the vehicle and produce unstable vehicle operating conditions. ◀
2. Determine the combined weight of the driver and passengers that will be riding in your vehicle.

3. Subtract the combined weight of the driver and passengers from XXX pounds or YYY kilograms.
4. The resulting figure equals the available amount of cargo and luggage load capacity. For example, if the XXX amount equals 1,400 lbs and there will be four 150 lb-passengers in your vehicle, the amount of available cargo and luggage load capacity is 650 lbs:
1,400 lbs minus 750 lbs = 650 lbs.
5. Determine the combined weight of luggage and cargo being loaded on the vehicle. That weight may not safely exceed the available cargo and luggage load capacity calculated in step 4.
6. If your vehicle will be towing a trailer, part of the load from your trailer will be transferred to your vehicle. Consult the manual for transporting a trailer to determine how this may reduce the available cargo and luggage load capacity of your vehicle.

- ▷ For very heavy cargo when the rear seat is not occupied, secure each safety belt in the respective opposite buckle.
- ▷ Do not stack higher than the top edge of the backrests.
- ▷ Use the cargo net, refer to page 106. Ensure that no objects can penetrate through the net.

Load

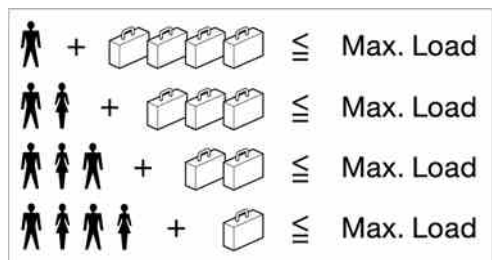

The permissible load is the sum of the occupants' weights and the weight of the cargo. The greater the weight of the occupants, the less cargo/luggage can be transported.

Stowing cargo

- ▷ Position heavy objects as low and as far forward as possible, ideally directly behind the rear seat backrests.
- ▷ Cover sharp edges and corners.

MINI

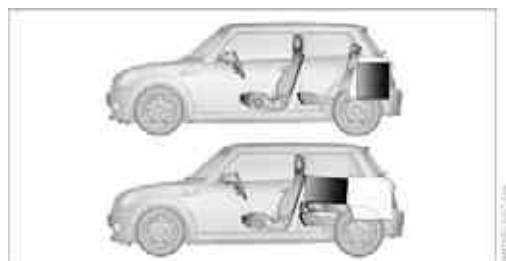

MINI Clubman

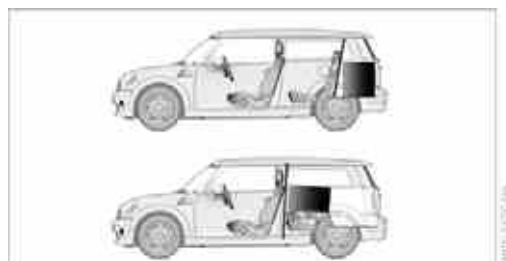

Securing cargo



By way of example, the illustration shows the cargo area in the MINI.

- ▷ Secure smaller and lighter items using retaining or draw straps.

- ▶ Heavy-duty cargo straps for securing larger and heavier objects are available at your MINI dealer. Four lashing eyes are provided for attaching the cargo straps. Two of them are located on the forward wall of the cargo area.

Comply with the information enclosed with the load-securing devices.

 Always position and secure the cargo as described above, so that it cannot endanger the car's occupants, for example if sudden braking or swerves are necessary.

Do not exceed the approved gross vehicle weight and axle loads, page 245; otherwise, the operating safety of the vehicle is no longer assured and the vehicle will not be in compliance with the construction and use regulations. Heavy or hard objects should not be carried loose inside the car, since they could be thrown around, for example as a result of heavy braking, sudden swerves, etc., and endanger the occupants. Do not secure cargo using the fastening points for the tether strap, page 47; they may become damaged. ◀

ROOF-MOUNTED LUGGAGE RACK

A special rack system is available as an option for your MINI. Your MINI dealer will be glad to advise you. Comply with the installation instructions supplied with the rack system.

Mounting points

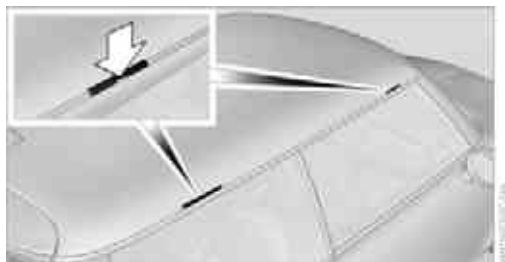

By way of example, the illustration shows the roof of the MINI.

Take out the cover panel.

Loading roof-mounted luggage rack

Because roof racks raise the vehicle's center of gravity when loaded, they have a major effect on vehicle handling and steering response.

You should therefore always remember not to exceed the approved roof load capacity, the approved gross vehicle weight or the axle loads when loading the rack.

You can find the applicable specifications under Weights on page 245.

The roof load must be distributed uniformly and should not be too large in area. Heavy items should always be placed at the bottom.

When loading, make sure that there is sufficient space for the movement of the glass roof and that no objects protrude into the swiveling area of the tailgate; otherwise, damage can occur.

Fasten roof-mounted cargo correctly and securely to prevent it from shifting or falling off during the trip.

Drive smoothly. Avoid sudden acceleration and braking maneuvers, and take corners gently.

SAVING FUEL

Your vehicle incorporates numerous technologies for reducing fuel consumption and emissions.

Fuel consumption depends on a number of different factors. Fuel consumption and environmental pollution are affected by various actions, the manner of driving and regular maintenance.

Remove unnecessary cargo

Additional weight increases fuel consumption.

Remove attached parts no longer in use

Remove auxiliary mirrors, roof- or rear-mounted luggage racks whenever you are not using them.

Attached parts on the vehicle affect its aerodynamics and increase fuel consumption.

Closing windows

Open windows increase air resistance and therefore fuel consumption.

Check tire inflation pressure regularly

Check and, if necessary, correct tire inflation pressure at least twice a month and before starting on a long trip.

Low inflation pressure increases rolling resistance and thus leads to greater fuel consumption and tire wear.

Drive off immediately

Do not wait for the engine to warm up while the vehicle remains stationary. Start driving right away, but at moderate engine speeds. This is the fastest way for the cold engine to reach its operating temperature.

Think ahead while driving

Avoid unnecessary acceleration and braking, by maintaining a suitable distance to the vehicle driving ahead.

Looking-ahead and smooth driving reduces fuel consumption.

Avoid high engine speeds

Use first gear only for driving off. In second and higher gears, accelerate smoothly to a suitable engine and road speed. In doing so, avoid high engine speeds and shift up early.

When you reach your desired traveling speed, shift to the highest suitable gear and drive at constant speed.

As a rule: driving at low engine speeds lowers fuel consumption and reduces wear.

Coasting

When approaching a red traffic light, take your foot off the accelerator and let the car roll to a stop in the highest gear possible.

On a downhill gradient, take your foot off the accelerator and let the vehicle coast in a suitable gear.

Fuel supply is shut off automatically when the vehicle is coasting.

Switch off the engine during lengthy stops

Switch off the engine when stopping for lengthy periods, e.g. at traffic lights, railroad crossings or in traffic jams.

Switch off any features that are not currently required

Features such as air conditioning, seat heaters and the rear window defroster require a great deal of energy and result in greater fuel consumption, especially in city driving and during Stop & Go operation. For this reason, switch off these features if they are not really needed.

Have the vehicle serviced

Have your vehicle serviced regularly to achieve good economy and a long vehicle life. The manufacturer of your MINI recommends having the vehicle serviced by a MINI dealer. Also note the MINI Maintenance System, page 213.

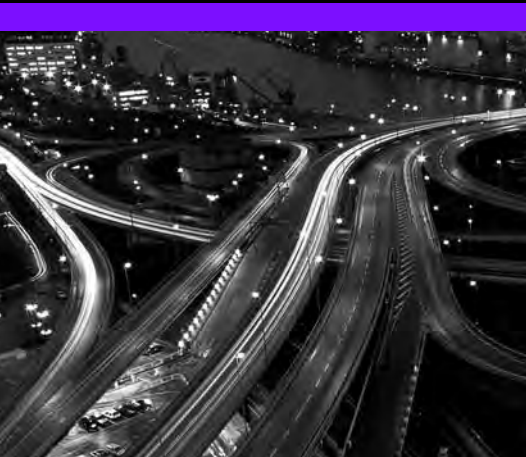

FOLLOW ME.

AT A GLANCE

CONTROLS

DRIVING TIPS

NAVIGATION

ENTERTAINMENT

COMMUNICATIONS

MOBILITY

REFERENCE

NAVIGATION SYSTEM

VEHICLE EQUIPMENT

In this chapter, all production, country, and optional equipment that is offered in the model range is described. Equipment is also described that is not available because of, for example, selected options or country version. This also applies to safety related functions and systems.

GENERAL INFORMATION

The navigation system can determine the precise position of the vehicle, with the aid of satellites and vehicle sensors, and can reliably guide you to every entered destination.

 Enter data only with the vehicle stationary, and always give priority to the applicable traffic regulations in the event of any contradiction between traffic and road conditions and the instructions issued by the navigation system. Failure to take to this precaution can place you in violation of the law and put vehicle occupants and other road users in danger. ◀

Selecting navigation

1. "Navigation"



During route guidance, an arrow view or a map view is displayed on the onboard computer.

NAVIGATION DATA

Information on navigation data

1. "Navigation"
2. Open "Options".
3. "Navigation system version"

Information about the data version is displayed.

Updating the navigation data

General information

Navigation data are stored in the vehicle and can be updated.

You may obtain current navigation data and the enabling code at your MINI dealer.

Updating the data can take several hours, depending on the volume of data.

- ▷ Update data while driving to reduce the drain on the battery.
- ▷ The update is resumed automatically when a trip is continued after an interruption.
- ▷ Only the main functions of the navigation system are available during updating.
- ▷ You can inquire as to the status of the update.
- ▷ The data are stored in the vehicle.
- ▷ After the updating process is complete, the system restarts.
- ▷ The medium with the navigation data can be removed after the update.

To update

1. Insert USB storage device with navigation data
 - ▷ into the USB interface in the glove compartment
 - ▷ into the USB audio interface.
2. Follow the instructions on the onboard computer.
3. Enter the activation code of the USB storage device.
4. Begin driving.

After you begin to drive, the system restarts and updates the navigation data as you drive.

DESTINATION ENTRY

GENERAL INFORMATION

In entering your destination you can select from among the following options:

- ▷ Manual destination entry, see below
- ▷ Selecting destination from address book, page 116
- ▷ Last destinations, page 117
- ▷ Special destinations, refer to page 118
- ▷ Entering the destination via map, refer to page 119
- ▷ Selecting home address, refer to page 117
- ▷ Entering destination via voice, page 120

After selecting your destination you can proceed to start the route guidance, page 123.

MANUAL DESTINATION ENTRY

To make it easier to enter town/city names and street names, you are supported with the word-match principle, refer to page 121. This makes it possible to enter different spellings and completes your entry automatically so that stored town/city names and street names can be accessed quickly.

1. "Navigation"
2. "Enter address"

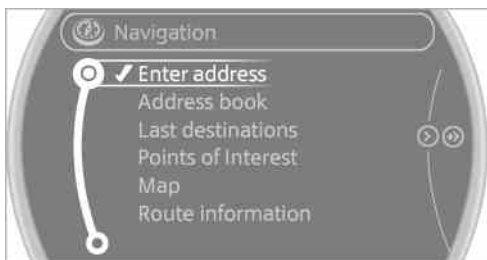

The system also supports you with the following features:

- ▷ If you do not enter a street, the system will guide you to the downtown area of a town or city.
- ▷ You can skip the entry of country and town/city if the current entries should be retained for your new destination.

Entering a state/province

1. "Navigation"
2. "Enter address"
3. Select "State/Province" or displayed country.

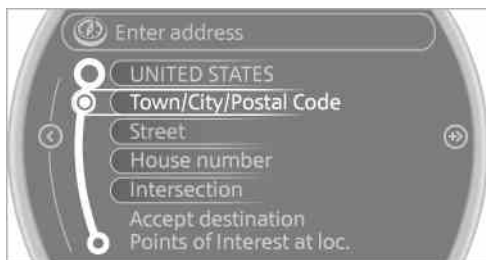

Entering a town/city

1. Select "Town/City/Postal Code" or displayed city.



2. Select letters, if necessary.
A list of all towns/cities starting with this letter appears on the Control Display.

To delete letters:

- ▷ To delete individual numbers or letters:
Turn the MINI joystick to highlight  and press the MINI joystick.
 - ▷ To delete all numbers or letters:
Turn the MINI joystick to highlight  and press and hold the MINI joystick.
3. If necessary, enter more letters.
The list gradually grows smaller each time you enter a new letter.

To enter spaces, if necessary:
Select the  symbol.

- If necessary, move the MINI joystick to the right and change to the list of towns and cities and select a name.



Entering the postal code

- Select "Town/City/Postal Code" or displayed city.
- Select the 1@+ symbol.
- Select the digits individually.
- Change to the list of postal codes and towns/cities.
- Highlight the postal code.
- Select the zip code.
The corresponding destination is displayed.

Entering street and intersection

- Select "Street" or displayed street.
- Enter the street and intersection the same way you entered the town/city.

If there are several streets with the same name:

- Move the MINI joystick to the right to change to the list of street names.
- Highlight street.
- Select the street.

Alternative: entering street and house number

- Select "Street" or displayed street.
- Enter the street the same way you entered the town/city.
- "House number"
- Select the digits.

- Change to the list of house numbers.
- Select a house number or range of house numbers.

Entering a street without a destination town/city

It is also possible to enter a street without entering a destination town/city. In this case all streets of the entered country are offered for selection. The related town/city is displayed after the street name.

If a town/city has already been entered, this entry can be canceled. This may be practical if the desired street does not exist in the entered destination, because, for example, it belongs to another part of the town/city.

- "Navigation"
- "Enter address"
- Select "Street" or displayed street.
- Change to the list of street names.
- Select "In" with the currently displayed country.

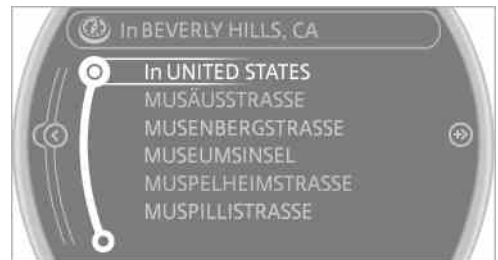

- Select the letters.
- Change to the list of street names.
- Highlight street.
- Select the street.

Starting route guidance after entering the destination

- "Accept destination"
- "Start guidance" or "Add as another destination".

- ▷ Setting "Route preference", refer to page 123.
- ▷ Search for "Points of Interest at loc.", refer to page 118.

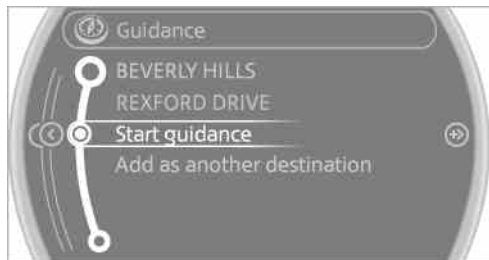

ADDRESS BOOK

To create contacts, refer to page 165 or page 182.

Selecting a destination from the address book

1. "Navigation"
2. "Address book"
Contacts with addresses are displayed if these addresses have been checked as destinations.

If the contacts with addresses from the mobile phone are not displayed, they must first be checked as destinations, refer to page 166 or page 183.

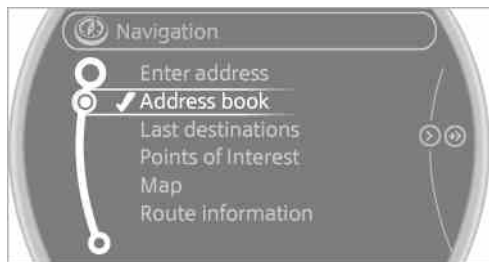

3. Select a contact in the list or if so desired, using the "A-Z search".
4. If necessary, select "Business address" or "Home address".

Storing a destination in the address book

Store the destination in the address book after entering the destination.

1. "Navigation"
2. "Map"
3. "Guidance"
4. Open "Options".
5. "Store as new contact" or "Add to existing contact".

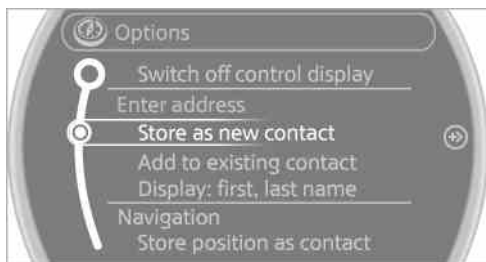

6. Select an existing contact, if available.
7. Select "Business address" or "Home address".
8. Enter "Last name" and "First name" if you wish.
9. "Store in vehicle"

Storing the position

Your current position can be stored in the address book.

1. "Navigation"
2. Open "Options".
3. "Store position as contact" or "Add position to contact".

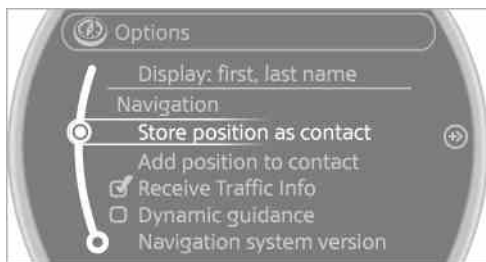

- Depending on the selection, select an existing contact from the list or the type of address and enter the last and first name.
- "Store in vehicle"

Editing or deleting an address

- "Navigation"
- "Address book"
- Highlight the entry.
- Open "Options".
- "Edit in Contacts" or "Delete entry".

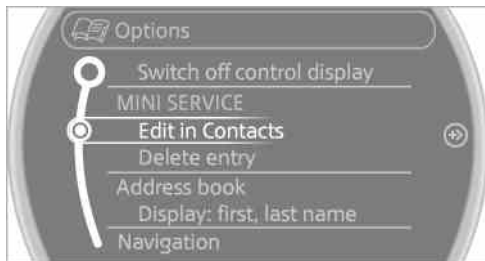

Using home address as destination

The home address must be stored as a destination. Refer to Defining a home address, page 166 or page 183.

- "Navigation"
- "Address book"
- "Home"

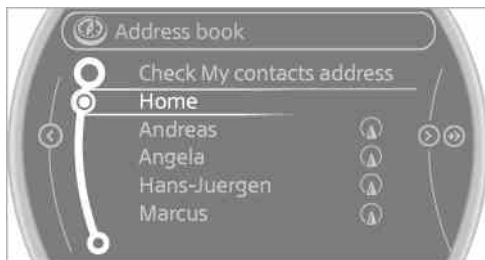

- "Start guidance"

LAST DESTINATIONS

The last destinations are stored automatically. These destinations can be called up and used as a destination for route guidance.

Accessing last destinations

- "Navigation"
- "Last destinations"

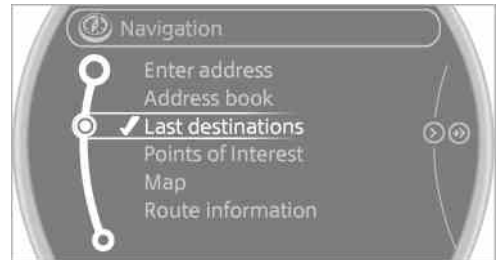

- Select the destination.
- "Start guidance"

Editing a destination

Destinations can be edited, for example, to change the house number of an existing entry.

- "Navigation"
- "Last destinations"
- Highlight the destination.
- Open "Options".
- "Edit destination"

Deleting the last destinations

- "Navigation"
- "Last destinations"
- Highlight the destination.
- Open "Options".
- "Delete entry" or "Delete all last destinations".

SPECIAL DESTINATIONS

You can search for a special destination, e.g. a hotel or place of interest, and start route guidance to the corresponding location.

 The scope of information provided depends on the particular set of navigation data you are using. ◀

Accessing search for special destinations

1. "Navigation"
2. Select "Points of Interest" search.

A-Z search

1. "A-Z search"
2. "Town/City"
3. "Category"
4. "Category details"

For some special destinations, it is possible to select several category details. Move the MINI joystick to the left to exit category details.

5. "Keyword"
6. Enter keyword.
A list of the special destinations is displayed.
7. Select the special destination.
8. Select the  symbol.
9. "Start guidance" or "Add as another destination".

If several details are stored, then you can scroll through the pages.

If a phone number is available, a connection can be established, if desired.

Category search

1. "Category search"
2. "Search destination"
3. Select or enter town/city.
4. "Category"

5. Select category.
6. "Category details"
For some special destinations, it is possible to select several category details. Move the MINI joystick to the left to exit category details.
7. "Start search"
A list of the special destinations is displayed.
8. Select the special destination.
Details are displayed.
9. Select the  symbol.
10. "Start guidance" or "Add as another destination".

If several details are stored, then you can scroll through the pages. If a phone number is available, a connection can be established, if desired.

Special destination location

As you input the search destination, you can select from among various options.

- ▷ "At current location"
- ▷ "At destination"
- ▷ "At different location"
- ▷ With active route guidance: "Along route"

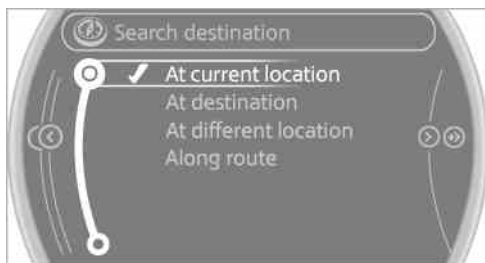

Starting the search for special destinations

1. "Start search"
2. A list of the special destinations is displayed.
 - ▷ "At current location"
The special destinations are displayed in order of their distance and are displayed with a direction arrow pointing toward the destination.

- ▷ "At destination", "At different location", "Along route"

The special destinations are displayed in order of their distance from the search point.

- ▷ Destinations of the selected category are displayed in the map display as symbols. The display depends on the map scale and the category.

3. Highlight special destination.
4. Select the special destination.
5. Select the  symbol.
6. "Start guidance" or "Add as another destination".

The distance from the destination is displayed.

Displaying special destinations in the map

To display symbols of the special destinations in the map:

1. "Navigation"
2. "Map"
3. Open "Options".
4. "Display Points of Interest"

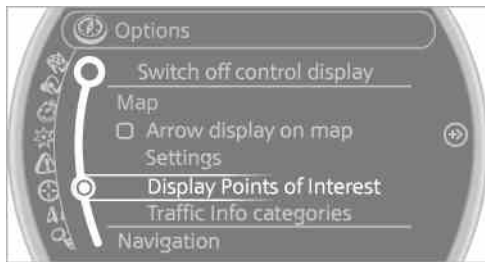

5. Select the settings.

ENTERING THE DESTINATION VIA MAP

If you only know the location of a destination or street, then you can enter the destination with the aid of the map.

Selecting the destination

1. "Navigation"
2. "Map"

The map shows the current position of the vehicle.

3.  "Interactive map"

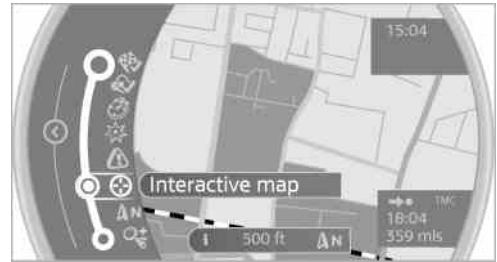

4. Select the destination with the cross-hairs.
 - ▷ Changing scale: turn the MINI joystick.
 - ▷ Moving map: move the MINI joystick in the corresponding direction.
 - ▷ Shifting map diagonally: move the MINI joystick in the corresponding direction and turn the MINI joystick.
5. Press the MINI joystick to display additional menu items.
 - ▷ Select the  symbol: "Start guidance" or "Add as another destination".
 - ▷ "Find points of interest": the search for special destinations is started.

Specifying the street

If the system does not detect any street, then a street name in the vicinity or the coordinates of the destination are displayed.

Additional functions

In the interactive map, the scale can be adjusted and the visible map section can be shifted. You can also access other functions by pressing the MINI joystick:





- ▶ Select the  symbol and "Start guidance" if necessary.
- ▶ "Exit interactive map"
- ▶ Map display
- ▶ "Display destination"
The section of the map around the destination is displayed.
- ▶ "Display current location"
The section of the map around the current position is displayed.
- ▶ "Find points of interest", refer to page 118.

- ▶ Spell the entry if the language of the area is different from the system language.
- ▶ Speak the letters smoothly and avoid excessive emphasis and pauses.

Entering a town/city

The town/city can be spelled or entered as an entire word.

 The methods of entry depend on the navigation data in use and the country and language settings. ◀

-  1. ›City‹ or ›Spell city‹.
2. Wait for the system prompt for the town/city.
3. Say the name of the town/city or if necessary, spell at least the first three letters.

-  4. Select city/town:
 - ▶ To select a recommended town/city: ›Yes‹
 - ▶ Select other city/town: ›New entry‹
 - ▶ To select an entry, e.g. ›Entry ...‹
 - ▶ Spell the entry: ›Spell city‹

ENTERING DESTINATION VIA VOICE

General information

- ▶ Voice activation system, refer to page 22.
- ▶ When entering a destination by voice, it is possible to switch between voice input and the onboard computer.
- ▶ Having the possible spoken commands read aloud: ›Voice commands‹

Saying the entries

- ▶ Countries, towns/cities, streets, and inter-sections can be either spoken aloud as an entire words or spelled in the system language, refer to page 68.
Example: to enter a destination in a US state as a complete word, the system language must be English.

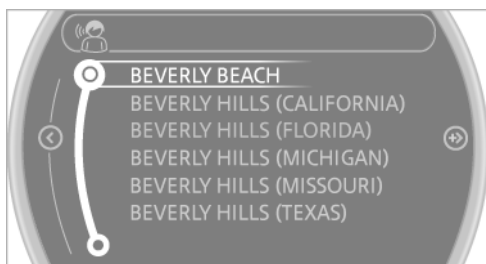

 Similar-sounding towns/cities that cannot be differentiated by the system are compiled in a separate list and displayed as a town/city followed by three dots.
If necessary, select this entry with ›Yes‹. Then select the desired city/town in this list. ◀

The town/city can also be selected from the list via the onboard computer:
Turn the MINI joystick until the destination is selected, and press the MINI joystick.

Entering a street or intersection

The street or intersection is entered in the same way as the town/city.

Entering house number

Depending on the data in the navigation system, house numbers up to the number 2,000 can be entered:

1. ›House number‹
2. Say the house number.
3. ›Yes‹ to confirm the house number.
4. ›Accept destination‹

Starting route guidance

- ›Start guidance‹

Route guidance starts immediately.

Adding further intermediate destinations

- ›Add as another destination‹

Further intermediate destinations can be added.

Saving destination

The destination is automatically added to the list of the last destinations.

PLANNING A TRIP WITH INTERMEDIATE DESTINATIONS

New trip

Various intermediate destinations can be entered for a trip. The trip destination must be entered first, refer to Destination input, page 114.

Entering intermediate destinations

A maximum of 30 intermediate destinations can be entered for one trip.

1. "Navigation"
2. Select the type of destination entry and enter the intermediate destination.

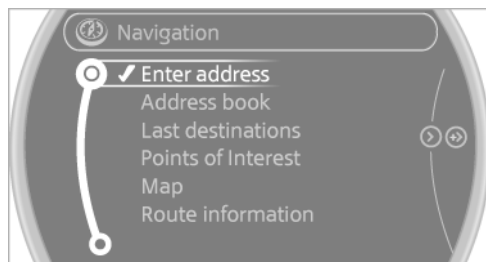

3. "Add as another destination"

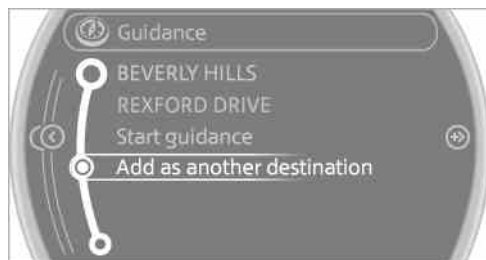

4. Select the location where the intermediate destination is to be inserted.

Starting the trip

After entering all intermediate destinations: "Start guidance"

WORD-MATCHING PRINCIPLE

The system's word-matching principle makes it easier to enter the names of towns or streets. The system runs ongoing checks, comparing your destination entries with the data stored in the vehicle as the basis for instant response. The user benefits include:

- ▷ Town/city names can also be entered differently from the official names if you use a form that is customary in other countries.

Example:

Instead of "München", you can also enter the English spelling "Munich" or the Italian spelling "Monaco".

- ▷ When you are entering the names of towns/cities and streets the system will complete them automatically as soon as enough letters are available to ensure unambiguous identification.
- ▷ The system offers only those letters for selection of name entries that are stored in the vehicle. The system will not accept non-existent names and addresses.

ROUTE GUIDANCE

STARTING ROUTE GUIDANCE

1. "Navigation"
 2. "Enter address"
 3. Select the destination.
 4. "Accept destination"
 5. "Start guidance"
- ▷ The route is displayed on the onboard computer.
 - ▷ The distance to the destination/intermediate destination and the estimated time of arrival are displayed in the map view.
 - ▷ The arrow display is displayed on the onboard computer, if so desired.

TERMINATING ROUTE GUIDANCE

In the arrow or map view

1. "Navigation"
2. "Map"
3. Select the  symbol.
4. "Stop guidance"

CONTINUING ROUTE GUIDANCE

If the destination was not reached during the last trip, route guidance can be resumed.

"Resume guidance"







ROUTE CRITERIA

General information

- ▷ You can influence the calculated route by selecting certain criteria.

- ▷ Route criteria can be changed during destination input and during route guidance.
- ▷ Street types are part of the navigation data and are taken into account in route planning, e.g. avoiding highways.
- ▷ The proposed route can differ from personal experience.
- ▷ The settings are stored for the remote control currently in use.
- ▷ Route guidance with traffic information, refer to page 129.

Changing route criteria

1. "Navigation"
2. "Map"
3.    "Route preference"
4. Selecting a criterion:
 - ▷  "Fast route": time-optimized route through a combination of the least possible distance and stretches of road that allow rapid driving.
 - ▷  "Efficient route": optimized combination of the fastest and shortest possible route.
 - ▷  "Short route": short distance without taking time into account.
 - ▷ "Alternative routes": suggestions of additional alternate routes during route guidance.

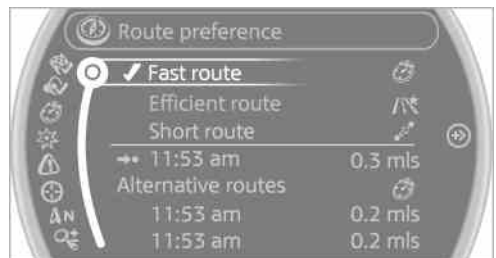

- Select additional route criteria, if desired. Where possible, the selected criteria will be avoided on the route.
 - ▷ "Avoid highways": avoid highways where possible.
 - ▷ "Avoid toll roads": avoid toll roads where possible.
 - ▷ "Avoid ferries": avoid ferries where possible.

The setting applies to the current route and to the planning of future routes.

 If the route criteria "Avoid highways", "Avoid toll roads", or "Avoid ferries" are selected, then this can prolong the calculation time for the route. ◀

ROUTE

There are various views of the route available during route guidance:

- ▷ Arrow display
- ▷ List of streets and towns/cities
- ▷ Map view, refer to page 125

Arrow display

The following information is displayed during route guidance:

- ▷ Large arrow: current direction of travel.
- ▷ Street name of the currently traveled street.
- ▷ Small arrow: indicates the next change of direction.
- ▷ Intersection view.
- ▷ Lane information.
- ▷ Traffic information.
- ▷ Distance to the next change of direction.
- ▷ Street name of the next change of direction.

Lane information

In the arrow display, the recommended lanes of multi-lane roads are each marked with a triangle.

- ▷ Filled triangle: optimum lane.
- ▷ Empty triangle: likewise possible lane. It can, however, also be possible to briefly make additional lane changes.

List of roads or towns/cities on the route

If the route guidance has been started, then you can display a list of the roads and towns/cities on the route. The distance to be traveled and traffic bulletins are displayed for each segment of the route.

- "Navigation"
- "Route information"



- Highlight a section.

Taking detours

During route guidance, prompt the navigation system to bypass certain route segments. In doing so, you will specify how many kilometers to travel before returning to the original route.

- "Navigation"
- "Route information"
- "New route for:"

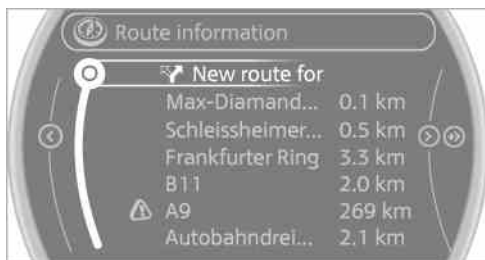

- Turn the MINI joystick: enter the desired mileage.
- Press the MINI joystick.

Resuming the original route

If the route section should no longer be bypassed:

- "Navigation"
- "Route information"
- "New route for:"
- "Remove blocking"

Recommended refueling

The remaining driving range is calculated, and gas stations along the route are shown.

Even with the latest navigation data, information on various points of interest may have changed, e.g., service stations may not be in operation.

- "Navigation"
- "Route information"
- "Recommended refuel"
A list of gas stations is displayed.
- Select a gas station.
- Select the  symbol.
- "Start guidance": the guidance to the selected gas station is started.
"Add as another destination": the gas station is included in the route.

MAP DISPLAY

Displaying map view

- "Navigation"
- "Map"

Overview

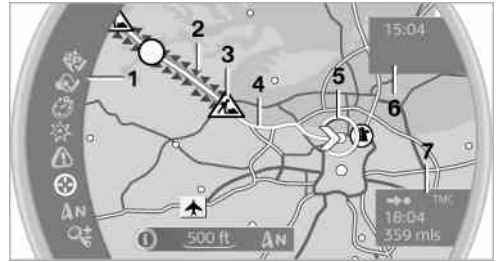

- Toolbar
- Route segment with traffic obstruction
- Road sign for traffic obstruction
- Planned route
- Current location
- Upper status box
- Lower status box

Lines on the map

In the map view, streets and roads are depicted with different colors and lines according to their classification. Dotted lines represent railroad and ferry connections. National borders are depicted with thin lines.

Traffic obstructions

Small triangles along the planned route identify route segments with traffic obstructions, depending on map scale. The direction of the triangles indicates the direction of the obstruction.

Road signs classify the obstructions.

- ▶ Red road sign: the obstruction relates to the planned route or direction of travel.
- ▶ Gray road sign: the obstruction does not relate to the planned route or direction of travel.

Traffic information, refer to page [127](#).

Planned route

After route guidance is started, the planned route is displayed on the map.

Status boxes

Show/hide: press the MINI joystick.

- ▷ Upper status box: time, phone details, and entertainment details.
- ▷ Lower status box: symbol for active route guidance, traffic information status, arrival time, and distance from destination.

Toolbar

The following functions are available directly in the map view:

Symbol	Function
	Starting/stopping route guidance
	Switching voice instructions on/off
	Changing route criteria or selecting route alternatives
	Searching for special destination
	Displaying traffic bulletins
	Interactive map
	Adjusting map views or arrow display
	Changing scale

Changing map scale

- ▷ "Interactive map"
- ▷ Moving map: move the MINI joystick in the corresponding direction.
- ▷ Shifting map diagonally: move the MINI joystick in the corresponding direction and turn the MINI joystick.

Changing scale

1. Select the symbol and press the MINI joystick.
2. Changing scale: turn the MINI joystick.

Automatic scaling of the map

In the map view facing north, turn the MINI joystick in either direction until the scale AUTO is displayed. The map shows the entire path between the location and destination.

Settings for the map display

The settings are stored for the remote control currently in use.

1. Open "Options".
2. "Settings"
 - ▷ "Day/night mode"

Select and adjust depending on light conditions. If "Traffic conditions/gray map" is activated, then this setting is not taken into account.
 - ▷ "Traffic conditions/gray map"

The map is optimized for displaying traffic bulletins. Symbols for the special destinations are no longer displayed.

Displaying arrow view in map display

When route guidance is active, the arrow view can be displayed additionally on the right side of the map display.

1. "Navigation"
2. Open "Options".
3. "Arrow display on map"





DESTINATION GUIDANCE VIA VOICE INSTRUCTIONS

Switching voice instructions on/off

The voice instructions can be switched on and off during route guidance.

1. "Navigation"
2. "Map"
3. Select the  symbol.

Symbol	Meaning
	Voice instructions switched on
	Voice instructions switched off

Repeating a voice instruction

1. "Navigation"
2. "Map"
3. Highlight the  symbol.
4. Press the MINI joystick twice.

Adjusting volume for voice instructions

The volume can be adjusted only while a voice instruction is being issued.

1. Repeat the last voice instruction, if necessary.
2. Turn the knob during the voice instruction to select the desired volume.



This volume is independent of the volume of the audio sources.

The setting is stored for the remote control currently in use.

TRAFFIC INFORMATION

Overview

In many congested areas, you can receive traffic information that is transmitted by radio stations. The traffic conditions are monitored by traffic control centers and the traffic information is updated periodically.

During route guidance, the traffic information relevant to the route you are planning to take is automatically shown and taken into account in route planning. Irrespective of whether route guidance is active, you can have the traffic information displayed in the map display or as an event list.

 The symbol in the toolbar of the map view turns red if traffic information relates to the calculated route.

Real Time Traffic Information End-User Provisions

Certain MINI models equipped with navigation have the capability to display real-time traffic information. If your system has this capability the following additional terms and conditions apply:

An End-User shall no longer have the right to use the Traffic Data in the event that the End-User is in material breach of the terms and conditions contained herein.

A. Total Traffic Network, a division of Clear Channel Broadcasting, Inc. ("Total Traffic Network") holds the rights to the traffic incident data and RDS-TMC network through which it is delivered. You may not modify, copy, scan or use any other method to reproduce, duplicate, republish, transmit or distribute in any way any portion of traffic incident data. You agree to indemnify, defend and hold harmless MINI of North America, LLC. ("MINI NA") and Total Traffic Network, Inrix, Inc (and their affiliates) against any and all

claims, damages, costs or other expenses that arise directly or indirectly out of (a) your unauthorized use of the traffic incident data or the RDS-TMC network, (b) your violation of this directive and/or (c) any unauthorized or unlawful activities by you in connection herewith.

B. Total Traffic Network traffic data is informational only. User assumes all risk of use. Total Traffic Network, MINI NA, and their suppliers make no representations about content, traffic and road conditions, route usability, or speed.



C. The licensed material is provided to license "as is," and "where is". Total Traffic Network, including, but not limited to, any and all third party providers of any of the licensed material, expressly disclaims, to the fullest extent permitted by law, all warranties or representations with respect to the licensed material (including, without limitation, that the licensed material will be error-free, will operate without interruption or that the traffic data will be accurate), express, implied or statutory, including, without limitation, the implied warranties of merchantability, non-infringement fitness for a particular purpose, or those arising from a course of dealing or usage of trade.

D. Neither Total Traffic Network, Inrix, Inc. nor MINI NA will be liable to you for any indirect, special, consequential, exemplary, or incidental damages (including, without limitation, lost revenues, anticipated revenues, or profits relating to the same) arising from any claim relating directly or indirectly to use of the traffic data, and even if Total Traffic Network, Inrix, Inc., or MINI NA are aware of the possibility of such damages. These limitations apply to all claims, including, without limitation, claims in contract and tort (such as negligence, product liability and strict liability). Some states do not allow the exclusion or limitation of incidental or consequential damages, so those particular limitations may not apply to you.

Switching reception of traffic information on/off

1. "Navigation"
2. Open "Options".
3. Activate/deactivate "Receive Traffic Info".

Accessing traffic information

1. "Navigation"
2. "Map"
"Traffic Info": traffic information for the surrounding area is listed here. The symbol turns red when traffic information relate to the calculated route.
3.  "Traffic Info"
First, traffic bulletins relating to the planned route are displayed.
The traffic bulletins are sorted in the order of their distance from the current vehicle position.
4. Select traffic information.
 "More information": display additional information.
5. Scroll to the next or previous traffic information if desired.

Traffic bulletins in the map

When the traffic info map is activated, the picture on the Control Display is switched to a gray-scale. This permits an optimized depiction of traffic information. The day/night mode is disregarded in this setting. The symbols for the special destinations are no longer displayed.

1. "Navigation"
2. "Map"
3. Open "Options".
4. "Settings"
5. "Traffic conditions/gray map"

Symbols in map view

The symbols of traffic obstructions are displayed differently, depending on the scale of the map and location of the traffic obstruction in relation to the route.

Additional information in the map display

Depending on the map scale, the length, direction, and effects of a traffic obstruction are depicted by traffic symbols in the map or by bars along the planned route. The colors displayed depend on the information sent by the traffic information service.

- ▷ Red: traffic congestion
- ▷ Orange: stop-and-go traffic
- ▷ Yellow: heavy traffic
- ▷ Green: clear roads
- ▷ Gray: general traffic information such as road construction

The colors displayed depend on the information sent by the traffic information service.

Filtering of traffic bulletins

To set which traffic bulletins the system should display:

1. "Navigation"
2. "Map"
3. Open "Options".
4. "Traffic Info categories"
5. Select the desired categories.

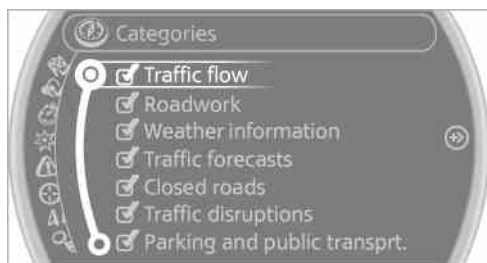

Traffic bulletins of the selected categories are displayed.

- ▷ Traffic bulletins on incidents along the route are always displayed.
- ▷ For personal safety, traffic information that indicates a potential hazard can not be hidden.

Route guidance with traffic information

General information

In semi-dynamic route guidance systems, detour suggestions by the navigation system can be added manually. In dynamic route guidance systems, they are automatically included in the route guidance.

Semi-dynamic route guidance

With traffic information reception switched on, semi-dynamic route guidance is active.

The system takes into account the existing traffic information during route guidance. A message is displayed as a function of the route, the traffic information, and the possible alternate routes. When there are obstructions to traffic, an alternate route is provided. The difference in distance and time between the original route and the alternate route are also displayed.

Taking an alternate route:

- 📍 "Detour"

With particular hazards, e.g. objects on the roadway, a message is displayed without a possible alternate route.

It is also possible to take alternate routes can also be taken if the traffic reports are accessed via the list:

1. "Navigation"
2. "Map"
3. ⚠️ "Traffic Info"
4. "Detour information"
5. 📍 "Detour"

Dynamic route guidance

The route is automatically changed in the event of traffic obstructions.

- ▷ The system will not point out traffic obstructions on the original route.
- ▷ Traffic information will continue to be displayed on the map.

- ▷ Depending on the type of road and the nature and length of the traffic obstruction, the route can also be calculated so that you travel through the traffic obstruction.
- ▷ Certain hazards are displayed regardless of the setting.

To activate dynamic route guidance:

1. "Navigation"
2. Open "Options".
3. "Dynamic guidance"

WHAT TO DO IF...

What to do if...

- ▷ The current position cannot be displayed?
The position is in an unrecognized region, in a poor reception area, or the system is in the process of determining the position. Reception is best when you have an unobstructed view to the sky.
- ▷ The route guidance does not accept an address without the street name?
A downtown area cannot be determined for the town or city that has been entered. Input any street in the selected town/city and start route guidance.
- ▷ The route guidance does not accept a destination?
The destination data is not contained in the navigation data. Select a destination that is as close as possible to the original.
- ▷ The letters for a destination cannot be selected during destination entry?
Stored data do not contain the data of the destination. Select a destination that is as close as possible to the original.
- ▷ The map view is displayed in grayscale?
When the traffic info map is activated, the picture on the Control Display is switched to a grayscale. This permits an optimized depiction of traffic information.
- ▷ Voice instructions are no longer issued before intersections during route guidance?
The area has not been fully recorded yet, or you have left the recommended route and the system requires a few seconds to calculate a new route suggestion.
- ▷ The navigation system does not react to entries?
If the battery was disconnected, it takes about 10 minutes before the system is once again operational.



ROCK ME.

AT A GLANCE

CONTROLS

DRIVING TIPS

NAVIGATION

ENTERTAINMENT

COMMUNICATIONS

MOBILITY

REFERENCE

ON/OFF AND TONE

VEHICLE EQUIPMENT

In this chapter, all production, country, and optional equipment that is offered in the model range is described. Equipment is also described that is not available because of, for example, selected options or country version. This also applies to safety related functions and systems.

GENERAL INFORMATION

The following audio sources have shared control elements and setting options:

- ▷ Radio
- ▷ CD player
- ▷ External devices, e.g. MP3 player

CONTROLS

The audio sources can be operated using:

- ▷ Buttons near the CD player
- ▷ Onboard computer
- ▷ Buttons on the steering wheel, refer to page 10

Buttons near the CD player



- 1 Drive for audio CDs
- 2 Selecting waveband
- 3 Changing the audio source

- 4 Sound output for entertainment on/off, volume
 - ▷ Press: switch on/off.
When you switch on the unit, the radio station or track set most recently is played.
 - ▷ Turn: adjust volume.
- 5 Station scan/track search
 - ▷ Change radio station.
 - ▷ Selecting a track.
- 6 Ejecting CD

SWITCHING ON/OFF

Entertainment audio output



Press the knob.

⚡ This symbol at the upper edge of the Control Display indicates that the sound output is switched off.

ADJUSTING VOLUME



Turn the knob to the desired volume.

The volume can also be adjusted on the steering wheel, refer to page 10.

The setting is stored for the remote control currently in use; refer to Personal Profile, page 28.

TONE CONTROL

Various tone settings can be changed, e.g. treble and bass or the speed-dependent volume control.

The tone settings are set for all audio sources at once.

The settings are stored for the remote control currently in use; refer to Personal Profile, page 28.

Treble, bass, balance, fader

- ▷ "Treble": treble adjustment.
- ▷ "Bass": bass adjustment.
- ▷ "Balance": volume distribution right/left.
- ▷ "Fader": volume distribution front/back.

Adjustments

1. "CD/Multimedia", "Radio" or "Settings".
2. "Tone"



3. Select the desired tone setting.

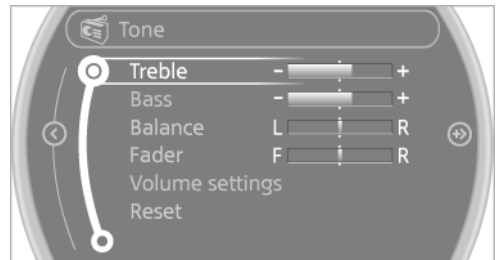

4. To adjust: turn the MINI joystick.
5. To store: press the MINI joystick.

Volume levels

- ▷ "Speed volume": volume is adapted depending on the speed
- ▷ "PDC": volume of the PDC acoustic signal relative to the entertainment sound output
- ▷ "Gong": volume of the acoustic signal, e.g. for the acoustic Safety Belt Reminder relative to the entertainment sound output

Mobile phone preparation Bluetooth

- ▷ "Microphone": volume of the microphone during a phone conversation.
- ▷ "Loudspeak.": volume of the speaker during a phone conversation.

Adjustments

1. "CD/Multimedia", "Radio" or "Settings".
2. "Tone"
3. "Volume settings"
4. Select the desired volume setting.

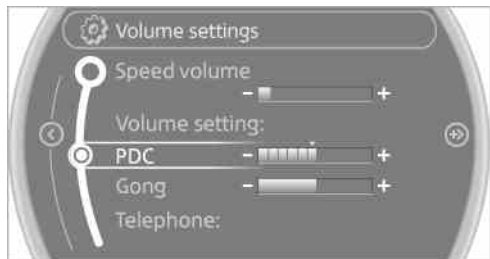

5. To adjust: turn the MINI joystick.
6. To store: press the MINI joystick.

Resetting tone settings

All tone settings can be reset to the default value.

1. "CD/Multimedia", "Radio" or "Settings".
2. "Tone"
3. "Reset"

RADIO

VEHICLE EQUIPMENT

In this chapter, all production, country, and optional equipment that is offered in the model range is described. Equipment is also described that is not available because of, for example, selected options or country version. This also applies to safety related functions and systems.

GENERAL INFORMATION

Your radio is designed for reception of the following stations:

- ▷ FM and AM
- ▷ HD Radio
- ▷ Satellite radio

AM/FM STATION

Selecting a station



Press the knob if the sound output is switched off.

1. "Radio"

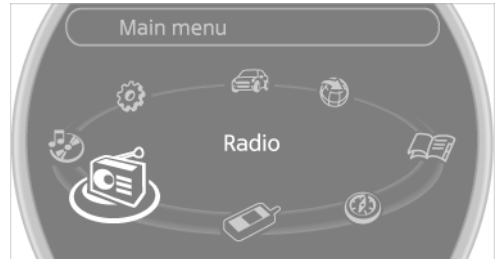

2. "FM" or "AM"

3. Select the desired station.

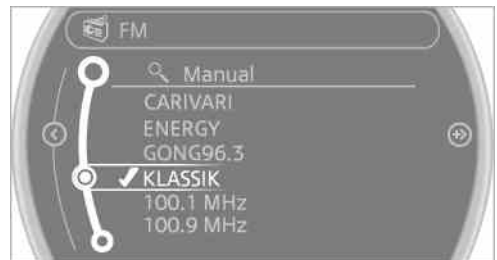

The selected station is stored for the remote control currently in use.

Changing stations

Turn and press the MINI joystick

or

Press the ◀▶ button for the corresponding direction

or

Press the buttons on the steering wheel, refer to page 10.

Selecting a station manually

Station selection via the frequency.

1. "Radio"
2. "FM" or "AM"
3. "Manual"

4. Select the frequency: turn the MINI joystick.



To store the station: press the MINI joystick.

Storing stations

1. "Radio"
2. "FM" or "AM"
3. Select the desired station.

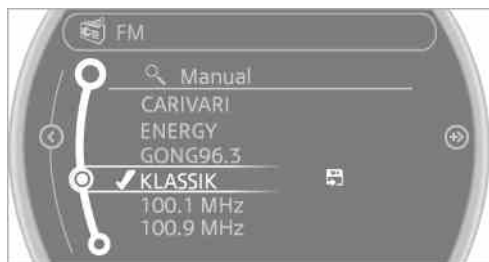

4. Press the MINI joystick.
5. Select the desired memory location.

Press and hold the MINI joystick to save a radio station that appears in the list of stations, but is not being listened to.

The stations are stored for the remote control currently in use.

RDS – Radio Data System

In the FM frequency range, additional information is transmitted via RDS. If the reception conditions are good, the station names are shown on the Control Display. If the reception is weak or disrupted, it can take some time before the station names are displayed.

Switching the RDS on/off

1. "Radio"
2. "FM"
3. Open "Options".
4. "RDS"

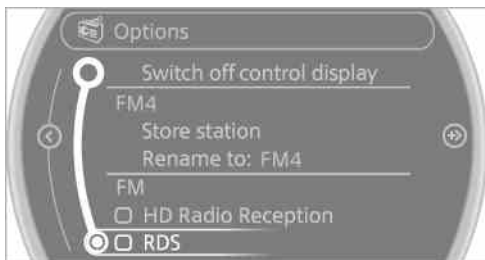

The setting is stored for the remote control currently in use.

HD RADIO™ RECEPTION

Many radio stations transmit analog and digital signals. If a digital radio network is available, these stations can be received digitally and thus with improved sound quality.

License conditions

HD Radio™ technology is manufactured under U.S. and Foreign Patents licensed from iBiquity Digital Corp. HD Radio™ and the HD and HD Radio logos are proprietary trademarks of iBiquity Digital Corp.

Activating/deactivating digital radio reception

1. "Radio"
2. "FM" or "AM"
3. Open "Options".
4. "HD Radio Reception"

The setting is stored for the remote control currently in use.

 This symbol is displayed when a station is being received digitally.

When setting a station with a digital signal, it may be a few seconds until the station is reproduced in digital quality.

In areas in which the station is not continuously received in digital mode, playback switches between analog and digital reception. In this case, switch off digital radio reception.

Displaying additional information

Some stations broadcast additional information on the current track, such as the name of the artist.

1. Select the desired station.
2. Open "Options".
3. "Station info"

Selecting a substation

The  symbol indicates that a main station also broadcasts additional substations. The station name of the main station ends in HD1. The station names of the substations end in HD2, HD3, etc.

1. Select the desired station.
2. Press the MINI joystick.
3. Select the substation.

When reception is poor, the substation is muted for several seconds.

STORED STATIONS

It is possible to store up to 40 stations.

Selecting a station

1. "Radio"
2. "Presets"
3. Select the desired station.

Storing a station

The station currently selected is stored.

1. "Radio"
2. "Presets"

3. "Store station"



4. Select the desired memory location.

The list of stored stations is stored for the remote control currently in use.

Deleting a station





1. "Radio"
2. "Presets"
3. Select the desired station.
4. Open "Options".
5. "Delete entry"

SATELLITE RADIO

General information

The channels are offered in fixed packages. Packages must be activated by telephone.

Navigation bar

Symbol	Function
	Changing list view
	Selecting category
	Entering channel directly
	Time shift

Symbol	Function
☆☆☆	Accessing favorites, selecting the My Favorites category
☆+	Managing favorites
↶	Traffic Jump

Managing subscription

Clear reception is required for activating and deactivating channels. Reception is best when you have an unobstructed view to the sky. The channel name is displayed in the status line.

Activating channels

The category 'Unsubscribed Channels' includes all channels that are not activated.

1. "Radio"
2. "Satellite radio"
3. ↶ "Category"



4. Select the category 'Unsubscribed Channels'.
5. Select desired channel.
The telephone number and electronic serial number, ESN, are displayed.

6. Dial the telephone number to have the channels activated.



This telephone number can also be used to deactivate the channels.

Deactivating channels

1. "Radio"
2. "Satellite radio"
3. Open "Options".
4. "Manage subscription"



The telephone number and electronic serial number, ESN, are displayed.

5. Call Sirius to deactivate the channels.

Selecting channels

You can only listen to activated channels.

The selected channel is stored for the remote control currently in use.

Using the onboard computer

1. "Radio"
2. "Satellite radio"
3. Select "All channels" or the desired category.
4. Select desired channel.



Using the buttons near the CD player

Press the ◀▶ button for the corresponding direction.

The next channel is selected.

Using direct channel entry

1. "Radio"
2. "Satellite radio"
3. 📶 "Set channel"
4. Turn the MINI joystick until you reach the desired channel and then press the MINI joystick.

Storing channel

1. "Radio"
2. "Satellite radio"
3. Select "All channels" or a desired category.
4. Select desired channel.
5. Press the MINI joystick again.

6. Press the MINI joystick again to confirm the highlighted channel.



7. Select the desired memory location.

The channels are stored for the remote control currently in use.

Changing list view

The list view changes each time the first symbol on the navigation bar is pressed.

Information about the channel is displayed.

Symbol	Function
📶	Channel name
🎤	Artist
🎵	Track

Selecting category

1. "Radio"
2. "Satellite radio"
3. 📶 "Category"
4. Select the desired category.

Time shift

Approximately one hour of the channel currently being listened to is temporarily stored in a cache memory. Prerequisite: the signal must be available.

The stored audio track can be played back at a different time from the live broadcast. If the cache memory is full, then the older tracks are recorded over. The cache memory is deleted if a new channel is selected.







Accessing Time shift

1. "Radio"
2. "Satellite radio"
3.  "Replay - Time shift"



- ▷ The red arrow indicates the current playback position.
- ▷ The time difference from the live broadcast is displayed next to the cache memory bar.
- ▷ For live transmissions: "live".

Time shift menu

Symbol	Function
	Go to live broadcast
	Playback/pause
	Next track
	Previous track
	Fast forward
	Reverse
	Automatic time shift deactivated/activated



Automatic time shift

When the function is activated, audio playback is stopped automatically in the event of:

- ▷ Incoming and outgoing telephone calls.
- ▷ Activation of the voice activation system.
- ▷ Muting.

The audio playback then continues with a time delay.

Activating

1. "Radio"
2. "Satellite radio"
3.  "Replay - Time shift"
4.  "Automatic time shift"

Deactivating

-  "Automatic time shift"

Storing favorites

Up to 30 favorites can be stored in the favorites list. Possible favorites include artist, track, game, league, and team.

Storing artist, track, or game

Only current broadcasts can be stored as favorites. The channel information must be available.

1. "Radio"
2. "Satellite radio"
3. Select "All channels" or the desired category.
4. Select desired channel.
5. Press the MINI joystick again.
6. Select artist, track, or game.

Storing league or team

Leagues or teams can be added to the favorites from a selection list.

1. "Radio"
2. "Satellite radio"
3.  "Manage favorites"

4. "Add sports information"



5. Select the desired league.
6. Select "Add all teams" or a desired team.

Accessing favorites

If an activated favorite is being played, the message "Favorite alert!" appears for approx. 20 seconds.

Select ☆ "Favorites" while the alert message is being displayed.



The displayed favorite will be played.

If it receives no notification, the system switches into the 'My Favorites' category. All of the favorites currently being broadcast can be selected from a list.

Managing favorites

Activating/deactivating favorites

Favorites can be activated or deactivated globally and individually.

1. "Satellite radio"
2. ☆+ "Manage favorites"
3. Select "Activate alert" or desired favorites.

The setting is stored for the remote control currently in use.

Deleting favorites

1. "Satellite radio"
2. ☆+ "Manage favorites"
3. Highlight the favorites you wish to delete.
4. Open "Options".
5. "Delete entry"

Traffic Jump

Traffic and weather information for a selected region are broadcast at intervals of a few minutes.

Selecting region

1. "Radio"
2. "Satellite radio"
3. Open "Options".
4. "Set jump"
5. Select the desired region.

The region is stored for the remote control currently in use.



Activating/deactivating Jump

1. "Radio"
2. "Satellite radio"
3. ↻ "Jump to:"

As soon as information about the selected region becomes available, it is broadcast.

A new panel appears in the display.

Cancel Traffic Jump: "Cancel".

Symbol	Meaning
	Information will be broadcast soon.
	Information is currently being broadcast.

Select one of the symbols to deactivate Traffic Jump.

Automatic update

About twice a year, Sirius carries out an update of the names and positions of the channels. The update occurs automatically and can take several minutes.

Notes

- ▷ Under some circumstances, reception may not be possible, e.g. under certain environmental or topographical conditions. The satellite radio has no influence on this.
- ▷ The signal may not be available in tunnels or underground garages or near trees, mountains, or other powerful sources of radio interference.

CD PLAYER

VEHICLE EQUIPMENT

In this chapter, all production, country, and optional equipment that is offered in the model range is described. Equipment is also described that is not available because of, for example, selected options or country version. This also applies to safety related functions and systems.

GENERAL INFORMATION

Inserting CD

Insert the CD into the drive with the labeled side up. The CD is automatically pulled in. Playback starts automatically if the sound output is on. For CDs with compressed audio files, it can take several minutes to the data, depending on the folder structure.

Playable formats

CD player



- ▷ CD: CD-ROM, CD-R, CD-RW, CD-DA
- ▷ Compressed audio files: MP3, WMA, AAC

Ejecting CD

Press the  button on the CD player. The CD will be slid a short distance out from the drive.

AUDIO PLAYBACK

Selecting the track using the button

Press the   button for the corresponding direction repeatedly until you reach the desired track.

Selecting the track using the onboard computer

Audio CDs

1. "CD/Multimedia"
2. "CD"
3. Select the desired track. Press the MINI joystick to start playback.



CDs with compressed audio files

Depending on the data, it is possible that not all indications on the CD will be correctly displayed.

1. "CD/Multimedia"
2. "CD"
3. Select the directory, if necessary. To change to a higher level directory: move the MINI joystick to the left.



- Select a track and press the MINI joystick.



Displaying information about the track

If information about a track has been stored, it is displayed automatically:



- ▷ Artist
- ▷ Album title
- ▷ Number of tracks on the CD
- ▷ Track file name

Random play sequence

The tracks on the current CD are played once each in random order.

- "CD/Multimedia"
- "CD"
- Select the desired CD.
- Open "Options".
- "Random"

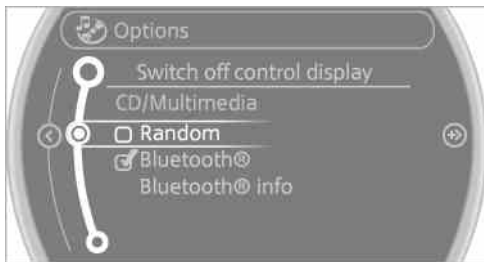

Switch off random play sequence: press the MINI joystick.

Fast forward/reverse

Press and hold the   button for the corresponding direction.

Automatic replay





Selected tracks, folders, or CDs are automatically repeated.

EXTERNAL DEVICES

VEHICLE EQUIPMENT

In this chapter, all production, country, and optional equipment that is offered in the model range is described. Equipment is also described that is not available because of, for example, selected options or country version. This also applies to safety related functions and systems.

OVERVIEW

Symbol	Meaning
	USB audio interface
	Mobile phone audio interface
	Bluetooth audio
	AUX-In connection

AUX-IN CONNECTION

Overview

- ▷ It is possible to connect audio devices, e.g. MP3 players. Sound is output over the vehicle speakers.
- ▷ Recommended settings: mid-level tone and volume settings on the audio device. Tone may depend on the quality of the audio files.

Connecting



- 1 USB interface
- 2 Connection for audio playback:
TRS connector 1/8"/3.5 mm

For audio playback over the vehicle speakers, connect the headphones or line-out connection of the device to the AUX-In connection 2.

Starting audio playback

The audio device must be switched on.

1. "CD/Multimedia"
2. "External devices" if applicable



3.  "AUX front"

Sound is output on the vehicle loudspeakers.

Volume

The volume of the sound output depends on the audio device. If this volume differs markedly from the volume of the other audio sources, it is advisable to adjust the volumes.

Adjusting volume

1. "CD/Multimedia"
2. "External devices" if applicable
3.  "AUX front"
4. "Volume"

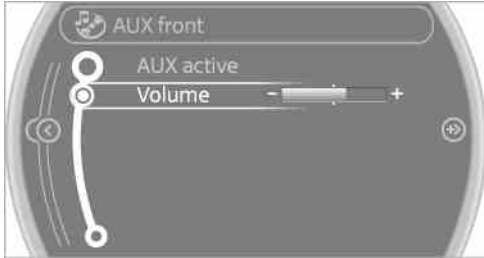

5. Turn MINI joystick until the desired volume is set and then press the MINI joystick.

USB AUDIO INTERFACE/ MOBILE PHONE AUDIO INTERFACE

Overview

It is possible to connect external audio devices. They are operated using the onboard computer. Sound is output over the vehicle speakers.

Options for connecting external devices

- ▷ Connection via USB audio interface: Apple devices, USB devices such as MP3 players, USB memory sticks, or mobile phones that are supported by the USB audio interface.
- ▷ Connection via the snap-in adapter, when equipped with extended connectivity of the music player in the mobile phone: Apple iPhone or mobile phones. Playback is only possible if no plug is present in the USB audio interface.

Because of the large number of audio devices available on the market, an operation via the vehicle cannot be guaranteed for every audio device/mobile phone.

Ask your MINI dealer for suitable audio devices/mobile phones.

File systems

Popular file systems for USB devices are supported. The manufacturer of your MINI recommends the FAT 32 format.

Audio files

Playback of standard audio files is possible, depending on the vehicle equipment:

- ▷ MP3
- ▷ WMA
- ▷ WAV (PCM)
- ▷ AAC, M4A
- ▷ Without voice activation system: Playback lists: M3U
- ▷ With voice activation system: Playback lists: M3U, WPL, PLS

Video files

Playback of standard video files with a compatible Apple device is possible:

- ▷ MPEG4
- ▷ H.264

Connecting via the USB audio interface



- 1 USB interface
- 2 Connection for audio/video playback: TRS connector 1/8"/3.5 mm

Apple device

A special adapter cable is available for connecting the Apple device. The adapter cable is required for a proper connection.

Further information:

- ▷ At: www.mini.com/connectivity
- ▷ At your MINI dealer.

For audio playback over the vehicle speakers, connect the Apple device using the special adapter cable with AV-In connection **2** and USB interface **1** or using a flexible adapter cable with a USB interface **1**.

The USB audio interface supports the menu structure of the Apple device.

USB device

To protect the USB interface and USB device from mechanical damage, connect them with a flexible adapter cable.

Connect the USB device to the USB interface **1**.

After initial connection

Track information, e.g. artist or music style and the playlists of the USB device are imported into the vehicle. This process can take some time.

The time required is dependent on the USB device and on the number of tracks.

During transmission, the tracks can be accessed via the file directory.

Number of tracks



The data from up to four USB devices or for approx. 26,000 tracks can be stored in the vehicle. If a fifth device is connected or if more than 26,000 tracks are stored, then the data of existing tracks may be deleted.

Copy protection

Music tracks with integrated Digital Rights Management (DRM) cannot be played.

Audio playback

Starting audio playback

1. "CD/Multimedia"
2. "External devices"
3. Select the  or  symbol and press the MINI joystick.

Playback begins with the first track.



Track search

Selection is possible via:

- ▷ Playback lists
- ▷ Information: music style, artist; if applicable, composer, album, track.
- ▷ Additionally for USB devices: file directory; if applicable, composer.

Track titles are displayed if they have been stored in the Latin alphabet.

Starting the track search

1. "CD/Multimedia"
2. "External devices"
3. Select the  or  symbol.



4. Select desired category, e.g. "Genre", "Artist".

All entries are displayed in a list.

- ▷ Open "A-Z search" and enter the desired input. When a letter is entered, the results are filtered using this letter as the first letter. If multiple letters are entered, all results that contain that sequence are displayed.

- ▶ Select the desired entry from the list.





5. Select additional categories if desired.
Not all categories need to be selected. For example, if all of the tracks by a certain artist are to be displayed, call up that artist only. All of the tracks by that artist are then displayed.
6. "Play"

Restarting a track search

"New search"



Playback lists

To open playback lists.

1. "CD/Multimedia"
2. "External devices"
3. Select the  or  symbol.
4. "Playlists"

Current playback

List of tracks currently being played.

1. "CD/Multimedia"
2. "External devices"
3. Select the  or  symbol.
4. "Current playback"

Random play sequence

The current list of tracks is played in random sequence.

1. "CD/Multimedia"
2. "External devices"
3. Open "Options".
4. "Random"

Fast forward/reverse

Buttons on the steering wheel or CD player:

Press and hold the   button for the corresponding direction.

Video playback

The video image on the onboard computer is displayed when the vehicle is standing still; in some countries only when the hand brake is engaged or if the transmission is set on P.

For video playback, connect the Apple device to the USB audio interface using the video-enabled adapter cable.

1. "CD/Multimedia"
2. "External devices"
3. Select the  symbol and press the MINI joystick.
4. "Video"



5. Select the desired file.
Select category in file directory, if applicable.



6. Press the MINI joystick.
The playback of the selected video file is started.

Notes

 Do not subject the audio device to extreme environmental conditions, e.g. extremely high temperatures, refer to the operating instructions for the audio device. Otherwise the audio device may be damaged, impairing driving safety while driving. ◀

Depending on the configuration of the audio files, e.g. bit rates greater than 256 Kbit/s, proper playback cannot always be ensured.

Information on connection

- ▶ The connected audio device is supplied with a max. power of 500 mA if supported by the device. Therefore, do not connect the device to the power socket in the vehicle.
- ▶ Do not use force when plugging the connector into the USB interface.
- ▶ Do not connect any devices, e.g. fans or lamps, to the USB audio interface.
- ▶ Do not connect USB hard drives.
- ▶ Do not use the USB audio interface to recharge external devices.

BLUETOOTH AUDIO

Overview

- ▶ It is possible to use Bluetooth to play music files from external devices, e.g. audio devices or mobile phones.
- ▶ Bluetooth® is a registered trademark of Bluetooth® SIG, Inc.
- ▶ Sound is output over the vehicle speakers.
- ▶ The volume of the sound output depends on the device. If necessary, change the volume setting on the device.
- ▶ Up to four external devices can be paired with the vehicle.

Requirements

- ▶ Suitable device. Information is available at www.mini.com/connectivity.
- ▶ Device operational.
- ▶ Ignition switched on.
- ▶ Bluetooth activated in vehicle, refer to page 169, and in the device.
- ▶ Bluetooth presets in the device are required, e.g. connection not confirmed or visible, refer to Owner's Manual for the device.
- ▶ A number with at least 4 and at most 16 digits has been established as the Bluetooth passkey. Only required once for pairing.

Pairing and connecting

 Only pair the device when the vehicle is stopped; otherwise, inattention may lead to endangerment of passengers or other road users. ◀

1. "CD/Multimedia"
2. "Bluetooth® (audio)"
3. "Bluetooth® audio" if applicable
4. "Add new phone"

The Bluetooth name of the vehicle is displayed.



5. To perform other operations on the device, refer to the operating instructions for the device: e.g. search for and connect Bluetooth device or a new device.

The Bluetooth name of the vehicle appears on the device's display.

- Select the Bluetooth name of the vehicle on the device's display.
The onboard computer or the device will prompt you to enter the same Bluetooth passkey.
- Enter the passkey and confirm.



- Select desired functions with which the device is to be connected, e.g. "Audio".
- "OK"

If the pairing was successful, the device is displayed as connected.

 symbol displayed in white: device is active as an audio source.

If the pairing was not successful: what to do if..., refer to page 154.

Connecting a particular device

A device that has already been paired can be connected as an active audio source.

Connection is not possible if a data exchange is currently taking place via a mobile phone that is connected via Bluetooth.

Prerequisite

If necessary, activate the audio connection of the desired device from the list of paired devices.

- "CD/Multimedia"
- "Bluetooth® (audio)"
- "Bluetooth® audio" if applicable
- Select the desired device from the list of paired devices.
- Open "Options".

- "Configure phone"
- Activate "Audio".
- "OK"

Connecting a device

- "CD/Multimedia"
- "Bluetooth® (audio)"
- "Bluetooth® audio" if applicable
- Select the desired device from the list of paired devices.



 symbol displayed in white: device is active as an audio source.

Playback

General information

- ▶ The display of track information depends on the device.
- ▶ Operation via the device or the onboard computer are both possible.
- ▶ Playback is interrupted if a data exchange takes place via a mobile phone that is connected via Bluetooth.

Starting playback

- Connect device.
- "CD/Multimedia"
- "External devices"

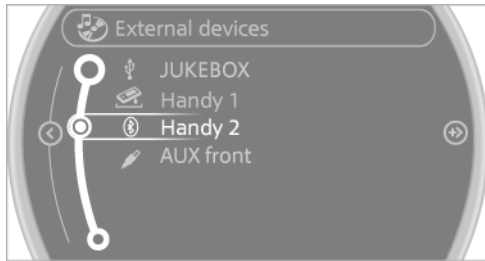

4. Select the  symbol.



5. Select the desired track from the list.

Playback menu

Depending on the device, all functions may not be available.

Symbol	Function
	Next track Fast forward: press and hold the symbol.
	Previous track Reverse: press and hold the symbol.

Track search

Depending on the device, it is possible to search by track.

1. "CD/Multimedia"
2. "External devices"
3. Select the  symbol.
4. "Search device content"
5. "A-Z search"
6. Select desired entry or directory.

Player program

Depending on the device, there may be various programs for playing music files.

1. "CD/Multimedia"
2. "External devices"
3. Select the  symbol.

4. Open "Options".
5. "Select player"
6. Select the desired program.

Disconnecting an audio connection

1. "CD/Multimedia"
2. "Bluetooth® (audio)"
3. Select the desired device from the list of connected devices.
4. Open "Options".
5. "Configure phone"
6. Deactivate "Audio".
7. "OK"

With a mobile phone, only the audio connection is disconnected. All other connections remain active.

Unpairing device

1. "CD/Multimedia"
2. "Bluetooth® (audio)"
3. "Bluetooth® audio" if applicable
4. Highlight the device to be unpaired.
5. Open "Options".
6. "Remove phone from list"

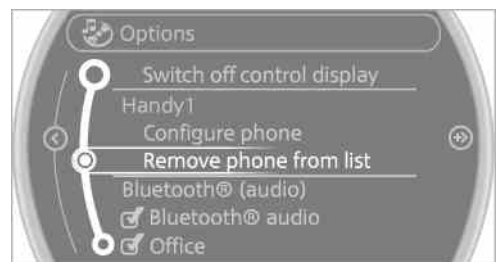

What to do if...

Information about suitable devices is available at www.mini.com/connectivity.

Suitable mobile phones, refer to page 168.

Device not supported by vehicle.

- ▷ If necessary, perform a software update; refer to page 154.

Device could not be paired or connected.

- ▷ Do the Bluetooth passkeys on the device and vehicle match? Enter the same passkey on the device and via the onboard computer.
- ▷ A multi-digit passkey may be required.
- ▷ Is the passkey input taking longer than 30 seconds? Repeat the pairing procedure.
- ▷ Are too many Bluetooth devices connected to the device or to the vehicle? If necessary, delete the connections with other devices.
- ▷ Is the mobile phone in power economy mode or does it only have a small amount of battery charge remaining? Charge the mobile phone in the snap-in adapter or via a charging cable.
- ▷ Depending on the mobile phone, it may only be possible to connect one device to the vehicle. Unpair the connected device from the vehicle and only pair and connect one device.
- ▷ Is the device no longer responding? Switch the device off and back on again.
- ▷ Repeat the pairing procedure.

No music can be played.

- ▷ Start the program for playing music files on the device and if necessary, select a track via the device.
- ▷ Activate and deactivate the radio mute on the radio control panel.

Music files only play quietly.

- ▷ Adjust volume settings on the device.

Videos cannot be played or can only be played with a delayed audio output.

- ▷ Check the device compatibility. Information is available at www.mini.com/connectivity.

Playback is interrupted by the press of a button or other messages on the device.

- ▷ Switch off key tones and other acoustic signal on the device.

Playback is interrupted by a phone call or traffic report and does not automatically continue.

- ▷ Activate and deactivate the radio mute on the radio control panel.

Playback is not possible when the mobile phone is connected via Bluetooth audio and at the same time via the extended connectivity of the music player in the mobile phone.

- ▷ Disconnect one of the two connections, e.g. the audio connection, refer to page 153, and start playback again.

If you have gone through all items in the list and still cannot activate the desired function please contact the Hotline or your MINI dealer.

SOFTWARE UPDATE

The vehicle supports various external devices, depending on the software it is currently using. A software update can enable the vehicle to support, for example, new mobile phones or new external devices.

Software updates and associated, up-to-date instructions are available on the web page www.mini.com/connectivity.

Displaying current version

The currently installed software is displayed.

1. "Settings"
2. "Software update"
3. "Show current version"

Select the desired version to display additional information.

Updating software

The software update can only be performed when stopped.

1. Save the file for the software update in the main directory of a USB data storage device.
2. Connect the USB data storage device to the USB interface of the USB audio interface in the center console. It is not possible to perform the update using the USB interface in the glove compartment.
3. "Settings"
4. "Software update"
5. "Update software"



6. "Start update"
7. "OK"

All of the listed software updates are installed.

Reinstalling previous version

The software version before the last software update can be restored.

The restoring to the previous version can only be performed when stopped.

1. "Settings"
2. "Software update"
3. "Restore previous version"
4. Select "OK" twice.

All of the listed software updates are removed.

Note

MINI Connected, Office functions, and connected devices may temporarily be unavailable during a software update or while restoring to the previous version. Wait a few minutes until the functions are available once more.



CONNECT ME.

AT A GLANCE

CONTROLS

DRIVING TIPS

NAVIGATION

ENTERTAINMENT

COMMUNICATIONS

MOBILITY

REFERENCE

HANDS-FREE DEVICE BLUETOOTH

VEHICLE EQUIPMENT

In this chapter, all production, country, and optional equipment that is offered in the model range is described. Equipment is also described that is not available because of, for example, selected options or country version. This also applies to safety related functions and systems.

OVERVIEW

The concept

Mobile phones can be connected to the vehicle through Bluetooth.

Bluetooth® is a registered trademark of Bluetooth® SIG, Inc.

After being paired once, when the ignition is switched on, these devices are automatically detected as soon as they are present in the vehicle and can be controlled via the onboard computer, the buttons on the steering wheel, and by voice.

Up to four mobile phones can be paired.

It may be necessary for some functions to be activated by the mobile phone provider.

 Only make entries when traffic conditions permit. Do not hold the mobile phone in your hand while you are driving; use the hands-free system instead. If you do not observe this precaution, your being distracted can endanger vehicle occupants and other road users. ◀

Suitable mobile phones

Precise information as to which mobile phones are supported by the hands-free device can be found at www.mini.com/connectivity.

With a certain software version, these suitable mobile phones support the vehicle functions described below.

With other mobile phones or software versions, malfunctions may occur.

A mobile phone that is connected to the vehicle should not be operated via the mobile phone keypad; otherwise, malfunctions may occur.

Displaying vehicle identification number and software part number

To check which mobile phones are supported by the hands-free device, the vehicle identification number and the software part number will be required. The software version of the mobile phone may also be required.

1. "Telephone"
2. Open "Options".
3. "Bluetooth® info"
4. "Display system information"

Notes

Do not expose your mobile phone to extreme ambient conditions, for example, very high temperatures; otherwise, functions on your mobile phone may not work. Follow the operating instructions for your mobile phone.

PAIRING/UNPAIRING MOBILE PHONE

Requirements

- ▷ Suitable mobile phone, refer to page 158.
- ▷ Mobile phone operational.
- ▷ Bluetooth activated in vehicle, refer to page 159, and in the mobile phone.
- ▷ Bluetooth presets in the mobile phone are required, e.g. connection not confirmed or visible, refer to Owner's Manual for the mobile phone.

- ▷ A number with at least 4 and at most 16 digits has been established as the Bluetooth passkey. Only required once for pairing.
- ▷ Radio readiness switched on.

Activating/deactivating Bluetooth link

Bluetooth is not permitted everywhere. Comply with all safety guidelines and regulations.

1. "Telephone"
2. Open "Options".
3. "Bluetooth®"

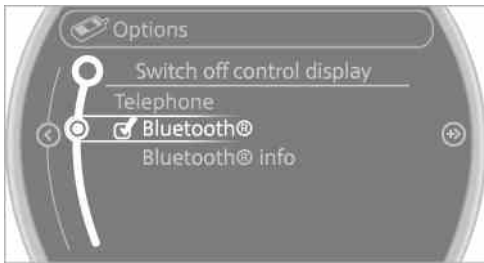

Pairing and connecting

! Only pair the mobile phone when the vehicle is stopped; otherwise, inattention may lead to endangerment of passengers or other road users. ◀

1. "Telephone"
2. "Bluetooth® (phone)"
3. "Add new phone"

The Bluetooth name of the vehicle is displayed.



4. To perform other operations on the mobile phone, refer to the Owner's Manual for the mobile phone: e.g. search for and connect Bluetooth device or a new device.

The Bluetooth name of the vehicle appears on the mobile phone display.

5. Select the Bluetooth name of the vehicle on the mobile phone display.
6. The onboard computer or the mobile phone will prompt you to enter the same Bluetooth passkey.



Enter the passkey and confirm.

or

Compare the control number on the vehicle display with the control number on the mobile phone display. Confirm the control number in the mobile phone and in the vehicle.

"OK"

7. Select the functions that are to be used for the mobile phone.
8. "OK"
9. Move the MINI joystick to the left.

If pairing was successful, the mobile phone appears at the top of the list of mobile phones.

If the pairing was not successful: what to do if..., refer to page 160.

Following the initial pairing

- ▷ The mobile phone is detected/connected in the vehicle within a short period of time when the engine is running or radio readiness is switched on.

- ▷ After identification, phone book entries are imported from the mobile phone and/or SIM card of the telephone, depending on the telephone.
- ▷ Four mobile phones can be paired.
- ▷ Specific settings may be necessary in some mobile phones, e.g. authorization or a secure connection, refer to the Owner's Manual for the mobile phone.

Connecting a particular mobile phone

1. "Telephone"
2. "Bluetooth® (phone)"
All paired mobile phones are listed.
3. Select the mobile phone to be connected.



Unpairing mobile phone

1. "Telephone"
2. "Bluetooth® (phone)"
All paired mobile phones are listed.
3. Highlight the mobile phone to be unpaired.
4. Open "Options".
5. "Remove phone from list"

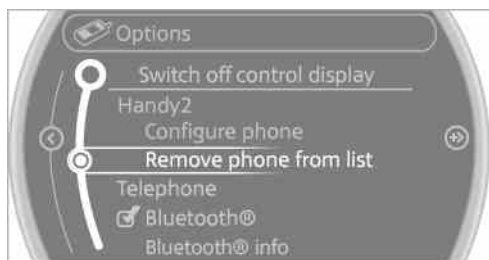

What to do if...

For information on suitable mobile phones, refer to page 158.

The mobile phone could not be paired or connected.

- ▷ Is Bluetooth activated in the vehicle and in the mobile phone? Activate Bluetooth in the vehicle and in the mobile phone.
 - ▷ Do the Bluetooth passkeys on the mobile phone and the vehicle match? Enter the same passkey on the mobile phone and via the onboard computer.
 - ▷ Is the passkey input taking longer than 30 seconds? Repeat the pairing procedure.
 - ▷ Are too many Bluetooth devices connected to the mobile phone? If so, delete the connections with other devices on the mobile phone.
 - ▷ Is the mobile phone in power economy mode or does it only have a small amount of battery charge remaining? Charge the mobile phone using a charging cable.
 - ▷ Depending on the mobile phone, it may only be possible to connect one device to the vehicle. Unpair the connected device from the vehicle and only pair and connect one device.
 - ▷ Is the mobile phone no longer responding? Switch the mobile phone off and back on again. Repeat the pairing procedure.
- Is the mobile phone no longer responding?
- ▷ Switch the mobile phone off and back on again. Repeat the pairing procedure.
 - ▷ Is the ambient temperature too high or too low? Do not subject your mobile phone to extreme ambient temperatures.

Phone book entries are not displayed, not all of them are displayed, or they are displayed incompletely.

- ▷ The transfer of phone book entries has not yet completed.
- ▷ It is possible that only the phone book entries of the mobile phone or the SIM card are transferred.
- ▷ It may not be possible to display phone book entries with special characters.
- ▷ The number of phone book entries to be stored is too high.
- ▷ Is the amount of data for the contact too large, e.g., because of stored information such as addresses? Reduce the number of data entries.

The telephone connection quality is low.

- ▷ Depending on the mobile phone, it is possible to adjust the strength of the Bluetooth signal.
- ▷ Place mobile phone in the area of the center console.

If you have gone through all items in the list and still cannot activate the desired function please contact the Hotline or your MINI dealer.

OPERATION

Adjusting volume



Turn the knob until the desired volume is reached.

The setting is stored for the remote control currently in use.

Incoming call

Receiving calls

If the number of the caller is stored in the phone book and is transmitted by the network, then the name and number of the contact are displayed; otherwise, only the number is displayed.

If a contact is assigned more than one phone number, then only the name of the caller is transmitted.

Accepting a call

Press the  button on the steering wheel

or

 "Accept"

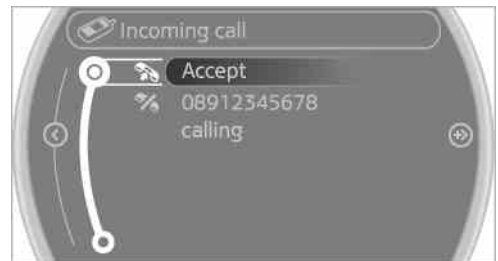

Rejecting a call

 "Reject"

The caller is redirected to the mailbox if it has been activated.

Ending a call

Press the  button on the steering wheel

or

1. "Telephone"
2.  "End call"

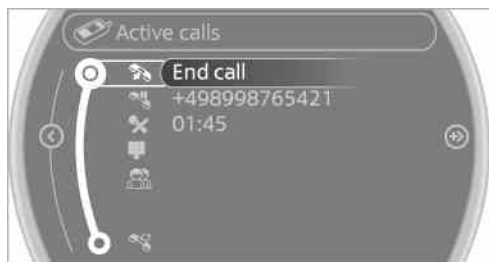

Entering phone numbers

Dialing a number

1. "Telephone"
2. "Dial number"
3. Select the digits individually.
4. Select the  symbol.



It is also possible to enter phone numbers by voice, page 177.

Calls with multiple parties

General information

It is possible to switch between two calls and to connect two calls to form a conference call. These functions must be supported by the mobile phone and by the service provider.

Accepting a call while speaking to another party

This function may have to be activated by the service provider and the mobile phone may need to be adjusted for this.

When a second call comes in during an ongoing call, a call-waiting signal sounds.

"Accept"

The call is accepted and the existing call is put on hold.

Establishing a second call

Establish another call during an active call.

1. "Telephone"
2. "Active calls"
3.  "Hold"

The existing call is put on hold.



4. Dial the new phone number or select it from a list.

"Return"

The conversation that was on hold is continued.

Switching between two calls, toggling

Active call: highlighted.

The call on hold is identified with: "on hold...".

Select the  symbol to switch to the call on hold.

Establishing a conference call

Two calls can be connected to a single telephone conference call.

1. Establish two calls.
2.  "Conference call"

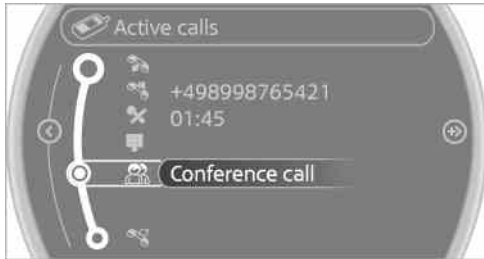

Both calls are always ended when a conference call is terminated. If one call is terminated by another party, the other call can be continued.

Keypad dialing

Use keypad dialing to gain access to network services or to control devices, e.g. to remotely access an answering machine. This requires the DTMF code.

1. "Telephone"
2. Select contact from a list or "Dial number"
3.  "Keypad dialing"

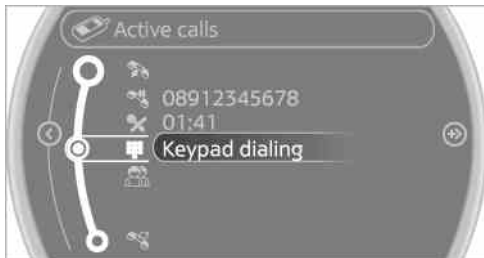

4. Enter the DTMF code via the onboard computer.

For a conference call in progress, DTMF dialing is not possible.

Phone book

Displays



The phone book accesses the contacts of the telephone and shows all contacts for which a phone number is entered. The entries can be selected to make a call.

1. "Telephone"
2. "Phone book"

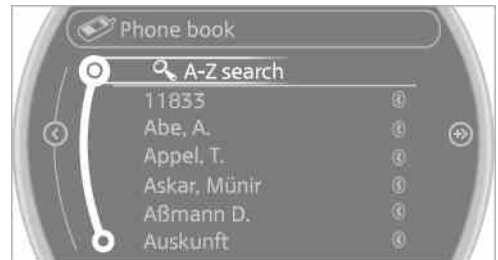
A symbol indicates the storage location of the contacts, refer to page 165.



Calling a contact

1. Select the desired contact.
Select the  symbol. Contact with one phone number. The connection is established.
2. Select the  symbol. Contact with more than one phone number. Select phone number, the connection is established.

 Call not possible, the mobile phone has no reception or network.

Editing a contact

Changing entries in the "Contacts" menu. If a contact is changed, the changes are not stored in the mobile phone. A copy of the entry is stored in the vehicle.

1. Highlight the contact.
2. Open "Options".
3. "Edit entry"

The contact can be edited.

Redialing

General information

The list of dialed numbers in the telephone are transferred to the vehicle, depending on the mobile phone. The last 20 phone numbers dialed are displayed. The sorting of the phone numbers depends on the mobile phone.

Selecting the number using the onboard computer

1. "Telephone"
2. "Redial"



3. Select the desired entry and phone number, if necessary.

The connection is established.

Deleting a single entry or all entries

Deleting entries depends upon the mobile phone.

1. Highlight the entry.
2. Open "Options".
3. "Delete entry" or "Delete list".

Saving an entry in the contacts

1. Highlight the entry.
2. Open "Options".
3. "Store as new contact" or "Add to existing contact".
4. Select the type of number: "Home", "Business", "Mobile" or "Other".
5. Complete the entries if necessary.
6. "Store contact" if necessary

Received calls

Displaying calls

The list of received calls in the telephone is transferred into the vehicle, depending on the mobile phone. The last 20 calls received are displayed. The sorting and displaying of phone numbers depends on the mobile phone.

1. "Telephone"
2. "Received calls"



Calling a number from the list

Select an entry.

The connection is established.

Deleting a single entry or all entries

Deleting entries depends upon the mobile phone.

1. Highlight the entry.
2. Open "Options".
3. "Delete entry" or "Delete list".

Saving an entry in the contacts

1. Highlight the entry.
2. Open "Options".
3. "Store as new contact" or "Add to existing contact".
4. Select the type of number: "Home", "Business", "Mobile" or "Other".
5. Complete the entries if necessary.
6. "Store contact" if necessary

Hands-free system

General information

Calls being conducted using the hands-free system can be continued using the mobile phone and vice versa.

From the mobile phone to the hands-free system

Calls that have been initiated from outside the Bluetooth range of the vehicle can be continued using the hands-free system if the ignition is switched on.

Depending on the mobile phone, the call is automatically switched to hands-free mode.

If the switch does not occur automatically, then follow the instructions that appear on the display of the mobile phone, also refer to the Owner's Manual for the mobile phone.

From hands-free system to mobile phone

Calls being conducted using the hands-free system can also be continued using the mobile phone if so desired, depending on the mobile phone.

At this point, follow the instructions that appear on the display of the mobile phone, also refer to the Owner's Manual for the mobile phone.

CONTACTS

General information

Contacts can be created and edited. The addresses can be used as destinations for navigation.

New contact

1. "Contacts"
2. "New contact"



3. If input boxes are already filled with previous entries: "Delete input fields"
4. To fill in the entry fields: select the symbol next to the entry field.



5. Input text, refer to page 21.

When equipped with a navigation system: Enter address. It is only possible to enter addresses that are contained in the navigation data stored in the vehicle. This ensures that route guidance is possible for all addresses.

6. "Store" if necessary
7. "Store contact in vehicle"

Defining a home address

It is possible to store a home address. It is listed at the beginning of the contacts.

1. "Home"
2. Create a contact.
3. "Store contact in vehicle"

My contacts

General information

Listing all contacts from the vehicle.

Displaying contacts

1. "Contacts"
2. "My contacts"

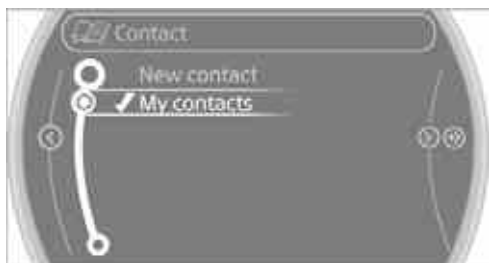

All contacts are listed in alphabetical order. Depending on the number of contacts, an A-Z search is offered.

A symbol indicates the storage location of the contacts:

Symbol	Storage location
No symbol	In the vehicle; the address has not been checked as a destination.
	In the vehicle; the address has been checked as a destination.
	Mobile phone

Editing a contact

1. Select the desired contact.
2. "Edit contact"



3. Change the entry.
4. Move the MINI joystick to the left.
5. "Yes"

If a contact that comes from the mobile phone is edited, the changes are not stored on the mobile phone. A copy of the entry is stored in the vehicle, and only this copy is displayed. Under certain conditions, an identical contact entry is generated.

Selecting a contact as a destination

1. Select the desired contact.
2. Select address.
3. "Start guidance" or "Add as another destination"

Checking the address as a destination

An address that is to be used in route guidance must correspond to the navigation data stored in the vehicle. The address can be checked to ensure this.

1. Select the desired contact and highlight the address.
2. Open "Options".
3. "Check as destination"
4. Correct and store the address, if necessary.

Selecting name sorting

Names can be displayed in different orders.

1. "My contacts"
2. Open "Options".
3. "Display: last, first name" or "Display: first, last name"

Depending on how the contacts were stored in the mobile phone, the sorting of names can differ from the sorting selected.

Deleting contacts

1. "My contacts"
2. Highlight the contact.
3. Open "Options".
4. "Delete contact" or "Delete all contacts".

MOBILE PHONE PREPARATION BLUETOOTH

VEHICLE EQUIPMENT

In this chapter, all production, country, and optional equipment that is offered in the model range is described. Equipment is also described that is not available because of, for example, selected options or country version. This also applies to safety related functions and systems.

OVERVIEW

The concept

Mobile phones or other external devices, e.g. audio players, can be connected to the vehicle via Bluetooth.

Bluetooth® is a registered trademark of Bluetooth® SIG, Inc.

After being paired once, when the ignition is switched on, these devices are automatically detected as soon as they are present in the vehicle and can be controlled via the onboard computer, the buttons on the steering wheel, and by voice.

Depending on whether they are functioning as a telephone and/or as an audio source, external devices can be used via the vehicle. The telephone functions will be described below. Operation of audio functions, refer to page 151.

It may be necessary for some functions to be activated by the mobile phone provider.



Only make entries when traffic conditions permit. Do not hold the mobile phone in your hand while you are driving; use the hands-free system instead. If you do not observe this precaution, your being distracted can endanger vehicle occupants and other road users. ◀

Snap-in adapter

The snap-in adapter, refer to page 179, makes it possible to:

- ▷ Accommodate the mobile phone.
- ▷ Recharge its battery.
- ▷ Connect it to an external antenna of the vehicle.

This assures a better network connection and constant sound quality.

A mobile phone that is connected to the vehicle should not be operated via the mobile phone keypad; otherwise, malfunctions may occur.

Suitable mobile phones

For precise information as to which mobile phones and external devices with Bluetooth interfaces are supported by the mobile phone preparation package, go to www.mini.com/ connectivity.

With a certain software version, these suitable mobile phones support the vehicle functions described below.

With other mobile phones or software versions, malfunctions may occur.

It is possible to perform a software update, refer to page 154.

Displaying vehicle identification number and software part number

Checking which mobile phones are supported by the mobile phone preparation requires the vehicle identification number and software part number. The software version of the mobile phone may also be required.

1. "Telephone"
2. Open "Options".
3. "Bluetooth® info"
4. "Display system information"

Notes

Do not expose your mobile phone to extreme ambient conditions, for example, very high temperatures; otherwise, functions on your mobile phone may not work. Follow the operating instructions for your mobile phone.

PAIRING/UNPAIRING MOBILE PHONE



Overview

- ▷ Using a mobile phone as a telephone.
- ▷ Using the mobile phone as an auxiliary phone.
- ▷ Using a mobile phone as an audio source.
- ▷ Using an audio device as an audio source, refer to page 151.

Functions supported by the mobile phone and audio device are displayed as symbols during the pairing.

White symbol: function active.

Gray symbol: function inactive.

Symbol	Function
	Telephone
	Auxiliary phone
	Audio source

Up to four external devices can be paired. Two devices can be connected to the vehicle at a time and used for different functions. The phone can be used to perform all of the following phone functions.

Requirements

- ▷ Suitable mobile phone, refer to page 168.
- ▷ Mobile phone operational.
- ▷ Bluetooth activated in vehicle, refer to page 169, and in the mobile phone.

- ▷ Bluetooth presets in the mobile phone are required, e.g. connection not confirmed or visible, refer to Owner's Manual for the mobile phone.
- ▷ If necessary, deactivate the audio connection, refer to page 170.
- ▷ A number with at least 4 and at most 16 digits has been established as the Bluetooth passkey. Only required once for pairing.
- ▷ Ignition switched on.

Activating/deactivating Bluetooth link

Bluetooth is not permitted everywhere. Comply with all safety guidelines and regulations.

1. "Telephone"
2. Open "Options".
3. "Bluetooth®"

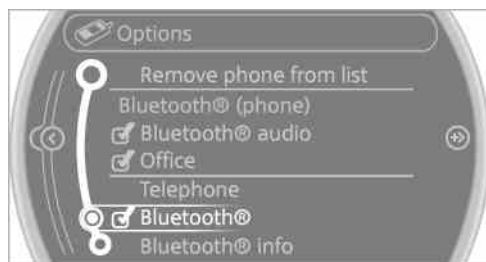

Activating/deactivating additional functions

To use these functions in the vehicle, activate them before pairing. For information on suitable mobile phones that support this function, refer to page 168.

1. "Telephone"
2. "Bluetooth® (phone)"
3. Open "Options".
4. "Configure Bluetooth®"
5. Select desired additional function.

Bluetooth audio

Use a mobile phone as a telephone and as an audio device in the vehicle.

"Bluetooth® audio"

To use a mobile phone exclusively as a telephone in the vehicle, deactivate the function and reconnect the mobile phone.

Office

Contacts, appointments, tasks, notes, text messages, and e-mails are imported from the mobile phone into the vehicle.

"Office"

Auxiliary phone

Another mobile phone can be used as an auxiliary phone.

"Additional telephone"

Incoming calls to the auxiliary phone can be accepted, refer to page 173. Missed calls to the auxiliary phone are shown in the Control Display.

Pairing and connecting



Only pair the mobile phone when the vehicle is stopped; otherwise, inattention may lead to endangerment of passengers or other road users. ◀

1. "Telephone"
2. "Bluetooth® (phone)"
3. "Add new phone"

The Bluetooth name of the vehicle is displayed.



4. To perform other operations on the mobile phone, refer to the Owner's Manual for the mobile phone: e.g. search for and connect Bluetooth device or a new device.

The Bluetooth name of the vehicle appears on the mobile phone display.

5. Select the Bluetooth name of the vehicle on the mobile phone display.
6. The onboard computer or the mobile phone will prompt you to enter the same Bluetooth passkey.

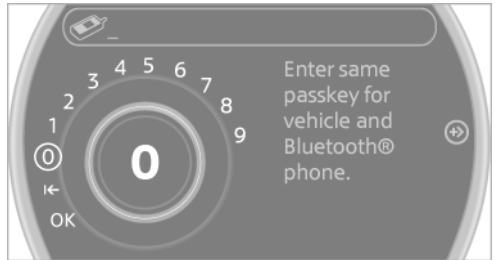

Enter the passkey and confirm.

or

Compare the control number on the vehicle display with the control number on the mobile phone display. Confirm the control number in the mobile phone and in the vehicle.

"OK"

7. Select the functions that are to be used for the mobile phone.



8. "OK"
9. Move the MINI joystick to the left.

If pairing was successful, the mobile phone appears at the top of the list of mobile phones.

If the pairing was not successful: what to do if..., refer to page 172.

Following the initial pairing

- ▷ The mobile phone is detected/connected in the vehicle within a short period of time when the engine is running or radio readiness is switched on.
- ▷ After identification, phone book entries are imported from the mobile phone and/or SIM card of the telephone, depending on the telephone.
- ▷ Specific settings may be necessary in some mobile phones, e.g. authorization or a secure connection, refer to the Owner's Manual for the mobile phone.

Connecting a particular mobile phone

1. "Telephone"
2. "Bluetooth® (phone)"
All paired mobile phones are listed.
3. Select the mobile phone to be connected.



The assigned functions before the unpairing of the mobile phone are assigned to the mobile phone when it is reconnected. If a mobile phone is already connected, then these functions are deactivated if necessary.

Device options

Device options in devices that are paired and connected can be activated or deactivated.

Configuring device

1. "Telephone"
2. "Bluetooth® (phone)"
3. Highlight the device to be configured.
4. Open "Options".
5. "Configure phone"



6. Activate/deactivate functions. At least one function must be selected.
 - ▷ "Telephone"
 - ▷ "Additional telephone"
 - ▷ "Audio"
7. "OK"

If a device is assigned a function, this may deactivate the function in an already connected device and cause the other device to be unpaired.

Exchanging the telephone and auxiliary phone

If the telephone and auxiliary phone are connected to the vehicle, the function can be swapped between the two devices.

1. "Telephone"
2. "Bluetooth® (phone)"
3. "Swap phone/addit. phone"

Using the mobile phone as an audio source

Using the audio-capable mobile phone as an audio source. Activate Bluetooth audio, refer to page 170.

Activate and connect the mobile phone in vehicle, refer to page 170.

The mobile phone is used as an audio source if no other device is connected as an audio source.

If a device is already connected as an audio source:

1. Activate and connect the mobile phone in vehicle, refer to page 170.

2. "Use for audio"

The mobile phone is connected as an audio source. The previous audio source is no longer connected to the vehicle.

Unpairing device

1. "Telephone"
2. "Bluetooth® (phone)"
All paired mobile phones are listed.
3. Highlight the device to be unpaired.
4. Open "Options".
5. "Remove phone from list"



What to do if...

For information on suitable mobile phones, refer to page 168.

The mobile phone could not be paired or connected.

- ▷ Is Bluetooth activated in the vehicle and in the mobile phone? Activate Bluetooth in the vehicle and in the mobile phone.
- ▷ Do the Bluetooth passkeys on the mobile phone and the vehicle match? Enter the same passkey on the mobile phone and via the onboard computer.

- ▷ Is the passkey input taking longer than 30 seconds? Repeat the pairing procedure.
- ▷ Are too many Bluetooth devices connected to the mobile phone? If so, delete the connections with other devices on the mobile phone.
- ▷ Is the audio connection activated? Deactivate the audio connection.
- ▷ Is the mobile phone in power economy mode or does it only have a small amount of battery charge remaining? Charge the mobile phone in the snap-in adapter or via a charging cable.
- ▷ Depending on the mobile phone, it may only be possible to connect one device to the vehicle. Unpair the connected device from the vehicle and only pair and connect one device.
- ▷ Telephone functions not possible.
- ▷ Is the mobile phone paired as an auxiliary phone and is the auxiliary phone function deactivated? Activate the function.
- ▷ Outgoing call not possible? Connect the mobile phone as a telephone.

Is the mobile phone no longer responding?

- ▷ Switch the mobile phone off and back on again. Repeat the pairing procedure.
- ▷ Is the ambient temperature too high or too low? Do not subject your mobile phone to extreme ambient temperatures.

Phone book entries are not displayed, not all of them are displayed, or they are displayed incompletely.

- ▷ The transfer of phone book entries has not yet completed.
- ▷ It is possible that only the phone book entries of the mobile phone or the SIM card are transferred.
- ▷ It may not be possible to display phone book entries with special characters.
- ▷ The number of phone book entries to be stored is too high.

- ▷ The data volume of the phone book entry is too great, e.g. due to additionally stored information such as notes? Reduce the data volume.
- ▷ Is the mobile phone connected as an audio source or auxiliary phone? The mobile phone must be connected as a telephone.

The telephone connection quality is low.

- ▷ Depending on the mobile phone, it is possible to adjust the strength of the Bluetooth signal.
- ▷ Insert the mobile phone into the snap-in adapter or place it in the vicinity of the center console.
- ▷ Adjust the volume of the microphone and speaker separately.

If you have gone through all items in the list and still cannot activate the desired function please contact the Hotline or your MINI dealer.

OPERATION

Adjusting volume



Turn the knob until the desired volume is reached.

The setting is stored for the remote control currently in use.

The vehicle automatically adjusts the volume of the microphone on the mobile phone and the volume of the person on the phone with you. Depending on the mobile phone, it may be necessary to adjust the volumes.

Adjustments are only possible during a call and must be carried out separately for each phone. When the telephone is unpaired, this deletes the settings.

1. "Settings"
2. "Tone"
3. "Volume settings"
4. To select the desired setting: "Microphone" or "Loudspeak."
5. To adjust: turn the MINI joystick.
6. To store: press the MINI joystick.

Incoming call

Receiving calls

If the number of the caller is stored in the phone book and is transmitted by the network, then the name and number of the contact are displayed; otherwise, only the number is displayed.

If a contact is assigned more than one phone number, then only the name of the caller is transmitted.

With calls to the auxiliary phone, only the number is displayed if it is transmitted by the network.

An incoming call on a phone will be rejected automatically when a call is active on the other phone.

Accepting a call

Press the  button on the steering wheel

or  "Accept"

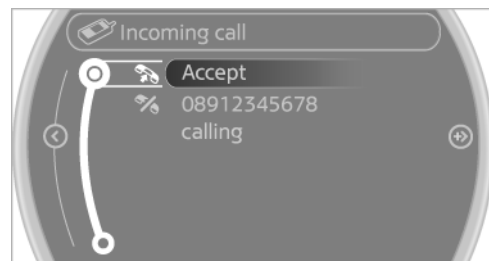

Rejecting a call

"Reject"

The caller is redirected to the mailbox if it has been activated.

Ending a call

Press the  button on the steering wheel

or

1. "Telephone"
2.  "End call"

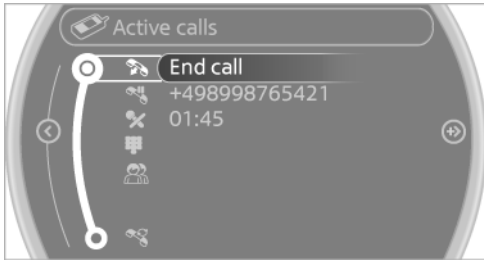

Entering phone numbers

Dialing a number

1. "Telephone"
2. "Dial number"
3. Select the digits individually.
4. Select the  symbol.



It is also possible to enter phone numbers by voice.

Calls with multiple parties

General information

It is possible to switch between two calls and to connect two calls to form a conference call. These functions must be supported by the mobile phone and by the service provider.

Accepting a call while speaking to another party

This function may have to be activated by the service provider and the mobile phone may need to be adjusted for this.

When a second call comes in during an ongoing call, a call-waiting signal sounds.

"Accept"

The call is accepted and the existing call is put on hold.

Establishing a second call

Establish another call during an active call.

1. "Telephone"
2. "Active calls"
3.  "Hold"

The existing call is put on hold.



4. Dial the new phone number or select it from a list.

Switching between two calls, toggling

Active call: highlighted.

The call on hold is identified with: "on hold...".

Select the  symbol to switch to the call on hold.

Establishing a conference call

Two calls can be connected to a single telephone conference call.

1. Establish two calls.
2.  "Conference call"

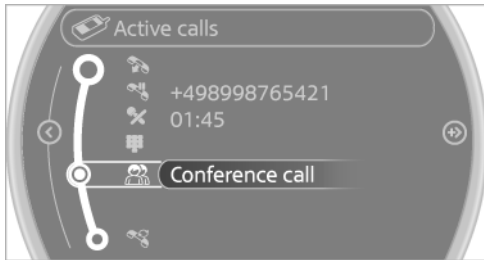

Both calls are always ended when a conference call is terminated. If one call is terminated by another party, the other call can be continued.

Muting the microphone

The microphone can be muted in active calls.

1. "Telephone"
2. "Active calls"
3.  "Microphone mute"



The muted microphone is automatically activated:

- ▷ If a new call is made.
- ▷ When switching between callers on hold.

Keypad dialing

Use keypad dialing to gain access to network services or to control devices, e.g. to remotely access an answering machine. This requires the DTMF code.

1. "Telephone"
2. Select contact from a list or "Dial number"
3.  "Keypad dialing"

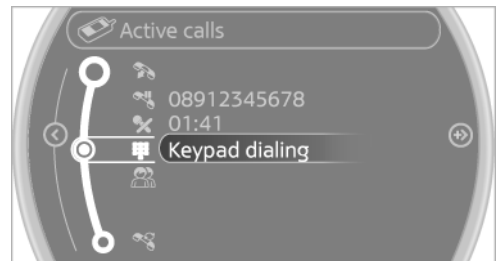

4. Enter the DTMF code via the onboard computer.

Phone book

Displays



The phone book accesses the contacts of the telephone and shows all contacts for which a phone number is entered. The entries can be selected to make a call.

1. "Telephone"
2. "Phone book"

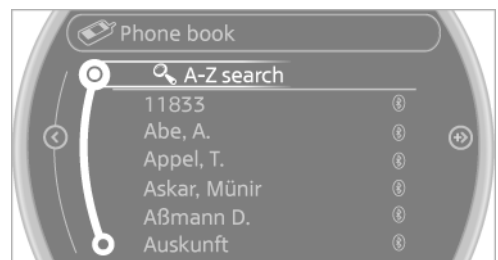
A symbol indicates the storage location of the contacts, refer to page 182.



Calling a contact

1. Select the desired contact.
Select the  symbol. Contact with one phone number. The connection is established.
2. Select the  symbol. Contact with more than one phone number. Select phone number, the connection is established.

 Call not possible, the mobile phone has no reception or network.

Editing a contact

Changing entries in the "Contacts" menu. If a contact is changed, the changes are not stored in the mobile phone. A copy of the entry is stored in the vehicle.

1. Highlight the contact.
2. Open "Options".
3. "Edit entry"

The contact can be edited.

Redialing

General information

The list of dialed numbers in the telephone are transferred to the vehicle, depending on the mobile phone. The last 20 phone numbers dialed are displayed. The sorting of the phone numbers depends on the mobile phone.

Selecting the number using the onboard computer

1. "Telephone"
2. "Redial"

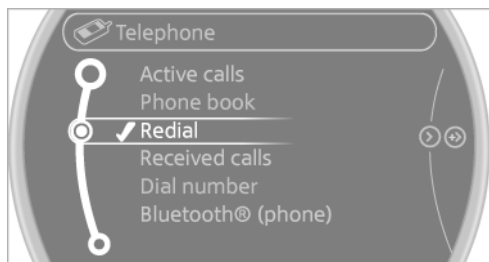

3. Select the desired entry and phone number, if necessary.

The connection is established.

Deleting a single entry or all entries

Deleting entries depends upon the mobile phone.

1. Highlight the entry.
2. Open "Options".
3. "Delete entry" or "Delete list".

Saving an entry in the contacts

1. Highlight the entry.
2. Open "Options".
3. "Store as new contact" or "Add to existing contact".
4. Select the type of number: "Home", "Business", "Mobile" or "Other".
5. Complete the entries if necessary.
6. "Store contact" if necessary

Received calls

Displaying calls

The list of received calls in the telephone is transferred into the vehicle, depending on the mobile phone. The last 20 calls received are displayed. The sorting and displaying of phone numbers depends on the mobile phone.

1. "Telephone"
2. "Received calls"

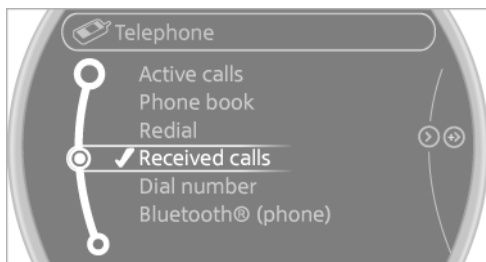

Calling a number from the list

Select an entry.

The connection is established.

Deleting a single entry or all entries

Deleting entries depends upon the mobile phone.

1. Highlight the entry.
2. Open "Options".
3. "Delete entry" or "Delete list".

Saving an entry in the contacts

1. Highlight the entry.
2. Open "Options".
3. "Store as new contact" or "Add to existing contact".
4. Select the type of number: "Home", "Business", "Mobile" or "Other".
5. Complete the entries if necessary.
6. "Store contact" if necessary

Hands-free system

General information

Calls being conducted using the hands-free system can be continued using the mobile phone and vice versa.

From the mobile phone to the hands-free system

Calls that have been initiated from outside the Bluetooth range of the vehicle can be continued using the hands-free system if the ignition is switched on.

Depending on the mobile phone, the call is automatically switched to hands-free mode.

If the switch does not occur automatically, then follow the instructions that appear on the display of the mobile phone, also refer to the Owner's Manual for the mobile phone.

From hands-free system to mobile phone

Calls being conducted using the hands-free system can also be continued using the mobile phone if so desired, depending on the mobile phone.

At this point, follow the instructions that appear on the display of the mobile phone, also refer to the Owner's Manual for the mobile phone.

OPERATION BY VOICE

Equipped with voice activation system: operation, refer to page 22. For the list with the short commands, refer to page 247, does not apply for this type of voice operation.

Equipped without voice activation system: Depending upon the equipment, the mobile phone can be voice-operated as described below.

The concept

- ▷ The mobile phone can be operated without removing your hand from the steering wheel.
- ▷ In many cases, the entry process is supported by means of announcements or questions.
- ▷ ›...‹ Verbal instructions to use with the voice operation system.
- ▷ ››...‹‹ Identifies the answers generated by the voice operation system.

Voice commands

Activating voice activation system

1. Briefly press the  button on the steering wheel.
2. Say the command.

Finishing voice input

Press the  button on the steering wheel briefly
or

 ›Cancel‹.

Possible commands

Having possible commands read aloud

Press the  button on the steering wheel.

 ›Help‹.

Possible commands are read aloud.

Each digit can be spoken individually or combined into a sequence to accelerate the entry process.

Using alternative commands

There are often a number of commands to run a function, e.g.:

 ›Dial name‹ or ›Name‹.

Example: dialing phone numbers

1. Briefly press the  button on the steering wheel.
2. ›Dial number‹
3. The system replies: ››Please say the number.‹‹
4. For example: ›123 456 7890‹
5. The system replies: ››123 456 7890. Continue?‹‹
6. ›Dial‹
System replies: ››Dialing number.‹‹

Calling

Dialing phone numbers

-  1. ›Dial number‹.
2. Say the phone number.
3. ›Dial‹.

The connection to the desired subscriber is established.

Correcting phone number

Digit sequences can be deleted after the system has repeated the digits.

 ›Correct number‹.

The command can be repeated as often as necessary.

Deleting phone number

 ›Delete‹.

All digits entered up to this point are deleted.

Redialing

 ›Redial‹.

Voice phone book

Depending on how your vehicle is equipped, it may be necessary to create your own voice phone book.

The entries must be entered by voice and are independent of the mobile phone's memory. Up to 50 entries can be set up.

Storing the entry

-  1. ›Save name‹.
2. Say the name aloud. Do not exceed a speaking duration of about 2 seconds.
3. Say the phone number after being prompted to do so by the system.
4. ›Save‹.

Deleting the entry

-  1. ›Delete name‹.
2. Say the name when prompted.
3. Confirm prompt with ›Yes‹.

Deleting all entries

-  1. ›Delete phonebook‹.
The dialog for deleting phone book is opened.
2. Confirm prompt with ›Yes‹.
3. Confirm repeated prompt with ›Yes‹.

Reading and selecting the entries

1. ›Read phonebook‹.
The dialog for reading phone book is opened.
2. ›Dial number‹ when the desired entry is read aloud.

Selecting an entry

1. ›Dial name‹.
2. Say the name when prompted.
3. Confirm prompt with ›Yes‹.

Adjusting volume

Turn knob during announcement.

- ▷ The volume remains the same, even if the volume of other audio sources is changed.
- ▷ The volume is stored for the remote control currently in use.

Notes

Do not use the voice operation system to initiate an emergency call. In stressful situations, the voice and vocal pitch can change. This can unnecessarily delay the establishment of a telephone connection.

Ambient conditions

- ▷ Say the commands, numbers and letters smoothly and with normal volume, emphasis and speed.
- ▷ Always say the commands in the language of the system. The language for voice operation system is preset and can not be changed via the Control Display.
- ▷ Keep doors, windows, glass sunroof/panoramic sunroof, or convertible top closed to avoid noise interference.
- ▷ Avoid ambient noise in the vehicle while speaking.

SNAP-IN ADAPTER

General information

Detailed information on snap-in adapters that compatibly support mobile phone functions can be found at your MINI dealer.

Do not expose your mobile phone to extreme ambient conditions, for example, very high temperatures; otherwise, functions on your mobile phone may not work. Follow the operating instructions for your mobile phone.

Installation location

In the center armrest.

Inserting snap-in adapter

1. Press the button and remove the cover.

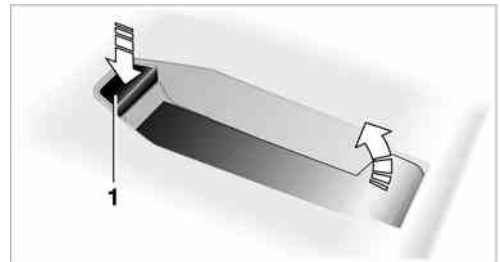

2. Insert the snap-in adapter at the front, arrow 1, and press downward, arrow 2, until it clicks into place.



Inserting mobile phone

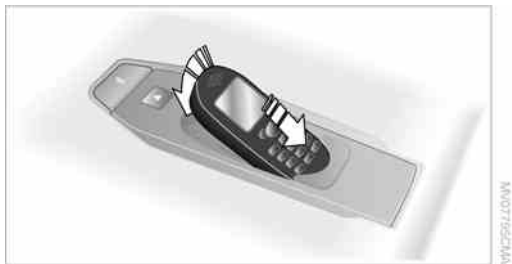

1. Depending on the mobile phone, it may be necessary to remove the protective cap of the antenna connector and from the USB connection of the mobile phone.
2. Push the mobile phone with the buttons facing upward toward the electrical connections and press down until it engages.

Removing mobile phone

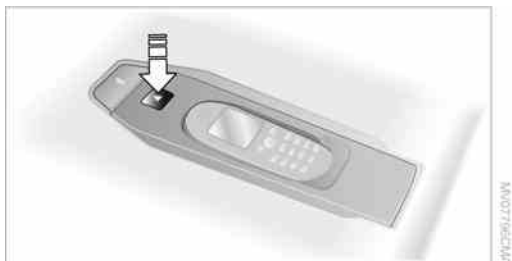

Press the button and remove the mobile phone.

OFFICE

VEHICLE EQUIPMENT

In this chapter, all production, country, and optional equipment that is offered in the model range is described. Equipment is also described that is not available because of, for example, selected options or country version. This also applies to safety related functions and systems.

OVERVIEW

General information

Contacts, appointments, tasks, notes, text messages and mobile phone e-mails can be displayed using the Control Display if the mobile phone compatibly supports these functions and the required Bluetooth radio standards.

For information about which mobile phones and functions are available, go to www.mini.com/connectivity.

A limited number of compatible mobile phones are available for Office.

Contents are only displayed completely when the vehicle is stopped.

Only read access to the mobile phone is possible.

 Do not use Office while driving. Make entries only when traffic and road conditions permit; otherwise, you may endanger vehicle occupants and other road users by being distracted. ◀

Requirements

- ▷ A suitable mobile phone is paired with the vehicle and connected. In some mobile phones, the data access to the mobile phone must be confirmed.
- ▷ Time zones, time, and date, refer to page 64, are correctly adjusted on the Control Display and on the mobile phone in

order, for example, to correctly display appointments.

Updating

Every time that the mobile phone is connected to the vehicle, data are updated. Appointments, tasks, notes and reminders can be updated separately.

1. "Office"
2. "Current office", "Calendar", "Tasks", "Notes" or "Reminders"
3. Open "Options".
4. "Update data"

Data from the mobile phone are again transferred to the vehicle.

CURRENT OFFICE

The number of unread messages and active tasks as well as upcoming appointments are displayed.

1. "Office"
2. "Current office"
3. Select the desired entry to display details.

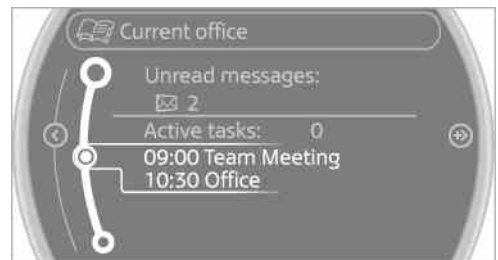

CONTACTS

General information

Contacts can be created and edited. The contacts from the mobile phone are displayed as well if this function is supported by the mobile phone. The addresses can be used as destinations for navigation and the phone numbers can be dialed.

Displaying contacts

1. "Office"
2. "Contacts"

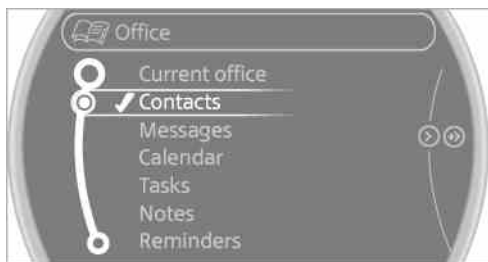

All contacts are listed in alphabetical order. Depending on the number of contacts, an A-Z search is offered.

A symbol indicates the storage location of the contacts:

Symbol	Storage location
No symbol	In the vehicle; the address has not been checked as a destination.
	In the vehicle; the address has been checked as a destination.
	Mobile phone

Dialing phone numbers

1. Select the desired contact.
2. Select phone number.

The connection is established.

Editing a contact

1. Select the desired contact.
2. "Edit contact"

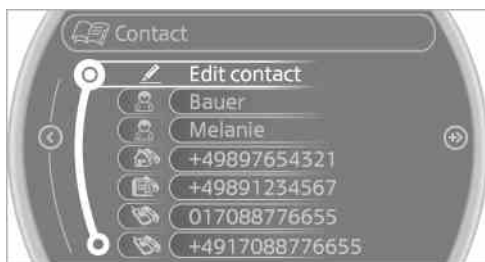

3. Change the entry.
4. "Store contact in vehicle"

If a contact is changed, the changes are not stored in the mobile phone. A copy of the entry is stored in the vehicle, and only this copy is displayed.

Selecting a contact as a destination

1. Select the desired contact.
2. Select address.

With contacts from the mobile phone, the address must be compared with the navigation data stored in the vehicle. In this case:

Correct the address.



3. "Start guidance" or "Add as another destination"

Checking the address as a destination

An address that is to be used in route guidance must correspond to the navigation data stored in the vehicle. The address can be checked to ensure this.

1. Select the desired contact and highlight the address.
2. Open "Options".
3. "Check as destination"
4. Correct and store the address, if necessary.

If the address is corrected and stored, a copy of it is stored in the vehicle. The address is not changed on the mobile phone.

New contact

A contact can be associated with up to 8 phone numbers, 2 addresses, 3 e-mail addresses, and one Internet address.

1. "Office"
2. "Contacts"
3. Open "Options".
4. "New contact"









5. If input boxes are already filled with previous entries: "Delete input fields"
6. To fill in the entry fields: select the symbol next to the entry field.
7. Enter text and assign a contact type, refer to page 183.
8. When equipped with a navigation system: Enter address. It is only possible to enter addresses that are contained in the navigation data stored in the vehicle. This ensures

that route guidance is possible for all addresses.

9. "Accept address" if necessary
10. "Store contact in vehicle"

Contact types

Phone numbers and addresses can be assigned various contact types.

Symbol	Meaning
	Private phone number
	Business phone number
	Mobile phone number
	Other phone number
	Private address
	Business address

Defining a home address

It is possible to store a home address. It is listed at the beginning of the contacts.

1. "Home"
2. Create a contact.
3. "Store contact in vehicle"

Selecting name sorting

Names can be displayed in different orders.

1. "Office"
2. "Contacts"
3. Open "Options".
4. "Display: last, first name" or "Display: first, last name"

Depending on how the contacts were stored in the mobile phone, the sorting of names can differ from the sorting selected.

Displaying contact pictures

Pictures stored with contacts are stored in the vehicle when the mobile phone is connected to the vehicle. The number of pictures transmitted depends on the mobile phone. The mobile phone must support this function.

1. "Office"
2. "Contacts"
3. Open "Options".
4. "Configure Bluetooth®"
5. "Show images"

The display of all contact pictures is activated or deactivated.

Deleting contacts

Only contacts that are stored in the vehicle are deleted. The contacts on the mobile phone cannot be deleted.

1. "Office"
2. "Contacts"
3. Highlight the contact.
4. "Options"
5. "Delete contact" or "Delete all contacts".

MESSAGES

General information



The displaying of text messages and e-mails depends on whether the mobile phone supports transmission to the vehicle. Text messages and e-mails may not be supported by the service provider or the function may have to be separately activated. After a mobile phone is paired for the first time, the transmission may take several minutes. Messages are only displayed completely when the vehicle is stopped. Messages from the auxiliary phone are not transmitted.



Displaying messages

1. "Office"
2. "Messages"

Message type

A symbol indicates the type of message.

-  Read message.
-  Unread message.

Symbol	Message type
	Text message
	E-mail from mobile phone



Filtering message lists

A message list can be filtered if there is more than one message type.

1. "Filter:"
2. Select message type.
 - ▷ "All"
All messages are displayed.
 - ▷ "Text message"
Only text messages from mobile phones are displayed.
 - ▷ "E-mail"
Only text messages from mobile phones are displayed.

Text message

Calling a text message sender

1.  Select the desired message.
2.  Select the symbol.

Saving sender in the contacts

1. Highlight the desired message.
2. Open "Options".
3. "Store as new contact" or "Add to existing contact"

Using contact data

Contact data from deadlines, tasks, text messages, e-mails and notes can be stored or selected, see page 187.

Reading text messages aloud

Reading text messages aloud, refer to page 187.

E-mail

Displaying e-mail

1. "Office"
2. "Messages"
3.  Select the desired message.

Displaying e-mail contacts

If the sender and receiver of an e-mail were transmitted from a mobile phone, they will be displayed in the e-mail.

"Sender/Recipient"

If the e-mail address is stored in the contacts, then the contact is displayed. Select contact to display details.

If the e-mail address is not stored in the contacts, then it may be that only the e-mail address is displayed.

Using contact data

Contact data from deadlines, tasks, text messages, e-mails and notes can be stored or selected, see page 187.

Deactivating entire display

When opening an e-mail when in the vehicle, it is completely transferred to the vehicle. This may result in charges.

1. "Office"
2. "Messages"
3. Open "Options".
4. "Fully download e-mails"

Only a part of an e-mail from a mobile phone is loaded into the vehicle.

Reading e-mail

Reading e-mail, see page 187.

CALENDAR

Displaying calendar

Appointments from the last 20 days and the next 50 days can be displayed.

1. "Office"
2. "Calendar"

Appointments of the current day are displayed.

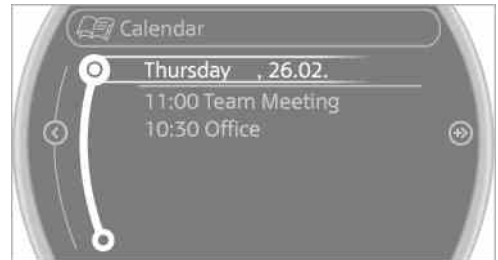

Selecting calendar day

1. Select date.



2. Select desired day or date.
 - ▷ "Next day"
 - ▷ "Date:"
 - ▷ "Previous day"
 - ▷ "Today"

Displaying appointment

1. Select the desired appointment.
2. To scroll through appointment, if necessary:
 - ▷ Turn the MINI joystick.
 - ▷ Select the   symbol.

Using contact data

Contact data from deadlines, tasks, text messages, e-mails and notes can be stored or selected, see page 187.

Reading an appointment aloud

Reading an appointment aloud, refer to page 187.

TASKS

Displaying task list

Display open tasks that must be completed within the next 90 days.

1. "Office"
2. "Tasks"

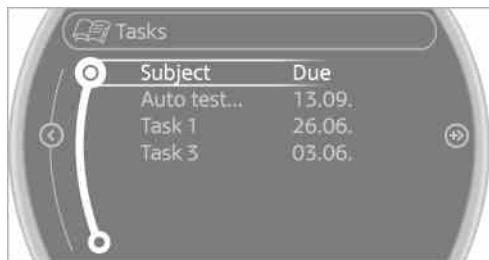

Sorting task list

1. Select the top line in the task list.



2. To select sorting criterion:
 - ▷ "Priority (!)"
 - ▷ "Subject"
 - ▷ "Due date"

Displaying task

1. Select the desired task.
2. To scroll through the task, if necessary:
 - ▷ Turn the MINI joystick.
 - ▷ Select the   symbol.

Using contact data

Contact data from deadlines, tasks, text messages, e-mails and notes can be stored or selected, see page 187.

Reading a task aloud

Reading a task aloud, refer to page 187.

NOTES



Displaying notes

1. "Office"
2. "Notes"
 - All notes are displayed.

Displaying a note

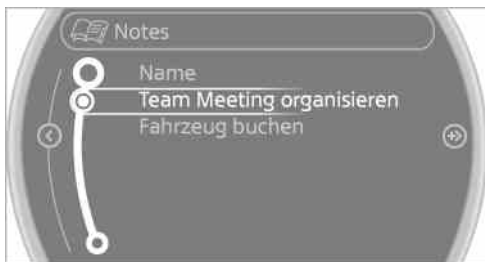
1. Select the desired note.



2. To scroll through the note, if necessary:
 - ▷ Turn the MINI joystick.
 - ▷ Select the   symbol.

Using contact data

Contact data from deadlines, tasks, text messages, e-mails and notes can be stored or selected, see page 187.

Reading a note aloud

Reading a note aloud, refer to page 187.

REMINDERS

Displaying reminders

Reminders for imminent appointments and tasks are displayed. After an appointment has passed or a task is due, the reminder is deleted.

1. "Office"
2. "Reminders"
3. Select the desired reminder.
 - The associated appointment or task is displayed.

USING CONTACT DATA

Overview

Contact data from deadlines, tasks, text messages, e-mails and notes can be stored or selected.

To display a contact or dial a phone number

1.  "Use contact data"

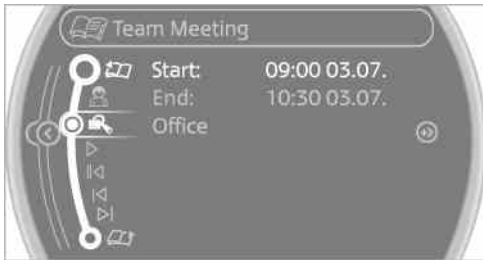

2. To display a contact or dial a phone number:
 - ▶ Select a contact to display a detailed view of the contact.
 - ▶ Select a phone number to directly establish a connection.

Storing contact data





1.  "Use contact data"
2. Highlight a phone number or e-mail address.
3. Open "Options".
4. "Add to existing contact" or "Store as new contact"

READING ALOUD

Text messages, e-mails, appointment entries, tasks, and notes can be read aloud to you.

1. Select the desired message, appointment, task, or note.
2. Select the  symbol.

While the message is being read aloud, you have the following options:

- ▶  "Pause"
Interrupt the reading. Select again to resume the reading.
- ▶  "Back to beginning"
Read message again from the beginning.
- ▶ Select the  symbol.
Skip back one paragraph.
- ▶ Select the  symbol.
Skip over a paragraph.
- ▶ To terminate the reading, move the MINI joystick to the left.

WHAT TO DO IF...

For information on suitable mobile phones, refer to page 168.

- ▶ Appointments, tasks, notes, or text messages are not being displayed?

The mobile phone is not suitable for the missing function or is not correctly connected.

The mobile phone is connected as an auxiliary phone.

The Office function is deactivated.

The appointments are older than 20 days and are more than 50 days in the future.

The tasks have been marked as completed or are more than 90 days in the future.

Depending on the number of appointments, tasks, notes, and messages stored in the mobile phone, not all of them are displayed in the vehicle.

- ▶ Appointments or tasks from the mobile phone are not being displayed at the correct time?

The time zone, time, or date is incorrectly set in the Control Display and in the mobile phone.

- ▷ Texts of entries are not displayed completely?
Texts are already shortened by the mobile phone.
Synchronization between the mobile phone and vehicle can take a few minutes.
- ▷ Contact pictures are not being displayed?
Up to max. 200 contact pictures can be stored in the vehicle.
- ▷ If you have gone through all items in the list and still cannot activate the desired function please contact the Hotline or your MINI dealer.

MINI CONNECTED

VEHICLE EQUIPMENT

In this chapter, all production, country, and optional equipment that is offered in the model range is described. Equipment is also described that is not available because of, for example, selected options or country version. This also applies to safety related functions and systems.

OVERVIEW

The concept

You can use MINI Connected to integrate certain software applications of a suitable mobile phone into your MINI. These software applications are displayed on the Control Display. They are operated using the MINI joystick.

The range of software applications can be country-specific.

Requirements

The following requirements must be met for the function of MINI Connected:

- ▷ The operating system of the mobile phone must support the software applications of MINI Connected.
- ▷ The software applications are installed on the mobile phone and are operational.
- ▷ Suitable mobile phone.
- ▷ Appropriate mobile phone contract.

Possible additional costs incurred are not included with MINI Connected.

 Only make entries when the traffic situation allows you to do so. If you do not observe this precaution, your being distracted can endanger vehicle occupants and other road users.

For safety reasons, some software applications can only be used when the vehicle is stopped. ◀



Only use software applications approved by the manufacturer of your MINI; otherwise, malfunctions may result. ◀

Notes

For information on suitable mobile phones, available software applications, and their installation:

- ▷ At: www.mini.com/connectivity
- ▷ At your MINI dealer.

CONNECTING A MOBILE PHONE

Connecting via the USB audio interface



- 1 USB interface
- 2 Connection for audio/video playback: TRS connector 1/8"/3.5 mm

Connect the mobile phone using the special connecting cable, available at your MINI dealer, to the USB interface **1** and the AV-IN connection **2**.

To perform other operations on the mobile phone, refer to the Owner's Manual for the mobile phone: e.g. selecting and activating a software application.

Connecting via the snap-in adapter

The mobile phone can also be connected using the snap-in adapter, refer to page 179.

USING MINI CONNECTED

After successful connection of the mobile phone to the vehicle and activation of MINI Connected, the applications are displayed on the Control Display and can be operated using the MINI joystick.

Volume adjustments can be made using the buttons on the steering wheel, refer to page 10, or using the volume control knob on the radio, refer to page 135.

1. Press the  button.
This opens the main menu.
2. "MINI Connected"



3. Select the desired software application.

The extent of MINI Connected that is shown on the Control Display depends on the range of installed software applications on the mobile phone.

 The data transfer of the software application from the telephone to the vehicle can take a few minutes. Some software applications depend on the speed of the available Internet connection for the mobile phone. ◀

Certain versions of mobile phones used and their software can make it impossible to use MINI Connected and the Bluetooth hands-free system at the same time.

After a phone call, it may be necessary to restart the software application on the mobile phone.

PlugIn

Selected functions for an Apple device are shown on the Control Display. Operation takes place using the onboard computer.

1. Connecting an Apple device over a USB audio interface, refer to page 189.
2. "MINI Connected"
3. "PlugIn"
4. "Activate PlugIn"
5. Navigate among the functions shown via a MINI joystick and, e.g., select a desired category or track.

Press the  button to return back or to change to a level higher within the functions of the Apple device.

Press the  button twice to return back to the main menu.

Additional information can be found in the MINI Connected Owner's Manual at www.mini.com/connectivity.

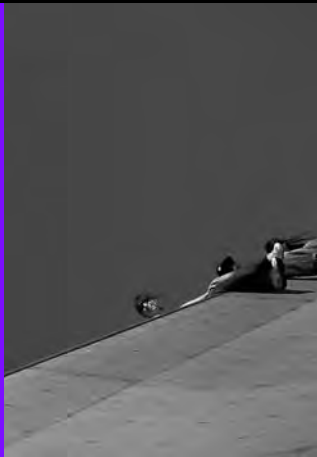
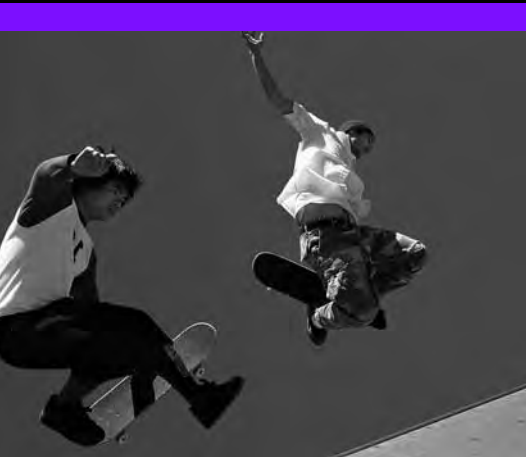

MOVE ME.

AT A GLANCE

CONTROLS

DRIVING TIPS

NAVIGATION

ENTERTAINMENT

COMMUNICATIONS

MOBILITY

REFERENCE

REFUELING

VEHICLE EQUIPMENT

In this chapter, all production, country, and optional equipment that is offered in the model range is described. Equipment is also described that is not available because of, for example, selected options or country version. This also applies to safety related functions and systems.

GENERAL

 Switch off the engine before refueling; otherwise, fuel cannot be added to the tank and a message will be displayed. ◀

 Take all precautionary measures and observe all applicable regulations when handling fuel. Do not carry any spare fuel containers in your vehicle. They can develop a leak and cause an explosion or cause a fire in the event of an accident. ◀

FUEL FILLER FLAP

Opening

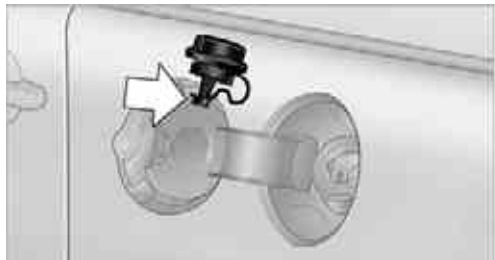

1. Open the fuel filler flap.
2. Turn the fuel cap counterclockwise.
3. Place the fuel cap in the bracket attached to the fuel filler flap.

Closing

Fit the cap and turn it clockwise until you clearly hear a click.

 Do not pinch the band attached to the cap; otherwise, the cap cannot be closed properly and fuel vapors can escape. A message will be displayed if the fuel cap is loose or missing. ◀

Manually releasing the fuel filler flap

In the event of an electrical malfunction, you can manually release the fuel filler flap:

MINI:

1. Remove the cover from the left-hand side-wall of the cargo area.

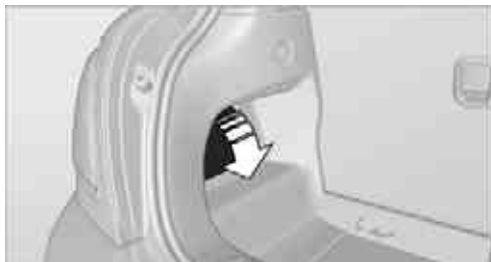

2. Pull on the green knob with the fuel pump symbol. The fuel filler flap is released.



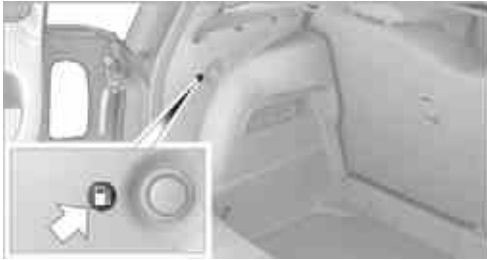

MINI Clubman:



Pull on the green knob with the fuel pump symbol; the fuel filler flap opens.

Observe the following when refueling

 Take all precautionary measures and observe all applicable regulations when handling fuel; otherwise, there is a danger of personal injury and property damage. ◀

 Do not overfill the fuel tank; otherwise, overflowing fuel can cause damage to the environment and the vehicle. ◀

When refueling, insert the filler nozzle completely into the filler pipe. Avoid lifting the filler nozzle while filling the tank, as that would lead to

- ▷ premature pump shutoff
- ▷ reduced efficiency of the fuel-vapor recovery system.

The fuel tank is full when the filler nozzle clicks off the first time.

Fuel tank capacity

 If the range displayed is less than 30 miles/50 km, be sure to refuel; otherwise, engine functions are not guaranteed and damage could occur. ◀

Approx. 13.2 US gal/50 liters, including the reserve capacity of 2.1 US gal/8 liters.

FUEL SPECIFICATIONS

Gasoline

For optimum fuel efficiency, the gasoline should be free of sulfur or as low in sulfur as possible.

Fuels that are labeled at the pump as containing metal may not be used.

 Do not fill the tank with leaded gasoline or gasoline that contains metal additives, such as manganese or iron; otherwise, long term damage to the catalytic converter or other components may result. ◀

Fuels with a maximum ethanol content of up to 10%, that is, E10, can be used.

The ethanol should meet the following quality standards:

US: ASTM 4806-xx

CAN: CGSB-3.511-xx

xx: always observe currently valid standards.

 Do not fill the tank with E85, i.e. fuel containing 85% ethanol, nor with FlexFuel. Otherwise, the engine and fuel supply system will be damaged. ◀

The engine is knocking regulated. Therefore, different grades of gasoline can be used for refueling.

Recommended gasoline grades

The manufacturer of your MINI recommends:

- ▷ AKI 91.
- ▷ John Cooper Works AKI 93.

Minimum grade

The manufacturer of your MINI recommends AKI 89.

 Do not use any gasoline below the specified minimum fuel grade. Otherwise, the engine could be damaged. ◀

If you use gasoline with this minimum AKI rating, the engine may produce knocking sounds when starting at high external temperatures. This has no effect on the engine life.

 The use of poor-quality fuels may result in harmful engine deposits or damage. Additionally, problems relating to driveability, starting and stalling, especially under certain environmental conditions such as high ambient temperatures and high altitudes, may occur.

If driveability problems are encountered, we recommend switching to a high quality gasoline brand and a higher octane grade - AKI number - for a few tank fulls. To avoid harmful engine deposits, it is highly recommended to purchase gasoline from BP or Top Tier retailers.

Failure to comply with these recommendations may result in the need for unscheduled maintenance. ◀

MINI recommends BP fuels 

WHEELS AND TIRES

VEHICLE EQUIPMENT

In this chapter, all production, country, and optional equipment that is offered in the model range is described. Equipment is also described that is not available because of, for example, selected options or country version. This also applies to safety related functions and systems.

TIRE INFLATION PRESSURES

Information for your safety

It is not merely the tires' service life, but also driving comfort and, to a great extent, driving safety that depend on the condition of the tires and the maintenance of the specified tire pressure.

Checking pressure

 Check the tire inflation pressure regularly and correct it, if necessary; at least twice a month and before starting long trips. If you fail to observe this precaution you may be driving on tires with incorrect tire pressures, a condition that can not only compromise your vehicle's driving stability, but also lead to tire damage and the risk of an accident. Do not drive with deflated, i.e. flat tires, except when using run-flat tires. A flat tire will seriously impair your vehicle's handling and braking response. Attempts to drive on a flat tire can lead to loss of control over the vehicle. ◀

Check the tire inflation pressures only on cold tires. This means after a maximum of 1.25 miles/ 2 km driving or when the vehicle has been parked for at least 2 hours. When tires are warm, the tire inflation pressure is higher.

 After adjusting the tire inflation pressure, reinitialize the Flat Tire Monitor, page 74, or reset the Tire Pressure Monitor, page 77. ◀

MINI: checking the tire inflation pressure of the compact tire

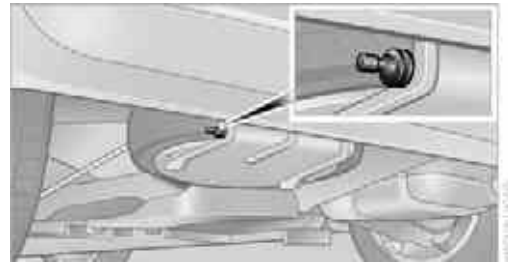

A valve extension for checking the inflation pressure is located behind the bumper.

MINI Clubman: checking the tire inflation pressure of the compact tire

To check the inflation pressure, fold up the flat load floor. Remove the toolkit and the space-saver spare tire, refer to page 229.

Inflation pressure specifications

MINI:

The tables below provide all the correct inflation pressures for the specified tire sizes at ambient temperature.

 The tire inflation pressures apply to the tire sizes approved and the tire brands recommended by the manufacturer of your MINI. Your MINI dealer will be glad to advise you. ◀

For correct identification of the right tire inflation pressures, observe the following:

- ▷ Tire sizes for your vehicle
- ▷ Maximum allowable driving speed

Tire inflation pressures for driving up to 100 mph or 160 km/h

For normal driving up to 100 mph or 160 km/h and to achieve optimum driving comfort, adjust pressures to the respective tire inflation pressures listed on the following pages in the columns for traveling speeds up to a maximum of 100 mph or 160 km/h.

These tire inflation pressures can also be found on the driver's side door pillar when the driver's door is open.

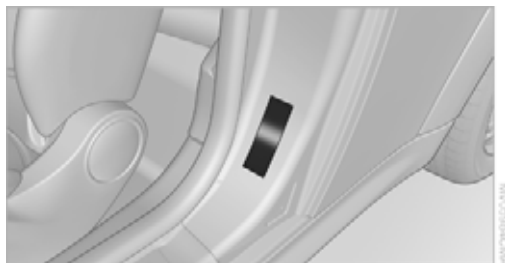

 The maximum permitted speed for these tire inflation pressures is 100 mph or 160 km/h. Do not exceed this speed; otherwise, tire damage and accidents may occur. ◀

Tire inflation pressures for driving above 100 mph or 160 km/h

 In order to drive at maximum speeds in excess of 100 mph or 160 km/h, adjust pressures to the respective tire inflation pressures listed on the following pages in the columns for traveling speeds including those exceeding 100 mph or 160 km/h. Otherwise, tire damage and accidents could occur. ◀

Observe all national and local maximum speed limits; otherwise, violations of the law could occur.

MINI Cooper tire inflation pressures

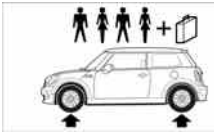
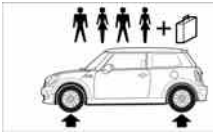
Tire size	Tire pressures in bar/psi			
	Speeds up to a max. of 100 mph / 160 km/h		Speeds including those exceeding 100 mph / 160 km/h	
<p>All pressure specifications in the table are indicated in bar/psi for cold tires. Cold = ambient temperature</p>				
	175/65 R 15 84 T M+S Std			
175/65 R 15 84 H M+S A/S Std				
175/65 R 15 84 H Std				
175/60 R 16 82 H M+S RSC				
195/55 R 16 87 H RSC				
195/55 R 16 87 H M+S RSC	2.3/33	2.3/33	2.6/38	2.6/38
195/55 R 16 87 V M+S A/S RSC				
205/45 R 17 84 V M+S A/S RSC				
205/45 R 17 84 V RSC				
205/45 R 17 84 V M+S RSC				
205/40 R 18 82 W RSC				
Space-saver spare tire: T 115/70 R 15 90 M			Speed up to a max. of 50 mph/80 km/h 4.2/60	

More details on the permissible load and weights can be found on page [245](#).

MINI Cooper S tire inflation pressures

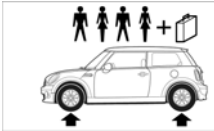
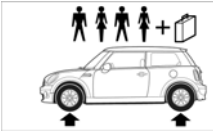
Tire size	Tire pressures in bar/psi				
	Speeds up to a max. of 100 mph / 160 km/h		Speeds including those exceeding 100 mph / 160 km/h		
<p>All pressure specifications in the table are indicated in bar/psi for cold tires. Cold = ambient temperature</p>  					
	195/55 R 16 87 V RSC				
	195/55 R 16 87 H,V M+S RSC	2.3/33	2.3/33	2.6/38	2.6/38
195/55 R 16 87 V M+S A/S RSC					
205/45 R 17 84 V M+S A/S RSC					
205/45 R 17 84 V M+S RSC					
205/45 R 17 84 V RSC	2.6/38	2.6/38	2.8/41	2.8/41	
205/40 R 18 82 W RSC					
175/60 R 16 82 H M+S RSC					

More details on the permissible load and weights can be found on page [245](#).

MINI John Cooper Works tire inflation pressures

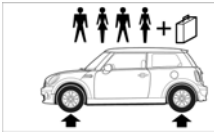
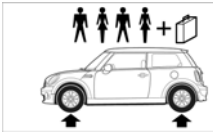
Tire size	Tire pressures in bar/psi				
	Speeds up to a max. of 100 mph / 160 km/h		Speeds including those exceeding 100 mph / 160 km/h		
<p>All pressure specifications in the table are indicated in bar/psi for cold tires. Cold = ambient temperature</p>					
	185/50 R 17 86 H M+S XL RSC	2.6/38	2.6/38	2.8/41	2.8/41
	205/45 R 17 84 V M+S RSC 205/45 R 17 84 W RSC				
205/40 R 18 82 W RSC	2.8/41	2.8/41	3.0/44	3.0/44	

More details on the permissible load and weights can be found on page [245](#).

MINI Cooper Clubman tire inflation pressures

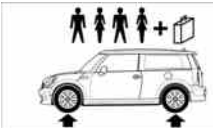
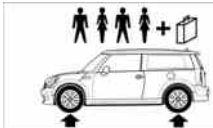
Tire size	Tire pressures in bar/psi			
	Speeds up to a max. of 100 mph / 160 km/h		Speeds including those exceeding 100 mph / 160 km/h	
<p>All pressure specifications in the table are indicated in bar/ psi for cold tires. Cold = ambient temperature</p> <div style="display: flex; justify-content: space-around;">   </div>				
195/55 R 16 87 H RSC				
195/55 R 16 87 H M+S RSC	2.2/32	2.2/32	2.4/35	2.6/38
195/55 R 16 87 V M+S A/S RSC				
<hr/>				
175/65 R 15 84 T M+S Std				
175/65 R 15 84 H M+S A/S Std				
175/65 R 15 84 H Std				
175/60 R 16 82 H M+S RSC	2.4/35	2.4/35	2.6/38	2.8/41
205/45 R 17 84 V RSC				
205/45 R 17 84 V M+S RSC				
205/40 R 18 82 W RSC				
205/45 R 17 84 V M+S A/S RSC				
<hr/>				
Space-saver spare tire:	Speed up to a max. of 50 mph/80 km/h			
T 115/70 R 15 90 M	4.2/60			

More details on the permissible load and weights can be found on page [245](#).

MINI Cooper S Clubman tire inflation pressures

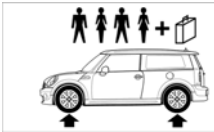
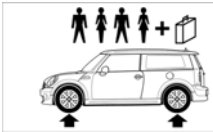
Tire size	Tire pressures in bar/psi				
	Speeds up to a max. of 100 mph / 160 km/h		Speeds including those exceeding 100 mph / 160 km/h		
<p>All pressure specifications in the table are indicated in bar/psi for cold tires. Cold = ambient temperature</p>					
	195/55 R 16 87 V RSC				
	195/55 R 16 87 H,V M+S RSC	2.4/35	2.4/35	2.6/38	2.8/41
195/55 R 16 87 V M+S A/S RSC					
205/45 R 17 84 V RSC					
205/45 R 17 84 V M+S RSC					
205/45 R 17 84 V M+S A/S RSC	2.6/38	2.6/38	2.8/41	3.0/44	
205/40 R 18 82 W RSC					
175/60 R 16 82 H M+S RSC					

More details on the permissible load and weights can be found on page [245](#).

MINI John Cooper Works Clubman tire inflation pressures

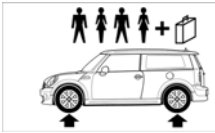
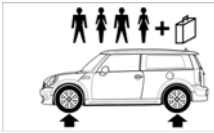
Tire size	Tire pressures in bar/psi				
	Speeds up to a max. of 100 mph / 160 km/h		Speeds including those exceeding 100 mph / 160 km/h		
All pressure specifications in the table are indicated in bar/psi for cold tires. Cold = ambient temperature					
					185/50 R 17 86 H M+S XL RSC
	205/45 R 17 84 V M+S RSC	2.6/38	2.6/38	2.7/39	3.1/45
205/45 R 17 84 W RSC	2.6/38	2.6/38	2.7/39	3.1/45	
205/40 R 18 82 W RSC	2.8/41	2.8/41	2.9/42	3.3/48	

More details on the permissible load and weights can be found on page [245](#).

TIRE CODING

Knowledge of the labeling on the side of the tire makes it easier to identify and choose the right tires.

Tire size

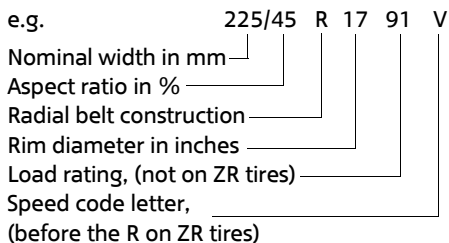

Speed letter

- Q = up to 100 mph/160 km/h
- T = up to 118 mph/190 km/h
- H = up to 131 mph/210 km/h
- V = up to 150 mph/240 km/h
- W = up to 167 mph/270 km/h
- Y = up to 186 mph/300 km/h

Tire Identification Number

Tires with DOT codes meet the guidelines of the US Department of Transportation.

DOT code:

Uniform Tire Quality Grading

For instance: DOT xxxx xxx 0312

Manufacturer's code
for tire make

tire size and tire design

Tire age

Quality grades can be found where applicable on the tire sidewall between tread shoulder and maximum section width. For example:

Tread wear 200 Traction AA
Temperature A

DOT Quality Grades

Tread wear
Traction AA A B C
Temperature A B C

 All passenger car tires must conform to Federal Safety Requirements in addition to these grades. ◀

Tread wear

The tread wear grade is a comparative rating based on the wear rate of the tire when tested under controlled conditions on a specified government test course. For example, a tire graded 150 would wear one and one-half (1 ½) times as well on the government course as a tire graded 100. The relative performance of tires depends upon the actual conditions of their use, however, and may depart significantly from the norm due to variations in driving habits, service practices and differences in road characteristics and climate.

Traction

The traction grades, from highest to lowest, are AA, A, B, and C. Those grades represent the tire's ability to stop on wet pavement, as measured under con-

trolled conditions on specified government test surfaces of asphalt and concrete. A tire marked C may have poor traction performance.

 The traction grade assigned to this tire is based on straight-ahead braking traction tests, and does not include acceleration, cornering, hydroplaning, or peak traction characteristics. ◀

Temperature

The temperature grades are A, the highest, B, and C, representing the tire's resistance to the generation of heat and its ability to dissipate heat when tested under controlled conditions on a specified indoor laboratory test wheel. Sustained high temperature can cause the material of the tire to degenerate and reduce tire life, and excessive temperature can lead to sudden tire failure. The grade C corresponds to a level of performance which all passenger car tires must meet under the Federal Motor Vehicle Safety Standard No. 109. Grades B and A represent levels of performance on the laboratory test wheel that exceed the minimum required by law.

 The temperature grade for this tire is established for a tire that is properly inflated and not overloaded. Excessive speed, underinflation, or excessive loading, either separately or in combination, can cause heat buildup and possible tire failure. ◀

RSC - run-flat tires

You will recognize run-flat tires by a circular symbol containing the letters RSC on the side of the tire, page 207.

M+S

Winter and all-season tires. These have better winter properties than summer tires.

XL

Designation for specially reinforced tires.

TIRE CONDITION

Inspect your tires regularly for tread wear, signs of damage and for foreign objects lodged in the tread. Check the tread depth.

Tread depth

The tread depth should not drop below 1/8 in/3 mm, although, for example, European legislation only specifies a minimum tread depth of 1/16 in/1.6 mm. At tread depths below 1/8 in/3 mm there is an increased risk of high-speed hydroplaning, even when only small amounts of water are present on the road surface.

Winter tires

When winter tires wear down past a tread depth of 1/6 in/4 mm, they become perceptibly less suitable for winter conditions. In the interest of safety, new tires should be installed.

Minimum tread depth

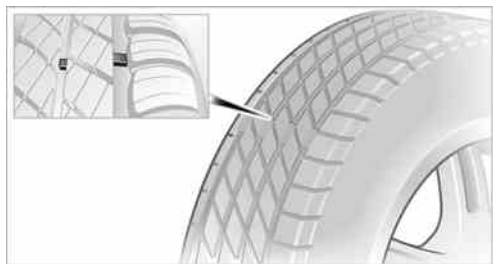

Wear indicators in the base of the tread groove are distributed around the tire's circumference; the letters TWI, for Tread Wear Indicator, on the tire's sidewalls identify tires that incorporate these wear indicators. When tire tread is worn down to the level of the wear indicators, the remaining tread depth is 1/16 in/1.6 mm.

Tire damage

Driving over rough or damaged road surfaces, as well as debris, curbs, and other obstacles can cause serious damage to wheels, tires, and suspension parts. This is more likely to occur with low-profile tires, which provide less cushioning between the wheel and the road. Be careful to avoid road hazards and reduce your speed, especially if your vehicle is equipped with low-profile tires.

Unusual vibrations encountered during normal vehicle operation can indicate tire failure or some other vehicle defect. This can, for example, be caused by driving over curbs. The same applies to any other abnormal road behavior, such as pulling severely to the right or left.



In these cases, reduce speed immediately and have wheels and tires thoroughly checked. To do so, drive carefully to the nearest MINI dealer or a specialized tire shop that has specially trained personnel working in accordance with the specifications of the MINI manufacturer. If necessary, have the vehicle towed there.

Otherwise, tire damage can be extremely dangerous for vehicle occupants and other road users. ◀

Tire age

The manufacturing date of tires is contained in the tire coding:

DOT ... 0312 means that the tire was manufactured during the 3rd week of 2012.

For various reasons, such as the development of brittleness, the manufacturer of your MINI recommends tire replacement after no more than 6 years, regardless of the actual wear of the tires.

RUN-FLAT TIRES



The symbol identifying run-flat tires is a circle with the letters RSC on the sidewall. Run-flat tires comprise a conditionally self-supporting tire and a special rim. The reinforcement in the sidewalls ensures that the tire can continue to be used subject to certain restrictions, even if depressurized.

For information on continuing to drive with a flat tire, refer to Indication of a flat tire, page 75.

NEW WHEELS AND TIRES

 Have new wheels and tires mounted only by your MINI dealer or a specialized tire shop that has specially trained personnel working in accordance with the specifications of the MINI manufacturer. If this work is not carried out properly, there is a danger of subsequent damage and related safety hazards. Make sure that the new wheels are balanced. ◀

Retreaded tires

 The manufacturer of your MINI recommends that you avoid using retreaded tires, as this could impair driving safety. The causes for this include potentially different tire casing structures and often wide variations in tire age, which can result in a limited service life. ◀

Correct wheels and tires

 The manufacturer of your MINI recommends mounting only wheels and tires

that it has specifically approved for use on your particular model. Although other wheels and tires may theoretically have the same dimensions, variations in factors such as manufacturing tolerances can result in contact between tire and bodywork, ultimately leading to serious accidents. The manufacturer of your MINI cannot evaluate non-approved wheels and tires to determine if they are suited for use, and therefore cannot ensure the operating safety of the vehicle if they are mounted. ◀

Your MINI dealer will be glad to inform you about the correct wheel and tire combination for your vehicle.

The correct combination of wheels and tires is also necessary to ensure reliable operation of various vehicle systems such as ABS and DSC.

To maintain good handling and vehicle response, use only tires of a single brand and tread configuration. After a tire has been damaged, mount the previous wheel and tire combination again as soon as possible.

Wheels with Tire Pressure Monitor TPM electronics

When mounting new tires or changing over from summer to winter tires, or vice versa, only use wheels with TPM electronics; otherwise, the Tire Pressure Monitor may not be able to detect a puncture, refer to page 77. Your MINI dealer will be glad to advise you.

Recommended tire brands

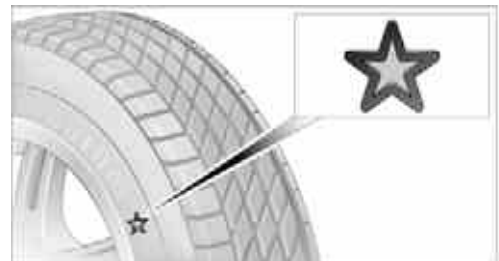

For each tire size, the manufacturer of your MINI recommends certain tire brands. They are

marked with a clearly visible MINI designation on the sidewall of the tire.

When properly used, these tires meet the highest standards in terms of safety and handling characteristics.

Run-flat tires

When mounting new tires or changing over from summer to winter tires and vice versa, mount run-flat tires for your own safety. Keep in mind that no space-saver spare tire is available in the event of a flat. Your MINI dealer will be glad to advise you.

Special characteristics of winter tires

The manufacturer of your MINI recommends the use of winter tires on snowy roads or if temperatures drop below 45 °F / +7 °C. Although all-season M+S tires provide better winter traction than summer tires, they generally fail to provide the same levels of cold-weather performance as winter tires.

Pay attention to speed



Always comply with the speed limit for the winter tires mounted on your car; failure to do so could result in tire damage and accidents. ◀

If the car is capable of speeds higher than that permitted for the winter tires, a label stating the maximum permitted speed for the mounted tires must be displayed in your field of view. This label is available at your tire dealer or MINI dealer.

Storage

Always store wheels and tires in a cool, dry place with as little exposure to light as possible.

Always protect tires against all contact with oil, grease and fuels.

Do not exceed the maximum tire inflation pressure indicated on the sidewall of the tire.

Swapping wheels among the axles

Depending on the individual use, front and rear tires may exhibit different wear and tear.

In order to maintain an even wear and tear, the wheels may be rotated between the axles. Your MINI dealer will be glad to advise you.

Always check the inflation pressure after the tire rotation, if necessary change the pressure.

SNOW CHAINS

Only certain types of fine-link snow chains have been tested by the manufacturer of your MINI, classified as road-safe and recommended. Contact your MINI dealer for more details.

Only attach snow chains in pairs to the front wheels with the following tires.

▷ 175/65 R 15 M+S

▷ 175/60 R 16 M+S

John Cooper Works:

▷ 185/50 R 17 86 H M+S XL RSC

Observe the manufacturer's instructions when mounting snow chains. Do not exceed a speed of 30 mph or 50 km/h.



Do not initialize the Flat Tire Monitor if snow chains are mounted; otherwise, the instrument might issue an incorrect reading. When driving with snow chains, it can be useful to briefly deactivate DSC or activate DTC, refer to page 72. ◀

ENGINE COMPARTMENT

VEHICLE EQUIPMENT

In this chapter, all production, country, and optional equipment that is offered in the model range is described. Equipment is also described that is not available because of, for example, selected options or country version. This also applies to safety related functions and systems.

GENERAL INFORMATION

 Never attempt to perform any service or repair operations on your vehicle without the required professional technical training. If you do not know how to follow the specified instructions, then have the work carried out by your MINI dealer. If this work is not carried out properly, there is a danger of subsequent damage and related safety hazards. ◀

IMPORTANT PARTS OF THE ENGINE COMPARTMENT

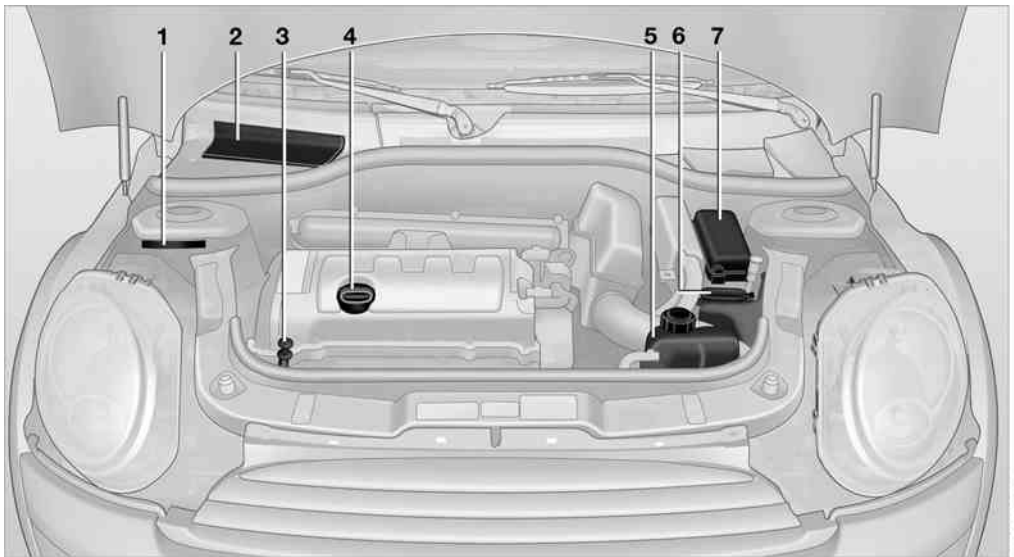

- | | | | |
|---|--|---|---|
| 1 | Vehicle identification number | 5 | Coolant expansion tank 212 |
| 2 | Battery, under the cover 234 | 6 | Reservoir for washer fluid for the headlamp and window washer system 56 |
| 3 | Engine oil dipstick 210 | 7 | Engine compartment fuse box 232 |
| 4 | Engine oil filler neck 211 | | |

HOOD

Releasing



Pull the lever.

! Do not clean the windshield and headlamps if the hood is unlocked as this may damage the headlamp washer system. ◀

Opening



! To avoid damage, make sure that the wiper arms are against the windshield before you open the hood. ◀

Press the release handle and open the hood.

Closing

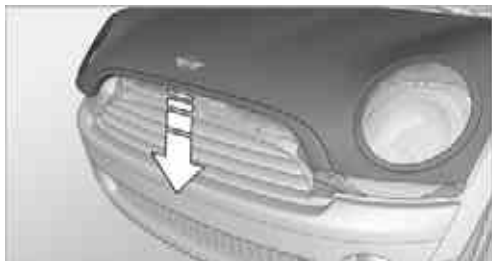

Close the hood from a height of approx. 16 in/ 40 cm with momentum. It must be clearly heard to engage.

! If you notice any signs while driving your vehicle that the hood is not completely closed, stop at once and close it securely. Make sure that the closing path of the hood is clear; otherwise, injuries may result. ◀

ENGINE OIL

Engine oil consumption depends on driving style and operating conditions, e.g., with a very sporty driving style, the engine oil consumption is significantly increased.

Therefore, check the engine oil level regularly after each refueling.

Checking engine oil level

1. With the vehicle's engine at normal operating temperature, i.e. after uninterrupted driving for at least 6 miles/10 km, park the vehicle on a level surface.
2. Switch off the engine.
3. Pull the dipstick out after approx. 5 minutes and wipe it off with a lint-free cloth, paper towel or similar material.
4. Carefully push the dipstick all the way into the guide tube and pull it out again. The oil level should be between the two marks on the dipstick.



The oil quantity corresponding to the difference between the two marks on the dipstick is 1 US quart/1 liter.

! Do not fill beyond the upper mark on the dipstick. Excess oil will damage the engine. ◀

Adding engine oil

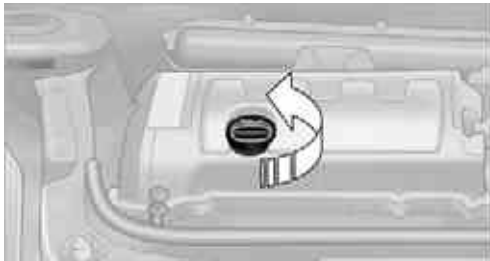

Do not add the maximum quantity of 1 US quart/1 liter of engine oil until the oil level has dropped to just above the lower mark on the dipstick, page 210.

! Add oil within the next 30 miles/50 km; otherwise, the engine could be damaged. ◀

! If too much motor oil is added, immediately have the vehicle checked; otherwise, damage to the engine may result. ◀

! Keep oils, grease, etc. out of the reach of children and comply with the warnings on the containers. Otherwise, health hazards may result. ◀

Oil types for refilling

Notes

! Do not use oil additives as this could result in engine damage. ◀

! When selecting a motor oil, ensure that it belongs to one of the SAE viscosity classes 0W-40, 0W-30, 5W-40 and 5W-30; otherwise, malfunctions or damage to the engine may result. ◀

The engine oil quality is critical for the life of the engine.

Some types of oil may not be available in every country.

Approved oil types

Gasoline engines

BMW High Performance SAE 5W-30

BMW Longlife-01

BMW Longlife-01 FE

Additional information on approved types of oil can be found at a MINI dealer.

Alternative oil types

If the approved engine oils are not available, up to 1 US quart/1 liter of another oil with the following specifications may be used:

Gasoline engines

API SM or higher specifications

Oil change

Only MINI dealers are to perform oil changes.

MINI RECOMMENDS 

COOLANT

Coolant consists of half water and half additive. Not all commercially available additives are suitable for your MINI. Your MINI dealer knows which additives are suitable and will be glad to advise you.

 Only use suitable additives; otherwise, engine damage may result. Because additives are harmful to your health, it is important to follow the instructions on the containers. ◀

 Comply with the appropriate environmental protection regulations when disposing of coolant additives. ◀

Coolant temperature

If the coolant, and therefore the engine, should overheat, then a warning lamp will go on. A message appears on the Control Display.

Checking coolant level

 Do not add coolant to the cooling system when the engine is hot. Escaping coolant can cause burns. ◀

Do not open the hood until the engine has cooled down.



The coolant level is correct if it is between the marks.

Topping off

1. Turn the cap of the expansion tank a little counterclockwise to allow any accumulated pressure to escape, then continue turning to open.
2. Slowly fill to the correct fluid level; do not overfill.
3. Close by turning the cap.

Have the reason for the coolant loss eliminated as soon as possible.

MAINTENANCE

VEHICLE EQUIPMENT

In this chapter, all production, country, and optional equipment that is offered in the model range is described. Equipment is also described that is not available because of, for example, selected options or country version. This also applies to safety related functions and systems.

MINI MAINTENANCE SYSTEM

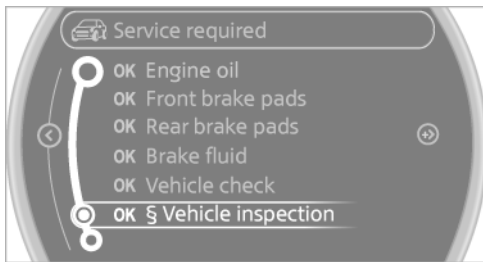

The MINI Maintenance System will remind you of necessary maintenance measures and by doing so, will assist you in maintaining the traffic and operating safety of your vehicle.

If and when you come to sell your MINI, a comprehensive record of servicing will prove a significant benefit.

Condition Based Service CBS

Sensors and special algorithms take the different driving conditions of your MINI into account. Condition Based Service uses this to determine the current and future service requirements. By letting you define a service and maintenance regimen that reflects your own individual requirements, the system builds the basis for trouble-free driving.

On the Control Display, you can have the remaining times or distances for selected maintenance tasks and any legally prescribed dates displayed, page 63.

Service data in the remote control

Your vehicle continuously stores service-requirement information in the remote control while you are driving. Your MINI dealer can read out this data from the remote control unit, and propose an optimized maintenance approach. Whenever you take your car in for servicing you should therefore hand your MINI dealer the remote control unit that you last used.

 Make sure that the date is always set correctly, page 65; otherwise, the effectiveness of Condition Based Service CBS is not assured. ◀

Service and Warranty Information Booklet for US models and Warranty and Service Guide Booklet for Canadian models

Please consult your Service and Warranty Information Booklet for US models and Warranty and Service Guide Booklet for Canadian models for additional information on service requirements.

 The manufacturer of the MINI recommends that you have service and repair operations performed at your MINI dealer. Take the time to ensure that these service procedures are confirmed by entries in your vehicle's Service and Warranty Information Booklet for US models and Warranty and Service Guide Booklet for Canadian models. These entries verify that your vehicle has received the specified regular maintenance. ◀

SOCKET FOR ON-BOARD DIAGNOSIS OBD



The primary components that make up the emissions can be checked by a device via the OBD socket.

Data memory

Your vehicle displays data about the operation, malfunctions, and user settings. These data are stored in the vehicle and can be partly stored in the remote control; the data can be read by suitable devices, in particular at your MINI dealer. The data read out are used for supporting the service processes and repair or for optimization and development of vehicle functions.

EMISSIONS



The warning lamps come on. The vehicle is producing higher emissions. You can continue your journey, but moderate your speed and exercise due caution.



Have the car checked as soon as possible.

Under certain circumstances, one of the lamps will flash or light up continuously. This indicates excessive misfiring or a malfunction in the engine. If this happens, reduce your speed and visit the nearest MINI dealer as soon as possible. Severe misfiring can quickly lead to serious damage of emissions-related components, especially the catalytic converter. In addition, mechanical engine components can become damaged.



If the fuel cap is not properly tightened, the OBD system may conclude that fuel vapors are escaping, causing an indicator to light up. If the fuel cap is then tightened, the indicator should go out within a few days.

CARE

VEHICLE EQUIPMENT

In this chapter, all production, country, and optional equipment that is offered in the model range is described. Equipment is also described that is not available because of, for example, selected options or country version. This also applies to safety related functions and systems.

CAR-CARE PRODUCTS

Regular cleaning and care helps to maintain the value of your MINI.

The manufacturer of your MINI recommends using manufacturer-approved products to clean and care for your vehicle.

Your MINI dealer would be pleased to advise you on cleaning and care products and services for your MINI.

 The ingredients of original MINI Care Products have been tested, and the products have been tested in the laboratory and in practice. They offer optimum care and protection for your vehicle. ◀

 Do not use any cleansers containing alcohol or solvents as these may cause damage. ◀

 Cleaning agents may contain hazardous or health-damaging substances. Follow the warning and hazard instructions on the packaging. For interior cleaning, always open the doors or windows of the vehicle. Do not use any products that are not intended for cleaning the vehicle. ◀

EXTERNAL CARE

Washing your vehicle

 Especially during the winter months the vehicle should be frequently washed. Dirt and road salt can damage the vehicle. ◀

 After washing the vehicle, apply the brakes briefly to dry them; otherwise, water can reduce braking efficiency over the short term and the brake rotors can corrode. ◀

Car washes

Preference should be given to cloth car washes.

 Do not use automatic high-pressure car washes; otherwise, water may drip into the vehicle around the windows. ◀

Before driving into the car wash, check if the system is suitable for your MINI. Observe the following points:

- ▷ Vehicle dimensions, page 241.
- ▷ If necessary: fold in the outside mirrors, page 44.
- ▷ Maximum permissible tire width.
-  Avoid car washes with tracks higher than 4 in/10 cm; otherwise, the chassis could be damaged. ◀

Preparations for driving into the car wash:

- ▷ Unscrew the rod antenna.
- ▷ Deactivate the rain sensor to prevent unintentional wiping.
- ▷ Deactivate rear window wiper and protect it from damage. Ask the car wash operator about measures that can be taken to protect the wipers.
- ▷ Remove additional attachments, e.g. spoilers or telephone antennas, if there is a possibility that they could be damaged.
- ▷ Insert the remote control into the ignition lock.

Automatic transmission

Before driving into the car wash, make sure that the vehicle can roll:

1. Place the remote control, even with Comfort Access, in the ignition lock.
2. Move the selector lever to position N.
3. Release the parking brake.
4. Switch off the engine.
5. Insert the remote control in the ignition lock so that the vehicle can roll.

Steam jets/high-pressure washers

 When using steam jets or high-pressure washers, make sure that you maintain sufficient distance from the vehicle and do not exceed a maximum temperature of 140 °F / 60 °C.

If the distance is too close, the pressure too high, or the temperature too high, parts of the vehicle can be damaged, or water can penetrate.

Observe the operating instructions for high-pressure washers. ◀

 Do not spray sensors, such as the Park Distance Control, with high-pressure washers for a long time or at a distance of less than 1 ft / 30 cm. ◀

Manual washing

Use a great deal of water and, if necessary, car shampoo when washing your car by hand. Clean the vehicle with a sponge or a washing brush applying a slight amount of pressure.

 Before cleaning the windshield, deactivate the rain sensor or turn off the ignition to prevent unintentional wiping. ◀

 Observe local regulations regarding washing vehicles by hand. ◀

Headlamps

Do not wipe dry and do not use abrasive or corrosive cleaning agents. Remove dirt and contamination, such as insects, by soaking with

shampoo and then washing with plenty of water.

Do not remove accumulated ice and snow with an ice scraper; use window deicers instead.

Windows

Clean the outside and inside of the windows and mirrors with a window cleaner.

 Do not clean the mirrors with cleaners containing quartz. ◀

Wiper blades

Clean with soapy water and change regularly to prevent the formation of streaks.

 Wax, preservatives and dirt on the windows cause streaks when the windshield wipers are on, and can cause premature wear of the wiper blades and interfere with the rain sensor. ◀

Paintwork, care

Regular care helps your vehicle retain its value and protects the paint from the long-term effects of aggressive substances.

Environmental influences in areas with increased air pollution or natural contaminants, such as tree sap or pollen, can affect the vehicle paintwork. It is therefore important to adjust the frequency and extent of vehicle care correspondingly.

Immediately remove any particularly aggressive substances, such as fuel that has overflowed, oil, grease, brake fluid, or bird droppings; otherwise, paint damage can be caused.

Removing paintwork damage

 Depending on the severity of the damage, immediately repair stone damage or scratches to prevent rusting. ◀

The manufacturer of the MINI recommends repairing paint damage professionally according to factory specifications with original MINI paints.

Preservation

Preservation is necessary when water no longer beads on the clean paint surface. To preserve the paint, only use preservatives that contain carnauba or synthetic waxes.

Rubber seals

Only treat with water or rubber care products.

 Do not use silicon sprays or other silicon-containing care products on rubber seals; otherwise, noise and damage could occur. ◀

Chrome parts

Carefully clean vehicle parts such as the radiator grill and door handles with copious quantities of water and, if necessary, a shampoo additive, especially when contaminated with road salt. For additional treatment, use chrome polish.

Light alloy wheels

The system produces brake dust that collects on the light alloy wheels. Clean them regularly with acid-free wheel cleaner.

 Do not use aggressive, acid-containing, highly alkaline, or abrasive cleansers or steam jets hotter than 140 °F /60 °C as they may cause damage. ◀

External sensors

 Keep the outside sensors on the vehicle such as the Park Distance Control clean and ice-free to ensure that they function properly. ◀

INTERNAL CARE

Upholstery/fabrics

Regularly use a vacuum cleaner to remove surface dirt.

In case of serious spots such as liquid stains, use a soft sponge or lint-free microfiber cloth and suitable interior cleaners. Observe the instructions on the packaging.



Clean upholstery up to the seams. Do not rub forcefully. ◀



Velcro fasteners on pants or other items of clothing can damage seat covers. Make sure that all Velcro fasteners are closed. ◀

Leather/leather coverings



The leather processed by the manufacturer of your MINI is a high-quality natural product. Light variations in the grain is one of the typical properties of natural leather. ◀

Dust and road grit in the pores and folds of the leather have an abrasive effect, leading to increased wear and causing the leather surface to become brittle prematurely. Use a cloth or vacuum cleaner to remove dust on a regular basis.

Especially when the leather has a light color, it should be cleaned regularly since it tends to get heavily soiled.

Treat the leather twice a year using a leather lotion since dirt and grease will gradually attack the leather's protective layer.

Carpets/floor mats



Keep floor mats, carpet, and other objects out of the movement range of the pedals; otherwise, they may inhibit the function of the pedals during driving.

Do not place additional floor mats onto an existing one or onto other objects.

Only use floor mats that have been approved for the vehicle and can be appropriately fastened. Make sure that the floor mats are securely fastened again after they have been removed, e.g. for cleaning. ◀

Floor mats can be removed to be cleaned.

If the carpets are very dirty, clean with a microfiber cloth and water or an interior cleaner. When doing so, rub forward and back in the driving direction; otherwise, the carpet may become matted.

Interior plastic parts

These include:

- ▷ Plastic surfaces
- ▷ Lamp glass
- ▷ Display panes
- ▷ Mat parts

Only clean with water and, if necessary, solvent-free plastic cleaners.

 Do not use solvents such as alcohol, lacquer thinner, cold cleaners, fuel, or similar, as these will damage the surfaces. ◀

Decorative strips

Only clean decorative strips with moist cloths. Wipe dry with a soft cloth.

Safety belts

Dirty belt straps impede the reeling action and thus have a negative impact on safety.

 Do not clean chemically, as this may destroy the webbing. ◀

Displays

To clean displays, such as the radio or display elements, use an anti-static microfiber cloth.

 Avoid pressing too hard when cleaning the display as this can cause damage. ◀

 Do not use chemical or abrasive household cleaning agents. Keep fluids of any kind away from the device. Surfaces or electrical components may otherwise become corroded or damaged. ◀

CD/DVD drives

 Do not use cleaning CDs as this could damage parts of the drive. ◀

VEHICLE STORAGE

If you park your vehicle longer than three months, ask your MINI dealer to advise you.

REPLACING COMPONENTS

VEHICLE EQUIPMENT

In this chapter, all production, country, and optional equipment that is offered in the model range is described. Equipment is also described that is not available because of, for example, selected options or country version. This also applies to safety related functions and systems.

TOOLKIT

Your vehicle comes with a toolkit that varies with the equipment version; it is stored underneath the flat load floor.

With Mobility Kit

MINI



- 1 Sealant bottle
- 2 Extractor hook
- 3 Vehicle jack
- 4 Wheel stud wrench
- 5 Flat screwdriver/Phillips screwdriver, towing eyelet
- 6 Compressor

MINI Clubman



- 1 Compressor
- 2 Wheel stud wrench
- 3 Vehicle jack
- 4 Torx insert bit for screwdriver
- 5 Flat screwdriver/Phillips screwdriver, towing eyelet
- 6 Extractor hook
- 7 Sealant bottle

Run-flat tires or space-saver spare tire

The toolkit includes a pouch with a plastic bag in which you can place the damaged wheel.

MINI



- 1 Folding chock and cover for defective wheel
- 2 Extractor hook
- 3 Wheel stud wrench
- 4 Vehicle jack

- 5 Special wrench for removing the space-saver spare tire
- 6 Flat screwdriver/Phillips screwdriver
- 7 Towing eyelet
- 8 Lifting handle

MINI Clubman



- 1 Folding chock and cover for defective wheel
- 2 Vehicle jack
- 3 Wheel stud wrench
- 4 Extractor hook
- 5 Flat screwdriver/Phillips screwdriver
- 6 Torx insert bit for screwdriver
- 7 Towing eyelet

WIPER BLADES

 Do not place windshield wipers on the windshield if wiper blades are not installed; otherwise, the windshield may be damaged. ◀

Changing the front wiper blades

1. Fold up the wiper arm.

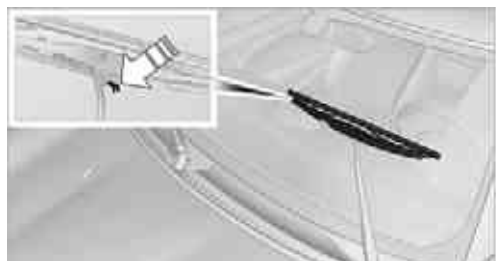

2. Position the wiper blade horizontally.
3. Press the securing spring, arrow.
4. Unhook the wiper blade toward the windshield.
5. Pull the wiper blade past the wiper arm toward the top.
6. Insert the new wiper blade.
7. Press into position until you hear it engage.
8. Fold down the wiper arm.

 To avoid damage, make sure that the wiper arms are against the windshield before you open the hood. ◀

MINI: changing the rear wiper blade



1. Fold up the wiper arm.
2. Rotate the wiper blade toward the back as far as it will go, arrow.
3. Press the wiper blade against the limit and thus out of the mounting.
4. Press the new wiper blade into the fixture until it engages audibly.

MINI Clubman: changing the rear wiper blade

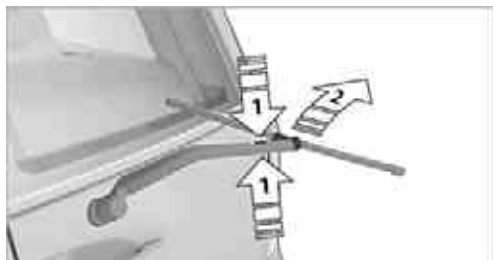

1. Fold out the wiper arm and hold it.
2. Press together the locking spring, arrow 1, and fold out the wiper blade.
3. Pull the wiper blade away from and out of the catch mechanism, arrow 2.
4. Press the new wiper blade into the fixture until it engages audibly.

LAMPS AND BULBS

Lamps and bulbs make an essential contribution to vehicle safety. They should, therefore, be handled carefully. The manufacturer of your MINI recommends having your MINI dealer perform any work that you do not feel competent to perform yourself or that is not described here.

 Never touch the glass of new bulbs with your bare fingers, as even minute amounts of contamination will burn into the bulb's surface and reduce its service life. Use a clean tissue, cloth or something similar, or hold the bulb by its base. ◀

You can obtain a selection of replacement bulbs at your MINI dealer.

 Only replace bulbs after they have cooled down; otherwise, you may burn your fingers. ◀

 When working on electrical systems, always begin by switching off the consumer in question; otherwise, short circuits could result. To avoid possible injury or equipment damage when replacing bulbs, observe

any instructions provided by the bulb manufacturer. ◀

Caring for headlamps, refer to page 216.

 For any bulb replacement not described below, contact a MINI dealer or a workshop that has specially trained personnel working in accordance with the specifications of the MINI manufacturer. ◀

 For checking and adjusting headlamp aim, please contact your MINI dealer. ◀

Light-emitting diodes LEDs

Light-emitting diodes installed behind translucent lenses serve as the light sources for many of the controls and displays in your vehicle. These light-emitting diodes are related to conventional laser diodes, and legislation defines them as Class 1 light-emitting diodes.

 Do not remove the covers or expose the eyes directly to the unfiltered light source for several hours; otherwise, this could cause irritation of the retina. ◀

Headlamp glass lens

In cool or humid weather, condensation may occur on the interiors of the headlamps. The condensation disappears a short time after the light is switched on. The headlamps do not need to be changed.

Do not remove the condensation from headlamps, despite driving with lights on, and if condensation increases, e.g., because of water droplets, have this checked by your MINI dealer.

Xenon lamps

The service life of these bulbs is very long and the probability of failure very low, provided that they are not switched on and off an excessive number of times. If a xenon lamp fails nevertheless, switch on the fog lamps and continue the journey with great care, provided that local legislation does not prohibit this.

! Work on the xenon lighting system, including lamp replacement, is only to be carried out only by your MINI dealer. Due to high voltage, there is a risk of fatal injury if work on the xenon lamps is carried out improperly. ◀

Halogen low beams and high beams

H13 bulb, 60/5 watts

! The H13 bulb is pressurized. Therefore, wear safety glasses and protective gloves. Otherwise, there is a risk of injury if the bulb is damaged. ◀

! Be careful when installing the cover; otherwise, leaks could occur and cause damage to the headlamp system. ◀

Accessing the lamp from the engine compartment

The low-beam/high-beam bulb can be changed from the engine compartment.



Removing the cover:

1. Press the tab.
2. Flip open the cover and take it out of the holder.

Follow the same steps in reverse order to reattach the cover.

! Be careful when installing the cover; otherwise, leaks could occur and cause damage to the headlamp system. ◀

Replacing the bulb

1. Turn the lamp counterclockwise, arrow 1, and remove it, arrow 2.

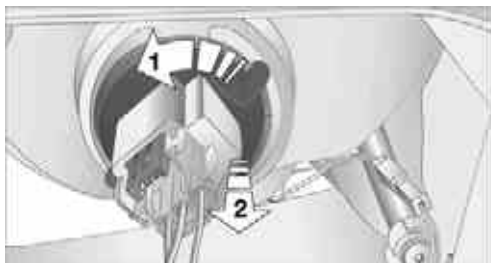

2. Push on the catch, arrow 1, and disconnect the connector, arrow 2.

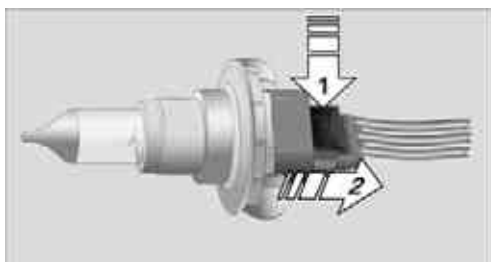

3. To insert the new bulb and replace the cover, proceed in reverse order.

Turn signals, parking lamps, roadside parking lamps, and fog lamps

Accessing the lamps via the wheel well



- 1 Turn signal
- 2 Parking/roadside parking/fog lamps

Replacing a turn signal bulb

21 watt bulb, PY 21 W

1. Turn in the wheel.
2. Remove cover 1.
To do so, turn the cover counterclockwise.
3. Remove the inside cover.
To do so, turn the cover counterclockwise.

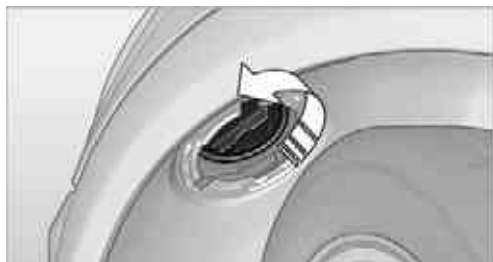

4. Unscrew the bulb counterclockwise.

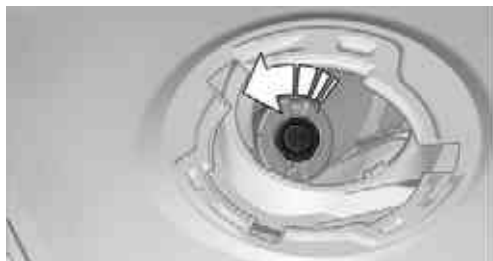

5. To insert the new bulb and replace the covers, proceed in reverse order.

Replacing a parking/roadside parking lamp bulb

5 watt bulb, W 5 W

1. Turn in the wheel.
2. Remove cover 2.
To do so, turn the cover counterclockwise.

3. Unscrew the upper bulb counterclockwise.



4. To insert the new bulb and replace the cover, proceed in reverse order.

Replacing a fog lamp bulb

H8 bulb, 35 watts

1. Turn in the wheel.
2. Remove cover 2.
To do so, turn the cover counterclockwise.
3. Pull the cable connector.
4. Unscrew the lower bulb counterclockwise.



5. To insert the new bulb and replace the cover, proceed in reverse order.

Side turn signals

5 watt bulb, W 5 W

1. Push the lamp with the ventilation grate forward and remove.

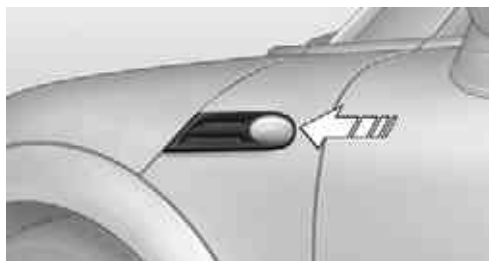

2. Unscrew the bulb holder counterclockwise.
3. Pull out and replace the bulb.
4. To insert the new bulb and replace the cover, proceed in reverse order.

Tail lamps

Turn signals: 21 watt bulb, PY 21 W

Brake light: bulb 21 Watt/5 Watt, W 5 W

Other lights: bulb 21 Watt, P 21 W

MINI

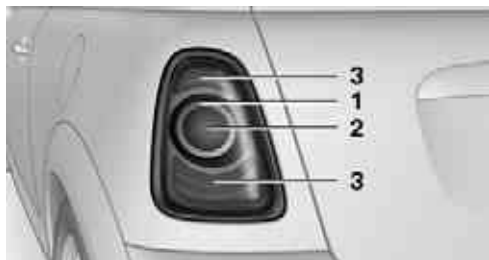

- 1 Turn signal
- 2 Tail lamp LED
- 3 Brake light

MINI Clubman

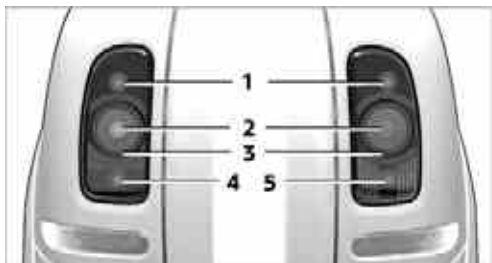

- 1 Brake light
- 2 Turn signal
- 3 Tail lamp LED
- 4 Rear fog lamp
- 5 Backup lamps

MINI: changing

1. Remove the cover from the sidewall of the cargo area.

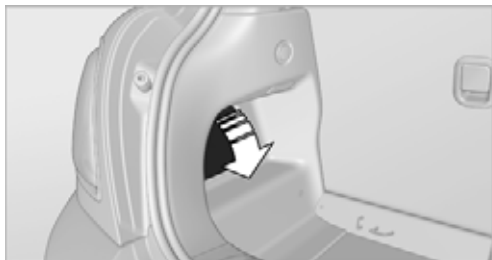

2. Unscrew the desired bulb counterclockwise, arrows 1. Another bulb is located behind the luggage compartment side wall, arrow 2.

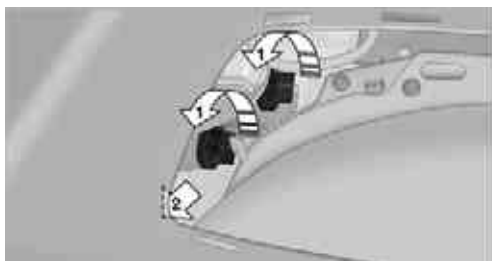

3. To insert the new bulb and replace the cover, proceed in reverse order.

MINI Clubman: changing

1. Using the screwdriver from the toolkit, remove the screw at the top.



2. Swing out the tail lamp and remove it toward the top.
3. Disconnect the cable connector if necessary, arrow 1.



4. Unscrew the corresponding bulb counterclockwise, arrow 2, and remove it.
5. To insert the new bulb and reinstall the tail lamp, proceed in reverse order.

MINI: rear fog lamps/Reverse lights

Bulbs 16 Watt, W 16W

Access the lamps via the rear or underside of the bumper.

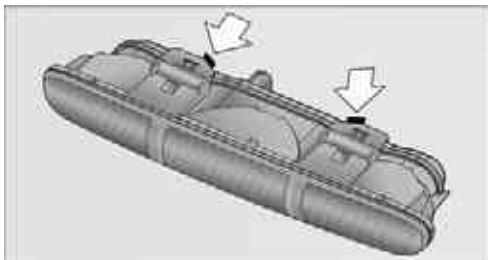

1. Press fastening clips, arrows, together and remove the lamp holder.
2. Remove the bulb and replace it.
3. To insert the new bulb and bulb holder, proceed in reverse order.
4. Re-engage the bulb holder so that it audibly clicks into place.

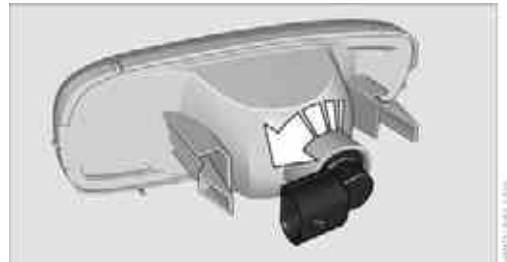
John Cooper Works: aerodynamic bumper

1. Unscrew the bulb holder counterclockwise, arrow.
2. Remove the bulb and replace it.
3. To insert the new bulb and bulb holder, proceed in reverse order.

▶ MINI Clubman: the rear fog lamp is located in the left tail lamp, refer to Tail lamps page 224. ◀

MINI: license plate lamps

5 watt bulb, C 5 W



1. Using a screwdriver, push the lamp to the left in the tab of the lamp housing, arrow 1.
2. Remove the lamp, arrow 2.

3. Replace the bulb.
4. Insert the lamp.

MINI Clubman: license plate lamps

5 watt bulb, C 5 W

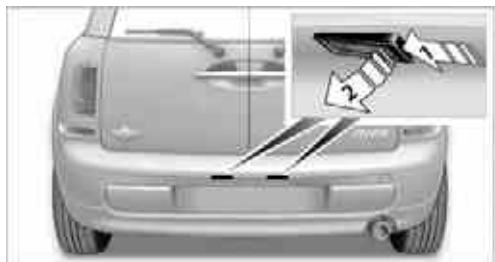

1. Using a screwdriver, push the lamp to the left in the tab of the lamp housing, arrow 1.
2. Remove the lamp, arrow 2.
3. Replace the bulb.
4. Insert the lamp.

Center brake lamp

This lamp uses LED technology for operation. In the event of a malfunction, contact your MINI dealer or a workshop that has specially trained personnel working in accordance with the specifications of your MINI manufacturer.

REPAIRING A FLAT TIRE

▷ Safety measures in the event of a breakdown:

Park the vehicle as far as possible from moving traffic and switch on the hazard warning flashers.

Turn the steering wheel until the front wheels are in the straight-ahead position and engage the steering wheel lock. Engage the parking brake and shift into 1st or reverse gear or place the selector lever in position P.

All passengers should be outside the vehicle and in a safe place, e.g. behind a guardrail.

Erect a warning triangle or warning flasher at the

appropriate distance if necessary. Comply with all safety guidelines and regulations. ◀

In the event of a flat tire, different procedures should be followed depending on the equipment included in your vehicle:

- ▷ MINI Mobility Kit, refer to the following section
- ▷ Run-flat tires, page 228
- ▷ Tire change with space-saver spare tire, page 228

MINI Mobility Kit

Preparations

Use of the MINI Mobility Kit may be ineffective if the tire puncture measures approx. 1/8 in/4 mm or more. Contact the nearest MINI dealer if the tire cannot be made drivable with the Mobility Kit.

Do not remove foreign bodies which have penetrated the tire if possible.

▷ Follow the instructions on using the Mobility Kit found on the compressor and the sealant bottle. ◀

Remove the adhesive label for the speed limit from the sealant bottle and affix it to the steering wheel.

Sealant and compressor



- 1 Sealant bottle and adhesive label with speed limit
- 2 Filling hose

▷ Note the use-by date on the sealant bottle. ◀

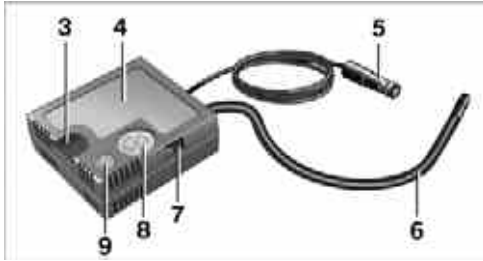

- 3 Holder for the sealant bottle
- 4 Compressor
- 5 Plug and cable for the socket in the vehicle interior, page 99
- 6 Connection hose to connect the compressor and sealant bottle or the compressor and wheel
- 7 On/off switch
- 8 Pressure gauge for indicating the tire inflation pressure
- 9 Release button for reducing the tire inflation pressure

Connector, cable and connection hose are stored in the compressor housing.

Using the Mobility Kit

To repair a tire puncture with the Mobility Kit, proceed as follows:

- ▷ Fill the tire with sealant.
- ▷ Distribute the sealant.
- ▷ Correct the tire inflation pressure.

Filling the tire with sealant

! Proceed in the specified order; otherwise, sealant may emerge under high pressure. ◀

1. Shake the sealant bottle.
2. Pull the connecting hose **6** completely out of the compressor housing and screw it onto the connector of the sealant bottle. Make sure that the hose is not kinked.
3. Insert the sealant bottle on the compressor housing in an upright position.

4. Unscrew the dust cap from the valve of the defective wheel and screw the filling hose **2** of the sealant bottle onto the valve.
5. Ensure that the compressor is switched off.
6. Insert the plug **5** into the lighter socket/ power socket in the vehicle interior, page 99.
7. With the engine running: Switch on the compressor and let run for about 3 to 8 minutes in order to add the sealant and to achieve an inflation pressure of about 1.8 bar/26 psi.

▶ When adding the sealant, the filling pressure can temporarily increase up to about 5 bar/73 psi. Do not switch off the compressor during this phase. ◀

! Do not run the compressor for longer than 10 minutes; otherwise, the device will overheat and possibly be damaged. ◀

8. Switch off the compressor.

If an inflation pressure of 1.8 bar/26 psi is not reached:

1. Unscrew the filling hose **2** from the wheel and drive the vehicle forward and backward approx. 33 ft/10 m to distribute the liquid sealant in the tire evenly.
2. Inflate the tire again with the compressor.

▶ If an inflation pressure of 1.8 bar/26 psi is not reached, then the tire is too badly damaged. Please contact the nearest MINI dealer. ◀

Stowing Mobility Kit

1. Unscrew filler hose **2** of the sealant bottle from the wheel.
2. Unscrew connecting hose of the compressor **6** from the sealant bottle.
3. Connect the filler hose **2** of the sealant bottle to the unoccupied connection on the sealant bottle.
This prevents the rest of the sealant from escaping from the bottle.
4. Wrap the empty sealant bottle in suitable material to avoid dirtying the cargo area.
5. Stow Mobility Kit back in the vehicle.

Distributing the sealant

Immediately drive approx. 3.1 miles/5 km so that the sealant evenly distributes itself.

 Do not exceed speeds of 50 mph/80 km/h.

If possible, do not drop below 10 mph/20 km/h. ◀

Adjusting the tire pressure

1. After driving approx. 3.1 miles/5 km or 10 minutes, stop at a suitable location.
 2. Screw the connection hose **6** of the compressor directly onto the tire valve.
 3. Insert the plug **5** into the power socket in the vehicle interior.
 4. Adjust tire pressure to 1.8 bar/26 psi. With the engine running:
 - ▷ To increase the inflation pressure: switch on the compressor. To check the current inflation pressure, switch off the compressor.
-  Do not run the compressor for longer than 10 minutes; otherwise, the device will overheat and possibly be damaged. ◀
- ▷ To decrease the inflation pressure: press the release button **9**.

 If the tire cannot maintain the inflation pressure, drive the vehicle again, refer to Distributing the sealant. Then repeat steps 1 to 4.

If an inflation pressure of 1.8 bar/26 psi still cannot be reached, then the tire is too heavily damaged. Contact your nearest MINI dealer. ◀

Driving on

 Do not exceed the permitted maximum speed of 50 mph/80 km/h; doing so may result in an accident. ◀

Replace the defective tire as soon as possible and have the new wheel/tire assembly balanced.

Have the Mobility Kit refilled.

CHANGING WHEELS

Run-flat tires

Tire change for run-flat tires:

- ▷ Prepare for tire change, page [230](#)
- ▷ Jack up vehicle, page [230](#)
- ▷ Tighten lug bolts, page [231](#)

Space-saver spare tire

Tire change with space-saver spare tire:

- ▷ Remove the space-saver spare tire, page [229](#)
- ▷ Prepare for tire change, page [230](#)
- ▷ Jack up vehicle, page [230](#)
- ▷ Mount space-saver spare tire, page [230](#)
- ▷ Tighten lug bolts, page [231](#)
- ▷ Drive with space-saver spare tire, page [230](#)

MINI: removing the space-saver spare tire

The screw connection of the space-saver spare tire is under the floor mat in the cargo area, on the base of the storage compartment for the tire change set.

1. Unscrew the screw connection with the special wrench.
2. Take out the cover panel.



3. Screw the lifting handle from the toolkit onto the thread.



4. Raise the lifting handle slightly.
5. Squeeze the securing spring.

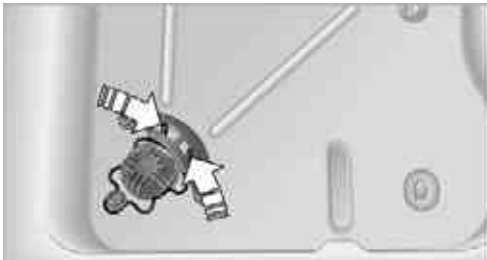

6. The space-saver spare tire is released and must be held by the lifting handle.
7. Lower the space-saver spare tire with the lifting handle.
8. Unscrew the lifting handle.

9. Pull the space-saver spare tire underneath the vehicle out toward the rear.



10. Position the space-saver spare tire with the valve facing upward.
11. Unscrew the valve extension from the valve of the space-saver spare tire.
12. Unscrew the dust cap from the extension and place it on the valve of the space-saver spare tire.

 Due to its different dimensions, the damaged wheel cannot be placed in the recess for the space-saver spare tire. ◀

MINI Clubman: removing the space-saver spare tire

The space-saver spare tire is located under the tire change set in the cargo area.

1. Fold up the floor mat.
2. Unscrew the nut, arrow, and remove the space-saver spare tire.



Driving with the space-saver spare tire

! Drive cautiously and do not exceed a speed of 50 mph/80 km/h. Changes may occur in vehicle handling such as lower track stability during braking, longer braking distances and changes in self-steering properties when close to the handling limit. These properties are more noticeable with winter tires. ◀

! Only one space-saver spare tire may be mounted at one time. Mount a wheel and tire of the original size as soon as possible, to avoid any safety risks. ◀

▶ Check the tire inflation pressure at the earliest opportunity and correct it if necessary. Replace the defective tire as soon as possible and have the new wheel/tire assembly balanced. ◀

Preparing for a tire change

▶ Observe the safety precautions regarding flat tires on page 226. ◀

! Additional safety measures when changing tires:

Only change the tire when parked on a surface that is level, firm and not slippery.

The vehicle or the jack could slip sideways on soft or slippery support surfaces, such as snow, ice, flagstones, etc.

Do not use a wooden block or similar object as a support base for the jack, as this would prevent it from extending to its full support height and reduce its load-carrying capacity.

Do not lie under the vehicle or start the engine when the vehicle is supported by the jack; otherwise, there is a risk of fatal injury. ◀

1. Place the foldable chock behind the front wheel on the other side of the vehicle or in front of the wheel if the vehicle is on an incline. If the wheel is changed on a surface with a more severe slope, take additional precautions to secure the vehicle from rolling.
2. Uncover the lug bolts if necessary.
3. Loosen the lug bolts by a half turn.

Jacking up the vehicle

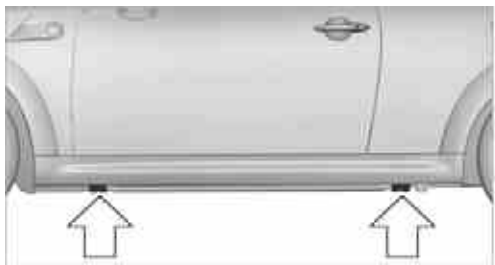

! The vehicle jack is designed for changing wheels only. Do not attempt to raise another vehicle model with it or to raise any load of any kind. To do so could cause accidents and personal injury. ◀

1. Place the jack at the jacking point closest to the wheel.

The jack base must be perpendicular to the surface beneath the jacking point.



2. During jacking up, insert the jack head in the square recess of the jacking point.
3. Jack the vehicle up until the wheel you are changing is raised off the ground.

Mounting the space-saver spare tire

1. Unscrew the lug bolts and remove the wheel.
2. Remove accumulations of mud or dirt from the mounting surfaces of the wheel and hub. Clean the lug bolts.
3. Lift the new wheel into place.
4. Screw at least two lug bolts finger-tight into opposite bolt holes.
5. Screw in the remaining bolts.

6. Tighten all the lug bolts firmly in a diagonal pattern.
7. Lower the vehicle.
8. Remove the jack.

Tightening the lug bolts

Tighten the lug bolts in a diagonal pattern.

 Immediately have the wheels checked with a calibrated torque wrench to ensure that the lug bolts are firmly seated. Otherwise, incorrectly tightened lug bolts can present a safety hazard. ◀

Tightening torque: 103.3 lb ft or 140 Nm.

Replace the defective tire as soon as possible and have the new wheel/tire assembly balanced.

VEHICLE BATTERY

Maintenance

The battery is 100% maintenance-free, the electrolyte will last for the life of the battery when the vehicle is operated in a temperate climate.

Battery replacement

 Only use vehicle batteries that have been approved for your vehicle by the manufacturer; otherwise, the vehicle could be damaged and systems or functions may not be fully available. ◀

After a battery replacement, have the battery registered on the vehicle by your MINI dealer to ensure that all comfort functions are fully available.

Charging the battery

Note

 Do not connect battery chargers to the sockets installed in the vehicle at the factory; otherwise you may cause damage to the vehicle. ◀

Starting-aid terminals

Only charge the battery in the vehicle when the engine is off. Connections, refer to Jump-starting on page 234.

Charger

The use of a charger ensures that the battery has a sufficient charge even when it is used for frequent short-distance drives, for example. Chargers that have been developed especially for the vehicle and adapted to the vehicle electrical system are available at your MINI dealer.

Disposal

 After replacing old batteries, return the used batteries to your MINI dealer or to a recycling center. Maintain the battery in an upright position for transport and storage. Always secure the battery against tipping over during transport. ◀

Power failure

After a temporary power loss, some equipment may not be fully functional and may require initialization. Individual settings are also lost and must be reprogrammed:

- ▷ Time and date
These values must be updated, page 64.
- ▷ Onboard monitor
Operability must be waited for, page 112.
- ▷ Glass sunroof, electric
It may only be possible to tilt the sunroof, if applicable. The system must be initialized. Contact your nearest MINI dealer.

Indicator and warning lamps

 Lights up in red:
Battery is no longer being charged.
Alternator malfunction.

Switch off all unnecessary electrical consumers. Have the battery checked without delay.



Lights up in yellow:
Battery charge level very low, battery aged, or battery not securely connected.

Charge it by taking a longer drive or by using an external charger. If the display appears again, have the battery checked as soon as possible.

Opening the cover

Press out at the recess.

FUSES

 Do not attempt to repair a blown fuse or replace it with a fuse of a different color or Ampere rating. To do this could cause a fire in the vehicle resulting from a circuit overload. Have fuses replaced by your MINI dealer. ◀

A fuse assignment diagram is located on the inside of the fuse box cover panels.

In the engine compartment



Opening the cover

Press the latch.

In the vehicle interior



On the right side of the footwell.

GIVING AND RECEIVING ASSISTANCE

VEHICLE EQUIPMENT

In this chapter, all production, country, and optional equipment that is offered in the model range is described. Equipment is also described that is not available because of, for example, selected options or country version. This also applies to safety related functions and systems.

ROADSIDE ASSISTANCE

Roadside Assistance is available by phone 24 hours a day in many countries. You can receive assistance there in the event of an emergency.

FIRST AID POUCH

Some of the articles contained in the first aid pouch have a limited service life. Therefore, check the expiration dates of the contents regularly and replace any items in good time, if necessary.

MINI



The first aid pouch is located on the rear cargo well by the left side trim panel.

MINI Clubman



The first aid pouch is located on the rear cargo well by the left side trim panel or under the flat load floor.

WARNING TRIANGLE

MINI

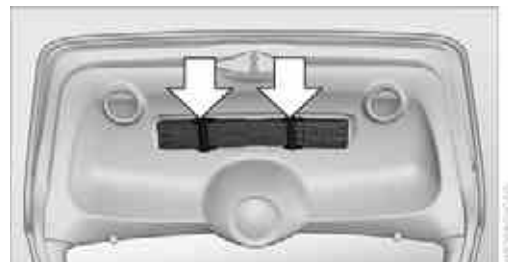

On the inside of the tailgate.
Press the tab to take it out.

MINI Clubman

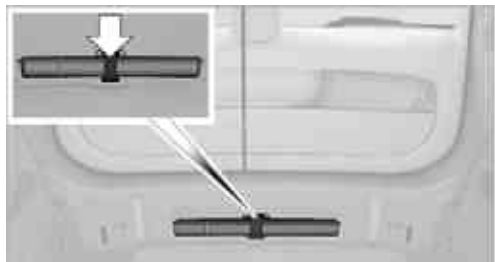

In the cargo area under the loading sill.
Open the center lock to take it out.

JUMP-STARTING

If the car's own battery is flat, your MINI's engine can be started by connecting two jumper cables to another vehicle's battery. You can also use the same method to help start another vehicle. Only use jumper cables with fully-insulated clamp handles.

! Do not touch any electrically live parts when the engine is running, or a fatal accident may occur. Carefully adhere to the following sequence, both to prevent damage to one or both vehicles, and to guard against possible personal injuries. ◀

Preparation

1. Check whether the battery of the other vehicle has a voltage of 12 volts and approximately the same capacitance in Ah. This information can be found on the battery.
2. Switch off the engine of the support vehicle.
3. Switch off any consumers in both vehicles.

! There must not be any contact between the bodies of the two vehicles; otherwise, there is a danger of shorting. ◀

Connecting jumper cables

! Connect the jumper cables in the correct order, so that no sparks which could cause injury occur. ◀

1. Open the battery cover in the engine compartment to access the positive terminal of your MINI.



2. Release the tabs on the left and right sides of the positive terminal cover, arrows 1, and lift the cover to open, arrow 2.

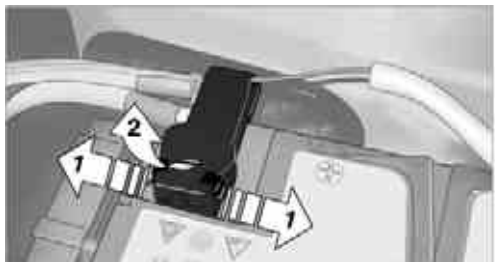

3. Attach one terminal clamp of the plus/+ jumper cable to the positive terminal of the battery or to a starting-aid terminal of the vehicle providing assistance.
4. Attach the second terminal clamp of the plus/+ jumper cable to the positive terminal of the battery or a starting-aid terminal of the vehicle to be started.
5. Attach one terminal clamp of the minus/- jumper cable to the negative terminal of the battery or to an engine or body ground of the assisting vehicle.

Body ground in MINI:



6. Attach the second terminal clamp of the minus/- jumper cable to the negative terminal of the battery or to the engine or body ground of the vehicle to be started.

Starting the engine

1. Start the engine of the donor vehicle and allow it to run for a few minutes at slightly increased idle speed.
2. Start the engine of the other vehicle in the usual manner.
If the first start attempt is not successful, wait a few minutes before another attempt in order to allow the discharged battery to recharge.
3. Let the engines run for a few minutes.
4. Disconnect the jumper cables by reversing the above connecting sequence.

If necessary, have the battery checked and recharged.

- ▶ Never use spray fluids to start the engine. ◀

TOW-STARTING, TOWING AWAY

⚠ Observe the applicable laws and regulations for tow-starting and towing vehicles. ◀

⚠ Do not transport any passengers other than the driver in a vehicle that is being towed. ◀

Using a tow fitting

The screw-in tow fitting must always be carried in the car. It can be screwed in at the front or rear of the MINI.

It is stored in the toolkit in the cargo area underneath the cover on the right-hand side, page 219.

⚠ Use only the tow fitting provided with the vehicle and screw it all the way in. Use the tow fitting for towing on paved roads only. Avoid lateral loading of the tow fitting, e.g. do not lift the vehicle by the tow fitting. Otherwise, the tow fitting and the vehicle could be damaged. ◀

Access to screw thread

Push out the cover of the towing eye out of the recess in the bumper.

Front

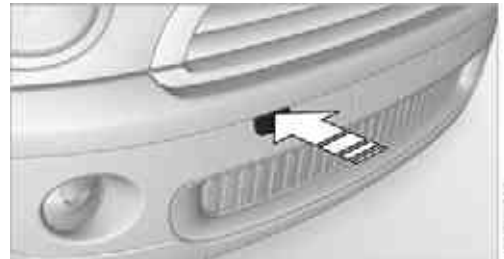

MINI: rear

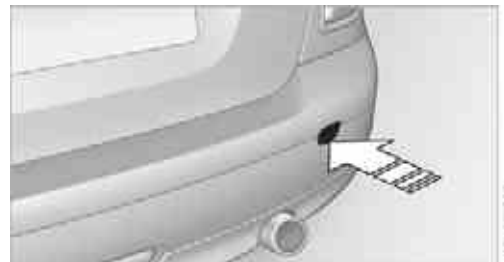

John Cooper Works with aerodynamic bumper:

Pull out the bottom of the cover panel of the towing eye in the bumper, arrow.



MINI Clubman: rear



Being towed

! Make sure that the ignition is switched on, refer to page 49; otherwise, the low beams, tail lamps, turn signals, and windshield wipers may be unavailable. Do not tow the vehicle with just the rear axle raised, as this would allow the steering to turn. ◀

There is no power assist while the engine is off. Thus, braking and steering will require increased effort.

Switch on the hazard warning flashers, depending on local regulations.

Manual transmission

Gearshift lever in neutral position.

Automatic transmission

! Tow vehicles with automatic transmission only with a tow truck or with the front wheels lifted; otherwise, the transmission can be damaged. ◀

Towing with a tow bar

! The towing vehicle must not be lighter than the towed vehicle; otherwise, it may be impossible to maintain control. ◀

The tow fittings used should be on the same side on both vehicles. Should it prove impossible to avoid mounting the tow bar at an angle, please observe the following:

- ▷ Clearance and maneuvering capability will be sharply limited during cornering.
- ▷ The tow bar will generate lateral forces if it is attached offset.

! Only attach the tow bar to the tow fittings, as attachment to other vehicle parts can lead to damage. ◀

Towing with a tow rope

When starting off in the towing vehicle, make sure that the tow rope is taut.

! To avoid jerking and the associated stresses on vehicle components when towing, always use nylon ropes or nylon straps. Attach the tow rope to the tow fittings only, as attaching it to other parts of the vehicle could result in damage. ◀

Towing with a tow truck

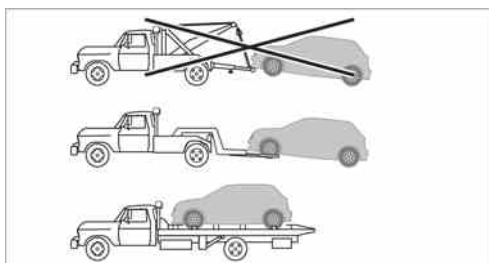

Have the MINI transported by a tow truck with a so-called lift bar or on a flat bed.

! Do not lift vehicle by tow fitting or body and chassis parts, otherwise damage may result. ◀

Tow-starting

Avoid tow-starting the vehicle whenever possible; instead, jump-start the engine, page 234.

Vehicles with a catalytic converter should only be tow-started when the engine is cold, vehicles with an automatic transmission cannot be tow-started at all.

1. Switch on hazard warning flashers, comply with local regulations.
2. Switch on the ignition, page 49.
3. Shift into 3rd gear.
4. Have the vehicle tow-started with the clutch completely depressed and then slowly release the clutch. After the engine starts, immediately depress the clutch completely again.
5. Stop at a suitable location, remove the tow bar or rope and switch off the hazard warning flashers.
6. Have the vehicle checked.

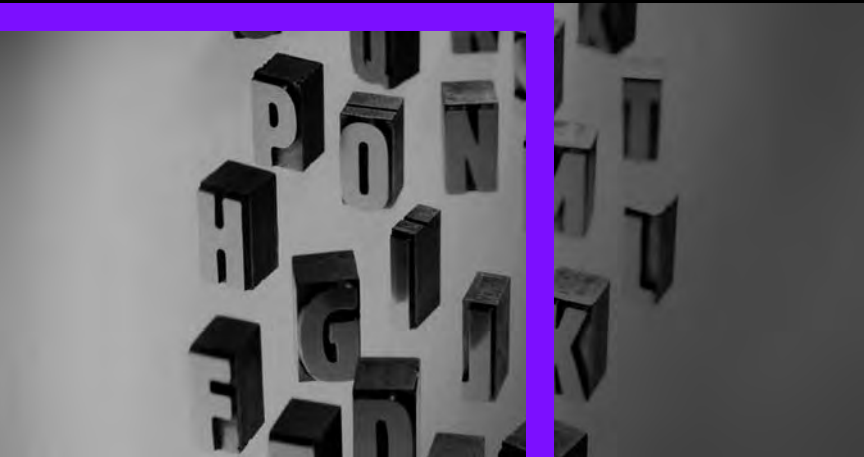

FIND ME.

AT A GLANCE

CONTROLS

DRIVING TIPS

NAVIGATION

ENTERTAINMENT

COMMUNICATIONS

MOBILITY

REFERENCE

TECHNICAL DATA

VEHICLE EQUIPMENT

In this chapter, all production, country, and optional equipment that is offered in the model range is described. Equipment is also described that is not available, for example due to the

selected options or national-market version. This also applies to safety related functions and systems.

ENGINE DATA

		Cooper	Cooper S	John Cooper Works
Displacement	cu in/ cm ³	97.5/ 1,598	97.5/ 1,598	97.5/ 1,598
Number of cylinders		4	4	4
Maximum power output	hp	121	181	208
At engine speed	rpm	6,000	5,500	6,000
Maximum torque with overboost	lb ft/ Nm	114/155 –	177/240 192/260	192/260 207/280
At engine speed with overboost	rpm	4,250 –	1,600-5,000 1,730-4,500	1,850-5,600 2,000-5,100
Overboost briefly raises the maximum torque at high rates of acceleration, e.g. when passing.				

DIMENSIONS

MINI

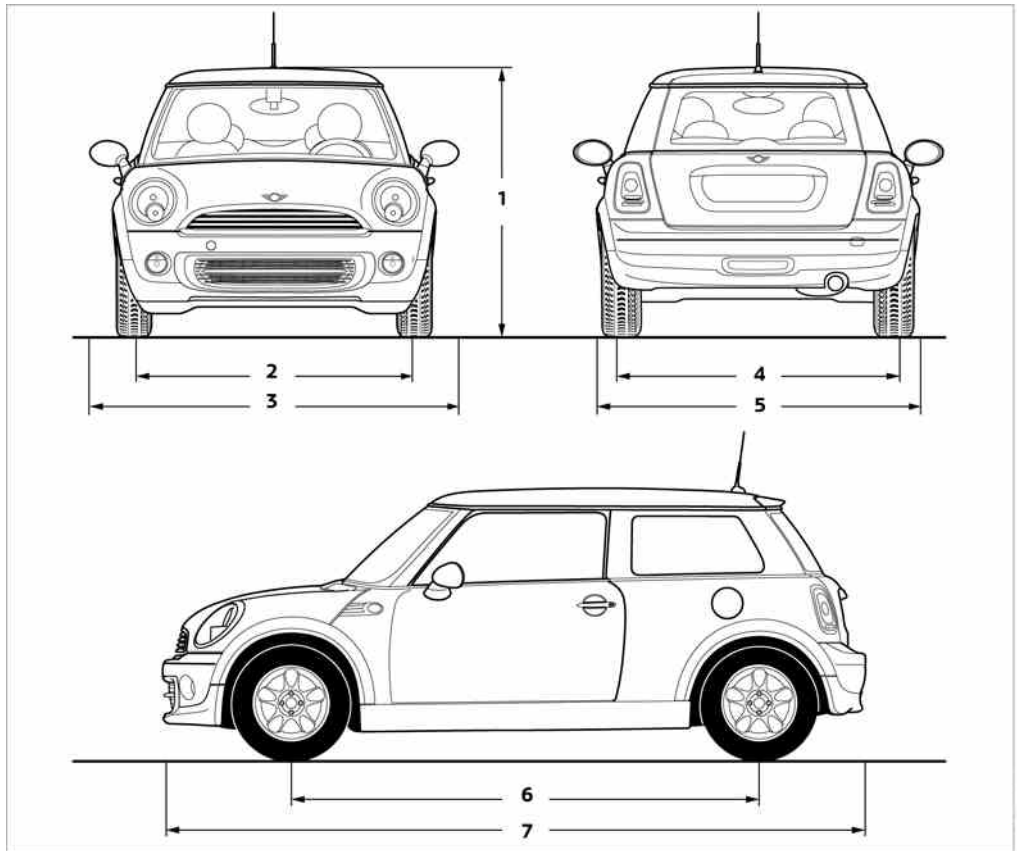

		Cooper	Cooper S, John Cooper Works
1	Vehicle height without roof antenna	55.4/1,407	55.4/1,407
2	Track, front	57.4/1,459	57.2/1,453
3	Vehicle width, with outside mirror	75.3/1,913	75.3/1,913
4	Track, rear	57.8/1,467	57.5/1,461
5	Vehicle width, without outside mirror	66.3/1,683	66.3/1,683
6	Wheelbase	97.1/2,467	97.1/2,467
7	Vehicle length with aerodynamic bumpers	146.6/3,723	146.8/3,729 148/3,758
All dimensions in inches/mm. Minimum turning radius dia.: 35 ft 10 in/10.7 m.			

MINI Clubman

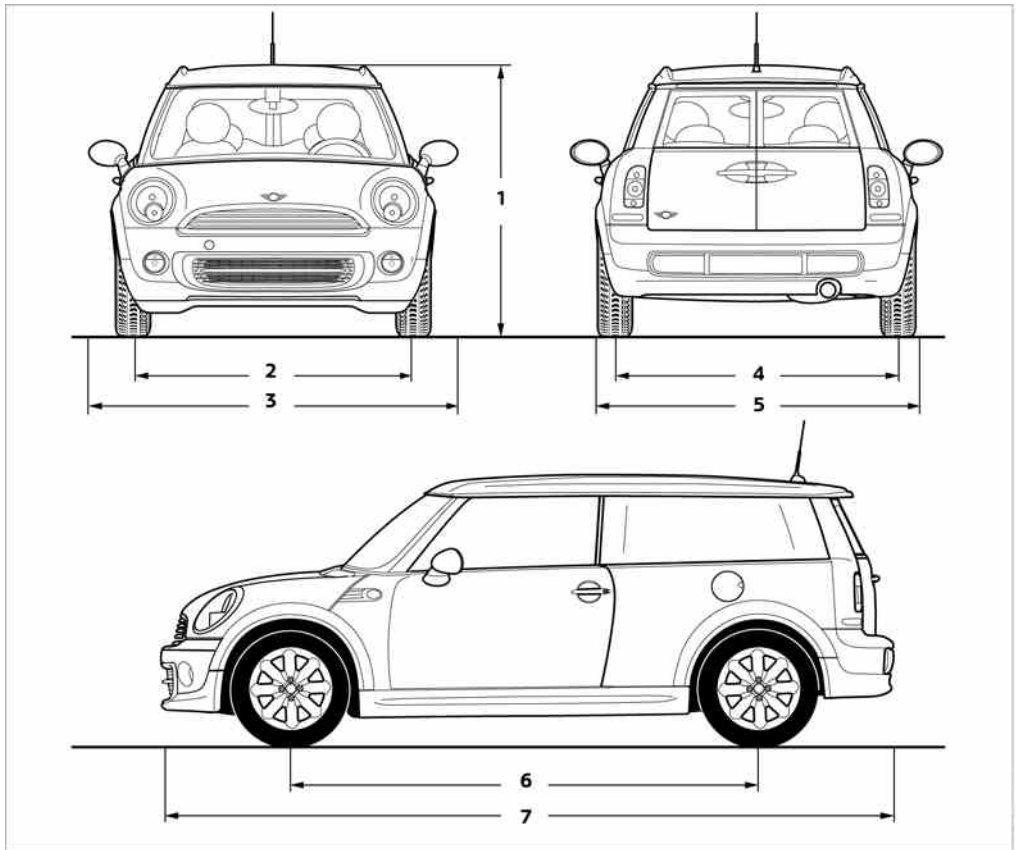

		Cooper	Cooper S, John Cooper Works
1	Vehicle height without roof antenna	56.1/1,426	56.4/1,432
2	Track, front	57.4/1,459	57.2/1,453
3	Vehicle width, with outside mirror	75.3/1,913	75.3/1,913
4	Track, rear	57.8/1,467	57.5/1,461
5	Vehicle width, without outside mirror	75.3/1,913	75.3/1,913
6	Wheelbase	100.3/2,547	100.3/2,547
7	Vehicle length	155.9/3,961	155.9/3,961
All dimensions in inches/mm. Minimum turning radius dia.: 36 ft/11.0 m.			

WEIGHTS

Never exceed either the approved axle loads or the gross vehicle weight.

MINI

		Cooper	Cooper S	John Cooper Works
Curb weight, ready for travel, with all optional extras				
▷ Manual transmission	lbs/kg	2,535/1,150	2,668/1,210	2,668/1,210
▷ Automatic transmission	lbs/kg	2,612/1,185	2,712/1,230	–
Approved gross weight				
▷ Manual transmission	lbs/kg	3,384/1,535	3,494/1,585	3,516/1,595
▷ Automatic transmission	lbs/kg	3,461/1,570	3,538/1,605	–
Approved front axle load				
▷ Manual transmission	lbs/kg	1,830/830	1,918/870	1,918/870
▷ Automatic transmission	lbs/kg	1,907/865	1,962/890	–
Approved rear axle load	lbs/kg	1,664/755	1,664/755	1,676/760
Approved roof load capacity	lbs/kg	165/75	165/75	165/75
Cargo area capacity	cu ft/ liters	5.7 - 24.0/ 160 - 680	5.7 - 24.0/ 160 - 680	5.7 - 24.0/ 160 - 680

MINI Clubman

		Cooper	Cooper S	John Cooper Works
Curb weight, ready for travel, with all optional extras				
▷ Manual transmission	lbs/kg	2,712/1,230	2,833/1,285	2,833/1,285
▷ Automatic transmission	lbs/kg	2,789/1,265	2,877/1,305	–
Approved gross weight				
▷ Manual transmission	lbs/kg	3,549/1,610	3,671/1,665	3,704/1,680
▷ Automatic transmission	lbs/kg	3,627/1,645	3,726/1,690	–
Approved front axle load				
▷ Manual transmission	lbs/kg	1,830/830	1,918/870	1,929/875
▷ Automatic transmission	lbs/kg	1,907/865	1,962/890	–
Approved rear axle load	lbs/kg	1,830/830	1,841/835	1,863/845
Approved roof load capacity	lbs/kg	165/75	165/75	165/75
Cargo area capacity	cu ft/ liters	9.2 - 32.8/ 260 - 930	9.2 - 32.8/ 260 - 930	9.2 - 32.8/ 260 - 930

CAPACITIES

	US gal/US quarts	Liters	Notes
Fuel tank	13.2/–	approx. 50	Fuel grade: page 195
including reserve of	2.1/–	approx. 8	
Window washer system incl. headlamp washer system	–/4.8	approx. 4.5	For more details: page 57

SHORT COMMANDS FOR THE VOICE ACTIVATION SYSTEM

VEHICLE EQUIPMENT

In this chapter, all production, country, and optional equipment that is offered in the model range is described. Equipment is also described that is not available because of, for example, selected options or country version. This also applies to safety related functions and systems.

GENERAL INFORMATION

Instructions for the voice activation system, refer to page 22.

Having the possible spoken commands read aloud: ›Voice commands‹

The following short commands apply to vehicles with voice activation system. They do not work for equipment with which only the mobile phone can be operated by voice.

USEFUL SHORT COMMANDS

Function	Command
Accessing tone control	›Tone‹
Accessing settings	›Settings‹
Accessing the onboard computer	›Onboard info‹
Accessing contacts	›Contacts‹
To display phone book	›Phonebook‹
Accessing services	›Assist‹
Selecting destination entry	›Enter address‹
Selecting route guidance	›Guidance‹

CD/MULTIMEDIA

CD drive

Function	Command
Playing a CD	›C D on‹
Selecting a CD	›Select C D‹
Selecting a CD and track	›C D ... track ...‹ e.g. CD 3 track 5
Selecting a track	›Track ...‹ e.g. track 5 or ›C D track ...‹ e.g. CD track 5
Opening the CD and Multimedia menu	›C D and multimedia‹
CD	›C D‹
Displaying entertainment details on the split screen	›Entertainment details‹

External devices

Function	Command
Selecting external devices	›External devices‹

Tone control

Function	Command
Accessing tone control	›Tone‹

RADIO

FM

Function	Command
Selecting the radio	›Radio‹
Selecting FM stations	›F M‹
Selecting manual search	›Manual‹
Selecting the frequency range	›Select frequency‹
Selecting a station	›Select station‹ e.g. WPLJ

AM

Function	Command
Selecting AM stations	›A M‹
Selecting manual search	›Manual‹

Satellite radio

Function	Command
Selecting the satellite radio	›Satellite radio‹
Switching on the satellite radio	›Satellite radio on‹
Selecting a satellite radio channel	›Select satellite radio‹ e.g. channel 2

Stored stations

Function	Command
Selecting stored stations	›Presets‹
Choosing a stored station	›Select preset‹
Selecting a stored station	›Preset ...‹ e.g. stored station 2

TELEPHONE

Function	Command
Opening the Telephone menu	›Telephone‹
To display phone book	›Phonebook‹
To redial	›Redial‹
Displaying accepted calls	›Received calls‹
Dialing a phone number	›Dial number‹
Displaying the list of messages	›Messages‹
Displaying Bluetooth devices	›Bluetooth‹

Contacts

Function	Command
Accessing contacts	›Contacts‹
My contacts	›My contacts‹
New contact	›New contact‹

Office

Function	Command
Calling up the Office menu	›Office‹
Displaying Current office	›Current office‹
Displaying contacts	›Contacts‹
Displaying messages	›Messages‹
Displaying calendar	›Calendar‹
Displaying tasks	›Tasks‹
Displaying reminders	›Reminders‹

NAVIGATION

General information

Function	Command
Navigation menu	›Navigation‹
Selecting destination entry	›Enter address‹
Entering an address	›Enter address‹
Selecting route guidance	›Guidance‹
Starting route guidance	›Start guidance‹
Ending route guidance	›Stop guidance‹
Retrieving home address	›Home address‹
Selecting route criteria	›Route preference‹

Function	Command
Selecting route	›Route information‹
Switching on the voice instructions	›Switch on voice instructions‹
Repeating a voice instruction	›Repeat voice instructions‹
Switching off the voice instructions	›Switch off voice instructions‹
Displaying the address book	›Address book‹
Displaying the last destinations	›Last destinations‹
Accessing traffic bulletins	›Traffic Info‹
Special destinations	›Points of interest‹

Map

Function	Command
Displaying the map	›Map‹
Map facing north	›Map facing north‹
Map in the direction of travel	›Map in direction of travel‹
Perspective map	›Map perspective view‹
Automatic scaling of the map	›Map with automatic scaling‹
Changing the scale	›Map scale‹

Route guidance with intermediate destinations

Function	Command
Entering a new destination	›Enter address‹

VEHICLE INFORMATION

Function	Command
Accessing the onboard computer	›Onboard info‹
Accessing the trip computer	›Trip computer‹
Accessing vehicle information	›Vehicle info‹
Accessing vehicle status	›Vehicle status‹

SETTINGS

Vehicle

Function	Command
Opening the main menu	›Main menu‹
Accessing settings	›Settings‹
Accessing options	›Options‹
Settings on the Control Display	›Control display‹
Accessing time and date settings	›Time and date‹
Accessing language and unit settings	›Language and units‹
Accessing speed limit settings	›Speed‹
Activating lighting	›Lighting‹
Selecting the door lock	›Door locks‹

EVERYTHING FROM A TO Z

INDEX

A

- ABS Antilock Brake System [71](#)
- Accessories, see Vehicle equipment [4](#)
- Acknowledgment signals for locking/unlocking vehicle [30](#)
- Activated-charcoal filter for automatic climate control [91](#)
- Adaptive Light Control [84](#)
- Adding engine oil [211](#)
- Additives
 - coolant [212](#)
 - engine oil [211](#)
- Address, entering [120](#)
- Address for navigation
 - entering [114](#), [120](#)
- Adjusting temperature inside the car, refer to Air conditioner [88](#)
- Adjusting temperature inside the car, refer to Automatic climate control [89](#)
- Adjusting the tone during audio operation, refer to Tone control [135](#)
- Airbags [80](#)
 - sitting safely [40](#)
 - warning lamp [81](#)
- Air conditioner [87](#)
- Air conditioning mode
 - air conditioner [88](#)
 - automatic climate control [89](#)
 - ventilation [91](#)
- Air distribution
 - automatic [90](#)
 - individual [89](#)
 - manual [89](#)
- Air flow rate [88](#), [90](#)
 - air conditioning system [88](#)
 - automatic climate control [90](#)
 - heating, ventilation [88](#)
- Airing, refer to Ventilation [91](#)
- Air outlets, refer to Air vents [87](#)
- Air pressure, checking, refer to Tire inflation pressure [197](#)
- Air recirculation, refer to Recirculated-air mode [88](#), [90](#)
- Air supply
 - air conditioner [88](#)
 - automatic climate control [89](#)
 - ventilation [91](#)
- Air vents [87](#)
- AKI, refer to Fuel grade [195](#)
- Alarm system [34](#)
- All-season tires, refer to Winter tires [208](#)
- AM, waveband [137](#)
- Ambient air, refer to Recirculated-air mode [88](#), [90](#)
- Ambient lighting [86](#)
- Antenna, care [215](#)
- Antifreeze
 - coolant [212](#)
 - washer fluid [56](#)
- Antilock Brake System ABS [71](#)
- Anti-theft alarm system, refer to Alarm system [34](#)
- Anti-theft system [29](#)
- Approved axle loads, refer to Weights [245](#)
- Approved engine oils [211](#)
- Approved gross vehicle weight, refer to Weights [245](#)
- Armrest, refer to Center armrest [97](#)
- Arrival time
 - computer [61](#)
 - route guidance [123](#)
- Ashtray [98](#)
- Assistant systems, refer to
 - Dynamic Stability Control DSC [71](#)
- Audio [134](#)
 - controls [134](#)
 - switching on/off [134](#)
 - tone control [135](#)
 - volume [135](#)
- Audio device, external [96](#)
- Automatic
 - air distribution [90](#)
 - air flow rate [90](#)
 - cruise control [57](#)
 - headlamp control [83](#)
- Automatic climate control [87](#)
 - automatic air distribution [90](#)
- Automatic transmission with Steptronic [51](#)
 - Interlock [52](#)
 - overriding selector lever lock [53](#)
 - Shiftlock [52](#)
 - sport program [53](#)
- AUTO program for automatic climate control [90](#)
- Auxiliary phone [170](#)
- AUX-In, refer to External audio device [96](#)
- AUX-In connection [147](#)
- Average fuel consumption [60](#)
 - setting the units [62](#)
- Average speed [61](#)
- Avoiding highways for navigation [123](#)
- Axle loads, refer to Weights [245](#)

B

Background lighting, refer to
Ambient lighting [86](#)

Backrests, refer to Seats [41](#)

Backup lamps
– replacing bulb [224](#), [225](#)

Band-aids, refer to First aid
pouch [233](#)

Bar, refer to Tow-starting,
towing away [236](#)

Base plate for telephone or
mobile phone
– refer to Snap-in adapter [179](#)

Bass sounds, refer to Tone
control [135](#)

Battery [231](#)
– disposal [37](#), [231](#)
– jump-starting [234](#)
– temporary power failure [231](#)

Battery renewal
– remote control [37](#)

Being towed [236](#)

Belts, refer to Safety belts [43](#)

Belt tensioner, refer to Safety
belts [43](#)

Beverage holders, refer to
Cupholders [98](#)

Black ice, refer to External
temperature warning [60](#)

Blower, refer to Air flow
rate [88](#), [90](#)

Bluetooth, activating/
deactivating [159](#), [169](#)

Bluetooth audio [151](#)
– device pairing [151](#)
– disconnecting an audio
connection [153](#)
– playback [152](#)
– unpairing device [153](#)
– what to do if... [154](#)

Bottle holders, refer to
Cupholders [98](#)

Brake Assist [71](#)

Brake fluid, refer to Service
requirements [63](#)

Brake lamps
– replacing bulbs [224](#), [225](#)

Brake pads, breaking in [102](#)

Brake rotors [104](#)
– brakes [102](#)
– breaking in [102](#)

Brakes
– ABS [71](#)
– breaking in [102](#)
– MINI Maintenance
System [213](#)
– parking brake [51](#)
– service requirements [63](#)

Brakes, refer to Braking
safely [103](#)

Brake system [102](#)
– breaking in [102](#)
– disc brakes [104](#)
– MINI Maintenance
System [213](#)

Breakdown service, refer to
Roadside Assistance [233](#)

Breaking in the clutch [102](#)

Break-in period [102](#)

Bulb changing, refer to Lamps
and bulbs [221](#)

Button for starting the
engine [49](#)

Buttons on the steering
wheel [11](#)

C

Calendar [185](#)
– displaying appointment [185](#)
– selecting calendar day [185](#)

California Proposition 65
warning [5](#)

Call
– accepting [161](#), [173](#)
– ending [161](#), [174](#)
– muting the microphone [175](#)

Calling, refer to Phone
numbers, dialing [162](#), [174](#)

Calling, refer to Telephone [97](#)

Can holders, refer to
Cupholders [98](#)

Capacities [246](#)

Car battery, refer to Vehicle
battery [231](#)

Car care [215](#)
Care [215](#)
– car-care products [215](#)
– car washes [215](#)
– CD/DVD drives [218](#)
– high-pressure washers [216](#)
– leather [217](#)
– manual washing [216](#)
– upholstery and fabrics [217](#)
– windows [216](#)
– wiper blades [216](#)

Cargo, securing [107](#)

Cargo area [104](#)
– capacity [245](#)
– Comfort Access [36](#)
– cover [104](#)
– doors, refer to Split Rear Barn
Doors [33](#)
– lamp [86](#)
– opening from outside [33](#)
– trunk lid, refer to Split Rear
Barn Doors [33](#)

Cargo area, expanding [105](#)

Cargo area doors, refer to Split
Rear Barn Doors [33](#)

Cargo area lamp [86](#)

Cargo area lid, refer to
Tailgate [33](#)

Cargo area partition net, refer
to Cargo net [106](#)

Cargo loading [106](#)
– securing cargo [107](#)
– stowing cargo [107](#)
– vehicle [104](#)

Cargo net [106](#)

Car key, refer to Keys/remote
controls [28](#)

Carpets, care [217](#)

Car phone
– installation location, refer to
Center armrest [97](#)
– refer to Telephone [97](#)

Car phone, refer to
Telephone [158](#), [168](#)

- Car radio, refer to Radio 137
 - Car wash, care 215
 - Car washes 215
 - Catalytic converter, refer to
 - Hot exhaust system 103
 - CD, audio playback 145
 - CD player 145
 - controls 134
 - fast forward/reverse 146
 - random order 146
 - selecting a track 145
 - switching on/off 134
 - tone control 135
 - volume 135
 - Center armrest 97
 - Center brake lamp 226
 - Center console, refer to
 - Around the center console 14
 - Central locking system 29
 - Comfort Access 35
 - from inside 32
 - from outside 29
 - Changing bulbs 221
 - Changing the language on the Control Display 68
 - Changing the measurement units on the Control Display 62
 - Changing wheels 228
 - Charging the battery 231
 - Chassis number, refer to
 - Engine compartment 209
 - Check Control 65
 - Child restraint fixing system LATCH 47
 - Child restraint systems 46
 - Child seats 46
 - Chrome parts, care 217
 - Chrome parts, refer to
 - Care 215
 - Cigarette lighter 98
 - Cleaning headlamps 56
 - washer fluid 57
 - Clock
 - setting time 64
 - 12 h/24 h mode 65
 - Closing
 - from inside 32
 - from outside 29
 - Clothes hooks 97
 - Club Door 32
 - Cockpit 10
 - Cold start, refer to Starting the engine 50
 - Comfort Access 35
 - replacing the battery 37
 - what to observe before entering a car wash 37
 - Comfort area, refer to Around the center console 14
 - Compartment for remote control, refer to Ignition lock 49
 - Compass 94
 - Computer 60
 - displays on Control Display 61
 - Condensation, refer to When the vehicle is parked 104
 - Condition Based Service CBS 213
 - Configuring settings, refer to Personal Profile 28
 - Connecting vacuum cleaner, refer to Connecting electrical appliances 99
 - Consumption, refer to Average fuel consumption 60
 - Contact editing 166
 - Contacts 165, 182
 - new contact 183
 - Continuing route guidance 123
 - Control Display
 - settings 62
 - Control Display, refer to iDrive
 - switching on/off 17
 - Control Display, refer to Onboard computer 17
 - Controls and displays 10
 - Control stick, refer to Onboard computer 17
 - Control unit, refer to Onboard computer 17
 - Convenience operation
 - windows 30
 - Convenient access, refer to Comfort Access 35
 - Convenient start, refer to Starting the engine 50
 - Coolant 212
 - checking level 212
 - filling 212
 - Coolant temperature 212
 - Cooling, maximum 90
 - Cooling fluid, refer to Coolant 212
 - Copyright 2
 - Cornering light, refer to Adaptive Light Control 84
 - Criteria for route 123
 - Cruise control
 - indicator lamp 13
 - Cruising range 60
 - Cupholders 98
 - Curb weight, refer to Weights 245
 - Current fuel consumption 61
 - Current playback
 - external devices 150
- ## D
- Dashboard, refer to Cockpit 10
 - Dashboard instruments, refer to Displays 12
 - Dashboard lighting, refer to Instrument lighting 85
 - Data 240
 - capacities 246
 - dimensions 241
 - engine 240
 - weights 245
 - Data memory 214
 - Date
 - setting 65
 - setting format 65
 - Daytime running lights 84

- DBC Dynamic Brake Control, refer to Brake Assist **71**
 - Deactivating front passenger airbags **80**
 - Deadlocking, refer to Locking **30**
 - Defect
 - door lock **32**
 - fuel filler flap **194**
 - Defining a home address **183**
 - Defogging windows **89, 91**
 - Defrosting windows **89, 91**
 - Defrosting windows and removing condensation
 - air conditioner **89**
 - automatic climate control **91**
 - Defrosting windshield, refer to Defrosting windows **89, 91**
 - Defrost position, refer to Defrosting windows **89, 91**
 - Deleting contacts **167, 184**
 - Destination address
 - entering **114, 120**
 - Destination for navigation
 - entering **114**
 - entering via map **119**
 - Differential, breaking in **102**
 - Digital compass **94**
 - Digital radio, refer to HD Radio **138**
 - Dimensions **241**
 - Dipstick, engine oil **210**
 - Directional indicators, refer to Turn signals **54**
 - Direction announcements, refer to Voice instructions **127**
 - Direction instructions, refer to Voice instructions **127**
 - Directory for navigation, refer to Address book **116**
 - Displacement, refer to Engine data **240**
 - Display, refer to Onboard computer controls **17**
 - Displaying contact pictures **184**
 - Displaying contacts **166**
 - Displaying special destinations **119**
 - Display lighting, refer to Instrument lighting **85**
 - Displays **12**
 - instrument cluster **12**
 - on the Control Display **17**
 - Displays, care **218**
 - Displays and controls **10**
 - Disposal
 - of coolant **212**
 - remote control battery **37**
 - vehicle battery **231**
 - Distance remaining to service, refer to Service requirements **63**
 - Distance warning, refer to Park Distance Control PDC **70**
 - Door
 - rear, refer to Club Door **32**
 - Door key, refer to Integrated key/remote control **28**
 - Door lock **31**
 - Door lock, confirmation signals **30**
 - Doors, manual operation **32**
 - DOT Quality Grades **205**
 - Double doors, refer to Split Rear Barn Doors **33**
 - Drinks holders, refer to Cupholders **98**
 - Drive-off assistant, refer to Hill Assist **73**
 - Driving dynamics control, refer to Sport button **73**
 - Driving lamps, refer to Parking lamps/low beams **83**
 - Driving notes **102**
 - Driving off on inclines, refer to Hill Assist **73**
 - Driving stability control systems **71**
 - Driving through water **103**
 - Driving tips, refer to Driving notes **102**
 - Dry air, refer to Cooling function **91**
 - DSC Dynamic Stability Control **71**
 - DTC Dynamic Traction Control **72**
 - Dynamic Brake Control DBC, refer to Brake Assist **71**
 - Dynamic route guidance **129**
 - Dynamic Stability Control DSC **71**
 - Dynamic Traction Control DTC **72**
- ## E
- Eject button, refer to Buttons on the CD player **134**
 - Electrical malfunction
 - door lock **32**
 - fuel filler flap **194**
 - Electric power windows
 - initializing **38**
 - Electronic brake-force distribution **71**
 - Electronic Stability Program ESP, refer to Dynamic Stability Control DSC **71**
 - E-mail **185**
 - Emergency operation, refer to Manual operation
 - door lock **32**
 - fuel filler flap **194**
 - transmission lock, automatic transmission **53**
 - Emergency services, refer to Roadside Assistance **233**
 - Ending a call **161, 174**
 - Engine
 - breaking in **102**
 - data **240**
 - overheated, refer to Coolant temperature **212**
 - speed **240**
 - starting, Comfort Access **35**
 - Engine compartment **209**

- Engine coolant, refer to
Coolant **212**
- Engine malfunction
– indicator lamp **13**
- Engine oil
– additives, refer to Approved engine oils **211**
– alternative oil types **211**
– approved engine oils **211**
– capacity **211**
– checking level **210**
– dipstick **210**
– intervals between changes, refer to Service requirements **63**
– MINI Maintenance System **213**
- Engine oil level, checking **210**
- Engine output, refer to Engine data **240**
- Engine starting, refer to
Starting the engine **50**
- Entering destination **114**
- Entering intersection **115**
- Entertainment sound output on/off **134**
- Entry map for destination **119**
- ESP Electronic Stability Program, refer to Dynamic Stability Control DSC **71**
- Exhaust system, refer to Hot exhaust system **103**
- Exterior mirrors **44**
– adjusting **44**
– automatic heating **44**
– folding in and out **44**
- External audio device **96**
- External audio device, refer to AUX-In connection **147**
- External care **215**
- External devices
– random play sequence **150**
– software update **154**
- External temperature display
– change units of measure **62**
– in the onboard computer **62**
- Eyes
– for tow-starting and towing away **235**
– for tying down loads **107**
- ## F
- Failure messages, refer to Check Control **65**
- Failure of an electrical consumer **232**
- Fastening safety belts, refer to Safety belts **43**
- Fastest route for navigation **123**
- Fast forward
– CD player **146**
- Fault messages, refer to Check Control **65**
- Filter
– microfilter/activated-charcoal filter for automatic climate control **91**
– microfilter for air conditioner **89**
- Fine wood, care **218**
- First aid pouch **233**
- Fixture for remote control, refer to Ignition lock **49**
- Flash when locking/unlocking **30**
- Flat load floor **106**
- Flat tire
– run-flat tires **207**
– Tire Pressure Monitor TPM **76**
- Flat Tire Monitor FTM **73**
– indicating a flat tire **75**
– initializing the system **74**
– snow chains **74**
– system limits **74**
- Flat tires, refer to Tire condition **206**
- Floor mats, care **217**
- Floor plate, refer to Flat load floor **106**
- FM, waveband **137**
- Fog lamps
– replacing bulb **222, 225**
- Folding rear seat backrest **105**
- Footbrake, refer to Braking safely **103**
- Footwell lamps **86**
- For your own safety **5**
- Front airbags **80**
- Front fog lamps **85**
– replacing bulb **222**
- Front seat adjustment **41**
- Frost on windows, refer to Defrosting windows **89, 91**
- FTM, refer to Flat Tire Monitor **73**
- Fuel **195**
– gauge **59**
– high-quality brands **195**
– quality **195**
– specifications **195**
– tank capacity **246**
- Fuel clock, refer to Fuel gauge **59**
- Fuel consumption display
– average fuel consumption **60**
- Fuel display, refer to Fuel gauge **59**
- Fuel filler flap **194**
– releasing in the event of electrical malfunction **194**
- Fuses **232**
- ## G
- Garage door opener, refer to Integrated universal remote control **92**
- Gasoline
– refer to Average fuel consumption **60**
- Gasoline, refer to Required fuel **195**
- Gasoline display, refer to Fuel gauge **59**
- Gear indicator
– automatic transmission with Steptronic **52**

Gear shifting
 – automatic transmission **52**
 – manual transmission **51**
 Gearshift lever
 – automatic transmission with Steptronic **52**
 – manual transmission **51**
 General driving notes **102**
 Glass roof, electric **37**
 – convenience operation **30, 31**
 – opening, closing **38**
 – remote control **30**
 – tilting **37**
 Glove compartment **96**
 GPS navigation, refer to Navigation system **112**
 Grills, refer to Air vents **87**
 Gross vehicle weight, refer to Weights **245**

H

Halogen lamps
 – replacing bulb **222**
 Handbrake, refer to Parking brake **51**
 Hands-free device
 Bluetooth **158**
 Hands-free system **14, 165, 177**
 Hazard warning flashers **14**
 HD Radio **138**
 Head airbags **80**
 Headlamp control, automatic **83**
 Headlamp flasher **54**
 – indicator lamp **11, 13, 88, 91**
 Headlamp glass lens **221**
 Headlamps
 – replacing bulb **222**
 Headlamps, care **216**
 Head Light, refer to Adaptive Light Control **84**
 Head restraints **42**
 – sitting safely **40**

Heated
 – mirrors **44**
 – rear window **89, 91**
 – seats **43**
 Heating **87**
 – mirrors **44**
 – rear window **89, 91**
 – seats **43**
 Heavy loads, refer to Stowing cargo **107**
 Height, refer to Dimensions **241**
 Height adjustment
 – seats **41**
 – steering wheel **45**
 High beams **85**
 – headlamp flasher **85**
 – indicator lamp **13, 88, 91**
 – replacing bulb **222**
 High water, refer to Driving through water **103**
 Highway, refer to Route criteria **123**
 Hill Assist **73**
 Hills **103**
 Holders for cups **98**
 Homepage **4**
 Hood **210**
 Horn **10**
 Hot exhaust system **103**
 Hydroplaning **103**

I

IBOC, refer to HD Radio **138**
 iDrive
 – status information **20**
 Ignition **49**
 – switched off **50**
 – switched on **49**
 Ignition key, refer to Integrated key/remote control **28**
 Ignition key position 1, refer to Radio readiness **49**
 Ignition key position 2, refer to Ignition on **49**

Ignition lock **49**
 Imprint **2**
 Incoming call **161, 173**
 Indicator and warning lamps **13**
 – Tire Pressure Monitor TPM **77**
 Indicator lighting, refer to Instrument lighting **85**
 Individual air distribution **89**
 Individual settings, refer to Personal Profile **28**
 Inflation pressure monitoring, refer to Tire Pressure Monitor TPM **76**
 Information
 – on another location **118**
 – on current position **118**
 – on destination location **118**
 Initializing
 – Flat Tire Monitor FTM **74**
 – glass roof, electric **38**
 – radio, refer to Station, storing **138**
 Initializing the
 – compass, see Calibration **95**
 Instructions for navigation system, refer to Voice instructions **127**
 Instrument cluster, refer to Displays **12**
 Instrument lighting **85**
 Instrument panel, refer to Cockpit **10**
 Instrument panel, refer to Displays **12**
 Integrated key **28**
 Integrated universal remote control **92**
 Interactive map **119**
 Interesting destination for navigation **118**
 Interior lamps **86**
 – remote control **30**
 Interior rearview mirror **44**
 – automatic dimming feature **44**
 Interlock **52**

Intermittent mode of the wipers **55**

Internal care **217**

Internet page **4**

J

Jacking points **230**

Jets, refer to Window washer nozzles **56**

Joystick, refer to Onboard computer **17**

Jumping, refer to Jump-starting **234**

Jump-starting **234**

K

Key, refer to Keys/remote controls **28**

Keyless-Go, refer to Comfort Access **35**

Keyless opening and closing, refer to Comfort Access **35**

Key Memory, refer to Personal Profile **28**

Keypad dialing **163, 175**

Kickdown **52**

– automatic transmission with Steptronic **52**

Knock control **195**

L

Lamps, refer to Parking lamps/ Low beams **83**

Lamps and bulbs, replacing bulbs **221**

Lashing eyes, refer to Securing cargo **107**

Last destinations **117**

LATCH child restraint fixing system **47**

Leather care **217**

LEDs light-emitting diodes **221**

Length, refer to Dimensions **241**

License plate lamp

– bulb replacement **225, 226**

Light alloy wheels, care **217**

Light-emitting diodes

LEDs **221**

Lighter **98**

– socket **99**

Lighting

– lamps and bulbs **221**

– of the instruments **85**

– of vehicle, refer to Lamps **83**

Light switch **83**

Limit, refer to Speed limit **67**

Load **106**

Load securing equipment, refer to Securing cargo **107**

Lock buttons of doors, refer to Locking **32**

Locking

– adjusting confirmation signal **30**

– from inside **32**

– from outside **30**

– without remote control, refer to Comfort Access **35**

Locking and unlocking doors

– confirmation signals **30**

– from inside **32**

– from outside **29**

Longlife oils

– approved motor oils **211**

Low beams **83**

– automatic **83**

– replacing bulb **222**

Lower back support, refer to Lumbar support **41**

Luggage compartment, refer to Cargo area **33**

Luggage compartment doors, refer to Split Rear Barn

Doors **33**

Luggage compartment lid, refer to Tailgate **33**

Luggage compartment partition net, refer to Cargo net **106**

Luggage rack, refer to Roof-mounted luggage rack **108**

Lumbar support **41**

M

M+S tires, refer to Winter tires **208**

Main menu **18**

Maintenance, refer to Service and Warranty Information Booklet for US models and Service Guide Booklet for Canadian models

Maintenance system **213**

Malfunction warnings, refer to Check Control **65**

Manual air distribution **89**

Manual mode

– automatic transmission with Steptronic **53**

Manual operation

– door lock **32**

– fuel filler flap **194**

– transmission lock, automatic transmission **53**

Manual transmission **51**

Manual washing **216**

Map

– changing scale **126**

Map for navigation

– entering destination **119**

Master key, refer to Integrated key/remote control **28**

Maximum cooling **90**

Maximum speed

– with winter tires **208**

Medical assistance, refer to First aid pouch **233**

MENU button **17**

Menus, refer to Onboard computer **17**

Messages **184**

- Microfilter
 - for air conditioner [89](#)
 - for automatic climate control [91](#)
 - MINI Maintenance System [213](#)
 - Microfilter/activated-charcoal filter
 - MINI Maintenance System [213](#)
 - Microphone for telephone [14](#)
 - MINI Connected [189](#)
 - MINI Internet page [4](#)
 - MINI joystick, refer to Onboard computer [17](#)
 - MINI Maintenance System [213](#)
 - Mirror dimming feature [44](#)
 - Mirrors [44](#)
 - exterior mirrors [44](#)
 - heating [44](#)
 - interior rearview mirror [44](#)
 - Mobile phone
 - adjusting volume [161](#), [173](#)
 - connecting, refer to Mobile phone, pairing [158](#), [169](#)
 - installation location, refer to Center armrest [97](#)
 - pairing [158](#), [169](#)
 - refer to Telephone [97](#)
 - what to do if.... [160](#), [172](#)
 - Mobile phone, installation location, refer to Center armrest [97](#)
 - Mobile phone preparation Bluetooth [168](#)
 - Mobility Kit [226](#)
 - Modifications, technical, refer to For your own safety [5](#)
 - Monitor, refer to MINI controls with navigation [17](#)
 - Monitoring system for tire pressures, refer to Flat Tire Monitor [73](#)
 - Multifunctional steering wheel, refer to Buttons on the steering wheel [11](#)
 - Multifunction switch
 - refer to Turn signals/headlamp flasher [54](#)
 - refer to Wiper system [55](#)
- ## N
- Navigation
 - storing current position [116](#)
 - Navigation data [112](#)
 - Navigation destination
 - entering manually [114](#), [120](#)
 - home address [117](#)
 - Navigation instructions, refer to Switching voice instructions on/off [127](#)
 - Navigation system [112](#)
 - address book [116](#)
 - bypassing a route section [124](#)
 - continuing route guidance [123](#)
 - destination entry [114](#)
 - dynamic route guidance [129](#)
 - entering a destination manually [114](#), [120](#)
 - planning a trip [121](#)
 - route list [124](#)
 - selecting destination via map [119](#)
 - selecting route criteria [123](#)
 - special destinations [118](#)
 - starting route guidance [123](#)
 - terminating route guidance [123](#)
 - voice instructions [127](#)
 - volume adjustment [127](#)
 - Neck support, refer to Head restraints [42](#)
 - Nets, refer to Storage compartments [97](#)
 - New tires [207](#)
 - North-facing map [125](#)
 - Notes [186](#)
 - Number of cylinders, refer to Engine data [240](#)
 - Number of safety belts [40](#)
 - Nylon rope, refer to Tow rope [236](#)
- ## O
- OBD socket, refer to Socket for On-Board Diagnosis [214](#)
 - Octane ratings, refer to Fuel specifications [195](#)
 - Odometer [60](#)
 - Office [181](#)
 - current office [181](#)
 - what to do if.... [187](#)
 - Oil, refer to Engine oil [210](#)
 - Oil consumption [210](#)
 - Oil level [210](#)
 - Oil types [211](#)
 - Old batteries, refer to Disposal [231](#)
 - Onboard computer [17](#)
 - adjusting brightness [68](#)
 - changing language [68](#)
 - menu guidance [18](#)
 - operating principles [17](#)
 - overview [17](#)
 - Opening and closing
 - Comfort Access [35](#)
 - from inside [32](#)
 - from outside [29](#)
 - using the door lock [31](#)
 - using the remote control [29](#)
 - Opening and unlocking
 - from inside [32](#)
 - Options, selecting for navigation [123](#)
 - Orientation menu, refer to Main menu [18](#)
 - Outlets
 - refer to Ventilation [91](#)
 - Outlets, refer to Air vents [87](#)
 - Output, refer to Engine data [240](#)
 - Outside-air mode
 - automatic climate control [90](#)
 - Overheated engine, refer to Coolant temperature [212](#)

P

- Paintwork, care [216](#)
- Park Distance Control PDC [70](#)
- Parking
 - vehicle [50](#)
- Parking aid, refer to Park Distance Control PDC [70](#)
- Parking brake [51](#)
 - indicator lamp [13](#)
- Parking lamps, replacing bulb [222](#)
- Parking lamps/low beams [83](#)
- Parts and accessories, see Vehicle equipment [4](#)
- Pathway lighting [84](#)
- Personal Profile [28](#)
- Phone numbers
 - dialing [162](#), [174](#)
- Pinch protection system
 - windows [39](#)
- Plastic parts, care [218](#)
- Pollen
 - refer to Microfilter/activated-charcoal filter for automatic climate control [91](#)
 - refer to Microfilter for air conditioner [89](#)
- Power failure [231](#)
- Power windows [38](#)
- Power windows, refer to Windows [38](#)
- Pressure, tires [197](#)
- Pressure monitoring, tires [73](#)
 - Flat Tire Monitor [73](#)
- Pressure monitoring of tires, refer to Tire Pressure Monitor TPM [76](#)
- Protective function, refer to Pinch protection system
 - windows [39](#)
- Puncture
 - Flat Tire Monitor [73](#)

R

- Radio
 - controls [134](#)
 - HD Radio [138](#)
 - satellite radio [139](#)
 - select waveband [137](#)
 - storing stations [138](#)
 - switching on/off [134](#)
 - tone control [135](#)
 - volume [135](#)
- Radio key, refer to Integrated key/remote control [28](#)
- Radio position, refer to Radio readiness [49](#)
- Radio readiness [49](#)
 - switched off [50](#)
 - switched on [49](#)
- Rain sensor [55](#)
- Random play sequence
 - external devices [150](#)
- Range, refer to Cruising range [60](#)
- Reading aloud [187](#)
- Reading lamps [86](#)
- Rear door, refer to Club Door [32](#)
- Rear doors, refer to Split Rear Barn Doors [33](#)
- Rear double doors, refer to Split Rear Barn Doors [33](#)
- Rear fog lamp [85](#)
 - indicator lamp [13](#)
 - replacing bulb [225](#)
- Rear lamps
 - bulb replacement [224](#), [225](#)
- Rear lamps, refer to Tail lamps [224](#)
- Rear seat backrest, folding [105](#)
- Rear seats
 - folding down the backrests [105](#)
- Rearview mirror
 - compass [94](#)
- Rearview mirror, refer to Mirrors [44](#)
- Rear window defroster [89](#), [91](#)
- Reception
 - quality [138](#)
 - radio station [138](#)
- Recirculated-air mode [88](#), [90](#)
- Recirculation of air, refer to Recirculated-air mode [88](#), [90](#)
- Reclining seat, refer to Backrest [41](#)
- Refueling [194](#)
- Rejecting a call [161](#), [174](#)
- Releasing
 - hood [210](#)
- Reminders [186](#)
- Remote control [28](#)
 - battery renewal [37](#)
 - Comfort Access [35](#)
 - garage door opener [92](#)
 - malfunctions [31](#), [37](#)
 - service data [213](#)
 - Split Rear Barn Doors [30](#)
- Replacement remote control [28](#)
- Replacing bulbs, refer to Lamps and bulbs [221](#)
- Replacing tires, refer to New wheels and tires [207](#)
- Reporting safety defects [6](#)
- Reserve warning, refer to Fuel gauge [59](#)
- Reservoir for washer systems [57](#)
- Reset, refer to Resetting tone settings [136](#)
- Restraint systems
 - for children [46](#)
 - refer to Safety belts [43](#)
- Reverse
 - CD player [146](#)
- Reverse gear
 - automatic transmission with Steptronic [52](#)
 - manual transmission [51](#)
- Road map [125](#)
- Roadside Assistance [233](#)
- Roadside parking lamps [85](#)
 - replacing bulb [222](#)

- Road worthiness test, refer to Service requirements [63](#)
 - Roof load capacity [245](#)
 - Roof-mounted luggage rack [108](#)
 - Rope, refer to Tow-starting, towing away [236](#)
 - Route [123](#), [124](#)
 - bypassing sections [124](#)
 - changing [123](#), [124](#)
 - changing criteria [123](#)
 - displaying arrow view [124](#)
 - displaying map view [125](#)
 - displaying streets or towns/cities [124](#)
 - selecting [123](#)
 - Route guidance [123](#)
 - bypassing a route section [124](#)
 - changing specified route [123](#)
 - distance and arrival [123](#)
 - voice instructions [127](#)
 - volume of voice instructions [127](#)
 - Route section, changing [124](#)
 - Route selection [123](#)
 - RSC Run-flat System
 - Component, refer to Run-flat tires [207](#)
 - Rubber parts, care [217](#)
 - Run-flat System Component
 - RSC, refer to Run-flat tires [207](#)
 - Run-flat tires [207](#)
 - flat tire [75](#)
 - tire inflation pressure [197](#)
 - tire replacement [207](#)
 - winter tires [208](#)
- S**
- Safety belt
 - number [40](#)
 - Safety Belt Reminder [43](#)
 - Safety belts [43](#)
 - damage [44](#)
 - indicator lamp [43](#)
 - reminder [43](#)
 - sitting safely [40](#)
 - Safety belts, care [218](#)
 - Safety systems
 - airbags [80](#)
 - Antilock Brake System ABS [71](#)
 - Dynamic Stability Control DSC [71](#)
 - safety belts [43](#)
 - Safety tires, refer to Run-flat tires [207](#)
 - Satellite radio [139](#)
 - channel, activating or deactivating [140](#)
 - channel, selecting [140](#)
 - channel, storing [141](#)
 - favorites [142](#)
 - time shift [141](#)
 - Traffic Jump [143](#)
 - Screen, refer to Onboard computer controls [17](#)
 - Screw thread for tow fitting [235](#)
 - SDARS, refer to Satellite radio [139](#)
 - Seat adjustment
 - mechanical [41](#)
 - Seats [41](#)
 - adjusting the seats [41](#)
 - heating [43](#)
 - sitting safely [40](#)
 - Securing the vehicle
 - from inside [32](#)
 - from outside [29](#)
 - Selecting navigation system [112](#)
 - Selecting new scale for navigation [126](#)
 - Selector lever
 - automatic transmission with Steptronic [52](#)
 - Selector lever lock
 - automatic transmission with Steptronic, refer to Shiftlock [52](#)
 - overriding manually [53](#)
 - Selector lever positions
 - automatic transmission with Steptronic [52](#)
 - Service, refer to Roadside Assistance [233](#)
 - Service car, refer to Roadside Assistance [233](#)
 - Service data in the remote control [213](#)
 - Service Interval Display, refer to Condition Based Service CBS [213](#)
 - Service requirement display, refer to Condition Based Service CBS [213](#)
 - Service requirements [63](#)
 - Settings
 - clock, 12 h/24 h mode [65](#)
 - date format [65](#)
 - Setting time and date [65](#)
 - Setting time zone, time, and date [65](#)
 - Shifting gears
 - automatic transmission with Steptronic [53](#)
 - manual transmission [51](#)
 - Shiftlock
 - automatic transmission, refer to Changing selector lever positions [52](#)
 - Short commands for the voice activation system [247](#)
 - Short route in navigation, refer to Selecting route [123](#)
 - Shuffled, refer to Random
 - CD player [146](#)
 - Side airbags [80](#)
 - Side door, rear, refer to Club Door [32](#)
 - Side turn signal
 - replacing bulb [224](#)

- Side windows, refer to
 - Windows [38](#)
 - Signal horn, refer to Horn [10](#)
 - Sitting safely [40](#)
 - airbags [40](#)
 - safety belts [40](#)
 - with head restraint [40](#)
 - Size, refer to Dimensions [241](#)
 - Sliding/tilt sunroof
 - refer to Glass roof, electric [37](#)
 - Slot for remote control [49](#)
 - Smokers' package, refer to
 - Ashtray [98](#)
 - Snap-in adapter
 - inserting/removing [179](#)
 - use [168](#)
 - Snap-in adapter, refer to
 - Center armrest storage compartment [97](#)
 - Snow chains [208](#)
 - Socket, refer to Connecting electrical appliances [99](#)
 - Socket for On-Board Diagnosis OBD [214](#)
 - Software update [154](#)
 - Space-saver spare tire
 - changing tires [228](#)
 - inflation pressure [197](#)
 - Spare wheel, refer to Space-saver spare tire [228](#)
 - Speaking, refer to Voice instructions from navigation system [127](#)
 - Special destinations [118](#)
 - Special oils, refer to Approved engine oils [211](#)
 - Speed [240](#)
 - with winter tires [208](#)
 - Speed limit [67](#)
 - setting [67](#)
 - Speed limit warning, refer to
 - Speed limit [67](#)
 - Speedo, refer to
 - Speedometer [12](#)
 - Speedometer [12](#)
 - Speed volume [135](#)
 - Split Rear Barn Doors [33](#)
 - opening/closing [33](#)
 - opening from outside [33](#)
 - unlocking with remote control [30](#)
 - Split rear seat backrest, refer to
 - Expanding the cargo area [105](#)
 - Sport button [73](#)
 - Stability control, refer to
 - Driving stability control systems [71](#)
 - Start/Stop button [49](#)
 - starting the engine [50](#)
 - switching off the engine [50](#)
 - Starting, refer to Starting the engine [50](#)
 - Starting assistance, refer to
 - Jump-starting [234](#)
 - Starting route guidance [123](#)
 - Starting the engine [50](#)
 - Start/Stop button [49](#)
 - Start-off assistance, refer to
 - DSC [71](#)
 - Hill Assist [73](#)
 - State/province, for navigation [114](#)
 - Station, selecting
 - radio [137](#)
 - Status information on the Control Display [20](#)
 - Status of this Owner's Manual at time of printing [4](#)
 - Steering wheel [45](#)
 - adjustment [45](#)
 - buttons on steering wheel [11](#)
 - lock [49](#)
 - shift paddles [53](#)
 - Steptronic, refer to Automatic transmission with
 - Steptronic [51](#)
 - Storage area
 - cargo area [104](#)
 - Storage compartment, front passenger side [97](#)
 - Storage compartments [97](#)
 - Storage space
 - storage compartments [97](#)
 - Storing a destination in the address book [116](#)
 - Storing the vehicle [218](#)
 - Storing tires [208](#)
 - Stowage, refer to Storage compartments [97](#)
 - Summer tires, refer to Wheels and tires [197](#)
 - SW, waveband [137](#)
 - Switches, refer to Cockpit [10](#)
 - Switching off
 - engine [50](#)
 - Switching off the engine [50](#)
 - Start/Stop button [49](#)
 - Switching on
 - audio [134](#)
 - CD player [134](#)
 - radio [134](#)
 - Switching the cooling function on and off [91](#)
 - Symbols [4](#)
 - status information [20](#)
- ## T
- Tachometer [59](#)
 - Tailgate [33](#)
 - Comfort Access [36](#)
 - Tailgate, refer to Split Rear Barn Doors [30](#)
 - Tail lamp, refer to Tail lamps [224](#)
 - replacing bulb [224](#)
 - Tail lamps [224](#)
 - Tank volume, refer to Capacities [246](#)
 - Target cursor for navigation [119](#)
 - Tasks [186](#)
 - Technical data [240](#)
 - Technical modifications [5](#)

- Telephone
 - hands-free system [165](#), [177](#)
 - installation location, refer to Center armrest [97](#)
 - voice commands [177](#)
- Telephone receiving power, refer to Status information [20](#)
- Temperature display
 - setting the units [62](#)
- Temperature of coolant, refer to Coolant temperature [212](#)
- Temperature setting
 - air conditioner [89](#)
 - automatic climate control [90](#)
- Tempomat, refer to Cruise control [57](#)
- Tensioning straps, refer to Securing cargo [107](#)
- Text message [184](#)
- Third brake lamp, refer to Center brake lamp [226](#)
- Three-point safety belt [43](#)
- Tightening the lug bolts
 - keys [219](#), [220](#)
 - torque [231](#)
- Tightening torque, refer to Tightening lug bolts [231](#)
- Tire change set
 - space-saver spare tire [219](#)
- Tire failure
 - Flat Tire Monitor [75](#)
 - indicator/warning lamp [75](#)
 - MINI Mobility Kit [226](#)
 - run-flat tires [75](#)
 - space-saver spare tire [228](#)
 - Tire Pressure Monitor [76](#)
- Tire inflation pressure [197](#)
 - loss [75](#), [76](#)
 - space-saver spare tire [197](#)
- Tire pressure monitoring, refer to Flat Tire Monitor [73](#)
- Tire Pressure Monitor TPM [76](#)
 - limitations of system [76](#)
 - resetting system [77](#)
 - warning lamp [77](#)
- Tire Quality Grading [205](#)
- Tires
 - age [206](#)
 - breaking in [102](#)
 - changing, refer to Changing wheels [228](#)
 - condition [206](#)
 - damage [206](#)
 - inflation pressure [197](#)
 - inflation pressure loss [77](#)
 - minimum tread depth [206](#)
 - new tires [207](#)
 - pressure monitoring, refer to Flat Tire Monitor [73](#)
 - pressure monitoring, refer to Tire Pressure Monitor TPM [76](#)
 - puncture [75](#)
 - size [204](#)
 - wear indicators, refer to Minimum tread depth [206](#)
 - winter tires [208](#)
 - with emergency operation properties [207](#)
- Tires with emergency operation properties, refer to Run-flat tires [207](#)
- Tires with safety features, refer to Run-flat tires [207](#)
- TMC station, refer to Traffic information [127](#)
- Tone
 - middle setting [136](#)
- Tone during audio playback
 - adjusting [135](#)
- Toolkit [219](#)
- Tools, refer to Toolkit [219](#)
- Torque [240](#)
 - lug bolts [231](#)
- Tow bar [236](#)
- Tow fitting [235](#)
 - screw thread [235](#)
- Tow fittings for tow-starting and towing away [235](#)
- Towing [235](#)
 - car with automatic transmission [236](#)
 - methods [236](#)
- Tow rope [236](#)
- Tow-starting [235](#)
- TPM, refer to Tire Pressure Monitor [76](#)
- Track
 - selecting on CD [145](#)
- Track width, refer to Dimension [241](#)
- Traction control, refer to
 - Dynamic Stability Control DSC [71](#)
- Traffic bulletins
 - categories [129](#)
- Traffic bulletins, filtering [129](#)
- Traffic congestion
 - displaying traffic information [127](#)
 - refer to Route, bypassing segments [124](#)
- Traffic information for navigation
 - displaying [128](#)
- Traffic information in navigation
 - screen display in the map view [128](#)
- Trailer operation
 - trailer loads and gross vehicle weight [245](#)
- Transmission
 - automatic transmission with Steptronic [51](#)
 - manual transmission [51](#)
 - overriding selector lever lock for automatic transmission with Steptronic [53](#)
- Transporting children safely [46](#)
- Transport securing devices, refer to Securing cargo [107](#)
- Tread depth, refer to Minimum tire tread [206](#)
- Treble, refer to Tone control [135](#)
- Trip computer [61](#)
- Trip-distance counter, refer to Trip odometer [60](#)
- Triple turn signal activation [54](#)

- Trip odometer [60](#)
 - Turning circle, refer to
 - Dimensions [241](#)
 - Turn signal [54](#)
 - front, replacing bulb [222](#)
 - indicator lamp [12, 13](#)
 - rear, replacing bulb [224](#)
 - side, replacing bulb [224](#)
 - Tying down loads, refer to
 - Cargo loading [107](#)
- U**
- Uniform Tire Quality Grading
UTQR [205](#)
 - Units
 - average fuel consumption [62](#)
 - temperature [62](#)
 - Universal garage door opener,
refer to Integrated universal
remote control [92](#)
 - Universal remote control [92](#)
 - Unlatching, refer to
 - Unlocking [36](#)
 - Unlocking
 - from inside [32](#)
 - from outside [29](#)
 - tailgate [36](#)
 - without remote control, refer
to Comfort Access [35](#)
 - Updating the navigation
data [112](#)
 - Upholstery, care [217](#)
 - USB audio interface [148](#)
 - USB interface [96](#)
 - Using contact data [187](#)
- V**
- Valve
 - dust cap [229](#)
 - Vehicle
 - battery [231](#)
 - breaking in [102](#)
 - cargo loading [104](#)
 - dimensions [241](#)
 - identification number, refer
to Engine compartment [209](#)
 - parking [50](#)
 - storage [218](#)
 - weight [245](#)
 - Vehicle equipment [4](#)
 - Vehicle jack [219, 220](#)
 - jacking points [230](#)
 - Ventilation
 - air conditioner [91](#)
 - Vents, refer to Air vents [87](#)
 - Vents, refer to Ventilation [91](#)
 - Voice commands
 - overview [22](#)
 - short commands [247](#)
 - telephone [177](#)
 - Voice instructions for
navigation system [127](#)
 - repeating [127](#)
 - switching on/off [127](#)
 - volume [127](#)
 - Voice phone book [178](#)
 - Volume [134](#)
 - audio sources [134](#)
 - mobile phone [161, 173](#)
 - voice instructions [127](#)
 - Volume balance, tone
setting [135](#)
 - Volume of cargo area [245](#)
- W**
- Warning and indicator
lamps [13](#)
 - Warning messages, refer to
Check Control [65](#)
 - Warning triangle [233](#)
 - Washer fluid [56](#)
 - capacity of reservoir [57](#)
 - Washer fluid reservoir [57](#)
 - Waste tray, refer to Ashtray [98](#)
 - Waterfall lighting, refer to
Ambient lighting [86](#)
 - Water on roads, refer to
Driving through water [103](#)
 - Waveband for radio [137](#)
 - Wear indicators in tires, refer to
Minimum tread depth [206](#)
 - Weights [245](#)
 - Welcome lamps [84](#)
 - Wheelbase, refer to
Dimensions [241](#)
 - Wheels, new [207](#)
 - Wheels and tires [197](#)
 - Wheel stud wrench
 - space-saver spare
tire [219, 220](#)
 - Width, refer to
Dimensions [241](#)
 - Windows [38](#)
 - closing [38](#)
 - convenience operation [30](#)
 - opening [38](#)
 - pinch protection system [39](#)
 - Windows, indicator on Control
Display [17](#)
 - Window washer, refer to
Washer fluid [57](#)
 - Window washer reservoir,
refer to Washer fluid
 - volume, refer to
Capacities [246](#)
 - Window washer system [55](#)
 - washer fluid [57](#)
 - washer jets [56](#)
 - Windshield
 - cleaning [56](#)
 - defrosting and removing
condensation [89, 91](#)
 - Windshield wiper blades,
changing [220](#)
 - Windshield wipers, refer to
Wiper system [55](#)
 - Winter tires [208](#)
 - setting speed limit [67](#)
 - storage [208](#)
 - Wiper blade replacement [220](#)
 - Wiper system [55](#)

Word matching principle for
navigation [121](#)
Work in the engine
compartment [210](#)
Wrench/screwdriver, refer to
Toolkit [219](#)

X

Xenon lamps
– replacing bulb [221](#)



01 40 2 903 935 ue

DRIVE ME.