

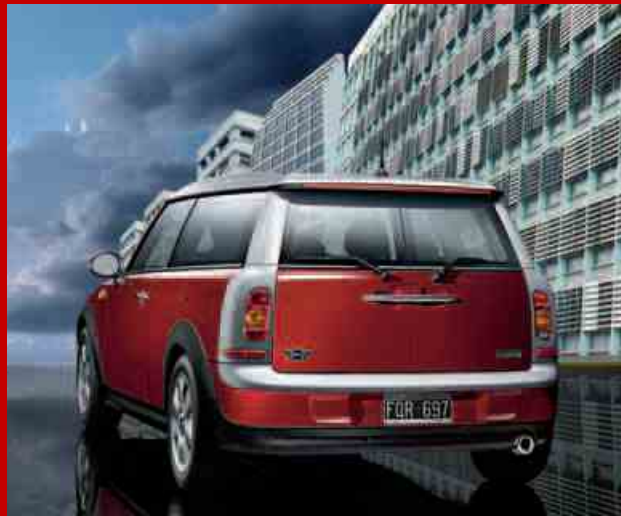

# OWNER'S MANUAL

## MINI MINI CLUBMAN





## COOPER COOPER S

### Congratulations on your new MINI

This Owner's Manual should be considered a permanent part of this vehicle. It should stay with the vehicle when sold to provide the next owner with important operating, safety and maintenance information.

We wish you an enjoyable driving experience.

© 2007 Bayerische Motoren Werke  
Aktiengesellschaft  
Munich, Germany  
Reprinting, including excerpts, only with the  
written consent of BMW AG, Munich.  
Order No. 01 41 0 014 701  
US English XI/07  
Printed in Germany  
Printed on environmentally friendly paper,  
bleached without chlorine, suitable for recycling.

# CONTENTS

The fastest way to find information on a particular topic or item is by using the index, refer to page 150.

## Using this Owner's Manual

- 4 Notes
- 6 Reporting safety defects

## AT A GLANCE 9

- 10 Cockpit

## CONTROLS 17

- 18 Opening and closing
- 30 Adjustments
- 36 Transporting children safely
- 39 Driving
- 48 Everything under control
- 57 Technology for driving comfort and safety
- 66 Lamps
- 71 Climate
- 76 Practical interior accessories

## DRIVING TIPS 83

- 84 Things to remember when driving

## MOBILITY 93

- 94 Refueling
- 96 Wheels and tires
- 106 Under the bonnet
- 110 Maintenance
- 112 Care
- 114 Replacing components
- 127 Giving and receiving assistance
- 131 Indicator and warning lamps

## REFERENCE 143

- 144 Technical data
- 150 From A to Z

# NOTES

## USING THIS OWNER'S MANUAL

We have tried to make all the information in this Owner's Manual easy to find. The fastest way to find specific topics is to refer to the detailed index at the back of the manual. If you wish to gain an initial overview of your vehicle, you will find this in the first chapter.

Should you wish to sell your MINI at some time in the future, remember to hand over this Owner's Manual to the new owner; it is an important part of the vehicle.

### Additional sources of information

Should you have any other questions, your MINI Dealer will be glad to advise you at any time.

You can find more information about the MINI, for example on its technology, on the Internet at [www.MINI.com](http://www.MINI.com).

## SYMBOLS USED

 Indicates precautions that must be followed precisely in order to avoid the possibility of personal injury and serious damage to the vehicle. ◀

 Indicates information that will assist you in gaining the optimum benefit from your vehicle and enable you to care more effectively for your vehicle. ◀

 Refers to measures that can be taken to help protect the environment. ◀

◀ Marks the end of a specific item of information.

\* Indicates special equipment, country-specific equipment and optional extras, as well as equipment and functions not yet available at the time of printing.

### Symbols on vehicle components

 Indicates that you should consult the relevant section of this Owner's Manual for information on a particular part or assembly.

## THE INDIVIDUAL VEHICLE

The manufacturer of your MINI is the Bayerische Motoren Werke Aktiengesellschaft, BMW AG.

When you ordered your MINI, you chose various items of equipment. This Owner's Manual describes the entire array of options and equipment that the manufacturer of your MINI makes available with a specific model range.

Bear in mind that the manual may contain information on accessories and equipment that you have not specified for your own vehicle. Sections describing options and special equipment are marked by asterisks \* to assist you in identifying possible differences between the descriptions in this manual and your own vehicle's equipment.

If your MINI features equipment not described in this Owner's Manual, observe the enclosed Supplementary Owner's Manuals.

## EDITORIAL NOTICE

The manufacturer pursues a policy of continuous, ongoing development that is conceived to ensure that MINI vehicles continue to embody the highest quality and safety standards combined with advanced, state-of-the-art technology. For this reason, it is possible in exceptional cases that features described in this Owner's Manual could differ from those on your vehicle.

## FOR YOUR SAFETY

### Maintenance and repair

 Advanced technology, e.g. the use of modern materials and powerful electron-

ics, requires specially adapted maintenance and repair methods. Therefore, have the necessary work on your MINI only carried out by a MINI Dealer or a workshop that has specially trained personnel working in accordance with the specifications of the MINI manufacturer. If this work is not carried out properly, there is a danger of subsequent damage and related safety hazards. ◀

### Parts and accessories

 For your own safety, use genuine parts and accessories approved by the manufacturer of the MINI.

When you purchase accessories tested and approved by the manufacturer of the MINI and Original MINI Parts, you simultaneously acquire the assurance that they have been thoroughly tested by the manufacturer of the MINI to ensure optimum performance when installed on your vehicle.

The manufacturer of the MINI warrants these parts to be free from defects in material and workmanship.

The manufacturer of the MINI will not accept any liability for damage resulting from installation of parts and accessories not approved by the manufacturer of the MINI.

The manufacturer of the MINI cannot test every product made by other manufacturers to verify if it can be used on a MINI safely and without risk to either the vehicle, its operation, or its occupants.

Original MINI Parts, MINI Accessories and other products approved by the manufacturer of the MINI, together with professional advice on using these items, are available from all MINI Dealers.

Installation and operation of non-MINI approved accessories such as alarms, radios, amplifiers, radar detectors, wheels, suspension components, brake dust shields, telephones, including operation of any mobile phone from within the vehicle without using an externally mounted antenna, or transceiver equipment, for instance, CBs, walkie-talkies, ham radios or similar accessories, may cause extensive damage to the vehicle, compromise its safety, interfere with

the vehicle's electrical system or affect the validity of the MINI Limited Warranty. See your MINI Dealer for additional information. ◀

 Maintenance, replacement, or repair of the emission control devices and systems may be performed by any automotive repair establishment or individual using any certified automotive part. ◀

### California Proposition 65 warning

California law requires us to issue the following warning:

 Engine exhaust and a wide variety of automobile components and parts, including components found in the interior furnishings in a vehicle, contain or emit chemicals known to the State of California to cause cancer and birth defects and reproductive harm. In addition, certain fluids contained in vehicles and certain products of component wear contain or emit chemicals known to the State of California to cause cancer and birth defects or other reproductive harm.

Battery posts, terminals and related accessories contain lead and lead compounds. Wash your hands after handling.

Used engine oil contains chemicals that have caused cancer in laboratory animals. Always protect your skin by washing thoroughly with soap and water. ◀

## SERVICE AND WARRANTY

We recommend that you read this publication thoroughly.

Your MINI is covered by the following warranties:

- ▷ New Vehicle Limited Warranty
- ▷ Rust Perforation Limited Warranty
- ▷ Federal Emissions System Defect Warranty
- ▷ Federal Emissions Performance Warranty
- ▷ California Emission Control System Limited Warranty

Detailed information about these warranties is listed in the Service and Warranty Information

Booklet for US models or in the Warranty and Service Guide Booklet for Canadian models.

## REPORTING SAFETY DEFECTS

### For US customers

The following applies only to vehicles owned and operated in the US.

If you believe that your vehicle has a defect which could cause a crash or could cause injury or death, you should immediately inform the National Highway Traffic Safety Administration, NHTSA, in addition to notifying MINI of North America, LLC, P.O. Box 1227, Westwood, New Jersey 07675-1227, Telephone 1-800-831-1117.

If NHTSA receives similar complaints, it may open an investigation, and if it finds that a safety defect exists in a group of vehicles, it may order a recall and remedy campaign. However, NHTSA cannot become involved in individual problems between you, your dealer, or MINI of North America, LLC.

To contact NHTSA, you may call the Vehicle Safety Hotline toll-free at 1-888-327-4236 (TTY: 1-800-424-9153); go to <http://www.safercar.gov>; or write to: Administrator, NHTSA, 400 Seventh Street, SW., Washington, DC 20590. You can also obtain other information about motor vehicle safety from <http://www.safercar.gov>

### For Canadian customers

Canadian customers who wish to report a safety-related defect to Transport Canada, Defect Investigations and Recalls, may call 1-800-333-0510 toll-free from anywhere in Canada or 1-613-993-9851 from the Ottawa region and from other countries, or contact Transport Canada by mail at: Transport Canada, ASFAD, Place de Ville, Tower C, 330 Sparks Street, Ottawa, ON, K1A 0N5.

You can also obtain other information about motor vehicle safety from <http://www.tc.gc.ca>







**AT A GLANCE**

**CONTROLS**

**DRIVING TIPS**

**MOBILITY**

**REFERENCE**

# COCKPIT

## AROUND THE STEERING WHEEL: CONTROLS AND DISPLAYS

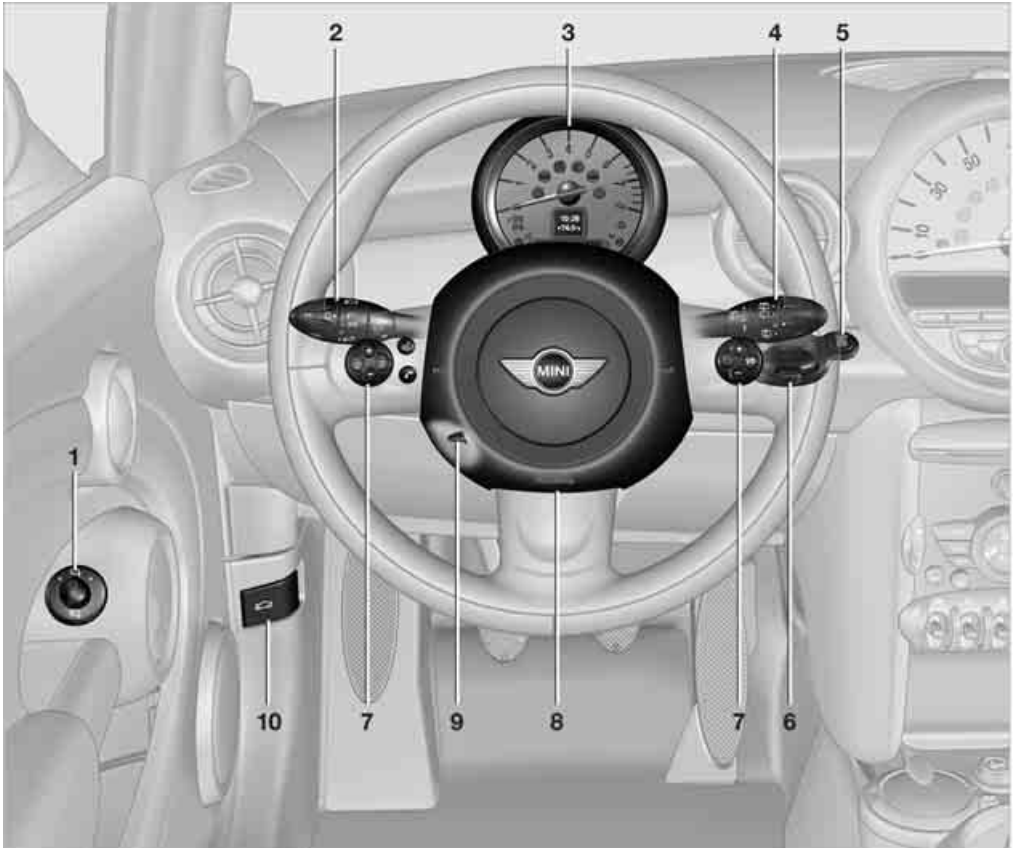



1 Adjusting the exterior mirrors, folding them in and out\* 33

2  Parking lamps 66

 Low beams 66

 Automatic headlamp control\* 66

 Turn signals 43

 High beams 68

 Headlamp flasher 43

 Roadside parking lamps\* 68

 Computer\* 49

3 Tachometer 12

 Instrument lighting 69

 Resetting the trip odometer 48

4  Wiper system 44

5  Switching the ignition on/off and starting/stopping the engine 39

6 Ignition lock 39

7 Buttons\* on steering wheel

 Continuing cruise control\* 46

 Right:  
Storing speed and accelerating or decelerating

 Left:  
Volume

 Activating/deactivating cruise control\* 47

 Telephone\*:  
Accepting and ending a call, starting dialing\* of selected phone number and redialing if no phone number is selected

 Activating/deactivating voice command system\*

 Changing radio station  
Selecting music track

 Scrolling through phone book and lists with stored phone numbers

8 Horn: the entire surface

9 Adjusting the steering wheel 34

10 Releasing the bonnet 106

DISPLAYS

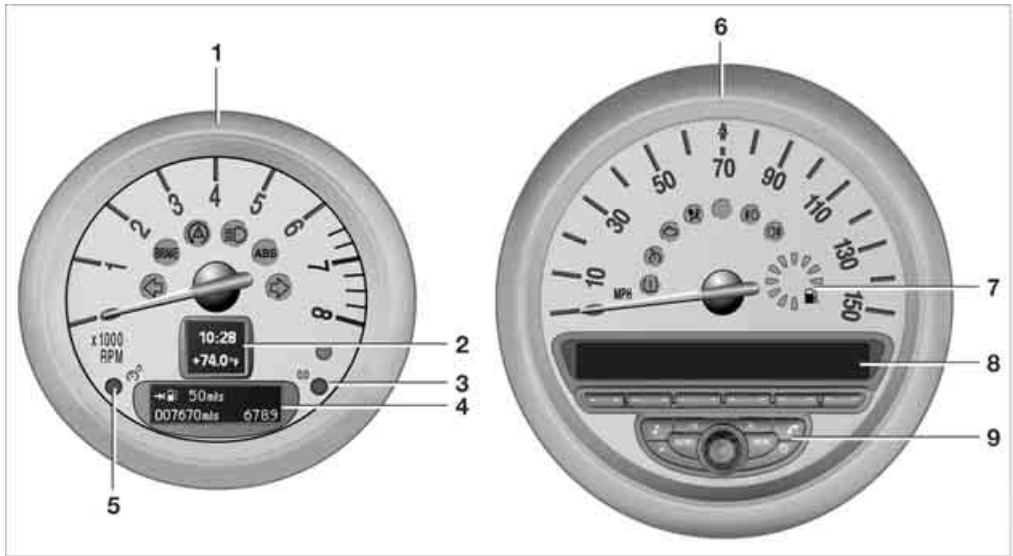

- 1 Tachometer 48  
with indicator and warning lamps 13
- 2 Display for
  - ▷ Clock 48
  - ▷ Outside temperature 48
  - ▷ Current vehicle speed 48
  - ▷ Indicator and warning lamps 13
- 3 Resetting the trip odometer 48
- 4 Display for
  - ▷ Position of automatic transmission\* 41
  - ▷ Computer\* 49
  - ▷ Date of next scheduled service, and remaining distance to be driven 53
  - ▷ Odometer and trip odometer 48
  - ▷ Initializing the Flat Tire Monitor\* 60
  - ▷ Resetting the Tire Pressure Monitor\* 61
  - ▷ Settings and information 50
  - ▷ Personal Profile settings 18
- 5 Instrument lighting 69
- 6 Speedometer  
with indicator and warning lamps 13
- 7 Fuel gauge 49
- 8 Radio display, refer to separate Owner's Manual
- 9 Radio, refer to separate Owner's Manual

# INDICATOR AND WARNING LAMPS

## The concept

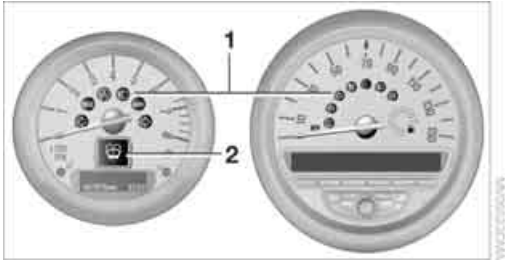

Indicator and warning lamps can light up in various combinations and colors in indicator area 1 or 2.

Some lamps are checked for proper functioning and thus come on briefly when the engine is started or the ignition is switched on.







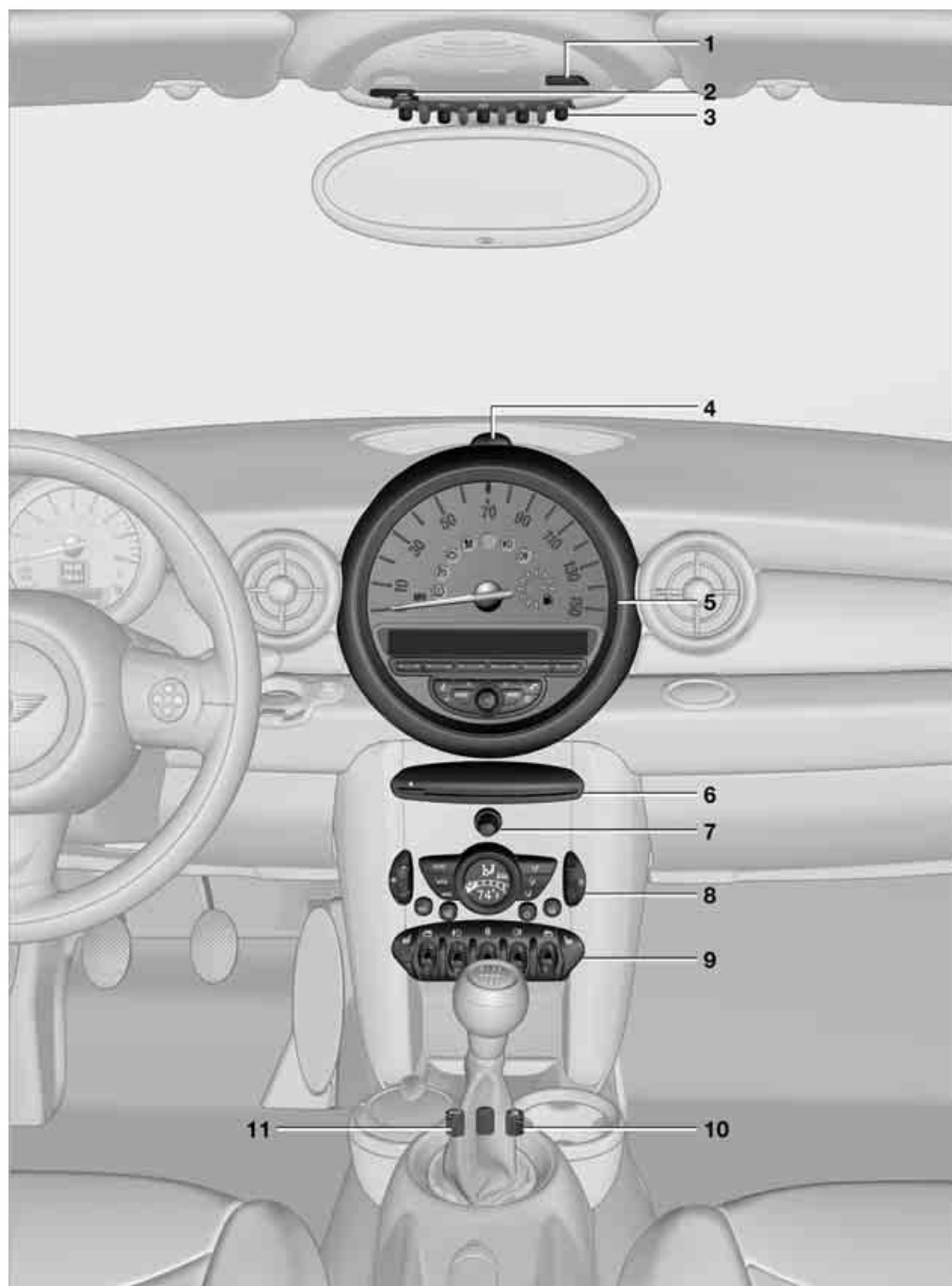



### What to do in case of a malfunction

A list of all indicator and warning lamps, as well as notes on possible causes of malfunctions and on how to respond, can be found starting on page 131.

## AROUND THE CENTER CONSOLE







- 1 Microphone for voice command system\* and for telephone in hands-free mode\* 74
- 2 Indicator/warning lamp\* for front passenger airbags 65
- 3
  -  Reading lamps\* 70
  -  Color of ambient lighting\* 70
  -  Glass sunroof, electric\* 27
  -  Interior lamps 69
- 4 Hazard warning flashers
- 5 Speedometer 12
- 6 Drive for audio CDs
- 7 Switching audio sources on/off and adjusting volume
- 8 Air conditioner or automatic climate control\*
  -  Temperature 72, 74
  -  Recirculated-air mode 72, 74
  -  Automatic recirculated-air control AUC\* and recirculated-air mode 74
  -  Air distribution for air conditioner 73
  -  Air distribution to the windshield\* 74
  -  Air distribution to the upper body area\* 74
  -  Air distribution to the footwell\* 74

**AUTO** Automatic air distribution and flow rate\* 74

**MAX** Maximum cooling\* 74

 Cooling function 72, 75

 Defrosting windows\* 73, 75

 Rear window defroster 72, 74

 Windshield heating\* 73, 75

 Air flow rate 72, 73

## 9 Switches in center console

 Seat heating\* 33

 Power windows 28

 Rear fog lamp\* 69

 Central locking system, inside 22

 Fog lamps\* 69

## 10 Driving stability control systems

▷ All-Season Traction Control ASC\* 58

▷ Dynamic Stability Control DSC\* 58

## 11 Sport button\* 59



**AT A GLANCE**

**CONTROLS**

**DRIVING TIPS**

**MOBILITY**

**REFERENCE**

# OPENING AND CLOSING

## KEYS/REMOTE CONTROLS



### Remote control

Each remote control contains a rechargeable battery that is recharged when it is in the ignition lock while the car is being driven. You should therefore use each remote control at least twice a year to maintain the charge status. In vehicles equipped with convenient access\*, the remote control contains a replaceable battery, page 27.

If more than one remote control is used, the settings called up and implemented depend on which remote control is recognized when the car is unlocked, refer to Personal Profile, page 18.

In addition, information about service requirements is stored in the remote control, refer to Service data in the remote control, page 110.

### New remote controls

Your MINI Dealer can supply new remote controls as additional units or as replacements in the event of loss.

### Integrated key

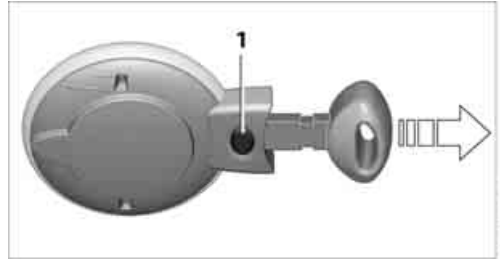

Press button 1 to release the key.

The integrated key fits the following locks:

- ▷ Driver's door, page 22

## PERSONAL PROFILE

### The concept

The functions of your MINI can be set individually. By means of Personal Profiles, most of these settings are stored for the remote control currently in use. When you unlock the car, the remote control is recognized and the settings stored for it are called up and implemented.

This means that your settings will be activated for you, even if in the meantime your car was used by someone else with another remote control and the corresponding settings.

At most three remote controls can be set for three different people. A prerequisite is that each person uses a separate remote control.

### Personal Profile settings

For more information on specific settings, refer to the specified pages.

- ▷ Response of the central locking system when the car is being unlocked 19
- ▷ Automatic locking of the vehicle 22
- ▷ Triple turn signal activation 43

- ▷ Settings for the displays on the onboard monitor, in the speedometer and in the tachometer.
  - ▷ 12h/24h mode of the clock, refer to Formats and units of measure 51
  - ▷ Date format, refer to Formats and units of measure 51
  - ▷ Units of measure for fuel consumption, distance covered/remaining distances and temperature, refer to Formats and units of measure 51
- ▷ Light settings:
  - ▷ Pathway lighting 66
  - ▷ Daytime running lamps 67
- ▷ Automatic climate control\*: AUTO program, activating/deactivating cooling function and automatic recirculated-air control, setting temperature, air flow rate and distribution 73
- ▷ Entertainment:
  - ▷ Audio volume, refer to separate Owner's Manual
  - ▷ Speed-dependent volume, refer to separate Owner's Manual

## CENTRAL LOCKING SYSTEM

### The concept

The central locking system is ready for operation whenever the driver's door is closed.

The system simultaneously engages and releases the locks on the following:

- ▷ Doors
- ▷ Tailgate/splitdoor
- ▷ Fuel filler door

### Operating from outside

- ▷ Via the remote control
- ▷ Via the door lock
- ▷ In cars with convenient access\*, via the door handles on the driver's and passenger's sides

The anti-theft system is also operated at the same time. It prevents the doors from being unlocked using the lock buttons or door handles. The remote control can also be used to switch on/off the welcome lamps and interior lamps.

### Operating from inside

Button for central locking system, page 22.

In the event of a sufficiently severe accident, the central locking system unlocks automatically. In addition, the hazard warning flashers and interior lamps come on.

## OPENING AND CLOSING: FROM OUTSIDE



Persons or animals in a parked vehicle could lock the doors from the inside. Take the key with you when you leave the vehicle so that the vehicle can be opened from the outside. ◀

### Using the remote control

#### Unlocking

Press the  button.

The welcome lamps and interior lamps come on.

#### Unlocking mode

You can also set which parts of the car are unlocked. The setting is stored for the remote control in use.

1. Switch on the ignition, refer to page 39.
2. Briefly press the button in the turn indicator lever repeatedly until "SET/INFO" is displayed.



3. Press and hold the button until the display changes.
4. Briefly press the button repeatedly until the symbol and "SET" are displayed.



5. Press and hold the button until the display changes.
6. Briefly press the button repeatedly until the display shows the illustrated symbol, arrow.

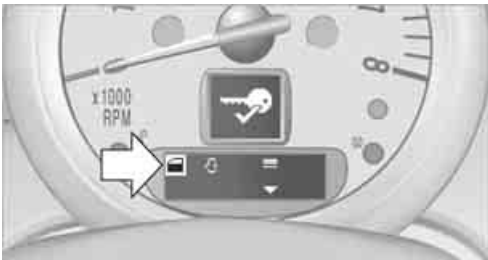

7. Press and hold the button until the display changes.
8. Briefly press the button to select:
  - ▷ Press the button once to unlock

only the driver's door and the fuel filler door.  
Press the button twice to unlock the entire vehicle.

- ▷ Press the button once to unlock the entire vehicle.

9. Press and hold the button until the display changes. The setting is stored for the remote control currently in use.

## Convenient opening

Hold the button down. The power windows are opened and the glass sunroof\* is raised.

- Convenient closing is not possible by means of the remote control. ◀

## Locking

Press the button.

- Do not lock the vehicle from the outside if there is any person inside, because the vehicle cannot be unlocked from inside without special knowledge. ◀

## Setting confirmation signals

To have the vehicle confirm when it has been locked or unlocked.

1. Switch on the ignition, refer to page 39.
2. Briefly press the button in the turn indicator lever repeatedly until "SET/INFO" is displayed.



3. Press and hold the button until the display changes.

- Briefly press the button repeatedly until the symbol and "SET" are displayed.



- Press and hold the button until the display changes.
- Briefly press the button to select, arrow:
  - ▷ Confirmation signal during unlocking
  - ▷ Confirmation signal during locking

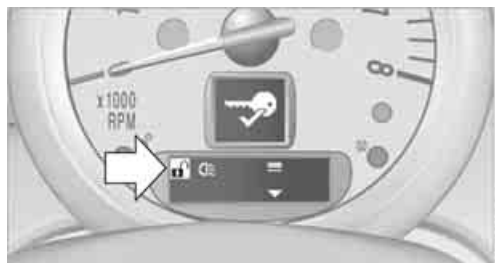

- Press and hold the button until the display changes.
- Briefly press the button to select:
  - ▷ The hazard warning flashers light up during unlocking/locking.
  - ▷ An acoustic signal sounds during unlocking/locking.
  - ▷ The hazard warning flashers light up and an acoustic signal\* sounds during unlocking/locking.
  - ▷ **off**  
The function is deactivated.
- Press and hold the button until the display changes. The setting is stored.

Acoustic signals can be selected in vehicles with an alarm system.

## Switching on interior lamps

While the car is locked:

Press the button.

You can also use this function to locate your vehicle in parking garages, etc.

## Unlocking the tailgate/splitdoor

Press the button.

When opened, the splitdoor swings backward and the tailgate swings backward and up. Ensure that there is sufficient clearance. To prevent accidentally locking yourself out, do not place the key down in the cargo bay. If the tailgate/splitdoor was locked before opening, it will be locked again after it is closed. Before and after each trip, check that the tailgate/splitdoor has not been inadvertently unlocked. ◀

## Malfunctions

The remote control may malfunction due to local radio waves. If this occurs, unlock and lock the car at the door lock with the integrated key.

If the car can no longer be locked with a remote control, the battery in the remote control is discharged. Use this remote control during an extended drive; this will recharge the battery, page 18.

## For US owners only

The transmitter and receiver units comply with part 15 of the FCC/Federal Communications Commission regulations. Operation is governed by the following:

FCC ID:  
LX8766S  
LX8766E  
LX8CAS

Compliance statement:

This device complies with part 15 of the FCC Rules. Operation is subject to the following two conditions:

- ▷ This device must not cause harmful interference, and

- ▷ This device must accept any interference received, including interference that may cause undesired operation.

 Any unauthorized modifications or changes to these devices could void the user's authority to operate this equipment. ◀

## Using the door lock

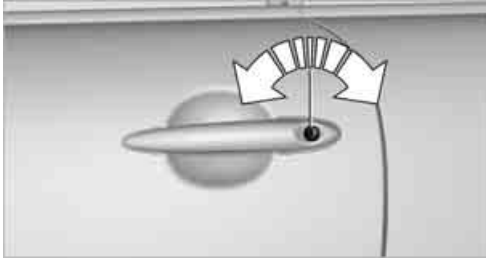

You can set which parts of the car are unlocked, page 19.

## Convenient operation

You can operate the windows and glass sunroof\* via the door lock.

Hold the key in the position for unlocking or locking.

 Watch during the closing process to be sure that no one is injured. Releasing the key stops the operation. ◀

## Manual operation

In the event of an electrical malfunction, the driver's door can be unlocked or locked by turning the integrated key in the door lock to the end positions.

## OPENING AND CLOSING: FROM INSIDE



The switch locks or unlocks the doors and tailgate when the doors are closed, but the anti-theft system is not activated. The fuel filler door remains unlocked\*.

## Unlocking and opening

- ▷ Either unlock the doors together using the switch for the central locking system and then pull the door handle above the armrest or
- ▷ pull on the door handle of either door twice: the first time unlocks the door, the second time opens it.

## Locking

- ▷ Press the switch or
- ▷ press down the safety lock button of a door. To prevent you from being locked out, the open driver's door cannot be locked using the lock button.

 Persons or animals in a parked vehicle could lock the doors from the inside. Take the key with you when you leave the vehicle so that the vehicle can be opened from the outside. ◀

## Automatic locking

You can also set the situations in which the car locks. The setting is stored for the remote control in use.



1. Switch on the ignition, refer to page 39.
2. Briefly press the button in the turn indicator lever repeatedly until "SET/INFO" is displayed.



3. Press and hold the button until the display changes.
4. Briefly press the button repeatedly until the symbol and "SET" are displayed.



5. Press and hold the button until the display changes.
6. Briefly press the button repeatedly until the display shows the illustrated symbol, arrow.

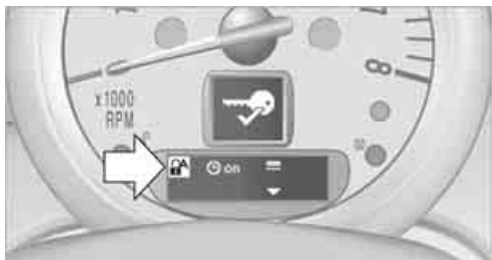

7. Press and hold the button until the display changes.
8. Briefly press the button to select:
  - ▷ on  
The central locking system automatically

locks the vehicle after some time if no door has been opened.

- ▷ on  
The central locking system automatically locks the vehicle as soon as you drive off.
- ▷ →  
The central locking system automatically locks the vehicle after some time if no door has been opened, or as soon as you drive off.
- ▷ off  
The central locking system remains unlocked.

9. Press and hold the button until the display changes. The setting is stored.

## CLUBDOOR

### MINI Clubman

#### Opening

The Clubdoor can only be opened using the handle on the inside. The right-hand front door must be open when opening the Clubdoor.



#### Closing

First close the Clubdoor, followed by the right-hand front door.

## TAILGATE/SPLITDOOR

- ▷ To avoid damage, make sure there is sufficient clearance before opening the tailgate/splitdoor. ◀

### Opening

▷ In some national-market versions, the tailgate/splitdoor cannot be unlocked using the remote control unless the vehicle is unlocked first. ◀

### MINI



Press the button in the handle, arrow, or the  button of the remote control, for an extended period. The tailgate is unlocked and can be opened.

### MINI Clubman

▷ Only drive with the splitdoor fully closed, otherwise the tail lamps will be obscured and driving safety will be compromised. ◀



Press the button in the handle or the  button of the remote control for an extended time. The splitdoor is unlocked.

Using the button in the handle, fully open first the right side, arrow 1, and then the left side of the splitdoor, arrow 2.

### Closing

⚠ Make sure that the closing path of the tailgate/splitdoor is clear, otherwise injuries may occur. ◀

### MINI



The handle recesses on the interior trim panel of the tailgate make it easier to pull it down.

### MINI Clubman

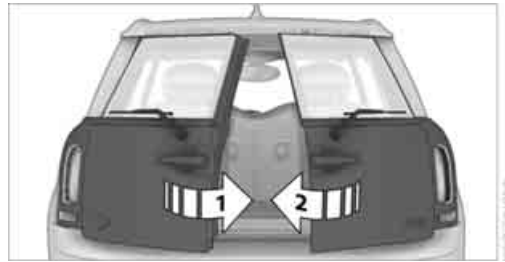

Close the left side, arrow 1, and then the right side of the splitdoor, arrow 2.

## ALARM SYSTEM\*

### The principle

The alarm system, when activated, reacts if:

- ▷ A door, the engine compartment lid or the tailgate is opened
- ▷ There is movement inside the car
- ▷ The car's inclination changes, for instance if an attempt is made to jack it up and steal the wheels or to raise it prior to towing away
- ▷ There is an interruption in the power supply from the battery

The alarm system briefly indicates unauthorized entry or tampering by means of:

- ▷ An acoustic alarm
- ▷ Switching on the hazard warning flashers

## Arming and disarming

Whenever the car is locked or unlocked, the alarm system is armed or disarmed.

Even when the alarm system is armed, you can open the tailgate by means of the  button on the remote control.

When you subsequently close the tailgate it is again locked and monitored.

 On certain national-market versions, unlocking via the door lock triggers off the alarm. ◀

## Panic mode\*

You can activate the alarm system if you find yourself in a dangerous situation.

Press the  button for at least two seconds.

Switching off the alarm:

Press any button.

## Switching off an alarm

- ▷ Unlock the car with the remote control.
- ▷ Insert the key fully into the ignition lock.
- ▷ In cars with convenient access\*, press the button on the door lock.

## Display on the revolution counter

When the system is armed, all LEDs pulse. After approx. 16 minutes one LED flashes.



- ▷ LEDs pulse or LED flashes: system is armed.
- ▷ One LED flashes at short intervals: A door, the bonnet or the tailgate is not properly closed. Even if these are not closed fully, the remaining items are deadlocked and the LEDs pulse after approx. 10 seconds for approx. 16 minutes. Afterwards, one LED flashes.

The interior movement detector is not activated.

- ▷ LEDs go out after the vehicle is unlocked: No attempt was made to tamper with the car.
- ▷ LEDs flash after unlocking until the key is inserted in the ignition, but for no longer than approx. 5 minutes: an attempt was made to tamper with the car.

## Tilt alarm sensor

The vehicle's inclination is monitored. The alarm is triggered, for instance, if an attempt is made to steal the car's wheels or tow it away.

## Interior movement detector

Before the interior movement detector can operate correctly, the windows and glass roof must be closed.

## Avoiding false alarms

The tilt alarm sensor and the interior movement detector can be switched off together.

This prevents false alarms, e.g. in the following situations:

- ▷ In duplex garages
- ▷ When being transported on car-carrying trains, ferries or trailers
- ▷ If pets are to remain inside the car

## Switching off the tilt alarm sensor and interior movement detector

- ▷ Press the  button on the remote control twice in succession.
- ▷ Lock the vehicle twice with the integrated key.

LEDs flash in short succession for approx. 2 seconds.

The tilt alarm sensor and the interior movement detector are switched off until the car is next unlocked and locked.

## CONVENIENT ACCESS\*

Convenient access enables you to enter your vehicle without having to hold the remote control in your hand. All you need to do is wear the remote control close to your body, e.g. in your jacket pocket. The vehicle automatically detects the remote control within the immediate vicinity or in the passenger compartment.

Convenient access supports the following functions:

- ▷ Unlocking/locking the vehicle
- ▷ Unlocking the tailgate/splitdoor separately
- ▷ Starting the engine
- ▷ Convenient operation

### Functional requirements

- ▷ The vehicle or the tailgate/splitdoor can only be locked when the vehicle detects that the remote control currently in use is outside of the vehicle.
- ▷ The vehicle cannot be locked or unlocked again until after approx. 2 seconds.
- ▷ The engine can only be started when the vehicle detects that the remote control is inside the vehicle.
- ▷ Doors and tailgate/splitdoor must be closed to be able to operate the windows and glass sunroof.

### Comparison to standard remote controls

In general, there is no difference between using convenient access or pressing the buttons on the remote control to carry out the functions mentioned above.

Instructions on opening and closing are found starting on page 18.

Special features regarding the use of convenient access are described below.

 If you notice a brief delay while opening or closing the windows or glass sunroof, the system is checking whether a remote control is inside the vehicle. Repeat the opening or closing procedure, if necessary. ◀

## Unlocking

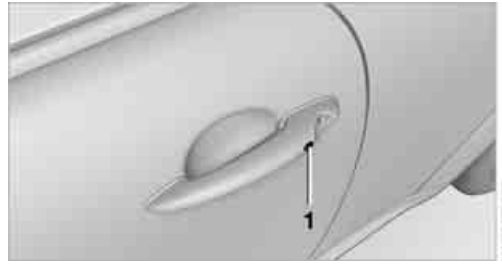

Press button 1.

Convenient opening with the remote control, refer to page 20.

## Locking

Press button 1.

For convenient closing, press and hold button 1. The power windows and the glass sunroof\* are closed.

## Unlocking the tailgate/splitdoor separately

Press the button on the outside of the tailgate/splitdoor.

 If the vehicle detects that a remote control has been accidentally left inside the locked vehicle's cargo bay after the tailgate/splitdoor is closed, the tailgate/splitdoor will reopen slightly. The hazard warning flashers flash and an acoustic signal\* sounds. ◀

## Windows and glass sunroof, electric\*

If the engine is switched off, you can still operate the windows and glass sunroof so long as a door or the tailgate/splitdoor has not been opened.

If the doors and tailgate/splitdoor are closed again and the remote control is located inside the vehicle, the windows and the glass sunroof can be operated again.

Insert the remote control into the ignition lock to be able to operate the windows or glass sunroof when the engine is switched off and the doors are open.

## Switching on radio readiness

Switch on radio readiness by briefly pressing the start/stop button, page 39.



Do not depress the brake or the clutch, otherwise the engine will start. ◀

## Starting the engine

The engine can be started or the ignition can be switched on when a remote control is inside the vehicle. It is not necessary to insert a remote control into the ignition lock, page 39.

## Switching off the engine in cars with automatic transmission

The engine can only be switched off when the selector lever is in position P, page 40. To switch the engine off when the selector lever is in position N, the remote control must be in the ignition lock.

## Before driving a vehicle with automatic transmission into a car wash

1. Insert remote control into ignition lock.
2. Depress the brake.
3. Move the selector lever to position N.
4. Switch off the engine.

The vehicle can roll.

## Malfunction

Convenient access may malfunction due to local radio waves.

If this happens, open or close the vehicle via the buttons on the remote control or using the integrated key.

Insert the remote control into the ignition lock and start the engine.

## Warning lamps



The warning lamp comes on when an attempt is made to start the engine: the engine cannot be started. The remote control is not inside the vehicle or is malfunctioning. Take the remote control with you inside the vehicle or have it checked. If necessary,

insert another remote control into the ignition lock.



The warning lamp comes on when the engine is running: the remote control is no longer inside the vehicle. After the engine is switched off, the engine can only be restarted within approx. 10 seconds.



The indicator lamp comes on: replace the battery in the remote control.

## Replacing the battery

The remote control for convenient access contains a battery that will need to be replaced from time to time.

1. Remove the cover.



2. Insert the new battery with the plus side facing up.
3. Press the cover on to close.



Take the old battery to a battery collection point or to your MINI Dealer. ◀

## GLASS SUNROOF, ELECTRIC\*



To prevent injuries, exercise care when closing the glass sunroof and keep it in your field of vision until it is shut.

Take the key with you when you leave the car, otherwise children could operate the sunroof and possibly injure themselves. ◀

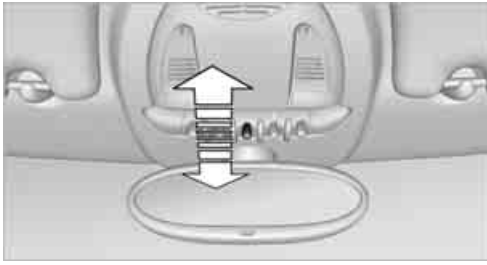

## Raising

- ▷ Press the switch backward to the resistance point and hold it there. Both glass sunroofs are raised. Releasing the switch stops the movement.
- ▷ With the ignition switched on, press the switch backward beyond the resistance point. Both closed sunroofs are raised fully. Pressing again stops the movement.

## Opening, closing

With the ignition switched on and the glass sunroof raised, press the switch backward and hold it there.

The front glass sunroof opens.

The rear glass sunroof is closed.

Releasing the switch stops the movement.

The glass sunroof can be closed in the same way by pressing the switch forward.

The front glass sunroof remains in a raised position. The rear glass sunroof is raised. Pressing on the switch again closes both sunroofs completely.

Convenient operation via door lock or convenient access, refer to page 20, 22, 26.

## Roller sun blind

The roller sun blind can be opened and closed independently of the glass sunroof.

## Following interruptions in electrical power supply

After a power failure, there is a possibility that the glass sunroof can only be raised. In this case, have the system initialized. The manufacturer of

your MINI recommends that you have this work done by your MINI Dealer.

## WINDOWS

 To prevent injuries, exercise care when closing the windows and keep them in your field of vision until they are shut.

Take the remote control with you when you leave the car, otherwise children could operate the electric windows and possibly injure themselves. ◀

 If, after a window is opened and closed several times in close succession, the window can only be closed and not opened, the system is overheated. Let the system cool for several minutes with the ignition switched on or the engine running. ◀

## Opening, closing

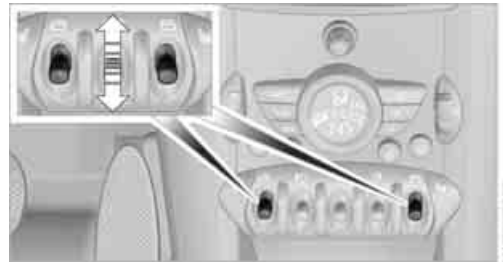

- ▷ Press the switch downwards. The window opens until you release the switch.
- ▷ Tap the switch downwards. The window opens automatically if the ignition is switched on. Tap the switch again to stop the opening movement.

The window can be closed in the same way by pressing the switch up.

## After switching off the ignition

When the ignition is switched off, the windows can still be operated for approx. 1 minute as long as no door is opened.

 Take the key with you when you leave the car, otherwise children could operate the

electric windows and possibly injure themselves. ◀

### Pinch protection system

If the closing force exceeds a specific value as a window closes, the closing action is interrupted and the window reopens slightly.

 Even though there is the pinch protection system, always ensure that the window's travel path is clear, otherwise the safety system might fail to detect certain kinds of obstructions, such as thin objects, and the window would continue closing.

Do not install any accessories that might interfere with window movement. Otherwise the pinch protection system could be impaired. ◀

### Closing without pinch protection

If there is an external danger, or if ice on the windows, etc., prevents you from closing the windows normally, the window can be closed manually.

1. Press the switch upward and hold it there. Pinch protection is limited and the window reopens slightly if the closing force exceeds a certain value.
2. Press the switch upward again within approx. 4 seconds and hold it there. The window closes without pinch protection.

# ADJUSTMENTS

## SITTING SAFELY

The ideal sitting position can make a vital contribution to relaxed, fatigue-free driving. In conjunction with the safety belts, the head restraints and the airbags, the seated position has a major influence on your safety in the event of an accident. To ensure that the safety systems operate with optimal efficiency, we strongly urge you to observe the instructions contained in the following section.

For additional information on transporting children safely, refer to page 36.

### Airbags

 Always maintain an adequate distance between yourself and the airbags. Always grip the steering wheel on the rim, with your hands in the 3 o'clock and 9 o'clock positions, to minimize the risk of injury to the hands or arms in the event of the airbag being triggered off. No one and nothing is to come between the airbags and the seat occupant.

Do not use the cover of the front airbag on the front passenger side as a storage area. Ensure that the front passenger is correctly seated, e.g. that no feet or legs are propped against the dashboard. Otherwise, leg injury could result if the front airbag suddenly deployed.

Make sure that passengers do not lean their heads against the side airbags, otherwise serious injuries could result if the airbags suddenly deployed. ◀

Even if you follow all the instructions, injuries resulting from contact with airbags cannot be fully excluded, depending on the circumstances. The ignition and inflation noise may provoke a mild hearing loss in extremely sensitive individuals. This effect is usually only temporary.

For airbag locations and additional information on airbags, refer to page 64.

### Head restraint

A correctly adjusted head restraint reduces the risk of neck injury in the event of an accident.

 Adjust the head restraint in such a way that its center is at approx. ear level. Otherwise, there is an increased risk of injury in the event of an accident. ◀

Head restraints, refer to page 32.

### Safety belt

Before every drive, make sure that all occupants wear their safety belts. Airbags complement the safety belt as an additional safety device, but they do not represent a substitute.

 Never allow more than one person to wear a single safety belt. Never allow infants or small children to ride in a passenger's lap.

Make sure that the belt in the lap area sits low across the hips and does not press against the abdomen. The safety belt must not rest against the throat, run across sharp edges, pass over hard or fragile objects or be pinched. Fasten the safety belt so that it is pulled taut across the lap and shoulder, fitting the body snugly without any twists. Otherwise the belt could slide over the hips in the event of a frontal collision and injure the abdomen. Avoid wearing bulky clothing and regularly pull the belt in the upper-body area taut, otherwise its restraining effect could be impaired. ◀

Safety belts, refer to page 33.

## SEATS

### Note before adjusting

 Never attempt to adjust your seat while the vehicle is moving. The seat could respond with unexpected movement, and the ensuing loss of vehicle control could lead to an accident.

On the front passenger seat as well, do not



incline the backrest too far to the rear while the vehicle is being driven, otherwise there is a danger in the event of an accident of sliding under the safety belt, eliminating the protection normally provided by the belt. ◀

Comply with the instructions on head restraint height on page 32 and on damaged safety belts on page 33.

### Seat adjustment

 Observe the instructions on page 30 to ensure the best possible personal protection. ◀



### Longitudinal adjustment

Pull the lever, arrow 1, and slide the seat to the desired position, arrows 2.

After releasing the lever, move the seat gently forward or back to make sure it engages properly.

### Height

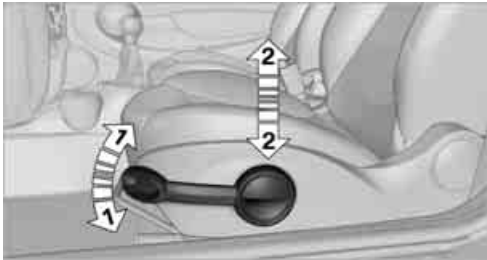

Pull up or push down the lever repeatedly, arrows 1, until the desired height is reached, arrows 2.

### Backrest

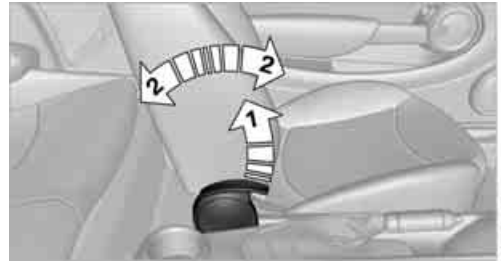

Pull the lever, arrow 1, and apply your weight to the backrest or lift it off, as necessary, arrows 2.

### Lumbar support\*

You can also adjust the contour of the backrest to obtain additional support in the lumbar region.

The upper hips and spinal column receive supplementary support to help you maintain a relaxed, upright sitting position.

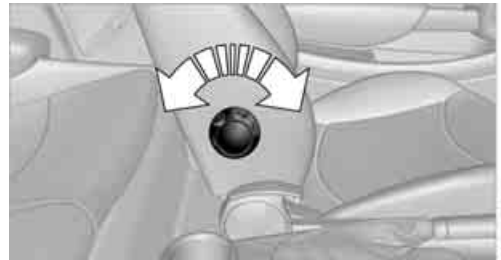

Turn the wheel to increase or decrease the curvature.

### Entry to the rear

#### Convenient entry

The convenient entry feature includes a mechanical memory function for the longitudinal adjustment and backrest angle.

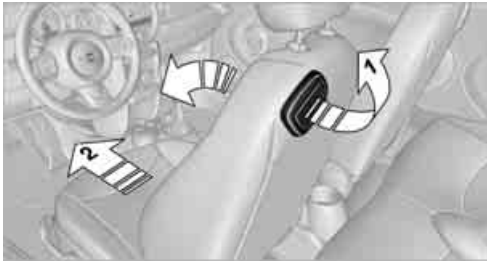

1. Pull up the lever on the seat backrest, arrow 1.  
The backrest folds forward.
2. Move the seat forward by pushing on the backrest, arrow 2.

## Previous position

1. Push the seat back into its previous position.

 Do not fold the backrest up until the seat is in its previous position. Otherwise, the seat will engage in its current position. In this case, adjust the longitudinal position manually, page 31. ◀

2. Fold the backrest back up to lock the seat.

 When moving the seat backwards, ensure that you do not cause personal injury or property damage. Before driving off, engage the front seats and seat backrests. Otherwise there is a risk of accident due to unexpected movement. ◀

## HEAD RESTRAINTS

A correctly adjusted head restraint reduces the risk of neck injury in the event of an accident.

 Adjust the head restraint in such a way that its center is at approx. ear level. Otherwise, there is an increased risk of injury in the event of an accident. Only remove a head restraint if no one will be sitting on the seat in question. Reinstall the head restraint before transporting anyone on that seat. Otherwise, the passenger will be without protection from the head restraint. ◀

## Height adjustment

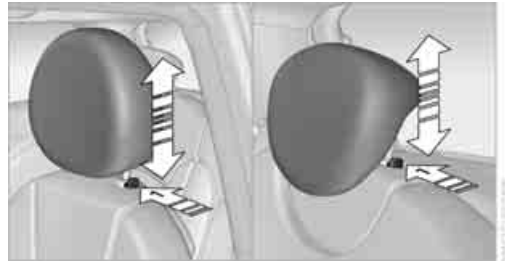

To raise: pull up.

To lower: press the button, arrow 1, and slide the head restraint down.

## Removing

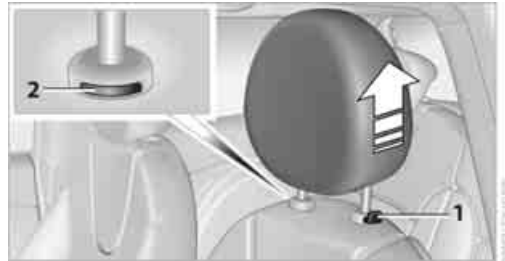

### Front

1. Pull up as far as it will go.
2. Fold the backrest forward slightly.
3. Press button 1 and pull the head restraint out as far as it will go.
4. Additionally press button 2 and pull the head restraint out completely.
5. Fold back the backrest.

### Rear

1. Pull up as far as it will go.
2. Press button 1 and pull the head restraint out completely.

## SEAT HEATING\*



### Switching on

Press once for each temperature level. Three LEDs indicate the highest temperature.

If you continue driving within the next 15 minutes, the seat heating is automatically activated at the previously set temperature.

The temperature is lowered or the heating is switched off entirely to save on battery power. The LEDs stay lit.

### Switching off

Press button longer.

## SAFETY BELTS

 Observe the instructions on page 30 to ensure the best possible personal protection. ◀

Before every drive, make sure that all occupants wear their safety belts. Airbags complement the safety belt as an additional safety device, but they do not represent a substitute.

### Front and rear seats

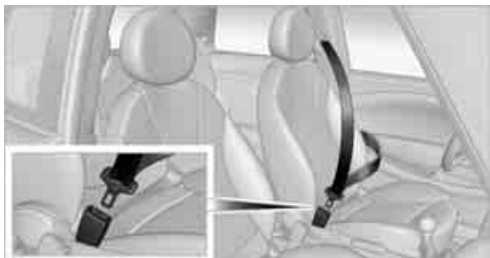

### Closing

Make sure you hear the lock engage in the belt buckle.

The upper belt anchor is suitable for adults of any stature as long as the seat is adjusted properly, page 30.

### Opening

1. Grasp the belt firmly.
2. Press the red button in the buckle.
3. Guide the belt into its reel.

### Seat belt reminder

#### Front seats



The indicator lamps come on and an acoustic signal sounds. Check whether the safety belt has been fastened correctly. The 'Fasten safety belts' reminder is issued when the driver's safety belt has not been fastened. The 'Fasten safety belts' reminder is also activated at road speeds above approx. 5 mph or 8 km/h if the front passenger's safety belt has not been fastened, if objects are placed on the front passenger seat, or if driver or front passenger unfasten their safety belts.

#### Damage to safety belts



If the safety belts are damaged or stressed in an accident: have the safety belt system and its seat-belt tensioners replaced and the belt anchors checked. Have this work carried out only by a MINI Dealer or by a workshop that has specially trained personnel working in accordance with the specifications of the MINI manufacturer, otherwise correct operation of these safety systems is not ensured. ◀

## MIRRORS

### Exterior mirrors

 The front passenger's mirror is more convex than the driver's mirror. The objects seen in the mirror are closer than they appear. Do not gauge your distance from traffic behind

you on the basis of what you see in the mirror; otherwise there is an increased risk of an accident. ◀

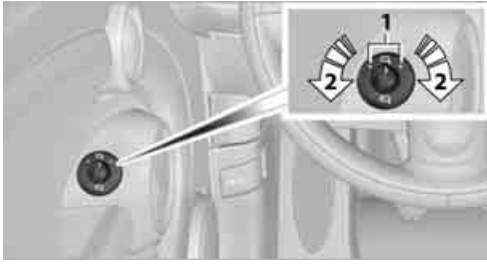

- 1 Adjusting the left or right exterior mirror
- 2 Folding mirrors in and out\*

### Manual adjustment

The mirrors can also be adjusted manually: press the edge of the glass.

### Folding mirrors in and out\*

Turn the knob beyond the pressure point in direction 2. The mirrors can be folded in at road speeds up to approx. 20 mph/30 km/h.

This can be beneficial in narrow streets, for example, or for moving mirrors that were folded in by hand back out into their correct positions.

### Automatic heating\*

At outside temperatures below a certain limit, both exterior mirrors are automatically heated while the engine is running or the ignition switched on.

### Interior rearview mirror

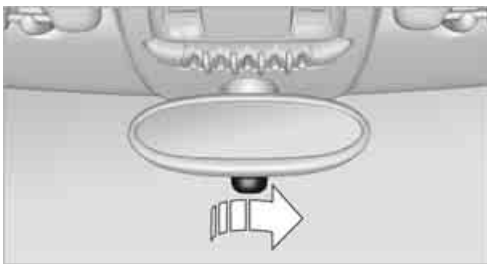

To reduce glare from vehicles behind you when you are driving at night:

Turn the knob.

### Interior mirror, automatic dimming\*



The automatic dimming feature of the interior rearview mirror\* is controlled by two photo cells in the mirror. One photo cell is in the mirror frame, arrow; the other is on the back of the mirror.

In order to ensure that the system functions correctly, keep the photo cells clean, do not cover the area between the interior rearview mirror and windshield, and do not affix adhesive labels or stickers of any kind to the windshield directly in front of the mirror.

## STEERING WHEEL

### Adjustments

 Do not adjust the steering wheel position while the car is in motion, otherwise there is a risk of accident due to an unexpected movement. ◀

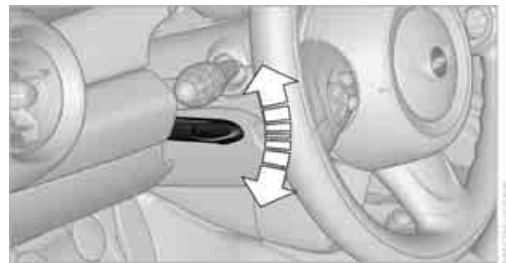

1. Fold the lever down.
2. Move the steering wheel to the preferred distance and angle to suit your seated position.

3. Swing the lever back up.



Do not use force to swing the lever back up, otherwise the mechanism will be damaged. ◀

# TRANSPORTING CHILDREN SAFELY

## THE RIGHT PLACE FOR CHILDREN

**⚠** Do not leave children unattended in the vehicle, otherwise they could endanger themselves and/or other persons by opening the doors, for example. ◀

### Children should always sit in the rear

Accident research has shown that the safest place for children is on the rear seat.

**⚠** Only transport children under the age of 13 or smaller than 5 ft/150 cm in the rear in a child-restraint system suitable for their age, weight and size. Otherwise there is an increased risk of injury in the event of an accident. ◀

Children 13 years of age or older must be buckled in with a safety belt as soon as there no longer is any child-restraint system that is appropriate for their age, size and weight.

**⚠** Only install child seats in the rear when the rear seat backrest is folded all the way back and engaged. Otherwise there will be an increased risk of injury in the event of an accident. ◀

### Exception for front passenger seat

#### Front passenger airbags

**⚠** Should it be necessary to use a child-restraint system on the front passenger seat, the front and side airbags must be deactivated. Otherwise, there is an increased risk of injury to the child if the airbags deploy, even if the child is seated in a child-restraint system. ◀

For more information on automatic deactivation of the front passenger airbags, refer to page 64.

## CHILD-RESTRAINT SYSTEMS, INSTALLATION

**⚠** Observe the child-restraint system manufacturer's instructions when selecting, installing and using child-restraint systems. Otherwise the protective effect may be diminished. ◀

### On the front passenger seat

**⚠** After installing a child-restraint system on the front passenger seat, make sure that the front and side airbags for the front passenger are deactivated, otherwise there is an increased risk of injury if the airbags deploy. ◀

### Child seat security



All rear safety belts and the safety belt for the front passenger can be prevented from being pulled out in order to secure child-restraint systems.

### To lock the safety belt

1. Secure the child-restraint system with the belt.
2. Pull the belt strap all the way out.
3. Allow the belt strap to retract and pull it taut against the child-restraint system.

The safety belt is locked.

### To unlock the safety belt

1. Open the belt buckle
2. Remove the child-restraint system.

3. Allow the safety belt strap to retract all the way.

## LATCH CHILD-RESTRAINT FIXING SYSTEM

LATCH: Lower Anchors and Tethers for Children.

 To install and use the LATCH child-restraint system, follow the operating and safety instructions provided by the manufacturer of the system, otherwise the protective function of the seat may be compromised. ◀

### Anchor points for LATCH anchors

Before installing the child's seat, pull the belt out of the area for the child-restraint fixing system.



The anchor points for the lower LATCH anchors are located behind the labeled protective caps.

 Make sure that the two LATCH anchors are properly engaged and that the child-restraint system rests firmly against the seat backrest, otherwise the protective function of the seat may be compromised. ◀

### Child-restraint system with tether strap

 Use the tether strap anchors to secure child-restraint systems only, otherwise the anchors could be damaged. ◀

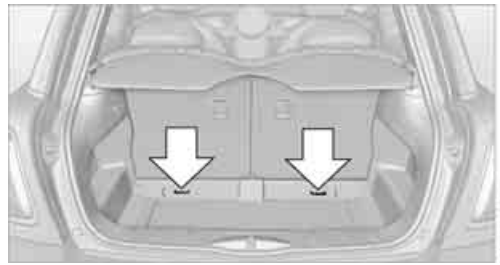

There are two additional anchors for child-restraint systems with tether straps, arrows. When the vehicle is equipped with a level load floor\*, the anchors are covered. Their positions are labeled.

### Placement of the tether strap

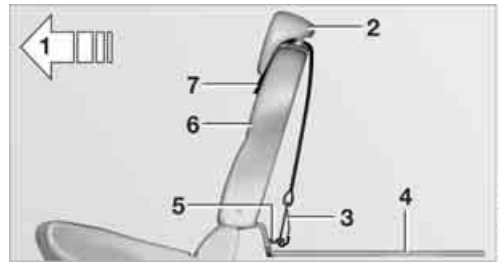

- 1 Direction of travel
- 2 Head restraint
- 3 Tether strap hook
- 4 Cargo bay floor
- 5 Anchor
- 6 Seat backrest
- 7 Tether strap of the child-restraint system

 Make sure the upper retaining strap does not run over sharp edges and is not twisted as it passes to the top anchor. Otherwise the strap will not properly secure the child-restraint system in the event of an accident. ◀

1. Push the head restraint upward.
2. Guide the tether strap between the head restraint holders.
3. Attach the tether strap to the anchor using the hook.
4. Push the head restraint into its lowermost position.

5. Pull the retaining strap tight.



# DRIVING

## IGNITION LOCK

### Inserting the key into the ignition lock

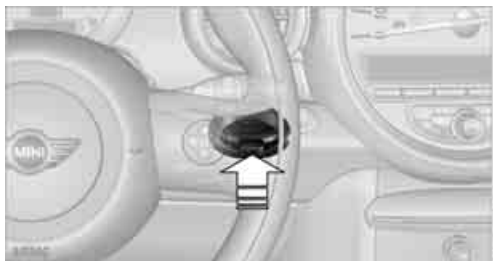

Insert the key all the way into the ignition lock.

Radio readiness

Individual electrical consumers can operate.

### Removing the key from the ignition lock

Press in the key briefly. It is ejected slightly.

At the same time:

- ▷ The ignition is switched off if it was on beforehand.

### Automatic transmission

You cannot take out the key unless the selector lever is in the P position: interlock.

## START/STOP BUTTON



Press the start/stop button to switch radio readiness or the ignition on and off. Do not depress the brake or clutch while doing so.

- ▷ When you press the start/stop button and depress the clutch if the car has manual transmission or the brake if the car has automatic transmission, the engine starts. ◀

### Radio readiness

Individual electrical consumers can operate. The time and outside temperature are displayed in the tachometer.

Radio readiness is switched off automatically:

- ▷ When the key is removed from the ignition lock
- ▷ When using convenient access\* by pushing the button on the door handle or the  button on the remote control, refer to Locking on page 26

### Ignition on

Most indicator and warning lamps in indicator area 1, page 13, light up for varying lengths of time.

- ▷ When the engine is off, switch off the ignition and any unnecessary electrical consumers in order to preserve the battery. ◀

### Radio readiness and ignition off

All indicator and warning lamps in the displays go out.

The ignition is switched off automatically when the driver's door is opened. Pressing the start/stop button again switches the ignition back on.

The ignition is not switched off in situations such as the following:

- ▷ The clutch or brake is depressed
- ▷ The low beams are switched on

## STARTING THE ENGINE

- ⚠ Do not allow the engine to run in enclosed spaces; otherwise inhalation of the noxious exhaust gases can lead to unconsciousness

and death. Exhaust gases contain carbon monoxide, an odorless and colorless, but highly toxic gas. Never leave an unattended vehicle with the engine running, otherwise such a vehicle represents a potential safety hazard.

Before leaving the car while the engine is running, place the transmission in neutral or move the selector lever to position P and forcefully apply the parking brake to prevent the car from moving. ◀

 Avoid frequent starting in quick succession or repeated start attempts in which the engine does not start. Otherwise, the fuel is not burned or inadequately burned and there is a danger of overheating and damaging the catalytic converter. ◀

Do not let the engine warm up with the vehicle at a standstill. Move off immediately at a moderate engine speed.

When starting the engine, do not depress the accelerator pedal.



### Manual transmission

Key in ignition lock or inside vehicle with convenient access, refer to page 26.

1. Depress the brake.
2. Depress the clutch.
3. Press the start/stop button.

### Automatic transmission

Key in ignition lock or in vehicle with convenient access, refer to page 26.

1. Depress the brake.
2. Move the selector lever to position P.
3. Press the start/stop button.

The starter operates automatically for a certain time, and stops automatically as soon as the engine has started.

## SWITCHING OFF THE ENGINE

 Always take the key with you when you leave the vehicle.

When parking, apply the parking brake forcefully, otherwise the vehicle could begin to roll. ◀

### Manual transmission

1. With the car at a standstill, press the start/stop button.
2. Shift into first gear or reverse.
3. Forcefully apply the parking brake.

### Automatic transmission

1. With the car at a standstill, move the selector lever to position P.
2. Press the start/stop button.
3. Forcefully apply the parking brake.

## PARKING BRAKE

The parking brake is primarily intended to prevent the vehicle from rolling while parked; it brakes the rear wheels.

### Applying

The lever locks in position automatically.

### Releasing

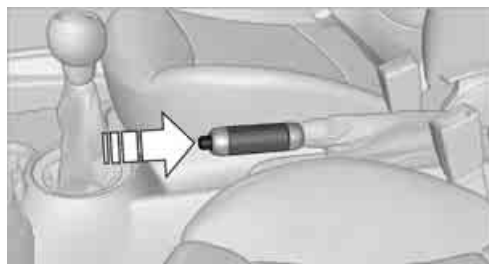

Pull slightly upwards, press the button and lower the lever.

**!** In exceptional cases, if the parking brake has to be used to slow or stop the car, do not pull the lever up too hard. In doing so, continuously press the button of the parking brake lever.

Otherwise, excessive force could lead to over-braking and loss of traction, i.e. fishtailing, at the rear axle. ◀

## MANUAL TRANSMISSION

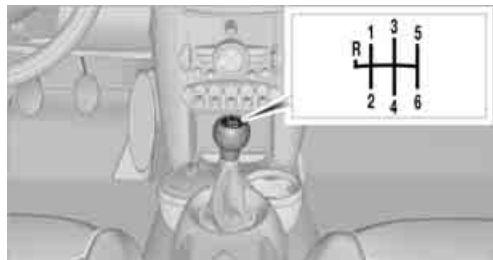

**!** When shifting into 5th or 6th gear, press the gearshift lever to the right. Otherwise the engine could be damaged if you inadvertently shift into 3rd or 4th gear. ◀

### Reverse gear

Select this only when the vehicle is stationary. When the gearshift lever is pressed to the left, a slight resistance has to be overcome.

## AUTOMATIC TRANSMISSION\* WITH STEPTRONIC

In addition to the fully automatic mode, you can shift gears manually using Steptronic, page 42.

### Parking the vehicle

**!** To prevent the vehicle from rolling, always select position P and apply the parking brake before leaving the vehicle with the engine running. ◀

### Removing the key

1. Move the selector lever to position P.
2. Switch off the engine.

3. Remove the key.

### Selector lever positions

P R N D M/S + -

### Displays in the tachometer



P R N D DS M1 to M6

The selector lever position is displayed, or the current gear in the manual mode.

### Changing selector lever positions

- ▷ The selector lever can only be moved out of position P if the ignition is switched on or the engine is running: interlock.
- ▷ Before moving the lever away from P or N with the vehicle stationary, first depress the brake; otherwise the selector lever will refuse to move: shiftlock.

**!** To prevent the vehicle from creeping after you select a driving position, depress the brake until you are ready to start. ◀

A lock prevents accidental shifting into selector lever positions R and P.

## Overriding the selector lever lock



Press the button on the front of the selector lever, arrow.

### P Park

Select this only when the vehicle is stationary. The transmission locks to prevent the drive wheels from turning.

### R Reverse

Select this only when the vehicle is stationary.

### N Neutral

Select this when you are in a car wash, for example. The vehicle can roll.

### D Drive, automatic position

Position for normal vehicle operation. All forward gears are selected automatically.

Under normal operation conditions, fuel consumption is lowest when you drive in position D.

### Kick-down

Kick-down enables you to achieve maximum performance. Depress the accelerator pedal beyond the full-throttle resistance point.

## Sport program and manual operation M/S



Move the selector lever from position D to the left into the M/S shifting slot:

The Sport program is activated and DS is displayed.

### Shifting with the selector lever

Push the selector lever forward or pull it back to activate manual operation. Steptronic shifts the gear.

- ▷ Pull the selector lever in the + direction. Transmission shifts up.
- ▷ Push the selector lever in the – direction. Transmission shifts down.

The tachometer displays M1 to M6.

To use the automatic mode again, move the selector lever to the right into position D.

Upshifts and downshifts are executed only when they will result in a plausible combination of engine and vehicle speed; thus, for example, a downshift that would cause the engine to over-rev will not be executed by the system. The selected gear is displayed briefly, followed by the actual gear.

### Shifting on the steering wheel

With the selector lever in position D, automatic drive, you can shift gears using the shift paddles on the steering wheel. The transmission automatically switches to manual mode.

If you do not shift gears with the shift paddles or accelerate for a certain amount of time, the transmission automatically returns to D, automatic drive.

## TURN SIGNALS/ HEADLAMP FLASHER



- ▷ Pull one of the shift paddles. Transmission shifts up.
- ▷ Push one of the shift paddles. Transmission shifts down.

M1 to M6 is displayed in the gear indicator.

### Overriding the selector lever lock

Should the selector lever refuse to move out of position P although the button on the selector lever is pressed, the selector lever lock can be overridden:

1. Unclip the sleeve of the selector lever.
2. Pull the sleeve up over the selector lever until the sleeve is inside out. Disconnect the cable connector if necessary.

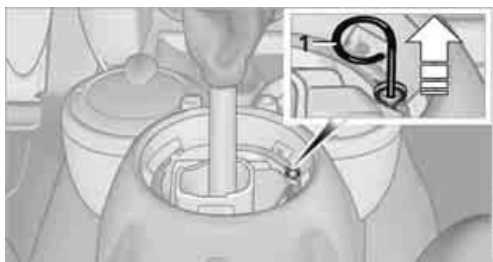

3. Take the hub cover remover 1 out of the onboard tool kit and insert it in the loop on the front passenger side.
4. Pull the loop up.
5. Move the selector lever into the desired position by pressing the button on the front of the selector lever.

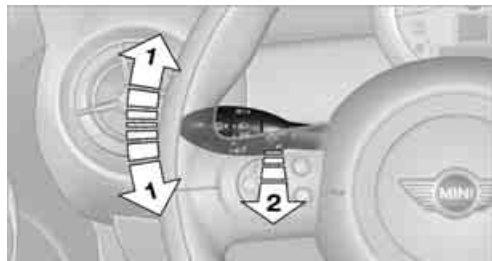

- 1 Turn signal indicator
- 2 Headlamp flasher

### Using turn signals

Press the lever beyond the resistance point.

To turn off manually, press the lever to the resistance point.

- ▶ Unusually rapid flashing of the indicator lamp indicates that an indicator bulb has failed. ◀

### Indicating a turn briefly

Press the lever as far as the resistance point for as long as you wish to indicate a turn.

### Triple turn signal activation

Press the lever as far as the resistance point.

You can set whether the turn signal is to flash once or three times.

1. Switch on the ignition, refer to page 39.
2. Briefly press the button in the turn indicator lever repeatedly until "SET/INFO" is displayed.



3. Press and hold the button until the display changes.
4. Briefly press the button repeatedly until the symbol and "SET" are displayed.



5. Press and hold the button until the display changes.
6. Briefly press the button repeatedly until the display shows the illustrated symbol, arrow.

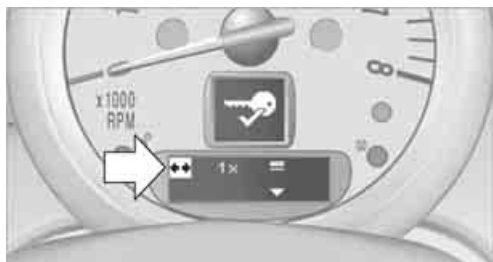

7. Press and hold the button until the display changes.
8. Briefly press the button to select:
  - ▷ 1 x  
Brief indication of a turn.
  - ▷ 3 x  
Triple turn signal.
9. Press and hold the button until the display changes. The setting is stored.

## WIPER SYSTEM

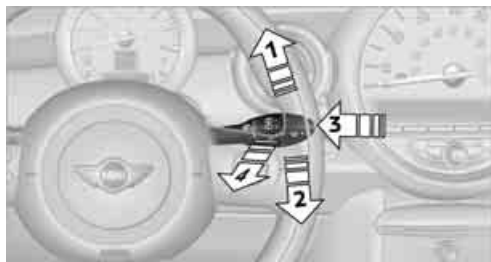

- 1 Switching on wipers
- 2 Switching off wipers or brief wipe
- 3 Activating/deactivating intermittent mode or rain sensor\*
- 4 Cleaning windshield and headlamps\*

### Switching on wipers

Press the lever upward, arrow 1.

The lever automatically returns to its initial position when released.

### Normal wiper speed

Press once.

The system switches to intermittent operation when the vehicle is stationary.

### Fast wiper speed

Press twice or press beyond the resistance point. The system switches to normal speed when the vehicle is stationary.

### Intermittent wipe or rain sensor\*

If the car is not equipped with a rain sensor, the intermittent-wipe time is preset.

If the car is equipped with a rain sensor, the time between wipes is controlled automatically and depends on the intensity of the rainfall. The rain sensor is mounted on the windshield, directly in front of the interior rearview mirror.

### Activating intermittent wipe or rain sensor

Press button, arrow 3.

 Deactivate the rain sensor before entering an automatic car wash. Failure to do so could result in damage caused by undesired wiper activation. ◀

### Adjusting the sensitivity of the rain sensor

1. Switch on the ignition, refer to page 39.
2. Briefly press the button in the turn indicator lever repeatedly until "SET/INFO" is displayed.



3. Press and hold the button until the display changes.
4. Briefly press the button repeatedly until the symbol and "SET" are displayed.



5. Press and hold the button until the display changes.



6. Press the button to select the desired sensitivity.
7. Wait for the display to change. The settings are stored.

### Deactivating intermittent wipe or rain sensor

Press the button again, arrow 3.

### Brief wipe

Press the lever downward once, arrow 2.

### Cleaning windshield and headlamps\*

Pull the lever, arrow 4.

Washer fluid is sprayed onto the windshield and the wipers are operated briefly.

When the vehicle lighting system is switched on, the headlamps are cleaned at regular and appropriate intervals.

In cars equipped with an alarm system, the headlamps cannot be cleaned when the bonnet is open.

 Do not use the washers when the washer fluid reservoir is empty, otherwise you will damage the washer pump.

Only use the washers if the bonnet has been completely closed, otherwise the headlamp washer system\* may be damaged. Do not use the washers if there is any danger that the fluid will freeze on the windshield. If you do, your vision could be obscured. For this reason, use antifreeze. ◀

## Window washer nozzles

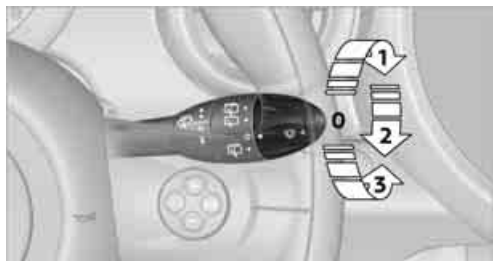

The window washer nozzles are heated automatically\* while the engine is running or the ignition is switched on.

## Rear window wiper



- 0 Rear wipers parked
- 1 To switch on intermittent wiper  :  
Turn the cap to level 1.  
Operation is continuous in reverse gear.

## Cleaning the rear window

- 2 To clean the rear window during intermittent wiper  :  
Turn the cap further to level 2 and hold it there.
- 3 To clean the rear window when wipers are parked  :  
Turn the cap to level 3 and hold it there.

 Do not use the washers when the washer fluid reservoir is empty, otherwise you will damage the washer pump. ◀

## WASHER FLUID

 Washer fluid antifreeze is flammable. Therefore, keep it away from ignition sources, store it only in the closed original container and keep it out of reach of children, otherwise there is a risk of personal injury. Comply with the instructions on the container. ◀

## Washer fluid reservoir

 Only refill washer fluid that contains anti-freeze when the engine is cool, to avoid contact with hot engine parts. Otherwise, fluid

spills constitute a fire hazard and a risk to personal safety. ◀



Fill with water and, if required, with a washer antifreeze, according to manufacturer's recommendations.

 Mix the water and antifreeze before filling the washer fluid reservoir to make sure the correct concentration is maintained. ◀

## Capacity

Approx. 2.6 US quarts/2.5 liters.

With headlamp washer system:  
Approx. 4.8 US quarts/4.5 liters.

## CRUISE CONTROL\*

### The concept

Cruise control is available at vehicle speeds of at least approx. 20 mph or 30 km/h. The car then stores and maintains the speed that you specify using the button on the steering wheel.

 Do not use cruise control when driving at constant speed is prevented by adverse conditions, e.g. winding roads, dense traffic or poor road conditions due to, e.g., snow, rain, ice or loose surfaces. Otherwise you could lose control of the vehicle and cause an accident as a result. ◀



## Activating

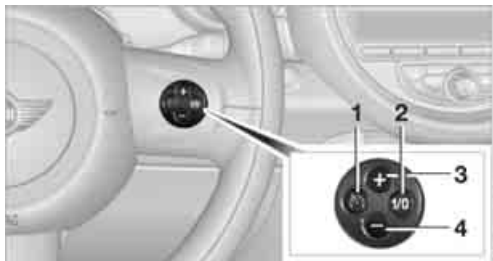

- 1 Resuming cruise control
- 2 Activating/deactivating cruise control
- 3 Maintaining, storing and increasing speed
- 4 Maintaining, storing and decreasing speed

Indicator lamp in the speedometer lights up. The cruise control system is ready and can be activated.

## Activating/deactivating cruise control

Press button **2**.

In addition, the system is automatically deactivated:

- ▷ When the brakes are applied
- ▷ When the clutch is depressed
- ▷ When the automatic transmission is in selection lever position N
- ▷ When the driving stability control system is active

Cruise control is not deactivated by depressing the accelerator pedal. Once the accelerator pedal is released, the stored speed is achieved again and maintained.

The stored speed is cleared when the ignition is switched off.

## Maintaining current speed

Press button **3**.

The system maintains and stores the current vehicle speed.

If, on a downhill grade, the engine braking effect is not sufficient, the controlled speed may be exceeded. On uphill grades vehicle speed may drop if the engine output is insufficient.

## Increasing speed

Press button **3** repeatedly until the desired speed is reached. Every time you press the button, the speed increases by approx. 1 mph or 2 km/h.

## Accelerating using the button

Press and hold button **3**.

The vehicle accelerates without pressure on the accelerator pedal. After the button is released, the driving speed is maintained and stored.

## Decreasing speed

Press button **4** repeatedly until the desired speed is reached.

The functions here are the same as for increasing the speed or accelerating, except that the speed will be decreased.

## Resuming a speed stored beforehand

Press button **1**.

The last speed stored is achieved again and maintained.

The stored speed is cleared when the ignition is switched off.

## Display in tachometer\*



Selected speed is displayed briefly.

▶ If --- mph or --- km/h is displayed briefly in the tachometer, the conditions necessary for operation may not be fulfilled. ◀

## Malfunction



The warning lamp in the tachometer lights up if the system fails.

# EVERYTHING UNDER CONTROL

## ODOMETER, OUTSIDE TEMPERATURE DISPLAY, CLOCK

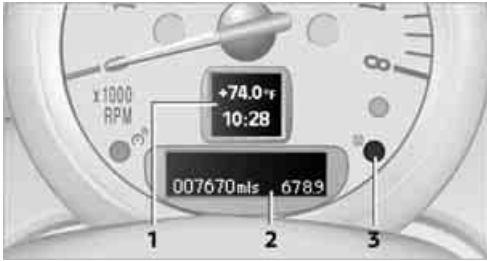

- 1 Outside temperature display and clock or current speed
- 2 Odometer and trip odometer
- 3 Resetting the trip odometer

### Units of measure

Select the respective units of measure, miles or km for the odometer as well as °F or °C for the outside temperature, page 51.

### Outside temperature display, time

Setting the time, refer to page 54.

### Outside temperature warning

When the displayed temperature sinks to approx. +37 °F / +3 °C, a signal sounds and a warning lamp lights up. There is an increased risk of black ice.

 Black ice can also form at temperatures above +37 °F / +3 °C. You should therefore drive carefully on bridges and shaded roads, for example, otherwise there is an increased risk of an accident. ◀

### Current vehicle speed

To have the current speed shown in the upper display otherwise serving for the outside temperature display and clock.

1. Press the button in the turn indicator lever repeatedly until the current speed appears in the lower display.
2. Wait for the speed display to automatically move to the upper display.

The outside temperature then appears in the lower display.

### Odometer and trip odometer

#### Resetting the trip odometer

With the ignition switched on, press knob 3 in the tachometer.

### When the vehicle is parked

To display the time, outside temperature and odometer briefly after the key is removed from the ignition lock:

Press knob 3 in the tachometer.

## TACHOMETER



Never operate the engine with the needle in the red overspeed zone of the gauge. In this range, the fuel supply is interrupted to protect the engine.

## COOLANT TEMPERATURE

A warning lamp will come on if the coolant, and therefore the engine, becomes too hot.

Check coolant level, refer to page 108.

## FUEL GAUGE

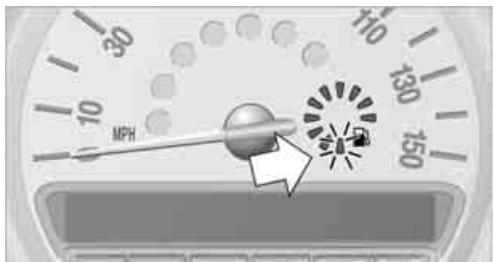

### Fuel tank capacity

You can find information on refueling on page 94.

If the tilt of the vehicle varies for a longer period, when you are driving in mountainous areas, for example, the indicator may fluctuate slightly.

### MINI Cooper, MINI Cooper S

Approx. 13.2 US gallons/50 liters.

### Reserve

Once the fuel level has fallen to the reserve zone of approx. 2.1 gallons/8 liters, the remaining indicator lamps change from orange to red, arrow. The tachometer displays the remaining cruising range. An indicator lamp comes on when the remaining range is less than approx. 30 miles/50 km.

 If the range displayed is less than 30 miles/50 km, be sure to refuel; otherwise engine functions are not guaranteed and damage could occur. ◀

## COMPUTER\*

### Displays in tachometer



Press the button in the turn indicator lever repeatedly to call up various items of information.

The following items of information are displayed in the order listed:

- ▷ Cruising range
- ▷ Average fuel consumption
- ▷ Current fuel consumption
- ▷ Average speed
- ▷ Current vehicle speed

To set the corresponding units of measure, refer to Formats and units of measure on page 51.

### Cruising range

Displays the estimated cruising range available with the remaining fuel. The range is calculated on the basis of the way the car has been driven over the last 18 miles/30 km and the amount of fuel currently in the tank.

 If the range displayed is less than 30 miles/50 km, be sure to refuel; otherwise engine functions are not guaranteed and damage could occur. ◀

### Average fuel consumption

Calculated for the time the engine has been running.

To reset average fuel consumption: press the button in the turn indicator lever for approx. 2 seconds.

### Current fuel consumption

Displays the current fuel consumption to allow you to see whether your current driving style is conducive to fuel economy with minimum exhaust emissions.

### Average speed

Periods with the vehicle parked and the engine switched off are not included in the calculations of average speed.

To reset average speed: press the button in the turn indicator lever for approx. 2 seconds.

### Current vehicle speed

To have the current speed shown in the upper display otherwise serving for the outside temperature display and clock.

1. Press the button in the turn indicator lever repeatedly until the current speed appears in the lower display.
2. Wait for the speed display to automatically move to the upper display.

The outside temperature then appears in the lower display of the computer.

## SETTINGS AND INFORMATION

### Operating principle

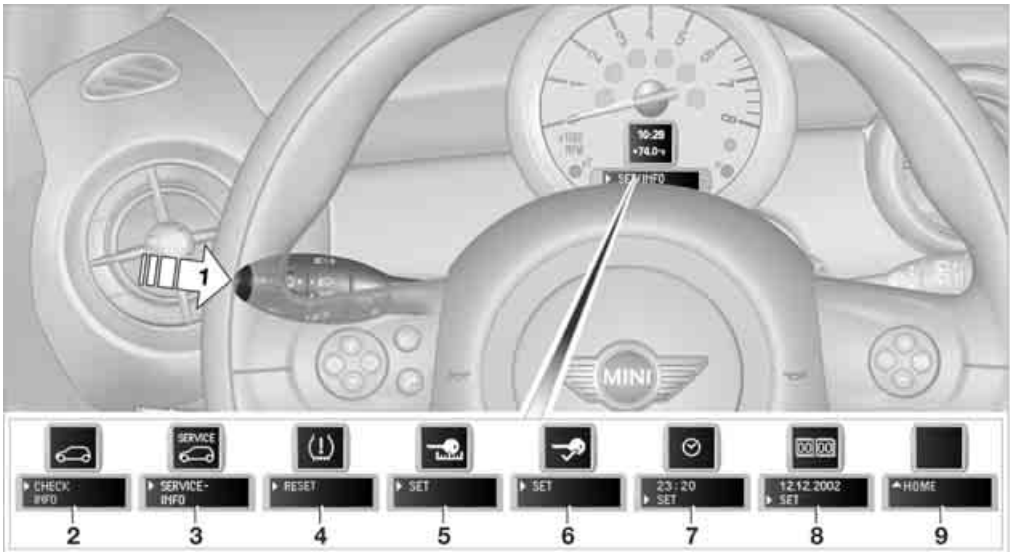

Certain settings and information are only available when the ignition is switched on, the vehicle is at a standstill and the doors are closed.

- 1 Button for:
  - ▷ Selecting display
  - ▷ Setting values
  - ▷ Confirming selected display or set values
  - ▷ Calling up computer information [49](#)
- 2 Calling up Check Control [55](#)
- 3 Displaying vehicle check [56](#)
- 4 Initializing the Flat Tire Monitor [60](#)  
Resetting the Tire Pressure Monitor [61](#)
- 5 Setting formats and units of measure, resetting to factory settings [52](#)

- 6** Adjusting settings
- ▷ Confirmation signals when locking and unlocking the vehicle **20**
  - ▷ Response during unlocking procedure **19**
  - ▷ Automatic locking **22**
  - ▷ Pathway lighting **66**
  - ▷ Daytime running lamps **67**
  - ▷ Triple turn signal activation **43**

- 7** Setting the time **54**
- 8** Setting the date **55**
- 9** Exiting the menu

## Exiting displays



1. Briefly press the button in the turn indicator lever repeatedly until "HOME" is displayed.
2. Press the button for a longer period.

The display again shows the outside temperature and the time.

Displays are also exited if no entries are made for approx. 8 seconds.

## Next setting or item of information



1. Within a setting or item of information, briefly press the button in the turn indicator lever repeatedly until "NEXT" is displayed.
2. Press the button for a longer period.

The display changes directly to the next setting or item of information.

## FORMATS AND UNITS OF MEASURE

To set the formats and units of measure. The settings are stored for the remote control currently in use, refer also to Personal Profile on page 18.

1. Switch on the ignition, refer to page 39.
2. Briefly press the button in the turn indicator lever repeatedly until "SET/INFO" is displayed.



3. Press and hold the button until the display changes.

- Briefly press the button repeatedly until the symbol and "SET" are displayed.



- Press and hold the button until the display changes.
- Briefly press the button repeatedly until the display shows the illustrated symbol, arrow.

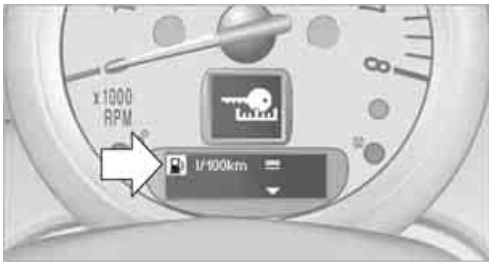

- ▷ Fuel consumption: l/100 km, mpg, km/l\*
- ▷ Distance covered: mls, km
- ▷ Time: 12h, 24h mode
- ▷ Date: day.month dd.mm, month/day mm/dd
- ▷ Temperature: °F, °C

- Press and hold the button until the display changes.
- Press the button briefly to change the format or unit of measure.
- Press and hold the button until the display changes. The settings are stored.

### Resetting to factory settings

The settings for formats and units of measure can be reset to the factory settings. The settings are stored for the remote control currently in use, refer also to Personal Profile on page 18.

- Briefly press the button in the turn indicator lever repeatedly until "SET/INFO" is displayed.



- Press and hold the button until the display changes.
- Briefly press the button repeatedly until the symbol and "SET" are displayed.



- Press and hold the button until the display changes.
- Briefly press the button repeatedly until "RESET" is displayed.



- Press and hold the button until the display changes to the first setting. The settings are reset.

## SERVICE REQUIREMENTS



The remaining driving distance and the date of the next scheduled service are briefly displayed immediately after you start the engine or switch on the ignition.

 The extent of service work required can be read out from the remote control by your MINI Dealer. ◀

### Displaying vehicle check

For certain maintenance operations, you can view the respective distance remaining or due date individually in the tachometer.

1. Switch on the ignition, refer to page 39.
2. Briefly press the button in the turn indicator lever repeatedly until "SET/INFO" is displayed.



3. Press and hold the button until the display changes.

4. Briefly press the button repeatedly until the corresponding symbol and "SERVICE-INFO" are displayed.



5. Press and hold the button until the display changes.
6. Briefly press the button to display the individual service items, refer to the following information.

Possible displays

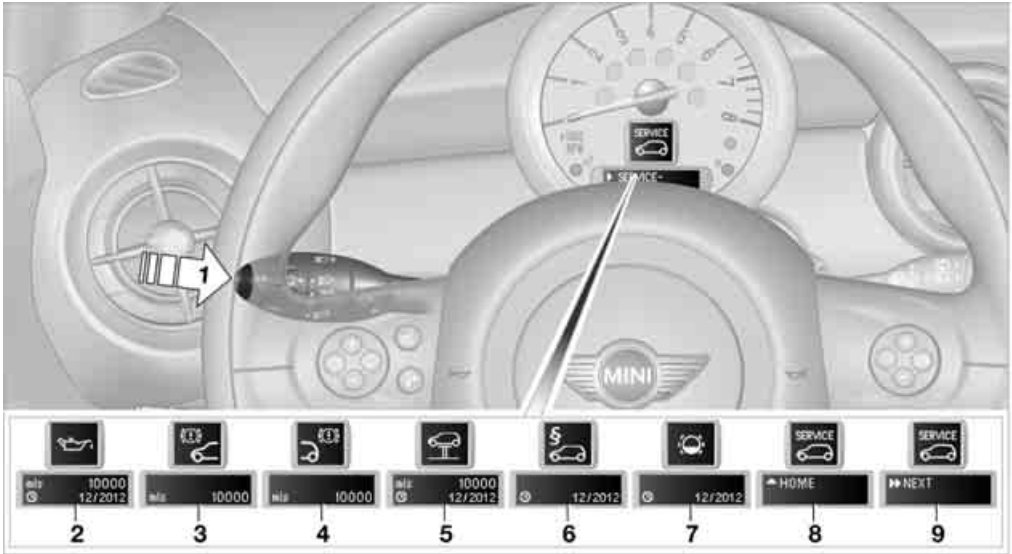

- 1 Button for selecting information
- 2 Engine oil
- 3 Front brakes
- 4 Rear brakes
- 5 Vehicle check

- 6 Roadworthiness test
- 7 Brake fluid
- 8 Exit display 51
- 9 Next setting or item of information 51

More information on the MINI Maintenance System can be found on page 110.

CLOCK

Setting the time

To set the 12h/24h mode, refer to Formats and units of measure on page 51.

1. Briefly press the button in the turn indicator lever repeatedly until "SET/INFO" is displayed.



2. Press and hold the button until the display changes.



- Briefly press the button repeatedly until the symbol and "SET" are displayed.



- Press and hold the button until the display changes.
- Press the button to set the hours.
- Wait for the display to change to minutes.
- Press the button to set the minutes.
- Wait for the display to change. The settings are stored.

- Briefly press the button repeatedly until the symbol and "SET" are displayed.



- Press and hold the button until the display changes.
- Press the button to set the day of the month.
- Wait for the display to change to month.
- Set the month and year in the same way.
- Wait for the display to change. The settings are stored.

## DATE

### Setting the date

To set the dd/mm or mm/dd date format, refer to Formats and units of measure on page 51.

- Briefly press the button in the turn indicator lever repeatedly until "SET/INFO" is displayed.



- Press and hold the button until the display changes.

## CHECK CONTROL

### The concept

The Check Control monitors vehicle functions and alerts you to any malfunctions in the systems monitored. Check Control messages involve indicator or warning lamps in the displays and, in some circumstances, an acoustic signal. To adjust the volume of the signal, refer to the Owner's Manual for Radio.

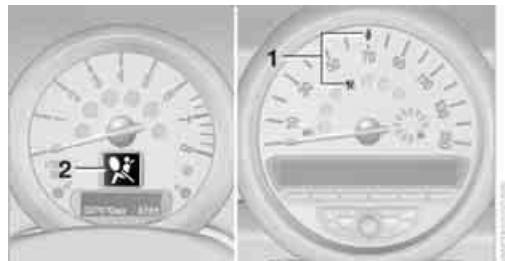

Indicator and warning lamps can light up in various combinations and colors in the indicator areas 1 and 2.

### What to do in case of a malfunction

The meaning of each lamp in the event of a malfunction and tips on how to respond are listed starting on page 131.

### Hiding Check Control messages

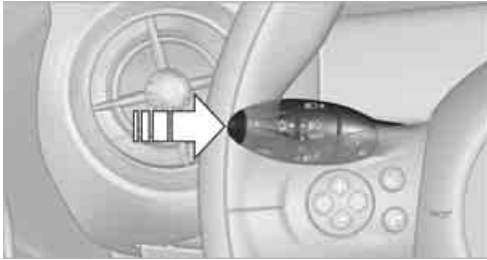

Press the button in the turn indicator lever.

Some Check Control messages are displayed until the malfunctions have been rectified. They cannot be hidden. If several malfunctions occur at the same time, they are displayed in succession.

Other Check Control messages are automatically hidden after approx. 20 seconds, but remain stored.

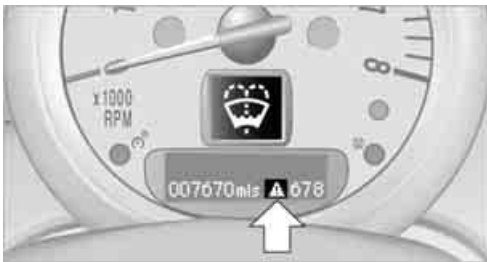

⚠ This symbol indicates that Check Control messages have been stored. Check Control messages can be viewed whenever it is convenient.

### Viewing stored Check Control messages

Stored Check Control messages can only be displayed if the driver's door is closed.

1. Briefly press the button in the turn indicator lever repeatedly until "SET/INFO" is displayed.



2. Press and hold the button until the display changes.
3. Press the button repeatedly until the display shows the corresponding symbol and "CHECK INFO".



4. Hold the button down. "CHECK OK" appears if there are no Check Control messages. If a Check Control message has been stored, the corresponding message is displayed.
5. Briefly press the button to check for other messages.

# TECHNOLOGY FOR DRIVING COMFORT AND SAFETY

## PARK DISTANCE CONTROL PDC\*

### The concept

PDC assists you with parking backwards. Acoustic signals warn you of the presence of an object behind the vehicle. To measure the distance, there are four ultrasonic sensors in either bumper.

However, an acoustic warning does not sound until an object is approx. 24 in/60 cm from the corner sensors, or approx. 5 ft/1.50 m from the center sensors.

 PDC is a parking aid that can indicate objects when they are approached slowly, as is usually the case when parking. Avoid approaching an object at high speed, otherwise physical circumstances may lead to the system warning being issued too late. ◀

### Automatic mode

With the engine running or the ignition switched on, the system is activated automatically after approx. 1 second when you engage reverse gear or move the automatic transmission selector lever to position R. Wait this short period before driving.

### Acoustic signals

As the distance between vehicle and object decreases, the intervals between the tones become shorter. If the distance to the nearest object falls to below roughly 1 ft/30 cm, then a continuous tone sounds.

If the distance remains constant, e.g. when driving parallel to a wall, the acoustic signal stops after approx. 3 seconds.

### Adjustments

The volume of the acoustic signals can be adjusted, refer to the Owner's Manual for Radio.

### Malfunction



Indicator lamp comes on: PDC is malfunctioning. Have the system checked.

To avoid this problem, keep the sensors clean and free of ice or snow in order to ensure that they will continue to operate effectively. When using a high-pressure cleaner, do not direct the jet toward the sensors for lengthy periods and only spray from a distance of at least 4 in/10 cm.

### System limitations



Even with PDC, final responsibility for estimating the distance between the vehicle and any obstructions always remains with the driver. Sensors, too, have blind spots in which objects cannot be detected. Moreover, ultrasonic detection can reach its physical limits with objects such as trailer tow bars and couplings, thin and wedge-shaped objects, etc. Low objects already indicated, such as curbs, may enter the sensors' blind spots before or after a continuous audible signal is given. Higher, protruding objects, such as wall ledges, may not be detectable. Therefore, always drive cautiously, otherwise there is a risk of personal injury or property damage. Loud sound sources outside or inside the car can drown out the PDC signal. ◀

## DRIVING STABILITY CONTROL SYSTEMS

Your MINI has a number of systems that help to maintain the vehicle's stability even in adverse driving conditions.



The laws of physics cannot be repealed, even with driving stability control systems. An appropriate driving style always remains the responsibility of the driver. Therefore, do not reduce the additional safety margin again by taking risks. ◀

## Antilock Brake System ABS

ABS prevents locking of the wheels during braking. Safe steering response is maintained even during full braking. Active safety is thus increased.

Braking safely, refer to page 85.

Among others, ABS includes the following functions:

- ▷ Cornering Brake Control CBC
- ▷ Electronic brake-force distribution
- ▷ Brake Assist

## Cornering Brake Control CBC

Driving stability and steering characteristics are further enhanced while braking in turns or during a lane change.

## Electronic brake-force distribution EBV

The system controls the brake pressure in the rear wheels to ensure stable braking behavior.

## Brake Assist

Rapidly depressing the brake causes this system to automatically develop maximum braking force. Thus, the system helps keep braking distance to a minimum. At the same time, all the benefits provided by ABS are exploited.

Do not reduce the pressure on the brake for the duration of the full braking application.

## All-Season Traction Control ASC\*

ASC prevents slip at the drive wheels while starting off and accelerating the vehicle.

This system optimizes driving stability and traction, especially when driving off, accelerating and cornering, by reducing engine output and, if necessary, braking the front wheels.

ASC encompasses the following functions:

- ▷ Antilock Brake System ABS
- ▷ Brake Assist

## Dynamic Stability Control DSC\*

DSC prevents the driving wheels from losing traction when you pull away from rest or accelerate. The system also recognizes unstable driv-

ing conditions, for example if the rear of the car is about to swerve or if momentum is acting at an angle past the front wheels. In these cases, DSC helps the vehicle maintain a safe course within physical limits by reducing engine output and through braking actions at the individual wheels.

DSC also encompasses the following functions:

- ▷ All-Season Traction Control ASC
- ▷ Antilock Brake System ABS
- ▷ Brake Assist
- ▷ Hill Start Assist

## Deactivating ASC or DSC

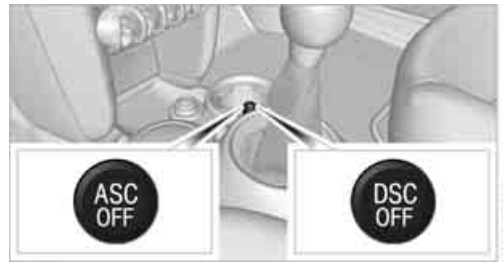

Press the button repeatedly until the indicator lamp for the ASC or DSC comes on. ASC or DSC are deactivated. Stabilizing and drive-output promoting actions are no longer executed.

When driving with snow chains or to 'rock free' in snow, it can be helpful to switch off ASC/DSC for a brief period.

To increase vehicle stability, activate ASC/DSC again as soon as possible.

## Activating ASC or DSC

Press the button again; the indicator lamp for ASC or DSC goes out.

## For better control





If the indicator lamp flashes: ASC or DSC controls the driving and braking forces.



If the indicator lamps are on: ASC or DSC is deactivated.



## Malfunction in the driving stability control systems

-  The warning lamps come on. ASC or DSC is malfunctioning.
-  The vehicle remains operational. Have the system checked as soon as possible.
-  Drive cautiously and think well ahead, otherwise unstable driving conditions could result. ◀

## Hill Start Assist\*

Hill Start Assist aids you in comfortably driving off on inclines. It is not necessary to use the parking brake for this.

1. Hold the MINI with the brake.
2. Depress the clutch and shift into gear.
3. Release the brake and immediately drive off.

Hill Start Assist holds the car in place for approx. 2 seconds after the brake is released.

-  Depending on vehicle load and road inclination, the car may roll backwards a little during this time span. Drive off immediately after releasing the brake. Hill Start Assist will no longer hold the car in place after approx. 2 seconds and the car will start to roll backwards. ◀

## SPORT BUTTON\*

Pressing the button causes your MINI to respond even more sportily.

- ▷ Engine responds more spontaneously to movements of the accelerator.
- ▷ Steering response is more direct.

With automatic transmission:

- ▷ More rapid gear shifting in Sport program.

## Activating the system



Press the SPORT button.

The LED lights up.

SPORT is briefly displayed in the tachometer.

## Deactivating the system

- ▷ Press the SPORT button again.
- ▷ Switch off the engine.

## FLAT TIRE MONITOR FTM\*

### The concept

The Flat Tire Monitor detects pressure loss in a tire by comparing the rotating speeds of the individual tires while moving.

If a tire loses pressure, its rolling circumference changes, and this in turn alters the speed of rotation. This change is detected and is reported as a flat tire.

### Functional requirement

In order to assure the reliable reporting of a flat tire, the system must be initialized for the correct tire inflation pressure.

-  Each time you correct the pressure in a tire, or change a wheel or tire, the system must be reinitialized. ◀

### System limitations

The Flat Tire Monitor is unable to warn the driver of sudden, severe tire damage caused by external factors, nor can it identify the gradual loss of pressure that will inevitably occur in all four tires over a lengthy period of time.

In the following situations, the system could be delayed or malfunction:

- ▷ System has not been initialized
- ▷ Driving on snowy or slippery road surface
- ▷ Performance-oriented style of driving: slip in the drive wheels, high lateral acceleration
- ▷ Snow chains are attached

When the vehicle is driven with a space-saver spare tire\*, page 124, the Flat Tire Monitor cannot function.

### Initializing the system

▶ The initialization is completed during driving, which can be interrupted at any time. When driving resumes, the initialization is continued automatically.

Do not initialize the system if you are driving with snow chains or a space-saver spare tire\*. ◀

1. Start the engine, but do not start driving.
2. Briefly press the button in the turn indicator lever repeatedly until "SET/INFO" is displayed.



3. Press and hold the button until the display changes.
4. Briefly press the button repeatedly until the corresponding symbol and "RESET" are displayed.



5. Press and hold the button until the display changes.
6. Start driving.  
Initialization is completed while the car is on the move, without any feedback.

### Indication of a flat tire



The warning lamps come on in yellow and red. An acoustic signal also sounds.



There is a flat tire or substantial loss of tire pressure.

1. Reduce speed and stop the vehicle with caution. Avoid sudden braking and steering maneuvers.
2. Check whether your vehicle is equipped with normal tires or Run-Flat Tires.



The symbol identifying Run-Flat Tires is a circle with the letters RSC on the sidewall, refer to Run-Flat Tires, page 104. ◀

### Normal tires

1. Determine which tire is damaged.  
▶ If this cannot be determined, contact your MINI Dealer. ◀
2. Repair the flat tire, refer to page 119, or change the damaged tire, refer to page 122.

### Run-Flat Tires\*

1. Cautiously reduce speed to below 50 mph or 80 km/h. Avoid sudden braking and steering maneuvers. Do not exceed a speed of 50 mph or 80 km/h.



Do not continue driving if the vehicle is not equipped with Run-Flat Tires, page 104, otherwise a serious accident could result. ◀

2. At the next opportunity, check the air pressure in all four tires.



If all four tires are inflated to the correct pressures, the Flat Tire Monitor might not have been initialized. The system must then be initialized. ◀

3. In the event of complete tire pressure loss, 0 psi/0 kPa, you can estimate the possible



distance for continued driving on the basis of the following guidelines:

- ▷ With a light load:  
1 to 2 persons without luggage:  
approx. 155 miles/250 km
- ▷ With a medium load:  
2 persons, cargo bay full, or 4 persons  
without luggage:  
approx. 90 miles/150 km
- ▷ With a full load:  
4 persons, cargo area full:  
approx. 30 miles/50 km

 Drive cautiously and do not exceed a speed of 50 mph or 80 km/h, otherwise an accident may occur. In the event of pressure loss, vehicle handling changes. This includes reduced tracking stability in braking, extended braking distance and altered natural steering characteristics.

If unusual vibration or loud noises occur during the journey, this may be an indication that the damaged tire has finally failed. Reduce the vehicle speed and stop as soon as possible. Otherwise, sections of the tire may come loose and cause accidents. Do not continue driving and contact your MINI Dealer. ◀

## Malfunction

 The warning lamps light up in yellow.  There is a malfunction in the Flat Tire Monitor or the system has failed. Have the system checked as soon as possible.

## TIRE PRESSURE MONITOR TPM\*

### The concept

TPM checks the inflation pressures of the four mounted tires. The system notifies you if there is a significant loss of pressure in one or more tires.

### Functional requirement

In order to assure the reliable reporting of a flat tire, the system must be reset while all tire inflation pressures are correct.

Always use wheels with TPM electronics. Otherwise, the system may malfunction.

 Each time a tire inflation pressure has been corrected or a wheel or tire has been changed, reset the system. ◀

### System limitations

 TPM cannot warn you in advance of sudden severe tire damage caused by outside influences. ◀

The system does not work correctly if it has not been reset; for example, a flat tire may be indicated even though the tire inflation pressures are correct.

The system is inactive and cannot indicate a flat tire if a wheel without TPM electronics, such as a compact spare wheel\*, has been mounted, or if TPM is temporarily malfunctioning due to other systems or devices using the same radio frequency.

### Resetting the system

 Each time a tire inflation pressure has been corrected or a wheel or tire has been changed, reset the system. ◀

### Using the button in the turn indicator lever

1. Start the engine, but do not start driving.
2. Briefly press the button in the turn indicator lever repeatedly until "SET/INFO" is displayed.



3. Press and hold the button until the display changes.
4. Repeatedly press the button briefly until the symbol for Tire Pressure Monitor and

"ACTIVE" are displayed. The Tire Pressure Monitor can be reset using "RESET".





5. Press and hold the button until "RESETTING" appears.



6. Start driving.  
After driving a few minutes, the set inflation pressures in the tires are accepted as the target values to be monitored. The system reset is completed during your drive, and can be interrupted at any time. When driving resumes, the reset is continued automatically. The indicator lamp goes out after the system reset is completed.

### Message for low tire inflation pressure

 The warning lamps come on in yellow and red. An acoustic signal also sounds.  There is a flat tire or substantial loss of tire pressure.

1. Reduce speed and stop the vehicle with caution. Avoid sudden braking and steering maneuvers.
2. Check whether your vehicle is equipped with normal tires or Run-Flat Tires.

 The symbol identifying Run-Flat Tires is a circle with the letters RSC on the sidewall, refer to the Owner's Manual for Vehicle. ◀

### Normal tires

1. Determine which tire is damaged.  If this cannot be determined, contact your MINI Dealer. ◀
2. Repair the flat tire or change the damaged tire, refer to page 122.

### Run-Flat Tires\*

1. Cautiously reduce speed to below 50 mph/ 80 km/h. Avoid sudden braking and steering maneuvers. Do not exceed a speed of 50 mph/80 km/h.  Do not continue driving if the vehicle is not equipped with Run-Flat Tires, otherwise a serious accident could result. ◀
2. In the event of complete tire pressure loss, 0 psi/0 kPa, you can estimate the possible distance for continued driving on the basis of the following guidelines:
  - ▷ With a light load:  
1 to 2 persons without luggage:  
approx. 155 miles/250 km
  - ▷ With a medium load:  
2 persons, cargo area full, or 4 persons without luggage:  
approx. 90 miles/150 km
  - ▷ With a full load:  
4 persons, cargo area full:  
approx. 30 miles/50 km

 Drive cautiously and do not exceed a speed of 50 mph/80 km/h, otherwise an accident may occur. In the event of pressure loss, vehicle handling changes. This includes reduced tracking stability in braking, extended braking distance and altered natural steering characteristics.

If unusual vibration or loud noises occur during the journey, this may be an indication that the damaged tire has finally failed. Reduce the vehicle speed and stop as soon as possible. Otherwise, sections of the tire may come loose and



cause accidents. Do not continue driving and contact your MINI Dealer. ◀

### Malfunction



The small warning lamp flashes in yellow and then lights up continuously; the larger warning lamp comes on in yellow.



No punctures can be detected.

This type of message is shown in the following situations:

- ▶ If there is a malfunction  
Have the system checked.
- ▶ If a wheel without TPM electronics has been mounted
- ▶ If TPM is temporarily malfunctioning due to other systems or devices using the same radio frequency.

### Message for unsuccessful system reset



Both warning lamps come on in yellow. The system is not reset after a tire has been changed, for example.



Check the tire inflation pressure and reset the system, refer to the Owner's Manual for Vehicle.

### Declaration according to NHTSA/ FMVSS 138 Tire Pressure Monitoring Systems

Each tire, including the spare, should be checked monthly when cold and inflated to the inflation pressure recommended by the vehicle manufacturer on the vehicle placard or tire inflation pressure label. If your vehicle has tires of a different size than the size indicated on the vehicle placard or tire inflation pressure label, you should determine the proper tire inflation pressure for those tires. As an added safety feature, your vehicle has been equipped with a tire pressure monitoring system TPMS that illuminates a low tire pressure telltale when one or more of your tires are significantly under-inflated. Accordingly, when the low tire pressure telltale illuminates, you should stop and check your tires as soon as possible, and inflate them to the proper pressure. Driving on a significantly

under-inflated tire causes the tire to overheat and can lead to tire failure. Underinflation also reduces fuel efficiency and tire tread life, and may affect the vehicle's handling and stopping ability. Please note that the TPMS is not a substitute for proper tire maintenance, and it is the driver's responsibility to maintain correct tire pressure, even if underinflation has not reached the level at which the TPMS low tire pressure telltale illuminates.

The TPMS malfunction indicator is combined with the low tire pressure telltale. When the system detects a malfunction, the telltale will flash for approximately one minute and then remain continuously lit. This sequence will continue upon subsequent vehicle startups as long as the malfunction exists. When the malfunction indicator is illuminated, the system may not be able to detect or signal low tire pressure as intended. TPMS malfunctions may occur for a variety of reasons, including the installation of replacement or alternate tires or wheels on the vehicle that prevent the TPMS from functioning properly. Always check the TPMS malfunction telltale after replacing one or more tires or wheels on your vehicle to ensure that the replacement or alternate tires and wheels allow the TPMS to continue to function properly.

## AIRBAGS

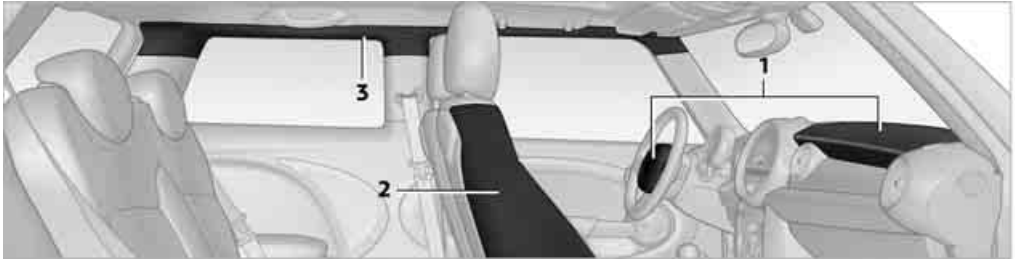

The following airbags are located under the marked covers:

- 1 Front airbags
- 2 Side airbags in backrests
- 3 Head airbags at the front and rear

### Protective action

 Observe the instructions on page 30 to ensure the best possible personal protection. ◀

The front airbags help protect the driver and front passenger by responding to frontal impacts in which safety belts alone cannot provide adequate restraint. When needed, the head and side airbags help provide protection in the event of side impact. The relevant side airbag supports the side upper body area. The head airbag supports the head.

The airbags are designed to not be triggered in every type of collision, e.g. not in minor accidents, certain rollover situations or rear impacts.

 Do not apply adhesive materials to the cover panels of the airbags, cover them or modify them in any other way. Do not attach seat covers, cushions or other objects not specifically approved for seats with integral side airbags to the front seats. Do not hang items of clothing such as coats or jackets over the backrests. Do not attempt to remove the airbag retention system from the vehicle. Do not modify the individual components of the system or its wiring in any way. This includes the upholstered covers on the steering wheel, instrument panel, seats and roof posts, as well as the sides of the roof lining. Do not attempt to remove or dismantle the steering wheel.

Do not touch the individual components immediately after the system has been triggered,

because there is a danger of burns.

In the event of malfunctions, deactivation, or triggering of the airbag restraint system, have the testing, repair, removal, and disposal of airbag generators executed only by a MINI Dealer or a workshop that works according to repair procedures of the manufacturer of your MINI with correspondingly trained personnel and has the required explosives licenses. Otherwise, unprofessional attempts to service the system could lead to failure in an emergency or undesired airbag activation, either of which could result in personal injury. ◀

Warning notices and information about the airbags can also be found on the sun visors.

### Automatic deactivation of the front passenger airbags

An analysis of the impression in the front passenger seat cushion determines whether and how the seat is occupied. The front and side airbags for the front passenger are activated or deactivated by the system accordingly.

 The indicator lamp above the interior rear-view mirror shows the current status of the front passenger airbags, deactivated or activated, refer to Status of front passenger airbags below. ◀

 Before transporting a child on the front passenger seat, read the safety precau-

tions and handling instructions under Transporting children safely, page 36.

The front and side airbags can also be deactivated by adolescents and adults sitting in certain positions; the indicator lamp for the front passenger airbags comes on. In such cases, the passenger should change his or her sitting position so that the front passenger airbags are activated and the indicator lamp goes out. If the desired airbag status cannot be achieved by changing the sitting position, transport the relevant passenger on a rear seat. Do not attach covers, cushions, ball mats or other items to the front passenger seat unless they are specifically recommended by the manufacturer of your MINI. Do not place any items under the seat which could press against the seat from below. Otherwise a correct analysis of the seat cushion is not ensured. ◀

### Status of front passenger airbags



The indicator lamp for the front passenger airbags shows the functional status of the front passenger's front and side airbags in accordance with whether and how the front passenger seat is occupied. The indicator lamp shows whether the front passenger airbags are activated or deactivated.

- ▷ The indicator lamp comes on as intended when a child in a specially designated child-restraint system is detected on the seat. The front and side airbags for the front passenger are not activated.

▷ Most child seats are detected by the system. This particularly applies to child seats that were required by the NHTSA at the time of manufacture of the vehicle. After installing a child's seat, check that the

indicator lamp for the front passenger airbags comes on. It indicates that the child's seat has been detected and that the front passenger airbags are deactivated. ◀

- ▷ The indicator lamp does not come on as long as a person of sufficient size and in a correct sitting position is detected on the seat. The front and side airbags for the front passenger are activated.
- ▷ The indicator lamp does not come on if the seat is empty. The front and side airbags for the front passenger are not activated.

### Operational readiness of airbag system



As of radio readiness, page 39, the warning lamp comes on briefly to indicate that the entire airbag system and the belt tensioners are operational.

### Airbag system malfunction

- ▷ The warning lamp does not come on when radio readiness or the ignition is switched on.
  - ▷ The warning lamp stays lit continuously.
- ⚠ In the event of a fault in the airbag system, have it checked without delay, otherwise there is the risk that the system will not function as intended even if a sufficiently severe accident occurs. ◀

# LAMPS

## PARKING LAMPS/LOW BEAMS

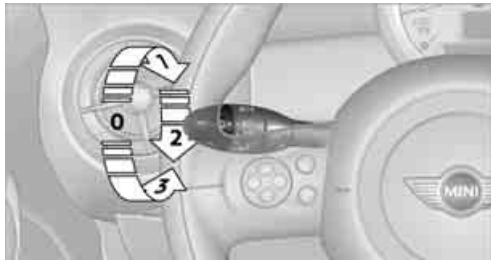

- 0** Lamps off and daytime running lamps
- 1** Parking lamps and daytime running lamps
- 2** Low-beam headlamps and welcome lamps
- 3** Automatic headlamp control\*, daytime running lamps and welcome lamps

When you open the driver's door with the ignition switched off, the exterior lighting is automatically switched off if the light switch is in position **0**, **2** or **3**.

Switch on the parking lamps if necessary, switch position **1**.

### Parking lamps

Turn the light switch to position **1**.

The front, rear and side vehicle lighting is switched on.

Activation of lights on one side of the vehicle for parking, page [68](#).

 The parking lamps will discharge the battery. Therefore, do not leave them on for unduly long periods of time, otherwise the battery might not have enough power to start the engine. ◀

### Low beams

Turn the light switch to position **2**.

The low beams come on when the ignition is on.

### Automatic headlamp control\*

When the switch is in position **3**, the low beams are switched on and off automatically depend-

ing on ambient light conditions, e.g. in a tunnel, in twilight, or if there is precipitation.

The headlamps may also come on when the sun is sitting low on a blue sky.

When driving into tunnels with bright overhead lights, there may be a delay before the headlamps come on.

The low beams remain switched on independent of the ambient lighting conditions when you switch on the fog lamps\*.

If the daytime running lamps are activated, page [67](#), the low beams are always switched on with the light switch in position **3** and the ignition on. The exterior lamps are automatically switched off after the vehicle is parked.

 The automatic headlamp control cannot serve as a substitute for your personal judgment in determining when the lamps should be switched on in response to ambient lighting conditions. For example, the system cannot detect fog or hazy weather. To avoid safety risks, you should respond to these kinds of low-visibility situations by switching the headlamps on manually. ◀

### Welcome lamps

If you leave the light switch in the low beam or automatic headlamp control position when you switch off the ignition, the parking lamps and interior lamps come on for a certain time as soon as the vehicle is unlocked.

### Pathway lighting

If you activate the headlamp flasher after parking the car, with the lights switched off, the low beams come on and remain on for a certain time.

The setting is stored for the remote control in use, refer to Personal Profile, page [18](#).

## Setting the duration or deactivating the function

1. Switch on the ignition, refer to page 39.
2. Briefly press the button in the turn indicator lever repeatedly until "SET/INFO" is displayed.



3. Press and hold the button until the display changes.
4. Briefly press the button repeatedly until the symbol and "SET" are displayed.



5. Press and hold the button until the display changes.
6. Briefly press the button repeatedly until the display shows the illustrated symbol.

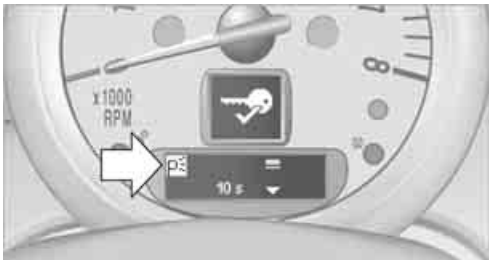

7. Press and hold the button until the display changes.

8. Briefly press the button to select:
  - ▷ **0 s**  
The function is deactivated.
  - ▷ **10 s ... 240 s**  
Select the corresponding duration, e.g. 40 seconds.
9. Press the button for a longer period.  
The setting is stored.

## Daytime running lamps\*

The light switch can remain in the lamps off, parking lamps or automatic headlamp control\* position.

In the lamps off position, the exterior lighting is automatically switched off after the vehicle is parked. In the parking lamps position, the parking lamps will stay on after the ignition is switched off.

Switch on the parking lamps separately if needed.

## Activating/deactivating daytime running lamps

The setting is stored for the remote control in use, refer to Personal Profile, page 18.

1. Switch on the ignition, refer to page 39.
2. Briefly press the button in the turn indicator lever repeatedly until "SET/INFO" is displayed.



3. Press and hold the button until the display changes.

- Briefly press the button repeatedly until the symbol and "SET" are displayed.



- Press and hold the button until the display changes.
- Briefly press the button repeatedly until the display shows the illustrated symbol, arrow.

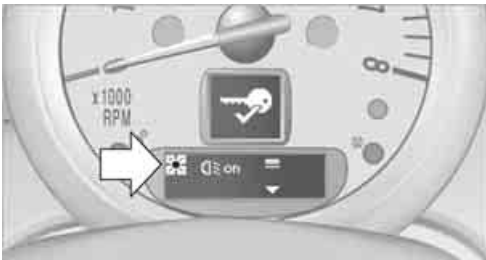

- Press and hold the button until the display changes.
- Briefly press the button to select:
  - ▷ on  
Daytime running lamps activated.
  - ▷ off  
Daytime running lamps deactivated.
- Press the button for a longer period. The setting is stored.

## HIGH BEAMS/ROADSIDE PARKING LAMPS

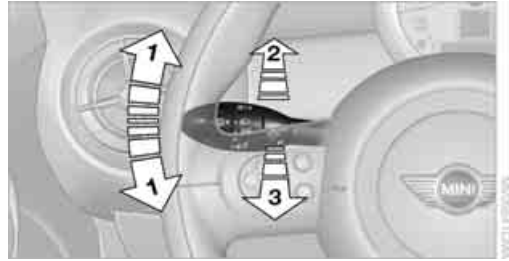

- Turn signal indicators/roadside parking lamps\*
- Switching on high beams
- Switching off high beams/headlamp flasher

### Roadside parking lamps, left or right\*

The vehicle can be illuminated on one side for parking. Comply with local regulations when doing so.

### Switching on

After parking the vehicle, press the lever up or down, arrow 1.

The roadside parking lamps drain the battery. Therefore, do not leave them on for unduly long periods of time, otherwise the battery might not have enough power to start the engine. ◀

### Switching off

Press the lever up or down to the pressure point.

## FOG LAMPS\*



- 1 Fog lamps\*
- 2 Rear fog lamp\*

Press the respective switch to turn the lamps on/off.

### Fog lamps\*

The parking lamps or low beams must be switched on for the fog lamps to operate. The green indicator lamp comes on when the fog lamps are switched on.

Depending on your vehicle's equipment, the fog lamps are switched off when you activate the headlamp flasher or switch on the high beams.

 If the automatic headlamp control is activated, the low beams will come on automatically when you switch on the fog lamps. ◀

### Rear fog lamp\*

The low beams or parking lamps with fog lamps must be switched on. The yellow indicator lamp comes on when the rear fog lamp is switched on.

## INSTRUMENT LIGHTING

You can adjust the brightness of the instrument lighting only when the parking lamps or the low beams are on.



### Increasing brightness

Press and hold the button until the desired brightness is reached.

### Reducing brightness

Press the button briefly.

The brightness decreases every time the button is pressed briefly.

## INTERIOR LAMPS

The interior lamps, the footwell lamps\* and the cargo bay lamp are controlled automatically.

 To avoid draining the battery, all lamps inside the car are switched off about 30 minutes after the ignition is switched off, refer to Start/stop button on page 39. ◀

### Switching interior lamps on/off manually

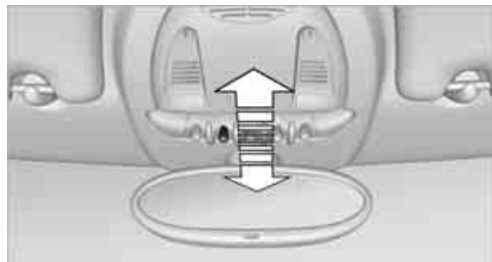

To switch the interior lamps on/off.

Press the switch.

To switch off the interior lamps permanently, press the button for about 3 seconds.

## Reading lamps\*

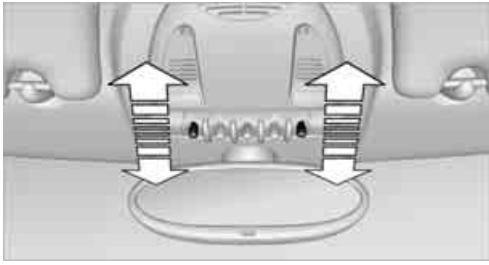

To switch the reading lamps on and off.  
Press the switch.

## Ambient lighting\*

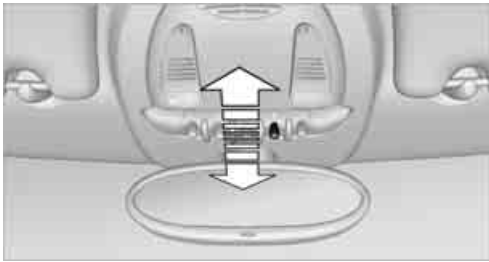

The color of the ambient lighting can be changed.

- ▷ Press the switch forward.  
The color changes in stages, ultimately to orange.
- ▷ Press the switch toward the rear.  
The color changes in stages, ultimately to blue.

Intermediate settings and colors are possible.



# CLIMATE

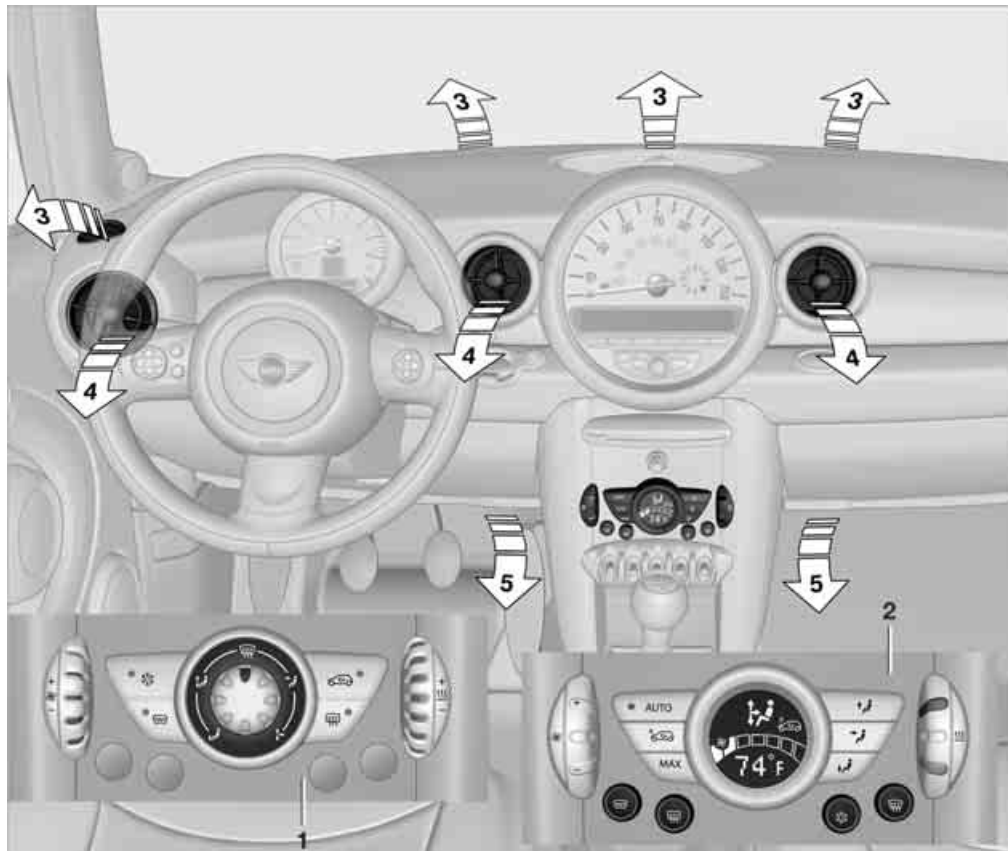

## Equipment versions

Depending on your vehicle's equipment, your MINI contains an air conditioner or an automatic climate control\*.

- 1 Air conditioner
- 2 Automatic climate control\*

## Air vents

- 3 Airflow directed toward the windshield and side windows
- 4 Air to the upper body area
- 5 Air to the footwell

## AIR CONDITIONER

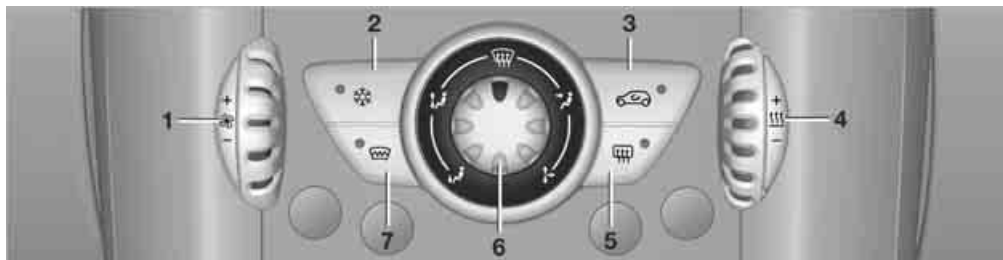

- |  |  |
|--|--|
| <p>1 Air flow rate</p> <p>2 Cooling function</p> <p>3 Recirculated-air mode</p> <p>4 Temperature</p> | <p>5 Rear window defroster</p> <p>6 Air distribution</p> <p>7 Windshield heating</p> |
|--|--|

## Air flow rate



Adjust the air flow rate. The higher the rate, the more effective the heating or cooling will be.

The air flow rate is lowered or switched off entirely to save on battery power.

## Switching the system on/off

Turn the air flow rate rotary switch to 0. Blower and air conditioner are completely switched off and the air supply is cut off.

Set any desired air flow rate to switch on the air conditioner.

## Cooling function



When the cooling function is on, the air is cooled, dried, then reheated according to the temperature setting. The recirculated-air mode may be switched on automatically. This function is only available while the engine is running.

The cooling function helps prevent condensation on the windows or removes it quickly.

Depending on the weather, the windshield may fog over briefly when the engine is started.

## Recirculated-air mode



If the air outside the car has an unpleasant odor or contains pollutants, shut off the supply to the interior of the car temporarily. The system then recirculates the air currently within the vehicle.



If condensation starts to form on the inside window surfaces, switch off the recirculated-air mode and, if necessary, switch on the cooling function or increase the air flow rate. ◀



To prevent the air quality inside the vehicle from deteriorating during extended use of the recirculated-air mode, fresh air is added briefly at regular intervals. ◀

## Temperature



Turn upward, red, to increase the temperature.

Turn downward, blue, to decrease the temperature.



## Rear window defroster



The defroster is switched off automatically after a certain time.

## Air distribution



Direct the flow of air to the windows , to the upper body area  or to the footwell . Intermediate settings are possible.

## Windshield heating\*



The windshield heating is switched off automatically after a short time.

## Defrosting windows and removing condensation

1. Set air flow rate to the maximum level.
2. Set air distribution to position .  
Condensation is removed from the windows

more quickly when the cooling function\* is also activated.

3. Set to the highest temperature, red.
4. Deactivate recirculated-air mode.
5. Turn on windshield heating if necessary.
6. Turn on rear window defroster if necessary.

## Microfilter

The microfilter captures dust and pollen. The microfilter is changed by your MINI Dealer during routine maintenance work.

## AUTOMATIC CLIMATE CONTROL\*



- |  |  |
|--|--|
| 1 Air flow rate, manual  | 6 Temperature                                  |
| 2 AUTO program   | 7 Defrosting windows and removing condensation |
| 3 Automatic recirculated-air control AUC/<br>Recirculated-air mode | 8 Cooling function                             |
| 4 Maximum cooling  | 9 Rear window defroster                        |
| 5 Air distribution, manual   | 10 Windshield heating*                         |

## Comfortable interior climate

AUTO program 2 offers the ideal air distribution and air flow rate for almost all conditions, refer to AUTO program below. All you need to do is select an interior temperature which is comfortable for you.

The following sections inform you in detail about how to adjust the settings.

Most settings are stored for the remote control currently in use, refer also to Personal Profile settings on page 18.

## Air flow rate, manual



Press the – button to reduce air flow. Press the + button to increase it.

You can reactivate the automatic mode for the air flow rate with the AUTO button.

The air flow rate is lowered or switched off entirely to save on battery power. The display remains the same.

### Switching the system on/off

Reduce the air flow by pressing the – button repeatedly until the system is switched off. All indicators go out.

Press the AUTO button to switch the automatic climate control back on.

### AUTO program

 The AUTO program adjusts the air distribution to the windshield and side windows, towards the upper body area and into the footwell for you. The air flow rate and your temperature specifications will be adapted to outside influences in accordance with seasonal changes, e.g. sunlight.

The cooling function is automatically switched on along with the AUTO program.

### Automatic recirculated-air control AUC/ Recirculated-air mode

 Switch on the desired operating mode by pressing the button repeatedly.

### Display of operating modes

No display: outside air flows in continuously.

 AUC mode: a sensor detects pollutants in the outside air. If necessary, the system blocks the supply of outside air and recirculates the inside air. As soon as the concentration of pollutants in the outside air has decreased sufficiently, the system automatically switches back to outside air supply.

At outside temperatures below approx. 41 °F / +5 °C, the AUC mode may be restricted due to the increased risk of window condensation.

 Recirculated-air mode: the supply of outside air is permanently shut off. The system then recirculates the air currently within the vehicle.

 If condensation starts to form on the inside window surfaces, press the AUTO

button or switch off the recirculated-air mode and, if necessary, increase the air flow rate. The recirculated-air mode should not be used over an extended period of time, otherwise the air quality inside the car will deteriorate continuously. ◀

### Maximum cooling

 At outside temperatures above 32 °F / 0 °C and when the engine is running, you obtain a maximum cooling effect as soon as possible.

The automatic climate control goes into recirculated-air mode at the lowest temperature. Air flows at maximum rate from the vents for the upper body area. You should therefore open them for maximum cooling.

### Air distribution, manual

 The flow of air is directed to the windows, to the upper body area or to the footwell as selected.

You can switch the automatic air distribution back on by pressing the AUTO button.

### Temperature

 Set the desired temperature individually.

The automatic climate control achieves this temperature as quickly as possible regardless of the season, using maximum cooling or heating power if necessary, and then maintains it.

 If you switch between different temperature settings in quick succession, the automatic climate control does not have enough time to achieve the set temperature. ◀

### Rear window defroster

 The defroster is switched off automatically after a certain time. Depending on your vehicle's equipment, the upper wires serve as an antenna and are not part of the rear window defroster.

## Defrosting windows and removing condensation



Quickly removes ice and condensation from the windshield and front side windows.

For this purpose, also switch on the cooling function. The windshield heating\* is switched on automatically.

## Windshield heating\*



The windshield heating is switched off automatically after a certain time.

## Cooling function



When the cooling function is on, the air is cooled, dried, then reheated according to the temperature setting. This function is only available while the engine is running.

The cooling function helps prevent condensation on the windows or removes it quickly.

Depending on the weather, the windshield may fog over briefly when the engine is started. The recirculated-air mode may be switched on automatically.

The cooling function is automatically switched on along with the AUTO program. The passenger compartment can only be cooled while the engine is running.

## Microfilter/activated-charcoal filter

The microfilter captures dust and pollen. The activated-charcoal filter provides additional protection by filtering gaseous pollutants from the outside air. Your MINI Dealer replaces this combined filter as a standard part of your scheduled maintenance.

You can call up further information in the service requirements display, page 53.

## VENTILATION

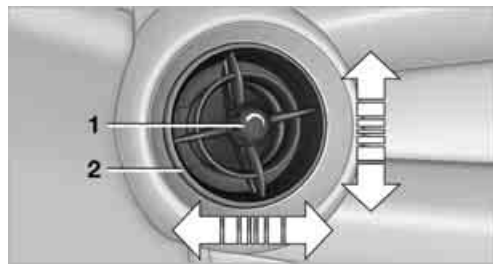

- 1 Knob for continuous opening and closing
- 2 Jet for direction of air flow

### Opening/closing

Turn the knob.

### Direction of air flow

Swivel the entire jet.

# PRACTICAL INTERIOR ACCESSORIES

## INTEGRATED UNIVERSAL REMOTE CONTROL\*

### The concept

The integrated universal remote control can replace as many as three hand-held transmitters for various remote-controlled devices, such as garage and gate openers and lighting systems. The integrated universal remote control registers and stores signals from the original hand-held transmitters.

The signal of an original hand-held transmitter can be programmed on one of the three memory buttons **1**. The system in question can then be operated by means of the programmed memory button **1**. The LED **2** flashes to confirm transmission of the signal.

If you decide to sell your vehicle one day, in the interest of your own security, remember to clear the stored programs before the vehicle leaves your possession, page 77.

 To prevent possible damage or injury, before programming or using the integrated universal remote control, always inspect the immediate area to make certain that no people, animals or objects are within the pivoting or travel range of the device being operated. Comply also with the safety instructions supplied with the original hand-held transmitter. ◀

### Checking compatibility

 If this symbol appears on the package or in the instructions supplied with the original hand-held transmitter, you can assume that the radio remote control device will be compatible with the integrated universal remote control.

For additional information, please contact your MINI Dealer or call: 1-800-355-3515.

You can also obtain information on the Internet at:

[www.MINI.com](http://www.MINI.com) or  
[www.homelink.com](http://www.homelink.com)

HomeLink is a registered trademark of Johnson Controls, Inc.

### Programming



- 1 Memory buttons
- 2 LED

### Fixed-code hand-held transmitters

1. Switch on the ignition, page 39.
2. When starting operation for the first time: press both outer memory buttons **1** for approx. 20 seconds until the LED **2** flashes rapidly. All stored programs are cleared.
3. Hold the original hand-held transmitter at a distance of approx. 2 to 12 in/5 to 30 cm from the memory buttons **1**.

 The required distance between the hand-held transmitter and the memory buttons **1** depends on the system of the respective original hand-held transmitter used. ◀

4. Simultaneously press the transmit key on the original hand-held transmitter and the desired memory button **1** on the integrated universal remote control. The LED **2** flashes slowly at first. As soon as the LED **2** flashes rapidly, release both buttons. If the LED **2** does not flash rapidly after approx. 15 seconds, alter the distance.
5. To program other original hand-held transmitters, repeat steps 3 and 4.

The corresponding memory button **1** is now programmed with the signal of the original hand-held transmitter.

You can operate the system with the engine running or with the ignition switched on.

 If the system fails to function even after repeated programming, check whether the original hand-held transmitter uses an alternating-code system. To do so, either read the instructions for the original hand-held transmitter or hold down the programmed memory button **1** of the integrated universal remote control. If the LED **2** on the integrated universal remote control flashes rapidly and then remains lit for about two seconds, the original hand-held transmitter uses an alternating-code system. If it uses an alternating-code system, program the memory buttons **1** as described under Alternating-code hand-held transmitters. ◀

### Alternating-code hand-held transmitters

To program the integrated universal remote control, consult the operating instructions for the device to be set. You will find information there on the possibilities for synchronization or programming of additional hand-held transmitters.

When programming hand-held transmitters that employ an alternating code, please observe the following supplementary instructions:

 Programming will be easier with the aid of a second person. ◀

1. Park your vehicle within the range of the remote-controlled device.
2. Program the integrated universal remote control as described above in the section Fixed-code hand-held transmitters.
3. Locate the button on the receiver of the device to be set, e.g. on the drive unit.
4. Press the button on the receiver of the device to be set. After step 4, you have approx. 30 seconds for the next step 5.
5. Press the programmed memory button **1** of the integrated universal remote control three times.

The corresponding memory button **1** is now programmed with the signal of the original hand-held transmitter.

### Clearing stored programs

Press both outer memory buttons **1** for approx. 20 seconds until the LED **2** flashes: all stored programs are cleared.

It is not possible to clear individual programs.

### Reassigning individual programs

1. Hold the original hand-held transmitter at a distance of approx. 2 to 12 in/5 to 30 cm from the memory buttons **1**.

 The required distance between the hand-held transmitter and the memory buttons **1** depends on the system of the respective original hand-held transmitter used. ◀

2. Press the desired memory button **1** of the integrated universal remote control.
3. If the LED **2** flashes slowly after approx. 20 seconds, press the transmit key of the original hand-held transmitter and release both buttons as soon as the LED **2** flashes rapidly.

If the LED **2** does not flash rapidly after approx. 15 seconds, alter the distance and repeat this step.

## GLOVE COMPARTMENT

### Opening

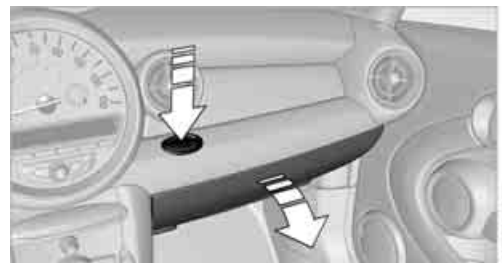

Press the button to open the cover.  
The light in the glove compartment comes on.

### Closing

Fold cover up.

**⚠** To prevent injury in the event of an accident, close the glove compartment after use while the vehicle is being driven. ◀

### Ventilation\*

Depending on your vehicle's equipment, it may be possible to ventilate the glove compartment.

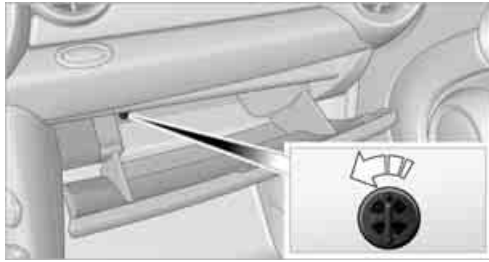

### Opening

Turn the switch to the horizontal position, arrow.

### Closing

Turn the switch to the vertical position.

Depending on the temperature setting of the air conditioning or the automatic climate control, high temperatures may result in the glove compartment.

## CENTER ARMREST\*

### Storage compartment

The center armrest between the front seats contains either a compartment or the cover for the mobile phone base plate\* or the snap-in adapter\*.



### Opening

The cover slides along guide rails and can be opened fully by pushing it back and lifting it.

### Closing

Push the cover forwards.

## CONNECTION FOR EXTERNAL AUDIO DEVICE

You can connect an external audio device such as a CD or MP3 player and play audio recordings over the vehicle loudspeakers. The volume and tone settings can be adjusted via the car radio, refer to the Owner's Manual for Radio.

### Connecting

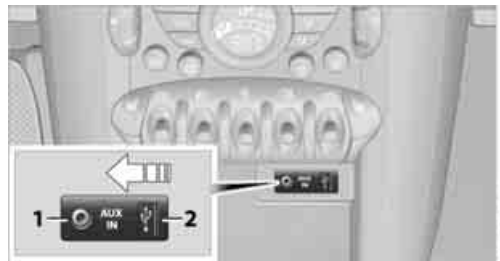

- 1 Connection for audio playback:  
TRS connector 1/8 in/3.5 mm
- 2 USB interface\*

### iPod

To connect the iPod, use the cable adapter for the Apple iPod.

For additional information, contact your MINI Dealer or visit the Internet at [www.MINI.com](http://www.MINI.com)



To play audio tracks over the vehicle's loud-speaker system, connect the iPod to ports **1** and **2**.

The iPod's menu structure is supported by the USB-audio interface.

### USB device

To play audio tracks over the vehicle's loud-speaker system, connect the USB device to port **2**.

### Notes

 Do not expose the audio device to extreme environmental conditions, e.g. very high temperatures, refer to the operating instructions of the audio device. Otherwise the audio device may become damaged, which could compromise safety while driving. ◀

- ▷ The USB-audio interface supplies the connected audio devices with power, provided that this is supported by the audio device. Therefore, do not connect the USB audio device to the power socket in the vehicle during operation.
- ▷ Do not forcibly connect the plug to the USB interface.
- ▷ Do not connect devices such as fans or lamps to the USB-audio interface.
- ▷ Do not connect USB hard disks.
- ▷ Do not use the USB-audio interface to charge external devices.

## STORAGE COMPARTMENTS

### In the vehicle interior

Depending on your vehicle's equipment, you will find storage compartments in the doors, next to the rear seats and in the center console\*. Nets\* are located in the passenger footwell and on the backs of the front seat backrests.

### Storage compartment on the front passenger side\*

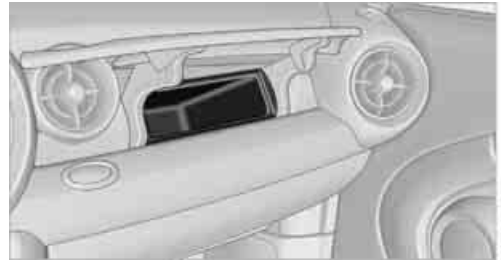

### Opening

Briefly press the bottom edge of the cover.

### Closing

Push the cover back into its original position.

 To prevent injury in the event of an accident, close the storage compartment after use while the vehicle is being driven. ◀

### Clothes hooks

There are clothes hooks on the grab handles in the rear passenger compartment.

 Items of clothing hung from the hooks must not obstruct the driver's view. Do not hang heavy objects from the hooks, otherwise they could endanger the car's occupants, e.g. in case of heavy braking or sudden swerving. ◀

### In the cargo bay

Depending on your vehicle's equipment, you have the following storage options:

- ▷ Umbrella holder\* under the loading sill in front of the warning triangle.
- ▷ Hooks, e.g. for shopping bags or carrying bags, on the left and right sides of the cargo bay.
- ▷ Storage compartment under the level load floor\*
- ▷ Removable box with lid\* under the level load floor, e.g. for wet or dirty items
- ▷ Storage compartment in the splitdoor

## CUP HOLDERS AND ASH-TRAY\*



### Cup holders

Two cup holders are located in the front of the center console, another is in the rear at the back of the center console.

In the MINI Clubman there are two additional cup holders in the armrests in the rear.



 Do not place glass containers in the cup holders, as this increases the risk of injury in the event of an accident. ◀

### Ashtray\*

The ashtray is located in one of the cup holders in the center console.

### Emptying

Remove the entire ashtray.

### Lighter

With the engine running or the ignition switched on, press in the cigarette lighter.

The lighter can be pulled out as soon as it pops back out.

 Hold or touch the hot cigarette lighter by the knob only. Holding or touching it in other areas could result in burns. When leaving the car, always remove the key so that children cannot operate the cigarette lighter and burn themselves. ◀

## CONNECTING ELECTRICAL APPLIANCES

In your MINI, you can use electrical devices such as a flashlight, car vacuum cleaner, etc., up to approx. 200 watts at 12 volts, as long as one of the following sockets is available. Avoid damaging the sockets by attempting to insert plugs of unsuitable shape or size.

### Cigarette lighter socket

Remove the lighter\* or cover from the socket.

### Power socket in cargo bay



By way of example, the illustration shows the cargo bay in the MINI.

Pull out the cover.





**AT A GLANCE**

**CONTROLS**

**DRIVING TIPS**

**MOBILITY**

**REFERENCE**

# THINGS TO REMEMBER WHEN DRIVING

## BREAK-IN PERIOD

Moving parts need breaking-in time to adjust to each other. Please follow the instructions below in order to achieve the optimal service life and economy of operation for your vehicle.

### Engine and differential

Always obey all official speed limits.

#### Up to 1,200 miles/2,000 km

Drive at varying engine and road speeds, but do not exceed the following:

- ▷ Gasoline engine  
4500 rpm or 100 mph/160 km/h

Avoid full-throttle operation and use of the transmission's kick-down mode.

#### After driving 1,200 miles/2,000 km

Engine and vehicle speeds can be gradually increased.

### Tires

Due to technical factors associated with their manufacture, tires do not achieve their full traction potential until after an initial break-in period. Therefore, drive cautiously during the first 200 miles/300 km.

### Brake system

Brakes require an initial break-in period of approx. 300 miles/500 km to achieve optimized contact and wear patterns between brake pads and rotors. Drive cautiously during this break-in period.

### Clutch

The function of the clutch reaches its optimal level only after a distance driven of approx. 300 miles/500 km. During this break-in period, engage the clutch gently.

### Following part replacement

The same break-in procedures should be observed if any of the components mentioned above have to be renewed in the course of the vehicle's operating life.

## GENERAL DRIVING NOTES

### Close the tailgate

 Drive the vehicle only when the tailgate is closed. Otherwise, exhaust fumes could penetrate the interior of the vehicle. ◀

If special circumstances make it absolutely necessary to drive with the tailgate open:

1. Close all windows and the glass sunroof.
2. Switch off the recirculated-air mode and significantly increase the air flow rate of the air conditioner or automatic climate control, page 72 or 73.

### Hot exhaust system

 In all vehicles, extremely high temperatures are generated in the exhaust system. Do not remove the heat shields installed adjacent to various sections of the exhaust system, and never apply undercoating to them. When driving, standing at idle and while parking, take care to avoid possible contact between the hot exhaust system and any highly flammable materials such as hay, leaves, grass, etc. Such contact could lead to a fire, with the risk of serious personal injuries and property damage. Do not touch hot exhaust tail pipes. Otherwise there is a risk of burns. ◀

### Hydroplaning

 When driving on wet or slushy roads, reduce road speed. If you do not, a wedge of water can form between tires and road surface. This situation, known as hydroplaning, can cause partial or complete loss of tire contact

with the road surface, so that the car cannot be steered or braked properly. ◀

The risk of hydroplaning increases with declining tread depth on the tires, refer also to Tread depth on page 103.

### Driving through water

 Drive through water on the road only if it is not deeper than 1 ft/30 cm, and then only at walking speed at the most. Otherwise, the vehicle's engine, the electrical systems and the transmission may be damaged. ◀

### Parking brake on inclines

 On inclines, do not hold the vehicle with the clutch; use the parking brake. Otherwise greater clutch wear will result. ◀

For information on driving off using Hill Start Assist\*, refer to page 59.

### Braking safely

Your MINI is equipped with ABS. If you are in a situation which requires full braking, it is best to brake using maximum brake pressure. Since the vehicle maintains steering responsiveness, you can still avoid possible obstacles with a minimum of steering effort.

The pulsation of the brake pedal, together with the sound of hydraulic regulation, indicates that ABS is actively taking effect.

### Driving in wet conditions

When roads are wet or there is heavy rain, briefly exert gentle pressure on the brake pedal every few miles. Monitor traffic conditions to ensure that this maneuver does not endanger other road users. The heat generated in this process helps dry the pads and rotors to ensure that Then full braking force will be immediately available when it is needed.

### Hills

 To prevent overheating and the resulting reduced efficiency of the brake system, drive long or steep downhill gradients in the gear in which the least braking is required. Even light but consistent brake pressure can lead to

high temperatures, brake wear and possibly even brake failure. ◀

You can increase the engine's braking effect by shifting down, all the way to first gear if necessary. This strategy helps you avoid placing excessive loads on the brake system. Downshifting in manual mode of the automatic transmission, page 42.

 Never drive with the clutch held down, with the transmission in neutral or with the engine switched off; otherwise, engine braking action will not be present or there will be no power assistance to the brakes or steering. Never allow floor mats, carpets or any other objects to protrude into the area around the pedals, otherwise pedal function could be impaired. ◀

### Corrosion on brake rotors

When the vehicle is driven only occasionally, during extended periods when the vehicle is not used at all, and in operating conditions where brake applications are less frequent, there is an increased tendency for corrosion to form on rotors, while contaminants accumulate on the brake pads. This occurs because the minimum pressure which must be exerted by the pads during brake applications to clean the rotors is not reached.

Should corrosion form on the brake rotors, the brakes will tend to respond with a pulsating effect that even extended application will fail to cure.

### When the vehicle is parked

Condensation forms while the automatic climate control is in operation, and then exits under the vehicle. Traces of condensed water under the vehicle are therefore normal.

In the MINI Cooper S, the coolant pump may continue to run for some time after the engine is switched off. This will generate noise in the engine compartment.

### Before driving into a car wash

**⚠** Avoid car washes with tracks higher than 4 in/10 cm, otherwise the chassis could be damaged. ◀

For general information about vehicle care for your MINI, refer to the chapter beginning on page 112.

### With convenient access and automatic transmission

Insert the key into the ignition lock. The engine can be switched off when the selector lever is in position N. Refer also to page 27.

## CARGO LOADING

**⚠** To avoid loading the tires beyond their approved carrying capacity, never overload the vehicle. Overloading can lead to overheating and increases the rate at which damage develops inside the tires. The ultimate result can assume the form of a sudden blow-out. ◀

**⚠** Avoid fluid spills in the cargo bay as they could damage the vehicle. ◀

### Cargo bay cover

**⚠** Do not place any objects on the cover, otherwise they could endanger the car's occupants, e.g. in the case of braking or sudden swerving. ◀

### MINI

When you open the tailgate of the MINI, the cargo bay cover is raised.

To load bulky luggage, the cover can be removed.

1. Unhook the lift straps from the tailgate.
2. Pull the cover out of the holders toward the rear.

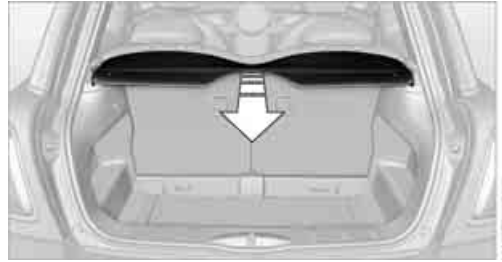

### MINI Clubman

In the MINI Clubman, the cargo bay cover can be locked in the intermediate positions 1 to 3.



To load bulky luggage, the cover can be removed.

1. Pull on the handle, arrow 1, to detach the cargo bay cover.



2. Lift the cargo bay cover up out of the holders, arrows 2.

### Expanding the cargo bay

The rear set backrest is split. Both sides can be folded separately to expand the cargo bay.



In the MINI Clubman, remove the third head restraint if necessary, refer to Head restraints, Removing, page 32.

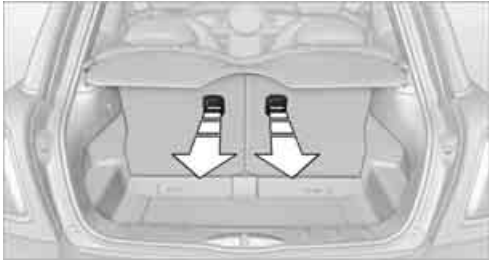

1. Pull the lever.
2. Fold rear seat backrests forward.

**!** When folding the backrest back up, make sure that the seat's locking mechanisms engage properly. Otherwise, cargo could be thrown around in the event of sharp braking or swerving and endanger the occupants. ◀

### Adjusting rear seat backrest\*

Expand the cargo bay by raising the split rear seat backrests to a steeper angle.



1. Pull the lever, arrow 1, and fold the rear seat backrest forward.
2. Fold up the lever of the backrest lock until it audibly engages, arrow 2.
3. Fold back the backrest until it engages.

**!** If the rear seat backrests are positioned at a steeper angle, do not install child-restraint systems in the rear of the vehicle as their protective features may be ineffective. ◀

### Partition net\* in MINI Clubman

**!** Ensure that the partition net is firmly attached, otherwise injuries may occur. ◀

The partition net can be mounted in the cargo bay or behind the front seats.

### In the cargo bay

1. Fold the rear seat backrest forward if necessary, page 87.



2. Insert each partition net mounting pin all the way into its respective rear mount in the headliner, arrow 1, and push it forward.
3. Hang the hooks of the partition net into the eyelets on the cargo bay floor, arrow 2.

### Behind the front seats

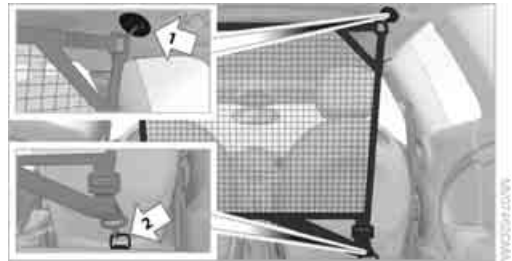

1. Fold down the rear seat backrests, refer to Expanding the cargo bay.
2. Insert each partition net mounting pin all the way into its respective front mount in the headliner, arrow 1, and push it forward.
3. Fold up the eyelets on the rear seat and hook the partition net into them, arrow 2.

### Level load floor\* in MINI Clubman

**!** The maximum load capacity of the level load floor is 165 lb/75 kg. For the storage compartment under the load floor, do not

exceed a maximum load of 55 lb/25 kg, otherwise damage may occur. ◀

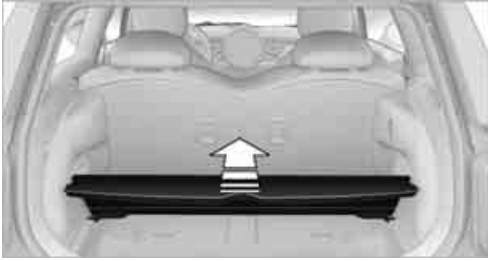

Raise the level load floor and fold it up toward the front, arrow.

### Removing

1. Fold up the level load floor.
2. Pull the load floor back slightly.
3. Then take it out toward the top.

### Determining cargo limit



1. Locate the following statement on your vehicle's placard\*:



The combined weight of occupants and cargo should never exceed XXX kg or YYY lbs. Otherwise, overloading can result in damage to the vehicle and unstable driving conditions. ◀

2. Determine the combined weight of the driver and passengers that will be riding in your vehicle.
3. Subtract the combined weight of the driver and passengers from XXX kilograms or YYY pounds.
4. The resulting figure equals the available amount of cargo and luggage load capacity. For example, if the XXX amount equals

1,400 lbs. and there will be four 150-lb. passengers in your vehicle, the amount of available cargo and luggage load capacity is 650 lbs:

1,400 lbs. minus 750 lbs. = 650 lbs.

5. Determine the combined weight of luggage and cargo being loaded on the vehicle. That weight may not safely exceed the available cargo and luggage load capacity calculated in step 4.
6. If your vehicle will be towing a trailer, part of the load from your trailer will be transferred to your vehicle. Consult the manual for transporting a trailer to determine how this may reduce the available cargo and luggage load capacity of your vehicle.

### Load

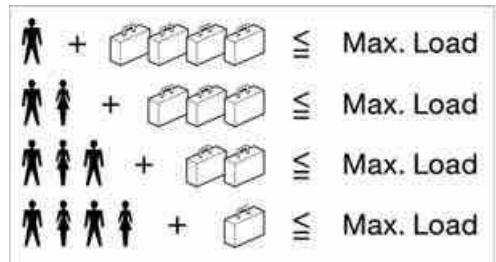

The permissible load is the sum of the occupants' weights and the weight of the cargo. The greater the weight of the occupants, the less cargo/luggage can be transported.

### Stowing cargo

- ▷ Position heavy objects as low and as far forward as possible, ideally directly behind the rear seat backrests.
- ▷ Cover sharp edges and corners.
- ▷ For very heavy cargo when the rear seat is not occupied, secure each safety belt in the respective opposite buckle.
- ▷ Do not stack higher than the top edge of the backrests.

In addition in the MINI Clubman:

- ▷ Use the partition net, refer to page 87. Ensure that no objects can penetrate through the net.

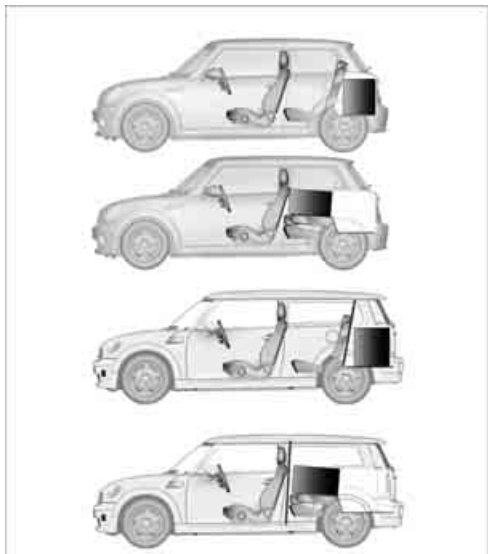

## Securing cargo



- ▷ Secure smaller and lighter items using retaining or draw straps\*.
- ▷ Heavy-duty cargo straps\* for securing larger and heavier objects are available at your MINI Dealer. Four lashing eyes are provided for attaching the cargo straps. Two of them are located on the forward wall of the cargo bay.

Comply with the information enclosed with the load-securing devices.

**!** Always position and secure the cargo as described above, so that it cannot endanger the car's occupants, for example if sudden braking or swerves are necessary.

Do not exceed the approved gross weight and axle loads, page 146; otherwise the vehicle's operating safety is no longer assured and it will

not be in compliance with the certification regulations.

Heavy or hard objects should not be carried loose inside the car, since they could be thrown around, for example as a result of heavy braking, sudden swerves, etc., and endanger the occupants. ◀

## ROOF-MOUNTED LUGGAGE RACK\*

A special rack system is available as an option for your MINI. Your MINI Dealer will be glad to advise you. Comply with the installation instructions supplied with the rack system.

### Mounting points

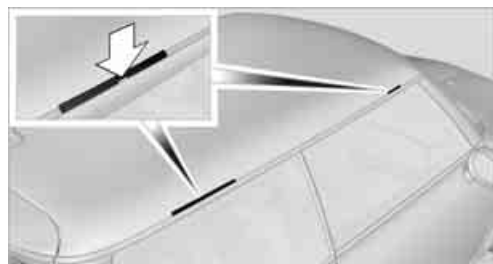

Remove the cover panel.

### Loading roof-mounted luggage rack

Because roof racks raise the vehicle's center of gravity when loaded, they have a major effect on vehicle handling and steering response. You should therefore always remember not to exceed the approved roof load capacity, the approved gross vehicle weight or the axle loads when loading the rack.

You can find the applicable data under Weights on page 146.

The roof load must be distributed uniformly and should not be too large in area. Heavy items should always be placed at the bottom.

When loading, make sure that there is sufficient space for the movement of the glass sunroof and that no objects protrude into the swiveling

area of the tailgate; otherwise damage can occur.

Fasten roof-mounted cargo correctly and securely to prevent it from shifting or falling off during the trip.

Drive smoothly. Avoid sudden acceleration and braking maneuvers, and take corners gently.

## SAVING FUEL

Fuel consumption depends on a number of different factors. The implementation of certain measures, your driving style and regular maintenance can have an influence on fuel consumption and on the environmental impact.

### Remove unnecessary cargo

Additional weight increases fuel consumption.

### Remove attached parts no longer in use

Remove auxiliary mirrors, roof- or rear-mounted luggage racks whenever you are not using them.

Attached parts on the vehicle affect its aerodynamics and increase fuel consumption.

### Check tire inflation pressure regularly

Check and, if necessary, correct tire inflation pressure at least twice a month and before starting on a long trip.

Low inflation pressure increases rolling resistance and thus leads to greater fuel consumption and tire wear.

### Drive off immediately

Do not wait for the engine to warm up while the vehicle remains stationary. Start driving right away, but at moderate engine speeds. This is the fastest way for the cold engine to reach its operating temperature.

### Think ahead while driving

Avoid unnecessary acceleration and braking by maintaining a suitable distance to the vehicle driving ahead.

Driving smoothly and anticipating impending traffic situations reduces fuel consumption.

### Avoid high engine speeds

Use first gear only for driving off. In second and higher gears, accelerate smoothly to a suitable engine and road speed. In doing so, avoid high engine speeds and shift up early.

When you reach your desired traveling speed, shift to the highest suitable gear and drive at constant speed.

As a rule: driving at low engine speeds lowers fuel consumption and reduces wear.

### Coasting

When approaching a red traffic light, take your foot off the accelerator and let the vehicle coast to a halt in the highest suitable gear.

On a downhill gradient, take your foot off the accelerator and let the vehicle coast in a suitable gear.

Fuel supply is shut off automatically when the vehicle is coasting.

### Switch off the engine during lengthy stops

Switch off the engine when stopping for lengthy periods, e.g. at traffic lights, railroad crossings or in traffic congestions.

### Have the vehicle serviced

Have your vehicle serviced regularly to achieve good economy and a long vehicle life. The manufacturer of your MINI recommends having the vehicle serviced by a MINI Dealer. Also note the MINI Maintenance System, page 110.





**AT A GLANCE**

**CONTROLS**

**DRIVING TIPS**

**MOBILITY**

**REFERENCE**

# REFUELING

 Switch off the engine before refueling, otherwise fuel cannot be added to the tank and a message will be displayed. ◀

 Take all precautionary measures and observe all applicable regulations when handling fuel. Do not carry any spare fuel containers in your vehicle. They can develop a leak and cause an explosion or cause a fire in the event of an accident. ◀

## FUEL FILLER DOOR

### Opening

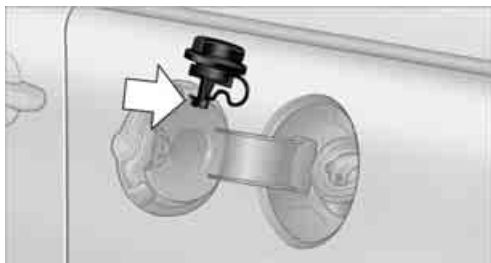

1. Open fuel filler door.
2. Turn the gas cap counterclockwise.
3. Place the gas cap in the bracket attached to the fuel filler door.

### Closing

Fit the cap and turn it clockwise until you clearly hear a click.

 Do not pinch the band attached to the cap, otherwise the cap cannot be closed properly and fuel vapors can escape. A message will be displayed if the gas cap is loose or missing. ◀

### Manually releasing the fuel filler door

#### MINI

In the event of an electrical malfunction, you can manually unlock the fuel filler door:

1. Remove the cover from the left-hand side-wall of the cargo bay.

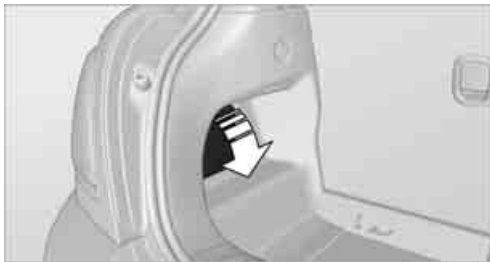

2. Pull on the green knob with the fuel pump symbol. The fuel filler door is released.



#### MINI Clubman

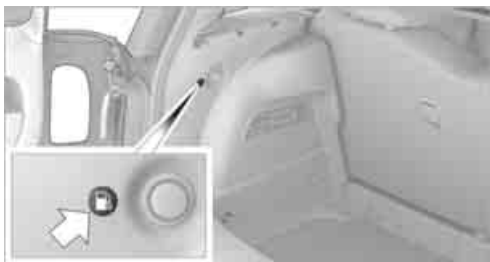

Pull on the green knob with the fuel pump symbol; the fuel filler door opens.

### Observe the following when refueling

 Take all precautionary measures and observe all applicable regulations when handling fuel, otherwise there is a danger of personal injury and property damage. ◀



When refueling, insert the filler nozzle completely into the filler pipe. Avoid lifting the filler nozzle while filling the tank, as that would lead to

- ▷ premature pump shutoff
- ▷ reduced efficiency of the fuel-vapor recovery system.

The fuel tank is full when the filler nozzle clicks off the first time.

## Fuel tank capacity

 If the range displayed is less than 30 miles/50 km, be sure to refuel; otherwise engine functions are not guaranteed and damage could occur. ◀

## MINI Cooper, MINI Cooper S

Approx. 13.2 US gallons/50 liters, including the reserve capacity of 2.1 US gallons/8 liters.

## FUEL SPECIFICATIONS

 Do not fill the tank with leaded fuel, as this would cause damage to the catalytic converter.

Do not fill the tank with E85, i.e. fuel containing 85 % ethanol, nor with FlexFuel. Otherwise the engine and fuel supply system will be damaged. ◀

## Required fuel

### Super Premium gasoline/AKI 91

This gasoline is highly recommended.

However, you may also use gasoline with less AKI. The minimum AKI Rating is 87.

If you use gasoline with this minimum AKI Rating, the engine may produce knocking sounds when starting at high outside temperatures. This has no effect on the engine life.

 Do not use any gasoline below the specified minimum fuel grade. Otherwise the engine could be damaged. ◀



## Use high-quality brands

Field experience has indicated significant differences in fuel quality: volatility, composition, additives, etc., among gasolines offered for sale in the United States and Canada. Fuels containing up to and including 10% ethanol or other oxygenates with up to 2.8% oxygen by weight, that is, 15% MTBE or 3% methanol plus an equivalent amount of co-solvent, will not void the applicable warranties with respect to defects in materials or workmanship.



The use of poor-quality fuels may result in driveability, starting and stalling problems especially under certain environmental conditions such as high ambient temperature and high altitude.

Should you encounter driveability problems which you suspect could be related to the fuel you are using, we recommend that you respond by switching to a recognized high-quality brand such as gasoline that is advertised as Top Tier Detergent Gasoline.

Failure to comply with these recommendations may also result in unscheduled maintenance. ◀

# WHEELS AND TIRES

## TIRE INFLATION PRESSURES

### Information for your safety

It is not merely the tires' service life, but also driving comfort and, to a great extent, driving safety that depend on the condition of the tires and the maintenance of the specified tire pressure.

### Checking pressure

 Check the tire inflation pressure regularly and correct it, if necessary: at least twice a month and before starting long trips. If you fail to observe this precaution you may be driving on tires with incorrect tire pressures, a condition that can not only compromise your vehicle's driving stability, but also lead to tire damage and the risk of an accident. Do not drive with deflated, i.e. flat tires, except when using Run-Flat Tires. A flat tire will seriously impair your vehicle's handling and braking response. Attempts to drive on a flat tire can lead to loss of control over the vehicle. ◀

Check the tire inflation pressures only on cold tires. This means after a maximum of 1.25 miles/ 2 km driving or when the vehicle has been parked for at least 2 hours. When tires are warm, the tire inflation pressure is higher.

 After correcting the tire inflation pressure, reinitialize the Flat Tire Monitor, page 60, or reset the Tire Pressure Monitor, page 61. ◀

### Checking the inflation pressure of the space-saver spare tire\* of the MINI

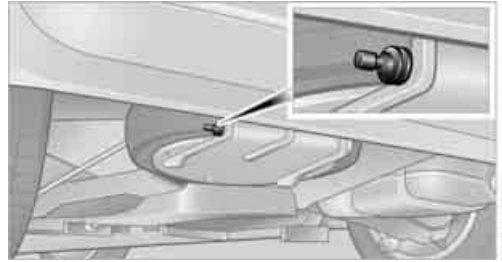

A valve extension for checking the inflation pressure is located behind the bumper.

### Checking the inflation pressure of the space-saver spare tire\* of the MINI Clubman

To check the inflation pressure, fold up the level load floor. Remove the onboard tool kit and the space-saver spare tire, refer to page 123.

### Inflation pressure specifications

The tables below provide all the correct inflation pressures for the specified tire sizes at ambient temperature.

 The tire inflation pressures apply to the tire sizes approved and the tire brands recommended by the manufacturer of your MINI. Your MINI Dealer will be glad to advise you. ◀

For correct identification of the right tire inflation pressures, observe the following:

- ▷ Tire sizes for your vehicle
- ▷ Load conditions
- ▷ Maximum allowable driving speed

### Tire inflation pressures for driving up to 100 mph or 160 km/h

For normal driving up to 100 mph or 160 km/h and to achieve optimum driving comfort, adjust pressures to the respective tire inflation pressures listed on the following pages in the col-

umns for traveling speeds up to a maximum of 100 mph or 160 km/h.

These tire inflation pressures can also be found on the driver's-side door post when the driver's door is open.

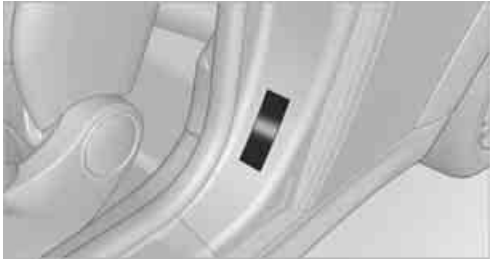



 The maximum permissible speed for these tire pressures is 100 mph or 160 km/h. Do not exceed this speed, otherwise tire damage and accidents could occur. ◀

### Tire inflation pressures for driving above 100 mph or 160 km/h

 In order to drive at maximum speeds in excess of 100 mph or 160 km/h, adjust pressures to the respective tire inflation pressures listed on the following pages in the columns for traveling speeds including those exceeding 100 mph or 160 km/h. Otherwise tire damage and accidents could occur. ◀

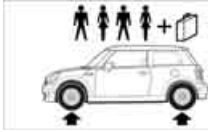

Observe all national and local maximum speed limits, otherwise violations of the laws could occur.

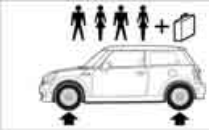
## MINI Cooper tire inflation pressures

Tire size	Pressure specifications in psi/kPa					
	Speeds up to a max. of 100 mph / 160 km/h		Speeds including those exceeding 100 mph / 160 km/h			
<p>All pressure specifications in the table are indicated in psi/kilopascal with cold tires. Cold = ambient temperature</p> <div style="display: flex; justify-content: space-around; align-items: center;">    </div>						
175/65 R 15 84 T M+S						
175/65 R 15 84 H M+S						
175/65 R 15 84 H						
175/60 R 16 82 H M+S RSC						
195/55 R 16 87 H RSC						
195/55 R 16 87 H M+S RSC	33/230	33/230	33/230	33/230	38/260	38/260
195/55 R 16 87 V M+S RSC						
205/45 R 17 84 V M+S RSC						
205/45 R 17 84 V RSC						
205/45 R 17 84 V M+S RSC						
205/40 R 18 82 W RSC						
Emergency wheel: 115/70 R 15 90 M	61/420	61/420	-	-	61/420	61/420

More details on the permissible load and weights can be found on page [147](#).

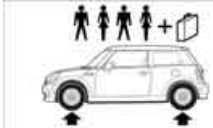
## MINI Cooper S tire inflation pressures

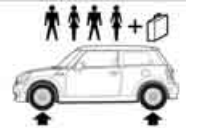
Tire size	Pressure specifications in psi/kPa					
	Speeds up to a max. of 100 mph / 160 km/h		Speeds including those exceeding 100 mph / 160 km/h			
All pressure specifications in the table are indicated in psi/kilopascal with cold tires. Cold = ambient temperature						
	195/55 R 16 87 V RSC					
	195/55 R 16 87 H M+S RSC	33/230	33/230	33/230	33/230	38/260
195/55 R 16 87 V M+S RSC						
205/45 R 17 84 V M+S RSC						
205/45 R 17 84 V RSC						
205/40 R 18 82 W RSC	38/260	38/260	38/260	38/260	41/280	41/280
175/60 R 16 82 H M+S RSC						
More details on the permissible load and weights can be found on page <a href="#">147</a> .						

## MINI Clubman Cooper tire inflation pressures

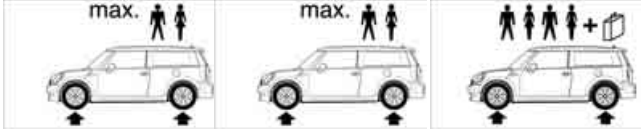
Tire size	Pressure specifications in psi/kPa					
	Speeds up to a max. of 100 mph / 160 km/h		Speeds including those exceeding 100 mph / 160 km/h			
<p>All pressure specifications in the table are indicated in psi/kilopascal with cold tires. Cold = ambient temperature</p> 						
	195/55 R 16 87 V RSC					
195/55 R 16 87 H M+S RSC	32/220	32/220	33/230	33/230	35/240	38/260
195/55 R 16 87 V M+S RSC						
175/65 R 15 84 T M+S						
175/65 R 15 84 H M+S						
175/65 R 15 84 H						
175/60 R 16 82 H M+S RSC	35/240	35/240	35/240	35/240	38/260	41/280
205/45 R 17 84 V RSC						
205/45 R 17 84 V M+S RSC						
205/40 R 18 82 V RSC						
195/55 R 16 87 H RSC	34/240	34/240	34/240	34/240	38/260	41/280
195/55 R 16 87 H M+S RSC						
Emergency wheel: 115/70 R 15 90 M	61/420	61/420	-	-	61/420	61/420

More details on the permissible load and weights can be found on page [147](#).

## MINI Clubman Cooper S tire inflation pressures

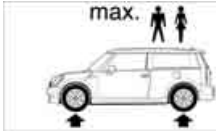
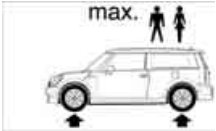
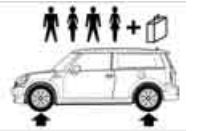
Tire size	Pressure specifications in psi/kPa							
	Speeds up to a max. of 100 mph / 160 km/h		Speeds including those exceeding 100 mph / 160 km/h					
All pressure specifications in the table are indicated in psi/kilopascal with cold tires. Cold = ambient temperature								
	195/55 R 16 87 V RSC		35/240	35/240	35/240	35/240	38/260	41/280
	195/55 R 16 87 H M+S RSC							
195/55 R 16 87 V M+S RSC								
205/45 R 17 84 V RSC								
205/45 R 17 84 V M+S RSC								
205/40 R 18 82 W RSC			38/260	38/260	38/260	38/260	41/280	44/300
175/60 R 16 82 H M+S RSC								
More details on the permissible load and weights can be found on page <a href="#">147</a> .								

## TIRE CODING

Knowledge of the labeling on the side of the tire makes it easier to identify and choose the right tires.

### Tire size

e.g. 225/45 R 17 91 V

Nominal width in mm ———┐  
 Aspect ratio in % ————┐  
 Radial belt construction ———┐  
 Rim diameter in inches ———┐  
 Load rating, not on ZR tires ———┐  
 Speed code letter, in front of the R on ZR tires ———┐

### Speed code letter

- Q = up to 100 mph or 160 km/h
- T = up to 118 mph or 190 km/h
- H = up to 131 mph or 210 km/h
- V = up to 150 mph or 240 km/h
- W = up to 167 mph or 270 km/h
- Y = up to 186 mph or 300 km/h

### Tire Identification Number

Tires with DOT codes meet the guidelines of the US Department of Transportation.

DOT code:

e.g. DOT xxxx xxx 4707

Manufacturer's code for tire make ———┐  
 Tire size and tire design ———┐  
 Tire age ———┐

### Uniform Tire Quality Grading

Quality grades can be found where applicable on the tire sidewall between tread shoulder and maximum section width. For example:

Tread wear 200 Traction AA  
 Temperature A

## DOT Quality Grades

Tread wear  
 Traction AA A B C  
 Temperature A B C



All passenger car tires must conform to Federal Safety Requirements in addition to these grades. ◀

### Tread wear

The tread wear grade is a comparative rating based on the wear rate of the tire when tested under controlled conditions on a specified government test course. For example, a tire graded 150 would wear one and one-half (1 ½) times as well on the government course as a tire graded 100. The relative performance of tires depends upon the actual conditions of their use, however, and may depart significantly from the norm due to variations in driving habits, service practices and differences in road characteristics and climate.

### Traction

The traction grades, from highest to lowest, are AA, A, B, and C.

Those grades represent the tire's ability to stop on wet pavement as measured under controlled conditions on specified government test surfaces of asphalt and concrete. A tire marked C may have poor traction performance.



The traction grade assigned to this tire is based on straight-ahead braking traction tests, and does not include acceleration, cornering, hydroplaning, or peak traction characteristics. ◀

### Temperature

The temperature grades are A, the highest, B, and C, representing the tire's resistance to the generation of heat and its ability to dissipate heat when tested under controlled conditions on a specified indoor laboratory test wheel. Sustained high temperature can cause the material of the tire to degenerate and reduce tire life, and excessive temperature can lead to sudden tire failure. The grade C corresponds to a level of performance which all passenger car tires must



meet under the Federal Motor Vehicle Safety Standard No. 109. Grades B and A represent higher levels of performance on the laboratory test wheel than the minimum required by law.

 The temperature grade for this tire is established for a tire that is properly inflated and not overloaded. Excessive speed, underinflation, or excessive loading, either separately or in combination, can cause heat buildup and possible tire failure. ◀

### RSC – Run-Flat Tires

You will recognize Run-Flat Tires by a circular symbol containing the letters RSC on the side of the tire, page 104.

### M+S

Winter and all-season tires. These have better winter properties than summer tires.

### XL

Designation for specially reinforced tires.

## TIRE CONDITION

Inspect your tires regularly for tread wear, signs of damage and for foreign objects lodged in the tread. Check the tread depth.

### Tread depth

The tread depth should not drop below 1/8 in/ 3 mm, although, for example, European legislation only specifies a minimum tread depth of 1/16 in/1.6 mm. At tread depths below 1/8 in/ 3 mm there is an increased risk of high-speed hydroplaning, even when only small amounts of water are present on the road surface.

### Winter tires

When winter tires wear down past a tread depth of 1/6 in/4 mm, they become perceptibly less suitable for winter conditions. In the interest of safety, new tires should be installed.

### Minimum tread depth

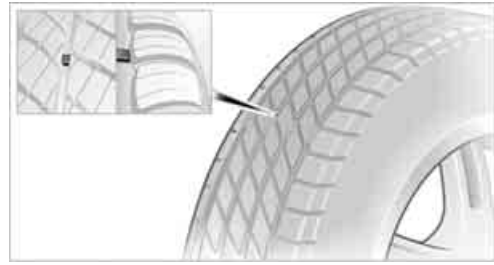

Wear indicators in the base of the tread groove are distributed around the tire's circumference; the letters TWI, for Tread Wear Indicator, on the tire's sidewalls identify tires that incorporate these wear indicators. When tire tread is worn down to the level of the wear indicators, the remaining tread depth is 1/16 in/1.6 mm.

### Tire damage

Please note that low-profile tires cause wheels, tires and suspension parts to be more susceptible to road hazard and consequential damages.

Unusual vibrations encountered during normal vehicle operation can indicate tire failure or some other vehicle defect. This can, for example, be caused by driving over curbs. The same applies to any other abnormal road behavior, such as pulling severely to the right or left.

 In these cases, reduce speed immediately and have wheels and tires thoroughly checked. To do so, drive carefully to the nearest MINI Dealer or tire shop that works according to MINI repair procedures with correspondingly trained personnel. If necessary, have the vehicle towed there. Otherwise tire damage can be extremely dangerous for vehicle occupants and other road users. ◀

### Tire age

The manufacturing date of tires is contained in the tire coding:

DOT ... 4707 means that the tire was manufactured in week 47 of 2007.

For various reasons, such as the development of brittleness, the manufacturer of your MINI rec-

ommends tire replacement after no more than 6 years, regardless of the actual wear of the tires.

## RUN-FLAT TIRES\*



The symbol identifying Run-Flat Tires is a circle with the letters RSC on the sidewall. Run-Flat Tires comprise a conditionally self-supporting tire and a special rim. The reinforcement in the sidewalls ensures that the tire can continue to be used subject to certain restrictions, even if depressurized.

For information on continuing to drive with a flat tire, refer to Indication of a flat tire, page 60.

## NEW WHEELS AND TIRES

**⚠** Have new wheels and tires mounted only by your MINI Dealer or a specialized tire shop that has specially trained personnel working in accordance with the specifications of the MINI manufacturer. If this work is not carried out properly, there is a danger of subsequent damage and related safety hazards. Make sure that the new wheels are balanced. ◀

### Retreaded tires

**⚠** The manufacturer of your MINI recommends that you avoid using retreaded tires, as this could impair driving safety. The causes for this include potentially different tire casing structures and often wide variations in tire age, which can result in a limited service life. ◀

## Correct wheels and tires

**⚠** The manufacturer of your MINI recommends mounting only wheels and tires that it has specifically approved for use on your particular model. Although other wheels and tires may theoretically have the same dimensions, variations in factors such as manufacturing tolerances can result in contact between tire and bodywork, ultimately leading to serious accidents. The manufacturer of your MINI cannot evaluate non-approved wheels and tires to determine if they are suited for use, and therefore cannot ensure the operating safety of the vehicle if they are mounted. ◀

Your MINI Dealer will be glad to inform you about the correct wheel and tire combination for your vehicle.

The correct combination of wheels and tires is also necessary to ensure reliable operation of various vehicle systems such as ABS and DSC.

To maintain good handling and vehicle response, use only tires of a single brand and tread configuration. After a tire has been damaged, mount the previous wheel and tire combination again as soon as possible.

## Wheels with Tire Pressure Monitor TPM electronics

When mounting new tires or changing over from summer to winter tires, or vice versa, only use wheels with TPM electronics; otherwise the Tire Pressure Monitor may not be able to detect a puncture, refer to page 62. Your MINI Dealer will be glad to advise you.

## Recommended tire brands

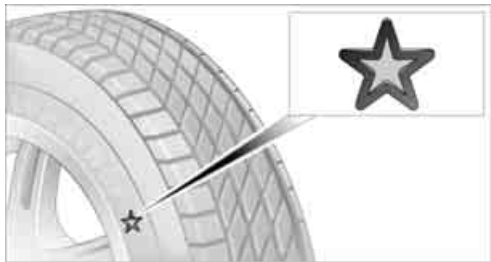

For each tire size, the manufacturer of your MINI recommends certain tire brands. They are marked with a clearly visible MINI designation on the sidewall of the tire.

When properly used, these tires meet the highest standards in terms of safety and handling characteristics.

## Run-Flat Tires\*

When mounting new tires or changing over from summer to winter tires and vice versa, mount Run-Flat Tires for your own safety. Keep in mind that no space-saver spare tire is available in the event of a flat. Your MINI Dealer will be glad to advise you.

## Special characteristics of winter tires

The manufacturer of your MINI recommends winter tires for driving in adverse winter road conditions. Although all-season M+S tires provide better winter traction than summer tires, they generally fail to provide the same levels of cold-weather performance as winter tires.

## Pay attention to speed

 Always comply with the speed limit for the winter tires mounted on your car; failure to do so could result in tire damage and accidents. ◀

If the car is capable of speeds higher than that permitted for the winter tires, a label stating the maximum permitted speed for the mounted tires must be displayed in your field of view. Specialist tire dealers and your MINI Dealer can supply these labels.

## Storage

Always store wheels and tires in a cool, dry place with as little exposure to light as possible. Always protect tires against all contact with oil, grease and fuels.

Do not exceed the maximum tire inflation pressure indicated on the sidewall of the tire.

## Swapping wheels among the axles

The manufacturer of your MINI recommends that you do not swap the front wheels with the rear wheels.

## SNOW CHAINS\*

Only certain types of fine-link snow chains have been tested by the manufacturer of your MINI, classified as road-safe and recommended. Contact your MINI Dealer for more details.

Only attach snow chains in pairs to the front wheels with the following tires.

▷ 175/65 R 15 M+S

▷ 175/60 R 16 M+S

Observe the manufacturer's instructions when mounting snow chains. Do not exceed a speed of 30 mph or 50 km/h.

 Do not initialize the Flat Tire Monitor if snow chains are mounted, otherwise the instrument might issue an incorrect reading. When driving with snow chains, you may find it helpful to deactivate ASC or DSC temporarily, refer to page 58. ◀

# UNDER THE BONNET

**⚠** Do not work on the car unless you possess the necessary technical knowledge. If you are not familiar with the regulations to be observed, have the necessary work on your vehicle carried out only by a MINI Dealer or a workshop that has specially trained personnel working in accordance with the specifications of the MINI manufacturer. If this work is not carried out properly, there is a danger of subsequent damage and related safety hazards. ◀

## BONNET

### Releasing

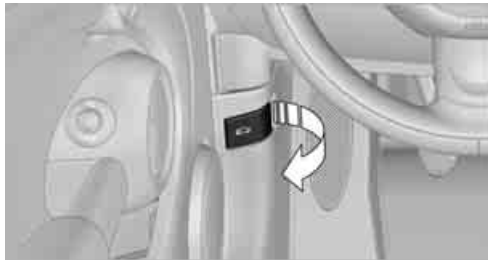

Pull the lever.

**⚠** Do not clean the windshield and headlamps if the bonnet is unlocked as this may damage the headlamp washer system\*. ◀

### Opening



**⚠** To avoid damage, make sure that the wiper arms are against the windshield before you open the bonnet. ◀

Press the release handle and open the bonnet.

### Closing

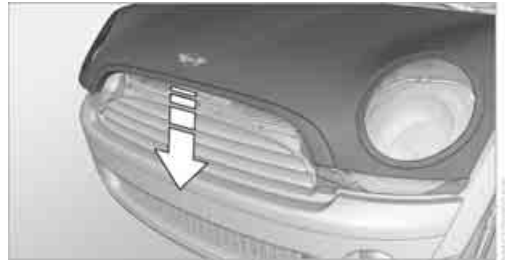

Close the bonnet from a height of approx. 16 in/ 40 cm with momentum. It must be clearly heard to engage.

**⚠** If you notice any signs while driving your vehicle that the bonnet is not completely closed, stop at once and close it securely. Make sure that the closing path of the bonnet is clear, otherwise injuries may result. ◀

# IMPORTANT PARTS OF THE ENGINE COMPARTMENT

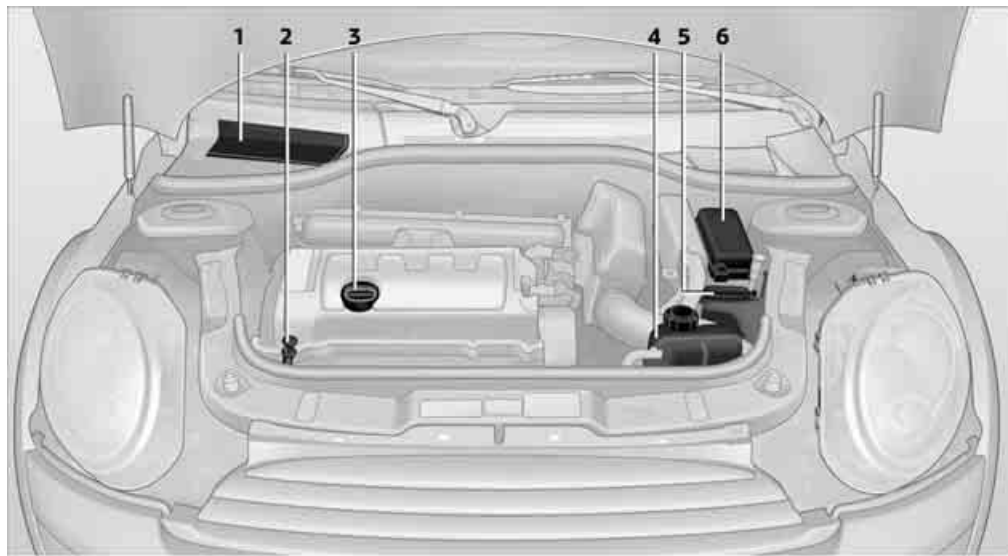

- 1 Battery, under the cover 128
- 2 Engine oil dipstick 107
- 3 Engine oil filler neck 108
- 4 Coolant expansion tank 108
- 5 Reservoir for washer fluid for the headlamp and window washer system 46
- 6 Engine compartment fuse box 125

## ENGINE OIL

The engine oil consumption is dependent on driving style and driving conditions.

### Checking engine oil level

1. With the vehicle's engine at normal operating temperature, i.e. after uninterrupted driving for at least 6 miles/10 km, park the vehicle on a level surface.
2. Switch off the engine.
3. Pull the dipstick out after approx. 5 minutes and wipe it off with a lint-free cloth, paper towel or similar material.
4. Carefully push the dipstick all the way into the guide tube and pull it out again. The oil level should be between the two marks on the dipstick.



The oil quantity corresponding to the difference between the two marks on the dipstick is 1 US quart/1 liter.

 Do not fill beyond the upper mark on the dipstick. Excess oil will damage the engine. ◀

AT A GLANCE

CONTROLS

DRIVING TIPS

MOBILITY

REFERENCE

## Adding engine oil

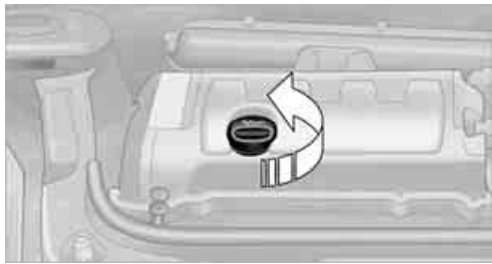

Do not add the maximum quantity of 1 US quart/1 liter of engine oil until the oil level has dropped to just above the lower mark on the dipstick, page 107.

 Add oil within the next 30 miles/50 km, otherwise the engine could be damaged. ◀

 Keep oils, greases, etc. out of the reach of children and comply with the warnings on the containers. Otherwise, health hazards may result. ◀

### Oil change

Have the oil changed only by a MINI Dealer or a workshop that has specially trained personnel working in accordance with the specifications of the MINI manufacturer.

### Approved engine oils

The quality of the engine oil selected has critical significance for the operation and service life of an engine. Based on extensive testing, the manufacturer of your MINI approves only certain grades of engine oil on a regular basis.

Only use High Performance Synthetic Oil approved by the manufacturer of your MINI.

If MINI High Performance Synthetic Oil is not available, you can add small quantities of another synthetic oil in between oil changes. Only use oils with the API SM specification or higher.

 If you have any further questions regarding MINI High Performance Synthetic Oil or approved synthetic oils, your MINI Dealer will be glad to advise you. ◀

You can also call MINI USA at 1-800-831-1117 or visit the website [www.miniusa.com](http://www.miniusa.com) to obtain this information.

### Viscosity grades

Viscosity is a measure of an oil's flow rating and is categorized in SAE classes.

The correct SAE grade for your MINI is determined by the climatic conditions of the region in which you normally drive your MINI.

 Approved oils belong to the 5W-40 and 5W-30 classes. ◀

These oils can be used for driving at all outside temperatures.

MINI RECOMMENDS 

## COOLANT

 Do not add coolant to the cooling system when the engine is hot. Escaping coolant can cause burns. ◀

Coolant consists of half water and half additive. Not all commercially available additives are suitable for your MINI. Your MINI Dealer knows which additives are suitable and will be glad to advise you.

 Only use suitable additives, otherwise engine damage may result. Because additives are harmful to your health, it is important to follow the instructions on the containers. ◀

 Comply with the appropriate environmental protection regulations when disposing of coolant additives. ◀

### Checking coolant level

1. Do not open the bonnet until the engine has cooled down.
2. Turn the cap of the expansion tank a little counterclockwise to allow any accumulated pressure to escape, then continue turning to open.
3. The coolant level is correct if it is between the Min and Max markings.

4. If the coolant is low, slowly add coolant up to the specified level; do not overfill.
5. Turn the cap until there is an audible click.
6. Have the reason for the coolant loss eliminated as soon as possible.

AT A GLANCE

CONTROLS

DRIVING TIPS

MOBILITY

REFERENCE

# MAINTENANCE

## MINI MAINTENANCE SYSTEM



The MINI Maintenance System supports the preservation of the traffic and operating safety of your MINI. The objective is to optimize efforts with respect to minimal vehicle maintenance costs.

If and when you come to sell your MINI, a comprehensive record of servicing will prove a significant benefit.

### Condition Based Service CBS

Sensors and special algorithms take the different driving conditions of your MINI into account. Condition Based Service uses this to determine the current and future service requirements. By letting you define a service and maintenance regimen that reflects your own individual requirements, the system builds the basis for trouble-free driving.

In the tachometer, you can have the remaining times or distances for selected maintenance tasks and any legally prescribed dates displayed, page 53.

### Service data in the remote control

Your vehicle continuously stores service-requirement information in the remote control while you are driving. Your MINI Dealer can read out this data from the remote control unit, and propose an optimized maintenance approach. Whenever you take your car in for servicing you should therefore hand your MINI Dealer the remote control unit that you last used.

 Make sure that the date in the tachometer is always set correctly, page 55; otherwise the effectiveness of Condition Based Service CBS is not assured. ◀

### Service and Warranty Information Booklet for US models and Warranty and Service Guide Booklet for Canadian models

Please consult your Service and Warranty Information Booklet for US models and Warranty and Service Guide Booklet for Canadian models for additional information on service requirements.

 The manufacturer of the MINI recommends that you have service and repair operations performed at your MINI Dealer. Take the time to ensure that these service procedures are confirmed by entries in your vehicle's Service and Warranty Information Booklet for US models and Warranty and Service Guide Booklet for Canadian models. These entries verify that your vehicle has received the specified regular maintenance. ◀

## SOCKET FOR ONBOARD DIAGNOSIS OBD

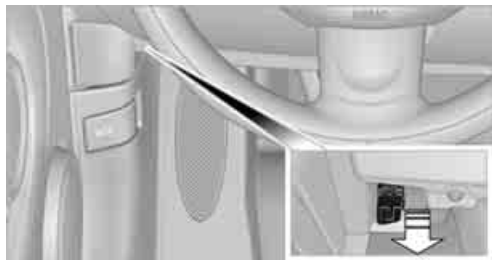

Primary components that make up exhaust emissions can be checked by a device via the OBD socket.

This socket is located to the left of the driver's side, on the bottom of the instrument panel.



## EXHAUST EMISSION VALUES



The warning lamps come on. The exhaust emission values have turned poor and there is a danger of engine damage. You can continue your journey, but moderate your speed and exercise due caution. Have the car checked as soon as possible.



Under certain circumstances, one of the lamps will flash or light up continuously. This indicates excessive misfiring or a malfunction in the engine. If this happens, reduce your speed and visit the nearest MINI Dealer as soon as possible. Severe misfiring can quickly lead to serious damage of emissions-related components, especially the catalytic converter. In addition, mechanical engine components can become damaged.

If the fuel filler cap is not properly tightened, the OBD system may conclude that fuel vapors are escaping, causing an indicator to light up. If the filler cap is then tightened, the indicator should go out within a few days.

### Event data recorders

Your vehicle may be equipped with one or several measuring or diagnostic modules or a device for recording or sending certain vehicle data or information.

# CARE

## Suitable car-care products

 Use the cleaning and car-care products available at your MINI Dealer. ◀

 Cleaning agents may contain hazardous or health-damaging substances. Follow the warning and hazard instructions on the packaging. For interior cleaning, always open the doors or windows of the vehicle.

Do not use any products that are not intended for cleaning the vehicle. ◀

## Washing your vehicle

You can wash your new MINI in an automatic car wash from the first day. Preference should be given to cloth car washes. If, due to lack of availability, brush car washes must be used, modern systems with soft brushes should be given preference.

 When using steam jets or high-pressure washers, ensure that you maintain a sufficient distance to the vehicle and do not exceed a maximum temperature of 140°F / 60°C. If the jet is too close or the pressure is too high, this can lead to damage or initial damage that can develop into more serious damage. Water that enters vehicle components can lead to damage over the long term.

After washing the vehicle, apply the brakes briefly to dry them, otherwise water can reduce braking efficiency over the short term and the brake rotors can corrode.

Switch the rain sensor off when passing through an automatic car wash, page 44. Failure to do so could result in damage caused by undesired wiper activation. ◀

## Frameless doors

In car washes working with high pressures and jet positions near the vehicle windows, small amounts of water may drip into the interior.

## Rear window wiper

In automatic car washes, the rear window wipers may be damaged. Ask the car wash operator

about measures that can be taken to protect the wipers.

## Rod antenna

If necessary, for example before entering a car wash or a garage with an elevator ramp, remove the rod antenna.

## Headlamps

Do not wipe dry and do not use abrasive or corrosive cleaning agents. Remove dirt and contamination, such as insects, by soaking with shampoo and then rinsing with plenty of water. Do not remove accumulated ice and snow with an ice scraper; use window de-icers instead.

## Vehicle paintwork

Regular care contributes greatly to driving safety and value retention.

Environmental influences varying from one region to the next can affect the vehicle paintwork. Base the frequency and scope of car care on these various influences.

## Care of upholstery

Depressions that come about on the upholstery material of the seats in daily use can be brushed out using a slightly damp brush against the grain.

The fact that velour lays down is not a quality defect but rather is inevitable, as it is with home textiles or clothing.

In the case of strong sunlight and longer parking periods, cover the seats or all windows to prevent discoloration.

## Care of special parts

### Light-alloy wheels\*

Especially in the winter months, care for the wheel rims with wheel rim cleaner. Do not use acidic, strongly alkaline and abrasive cleaning

agents or steam jets. Follow the manufacturer's instructions.

### Chrome parts\*

Carefully clean vehicle parts such as the radiator grill and door handles with copious quantities of water and, if necessary, a shampoo additive, especially when contaminated with road salt. For additional treatment, use chrome polish.

### Rubber parts

Treat only with water or rubber care products.

 Do not use silicon sprays or other silicon-containing care products on rubber seals, otherwise noise and damage could occur. ◀

### Fine wood parts\*

Clean fine wood trim and fine wood parts with a damp cloth only. Wipe dry with a soft cloth.

### Plastic parts

These include:

- ▷ Plastic surfaces
- ▷ Headliner
- ▷ Lamp glass
- ▷ Display panes
- ▷ Parts with matt black coating

Only clean with water and, if necessary, cleaning agents for plastic materials. Do not dampen seats or the headliner.

 Do not use solvents such as alcohol, lacquer thinner, cold cleaners, fuel, or similar, as these will damage the surfaces. ◀

### Safety belts

Dirty safety belts resist being reeled in and thus compromise safety.

 Do not dry clean, as the fabric can be destroyed. ◀

Only clean using mild soap, leaving the belts installed.

Allow safety belts to be reeled in only when they are dry.

### Floor carpets and mats\*

Floor mats can be removed to allow the vehicle interior to be cleaned.

Clean with interior cleaner if very soiled.

### Wiper blades

Clean with soapy water. Replace wiper blades twice a year, before and after the cold season. This is particularly important on vehicles fitted with a rain sensor.

### Displays

To clean the displays, e.g. of the onboard monitor, etc., use a display cleaning cloth or a cloth lightly moistened with water.

 Do not use chemical or household cleaning agents. Keep fluids of any kind and moisture away from the device. Surfaces and components may otherwise become corroded or damaged. ◀

### Leather care

The leather\* used by the manufacturer of your MINI is a high quality natural product processed according to the latest methods in leather preparation.

Dust and road grit in the pores and folds of the leather have an abrasive effect, leading to increased wear and causing the leather surface to become brittle prematurely.

Frequently clean the leather of dust using a cloth or vacuum cleaner.

Treat the leather twice a year using a leather care product as dirt and grease will gradually attack the leather's protective layer. This preserves the quality of the leather and prevents electrostatic charges.

### Vehicle storage

Your MINI Dealer will be glad to advise you on what is important if the vehicle is to be decommissioned for longer than three months.

# REPLACING COMPONENTS

## ONBOARD TOOL KIT



Your vehicle comes with an onboard tool kit that varies with the equipment version; it is stored underneath the level load floor.

- ▷ Mobility System with onboard tool kit and tire change set\* 120
- ▷ Tire change set with onboard tool kit for space-saver spare tire 122

## WIPER BLADES

### Changing the front wiper blades

1. Fold up the wiper arm.

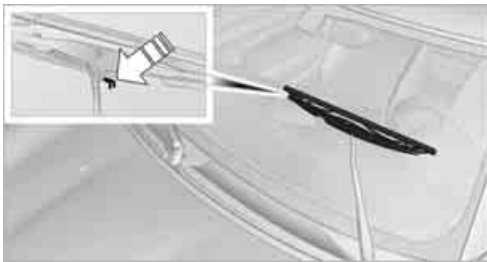

2. Position the wiper blade horizontally.
3. Press the securing spring, arrow.
4. Unhook the wiper blade toward the windshield.
5. Pull the wiper blade past the wiper arm toward the top.
6. Insert the new wiper blade.
7. Press into position until you hear it engage.

 To avoid damage, make sure that the wiper arms are against the windshield before you open the bonnet. ◀

### Replacing the rear wiper blade in the MINI

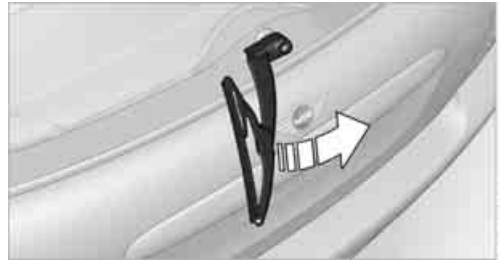

1. Fold up the wiper arm.
2. Rotate the wiper blade toward the back as far as it will go, arrow.
3. Press the wiper blade against the limit and thus out of the mounting.
4. Press the new wiper blade into the fixture until it engages audibly.

### Replacing the rear wiper blade in the MINI Clubman

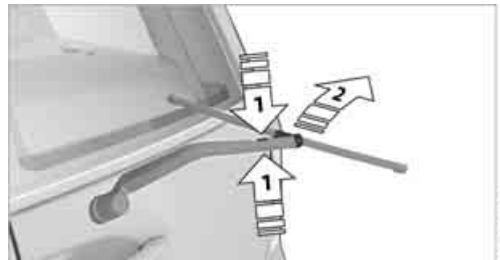

1. Fold out the wiper arm and hold it.
2. Press together the locking spring, arrow 1, and fold out the wiper blade.
3. Pull the wiper blade away from and out of the catch mechanism, arrow 2.
4. Press the new wiper blade into the fixture until it engages audibly.

## LAMPS AND BULBS

Lamps and bulbs make an essential contribution to vehicle safety. They should, therefore, be handled carefully. The manufacturer of your MINI recommends having your MINI Dealer perform any work that you do not feel competent to perform yourself or that is not described here.

 Never touch the glass of new bulbs with your bare fingers, as even minute amounts of contamination will burn into the bulb's surface and reduce its service life. Use a clean tissue, cloth or something similar, or hold the bulb by its base. ◀

You can obtain a selection of replacement bulbs at your MINI Dealer.

 When working on electrical systems, always begin by switching off the consumer in question, otherwise short circuits could result. To avoid possible injury or equipment damage when replacing bulbs, observe any instructions provided by the bulb manufacturer. ◀

Caring for headlamps, refer to page 112.

 For any bulb replacement not described below, contact a MINI Dealer or a workshop that has specially trained personnel working in accordance with the specifications of the MINI manufacturer. ◀

 For checking and adjusting headlamp aim, please contact your MINI Dealer. ◀

### Light-emitting diodes LEDs

Light-emitting diodes installed behind translucent lenses serve as the light sources for many of the controls and displays in your vehicle. These light-emitting diodes are related to conventional laser diodes, and legislation defines them as Class 1 light-emitting diodes.

 Do not remove the covers or expose the eyes directly to the unfiltered light source for several hours, otherwise this could cause irritation to the retina. ◀

### Bi-Xenon lamps\*

The service life of these bulbs is very long and the probability of failure very low, provided that they are not switched on and off an excessive number of times. If a xenon lamp fails nevertheless, switch on the fog lamps and continue the journey with great care, provided that local legislation does not prohibit this.

 Have any work on the xenon lamp system, including bulb replacement, carried out only by a MINI Dealer or a workshop that has specially trained personnel working in accordance with the specifications of the MINI manufacturer. Due to high voltage, there is a risk of fatal injury if work on the xenon lamps is carried out improperly. ◀

### Halogen low beams and high beams

H13 bulb, 60/55 watts

 The H13 bulb is pressurized. Therefore, wear safety glasses and protective gloves. Otherwise there is a risk of injury if the bulb is damaged. ◀

 Be careful when installing the cover, otherwise leaks could occur and cause damage to the headlamp system. ◀

### Accessing the lamp from the engine compartment

The low-beam/high-beam bulb can be changed from the engine compartment.

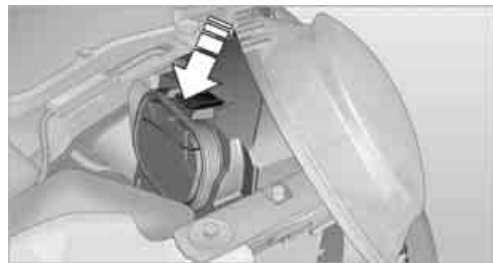

Removing the cover:

1. Press the tab.
2. Flip open the cover and take it out of the holder.

Follow the same steps in reverse order to reattach the cover.

**⚠** Be careful when installing the cover, otherwise leaks could occur and cause damage to the headlamp system. ◀

## Replacing the bulb

1. Turn the lamp counterclockwise, arrow 1, and remove it, arrow 2.

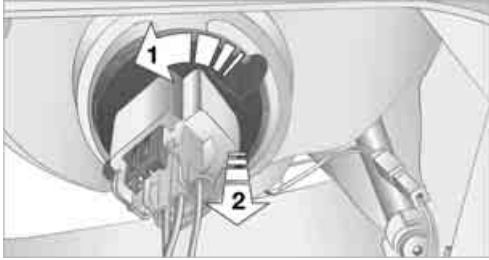

2. Push on the catch, arrow 1, and unplug the connector, arrow 2.

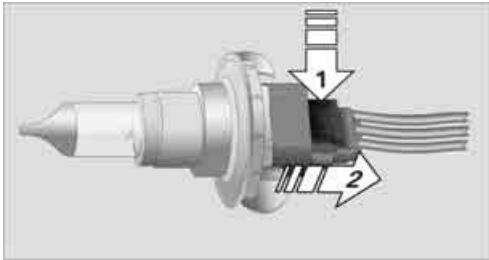

3. To insert the new bulb and replace the cover, proceed in reverse order.

## Turn signal indicators, parking lamps, roadside parking lamps and fog lamps

### Accessing the lamps via the wheel well



- 1 Turn signal
- 2 Parking/roadside parking/fog lamps

### Replacing a turn signal bulb

21 watt bulb, PY 21 W

1. Turn in the wheel.
2. Remove cover 1.  
To do so, turn the cover counterclockwise.
3. Remove the inside cover.  
To do so, turn the cover counterclockwise.

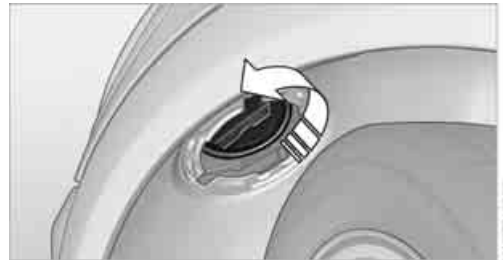

4. Screw out the bulb counterclockwise.

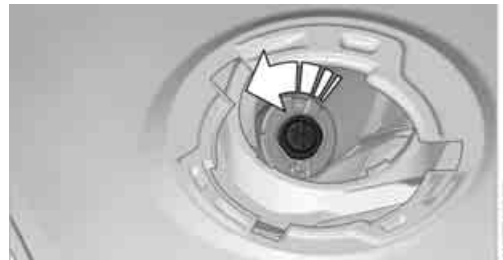

5. To insert the new bulb and replace the covers, proceed in reverse order.

## Replacing a parking/roadside parking lamp bulb

5 watt bulb, W 5 W

1. Turn in the wheel.
2. Remove cover **2**.  
To do so, turn the cover counterclockwise.
3. Screw out the upper bulb counterclockwise.

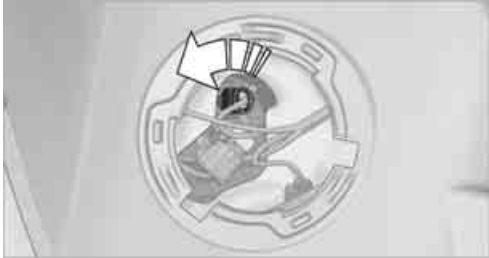

4. To insert the new bulb and replace the cover, proceed in reverse order.

## Replacing a fog lamp bulb

H8 bulb, 35 watts

1. Turn in the wheel.
2. Remove cover **2**.  
To do so, turn the cover counterclockwise.
3. Screw out the lower bulb counterclockwise.



4. To insert the new bulb and replace the cover, proceed in reverse order.

## Side turn signal indicators

5 watt bulb, W 5 W

1. Push the lamp with the ventilation grate forward and remove.

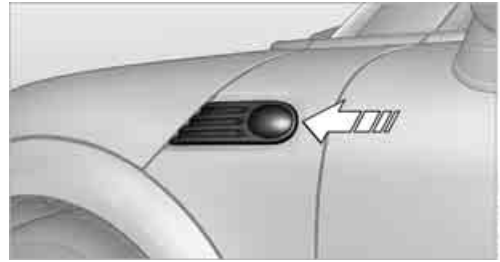

2. Screw out the bulb holder counterclockwise.
3. Pull out and replace the bulb.
4. To insert the new bulb and replace the cover, proceed in reverse order.

## Tail lamps

### MINI

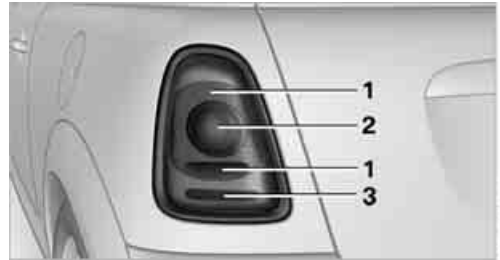

- 1 Brake lamp/tail lamp  
21 watt/5 watt bulb, W 5 W
- 2 Turn signal lamp  
21 watt bulb, P 21 W
- 3 Backup lamp  
21 watt bulb, P 21 W

## MINI Clubman

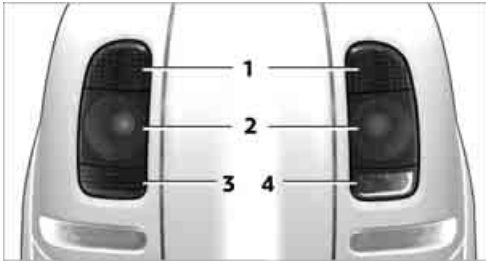

- 1 Brake lamp/tail lamp  
21 watt/5 watt bulb, W 5 W
- 2 Turn signal lamp  
21 watt bulb, P 21 W
- 3 Rear fog lamp\* P 21 W
- 4 Backup lamp  
21 watt bulb, P 21 W

## Replacing bulbs in MINI

1. Remove the cover from the sidewall of the cargo bay.

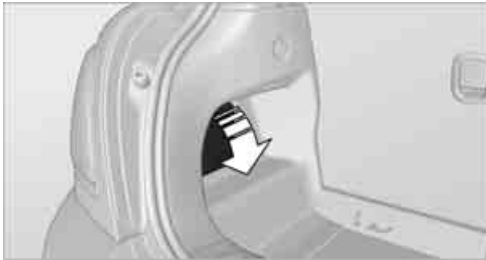

2. Screw out the desired bulb counterclockwise, arrows 1. Additional bulbs are located behind the sidewall of the cargo bay, arrow 2.

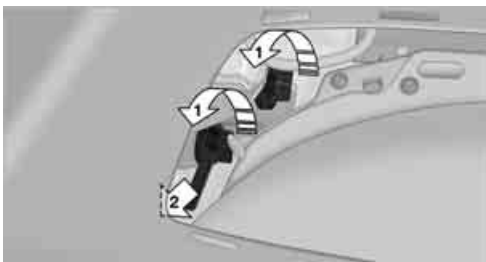

3. To insert the new bulb and replace the cover, proceed in reverse order.

## Replacing bulbs in MINI Clubman

1. Using the screwdriver from the onboard tool kit, remove the screw at the top.

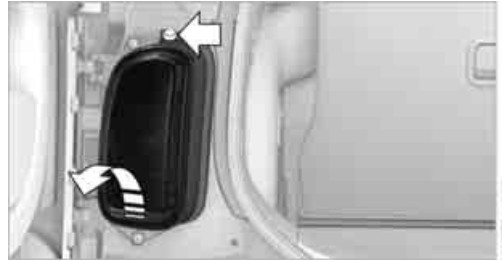

2. Swing out the tail lamp and remove it toward the top.
3. Pull off the cable connector 1, unlock the bulb holder, arrow 2, and remove it, arrow 3.

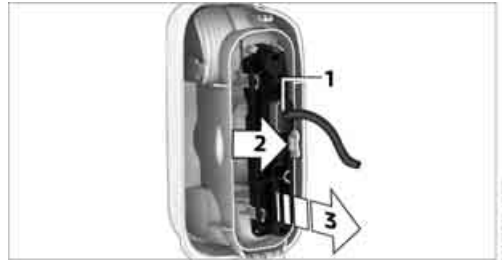

4. Screw out the respective bulb counterclockwise.
5. To insert the new bulb and reinstall the tail lamp, proceed in reverse order.

## Rear fog lamp\*

21 watt bulb, P 21 W

Access to the lamp via the back or underside of the bumper.



The illustration shows the fog lamp in the bumper of the MINI Cooper.

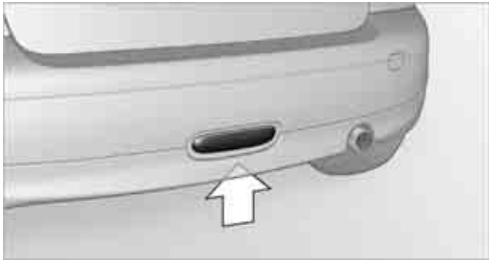

1. Screw out the bulb holder counterclockwise.
2. Screw out and replace the bulb.
3. To insert the new bulb and bulb holder, proceed in reverse order.

 In the MINI Clubman, the rear fog lamp is located in the left tail lamp, refer to Tail lamps, page 118. ◀

### License plate lamps in MINI

5 watt bulb, C 5 W



1. Using a screwdriver, push the lamp to the left in the tab of the lamp housing, arrow 1.
2. Remove the lamp, arrow 2.
3. Replace the bulb.
4. Insert the lamp.

### License plate lamps in MINI Clubman

5 watt bulb, C 5 W

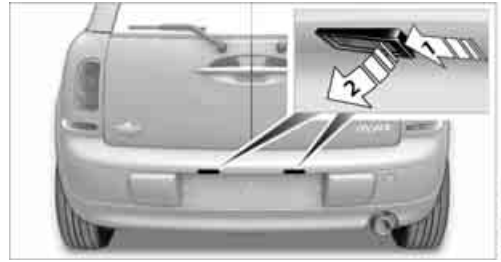

1. Using a screwdriver, push the lamp to the left in the tab of the lamp housing, arrow 1.
2. Remove the lamp, arrow 2.
3. Replace the bulb.
4. Insert the lamp.

### Center brake lamp

This lamp uses LED technology for operation. In the event of a malfunction, contact your MINI Dealer or a workshop that has specially trained personnel working in accordance with the specifications of your MINI manufacturer.

## REPAIRING A FLAT TIRE

 Safety measures in the event of a breakdown:

Park the vehicle as far as possible from moving traffic and switch on the hazard warning flashers.

Turn the steering wheel until the front wheels are in the straight-ahead position and engage the steering wheel lock. Engage the parking brake and shift into 1st or reverse gear or place the selector lever in position P.

All passengers should be outside the vehicle and in a safe place, e.g. behind a guardrail.

Erect a warning triangle or warning flasher at the appropriate distance if necessary. Comply with all safety guidelines and regulations. ◀

In the event of a flat tire, different procedures should be followed depending on the equipment included in your vehicle:

- ▷ MINI Mobility System, refer to the following section
- ▷ Run-Flat Tires, page 104
- ▷ Tire change with space-saver spare tire, page 122

## MINI Mobility System with onboard tool kit and tire change set\*

### MINI

The MINI Mobility System with onboard tool kit and tire change set\* is located under the floor mat in the cargo bay.



- 1 Filling canister
- 2 Allen wrench\*/screwdriver
- 3 Vehicle jack\*
- 4 Wheel stud wrench
- 5 Wrench, screwdriver/Phillips screwdriver, towing eyelet
- 6 Compressor, hose with manometer and plug for cigarette lighter socket
- 7 Package with filling hose, valve remover and valve core

### MINI Clubman

The MINI Mobility System with tire change set and onboard tool kit is located under the floor mat or the level load floor in the cargo bay.

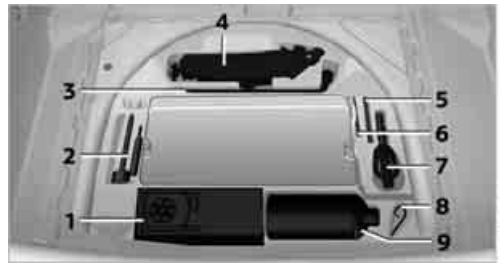

- 1 Compressor, hose with manometer and plug for cigarette lighter socket
- 2 Filling hose
- 3 Wheel stud wrench\*
- 4 Vehicle jack\*
- 5 Torx insert bit for screwdriver
- 6 Wrench
- 7 Flat screwdriver/Phillips screwdriver, towing eyelet
- 8 Hub cover remover
- 9 Filling canister

▷ Use of the MINI Mobility System may be ineffective if the tire puncture measures approx. 1/8 in/4 mm or more. Contact the nearest MINI Dealer if the tire cannot be made drivable with the MINI Mobility System. ◀

## Liquid sealant



- 1 Filling hose
- 2 Filling canister

## Filling

1. Shake the filling canister.
2. Screw the filling hose onto the filling canister.

3. Unscrew the dust cap from the valve of the defective tire.
4. Screw out the valve core with the valve remover. The valve remover is located in a package with the filling hose.
5. Remove the cap from the filling hose.
6. Push the filling hose onto the tire valve.
7. Hold the filling canister with the cap down and squeeze.
8. Squeeze the entire contents of the canister into the tire.
9. Remove the filling hose.
10. Screw the valve core into the tire valve with the valve remover.

 In the event of a lost or dirty valve core you will find another valve core in the package with the filling hose. Remember that the liquid canister must be replaced every four years if the equipment has not been used. ◀

## Compressor

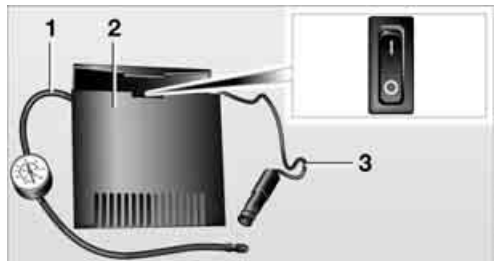

- 1 Hose with manometer
- 2 Compressor
- 3 Connector for power supply

## Reinflating the tire

1. Screw hose **1** with manometer onto the tire valve.
2. Insert connector **3** into the lighter socket in the interior of the vehicle, page **80**.
3. Switch on compressor **2**.
4. Inflate the tire to at least 26 psi/180 kPa and at most 36 psi/250 kPa.

To check the air pressure, shut off the device for a short time.

 Do not run the compressor for longer than 6 minutes, otherwise the device will overheat and possibly be damaged. ◀

If an air pressure of 26 psi/180 kPa is not reached:

1. Unscrew hose **1** and drive the vehicle forward and backward about 33 ft/10 m to distribute the liquid sealant in the tires evenly.
2. Repeat the procedure.

 If an air pressure of 26 psi/180 kPa still cannot be reached, the tire is too severely damaged. Please contact the nearest MINI Dealer. ◀

## Distributing liquid sealant

Immediately drive for approx. 10 minutes, so that the liquid sealant is uniformly distributed.

 Do not exceed speeds of 40 mph/60 km/h.

If possible, do not drop below 10 mph/20 km/h. ◀

## Checking tire inflation pressure

1. After driving for approx. 10 minutes, pull over at a suitable location.
2. Screw the hose with manometer back onto the tire valve.
3. Check the tire inflation pressure.

 The tire pressure must be at least 18 psi/130 kPa. If it is not, do not continue driving. ◀

If a tire pressure of at least 18 psi/130 kPa is displayed:

1. Switch on the compressor. Correct the tire inflation pressure to the specified value, page **96**.
2. Replace the tire as soon as possible.

## Driving on

 Do not exceed the permitted maximum speed of 50 mph/80 km/h; doing so may result in an accident. ◀

Replace the defective tire as soon as possible and have the new wheel/tire assembly balanced.

Have the MINI Mobility System refilled.

## Tire change set

When changing a tire, always observe the safety measures and the procedure for changing tires described below.

 In case of a flat tire the tire change set is not needed due to the availability of the MINI Mobility System. ◀

## CHANGING WHEELS

### Space-saver spare tire\*

To change a space-saver spare tire, proceed as follows:

- ▷ Remove space-saver spare tire, page 122
- ▷ Prepare for tire change, page 124
- ▷ Jack up vehicle, page 124
- ▷ Mount space-saver spare tire, page 124
- ▷ Tighten lug bolts, page 125
- ▷ Drive with space-saver spare tire, page 124

### MINI tire change set with space-saver spare tire\*

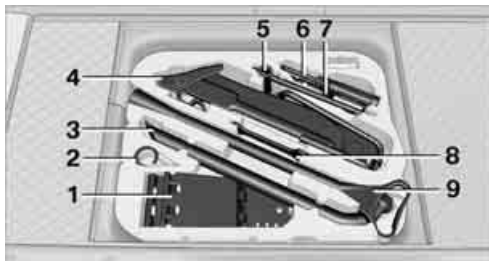

On vehicles with a space-saver spare tire, the tire change set with onboard tools is stored under the floor mat in the cargo bay.

- 1 Chock, folding
- 2 Hub cover remover
- 3 Wheel stud wrench
- 4 Vehicle jack

- 5 Special wrench for removing the space-saver spare tire
- 6 Flat screwdriver/Phillips screwdriver
- 7 Towing eyelet
- 8 Wrench
- 9 Lifting handle

The onboard tool kit includes a pouch with a plastic bag in which you can place the damaged wheel.

### Removing the space-saver spare tire

The screw connection of the space-saver spare tire is under the floor mat in the cargo bay, on the base of the storage compartment for the tire change set.

1. Unscrew the screw connection with the special wrench.
2. Take out the cover panel.



3. Screw the lifting handle from the onboard tool kit onto the thread.

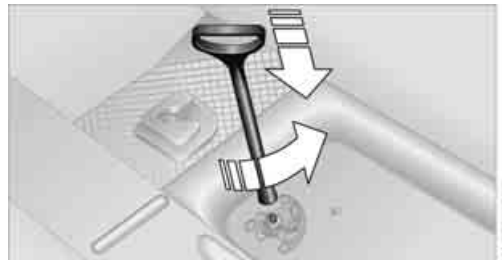

4. Raise the lifting handle slightly.

- Squeeze the securing spring.

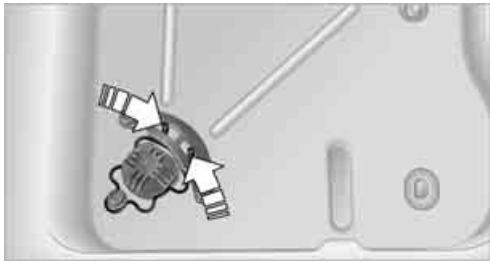

- The space-saver spare tire is released and must be held by the lifting handle.
- Lower the space-saver spare tire with the lifting handle.
- Unscrew the lifting handle.
- Pull the space-saver spare tire underneath the vehicle out towards the rear.



- Position the space-saver spare tire with the valve facing upward.
- Unscrew the valve extension from the valve of the space-saver spare tire.
- Unscrew the dust cap from the extension and place it on the valve of the space-saver spare tire.

 Due to its different dimensions, the damaged wheel cannot be placed in the recess for the space-saver spare tire. ◀

## MINI Clubman tire change set with space-saver spare tire\*

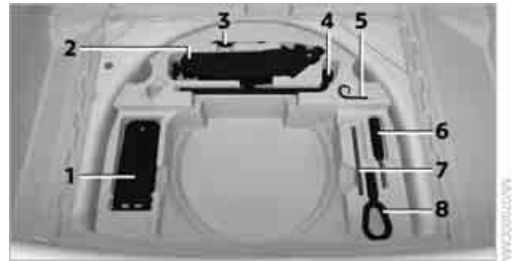

In vehicles with the space-saver spare tire, the tire change set with the onboard tool kit is located beneath the floor mat or level load floor in the cargo bay.

- Folding chock and cover for defective wheel
- Vehicle jack
- Wrench
- Wheel stud wrench
- Hub cover remover
- Flat screwdriver/Phillips screwdriver
- Torx insert bit for screwdriver
- Towing eyelet

The onboard tool kit includes a pouch with a plastic bag in which you can place the damaged wheel.

### Removing the space-saver spare tire

The space-saver spare tire is located under the tire change set in the cargo bay.

- Fold up the floor mat.
- Unscrew the nut, arrow, and remove the space-saver spare tire.



### Driving with the space-saver spare tire

Drive cautiously and do not exceed a speed of 50 mph/80 km/h.

You must expect changes in vehicle handling such as lower track stability during braking, longer braking distances and changes in self-steering properties when close to the handling limit. These effects are more pronounced when driving with winter tires.

**⚠** Only one space-saver spare tire may be mounted at one time. Mount a wheel and tire of the original size as soon as possible, to avoid any safety risks. ◀

**▶** Check the tire inflation pressure at the earliest opportunity and correct it if necessary. Replace the defective tire as soon as possible and have the new wheel/tire assembly balanced. ◀

### Preparing for a tire change

**▶** Observe the safety precautions regarding flat tires on page 119. ◀

**⚠** Additional safety measures when changing tires:

Only change the tire when parked on a surface that is level, firm and not slippery.

The vehicle or the jack could slip sideways on soft or slippery support surfaces, such as snow, ice, flagstones, etc.

Do not use a wooden block or similar object as a support base for the jack, as this would prevent it from extending to its full support height and reduce its load-carrying capacity.

Do not lie under the vehicle or start the engine when the vehicle is supported by the jack; otherwise there is a risk of fatal injury. ◀

1. Place the foldable chock\* behind the front wheel on the other side of the vehicle or in front of the wheel if the vehicle is on an incline. If the wheel is changed on a surface with a more severe slope, take additional precautions to secure the vehicle from rolling.
2. Uncover the lug bolts if necessary.

If the wheel is equipped with a hub cover, pry it off using the screwdriver from the tire change kit.

3. Loosen the lug bolts by a half turn.

### Jacking up the vehicle

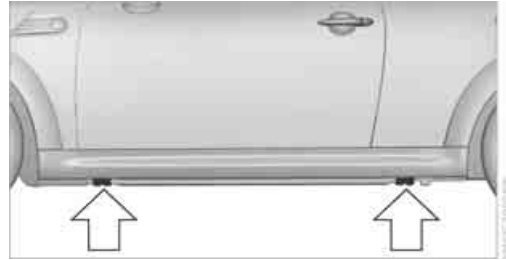

**⚠** The vehicle jack is designed for changing wheels only. Do not attempt to raise another vehicle model with it or to raise any load of any kind. To do so could cause accidents and personal injury. ◀

1. Place the jack at the jacking point closest to the wheel.  
The jack base must be perpendicular to the surface beneath the jacking point.



2. During jacking up, insert the jack head in the square recess of the jacking point.
3. Jack the vehicle up until the wheel you are changing is raised off the ground.

### Mounting the space-saver spare tire

1. Unscrew the lug bolts and remove the wheel.
2. Remove accumulations of mud or dirt from the mounting surfaces of the wheel and hub. Clean the lug bolts.
3. Lift the new wheel into place.

4. Screw at least two lug bolts finger-tight into opposite bolt holes.
5. Screw in the remaining bolts.
6. Tighten all the lug bolts firmly in a diagonal pattern.
7. Lower the vehicle.
8. Remove the jack.

### Tightening the lug bolts

Tighten the lug bolts in a diagonal pattern.

 Immediately have the wheels checked with a calibrated torque wrench to ensure that the lug bolts are firmly seated. Otherwise, incorrectly tightened lug bolts can present a safety hazard. ◀

Tightening torque: 103.3 lb ft or 140 Nm.

Replace the defective tire as soon as possible and have the new wheel/tire assembly balanced.

## VEHICLE BATTERY

 Have any work on the battery, including battery replacement, carried out only by a MINI Dealer or a workshop that has specially trained personnel working in accordance with the specifications of the MINI manufacturer. ◀

### Battery care

The battery is 100% maintenance-free, the electrolyte will last for the life of the battery when the vehicle is operated in a temperate climate.

### Charging the battery

Only charge the battery in the vehicle when the engine is off. Connections, refer to Jump starting on page 128.

### Disposal

 After replacing old batteries, return the used batteries to your MINI Dealer or to a recycling point. Maintain the battery in an upright position for transport and storage.

Always secure the battery against tipping over during transport. ◀

### Power failure

After a temporary power loss, some equipment may not be fully functional and may require initialization. Individual settings are also lost and must be reprogrammed:

- ▷ Time and date  
These values must be updated, page 54.
- ▷ Radio  
Stations must be stored again, refer to the separate Owner's Manual for Radio.
- ▷ Glass sunroof, electric  
It may only be possible to raise the sunroof, if applicable. The system must be initialized. Contact your nearest MINI Dealer.

## FUSES

 Do not attempt to repair a blown fuse or replace it with a fuse of a different color or Ampere rating. To do this could cause a fire in the vehicle resulting from a circuit overload. Have the fuse changed only by a MINI Dealer or a workshop that has specially trained personnel working in accordance with the specifications of the MINI manufacturer. ◀

A fuse allocation diagram is located on the inside of the fuse box cover panels.

### In the engine compartment



### Opening the cover

Press the latch.

## In the vehicle interior

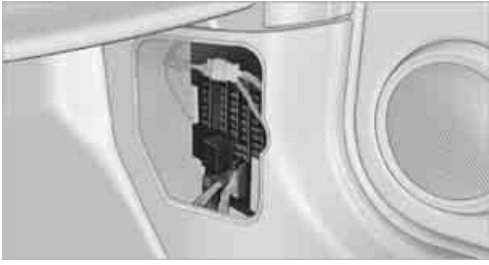

On the right side of the footwell.

### Opening the cover

Press out at the recess.



# GIVING AND RECEIVING ASSISTANCE

## ROADSIDE ASSISTANCE

The Roadside Assistance service is there to assist you around the clock in the event of a breakdown, including on weekends and public holidays.

The phone numbers of the Roadside Assistance in your home country can be found in the Contact brochure.

## FIRST AID POUCH\*

Some of the articles contained in the first aid pouch have a limited service life. Therefore, check the expiration dates of the contents regularly and replace any items in good time, if necessary.

### MINI



The first aid pouch is located on the cargo bay floor by the left side trim panel.

### MINI Clubman



The first aid pouch is located on the cargo bay floor by the left side trim panel or under the level load floor.

## WARNING TRIANGLE\*

### MINI

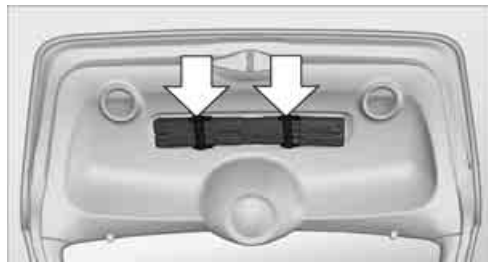

On the inside of the tailgate.  
Press the tab to take it out.

### MINI Clubman

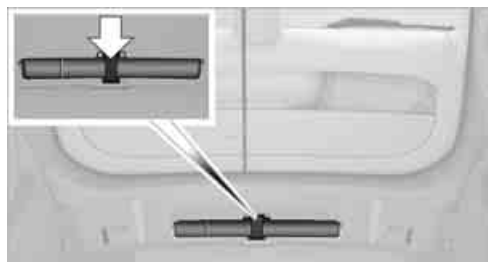

In the cargo bay under the loading sill.  
Open the center lock to take it out.

## JUMP STARTING

If the car's own battery is flat, your MINI's engine can be started by connecting two jumper cables to another vehicle's battery. You can also use the same method to help start another vehicle. Only use jumper cables with fully-insulated clamp handles.

 Do not touch any electrically live parts when the engine is running, or a fatal accident may occur. Carefully adhere to the following sequence, both to prevent damage to one or both vehicles, and to guard against possible personal injuries. ◀

### Preparation

1. Check whether the battery of the other vehicle has a voltage of 12 volts and approximately the same capacitance in Ah. This information can be found on the battery.
2. Switch off the engine of the support vehicle.
3. Switch off any consumers in both vehicles.

 There must not be any contact between the bodies of the two vehicles, otherwise there is a danger of shorting. ◀

### Connecting jumper cables

 Connect the jumper cables in the correct order, so that no sparks which could cause injury occur. ◀

1. Open the battery cover in the engine compartment to access the positive terminal of your MINI.

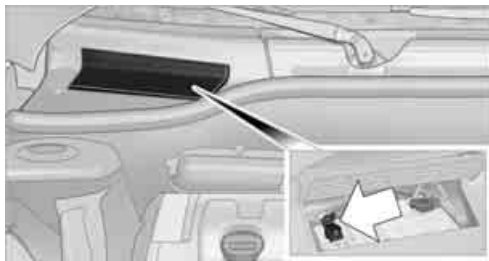

2. Attach one terminal clamp of the plus/+ jumper cable to the positive terminal of the battery or to a starting-aid terminal of the vehicle providing assistance.

3. Attach the second terminal clamp of the plus/+ jumper cable to the positive terminal of the battery or a starting-aid terminal of the vehicle to be started.
4. Attach one terminal clamp of the minus/- jumper cable to the negative terminal of the battery or to an engine or body ground of the assisting vehicle.

Body ground in MINI:

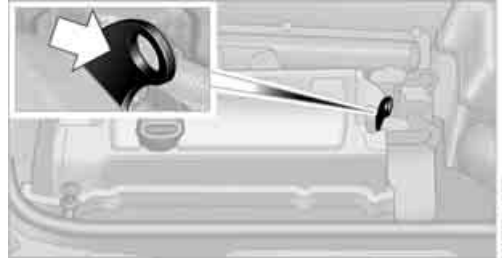

5. Attach the second terminal clamp of the minus/- jumper cable to the negative terminal of the battery or to the engine or body ground of the vehicle to be started.



### Starting the engine

1. Start the engine of the donor vehicle and allow it to run for a few minutes at slightly increased idle speed.
2. Start the engine of the other vehicle in the usual manner.  
If the first start attempt is not successful, wait a few minutes before another attempt in order to allow the discharged battery to recharge.
3. Let the engines run for a few minutes.
4. Disconnect the jumper cables by reversing the above connecting sequence.

If necessary, have the battery checked and recharged.

 Never use spray fluids to start the engine. ◀

# TOW-STARTING, TOWING AWAY

-  Observe the applicable laws and regulations for tow-starting and towing vehicles. ◀
-  Do not transport any passengers other than the driver in a vehicle that is being towed. ◀

## Using a tow fitting

The screw-in tow fitting must always be carried in the car. It can be screwed in at the front or rear of the MINI.

It is stored in the onboard tool kit in the cargo bay underneath the cover on the right-hand side, page 114.

-  Use only the tow fitting provided with the vehicle and screw it all the way in. Use the tow fitting for towing on paved roads only. Avoid lateral loading of the tow fitting, e.g. do not lift the vehicle by the tow fitting. Otherwise the tow fitting and the vehicle could be damaged. ◀

## Access to screw thread

Push out the rectangular cover panel in the bumper at the recesses.

## Front

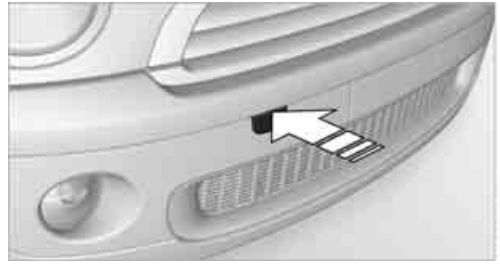

## Rear

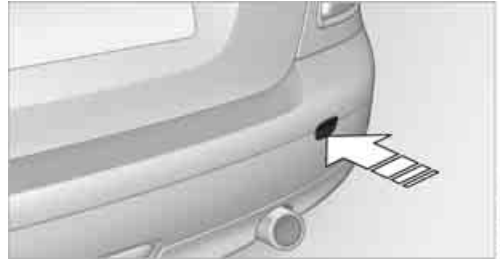

## Being towed

-  Make sure that the ignition is switched on, refer to page 39, otherwise the low beams, tail lamps, turn signal indicators and windshield wipers may be unavailable. Do not tow the vehicle with just the rear axle raised, as this would allow the steering to turn. There is no power assist while the engine is off. Thus, braking and steering will require increased effort. ◀
- Switch on the hazard warning flashers, depending on local regulations.

## Manual transmission

Gearshift lever in neutral position.

## Automatic transmission

-  Tow vehicles with automatic transmission only with a tow truck or with the front wheels lifted; otherwise the transmission can be damaged. ◀

## Towing with a tow bar

-  The towing vehicle must not be lighter than the towed vehicle, otherwise it may be impossible to maintain control. ◀

The tow fittings used should be on the same side on both vehicles. Should it prove impossible to avoid mounting the tow bar at an angle, please observe the following:

- ▷ Clearance and maneuvering capability will be sharply limited during cornering.
- ▷ The tow bar will generate lateral forces if it is attached offset.

 Attach the tow bar to the tow fittings only, as attaching it to other parts of the vehicle could result in damage. ◀

### Towing with a tow rope

When starting off in the towing vehicle, make sure that the tow rope is taut.

 To avoid jerking and the associated stresses on vehicle components when towing, always use nylon ropes or nylon straps. Attach the tow rope to the tow fittings only, as attaching it to other parts of the vehicle could result in damage. ◀

### Towing with a tow truck

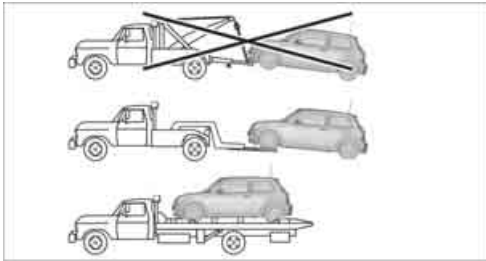

Have the MINI transported with a tow truck with a so-called lift bar or on a flat bed.

 Do not lift the vehicle by a tow fitting or body and chassis parts, otherwise damage may result. ◀

### Tow-starting

Avoid tow-starting the vehicle whenever possible; instead, jump-start the engine, page 128. Vehicles with a catalytic converter should only be tow-started when the engine is cold, vehicles with an automatic transmission cannot be tow-started at all.



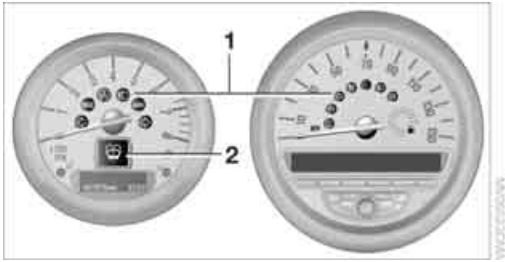

1. Switch on hazard warning flashers, comply with local regulations.
2. Switch on the ignition, page 39.
3. Shift into 3rd gear.
4. Have the vehicle tow-started with the clutch completely depressed and then slowly release the clutch. After the engine starts, immediately depress the clutch completely again.
5. Stop at a suitable location, remove the tow bar or rope and switch off the hazard warning flashers.
6. Have the vehicle checked.











# INDICATOR AND WARNING LAMPS

















or 2. See the table for information on causes and how to react. Note whether a lamp comes on alone or in combination with another. Some lamps can light up in different colors. Corresponding distinctions are made in the text.

Indicator and warning lamps can light up in various combinations and colors in indicator area 1







1	2	Cause	What to do
↔		Turn signals	
☰D		High beams/headlamp flasher switched on	
☼D		Fog lamps switched on	
☾☼		Rear fog lamp switched on	
		Fasten safety belts	Fasten your safety belt, refer also to page 33.
BRAKE		Indication in US models Parking brake applied	Release the parking brake.
		Indication in Canadian models Parking brake applied	Release the parking brake.
		Danger of icy roads	Drive cautiously, refer also to page 48.











1	2	Cause	What to do
	Lights up briefly: Approx. 2.1 US gallons/8 l of fuel remain in the tank		
	Remains on: Cruising range is no more than 30 miles/50 km, page 49		
	Engine refuses to start		Depress the brake or clutch in order to start the engine, page 39.
	Ignition switched on and driver's door open		Switch off the ignition, page 39, or close the driver's door.
	Lamps still on		
	Roadside parking lamps on		
	Door open		
	Clubdoor open		
	Splitdoor open		
	Bonnet open		
	Tailgate open		
	Gas cap missing or loose		Make sure that the gas cap is correctly positioned and close it until it audibly clicks. Do not jam the strap between the gas cap and the vehicle.















1	2	Cause	What to do
		Window washer fluid level too low	Add washer fluid as soon as possible, page 46.
		Lights up in yellow: The engine will start the next time the start/stop button is touched, possibly without the brake or clutch being depressed	
		Remote control malfunctioning or, in cars with convenient access, not detected	The engine cannot be started. Have the remote control checked, if necessary.
		Battery in remote control discharged	Use the remote control for a longer journey or, in cars with convenient access, replace the battery.
		Belt tensioners and/or airbag system failed	Have the system checked immediately. Fasten the safety belts anyway.
		Power steering failed	You can continue your journey, but moderate your speed and exercise due caution. Steering response will be markedly different. Have the system checked without delay.
		Lights up: Emergency calling system failed or malfunctioning	Have the system checked as soon as possible.
		Lights up in red: Engine malfunction	Stop the car and switch off the engine. You cannot continue your journey. Contact your MINI Dealer.
		Lights up in yellow: Full engine power no longer available	You can continue your journey, but moderate your speed and exercise due caution. Have the engine checked as soon as possible.





1	2	Cause	What to do
 	Indicator lamp 1 flashes:	Engine malfunction under high load. High engine load will result in damage to the catalytic converter	You can continue your journey, but moderate your speed and exercise due caution. Have the vehicle checked without delay.
	Indicator lamp 1 comes on:	Engine malfunction with adverse effect on exhaust emissions	You can continue your journey, but moderate your speed and exercise due caution. Have the car checked as soon as possible.
	Lights up in red:	Engine overheating	Carefully bring the car to a stop, switch off the engine and allow it to cool down. Do not open the bonnet, otherwise there would be a risk of injury by scalding. Contact your MINI Dealer.
	Lights up in yellow:	Engine too hot	Continue driving at more moderate speed so that the engine can cool down. Have the engine checked without delay if the situation reoccurs.
	Lights up in red:	Battery is no longer being charged. Alternator malfunction	Switch off all unnecessary electrical consumers. Have the battery checked without delay.
	Lights up in yellow:	Battery charge level very low, battery aged or not securely connected	Have the battery checked as soon as possible.
BRAKE		Indication in US models	
		Parking brake applied	





1	2	Cause	What to do
		Indication in Canadian models  Parking brake applied	
BRAKE		Indication in US models  Lights up in red:  Brake fluid level too low	Brake pedal travel may be markedly longer. Stop immediately. Contact the nearest MINI Dealer.
		Lights up in yellow:  Hill Start Assist failed. The car will not be held in place after the brake is released	Have the system checked as soon as possible.
		Indication in Canadian models  Lights up in red:  Brake fluid level too low	Brake pedal travel may be markedly longer. Stop immediately. Contact the nearest MINI Dealer.
		Lights up in yellow:  Hill Start Assist failed. The car will not be held in place after the brake is released	Have the system checked as soon as possible.
BRAKE		Indication in US models  Brake pads worn	Have the condition of the brake pads checked without delay.
		Indication in Canadian models  Brake pads worn	Have the condition of the brake pads checked without delay.











1	2	Cause	What to do
<p>ABS</p> <p>BRAKE</p> 		<p>Indication in US models</p> <p>Vehicle electronics failed</p>	<p>You cannot continue your journey. Contact your MINI Dealer.</p>
		<p>Indication* in Canadian models</p> <p>Vehicle electronics failed</p>	<p>You cannot continue your journey. Contact your MINI Dealer.</p>
<p>ABS</p> 		<p>Indication* in Canadian models</p> <p>Vehicle electronics failed</p>	<p>You cannot continue your journey. Contact your MINI Dealer.</p>
		<p>Lights up in red:</p> <ul style="list-style-type: none"> <li>▷ Starter failed or</li> <li>▷ ignition malfunctioning. Engine restart only possible when brake is depressed or</li> <li>▷ lighting system failed. Low beams/tail lamps and brake lamps still operational. All other lamps failed</li> </ul> <hr/> <p>Lights up in yellow:</p> <ul style="list-style-type: none"> <li>▷ Control of the brake lamps failed or</li> <li>▷ fuel supply malfunctioning</li> </ul>	<p>Have the system in question checked without delay.</p> <p>The engine cannot be restarted.</p> <p>You can continue your journey, but moderate your speed and exercise due caution. Have the system in question checked without delay.</p>
		<p>Flashing:</p> <p>Automatic Stability Control ASC or Dynamic Stability Control DSC is controlling drive and braking forces, refer also to page 57</p>	
		<p>Automatic Stability Control ASC or Dynamic Stability Control DSC deactivated, refer also to page 57</p>	<p>Driving stability limited during acceleration and cornering. Driving style must be adjusted.</p>





1	2	Cause	What to do
 		Suspension control system failed, refer also to page 59	Driving stability limited during acceleration and cornering. You can continue your journey, but moderate your speed and exercise due caution. Have the system checked as soon as possible.
ABS BRAKE  		Indication in US models  The driving stability control systems, including ABS and the Tire Pressure Monitor, have failed, refer also to page 59	You can continue your journey. Reduced braking and driving stability. Drive cautiously and think well ahead. Avoid braking with full force, driving on rough tracks, and depressing the accelerator pedal to full throttle or kick-down position. Have the system checked immediately.
   		Indication* in Canadian models  The driving stability control systems, including ABS and the Flat Tire Monitor or the Tire Pressure Monitor*, have failed, refer also to page 59	You can continue your journey. Reduced braking and driving stability. Drive cautiously and think well ahead. Avoid braking with full force, driving on rough tracks, and depressing the accelerator pedal to full throttle or kick-down position. Have the system checked immediately.
ABS   		Indication* in Canadian models  The driving stability control systems, including ABS and the Flat Tire Monitor or Tire Pressure Monitor*, have failed, refer also to page 59	You can continue your journey. Drive cautiously and think well ahead. Avoid braking with full force, driving on rough tracks, and depressing the accelerator pedal to full throttle or kick-down position. Have the system checked immediately.

1	2	Cause	What to do
 	<p>Vehicles with Flat Tire Monitor*</p> <hr/> <p>Light up in yellow and red:</p> <ul style="list-style-type: none"> <li>▷ Tire damage</li> <li>▷ Flat Tire Monitor not initialized</li> </ul> <hr/> <p>Light up in yellow:</p>	<p>Flat Tire Monitor failed. Punctures are not indicated</p>	<p>Carefully bring the car to a stop. Observe the information starting on page <a href="#">59</a>.</p> <p>Initialize Flat Tire Monitor, page <a href="#">60</a>.</p> <p>Have the system checked.</p>
 	<p>Vehicles with Tire Pressure Monitor*</p> <hr/> <p>Light up in yellow and red:</p> <ul style="list-style-type: none"> <li>▷ There is a flat tire or substantial loss in tire pressure</li> <li>▷ Tire Pressure Monitor not initialized</li> </ul> <hr/> <p>Light up in yellow:</p>	<p>Tire Pressure Monitor failed. Punctures are not indicated</p>	<p>Carefully bring the car to a stop. Observe the information starting on page <a href="#">61</a>.</p> <p>Initialize the Tire Pressure Monitor, page <a href="#">62</a>.</p> <p>Have the system checked. Observe the information starting on page <a href="#">63</a>.</p>

1	2	Cause	What to do
	 <p>Lights up in red:</p> <ul style="list-style-type: none"> <li>▷ Transmission limp-home program active with restricted range of gears, possibly with reduced acceleration</li> <li>▷ Gears can be engaged without depressing the brake</li> <li>▷ Automatic selector lever locked</li> </ul> <hr/> <p>Lights up in yellow:</p> <ul style="list-style-type: none"> <li>▷ Automatic selector lever locked: Selector lever locked in position P with engine running and brake depressed or</li> <li>▷ brake signal malfunctioning: gear can be engaged without depressing the brake</li> </ul>		<p>You can continue your journey, but moderate your speed and exercise due caution. Have the system checked without delay.</p> <p>Always depress the brake to engage a gear.</p> <p>Overriding the selector lever lock, page 43.</p> <hr/> <p>Have the system checked as soon as possible.</p> <p>Overriding the selector lever lock, page 43.</p> <p>To engage a gear while the vehicle is at a standstill, always depress the brake. Before leaving the vehicle, move the selector lever to position P and switch off the engine.</p>
	 <p>Lights up in red:</p> <p>Transmission overheating</p> <hr/> <p>Lights up in yellow:</p> <p>Transmission too hot</p>		<p>Bring the car to a stop and move the selector lever to position P. Allow the transmission to cool down. You can continue your journey, but moderate your speed and exercise due caution. Have the system checked if the situation reoccurs.</p> <p>Avoid high engine loads. You can continue your journey, but moderate your speed and exercise due caution.</p>
	 <p>Selector lever position P not engaged. Vehicle not prevented from rolling</p>		



1	2	Cause	What to do
	Selector lever position P not engaged. Ignition cannot be switched off		Engage selector lever position P when you wish to switch off the ignition, page 39.
	Lights up in red:  Electric steering wheel lock malfunctioning		The engine can no longer be started. If applicable, do not switch off the engine. Contact your MINI Dealer.
	Lights up in yellow:  Electric steering wheel lock engaged		Move the steering wheel before starting the engine.
	Cruise control system failed		Have the system checked.
	Park Distance Control failed		Have the system checked.
	Bulb of exterior lighting system failed		Have the exterior lighting checked as soon as possible.
	Low-beam headlamp or fog lamp failed		Have the lamps checked as soon as possible.
	High-beam headlamp failed		Have the high-beam headlamps checked.
	Rear fog lamp failed		Have the rear fog lamp checked.
	Headlamp beam throw adjustment system failed		Have the headlamp beam throw adjustment system checked.
	Coolant level too low		Add coolant immediately, page 108.
	Engine oil pressure too low		Stop immediately and switch off the engine. You cannot continue your journey. Contact your MINI Dealer.

1	2	Cause	What to do
	Lights up in red:	Service appointment overdue	Arrange a service appointment. Check service requirements, page 53.
	Lights up in yellow:	Service due	Arrange a service appointment. Check service requirements, page 53.
	No service due		
	Set speed limit exceeded		
	Time and date no longer correct		Set the time and date, page 54.

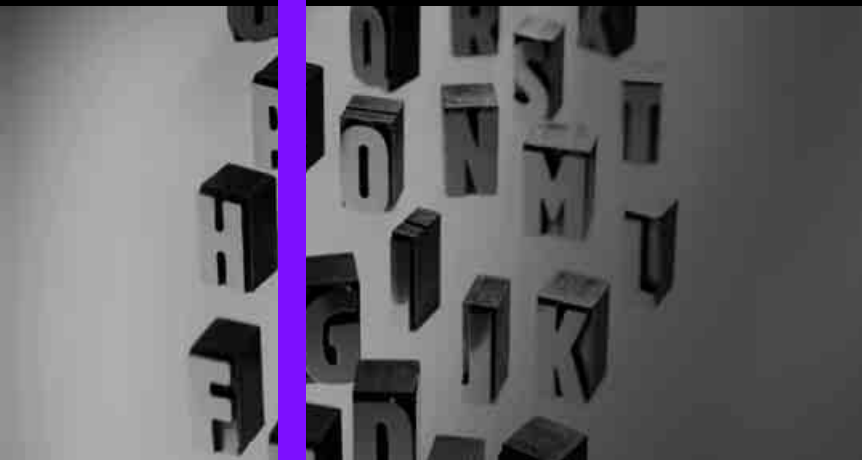



**AT A GLANCE**

**CONTROLS**

**DRIVING TIPS**

**MOBILITY**

**REFERENCE**

# TECHNICAL DATA

## ENGINE DATA

### MINI/MINI Clubman

		Cooper	Cooper S
Displacement	cu in/cm <sup>3</sup>	97.5/1,598	97.5/1,598
Number of cylinders		4	4
Maximum power output	hp	118	172
At engine speed	rpm	6,000	5,500
Maximum torque with overboost	lb ft/Nm	114/155 –	177/240 192/260
At engine speed with overboost	rpm	4,250 –	1,600-5,000 1,700-4,500
Overboost briefly raises the maximum torque at high rates of acceleration, e.g. when passing.			

# DIMENSIONS

## MINI

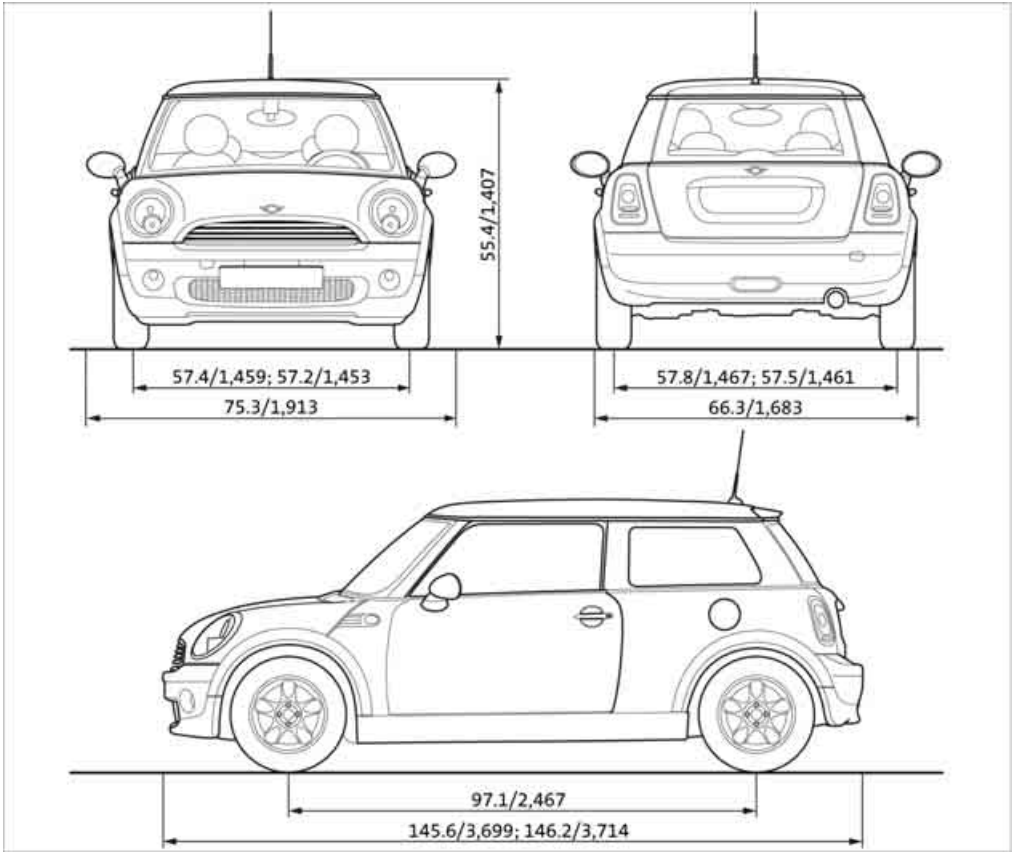

All dimensions given in inches/mm. Smallest turning circle diam.: 35 ft 2 in/10.7 m.  
Figures following the semicolons: values that differ for the MINI Cooper S.

AT A GLANCE

CONTROLS

DRIVING TIPS

MOBILITY

REFERENCE

## MINI Clubman

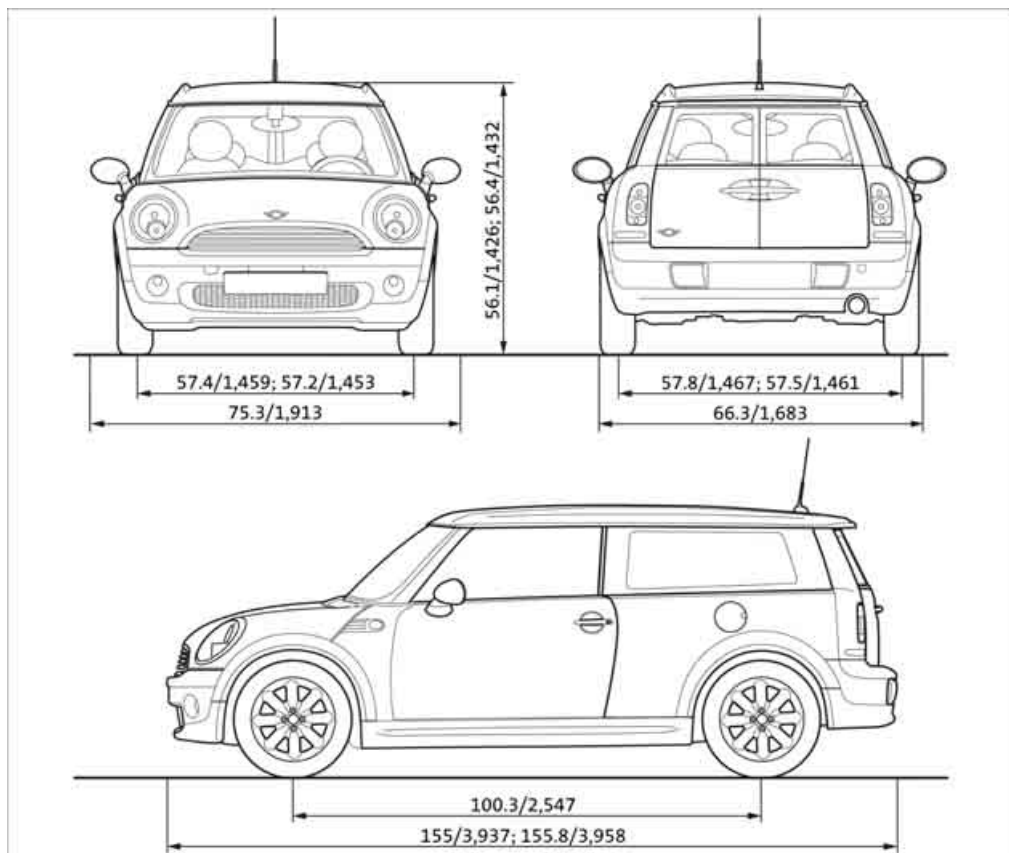

All dimensions given in inches/mm. Smallest turning circle diam.: 36 ft/11 m.  
 Figures following the semicolon: values that differ for the MINI Clubman Cooper S.

# WEIGHTS

## MINI

		MINI COOPER	MINI COOPER S
Curb weight, ready for travel, with all optional extras			
▷ Manual transmission	lbs/kg	2,546/1,155	2,668/1,210
▷ Automatic transmission	lbs/kg	2,634/1,195	2,723/1,235
Approved gross weight			
▷ Manual transmission	lbs/kg	3,362/1,525	3,483/1,580
▷ Automatic transmission	lbs/kg	3,450/1,565	3,538/1,605
Approved front axle load	lbs/kg	1,929/875	1,984/900
Approved rear axle load	lbs/kg	1,653/750	1,664/755
Approved roof load capacity	lbs/kg	165/75	165/75
Cargo bay capacity	cu ft/l	5.7/160 - 24.0/680	5.7/160 - 24.0/680

AT A GLANCE

CONTROLS

DRIVING TIPS

MOBILITY



## MINI Clubman

		MINI COOPER	MINI COOPER S
Curb weight, ready for travel, with all optional extras			
▷ Manual transmission	lbs/kg	2,723/1,235	2,855/1,295
▷ Automatic transmission	lbs/kg	2,800/1,270	2,900/1,315
Approved gross weight			
▷ Manual transmission	lbs/kg	3,539/1,605	3,671/1,665
▷ Automatic transmission	lbs/kg	3,616/1,640	3,715/1,685
Approved front axle load			
▷ Manual transmission	lbs/kg	1,830/830	1,918/870
▷ Automatic transmission	lbs/kg	1,907/865	1,962/890
Approved rear axle load	lbs/kg	1,830/830	1,841/835
Approved roof load capacity	lbs/kg	165/75	165/75
Cargo bay capacity	cu ft/l	9.2/260-32.8/930	9.2/260-32.8/930

Never exceed either the approved axle loads or the gross vehicle weight.

## CAPACITIES

### MINI/MINI Clubman

	US gal/US quarts	Liters	Notes
Fuel tank			Fuel grade: page <a href="#">95</a>
MINI Cooper, MINI Cooper S	13.2/-	approx. 50	
including reserve of	2.1/-	approx. 8	
Window washer system incl. headlamp washer system	-/4.8	approx. 4.5	For more details: page <a href="#">46</a>



## FROM A TO Z

## INDEX

## A

- Accessories, refer to Your individual vehicle [4](#)
- Activated-charcoal filter for automatic climate control [75](#)
- Additives
  - coolant [108](#)
  - engine oil [108](#)
- Adjusting temperature inside the car, refer to Air conditioner [72](#)
- Adjusting temperature inside the car, refer to Automatic climate control [73](#)
- Airbags [64](#)
  - sitting safely [30](#)
  - warning lamp [65](#)
- Air conditioner [71](#)
- Air conditioning mode
  - air conditioner [72](#)
  - automatic climate control [73](#)
  - ventilation [75](#)
- Air distribution
  - automatic [74](#)
  - individual [73](#)
  - manual [73](#)
- Air flow rate [72, 73](#)
  - air conditioning system [72](#)
  - automatic climate control [73](#)
  - heating, ventilation [72](#)
- Airing, refer to Ventilation [75](#)
- Air outlets, refer to Air vents [71](#)
- Air pressure, checking, refer to Tire inflation pressure [96](#)
- Air recirculation, refer to Recirculated-air mode [72, 74](#)
- Air supply
  - air conditioner [72](#)
  - automatic climate control [73](#)
  - ventilation [75](#)
- Air vents [71](#)
- AKI, refer to Fuel specifications [95](#)
- Alarm system [24](#)
- All-season tires, refer to Winter tires [105](#)
- All-Season Traction Control ASC [58](#)
- Ambient air, refer to Recirculated-air mode [72, 74](#)
- Ambient lighting [70](#)
- Antenna, care [112](#)
- Antifreeze
  - coolant [108](#)
  - washer fluid [46](#)
- Antilock Brake System ABS [58](#)
- Anti-theft alarm system, refer to Alarm system [24](#)
- Anti-theft system [19](#)
- Approved axle loads, refer to Weights [146, 147](#)
- Approved engine oils [108](#)
- Approved gross vehicle weight, refer to Weights [146, 147](#)
- Armrest, refer to Center armrest [78](#)
- Arrival time
  - computer [50](#)
- Ashtray [80](#)
- Assistant systems, refer to
  - All-Season Traction Control ASC [58](#)
  - Dynamic Stability Control DSC [58](#)
- AUC Automatic recirculated-air control [74](#)
- Audio device, external [78](#)
- Automatic
  - air distribution [74](#)
  - air flow rate [74](#)
  - cruise control [46](#)
  - headlamp control [66](#)
- Automatic climate control [71](#)
  - automatic air distribution [74](#)
- Automatic recirculated-air control AUC [74](#)
- Automatic transmission with Steptronic [41](#)
  - interlock [41](#)
  - overriding selector lever lock [43](#)
  - shiftlock [41](#)
  - sport program [42](#)
- AUTO program for automatic climate control [74](#)
- AUX-In, refer to External audio device [78](#)
- Average fuel consumption [49](#)
  - setting the units [51](#)
- Average speed [50](#)
- Axle loads, refer to Weights [146, 147](#)

## B

- Background lighting, refer to Ambient lighting [70](#)
- Backrests, refer to Seats [30](#)
- Backup lamps
  - replacing bulb [117](#)
  - replacing bulbs in MINI [118](#)
  - replacing bulbs in MINI Clubman [118](#)
- Band-aids, refer to First aid pouch [127](#)
- Bar, refer to Tow-starting, towing away [129](#)
- Battery [125](#)
  - charging [125](#)
  - disposal [27, 125](#)
  - jump starting [128](#)
  - temporary power failure [125](#)
- Battery renewal
  - remote control [27](#)
- Battery towed [129](#)



Belts, refer to Safety belts **33**  
Belt tensioner, refer to Safety belts **33**  
Beverage holders, refer to Cup holders **80**  
Blower, refer to Air flow rate **72, 73**  
Bonnet **106**  
Bottle holders, refer to Cup holders **80**  
Brake Assist **58**  
Brake fluid, refer to Service requirements **53**  
Brake lamps  
– replacing bulbs in MINI **118**  
– replacing bulbs in MINI Clubman **118**  
Brake pads, breaking in **84**  
Brake rotors **85**  
– brakes **84**  
– breaking in **84**  
Brakes  
– ABS **58**  
– breaking in **84**  
– MINI Maintenance System **110**  
– parking brake **40**  
– service requirements **53**  
Brakes, refer to Braking safely **85**  
Brake system **84**  
– breaking in **84**  
– disc brakes **85**  
– MINI Maintenance System **110**  
Breakdown service, refer to Roadside Assistance **127**  
Breaking in the clutch **84**  
Break-in period **84**  
Bulb changing, refer to Lamps and bulbs **115**  
Button for starting the engine **39**  
Buttons on the steering wheel **11**

## C

California Proposition 65 warning **5**  
Can holders, refer to Cup holders **80**  
Capacities **148**  
Capacity of cargo bay **146**  
Car battery, refer to Vehicle battery **125**  
Car care **112**  
Car-care products, refer to Suitable car-care products **112**  
Care **112**  
Cargo, securing **89**  
Cargo area  
– capacity **147**  
Cargo area partition net, refer to Partition net in MINI Clubman **87**  
Cargo bay **86**  
– capacity **146**  
– convenient access **26**  
– cover **86**  
– doors, refer to Splitdoor **23**  
– lamp **69**  
– lid, refer to Tailgate **23**  
– opening from outside **24**  
– volume **146**  
Cargo bay, expanding **86**  
Cargo bay doors, refer to Splitdoor **23**  
Cargo bay lamp **69**  
Cargo bay lid, refer to Tailgate **23**  
Cargo bay partition net, refer to Partition net in MINI Clubman **87**  
Cargo loading  
– securing cargo **89**  
– stowing cargo **88**  
– vehicle **86**  
Car key, refer to Keys/remote controls **18**  
Carpets, care **113**

Car phone  
– installation location, refer to Center armrest **78**  
– refer to separate Owner's Manual  
Car wash **86**  
Car wash, care **112**  
Catalytic converter, refer to Hot exhaust system **84**  
Center armrest **78**  
Center brake lamp **119**  
Center console, refer to Around the center console **14**  
Central locking system **19**  
– convenient access **26**  
– from inside **22**  
– from outside **19**  
Changing bulbs **115**  
Changing wheels **122**  
Chassis number, refer to Engine compartment **107**  
Check Control **55**  
Child's seats **36**  
Child-restraint fixing system LATCH **37**  
Child-restraint systems **36**  
Chock, folding  
– space-saver spare tire **122**  
Chrome parts, care **113**  
Chrome parts, refer to Care **112**  
Cigarette lighter **80**  
Cleaning headlamps **45**  
– washer fluid **46**  
Clock **48**  
– 12h/24h mode **51**  
– setting time **54**  
Closing  
– from inside **22**  
– from outside **19**  
Clothes hooks **79**  
Clubdoor **23**  
Cockpit **10**  
Cold start, refer to Starting the engine **39**  
Comfort access, refer to Convenient access **26**

Comfort area, refer to Around the center console [14](#)  
 Compartment for remote control, refer to Ignition lock [39](#)  
 Computer [49](#)  
 Condensation, refer to When the vehicle is parked [85](#)  
 Condition Based Service CBS [110](#)  
 Configuring settings, refer to Personal Profile [18](#)  
 Confirmation signals for vehicle locking/unlocking [20](#)  
 Connecting vacuum cleaner, refer to Connecting electrical appliances [80](#)  
 Consumption, refer to Average fuel consumption [49](#)  
 Consumption indicator  
 – average fuel consumption [49](#)  
 Control Display  
 – settings [50](#)  
 Controls and displays [10](#)  
 Convenience start, refer to Starting the engine [39](#)  
 Convenient access [26](#)  
 – replacing the battery [27](#)  
 – what to observe before entering a car wash [27](#)  
 Convenient operation  
 – windows [20](#)  
 Coolant [108](#)  
 – checking level [108](#)  
 – filling [108](#)  
 Coolant temperature [48](#)  
 Cooling, maximum [74](#)  
 Cooling fluid, refer to Coolant [108](#)  
 Copyright [2](#)  
 Cruising range [49](#)  
 Cup holders [80](#)  
 Curb weight, refer to Weights [146, 147](#)  
 Current fuel consumption [50](#)

## D

Dashboard, refer to Cockpit [10](#)

Dashboard instruments, refer to Displays [12](#)  
 Dashboard lighting, refer to Instrument lighting [69](#)  
 Data [144](#)  
 – capacities [148](#)  
 – dimensions [145](#)  
 – engine [144](#)  
 – weights [146, 147](#)  
 Date  
 – setting [55](#)  
 Daytime running lamps [67](#)  
 DBC Dynamic Brake Control, refer to Brake assist [58](#)  
 Deactivating front passenger airbags [64](#)  
 Deadlocking, refer to Locking [20](#)  
 Defect  
 – door lock [22](#)  
 – fuel filler door [94](#)  
 Defogging windows [73, 75](#)  
 Defrosting windows [73, 75](#)  
 Defrosting windows and removing condensation  
 – air conditioner [73](#)  
 – automatic climate control [75](#)  
 Defrost position, refer to Defrosting windows [73, 75](#)  
 Differential, breaking in [84](#)  
 Digital clock [48](#)  
 Dimensions [145](#)  
 Dipstick, engine oil [107](#)  
 Directional indicators, refer to Turn signals [43](#)  
 Displacement, refer to Engine data [144](#)  
 Display lighting, refer to Instrument lighting [69](#)  
 Displays [12](#)  
 – instrument combination [12](#)  
 Displays, care [113](#)  
 Displays and controls [10](#)  
 Disposal  
 – of coolant [108](#)  
 – remote control battery [27](#)  
 – vehicle battery [125](#)

Distance remaining to service, refer to Service requirements [53](#)  
 Distance warning, refer to Park Distance Control PDC [57](#)  
 Diving stability control systems [57](#)  
 Door  
 – rear, refer to Clubdoor [23](#)  
 Door key, refer to Integrated key/remote control [18](#)  
 Door lock [22](#)  
 Door lock, confirmation signals [20](#)  
 Doors, manual operation [22](#)  
 DOT Quality Grades [102](#)  
 Double doors, refer to Splitdoor [23](#)  
 Drinks holders, refer to Cup holders [80](#)  
 Drive-off assistant, refer to Hill Start Assist [59](#)  
 Driving dynamics control, refer to Sport button [59](#)  
 Driving lamps, refer to Parking lamps/low beams [66](#)  
 Driving notes [84](#)  
 Driving off on inclines, refer to Hill Start Assist [59](#)  
 Driving through water [85](#)  
 Driving tips, refer to Driving notes [84](#)  
 Dry air, refer to Cooling function [75](#)  
 Dynamic Brake Control DBC, refer to Brake assist [58](#)  
 Dynamic Stability Control DSC [58](#)

## E

Electrical malfunction  
 – door lock [22](#)  
 – fuel filler door [94](#)  
 Electronic brake-force distribution [58](#)  
 Electronic Stability Program ESP, refer to Dynamic Stability Control DSC [58](#)

Emergency operation, refer to  
Manual operation  
– door lock 22  
– fuel filler door 94  
– transmission lock, automatic transmission 43

Emergency services, refer to  
Roadside Assistance 127

Engine  
– breaking in 84  
– data 144  
– overheated, refer to Coolant temperature 48  
– speed 144  
– starting 39  
– starting, convenient access 26  
– switching off 40

Engine compartment 107

Engine coolant, refer to  
Coolant 108

Engine oil  
– adding 108  
– additives, refer to Approved engine oils 108  
– approved engine oils 108  
– capacity 108  
– checking level 107  
– dipstick 107  
– intervals between changes, refer to Service requirements 53  
– MINI Maintenance System 110

Engine oil level, checking 107

Engine output, refer to Engine data 144

Engine starting, refer to  
Starting the engine 39

Error messages, refer to Check Control 55

ESP Electronic Stability Program, refer to Dynamic Stability Control DSC 58

Event data recorders 111

Exhaust system, refer to Hot exhaust system 84

Exterior mirrors 33  
– adjusting 33  
– automatic heating 34  
– folding in and out 34

External audio device 78

Eyes  
– for tow-starting and towing away 129  
– for tying down loads 89

## F

Failure messages, refer to  
Check Control 55

Failure of an electrical consumer 125

Fastening safety belts, refer to  
Safety belts 33

Fasten safety belts reminder, refer to Seat belt reminder 33

Filter  
– microfilter/activated-charcoal filter for automatic climate control 75  
– microfilter for air conditioner 73

Fine wood, care 113

First aid pouch 127

Fixture for remote control, refer to Ignition lock 39

Flash when locking/unlocking 20

Flat tire  
– Run-Flat Tires 104  
– Tire Pressure Monitor TPM 61

Flat Tire Monitor FTM 59  
– indicating a flat tire 60  
– initializing the system 60  
– malfunction 61  
– snow chains 59  
– system limits 59

Flat tires, refer to Tire condition 103

Floor mats, care 113

Floor panel, refer to Level load floor in MINI Clubman 87

Fog lamps  
– replacing bulb 116, 118

Folding rear seat backrest 86

Footbrake, refer to Braking safely 85

Footwell lamps 69

For your own safety 4

Front airbags 64

Front fog lamps 69  
– indicator lamp 131  
– replacing bulb 116

Front seat adjustment 30

Frost on windows, refer to  
Defrosting windows 73, 75

FTM, refer to Flat Tire Monitor 59

Fuel 95  
– gauge 49  
– high-quality brands 95  
– quality 95  
– specifications 95  
– tank capacity 148

Fuel clock, refer to Fuel gauge 49

Fuel display, refer to Fuel gauge 49

Fuel filler door 94  
– releasing in the event of electrical malfunction 94

Fuses 125

## G

Garage door opener, refer to  
Integrated universal remote control 76

Gasoline  
– refer to Average consumption 49

Gasoline, refer to Required fuel 95

Gasoline display, refer to Fuel gauge 49

Gear indicator  
– automatic transmission with Steptronic 41

Gear shifting  
– automatic transmission 41  
– manual transmission 41

Gearshift lever  
 – automatic transmission with Steptronic 41  
 – manual transmission 41  
 General driving notes 84  
 Glass sunroof, electric 27  
 – convenient operation 20, 22  
 – opening, closing 28  
 – raising 28  
 – remote control 20  
 Glove compartment 77  
 Grills, refer to Air vents 71  
 Gross vehicle weight, refer to Weights 146, 147

## H

Halogen lamps  
 – replacing bulb 115  
 Handbrake, refer to Parking brake 40  
 Hands-free system 14  
 Hazard warning flashers 14  
 Head airbags 64  
 Headlamp control, automatic 66  
 Headlamp flasher 43  
 – indicator lamp 11, 131  
 Headlamps  
 – replacing bulb 115  
 Headlamps, care 112  
 Head restraints 32  
 – sitting safely 30  
 Heated  
 – mirrors 34  
 – rear window 72, 74  
 – seats 33  
 Heating 71  
 – mirrors 34  
 – rear window 72, 74  
 – seats 33  
 Heavy loads, refer to Stowing cargo 88  
 Height, refer to Dimensions 145  
 Height adjustment  
 – seats 31  
 – steering wheel 34

High beams 68  
 – headlamp flasher 68  
 – indicator lamp 131  
 – replacing bulb 115  
 High water, refer to Driving through water 85  
 Hills 85  
 Hill Start Assist 59  
 Holders for cups 80  
 Homepage 4  
 Horn 10  
 Hot exhaust system 84  
 Hydroplaning 84

## I

Ice warning 48  
 Icy roads, refer to Outside temperature warning 48  
 Ignition 39  
 – switched off 39  
 – switched on 39  
 Ignition key, refer to Integrated key/remote control 18  
 Ignition key position 1, refer to Radio readiness 39  
 Ignition key position 2, refer to Ignition on 39  
 Ignition lock 39  
 Imprint 2  
 Indicator and warning lamps 13, 131  
 – Tire Pressure Monitor TPM 62  
 Indicator lighting, refer to Instrument lighting 69  
 Individual air distribution 73  
 Individual settings, refer to Personal Profile 18  
 Inflation pressure monitoring, refer to Tire Pressure Monitor TPM 61  
 Initializing  
 – Flat Tire Monitor FTM 60  
 – glass sunroof, electric 28  
 Instrument cluster, refer to Displays 12  
 Instrument lighting 69

Instrument panel, refer to Cockpit 10  
 Instrument panel, refer to Displays 12  
 Integrated key 18  
 Integrated universal remove control 76  
 Interior lamps 69  
 – remote control 21  
 Interior rearview mirror 34  
 – automatic dimming feature 34  
 Interlock 41  
 Intermittent mode of the wipers 44  
 Internet page 4

## J

Jacking points 124  
 Jets, refer to Window washer nozzles 46  
 Jumpering, refer to Jump starting 128  
 Jump starting 128

## K

Key, refer to Keys/remote controls 18  
 Keyless go, refer to Convenient access 26  
 Keyless opening and closing, refer to Convenient access 26  
 Key Memory, refer to Personal Profile 18  
 Kick-down 42  
 – automatic transmission with Steptronic 42  
 Knock control 95

## L

Lamps, refer to Parking lamps/ Low beams 66  
 Lamps and bulbs, replacing bulbs 115

Lashing eyes, refer to Securing cargo **89**  
LATCH child-restraint fixing system **37**  
LEDs light-emitting diodes **115**  
Length, refer to  
    Dimensions **145**  
Level load floor in MINI Clubman **87**  
License plate lamp  
– replacing bulbs in MINI **119**  
– replacing bulbs in MINI Clubman **119**  
Light-alloy wheels, care **112**  
Light-emitting diodes  
    LEDs **115**  
Lighter **80**  
– socket **80**  
Lighting  
– lamps and bulbs **115**  
– of the instruments **69**  
– of vehicle, refer to Lamps **66**  
Light switch **66**  
Limit **141**  
Load securing equipment, refer to Securing cargo **89**  
Lock buttons of doors, refer to Locking **22**  
Locking  
– adjusting confirmation signal **20**  
– from inside **22**  
– from outside **20**  
– without remote control, refer to Convenient access **26**  
Locking and unlocking doors  
– confirmation signals **20**  
– from inside **22**  
– from outside **19**  
Low beams **66**  
– automatic **66**  
– replacing bulb **115**  
Lower back support, refer to Lumbar support **31**  
Luggage compartment, refer to Cargo bay **23**  
Luggage compartment doors, refer to Splitdoor **23**

Luggage compartment lid, refer to Tailgate **23**  
Luggage rack, refer to Roof-mounted luggage rack **89**  
Lumbar support **31**

## M

M+S tires, refer to Winter tires **105**  
Maintenance, refer to Service Booklet  
Maintenance system **110**  
Malfunction warnings, refer to Check Control **55**  
Manual air distribution **73**  
Manual mode  
– automatic transmission with Steptronic **42**  
Manual operation  
– door lock **22**  
– fuel filler door **94**  
– transmission lock, automatic transmission **43**  
Manual transmission **41**  
Master key, refer to Integrated key/remote control **18**  
Maximum cooling **74**  
Maximum speed  
– with winter tires **105**  
Medical assistance, refer to First aid pouch **127**  
Microfilter  
– for air conditioner **73**  
– for automatic climate control **75**  
– MINI Maintenance System **110**  
Microfilter/activated-charcoal filter  
– MINI Maintenance System **110**  
Microphone for telephone **14**  
MINI Internet page **4**  
MINI Maintenance System **110**  
Mirror dimming feature **34**

Mirrors **33**  
– exterior mirrors **33**  
– heating **34**  
– interior rearview mirror **34**  
Mobile phone  
– installation location, refer to Center armrest **78**  
– refer to separate Owner's Manual  
Mobile phone, installation location, refer to Center armrest **78**  
Mobile phone, refer to the separate Owner's Manual  
Mobility System **120**  
Modifications, technical, refer to For your own safety **4**  
Monitoring system for tire pressures, refer to Flat Tire Monitor **59**  
Multifunctional steering wheel, refer to Buttons on the steering wheel **11**  
Multifunction switch  
– refer to Turn signals/headlamp flasher **43**  
– refer to Wiper system **44**

## N

Neck support, refer to Head restraints **32**  
Nets, refer to Storage compartments **79**  
New tires **104**  
Number of cylinders, refer to Engine data **144**  
Nylon rope, refer to Tow rope **130**

## O

OBD socket, refer to Socket for Onboard Diagnosis **110**  
Octane ratings, refer to Fuel specifications **95**  
Odometer **48**  
Oil, refer to Engine oil **107**  
Oil consumption **107**

Oil level [107](#)  
 Old batteries, refer to Disposal [125](#)  
 Onboard tool kit [114](#)  
 Opening and closing  
 – convenient access [26](#)  
 – from inside [22](#)  
 – from outside [19](#)  
 – using the door lock [22](#)  
 – via the remote control [19](#)  
 Opening and unlocking  
 – from inside [22](#)  
 Outlets  
 – refer to Ventilation [75](#)  
 Outlets, refer to Air vents [71](#)  
 Output, refer to Engine data [144](#)  
 Outside-air mode  
 – automatic climate control [74](#)  
 Outside temperature display [48](#)  
 – changing unit of measure [51](#)  
 – on onboard computer [51](#)  
 Overheated engine, refer to Coolant temperature [48](#)

## P

Paintwork, care [112](#)  
 Park Distance Control PDC [57](#)  
 Parking  
 – vehicle [40](#)  
 Parking aid, refer to Park Distance Control PDC [57](#)  
 Parking brake [40](#)  
 Parking lamps, replacing bulb [116](#)  
 Parking lamps/low beams [66](#)  
 Partition net in MINI Clubman [87](#)  
 Parts and accessories, refer to Your individual vehicle [4](#)  
 Pathway lighting [66](#)  
 Personal Profile [18](#)  
 Pinch protection system  
 – windows [29](#)  
 Plastic parts, care [113](#)

Pollen  
 – refer to Microfilter/activated-charcoal filter for automatic climate control [75](#)  
 – refer to Microfilter for air conditioner [73](#)  
 Power failure [125](#)  
 Power windows [28](#)  
 Power windows, refer to Windows [28](#)  
 Pressure, tires [96](#)  
 Pressure monitoring, tires [59](#)  
 – Flat Tire Monitor [59](#)  
 Pressure monitoring of tires, refer to Tire Pressure Monitor TPM [61](#)  
 Protective function, refer to Pinch protection system  
 – windows [29](#)  
 Puncture  
 – Flat Tire Monitor [59](#)

## R

Radio key, refer to Integrated key/remote control [18](#)  
 Radio position, refer to Radio readiness [39](#)  
 Radio readiness [39](#)  
 – switched off [39](#)  
 – switched on [39](#)  
 Rain sensor [44](#)  
 Range, refer to Cruising range [49](#)  
 Reading lamps [70](#)  
 Rear door, refer to Clubdoor [23](#)  
 Rear doors, refer to Splitdoor [23](#)  
 Rear double doors, refer to Splitdoor [23](#)  
 Rear fog lamp [69](#)  
 – indicator lamp [131](#)  
 – replacing bulb [118](#)  
 Rear lamps, refer to Tail lamps [117](#)  
 Rear seat backrest, folding [86](#)  
 Rear seats  
 – folding the backrests [86](#)  
 Rearview mirror, refer to Mirrors [33](#)  
 Rear window heating [72, 74](#)  
 Recirculated-air mode [72, 74](#)  
 Recirculation of air, refer to Recirculated-air mode [72, 74](#)  
 Reclining seat, refer to Backrest [31](#)  
 Refueling [94](#)  
 Releasing  
 – bonnet [106](#)  
 Remote control [18](#)  
 – battery renewal [27](#)  
 – convenient access [26](#)  
 – garage door opener [86](#)  
 – malfunctions [21, 27](#)  
 – service data [110](#)  
 – tailgate [21](#)  
 Replacement remote control [18](#)  
 Replacing bulbs, refer to Lamps and bulbs [115](#)  
 Replacing tires, refer to New wheels and tires [104](#)  
 Reporting safety defects [6](#)  
 Reserve warning, refer to Fuel gauge [49](#)  
 Reservoir for washer systems [46](#)  
 Restraint systems  
 – for children [36](#)  
 – refer to Safety belts [33](#)  
 Reverse gear  
 – automatic transmission with Steptronic [42](#)  
 – manual transmission [41](#)  
 Roadside Assistance [127](#)  
 Roadside parking lamps [68](#)  
 – replacing bulb [116](#)  
 Roadworthiness test, refer to Service requirements [53](#)  
 Roof load capacity [146, 147](#)  
 Roof-mounted luggage rack [89](#)  
 Rope, refer to Tow-starting, towing away [130](#)

RSC Runflat System  
Component, refer to Run-Flat Tires 104  
Rubber parts, care 113  
Runflat System Component  
RSC, refer to Run-Flat Tires 104  
Run-Flat Tires 104  
– flat tire 60  
– new tires 104  
– tire inflation pressure 96  
– winter tires 105  
Runflat Tyres, refer to Run-Flat Tires 104

## S

Safety belts 33  
– damage 33  
– indicator lamp 33  
– reminder 33  
– sitting safely 30  
Safety belts, care 113  
Safety systems  
– airbags 64  
– All-Season Traction Control ASC 58  
– Antilock Brake System ABS 58  
– Dynamic Stability Control DSC 58  
– safety belts 33  
Safety tires, refer to Run-Flat Tires 104  
Screw thread for tow fitting 129  
Seat adjustment  
– mechanical 31  
Seats 30  
– adjusting the seats 31  
– heating 33  
– sitting safely 30  
Securing the vehicle  
– from inside 22  
– from outside 19  
Selector lever  
– automatic transmission with Steptronic 41

Selector lever lock  
– automatic transmission with Steptronic, refer to Shiftlock 41  
– overriding manually 43  
Selector lever positions  
– automatic transmission with Steptronic 41  
Service, refer to Roadside Assistance 127  
Service car, refer to Roadside Assistance 127  
Service data in the remote control 110  
Service Interval Display, refer to Condition Based Service CBS 110  
Service requirement display, refer to Condition Based Service CBS 110  
Service requirements 53  
Settings  
– clock, 12h/24h mode 51  
Shifting gears  
– automatic transmission with Steptronic 42  
– manual transmission 41  
Shiftlock  
– automatic transmission, refer to Changing selector lever positions 41  
Side airbags 64  
Side door, rear, refer to Clubdoor 23  
Side turn signal indicator  
– replacing bulb 117  
Side windows, refer to Windows 28  
Signal horn, refer to Horn 10  
Sitting safely 30  
– airbags 30  
– safety belts 30  
– with head restraint 30  
Size, refer to Dimensions 145  
Sliding/tilt sunroof  
– refer to Glass sunroof, electric 27  
Slot for remote control 39

Smokers' package, refer to Ashtray 80  
Snap-in adapter, refer to Center armrest storage compartment 78  
Snow chains 105  
Socket, refer to Connecting electrical appliances 80  
Socket for Onboard Diagnosis OBD 110  
Space-saver spare tire  
– changing tires 122  
– inflation pressure 96  
Spare wheel, refer to Space-saver spare tire 122  
Special oils, refer to Approved engine oils 108  
Speed 144  
– with winter tires 105  
Speed control, refer to Cruise control 46  
Speedometer 12  
Splitdoor 23  
Split rear seat backrest, refer to Expanding the cargo bay 86  
Sport button 59  
Stability control, refer to Driving stability control systems 57  
Start/stop button 39  
– starting the engine 39  
– switching off the engine 40  
Starting, refer to Starting the engine 39  
Starting assistance, refer to Jump starting 128  
Starting the engine  
– start/stop button 39  
Start-off assistance, refer to  
– ASC 58  
– DSC 58  
– Hill Start Assist 59  
Status of this Owner's Manual at time of printing 4  
Steering wheel 34  
– adjustment 34  
– buttons on steering wheel 11  
– lock 39  
– shift paddles 42

Steptronic, refer to Automatic transmission with Steptronic **41**

Storage area  
– cargo bay **86**

Storage compartment, front passenger side **79**

Storage compartments **79**

Storage space  
– storage compartments **79**

Storing the vehicle **113**

Storing tires **105**

Stowage, refer to Storage compartments **79**

Summer tires, refer to Wheels and tires **96**

Switches, refer to Cockpit **10**

Switching off  
– engine **40**

Switching off the engine  
– start/stop button **39**

Switching the cooling function on and off **75**

Symbols **4**

## T

Tachometer **48**

Tailgate **23**  
– convenient access **26**  
– opening/closing **24**  
– opening from outside **24**  
– unlocking with remote control **21**

Tail lamp, refer to Tail lamps **117**  
– replacing bulb **117**

Tail lamps **117**  
– replacing bulbs in MINI **118**  
– replacing bulbs in MINI Clubman **118**

Tank volume, refer to Capacities **148**

Technical data **144**

Technical modifications **4**

Telephone  
– installation location, refer to Center armrest **78**  
– refer to separate Owner's Manual

Telephone call, refer to the Owner's Manual for the telephone

Temperature display  
– ice warning **48**  
– outside temperature **48**  
– setting the units **51**

Temperature of coolant, refer to Coolant temperature **48**

Temperature setting  
– air conditioner **72**  
– automatic climate control **74**

Tensioning straps, refer to Securing cargo **89**

The individual vehicle **4**

Third brake lamp, refer to Center brake lamp **119**

Three-point safety belt **33**

Tightening the lug bolts  
– keys **122, 123**  
– torque **125**

Tightening torque, refer to Tightening the lug bolts **125**

Tire change set  
– MINI Mobility System **122**  
– space-saver spare tire **122, 123**

Tire failure  
– Flat Tire Monitor **60**  
– indicator/warning lamp **60**  
– MINI Mobility System **120**  
– Run-Flat Tires **60**  
– space-saver spare tire **122**  
– Tire Pressure Monitor **61**

Tire inflation pressure **96**  
– loss **60**  
– space-saver spare tire **96**

Tire pressure monitoring, refer to Flat Tire Monitor **59**

Tire Pressure Monitor TPM **61**  
– limitations of system **61**  
– resetting system **61**  
– warning lamp **62**

Tire Quality Grading **102**

Tires  
– age **103**  
– breaking in **84**  
– changing, refer to Changing wheels **122**  
– condition **103**  
– damage **103**  
– inflation pressure **96**  
– inflation pressure loss **62**  
– minimum tread depth **103**  
– new tires **104**  
– pressure monitoring, refer to Flat Tire Monitor **59**  
– pressure monitoring, refer to Tire Pressure Monitor TPM **61**  
– puncture **60**  
– Run-Flat Tires **104**  
– size **102**  
– wear indicators, refer to Minimum tread depth **103**  
– winter tires **105**

Tires with safety features, refer to Run-Flat Tires **104**

Tools, refer to Onboard tool kit **114**

Torque **144**  
– lug bolts **125**

Tow bar **129**

Tow fitting **129**  
– screw thread **129**

Tow fittings for tow-starting and towing away **129**

Towing **129**  
– car with automatic transmission **129**  
– methods **129**

Tow rope **130**

Tow-starting **129**

TPM, refer to Tire Pressure Monitor **61**

Track width, refer to Dimensions **145**

Traction control, refer to  
– Dynamic Stability Control DSC **58**



Transmission  
– automatic transmission with Steptronic 41  
– manual transmission 41  
– overriding selector lever lock for automatic transmission with Steptronic 43  
Transporting children safely 36  
Transport securing devices, refer to Securing cargo 89  
Tread depth, refer to Minimum tire tread 103  
Trip-distance counter, refer to Trip odometer 48  
Triple turn signal activation 43  
Trip odometer 48  
Turning circle, refer to Dimensions 145  
Turn signal indicator 43  
– front, replacing bulb 116  
– indicator lamp 12  
– rear, replacing bulb 117  
– side, replacing bulb 117  
Tying down loads, refer to Cargo loading 89

## U

Uniform Tire Quality Grading UTQR 102  
Units  
– average fuel consumption 51  
– temperature 51  
Universal garage door opener, refer to Integrated universal remote control 76  
Universal remove control 76  
Unlatching, refer to Unlocking 26  
Unlocking  
– from inside 22  
– from outside 19  
– tailgate 26  
– without remote control, refer to Convenient access 26  
Upholstery, care 112

## V

Valve  
– dust cap 123  
Vehicle  
– battery 125  
– breaking in 84  
– cargo loading 86  
– dimensions 145  
– Identification Number, refer to Engine compartment 107  
– parking 40  
– storage 113  
– weight 146, 147  
Vehicle jack 122, 123  
– jacking points 124  
Ventilation  
– air conditioner 75  
Vents, refer to Air vents 71  
Vents, refer to Ventilation 75  
Volume of cargo area 147

## W

Warning and indicator lamps 13, 131  
Warning messages, refer to Check Control 55  
Warning triangle 127  
Washer fluid 46  
– capacity of reservoir 46  
Washer fluid reservoir 46  
Waste tray, refer to Ashtray 80  
Waterfall lighting, refer to Ambient lighting 70  
Water on roads, refer to Driving through water 85  
Wear indicators in tires, refer to Minimum tread depth 103  
Weights 146, 147  
Welcome lamps 66  
Wheelbase, refer to Dimensions 145  
Wheels, new 104  
Wheels and tires 96  
Wheelslip control, refer to  
– All-Season Traction Control ASC 58  
Wheel stud wrench  
– space-saver spare tire 122, 123  
Width, refer to Dimensions 145  
Windows 28  
– closing 28  
– convenient operation 20  
– opening 28  
– pinch protection system 29  
Window washer, refer to Washer fluid 46  
Window washer reservoir, refer to Washer fluid  
– volume, refer to Capacities 148  
Windshield  
– cleaning 45  
– defrosting and removing condensation 73, 75  
Windshield, defrosting, refer to Defrosting windows 73, 75  
Windshield washer system 44  
– washer fluid 46  
– washer nozzles 46  
Windshield wiper blades, changing 114  
Windshield wipers, refer to Wiper system 44  
Winter tires 105  
– storage 105  
Wiper blade replacement 114  
Wiper blades, care 113  
Wiper system 44  
Work in the engine compartment 106  
Wrench/screwdriver, refer to Onboard tool kit 114

## X

Xenon lamps  
– replacing bulb 115







01 41 0 01 4 701 ue Basis

**DRIVE ME.**