



G-Class

Owner's Manual



Mercedes-Benz

Nur für internen Gebrauch / For internal use only

Symbols

In this manual, you will find the following symbols:

WARNING

Warning notices draw your attention to hazards that may endanger your health or life, or the health or life of others.

Environmental note

Environmental notes provide you with information on environmentally aware actions or disposal.

 Notes on material damage alert you to dangers that could lead to damage to your vehicle.

 These symbols indicate useful instructions or further information that could be helpful to you.

▶ This symbol designates an instruction you must follow.

▶ Several consecutive symbols indicate an instruction with several steps.

(▷ page) This symbol tells you where you can find further information on a topic.

▷▷ This symbol indicates a warning or an instruction that is continued on the next page.

Display This text indicates a message on the display.

Welcome to the world of Mercedes-Benz

Before you first drive off, read this Owner's Manual carefully and familiarise yourself with your vehicle. For your own safety and a longer vehicle life, follow the instructions and warning notices in this manual. Disregarding them may lead to damage to the vehicle or personal injury.

The equipment or model designation of your vehicle may vary according to:

- model
- order
- country variant
- availability

The illustrations in this manual show a left-hand-drive vehicle. On right-hand-drive vehicles, the layout of components and controls differs accordingly.

Mercedes-Benz is constantly updating its vehicles to the state of the art.

Mercedes-Benz therefore reserves the right to introduce changes in the following areas:

- design
- equipment
- technical features

The equipment in your vehicle may therefore differ from that shown in the descriptions and illustrations.

The following are integral components of the vehicle:

- Owner's Manual
- Service Booklet
- Equipment-dependent supplements

Keep printed copies of the documents in the vehicle at all times. If you sell the vehicle, always pass the documents on to the new owner.

The technical documentation team at Daimler AG wishes you safe and pleasant motoring.

Index	4	At a glance	17
Introduction	13	Safety	23
		Opening and closing	37
		Seats, steering wheel and mirrors	49
		Lights and windscreen wipers	57
		Climate control	77
		Driving and parking	85
		Display and display messages	117
		Stowing and features	127
		Maintenance and care	139
		Breakdown assistance	153
		Wheels and tyres	173
		Technical data	187

A	
ABS (Anti-lock Braking System)	
Function/notes	35
Important safety notes	35
Warning lamp	121
Activating/deactivating air-recirculation mode	81
Additives (engine oil)	194
Adjusting the seat	51
ADR (working speed governor)	95
Airbags	
Front airbag (driver, front passenger)	27
Important safety guidelines	26
Triggering	25
Air-conditioning system	
see Heating and air-conditioning system	
Air filter	
Cleaning valves	144
Warning lamp	124
Air vents	
Important safety notes	83
Setting	83
Setting the centre air vents	83
Setting the side air vents	83
All-wheel drive	
Transfer case	110
Anti-lock braking system	
see ABS (Anti-lock Braking System)	
Approach/departure angle	109
Aquaplaning	103
Assembly tool	
General notes	138
Radio aerial	138
ASSYST service interval display	
Resetting a service message	146
Service messages	146
Automatic car wash	147
Automatic transmission	
Driving tips	93
Emergency running mode	95
Important safety notes	91
Kickdown	93
Overview	91
Problem (fault)	95
Pulling away	88
Releasing the parking lock manually	95
Selector lever	91
Shift ranges	93
Trailer towing	93
Automatic transmission emergency running mode	95
Auxiliary heating	
Activating/deactivating	82
Important safety notes	82
Axle load, permissible (trailer towing)	201
B	
BAS (Brake Assist System)	36
Battery	
Warning lamp (control panel)	163
Warning lamp (instrument cluster)	123
Battery (vehicle)	
Charging	161
Important safety notes	160
Jump starting	163
Overview	160
Battery isolating switch	87
Blackout lighting	
Switching on/off	59
Bodystyling bar	138
Bonnet	
Closing	141
Important safety notes	140
Opening	140
Opening completely	141
Brake fluid	
Notes	195
Brakes	
ABS	35
BAS	36
Brake fluid (notes)	195
Driving tips	102
Important safety notes	102
Parking brake	101
Warning lamp	120
Breakdown	
see Flat tyre	
see Towing away	
Bulb	
Convoy lighting	72

Bulbs

Additional turn signal lamp	68
Blackout brake lamps	71
Blackout lighting	67
Blackout tail lamp	69
Brake lamp	69
Dipped-beam headlamps	65
Foglamps	66
Licence plate lamp	72
Main-beam headlamps	65
Rear foglamp	70
Replacing	65
Reversing lamp	70
Side lamp	66
Tail lamp	69
see Changing bulbs	

C**Care**

Automatic car wash	147
Display	150
Headlamps	150
High-pressure cleaner	148
Interior	150
Matt paintwork	149
Notes	147
Paint	148
Plastic trim	150
Seat belt	151
Seat covers	151
Trailer coupling	150
Wheels	148
Windows	149
Wiper blades	149

Centre console

Lower section	22
Overview	21

Changing a bulb

Rear (chassis cab with 12 V electrical system)	73
--	----

Changing bulbs

Important safety notes	63
Overview of bulb types	64
Reversing lamps	70
Turn signals (front)	67

Changing gears 92**Checklist**

After driving off-road	107
Before driving off-road	107

Child-proof lock

Rear door	34
-----------------	----

Child-proof locks

Rear doors	34
------------------	----

Children

In the vehicle	29
Restraint systems	29

Child seat

ISOFIX	31
On the front-passenger seat	30
Recommendations	34
Suitable positions	33
Top Tether	31

Chock

see Wheel chock	
-----------------	--

Climate control

Setting the air vents	83
-----------------------------	----

Cockpit

Overview	18
----------------	----

Combination switch 60**Coolant (engine)**

Checking the level	143
Notes	195
Temperature gauge	118

Coupling jaw 166**D****Daytime driving lights**

Switching on/off (switch)	59
---------------------------------	----

Diagnostics connection 14**Diesel** 192**Diesel particle filter** 101**Differential lock**

Disengaging	113
Front axle	113
Rear axle	113
Transfer case	112
see Differential lock	

Differential locks

Engaging	112
General notes	111
Terrain	111

Dipped-beam headlamp

Switching on/off	59
------------------------	----

- Dipped-beam headlamps**
 - Changing bulbs 65
 - Setting for driving abroad (symmetrical) 58
 - Display (cleaning instructions)** 150
 - Display message**
 - ASSYST service interval display 145
 - Door**
 - Opening (from the inside) 39
 - Doors**
 - Overview 39
 - Driving abroad**
 - Symmetrical dipped beam 58
 - Driving in mountainous terrain**
 - Approach/departure angle 109
 - Driving downhill 109
 - Gradient-climbing capability (maximum) 109
 - Driving off-road**
 - see Off-road driving
 - Driving on flooded roads** 103
 - Driving safety system**
 - Electronic Brake-force Distribution .. 36
 - Important safety guidelines 35
 - Driving safety systems**
 - ABS (Anti-lock Braking System) 35
 - BAS (Brake Assist System) 36
 - Overview 35
 - Driving tips**
 - Aquaplaning 103
 - Automatic transmission 93
 - Brakes 102
 - Downhill gradient 102
 - Driving abroad 58
 - Driving in winter 105
 - Driving on flooded roads 103
 - Driving on sand 108
 - Driving over obstacles 108
 - Gravel roads 108
 - Icy road surfaces 105
 - Off-road driving 106
 - Off-road fording 104
 - Snow chains 176
 - Symmetrical dipped beam 58
 - Towing a trailer 113
 - Travelling uphill 109
 - Tyre grip 103
 - Tyre ruts 108
 - Wet road surface 102
- E**
- EBD (electronic brake force distribution)**
 - Function/notes 36
 - Emergency start facility** 163
 - Engine**
 - Engine number 191
 - Jump-starting 163
 - Running irregularly 90
 - Starting problems 90
 - Starting the engine with the key 88
 - Stopping 101
 - Warning lamp (engine diagnostics) 122
 - Engine electronics**
 - Notes 189
 - Problem (fault) 90
 - Engine oil**
 - Additives 194
 - Checking the oil level 142
 - Checking the oil level (on-board computer) 142
 - Filling capacity 194
 - Notes about oil grades 194
 - Topping up 143
 - Viscosity 194
 - Environmental protection**
 - Note 13
 - Returning an end-of-life vehicle 13
- F**
- Filler cap**
 - see Fuel filler flap
 - Fire extinguisher** 154
 - First-aid kit** 154
 - Fitting a wheel**
 - Removing a wheel 181
 - Fitting wheels**
 - Fitting a wheel 181
 - Raising the vehicle 179
 - Securing the vehicle against rolling away 179
 - Flat tyre**
 - Preparing the vehicle 159

Floormat	138
Foglamps	
Switching on/off	60
Folding seat	53
Frequencies	
Mobile phone	189
Two-way radio	189
Fuel	
Important safety notes	192
Notes about consumption	193
Premium-grade unleaded petrol	192
Problem (malfunction)	100
Quality (diesel)	192
Refuelling	96
Tank content/reserve fuel	192
Fuel/water separator	
Service	146
Warning lamp	124
Fuel filler flap	
Opening/closing	98
Fuel reserve	
see Fuel	
Fuel tank	
Capacity	192
Problem (malfunction)	100
Fuse allocation chart	170
Fuse box	
Front-passenger footwell	170
Fuse extractor	170
Fuses	
Allocation chart	170
Before changing	170
Fuse allocation chart	170
Fuse box in the front-passenger footwell	170
Important safety notes	169
Main fuse box	170

G

Genuine Mercedes-Benz parts	188
Glove compartment	130
Gradient-climbing capability (maximum)	109

H

Hazard warning lamps	61
Headlamp	
Cleaning system (function)	61
Cleaning system (notes)	196
Headlamp range	
Controlling	61
Headlamps	
Cleaning	150
Misting up	62
Topping up the cleaning system	144
Head restraints	
Adjusting	52
Removing/fitting	53
Heating and air-conditioning system	
Activating/deactivating air-recirculation mode	81
Activating/deactivating heating system	79
Adjusting air outlets	83
Cooling with air dehumidification	80
Demisting the windows	81
Demisting the windscreen	81
Important safety notes	78
Increasing/reducing temperature	80
Overview	79
Problems with the cooling with air dehumidification function	80
Setting the airflow	80
Switching rear window heating on/off	81
High-pressure cleaners	148

I

Immobiliser	36
Increasing/reducing temperature (heating and air-conditioning system)	80
Indicator and warning lamps	
Overview	20
Instrument cluster	
Overview	19
Instrument cluster lighting	119
Instrument panel	
Instrument panel display	119

- Interior lighting** 62
 Automatic control system 62
 Manual control 62
 Overview 62
 Reading lamp 62
- ISOFIX child seat securing system** 31
- J**
- Jack**
 Pump lever 180
 Storage location 155
 Using 179
- Jump-starting**
 Jump leads 163
 Using a jump-starting socket 165
- Jump starting (engine)** 163
- Jump-starting socket** 165
- K**
- Key**
 Loss 39
 Malfunction 39
 Overview 38
 Problem (malfunction) 39
 Starting the engine 88
 Unlocking/locking vehicle 38
- Key positions**
 Key 87
- L**
- Lashing eyelets** 134
- Lights**
 Blackout lighting 59
 Convoy marking 72
 Dipped-beam headlamps 59
 Driving abroad 58
 Foglamps 60
 Hazard warning lamps 61
 Headlamp flasher 60
 Headlamp range 61
 Light switch 58
 Main-beam headlamps 60
 Rear foglamp 60
 Side lamps 59
 Slider lock 59
- Switching the daytime driving
 lights on/off (switch) 59
 Turn signals 60
 see Changing bulbs
 see Interior lighting
- Loading guidelines** 128
- Locking**
 From the inside (central locking
 button) 39
- Luggage compartment enlarge-
 ment**
 Important safety notes 130
- M**
- M+S tyres** 176
- Main-beam headlamps**
 Switching on/off 60
- Main fuse box** 170
- Matt finish (cleaning instructions)** . . 149
- Mercedes-Benz Service Centre**
 see Qualified specialist workshop
- Mirrors**
 see Exterior mirrors
- Mobile phone**
 Frequencies 189
 Installation 189
 Transmission output (maximum) 189
- N**
- Notes on running in a new vehicle** 86
- O**
- Occupant safety**
 Children in the vehicle 29
 Important safety notes 24
- Odometer** 119
- Off-road driving**
 Checklist 107
 Driving on sand 108
 Important safety notes 106
 Travelling uphill 109
- Off-road fording** 104
- Oil**
 see Engine oil
- Oil level (warning lamp)** 124

- Operating safety**
Diagnostics connection 14
- Outside temperature display** 118
- P**
- Paint code** 191
- Paintwork (cleaning instructions)** ... 148
- Parking** 100
Important safety notes 100
- Parking brake**
Operating 101
Warning lamp 122
see Parking brake
- Parking lock**
Releasing manually 95
- Petrol** 192
- Plastic trim (cleaning instructions)** . 150
- Platform dropside**
Important safety notes 44
Opening/closing 45
Removing/fitting 45
- Power supply (trailer)** 116
- Preheater block** 97
- Pulling away**
Automatic transmission 88
- Q**
- Qualified specialist workshop** 15
- R**
- Radiator cover** 142
- Radio aerial**
Assembly tool 138
Removing 138
Removing the radio aerial 138
Securing 138
Securing the radio aerial 138
- Rear bench seat**
Folding forward 131
- Rear door**
Opening/closing 40
- Rear foglamp**
Switching on/off 60
- Rear lamps**
see Lights
- Rear seat bench**
Folding into an upright position 132
- Rear-view mirror** 55
- Rear window heating** 81
- Rear window wiper**
Switching on/off 74
- Refuelling**
Important safety notes 96
Refuelling process 98
see Fuel
- Reserve (fuel tank)**
see Fuel
- Reserve fuel**
Warning lamp 122
- Restraint system**
see SRS (Supplemental Restraint System)
- Rev counter** 118
- Reversing lamp**
Changing bulbs 70
- S**
- Safety**
Children in the vehicle 29
Child restraint systems 29
- Safety system**
see Driving safety systems
- Seat**
Side-facing bench seat in the luggage compartment 54
- Seat backrest**
Folding back 131
- Seat belt**
Cleaning 151
Fastening 29
Important safety guidelines 27
Releasing 29
- Seat heating**
Malfunction indicator lamp 54
- Seats**
Adjusting the head restraint 52
Cleaning the cover 151
Correct driver's seat position 50
Folding the folding seat forward 53
Important safety notes 50
Overview 50
Switching seat heating on/off 53

- Securing a load** 133
- Service products**
- Brake fluid 195
 - Coolant (engine) 195
 - Engine oil 194
 - Fuel 191
 - Important safety notes 191
 - Notes 191
 - Washer fluid 196
- Setting the airflow** 80
- Shift ranges** 93
- Short journeys (diesel particle filter)** 101
- Side windows**
- Important safety notes 46
 - Opening/closing 46
- Ski rack** 136
- Slider lock** 59
- Sliding windows** 47
- Snow chains** 176
- Sockets**
- 12V socket 136
 - 24V port 137
 - 24V socket 136
- Spare fuses** 170
- Spare wheel**
- Fitting 178
 - Notes/data 184
 - Spare wheel bracket at the rear 157
 - Spare wheel carrier under the vehicle 158
- Spare wheel bracket**
- Swinging to the side 42
- Specialist workshop** 15
- Split rear door** 42
- SRS (Supplemental Restraint System)**
- Introduction 24
 - Warning lamp 122
 - Warning lamp (function) 25
- Starting the engine**
- Important safety notes 88
- Stowage areas** 129
- Stowage compartment**
- Door stowage compartment 130
 - Map pockets 130
- Stowage compartment (platform truck)** 135
- Stowage compartments**
- Glove compartment 130
 - Important safety information 129
- Summer tyres** 176
- Sun visor** 136
- Supplemental Restraint System**
- see SRS (Supplemental Restraint System)

T

- Tail lamps**
- see Lights
 - see Rear lamps
- Technical data**
- Capacities 191
 - Chassis-cab 197, 198
 - Information 188
 - Long-wheelbase panel van 196
 - Long-wheelbase station wagon 197
 - Trailer loads 201
 - Tyre pressures 184
 - Tyres 182
 - Tyres/wheels 182
 - Wheels 182
- Temperature**
- Coolant 118
 - Outside temperature 118
- Theft-deterrent system**
- Immobiliser 36
- Top Tether** 31
- Towing**
- Important safety notes 166
 - In the event of malfunctions 169
- Towing a trailer**
- Axle load, permissible 201
 - Trailer tow hitch 198
- Towing away**
- With both axles on the ground 167
- Towing coupling** 166
- Towing eye**
- Front 167
 - Rear 167
- Tow-starting**
- Important safety notes 166

- Trailer**
- 7-pin connector 116
 - Coupling up 115
 - Power supply 116
- Trailer coupling (cleaning instructions)** 150
- Trailer loads**
- Technical data 201
- Trailer tow hitch** 115
- Trailer towing**
- Driving tips 113
 - Mounting dimensions 198
 - Shift range 93
 - Trailer loads 201
- Transfer case**
- General notes 110
 - Indicator lamp 125
 - Shifting 110
 - Shifting (general notes) 110
 - Shifting (important safety notes) ... 110
 - Shifting to neutral 111
 - Shift range 110
 - Switching off the off-road gear ratio 111
 - Switching on the off-road gear ratio 111
- Transmission**
- see Automatic transmission
- Transmission position display** 92
- Transmission positions** 92
- Transport (vehicle)** 167
- Travelling uphill**
- Brow of hill 109
- Trip meter**
- Resetting 119
- Turn signals**
- Changing bulbs (front) 67
 - Switching on/off 60
- Two-way radio**
- Frequencies 189
 - Installation 189
 - Transmission output (maximum) ... 189
- Type identification plate**
- see Vehicle identification plate
- Tyre pressure**
- Recommended 177
 - Table (single tyres) 178
- Tyres**
- Changing a wheel 178
 - Checking 175
 - Direction of rotation 179
 - Grip 103
 - Important safety notes 174
 - Replacing 178
 - Service life 175
 - Storing 179
 - Technical data 182
 - Tyre size (data) 182
 - Tyre tread 175
 - see Flat tyre
- U**
- Underride guard (collapsible)** 158
- Unlocking**
- From inside the vehicle (central unlocking button) 39
- V**
- Vehicle**
- Correct use 15
 - Data acquisition 15
 - Electronics 189
 - Equipment 13
 - Implied warranty 15
 - Leaving parked up 101
 - Lowering 182
 - Pulling away 88
 - Raising 179
 - Registration 15
 - Securing from rolling away 179
 - Towing away 166
 - Tow-starting 166
 - Transporting 167
- Vehicle data**
- see Technical data
- Vehicle identification number**
- see VIN
- Vehicle identification plate** 191
- Vehicle tool kit** 155
- VIN** 191

W	
Walk-on bonnet	137
Warning and indicator lamps	
ABS	120
Air filter	124
Battery	123
Brakes	120
Brake wear	120
Coolant level	123
Engine diagnostics	122
Oil Level	124
Parking brake	122
Preglow	122
Reserve fuel	122
Reserve fuel (yellow)	122
SRS	122
Transfer case	125
Washer fluid	125
Water separator	124
Warning triangle	154
Washer fluid (warning lamp)	125
Wheel bolt tightening torque	182
Wheel chock	156
Wheels	
Changing/replacing	178
Changing a wheel	178
Checking	175
Cleaning	148
Cleaning (warning)	179
Fitting a new wheel	181
Fitting a wheel	179
Important safety notes	174
Overview	174
Removing a wheel	181
Storing	179
Technical data	182
Tightening torque	182
Wheel size/tyre size	182
Winch socket	137
Windows (cleaning instructions)	149
Windscreen washer fluid	
see Windscreen washer system	
Windscreen washer system	
Notes	196
Topping up	144
Windscreen wipers	
Problem (malfunction)	75
Rear window wiper	74
Replacing the wiper blades	74
Switching on/off	73
Winter	
Driving in winter	105
Winter operation	176
Winter operation	
Overview	176
Snow chains	176
Winter tyres	
M+S tyres	176
Wiper blades	
Cleaning	149
Important safety notes	74
Replacing	74
Working speed governor	
see ADR	

Protection of the environment

General notes

Environmental note

Daimler's declared policy is one of comprehensive environmental protection.

Our objectives are to use the natural resources which form the basis of our existence on this planet sparingly and in a manner which takes the requirements of both nature and humanity into consideration.

You too can help to protect the environment by operating your vehicle in an environmentally-responsible manner.

Fuel consumption and the rate of engine, transmission, brake and tyre wear depend on the following factors:

- operating conditions of your vehicle
- your personal driving style

You can influence both factors. Therefore, please bear the following in mind:

Operating conditions:

- avoid short trips, as these increase fuel consumption.
- observe the correct tyre pressure.
- do not carry any unnecessary weight in the vehicle.
- remove the roof rack once you no longer need it.
- a regularly serviced vehicle will contribute to environmental protection. You should therefore adhere to the service intervals.
- all maintenance work should be carried out at a qualified specialist workshop.

Personal driving style:

- do not depress the accelerator pedal when starting the engine.
- do not warm up the engine when the vehicle is stationary.
- drive carefully and maintain a safe distance from the vehicle in front.
- avoid frequent, sudden acceleration and braking.

- change gear in good time and use each gear only up to $\frac{2}{3}$ of its maximum engine speed.
- switch off the engine in stationary traffic.
- monitor the vehicle's fuel consumption.

Returning an end-of-life vehicle

Mercedes-Benz will take back your Mercedes-Benz to dispose of it in an environmentally responsible manner, in accordance with the European Union (EU) End of Life Vehicles Directive.

The End of Life Vehicles Directive applies to vehicles with a gross vehicle weight of up to 3.5 t, in accordance with national regulations. For several years, Mercedes-Benz has been meeting all the legal requirements for a design which allows for recycling and re-use. There is a network of return points and disassembly plants which can recycle your vehicle in an environmentally-responsible manner. The methods employed in vehicle and parts recycling are constantly being developed and improved. This means that your Mercedes-Benz will also continue to meet even the increased recycling quotas in the future in good time. You can obtain further information from your national Mercedes-Benz homepage or your national hotline number.

Owner's Manual

Vehicle equipment

This Owner's Manual describes all models and all standard and optional equipment of your vehicle available at the time of publication of the Owner's Manual. Country-specific differences are possible. Note that your vehicle may not be fitted with all features described. This is also the case for systems and functions relevant to safety. Therefore, the equipment on your vehicle may differ from that in the descriptions and illustrations.

The original purchase contract documentation for your vehicle contains a list of all of the systems in your vehicle.

Should you have any questions concerning equipment and operation, please consult a Mercedes-Benz Service Centre.

The Owner's Manual and the Service Booklet are important documents and should be kept in the vehicle.

Operating safety

Important safety notes

WARNING

If you do not have the prescribed service/maintenance work or necessary repairs carried out, this could result in malfunctions or system failures. There is a risk of an accident.

Always have the prescribed service/maintenance work as well as necessary repairs carried out at a qualified specialist workshop.

WARNING

Modifications to electronic components, their software as well as wiring could effect their function and/or the operation of other networked components. This could in particular also be the case for systems relevant to safety. They might not function properly any more and/or jeopardise the operational safety of the vehicle. There is an increased risk of an accident and injury.

Do not attempt to modify the wiring as well as electronic components or their software. Always have work on electrical and electronic components carried out at a qualified specialist workshop.

Improper modification of the electronic components, their software or wiring can render the operating permit invalid.

Declarations of conformity

Wireless vehicle components

The following information applies to all components of this vehicle that receive and/or transmit radio waves:

The components of this vehicle which receive and/or transmit radio waves are compliant with the basic requirements and other relevant provisions of Directive 1999/5/EC. You can obtain further information from any Mercedes-Benz Service Centre.

Electromagnetic compatibility

The electromagnetic compatibility of the vehicle components has been checked and certified according to Directive 72/245/EEC or the equivalent regulation ECE-R 10. In each case, the currently valid version is applicable.

Diagnostics connection

WARNING

If you connect equipment to a diagnostics connection, it can affect the operation of the vehicle systems. This could compromise the operating safety of your vehicle while driving. There is a risk of an accident.

Do not connect any equipment to a diagnostics connection.

WARNING

Loose equipment or cables hanging from a device which are connected to a diagnostic connection could impede pedal clearance. The equipment or cables could get caught between the pedals when driving and braking suddenly. This could impair the function of the pedals. There is a risk of accident.

Do not attach any equipment or cables in the driver's footwell.

 If the engine is switched off and a device is connected to a diagnostic connection, the battery may become discharged.

The diagnostics connection is only intended for the connection of diagnostic equipment at a qualified specialist workshop.

Connecting equipment to the diagnostics connection can lead to emissions monitoring information being reset, for example. This may lead to the vehicle failing to meet the requirements of the next emissions test during the main inspection.

Qualified specialist workshop

A qualified specialist workshop has the necessary special skills, tools and qualifications to correctly carry out any necessary work on your vehicle. This particularly applies to work relevant to safety.

Observe the notes in the Service Booklet.

Always have the following work carried out at a qualified specialist workshop:

- work relevant to safety
- service and maintenance work
- repair work
- modifications, installations and conversions
- work on electronic components

Mercedes-Benz recommends that you use a Mercedes-Benz Service Centre.

Vehicle registration

Mercedes-Benz may ask its Service Centres to carry out technical inspections on certain vehicles. The quality or safety of the vehicle is improved as a result of the inspection.

Mercedes-Benz can only inform you about vehicle checks if it has your registration data. It is possible that your vehicle has not yet been registered in your name in the following cases:

- if your vehicle was not purchased at an authorised specialist dealer.
- if your vehicle has not yet been examined at a Mercedes-Benz Service Centre.

It is advisable to register your vehicle with a Mercedes-Benz Service Centre.

Inform Mercedes-Benz as soon as possible about any change in address or vehicle ownership.

Correct use

Observe the following information when driving your vehicle:

- the safety notes in this manual
- the technical data in this manual
- traffic rules and regulations
- laws and safety standards pertaining to motor vehicles

If you remove any warning stickers, you or others could fail to recognise certain dangers. Leave warning stickers in position.

Implied warranty

! Follow the instructions in this manual about the proper operation of your vehicle as well as about possible vehicle damage. Damage to your vehicle that arises from culpable contraventions against these instructions are not covered either by Mercedes-Benz implied warranty or by the New or Used-Vehicle Warranty.

Data stored in the vehicle

Fault data

Components which are critical for vehicle operation are equipped with fault data memories as standard. There are also data storage devices which record the technical reactions of vehicle components to certain driving situations (e.g. airbag deployment).

This data is used exclusively to:

- assist in the rectification of faults and defects
- help Mercedes-Benz optimise and develop vehicle functions

The data cannot be used to trace the vehicle's movements.

When your vehicle is serviced by Mercedes-Benz, this technical information can be read out from the fault memory. Authorised employees of the Mercedes-Benz service network read this technical information using special diagnostic computers.

After a fault has been rectified, the information is deleted from the memory. Other memory data is constantly overwritten.

Other devices that store data

Depending on the equipment level, your vehicle may feature communications and/or entertainment systems (e.g. navigation devices, telephone systems). These allow you to save and edit data required for the operation of the respective device.

Further information on operation (e.g. on deleting data) can be found in the separate operating instructions.

Cockpit	18
Instrument cluster	19
Centre console	21

Cockpit



	Function	Page
①	Combination switch	60
②	Adjusts the headlamp range	61
③	Emergency start facility	163
④	Instrument cluster	19
⑤	Ignition lock	87
⑥	Glove compartment	130
⑦	Battery main switch ¹	87
⑧	Steering wheel	
⑨	Horn	
⑩	Opening the bonnet	140

¹ Only for 24 V electrical system.

Instrument cluster

Displays and controls

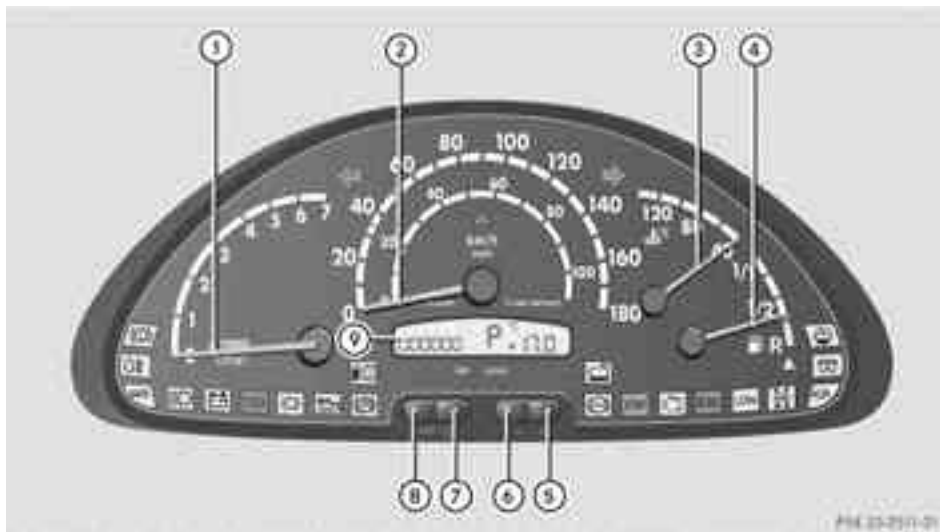

FH 22-211-01

	Function	Page
①	Rev counter	118
②	Speedometer	
③	Coolant temperature gauge	118
④	Fuel gauge	
⑤	Adjusts the instrument cluster lighting: brighter	119
⑥	Adjusts the instrument cluster lighting: dimmer	119
⑦	Inoperative	
⑧	Total distance recorder/trip meter selector button Reset button	119
⑨	Display	

Warning and indicator lamps



	Function	Page
①	Brakes	120
②	Turn signals	60
③	ABS warning lamp	121
④	Reserve fuel	122
⑤	Washer fluid level	125
⑥	Preglow	122
⑦	ADR	95
⑧	Air filter	124
⑨	Transfer case	125
⑩	Engine diagnostics	122

	Function	Page
⑪	ABS indicator lamp	120
⑫	Coolant	
⑬	Fuel/water separator	124
⑭	Parking brake	122
⑮	Oil level	124
⑯	Brake pad wear indicator	
⑰	Battery	123
⑱	Main-beam headlamps	60
⑲	SRS	122
⑳	Rear foglamp	60

Centre console

Overview

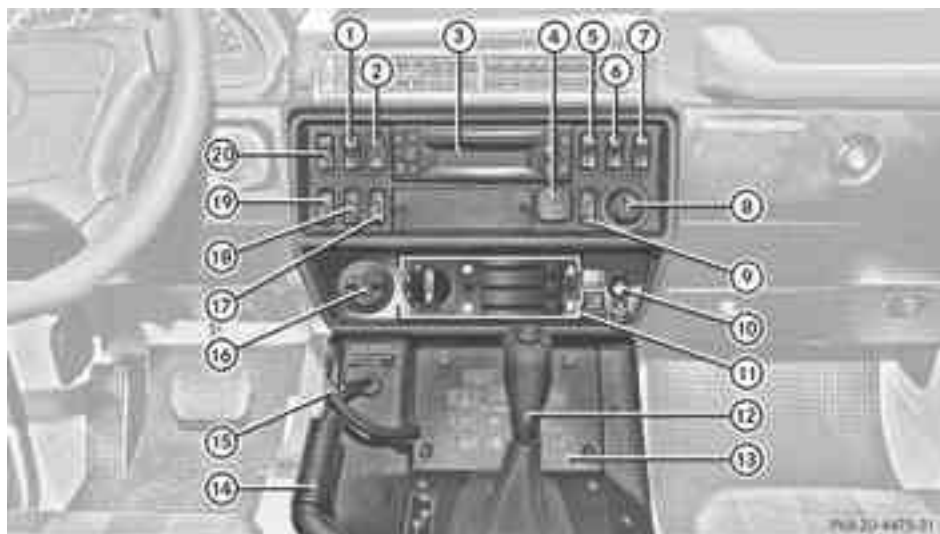

i Example: centre console overview

	Function	Page
①	Rear foglamp	60
②	Hazard warning lamps	61
③	CD/radio player; see the separate operating instructions	
④	12 V socket	136
⑤	Activates/deactivates ADR (working speed governor)	95
⑥	Adjusts ADR (working speed governor)	95
⑦	Switch for cable-winch socket/ Jump starting socket	137 165
⑧	Increases/reduces the temperature (air-conditioning system)	80
⑨	Air-recirculation mode	81

	Function	Page
⑩	24 V power socket	136
⑪	Heating and air-conditioning system control panel	79
⑫	Automatic transmission selector lever	91
⑬	Control panel	22
⑭	Parking brake	101
⑮	Battery main switch	87
⑯	Light switch	58
⑰	Switches the rear window wiper on/off	74
⑱	Washes the rear window with washer fluid	74
⑲	Rear window heating	81
⑳	Foglamps	60

Lower section with control panel

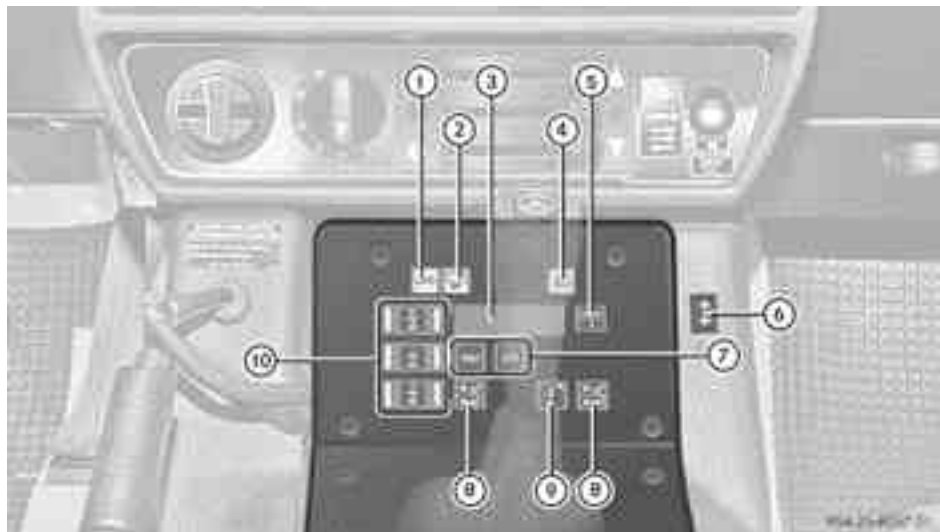

i Centre console, lower section with control panel (example)

	Function	Page
①	24 V turn signal indicator lamp for trailer towing	
②	24 V battery charge warning lamp	163
③	Display for 12 V/24 V battery voltage and operating hours counter	
④	Foglamp indicator lamp	60
⑤	Switches display between 12 V/24 V battery voltage and operating hours counter	

	Function	Page
⑥	12 V turn signal indicator lamp for trailer towing	
⑦	Engages the transfer case	110
⑧	Seat heating	53
⑨	Auxiliary heating	82
⑩	Engages differential locks	112

Useful information	24
Occupant safety	24
Children in the vehicle	29
Driving safety systems	35
Anti-theft systems	36

Useful information

- i** This Owner's Manual describes all models, series and optional equipment for your vehicle that were available at the time of going to press. Country-specific differences are possible. Note that your vehicle may not be fitted with all features described. This is also the case for systems and functions relevant to safety.
- i** Read the information on qualified specialist workshops: (▷ page 15).

Occupant safety

Important safety notes

WARNING

If service work is not carried out correctly, the operating safety of your vehicle may be affected. This could cause you to lose control of your vehicle and cause an accident. Moreover, the safety systems may no longer be able to protect you or others as they are designed to do.

Always have service work carried out at a qualified specialist workshop.

WARNING

Modifications to the restraint systems could result in them not functioning properly any more. The restraint systems could then no longer protect vehicle occupants as they are designed to do and could fail in the event of an accident or activate unexpectedly, for example. There is an increased risk of injury. Never modify parts of the restraint systems. Do not attempt to modify the wiring as well as electronic components or their software.

The airbag system can be adapted for a person with disabilities. For further information, consult a Mercedes-Benz Service Centre.

Seat belts, together with the Supplemental Restraint System, SRS (▷ page 24), are complementary, co-ordinated restraint sys-

tems. They reduce the risk of injury in specific, pre-defined types of accident situations and thereby increase occupant safety. However, seat belts and airbags generally do not protect against objects penetrating the vehicle from the outside.

To ensure that the restraint systems can deliver their full potential protection, make sure that:

- the seat and head restraint are adjusted properly (▷ page 50)
- the seat belt has been fastened properly (▷ page 29)
- the airbags can inflate unrestricted if deployed (▷ page 26)
- the restraint systems have not been modified

An airbag increases the protection of vehicle occupants wearing a seat belt. However, airbags are only an additional restraint system which complements, but does not replace, the seat belt. All vehicle occupants must wear their seat belt correctly at all times, even if the vehicle is equipped with airbags. The airbags are not deployed in all types of accidents. For example, if the protective capacity of correctly fastened seat belts is not increased by deploying the airbags, the airbags will not deploy.

Airbag deployment only provides increased protection if the seat belt is worn correctly. The seat belt helps, firstly, to keep the vehicle occupant in the best position in relation to the airbag. Secondly, in a head-on collision, for example, the seat belt prevents the vehicle occupant from being propelled towards the point of impact.

SRS (Supplemental Restraint System)

Introduction

SRS reduces the risk of occupants coming into contact with the vehicle's interior in the event of an accident. It can also reduce the

forces to which occupants are subjected during an accident.

SRS consists of:

- SRS warning lamps **SRS**
- airbags
- airbag control unit

SRS warning lamp

WARNING

If SRS is malfunctioning, child restraint system components may be triggered unintentionally or might not be triggered at all in the event of an accident with a high rate of vehicle deceleration. There is an increased risk of injury, possibly even fatal.

Have SRS checked and repaired immediately at a qualified specialist workshop.

A malfunction has occurred if the **SRS** warning lamp:

- does not go out after three seconds when you turn the key to position **1** in the ignition lock (self diagnosis)
- does not go on when you turn the key to position **2** in the ignition lock
- does not go out after the engine has been running for a few seconds
- lights up again

Airbag deployment

During the first stage of a collision, the airbag control unit evaluates important physical data relating to vehicle deceleration or acceleration, such as:

- duration
- direction
- magnitude

Based on the evaluation of this data, the airbag control unit triggers the front airbags in the event of a collision with a very high rate of deceleration or acceleration in a longitudinal direction. In the event of a collision, the

front airbags inflate with the maximum amount of gas within a few milliseconds.

- **i** Airbags are not deployed in all types of accidents. Also, not all airbags are deployed together in an accident. The different airbag systems work independently of each other.

How the airbag system works is determined by the severity of the collision detected, especially the vehicle deceleration or acceleration, and the apparent type of accident:

- head-on collision
- rear impact

The rate of vehicle deceleration or acceleration and the direction of the force are essentially determined by:

- the distribution of forces during the collision
- the collision angle
- the deformation characteristics of the vehicle
- the characteristics of the object with which the vehicle has collided

Factors which can only be seen and measured after a collision has occurred do not play a decisive role in the deployment of an airbag, nor do they provide an indication of airbag deployment.

The vehicle may be deformed significantly, e.g. the bonnet or the wing, without an airbag being deployed. This is the case if only parts which are relatively easily deformed are affected and the rate of deceleration is not high. Conversely, airbags may be deployed even though the vehicle suffers only minor deformation. This is the case if, for example, very rigid vehicle parts such as longitudinal body members are hit, and sufficient deceleration occurs as a result.

Airbags

Important safety notes

WARNING

Airbags provide additional protection; they are not, however, a substitute for seat belts. Observe the following notes to reduce the risk of serious or even fatal injury caused by airbag deployment:

- all vehicle occupants – in particular, pregnant women – must wear their seat belt correctly at all times and lean back against the backrest, which should be positioned as close to the vertical as possible. The head restraint must support the back of the head at about eye level.
- always secure children less than 1.50 m tall and under 12 years of age in suitable child restraint systems.
- the driver and front passenger must select a seat position that is as far away from the airbag as possible. The driver's seat position must allow the vehicle to be driven safely. The driver's chest should be as far away from the centre of the driver's airbag cover as possible.
- move the front-passenger seat as far back as possible. This is especially important if you have secured a child in a forward-facing child restraint system on the front-passenger seat.
- a rearward-facing child restraint system must never be secured on the front-passenger seat.
- make sure there are no heavy or sharp-edged objects in the pockets of clothing.
- do not lean forwards, e.g. over the cover of the driver's/front-passenger front airbag, particularly when the vehicle is in motion.
- do not put your feet on the dashboard.
- only hold the steering wheel on the outside. This allows the airbag to be fully deployed. You could be injured if the airbag is deployed and you are holding the inside of the steering wheel.

- do not lean on the doors from inside the vehicle.
- make sure that there are no people, animals or objects between the driver, front passenger and the area where the airbags are deployed.
- do not place any objects between the seat backrest and the door.
- do not hang any hard objects, e.g. coat hangers, on the grab handles or coat hooks.
- do not attach accessories, e.g. cup holders, to the doors.

It is not possible to rule out a risk of injury being caused by an airbag, due to the high speed at which the airbag must be deployed.

WARNING

If you modify the airbag covers or affix objects, e.g. stickers to them, the airbags may no longer function as intended. There is an increased risk of injury.

Never modify the airbag covers and do not affix any objects to them.

WARNING

After the driver's airbag has been deployed, the airbag parts are hot. There is a risk of injury.

Do not touch the airbag parts. Have deployed airbags replaced immediately at a qualified specialist workshop.

-  Have the vehicle towed to a qualified specialist workshop after the airbags have been deployed.

If an airbag deploys, you will hear a bang and a small amount of powder is released. Only in rare cases will the bang affect your hearing. The powder that is released generally does not constitute a health hazard. The **SRS** warning lamp lights up. If it is safe to do so:

► Leave the vehicle as soon as possible.

If you are unable to leave the vehicle:

► Open a window.

You will get fresh air and avoid breathing difficulties.

Your vehicle is equipped with a driver's and front-passenger's front airbag.

Airbag deployment slows down and restricts the movement of the vehicle occupant.

The installation locations of the airbags can be found in the "Front airbags" section (► page 27).

Front airbags

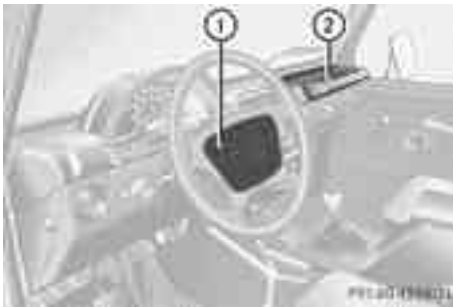

Driver's airbag ① deploys in front of the steering wheel; front-passenger front airbag ② deploys in front of and above the glove compartment.

The front airbags increase protection for the driver's and front-passenger's head, neck and chest.

They are deployed:

- at the start of an accident with a high rate of vehicle acceleration or deceleration in a longitudinal direction
- if the system determines that airbag deployment can offer additional protection to that provided by the seat belt
- depending on whether the seat belt is being used

If the vehicle overturns, the front airbags are generally not deployed. The front airbags are deployed if the system detects high vehicle deceleration in a longitudinal direction.

Seat belts

Important safety notes

WARNING

A seat belt which is not worn correctly, or which has not been engaged in the seat belt buckle correctly, cannot provide the intended level of protection. Under certain circumstances, this could cause severe or even fatal injuries in the event of an accident.

Therefore, make sure that all occupants – in particular, pregnant women – wear their seat belts correctly at all times.

- The seat belt must fit snugly on your body and must not be twisted. Therefore, avoid wearing bulky clothing, e.g. a winter coat. The shoulder section of the belt must be routed across the centre of your shoulder – on no account across your neck or under your arm – and pulled tight against your upper body. The lap belt must always pass across your lap as low down as possible, i.e. over your hip joints – not across your abdomen. If necessary, push the seat belt slightly downwards and adjust it by pulling it in the direction the seat belt retracts.
- Do not route the seat belt strap over sharp or fragile objects. Please make sure that such objects are not on or in your clothing, e.g. spectacles, pens or keys etc. The seat

belt strap could become damaged and tear during an accident and you or other vehicle occupants could be injured.

- Only one person should use each seat belt at any one time. Children must never travel sitting on the lap of another occupant. The child will not be secured in the event of an accident, heavy braking or sudden change of direction. This may result in the child or other occupants being seriously or fatally injured.
- Persons under 1.50 m tall cannot wear the seat belts correctly. For this reason secure persons less than 1.50 m tall in specially designed, suitable restraint systems.
- Children under 1.50 m tall and younger than twelve years of age cannot wear the seat belts correctly. For this reason secure them in special suitable child restraint systems installed on a suitable seat. Additional information can be found in the Operating Instructions in the chapter "Safety", "Children in the Vehicle". Observe the installation instructions of the child restraint system manufacturer.
- Do not secure an object with a seat belt if the seat belt is also being used by one of the vehicle's occupants.

WARNING

The seat belt does not offer the intended level of protection if the backrest is not in the upright position. When braking or in the event of an accident, you could slide underneath the seat belt and sustain abdomen or neck injuries, for example. This poses an increased risk of injury or even fatal injury.

Adjust the seat properly before beginning your journey. Always make sure that the seat is in the upright position.

WARNING

Seat belts cannot perform their intended protective function if:

- they are damaged, modified, bleached or coloured, or are very dirty
- the seat belt buckle is damaged or very dirty
- modifications have been made to the seat belt tensioners or belt anchorages

In the event of an accident, seat belts can sustain damage that is not visible to the naked eye, e.g. due to glass splinters. Modified or damaged seat belts could tear or fail in the event of an accident, for example. Modified belt tensioners could deploy unexpectedly or fail. There is an increased risk of serious or even fatal injuries.

Never make modifications to seat belts, belt tensioners, belt anchorages or seat belt retractors. Make sure that the seat belts are undamaged, are not worn and are clean.

Mercedes-Benz recommends that you only use seat belts which have been approved specifically for your vehicle by Mercedes-Benz.

The three-point seat belt provides better restraint than the lap belt and therefore provides better protection against injuries. Passengers on the rear seats should therefore use the seats with three-point seat belts when possible.

Seat belts are the most effective means of restraining the movement of vehicle occupants in the event of an accident. This reduces the risk of vehicle occupants coming into contact with parts of the vehicle interior.

Fastening seat belts

Three-point seat belt

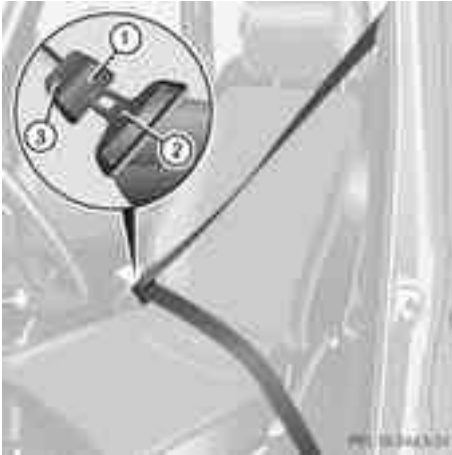

Example: three-point seat belt, front

- ▶ Adjust the seat and move the backrest to an almost vertical position (> page 50).
- ▶ Pull the seat belt smoothly from the inertia reel.
- ▶ Without twisting it, guide the shoulder section of the seat belt across the middle of your shoulder and the lap section across your hips.
- ▶ Engage belt tongue ② in buckle ③.
- ▶ If necessary, pull upwards on the shoulder section of the seat belt to tighten the belt across your body.

For more information about releasing the seat belt with release button ①, see "Releasing seat belts" (> page 29).

Releasing the seat belts

- ❗ Make sure that the seat belt is fully rolled up. Otherwise, the seat belt or belt tongue will be trapped in the door or in the seat mechanism. This could damage the door, the door trim panel and the seat belt. Damaged seat belts can no longer fulfil their protective function and must be replaced. Visit a qualified specialist workshop.

- ▶ Press release button ① of belt buckle ③ and guide belt tongue ② back towards belt sash guide.

Children in the vehicle

Child restraint systems

Important safety notes

WARNING

To reduce the risk of serious or even fatal injury to the child in the event of a sudden change in direction, braking or an accident:

- Children less than 1.50 m tall and under twelve years of age must always be secured in special child restraint systems on a suitable vehicle seat. This is necessary because the seat belts are not designed for children.
- Children must never travel sitting on the lap of another occupant. Due to the forces which occur in the event of a sudden change of direction, heavy braking or an accident, it would not be possible to restrain the child. The child could be thrown against parts of the vehicle interior and be seriously or even fatally injured.

WARNING

The child restraint system cannot perform its protective function if it is not correctly fitted to a suitable vehicle seat. The child cannot be restrained in the event of an accident, heavy braking or sudden changes of direction. The child could be seriously or even fatally injured. For this reason, when fitting a child restraint system, observe the manufacturer's installation instructions and the correct use of the child restraint system.

Child restraint systems should be fitted to the rear seats. Children are generally better protected there.

The entire base of the child restraint system must always rest on the seat cushion. There-

fore, never place objects, e.g. a cushion, under the child restraint system.

Only use child restraint systems with the original cover designed for them. Only replace damaged covers with genuine Mercedes-Benz covers.

We recommend the use of child restraint systems which have been approved for Mercedes-Benz vehicles.

WARNING

If the child restraint system is fitted incorrectly or is not secured, it can come loose in the event of an accident, heavy braking or a sudden change in direction. The child restraint system could be thrown about, striking vehicle occupants. There is an increased risk of injury, possibly even fatal.

Always fit child restraint systems properly, even if they are not being used. Make sure that you observe the child restraint system manufacturer's installation instructions.

If a child is travelling in your vehicle, secure the child using a child restraint system which is appropriate to the size, age and weight of the child and recommended for Mercedes-Benz vehicles. You should preferably fit the restraint system to a suitable rear seat. Make sure that the child is secured in a child restraint system throughout the trip.

Mercedes-Benz recommends that you only use the listed child restraint systems (▷ page 34).

You can obtain information about the correct child restraint system from any Mercedes-Benz Service Centre.

-  It is advisable to use Mercedes-Benz care products to clean child restraint systems. You can obtain information about this at any Mercedes-Benz Service Centre.

Child restraint system on the front-passenger seat

WARNING

If the front-passenger front airbag is not disabled:

- a child secured in a child restraint system on the front-passenger seat could be seriously or even fatally injured by the front-passenger airbag deploying. This is especially a risk if the child is in the immediate vicinity of the front-passenger front airbag when it deploys.
- never secure a child on the front-passenger seat in a rearward-facing child restraint system. Only secure a rearward-facing child restraint system on a suitable rear seat.
- always move the front-passenger seat to the rearmost position if you secure a child in a forward-facing child restraint system on the front-passenger seat.

Information about recommended child restraint systems is available at any Mercedes-Benz Service Centre.

The vehicle has no automatic child seat recognition and the front-passenger front airbag cannot be manually deactivated.



Warning symbol for a rearward-facing child restraint system

Do not use a rearward-facing child restraint system on a seat that is protected by an airbag installed in front of it.

ISOFIX child seat securing system for the rear seats

WARNING

ISOFIX child restraint systems do not provide sufficient protection for children weighing more than 22 kg. The child cannot be restrained in the event of an accident, for instance. There is an increased risk of injury, possibly even fatal.

If the child weighs more than 22 kg, secure the ISOFIX child restraint system additionally with the seat belt. If available, secure the child restraint system additionally with the Top Tether belt.

WARNING

The child restraint system cannot perform its protective function if it is not correctly fitted to a suitable vehicle seat. The child cannot be restrained in the event of an accident, heavy braking or sudden changes of direction. The child could be seriously or even fatally injured. For this reason, when fitting a child restraint system, be sure to observe the manufacturer's installation instructions and the instructions for correct use of the child restraint system.

For safety reasons, when installing child restraint systems on the rear seats, only use child restraint systems with the ISOFIX child seat securing system, which are specially tested and approved for Mercedes-Benz vehicles.

An incorrectly fitted child restraint system could come loose and seriously or even fatally injure the child or other vehicle occupants. When fitting the child restraint system, always make sure that it is engaged correctly in the securing rings on both sides.

ISOFIX is a standardised securing system for specially designed child restraint systems on the rear seats. Securing rings for two ISOFIX child restraint systems are fitted on the left and right of the rear seats.

Before every trip, make sure that the ISOFIX child restraint system is engaged correctly in both securing rings

When fitting a child restraint system, be sure to observe the manufacturer's installation instructions and the instructions for correct use of the child restraint system.



Example: rear bench seat, front-passenger side

① Securing rings

- ▶ Install the ISOFIX child restraint system. Comply with the manufacturer's instructions when installing the ISOFIX child restraint system.

Top Tether

WARNING

If you secure the Top Tether belt incorrectly, e.g. to the loop underneath the Top Tether anchorage, the child restraint system is not correctly kept in place. It therefore cannot perform its intended protective function in the event of an accident. This poses an increased risk of injury.

Only secure the Top Tether hook to the intended Top Tether anchorage.

Top Tether provides an additional connection between the child restraint system secured with ISOFIX and the rear seat. It helps reduce the risk of injury even further.



Example: vehicles with a 12 V electrical system



- ▶ Move the head restraint upwards.
- ▶ Fit the ISOFIX child restraint system with Top Tether. Comply with the manufacturer's installation instructions when doing so.
- ▶ Route Top Tether belt (3) under the head restraint between the two head restraint bars.
- ▶ Hook Top Tether hook (1) to Top Tether anchorage (2) on the side wall.
- ▶ Hook Top Tether hook (1) of Top Tether belt (3) into Top Tether anchorage (2).

Ensure that:

- Top Tether hook (1) is hooked into Top Tether anchorage (2) as shown
- Top Tether belt (3) is not twisted
- ▶ Make sure that Top Tether belt (3) is not twisted.
- ▶ Tension Top Tether belt (3). Comply with the manufacturer's installation instructions when doing so.
- ▶ Move the head restraint back down again slightly if necessary (▷ page 52). Make

sure that you do not interfere with the correct routing of Top Tether belt (3).

Suitable positioning of the child restraint systems

Weight categories and ages	Category 0: up to 10 kg up to approximately 9 months	Category 0+: up to 13 kg up to approximately 18 months
Child restraint system on the front-passenger seat ²	Not suitable	Not suitable
Child restraint system on the left-hand and right-hand sides of the rear bench seat ³	Universal	Universal

Weight categories and ages	Category I: 9 to 18 kg between approximately 8 months and 4 years	Category II/III: 15 to 36 kg between approximately 3.5 and 12 years
Child restraint system on the front-passenger seat ²	Universal, forward-facing	Universal
Child restraint system on the left-hand and right-hand rear seats ³	Universal	Universal

"Universal" category child restraint systems can be recognised by their orange approval label with the inscription "universal".



Example: approval label on the child restraint system

² Move the front-passenger seat to its rearmost position.

³ Vehicles with rear seats only.

Recommended child restraint systems

Weight categories and ages	Category 0: up to 10 kg up to approximately 9 months	Category 0+: up to 13 kg up to approximately 18 months
Manufacturer	Britax Römer	Britax Römer
Type	BABY SAFE PLUS	BABY SAFE PLUS
Approval number	E1 03 301146 E1 04 301146	E1 03 301146 E1 04 301146
Order number	A000 970 10 00	A000 970 10 00

Weight categories and ages	Category I: 9 to 18 kg between approximately 8 months and 4 years	Category II/III: 15 to 36 kg between approximately 3.5 and 12 years
Manufacturer	Britax Römer	Britax Römer
Type	DUO PLUS	KIDFIX
Approval number	E1 03 301133 E1 04 301133	E1 04 301198
Order number	A000 970 16 00	A000 970 19 00

Child-proof locks for the rear side doors and rear door

⚠ WARNING

If children are travelling in the vehicle, they could:

- open doors, thus endangering other people or road users
- exit the vehicle and be caught by oncoming traffic
- operate vehicle equipment and become trapped, for example

There is a risk of an accident and injury.

Always activate the child-proof locks and override feature if children are travelling in the vehicle. When leaving the vehicle, always take the key with you and lock the vehicle. Never leave children unattended in the vehicle.

A door secured with a child-proof lock cannot be opened from inside the vehicle. When the vehicle is unlocked, the door can only be opened from the outside.

i The chassis cab 6x6 with crewcab has no child-proof locks on the rear doors.

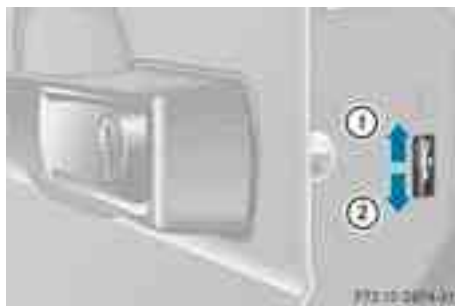

Example: rear side door

The station wagon has a child-proof lock on the rear doors and the tailgate.

- ▶ **To activate:** press the child-proof lock lever down in the direction of arrow ②.
- ▶ Make sure that the child-proof locks are working properly.
- ▶ **To deactivate:** press the child-proof lock lever up in the direction of arrow ①.

Driving safety systems

Driving safety systems overview

In this section, you will find information about the following driving safety systems:

- ABS (**A**nti-**l**ock **B**raking **S**ystem)
- BAS (**B**rake **A**ssist **S**ystem)
- EBD (**e**lectronic **b**rake **f**orce **d**istribution)

Important safety notes

If you fail to adapt your driving style, the driving safety systems can neither reduce the risk of accident nor override the laws of physics. Driving safety systems are merely aids designed to assist driving. You are responsible for the distance to the vehicle in front, for vehicle speed and for braking in good time. Always adapt your driving style to suit the prevailing road and weather conditions as well as the traffic conditions, and maintain a safe distance from the vehicle in front. Drive carefully.

- ❗ Please note that the driving safety systems described only work as effectively as possible when there is adequate contact between the tyres and the road surface. Pay particular attention to the information regarding tyres, recommended minimum tyre tread depths etc. in the "Wheels and tyres" section (▷ page 174).

In wintry driving conditions, always use winter tyres (M+S tyres) and, if necessary, snow chains. Only in this way will the driving safety systems described in this section work as effectively as possible.

ABS (Anti-lock Braking System)

Important safety notes

- ❗ Observe the "Important safety notes" section (▷ page 35).

WARNING

If ABS is faulty, the wheels could lock when braking. The steerability and braking characteristics may be severely impaired. Additionally, further driving safety systems are deactivated. There is an increased danger of skidding and accidents.

Drive on carefully. Have ABS checked immediately at a qualified specialist workshop.

ABS regulates brake pressure in such a way that the wheels do not lock when you brake. This allows you to continue steering the vehicle when braking.

ABS works from a speed of about 8 km/h upwards, regardless of road-surface conditions. ABS intervenes on slippery road surfaces, even when you only brake gently. The  indicator lamp in the instrument cluster (▷ page 20) lights up briefly when the engine is started. This indicates that ABS is operational.



Braking



- ❗ If a blackout lighting setting is selected, the button illumination and instrument cluster lighting are switched off. You will not be informed that the differential locks are engaged and that ABS is switched off. If you do not adapt your driving style accordingly, you could damage the transfer case.

If ABS intervenes when braking, you will feel a pulsing in the brake pedal.

- ▶ **If ABS intervenes:** continue to depress the brake pedal with force until the braking situation is over.
- ▶ **To make a full brake application:** depress the brake pedal with full force.

The pulsating brake pedal can be an indication of hazardous road conditions, and functions as a reminder to take extra care while driving.

- i** If ABS is malfunctioning, the  indicator lamp and the  warning lamp, or just the  indicator lamp in the instrument cluster light up.

When the differential locks are engaged, ABS is switched off. The  indicator lamp and the  warning lamp light up in the instrument cluster.

Normal driving and braking functions are still available.

BAS (Brake Assist System)

- i** Observe the "Important safety notes" section (▷ page 35).

WARNING

If BAS is malfunctioning, the braking distance in an emergency braking situation is increased. There is a risk of accident.

In an emergency braking situation, depress the brake pedal with full force. ABS prevents the wheels from locking.

BAS operates in emergency braking situations. If you depress the brake pedal quickly, BAS automatically boosts the braking force, thus shortening the stopping distance.

- Keep the brake pedal depressed firmly until the emergency braking situation is over. ABS prevents the wheels from locking.

The brakes will function as usual once you release the brake pedal. BAS is deactivated.

EBD (electronic brake force distribution)

- i** Observe the "Important safety notes" section (▷ page 35).

WARNING

If EBD has malfunctioned, the rear wheels can still lock, e.g. under full braking. This increases the risk of skidding and an accident.

You should therefore adapt your driving style to the different handling characteristics. Have the brake system checked at a qualified specialist workshop.

Observe information regarding indicator and warning lamps (▷ page 120).

EBD monitors and controls the brake pressure on the rear wheels to improve driving stability while braking.

Anti-theft systems

Immobiliser

- **To activate:** remove the key from the ignition lock.
- **To deactivate:** switch on the ignition.

The immobiliser prevents your vehicle from being started without the correct key.

- i** The immobiliser is always deactivated when you start the engine.

Useful information	38
Key	38
Doors	39
Rear door	40
Split rear door	42
Platform truck dropsides	44
Windows	46

Useful information

- i** This Owner's Manual describes all models, series and optional equipment for your vehicle that were available at the time of going to press. Country-specific differences are possible. Note that your vehicle may not be fitted with all features described. This is also the case for systems and functions relevant to safety.
- i** Read the information on qualified specialist workshops: (▷ page 15).

Key

Unlocking/locking the vehicle

WARNING

If children are left unsupervised in the vehicle, they can:

- open doors and endanger other persons or road users
- climb out and be injured by the traffic
- operate vehicle equipment and, for example, trap themselves.

Children could also set the vehicle in motion, for example by:

- releasing the parking brake
- shifting the automatic transmission out of park position **P**
- starting the engine.

There is a risk of an accident and injury.

When leaving the vehicle, always take the key with you and lock the vehicle. Never leave children unattended in the vehicle. Always keep the key out of reach of children.



Key

- ▶ **To unlock the vehicle:** insert the key into the door lock.
- ▶ Turn the key anti-clockwise.
- ▶ **To lock the vehicle:** insert the key into the door lock.
- ▶ Turn the key clockwise.
- i** The key fits all the door locks (except the glove compartment) and the fuel filler cap of the vehicle.

Problems with the key

Problem	Possible causes/consequences and ► Solutions
You have lost the key.	<ul style="list-style-type: none"> ► Report the loss immediately to the vehicle insurers. ► If necessary, have the locks changed as well.

Doors

Unlocking and opening the doors from the inside

You can open a door from inside the vehicle at any time, even if it has been locked.

You can only open the rear compartment doors from inside the vehicle if they are not secured by the child-proof locks (► page 34).



- ① To unlock
 - ② To lock
 - ③ Door handle
- Push the latch upwards ①.
The door is unlocked and can be opened.
- Pull door handle ③ and open the door.
- i** If you open a locked door from inside the vehicle, it is unlocked automatically.
 - i** You can only open a locked rear door from inside the vehicle if the child-proof locks have not been activated.

Centrally locking and unlocking the vehicle from the inside

⚠ WARNING

If children are left unsupervised in the vehicle, they could:

- open the doors, thus endangering other people or road users.
- get out and disrupt traffic.
- operate the vehicle's equipment.

Additionally, children could set the vehicle in motion if, for example, they:

- release the parking brake.
- shift the automatic transmission out of parking position P.
- shift the manual transmission into neutral.
- start the engine.

There is a risk of an accident and injury. When leaving the vehicle, always take the key with you and lock the vehicle. Never leave children or animals unattended in the vehicle. Always keep the key out of reach of children.

You can centrally lock or unlock the vehicle from the inside.

The button for the central locking does not lock or unlock the fuel filler flap.

The switch for the central locking is on the lower section of the centre console.

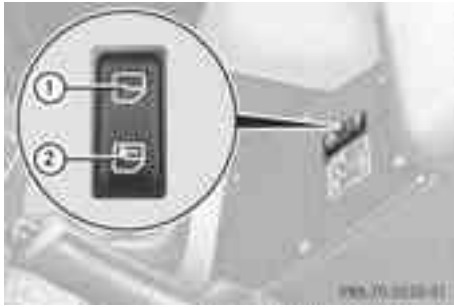

Example: station wagon

- ▶ **To unlock:** press button ①.
- ▶ **To lock:** press button ②.

- i** It is only possible to lock the vehicle centrally if the driver's door is closed.
- i** The doors unlock automatically in the event of an accident if the force of the impact exceeds a predetermined level.

Rear door

Important safety notes

WARNING

Combustion engines emit poisonous exhaust gases such as carbon monoxide. If the tailgate/rear door is open when the engine is running, particularly if the vehicle is moving, exhaust fumes could enter the passenger compartment. There is a risk of poisoning.

Turn off the engine before opening the tailgate/rear door. Never drive off with the tailgate/rear door open.

WARNING

If children are left unsupervised in the vehicle, they could:

- open the doors, thus endangering other people or road users.
- get out and disrupt traffic.
- operate the vehicle's equipment.

Additionally, children could set the vehicle in motion if, for example, they:

- release the parking brake.
- shift the automatic transmission out of parking position P.
- shift the manual transmission into neutral.
- start the engine.

There is a risk of an accident and injury.

When leaving the vehicle, always take the key with you and lock the vehicle. Never leave children or animals unattended in the vehicle. Always keep the key out of reach of children.

Opening from the outside

You can only open the rear door after unlocking it first.

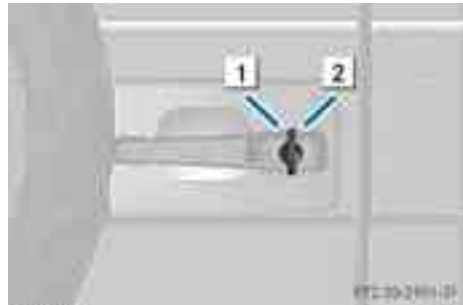

1 To unlock

2 To lock

- ▶ Insert the key into the door lock.
 - ▶ Turn the key anti-clockwise **1**.
 - The rear door is unlocked.
 - ▶ Remove the key.
- or
- ▶ Unlock the vehicle centrally from the inside (▷ page 39).

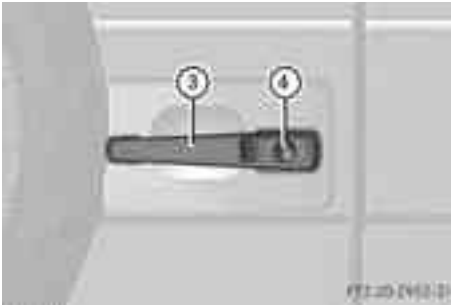

- ▶ Press lock cylinder ④ and pull door handle ③.

Entering/exiting through the rear door



Example: station wagon

- ▶ Open the rear door.
- ▶ Hold on to grab handle ① and tread on step ② on the bumper.

Opening from the inside



- ① To unlock
- ② To lock
- ③ Door handle

- ▶ Slide latch ① upwards. The door is unlocked.
- ▶ Pull door handle ③.

- i** If the child-proof locks (> page 34) are used to secure the rear door, you cannot open it from inside the vehicle, even when it has been unlocked.

Closing from the outside

- ▶ Close the rear door.
- ▶ Insert the key into the door lock.
- ▶ Turn the key clockwise. The rear door is locked.

Closing from inside the vehicle

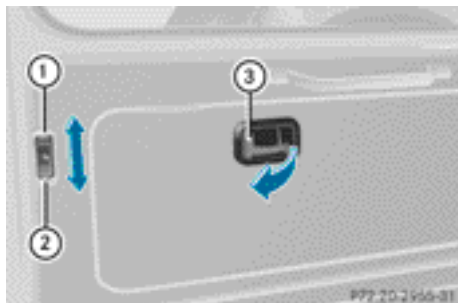

- ① To unlock
- ② To lock
- ③ Door handle

- ▶ Secure the rear door with the child-proof locks if necessary (▷ page 34).
- ▶ Pull the rear door closed using the handle underneath the rear window.
- ▶ Push the latch downwards ②. The rear door is locked.

Split rear door

Swinging the spare wheel bracket to one side

- ❗ Make sure that there is sufficient clearance.

⚠ WARNING

If the exterior spare wheel bracket has been moved to one side, the tail lamp may be covered. Other road users may not recognise the vehicle and, as a result, crash into your vehicle from the rear. Secure the vehicle additionally with a warning lamp or a warning triangle. Do not drive the vehicle if the spare wheel bracket is folded away from the vehicle.

Make sure that the spare wheel bracket is closed correctly.

You could otherwise injure people or cause an accident due to the flailing action of the spare wheel bracket.

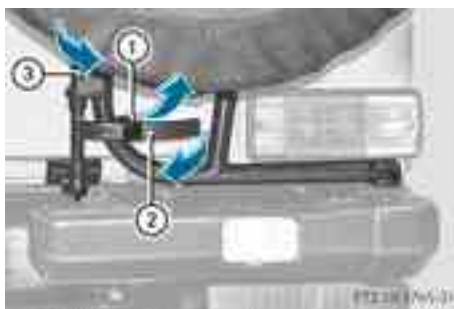

- ▶ Raise safety catch ① and pull lever ② in the direction of the arrow.
- ▶ Swing spare wheel bracket ③ to one side.

Opening from the outside

⚠ WARNING

Combustion engines emit poisonous exhaust gases such as carbon monoxide. If the tail-gate/rear door is open when the engine is running, particularly if the vehicle is moving, exhaust fumes could enter the passenger compartment. There is a risk of poisoning. Turn off the engine before opening the tail-gate/rear door. Never drive off with the tail-gate/rear door open.

- ❗ Make sure that you first open the left-hand rear door and then the right-hand rear door. You could otherwise damage the rear doors.
- ❗ Make sure that there is sufficient clearance.
- ▶ Insert the key into the door lock.
- ▶ Turn the key anti-clockwise. The rear door is unlocked.
- ▶ Remove the key.

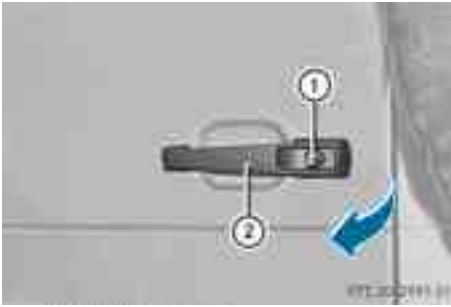

- ▶ Press lock cylinder ① and pull door handle ②.
- ▶ Open the left half of the rear door to the left.
- ▶ Swing the spare wheel bracket to one side (▷ page 42).



- ▶ Press lever ③ in the direction of the arrow and open the right half of the rear door to the right.

Entering/exiting through the rear door



- ▶ Swing the spare wheel bracket to one side.
- ▶ Open the left and right halves of the split rear door.
- ▶ When entering or exiting the vehicle, hold on to grab handle ① on the rear wall and use step ② above the trailer tow hitch.

Opening from the inside

- ❗ Make sure that there is sufficient clearance.

WARNING

Combustion engines emit poisonous exhaust gases such as carbon monoxide. If the tail-gate/rear door is open when the engine is running, particularly if the vehicle is moving, exhaust fumes could enter the passenger compartment. There is a risk of poisoning. Turn off the engine before opening the tail-gate/rear door. Never drive off with the tail-gate/rear door open.



- ▶ Make sure that the spare wheel bracket is folded to the side (▶ page 42).
- ▶ Push latch ① upwards. The door is unlocked.
- ▶ Pull door handle ② and open the left half of the rear door.

Closing from the outside

- ❗ Make sure that you first close the right-hand rear door and then the left-hand rear door. You could otherwise damage the rear doors.

⚠ WARNING

If children are left unsupervised in the vehicle, they can:

- open doors and endanger other persons or road users
- climb out and be injured by the traffic
- operate vehicle equipment and, for example, trap themselves.

Children could also set the vehicle in motion, for example by:

- releasing the parking brake
- shifting the automatic transmission out of park position **P**
- starting the engine.

There is a risk of an accident and injury.

When leaving the vehicle, always take the key with you and lock the vehicle. Never leave children unattended in the vehicle. Always keep the key out of reach of children.

- ▶ Close the right half of the rear door.
- ▶ Close the left half of the rear door.
- ▶ Insert the key into the door lock.
- ▶ Turn the key clockwise. The rear door is locked.

Platform truck dropsides

Important safety notes

⚠ WARNING

When opening the side panel lock, the drop-side may drop downwards. This is particularly the case when it is subjected to a load and is therefore under increased strain. There is a danger of injury.

Before opening, make sure that no persons are in the swinging range of the drop-side. Always open the side panel lock laterally from the drop-side to be opened. Be particularly careful if the side panel latches cannot be released using the normal amount of force.

⚠ WARNING

The rear exterior lighting is concealed when the tailgate is opened. This could cause other road users to fail to recognise the vehicle in time. There is a risk of an accident.

Make sure that the vehicle is safeguarded at the rear in accordance with national legal requirements, e.g. with a warning triangle.

Opening and closing the rear platform dropside



- ▶ **To open:** hold the platform dropside.
- ▶ Firmly push lever ① in the direction of the arrow all the way up until it engages.
- ▶ Repeat the procedure on the other side of the platform dropside.
- ▶ Fold down the platform dropside to an angle of 90°.

To fold down the platform dropside fully, the support cable must be detached.

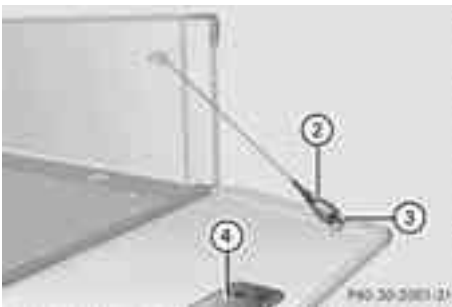

- ▶ **To fold down fully:** raise the platform dropside and unhook snap hook ② on the support cable from eyelet ③.
- ▶ Repeat the procedure on the other side of the platform dropside.
- ▶ Fold the platform dropside down carefully.
- ▶ **i** To improve access to the load surface, fold out step ④.
- ▶ **To close:** fold the platform dropside up and hold it.
- ▶ Hook snap hooks ② into eyelets ③.

- ▶ Close the platform dropside and hold it.
- ▶ Push lever ① down until it engages.
- ▶ Repeat the procedure on the other side of the platform dropside.

Removing and installing platform dropsides

This must be performed by two persons.

- ▶ **To remove a lateral platform dropside:** fold the rear platform dropside forward fully (▷ page 45).
- ▶ Hold the lateral platform dropside.
- ▶ Push the lever at the front of the lateral platform dropside up firmly until it engages.
- ▶ Fold the lateral platform dropside down carefully.

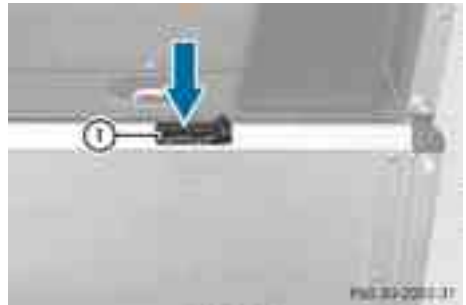

- ▶ Lever yellow locking pawl ① on the lateral platform dropside out of its guide at the recess (arrow) using the screwdriver from the vehicle tool kit.
- ▶ Pull the lateral platform dropside towards the rear off the hinge pins and remove it.
- ▶ **To fit the lateral platform dropside:** carefully position the lateral platform dropside on the hinge pins.
- ▶ Slide the lateral platform dropside forwards.
- ▶ Insert yellow locking pawl ① and fold the lateral platform dropside up.
- ▶ **To remove the rear platform dropside:** remove the lateral platform dropside on the

left-hand side when viewed in the direction of travel.

- ▶ Fold the rear platform dropside forward fully (▷ page 45).
- ▶ Pull the rear platform dropside off the hinge pins towards the left when viewed in the direction of travel and remove it.
- ▶ **To fit the rear platform dropside:** carefully position the rear platform dropside on the hinge pins.
- ▶ Slide the rear platform dropside to the right when viewed in the direction of travel.

Windows

Important safety notes

⚠ WARNING

While opening the side windows, body parts in the closing area could become trapped. There is a risk of injury.

Make sure that no body parts are in close proximity during the closing procedure. If somebody becomes trapped, release the switch or press the switch to open the side window again.

⚠ WARNING

If children are left unsupervised in the vehicle, they can:

- open doors and endanger other persons or road users
- climb out and be injured by the traffic
- operate vehicle equipment and, for example, trap themselves.

Children could also set the vehicle in motion, for example by:

- releasing the parking brake
- shifting the automatic transmission out of park position **P**
- starting the engine.

There is a risk of an accident and injury.

When leaving the vehicle, always take the key with you and lock the vehicle. Never leave

children unattended in the vehicle. Always keep the key out of reach of children.

⚠ WARNING

If children operate the side windows they could become trapped, particularly if they are left unsupervised. There is a risk of injury.

Activate the override feature for the rear side windows. When leaving the vehicle, always take the key with you and lock the vehicle. Never leave children unattended in the vehicle.

Opening and closing the side windows

The side windows can be opened and closed by hand.



Doors on the left

- ▶ **To open:** turn window crank ① clockwise.
- ▶ **To close:** turn window crank ① anti-clockwise.



Doors on the right

- ▶ **To open:** turn window crank ① anti-clockwise.
- ▶ **To close:** turn window crank ① clockwise.

Opening and closing the sliding window

The chassis-cab has a sliding window in the rear wall. It can be opened and closed by hand.



① Handle

- ▶ **To open:** pull on handle ① in the direction of the arrow and slide the sliding window to the desired position.
- ▶ **To close:** slide the sliding window by handle ① forcefully to the right in the direction of travel until the locking mechanism on handle ① engages.

Useful information	50
Correct driver's seat position	50
Seats	50
Mirrors	55

Useful information

i This Owner's Manual describes all models, series and optional equipment for your vehicle that were available at the time of going to press. Country-specific differences are possible. Note that your vehicle may not be fitted with all features described. This is also the case for systems and functions relevant to safety.

i Read the information on qualified specialist workshops: (▷ page 15).

Correct driver's seat position



① Steering wheel

② Seat belts

③ Seat

- ▶ Observe the safety guidelines on seat adjustment (▷ page 50).
- ▶ Make sure that seat ③ is correctly adjusted.

When adjusting the seat, make sure that:

- you are as far away from the driver's airbag as possible.
- you are sitting in a normal upright position.

- you can fasten the seat belt properly.
- you have moved the backrest to an almost vertical position.
- you can depress the pedals properly.

- ▶ Check whether the head restraint is adjusted correctly (▷ page 52).

When doing so, make sure that you have adjusted the head restraint so that the back of your head is supported at eye level by the centre of the head restraint.

- ▶ Observe the safety guidelines for seat belts (▷ page 27).
- ▶ Check whether you have fastened seat belt ② properly (▷ page 29).

The seat belt should:

- fit snugly across your body.
- be routed across the middle of your shoulder.
- be routed in your pelvic area across the hip joints.
- ▶ Before starting off, adjust the rear-view mirror and the exterior mirrors so that you have a good view of road and traffic conditions (▷ page 55).

Seats

Important safety notes

⚠ WARNING

If children adjust the seats, they could become trapped, especially if they are unattended. There is a risk of injury.

When leaving the vehicle, always take the key with you and lock the vehicle. Never leave children unattended in the vehicle.

The seats can still be adjusted when there is no key in the ignition lock.

⚠ WARNING

The head restraints cannot provide the intended protection unless they are fitted and adjusted correctly. There is an increased risk

of injury to the head and neck in the event of an accident or sudden braking, for example. Always drive with the head restraints fitted. Ensure that the centre of the head restraints support the back of each vehicle occupant's head at eye level before driving off.

Observe the following when adjusting the head restraints:

- ▶ Do not interchange the head restraints of the front and rear seats. Otherwise, you cannot adjust the height and angle of the head restraints correctly.
- ▶ Adjust the head restraint so that it is as close as possible to your head.

WARNING

If the driver's seat is not engaged, it can move unexpectedly while the vehicle is in motion. This could cause you to lose control of the vehicle. There is a risk of an accident.

Always make sure that the driver's seat is engaged before starting the engine.

WARNING

When adjusting a seat, you or another vehicle occupant could become trapped by the guide rail of the seat, for instance. There is a risk of injury.

Make sure that no one has any part of their body within the sweep of the seat when adjusting it.

WARNING

If the seat belt is not in the seat belt guide, it no longer offers the intended level of protection. An incorrectly fastened seat belt can also cause additional injuries. This poses an increased risk of injury or even fatal injury.

Before starting a journey, always make sure that the seat belt is in the seat belt guide and all vehicle occupants have fastened their seat belts properly.

 To avoid damage to the seats and the seat heating, observe the following information:

- do not spill any liquids on the seats. If liquid is spilled on the seats, dry them as soon as possible.
- if the seat covers are damp or wet, do not switch on the seat heating. The seat heating should also not be used to dry the seats.
- clean the seat covers as recommended; see the "Interior care" section.
- do not transport heavy loads on the seats. Do not place sharp objects on the seat cushions, e.g. knives, nails or tools. The seats should only be occupied by passengers, if possible.
- when the seat heating is in operation, do not cover the seats with insulating materials, e.g. blankets, coats, bags, seat covers, child seats or booster seats.

 Make sure that there are no objects in the footwell or behind the seats when moving the seat back. There is a risk that the seats and/or the objects could be damaged.

 The head restraints can be removed (▷ page 53).

For more information, contact a qualified specialist workshop.

 You can find further information about enlarging the luggage compartment (folding the rear bench seat forwards) on (▷ page 131).

Adjusting the seats

 Make sure that there are no objects in the footwell or behind the seats when moving the seat back. There is a risk that the seats and/or the objects could be damaged.

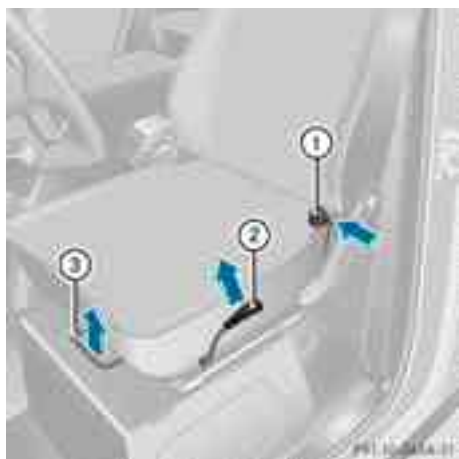

Example: front seat

- ▶ **To set the seat fore-and-aft adjustment:** pull bar ③ in the direction of the arrow.
- ▶ **To adjust the backrest angle:** push lever ① in the direction of the arrow.
- ▶ **To adjust the seat height:** pull lever ② up in the direction of the arrow and apply or remove weight to the seat as appropriate.

Adjusting the head restraints

Important safety notes

WARNING

The head restraints cannot provide the intended protection unless they are fitted and adjusted correctly. There is an increased risk of injury to the head and neck in the event of an accident or sudden braking, for example. Always drive with the head restraints fitted. Ensure that the centre of the head restraints support the back of each vehicle occupant's head at eye level before driving off.

Observe the following when adjusting the head restraints:

- ▶ Do not interchange the head restraints of the front and rear seats. Otherwise, you cannot adjust the height and angle of the head restraints correctly.
- ▶ Adjust the head restraint so that it is as close as possible to your head.

Adjusting the head restraints



Adjust the head restraint height and angle manually.

- ▶ **To raise:** pull the head restraint up to the desired height.
- ▶ **To lower:** push the head restraint down until it is in the desired position.
- ▶ **To adjust the angle:** pull the head restraint forwards or backwards until it is in the desired position.

Adjusting chassis-cab head restraints



Adjust the height of the head restraints manually.

- ▶ **To raise:** pull the head restraint up to the desired height.
- ▶ **To lower:** push the head restraint down until it is in the desired position.

Removing and fitting the head restraints



Example: front head restraints

- ① To make it easier to remove and fit head restraints:
 - tilt the front seat backrest back slightly.
 - fold the rear seat backrest forwards slightly (▷ page 131).
- ▶ **To remove:** pull the head restraint up and out.
- ▶ **To fit:** insert the head restraints.
- ① Make sure that you insert the head restraints facing in the correct direction.
- ▶ Push the head restraint down until you hear it engage in position.
- ▶ Adjust the height and angle of the head restraints manually.

Folding the folding seat forward

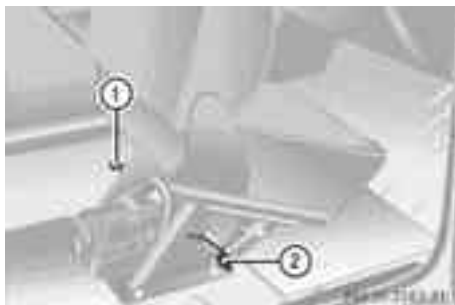

Example: folding the folding seat forwards

The folding seat has two release handles. The folding seat can be folded forward from the rear compartment or from the side.

Front release handle

- ▶ Open the front door.
- ▶ **To fold forward:** pull release handle ② up and fold the seat forwards.
- ▶ **To fold back:** push the seat back until it audibly engages.

Rear release handle

- ▶ Get into the rear compartment.
- ▶ **To fold forward:** pull release handle ① down and fold the seat forwards.
- ▶ **To fold back:** pull the seat back until it audibly engages.

Switching the seat heating on/off

General notes

The buttons for the front seat heating are located on the control panel.

The red indicator lamps in the button indicate the heating level you have selected.

- ▶ Make sure the key is in position 2 in the ignition lock.

- ① If the battery voltage is too low, the seat heating may switch off.

One or both indicator lamps will flash. Once there is sufficient battery voltage again, the seat heating switches on automatically.

Front-seat heating

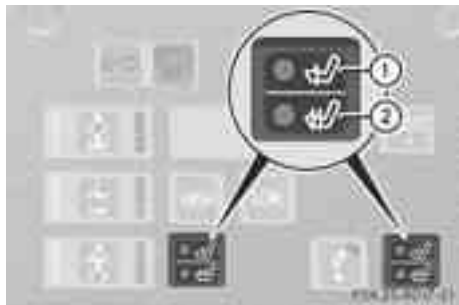

Example: buttons in the control panel

- ▶ **To select level 1:** press the button once. The seat is heated normally. Indicator lamp ① lights up.
- ▶ **To select level 2:** press the button twice. The seat is heated rapidly. Indicator lamps ① and ② light up.
- ❗ The system automatically switches down from level 2 to level 1 after approximately five minutes. The system automatically switches off approximately 30 minutes after it is set to level 1.
- ▶ **To switch off:** press the button repeatedly until all the indicator lamps go out.

Problems with the seat heating

If one or all of the indicator lamps in the seat heating button are flashing, the seat heating has switched off automatically. The vehicle's electrical system voltage is too low because too many electrical consumers are switched on.

- ▶ Switch off electrical consumers which you do not need, such as the rear window heating or interior lighting. Once the battery is sufficiently charged, the seat heating will switch back on automatically.

Side-facing bench seat in the luggage compartment (vehicles with a 24 V electrical system)

⚠ WARNING

Make sure that nobody can become trapped when folding down the side-facing bench seat.

Side-facing bench seats may only be occupied when the rear bench seat is upright and the seat catch is engaged.

The rear bench seat head restraints must be fitted.



- ▶ **To fold down:** detach hooks ② of fastening straps ① from eyelets ③ behind the seat backrest.
- ▶ Attach hooks ② to eyelets ③ on the underside of side-facing bench seat ④.



- ▶ Fold out support ⑤.
- ▶ Fold down side-facing bench seat ④.



- ▶ Make sure that support ⑤ lies on wheel arch ⑥.
- ▶ **To fold up:** fold up side-facing bench seat ④.
- ▶ Fold support ⑤ in until it sits completely against side-facing bench seat ④.
- ▶ Attach hooks ② of fastening straps ① to eyelets ③ behind the seat backrest.

Mirrors

Rear-view mirror

- ▶ Adjust the rear-view mirror by hand so you have a good overview of the traffic conditions behind you.

Exterior mirrors

Adjusting the exterior mirrors manually

- ▶ Adjust the exterior mirrors in such a way that you can get a good overview of road and traffic conditions.

Adjusting the exterior mirrors electrically

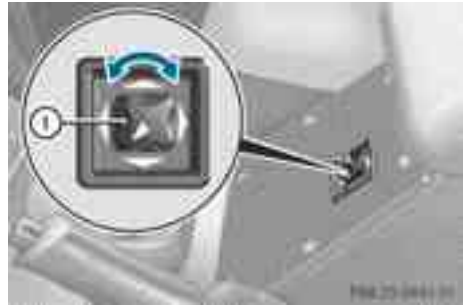

- ▶ Make sure the key is in position 2 in the ignition lock.
- ▶ Turn adjustment switch ① to the right for the right exterior mirror or to the left for the left exterior mirror.
- ▶ Press adjustment control ① up, down, or to the left or right until you have adjusted the exterior mirror to the correct position. You should have a good overview of traffic conditions.

Useful information	58
Exterior lighting	58
Interior lighting	62
Replacing bulbs	63
Windscreen wipers	73

Useful information

i This Owner's Manual describes all models, series and optional equipment for your vehicle that were available at the time of going to press. Country-specific differences are possible. Note that your vehicle may not be fitted with all features described. This is also the case for systems and functions relevant to safety.

i Read the information on qualified specialist workshops: (▷ page 15).

Exterior lighting

Important safety notes

For reasons of safety, Mercedes-Benz recommends that you drive with the lights switched on even during the daytime. In some countries, operation of the headlamps varies due to legal requirements and self-imposed obligations.

Driving abroad

Converting to symmetrical dipped beam

If your journey takes you to countries where vehicles are driven on the opposite side of the road to the country in which the vehicle is registered, your headlamps must be switched to symmetrical dipped beam. This prevents oncoming traffic from being dazzled. Symmetrical lights do not illuminate as large an area of the edge of the carriageway.

Have the headlamps converted at a qualified specialist workshop as close to the border as possible before driving in these countries.

Converting to asymmetrical dipped beam after returning

Have the headlamps converted back to asymmetrical dipped-beam headlamps at a qualified specialist workshop as soon as possible after crossing the border again.

Light switch

Operation

! Switch off the side lamps and dipped-beam headlamps when you leave the vehicle. This prevents the battery from discharging.

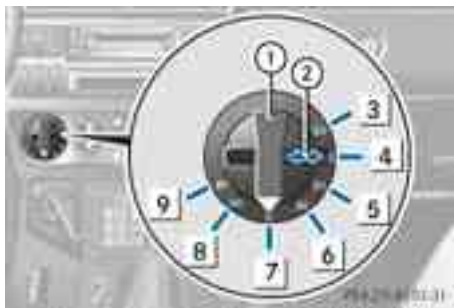

- ① Light switch
- ② Slider lock
- 3 **S3** Blackout lighting setting **S3**⁴
- 4 **S2** Blackout lighting setting **S2**⁴
- 5 **S1** Blackout lighting setting **S1**⁴
- 6 **S0** Blackout lighting setting **S0**⁴
- 7 **0** Lights off/daytime driving lights
- 8 Side lamps, licence plate and instrument cluster lighting
- 9 Dipped-beam headlamps

► Turn the light switch to **0**.

The turn signals, main-beam headlamps and the headlamp flasher are operated using the combination switch (▷ page 60).



⁴ Not for vehicles with a 12 V on-board electrical system.

Slider lock

Slider lock ② on light switch ① prevents you from switching from normal lights to blackout lighting unintentionally.

- ▶ **To switch the slider lock position:** press light switch ① and move slider lock ② to the desired position:
 - normal light functions to the right
 - blackout lighting setting to the left

Dipped-beam headlamps





- ▶ Turn the key to position **2** in the ignition lock.
- ▶ Make sure that slider lock ② has been moved to the right.
- ▶ **To switch on the dipped-beam headlamps:** turn light switch ① to . The dipped-beam or main-beam headlamps (▷ page 60) are switched on.
- ▶ **To switch on the side lamps:** turn light switch ① to . The side lamps, tail lamps, instrument cluster lighting and licence plate lighting are switched on.
- ▶ **To switch off the dipped-beam headlamps/side lamps:** turn light switch ① to .
- i** A warning tone sounds if you remove the key from the ignition lock and open the driver's door while the side lamps or dipped-beam headlamps are switched on.

Daytime driving lights

Starting the engine also switches on the daytime driving lights.

- ▶ **To switch on:** turn light switch ① to . When the engine is running: the dipped-beam headlamps, side lamps and licence plate lamp are switched on.



Blackout lighting (vehicles with a 24 V electrical system)

- i** Please note that functions such as the differential lock can also be active when a certain blackout lighting setting has been selected.
- ▶ Make sure that slider lock ② has been moved to the left.
- ▶ **Blackout lighting setting S0:** turn light switch ① to . Complete blackout. The entire vehicle lighting and the horn are switched off.
- ▶ **Blackout lighting setting S1:** turn light switch ① to . Blackout lighting, rear-facing only. The crosshair is switched on. The blackout brake lamp is ready for operation.
- ▶ **Blackout lighting setting S2:** turn light switch ① to . Blackout lighting, front-facing only. The blackout headlamps are switched on.
- ▶ **Blackout lighting setting S3:** turn light switch ① to . Blackout lighting, front and rear-facing. The blackout headlamps, blackout rear lamps and crosshair are switched on. The blackout brake lamp is ready for operation.
- i** The following functions are switched off in all blackout lighting settings:
 - turn signals, hazard warning lamps
 - horn
 - interior lighting
 - switch/button lighting
 - instrument cluster lighting
- ▶ **To switch off blackout lighting:** press light switch ① in and turn it to .



Combination switch

Turn signals



- ▶ Make sure that the key is in position **2** in the ignition lock.
- ▶ **To switch on:** press the combination switch in the direction of arrow **②** or **④** until it engages. The corresponding  or  indicator lamp in the instrument cluster flashes.

Main-beam headlamps

- ▶ **To switch on the main-beam headlamps:** turn the key in the ignition lock to position **2** or start the engine.
- ▶ Turn the light switch to .
- ▶ Press the combination switch beyond the pressure point in the direction of arrow **①**. The  indicator lamp in the instrument cluster lights up.
- ▶ **To switch off the main-beam headlamps:** move the combination switch back to its normal position. The  indicator lamp in the instrument cluster goes out.

Headlamp flasher

- ▶ **To switch on:** turn the key in the ignition lock to position **1** or **2**, or start the engine.
- ▶ Pull the combination switch briefly in the direction of arrow **③**.





Front foglamps and rear foglamp

Foglamps

WARNING





If you suspect that driving conditions will be foggy, turn the light switch to  before you start your journey. Your vehicle may otherwise not be visible and you could endanger yourself and others.



- ▶ Make sure that the  dipped-beam headlamps or  side lamps are switched on (▷ page 59).
- ▶ **To switch on:** press the upper section of the switch. The  indicator lamp in the control panel of the centre console lights up.
- ▶ **To switch off:** press the lower section of the switch. Indicator lamp  goes out.

Rear foglamp



- ▶ Make sure that the  dipped-beam headlamps (▷ page 59) or the  fog-lamp (▷ page 60) is switched on.
- ▶ **To switch on:** press the upper section of the switch.
The  indicator lamp in the instrument cluster lights up.
- ▶ **To switch off:** press the lower section of the switch.
Indicator lamp  goes out.

Adjusting the headlamp range

- ! The permissible load depends on the respective vehicle body type.

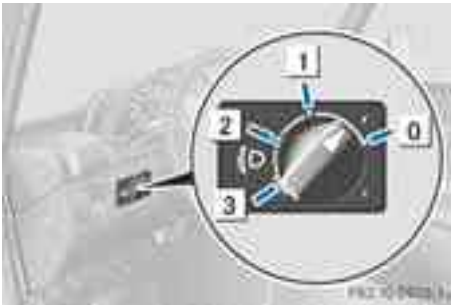

Headlamp range control

The headlamp range control allows you to adjust the cone of light from the headlamps to suit the vehicle load.

- ▶ Turn the headlamp range control to the corresponding position.
- i The luggage compartment or the load area may only be loaded to the maximum load. The permissible rear axle load must not be exceeded (▷ page 201).

Panel van, chassis cab

- 0 Front seats occupied
- 1 Front seats occupied, load in luggage compartment/on load area
- 2 Driver's seat occupied, load in luggage compartment/on load area

Station wagon

- 0 Front seats occupied
- 1 Front seats and rear bench seat occupied
- 2 Front seats and rear bench seat occupied, load in luggage compartment
- 3 Driver's seat occupied, load in the luggage compartment

Headlamp cleaning system

- ▶ Turn the ignition key to position 2 in the ignition lock or start the engine.
- ▶ **To switch on:** activate the "Wipe with washer fluid" function (▷ page 73).
The headlamps are cleaned with a high-pressure water jet.

Hazard warning lamps

Switching on and off



- ▶ Make sure that the battery main switch is switched on.
- ▶ **To switch on:** press the lower section of the switch.
All turn signals flash.
- ▶ **To switch off:** press the upper section of the switch.
- i The hazard warning lamps still operate if the ignition is switched off. The hazard warning lamp does not work, however, if a blackout lighting setting has been selected (▷ page 59).

Problems with the hazard warning lamps

The hazard warning lamps are not functioning because the battery main switch is switched off.

- ▶ Switch on the battery main switch (▷ page 87).

Headlamps and turn signals misted up on the inside

The headlamps may mist up on the inside if there is high atmospheric humidity.

- ▶ Drive with the headlamps switched on. The level of moisture diminishes, depending on the length of the journey and the weather conditions (humidity and temperature).

If the level of moisture does not diminish:

- ▶ Have the headlamps checked at a qualified specialist workshop.

Interior lighting

Overview of interior lighting



- 1 To switch on the interior lighting manually
- 2 To switch off the interior lighting manually
- 3 To switch on the interior lighting automatically

One interior light is located above the rear-view mirror and one in the luggage compart-

ment on the roof lining. The switch is located in the lamp.

Interior lighting control

General notes

The interior lighting functions are automatically deactivated after some time except for when the key is in position **2** in the ignition lock. This prevents your vehicle's battery from discharging.

Automatic control

- ▶ **To switch on:** slide the switch to position **3**.

The interior lighting switches on when you open a door.

When a front or rear door is opened, the front interior lighting comes on. When the tailgate is opened, the rear interior lighting comes on.

Manual control

- ▶ **To switch on:** slide the switch to position **1**.

The interior lighting remains switched on, even when the doors are shut.

- ▶ **To switch off:** slide the switch to position **2**.

Reading lamp



Reading lamp

- ▶ Remove the reading lamp from the glove compartment.
 - ▶ Plug the reading lamp into the 12 V socket.
 - ▶ **To switch on:** turn control knob ③ to position ②.
 - ▶ **To switch off:** turn control knob ③ to position ①.
- i** The 12 V socket also functions if blackout lighting is switched on. You can continue to use the reading lamp.

Replacing bulbs

Important safety notes

Notes on replacing bulbs

WARNING

Bulbs, lamps and plug connectors can become very hot during use. When replacing a bulb, you could burn yourself on these components. There is a risk of injury.

Allow these components to cool down before replacing the bulb.

Only operate bulbs in enclosed lamps designed for that purpose. Only fit spare bulbs of the same type and the specified voltage.

Protect bulbs from moisture during operation and do not allow bulbs to come into contact with fluids.

A bulb may explode if:

- it is dropped
- there are scratches on the glass tube
- you touch the hot glass tube

Do not touch the glass tube of new bulbs with your bare hands. Even minor contamination can burn into the glass surface and reduce the service life of the bulbs. Always use a lint-free cloth or only touch the base of the bulb when fitting.

Bulbs and lamps are an important aspect of vehicle safety. You must therefore make sure

that these function correctly at all times. Have the headlamp setting checked regularly. If the bulb does not light up or if you require assistance replacing bulbs, consult a qualified specialist workshop.

Before changing bulbs

Have the following bulbs changed at a qualified specialist workshop:

- third brake lamp
- blackout tail lamp

You can replace the following bulbs:

- side lamps
- main-beam/dipped-beam headlamps
- foglamps
- turn signal lamp (front)
- additional turn signal lamp
- blackout lighting
- brake lamp
- turn signal lamp (rear)
- reversing lamp
- blackout brake lamp
- rear foglamp
- licence plate lamp
- outline lamp

Overview of bulb replacement – bulbs

Front bulbs



Example: station wagon

- ① Additional turn signal lamp:
Chassis cab: P 21 W
All other vehicles: W 4 W
- ② Turn signal lamp: PY 21 W
- ③ Headlamp:
Main-beam/dipped-beam: H4 60/55 W
Side lamp: W 4 W
- ④ Foglamp: H3 55 W
- ⑤ Blackout lighting: P 18 W⁵

Rear bulbs



Example: station wagon

- ① Tail lamp:
Brake lamp: P 21 W
Turn signal lamp: PY 21 W
Tail lamp: W 5 W
Blackout tail lamp: P 2 W^{5, 6}

- ② Reversing lamp: P 21 W
- ③ Blackout brake lamp: P 2 W⁵
- ④ Rear foglamp: P 21 W
- ⑤ Third brake lamp: LEDs⁶
- ⑥ Licence plate lamp:
Long-wheelbase panel van/station wagon: W 10 W



6x6 chassis cab with crewcab

- ① Licence plate lamp: W 10 W
- ② Rear foglamp: P 21 W
- ③ Blackout brake lamp: LED⁶
- ④ Reversing lamp: P 21 W
- ⑤ Tail lamp:
Brake lamp: P 21 W
Turn signal lamp: PY 21 W
Tail lamp: W 5 W
Blackout tail lamp: P 2 W⁶
- ⑥ Convoy light: H 2 W

⁵ Not for vehicles with a 12 V electrical system.

⁶ Have these bulbs changed at a qualified specialist workshop only.

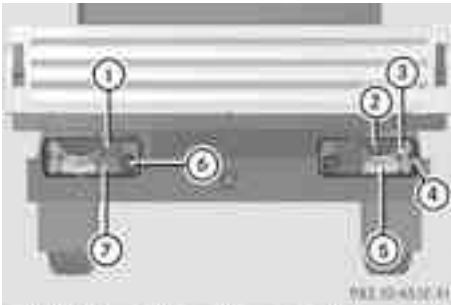

Example: chassis cab with 12 V electrical system, platform truck

- ① Tail lamp: R 5 W
- ② Brake lamp: P 21 W
- ③ Turn signal lamp: PY 21 W
- ④ Outline lamp: R 5 W
- ⑤ Reversing lamp: P 21 W
- ⑥ Rear foglamp: P 21 W
- ⑦ Licence plate lamp: R 5 W

In the chassis cab with a 24 V electrical system, the rear bulbs are installed in the bumper.

Replacing the front bulbs

Removing the headlamps

- ❗ For vehicles with a bodystyling bar, contact a qualified specialist workshop (▷ page 15).
- ▶ Switch off the lights.



Turning the front foglamp to the side

- ▶ Turn front foglamp ① in the direction of the arrow.



- ▶ Remove bolt ③.
- ▶ Remove front panel ② upwards.



- ▶ Unscrew screws ④.
- ❗ Only remove screws ④. Do not turn adjustment screws ⑤. If one adjustment screw ⑤ is turned, the front foglamp adjustment must be checked at a qualified specialist workshop.
- ▶ Remove headlamp ①.

Main-beam/dipped-beam headlamps

- ▶ Remove the headlamp (▷ page 65).



- ▶ Remove protective cap ①.
- ▶ Pull out connector ②.

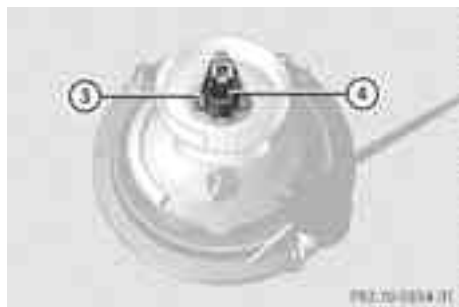

- ▶ Unclip retaining spring ③.
- ▶ Remove bulb ④.
- ▶ Insert the new bulb so that the base fits flush in the recess.
- ▶ Clip retaining spring ③ back in.
- ▶ Attach connector ② to the new bulb.
- ▶ Press on protective cap ①.

Side lamps

- ▶ Remove the headlamp (> page 65).

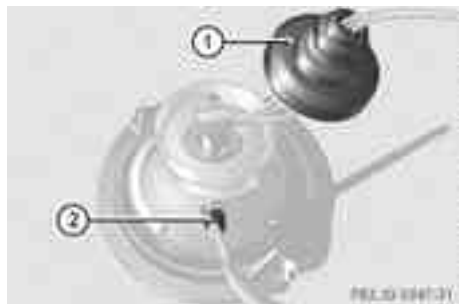

- ▶ Remove protective cap ①.
- ▶ Pull out connector ②.

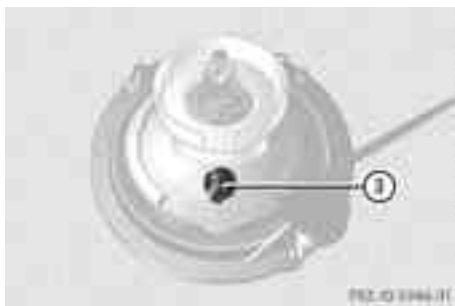

- ▶ Turn bulb ③ anti-clockwise, applying slight pressure, and remove it.
- ▶ Insert the new bulb and turn it clockwise, applying slight pressure, until it engages.
- ▶ Attach connector ② to the new bulb.
- ▶ Press on protective cap ①.

Front foglamps



- ▶ Switch off the lights.
- ▶ Unscrew screws ②.
- ▶ Remove front foglamp ① in the direction of the arrow.



- ▶ Pull out connector ③ and housing connector ④.
- ▶ Unclip retaining spring ⑤.
- ▶ Pull out the bulb.
- ▶ Insert the new bulb so that the base fits flush in the recess.
- ▶ Clip retaining spring ⑤ back in.
- ▶ Attach connector ③ and housing connector ④ to the new bulb.
- ▶ Reinsert front fog lamp ①.
- ▶ Replace and tighten screws ②.

Blackout lighting (vehicles with a 24 V electrical system)

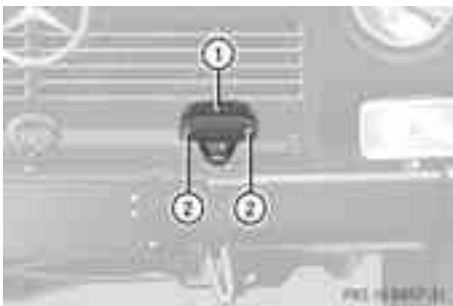

- ▶ Switch off the lights.
- ▶ Unscrew screws ②.
- ▶ Pull the lamp with cover ① forward out of the recess.

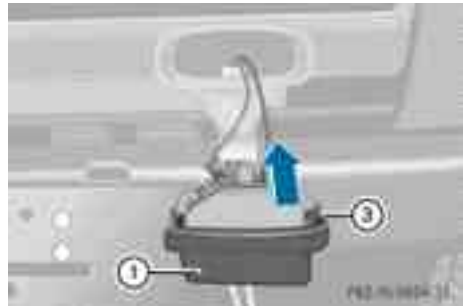

- ▶ Pull seal ③ off cover ①.



- ▶ Turn bulb ④ anti-clockwise, applying slight pressure, and remove it from the bulb holder.
- ▶ Insert the new bulb into the bulb holder and turn it clockwise until it engages.
- ▶ Clamp seal ③ on cover ①.
- ▶ Insert the lamp with cover ① and press in firmly. Seal ③ must fit tightly around the circumference.
- ▶ Replace and tighten screws ②.

Turn signals

- ▶ **!** Do not fasten the screws too tightly. You could otherwise damage the lens.

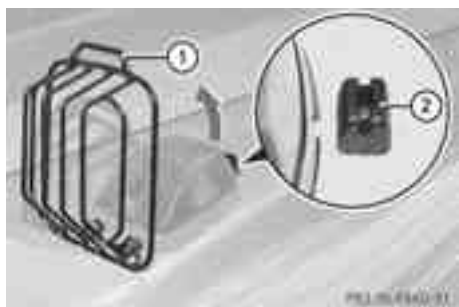

Example: turn signal lamp with protection grille

- ▶ Switch off the lights.
- ▶ Pull protection grille (1) in the direction of the arrow out of mounting (2).
- ▶ Fold up protection grille (1).

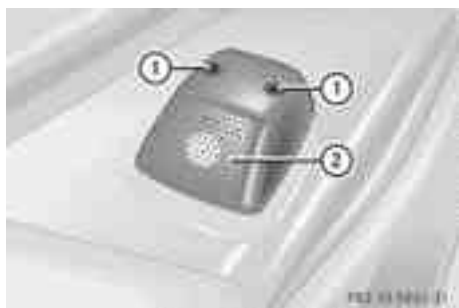

- ▶ Switch off the lights.
- ▶ Unscrew screws (1).
- ▶ Remove lens (2).



- ▶ Turn bulb (3) anti-clockwise, applying slight pressure, and remove it from the bulb holder.
- ▶ Insert the new bulb into the bulb holder and turn it clockwise until it engages.
- ▶ Fit lens (2).
- ▶ Replace and tighten screws (1).
- ▶ Fold down protective grid (1) and engage it in anchorage (2).

Additional turn signal lamp

Chassis cab

- ⚠ When fitting the lens, make sure that the seal is positioned correctly.
- ⚠ Do not fasten the screws too tightly. You could otherwise damage the lens.



Example: chassis cab

- ▶ Switch off the lights.
- ▶ Unscrew screws (1).
- ▶ Remove lens (2).



- ▶ Hold lens ② firmly and remove bulb holder ③.
- ▶ Turn bulb ④ anti-clockwise, applying slight pressure, and remove it from bulb holder ③.
- ▶ Insert the new bulb into bulb holder ③ and, applying slight pressure, turn it clockwise until it engages.
- ▶ Insert bulb holder ③ into lens ②.
- ▶ Fit lens ②.
- ▶ Replace and tighten screws ①.

All other vehicles

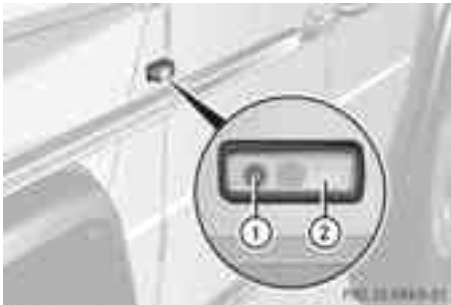

- ▶ Switch off the lights.
- ▶ Remove bolt ①.
- ▶ Pull the indicator lamp out by lens ②.

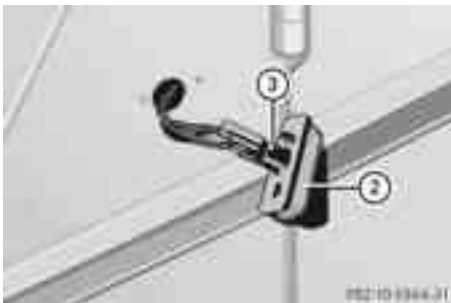

- ▶ Hold lens ② firmly and remove bulb holder ③.



- ▶ Pull bulb ④ out of bulb holder ③.
- ▶ Insert the new bulb into bulb holder ③, applying slight pressure so that it sits firmly.
- ▶ Insert bulb holder ③ into lens ②.
- ▶ Fit lens ② with the indicator lamp.
- ▶ Screw in bolt ①.

Replacing rear bulbs⁷

Tail lamps

- ❗ The blackout tail lamp can only be replaced at a qualified specialist workshop.
- ❗ When fitting the lens, make sure that the seal is positioned correctly.
- ❗ Do not fasten the screws too tightly. You could otherwise damage the lens.

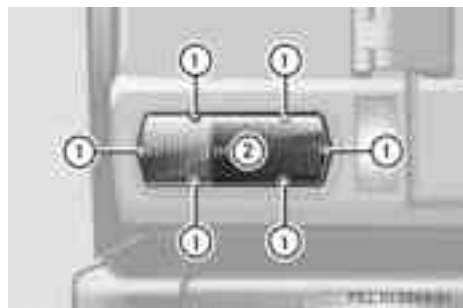

Example: station wagon

⁷ All vehicles except chassis-cab with 12 V electrical system.

- ▶ Switch off the lights.
- ▶ Unscrew screws ①.
- ▶ Remove lens ②.



Example: station wagon

- ③ Turn signals
- ④ Blackout tail lamp
- ⑤ Tail lamp
- ⑥ Brake lamp

- ▶ Turn the corresponding bulb anti-clockwise, applying slight pressure, and remove it from the bulb holder.
- ▶ Insert the new bulb into the bulb holder and turn it clockwise until it engages.
- ▶ Fit lens ②.
- ▶ Replace and tighten screws ①.

Reversing lamp/rear foglamp

- ❗ Do not fasten the screws too tightly. You could otherwise damage the lens.



Example: station wagon

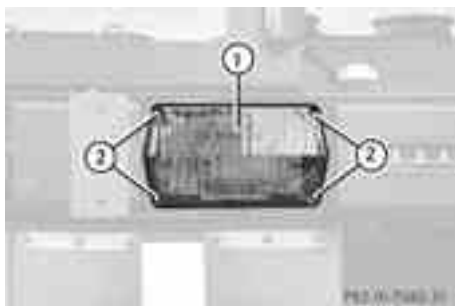

6x6 chassis cab with crewcab

- ▶ Switch off the lights.
- ▶ Unscrew screws ②.
- ▶ Remove lens ①.



Station wagon



6x6 chassis cab with crewcab

- ▶ Turn bulb ③ anti-clockwise, applying slight pressure, and remove it from the bulb holder.
- ▶ Insert the new bulb into the bulb holder and turn it clockwise until it engages.
- ▶ Fit lens ①.
- ▶ Replace and tighten screws ②.

Blackout brake lamp



- ▶ Switch off the lights.
- ▶ Unscrew screws ①.



- ▶ Carefully remove the blackout brake lamp housing from the bumper.



- ▶ Unscrew screws ②.
- ▶ Remove cover ③.

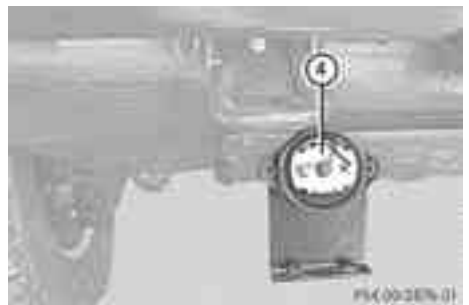

- ▶ Turn bulb ④ anti-clockwise, applying slight pressure, and remove it from the bulb holder.
- ▶ Insert the new bulb into the bulb holder and turn it clockwise until it engages.
- ▶ Replace cover ③.

- ▶ Replace and tighten screws ②.
- ▶ Insert the assembled blackout brake lamp housing into the bumper.
- ▶ Replace and tighten screws ①.
- ▶ Check that the installation has been performed correctly.

Convoy marking lighting

6x6 chassis cab with crewcab

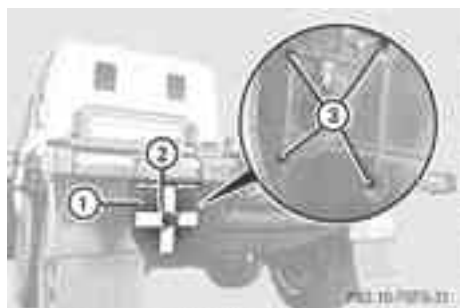

Removing the protective bar:

- ▶ At the rear of convoy marking ①, unscrew nuts ③ anti-clockwise.



- ▶ Remove protective bar ② in the direction of the arrow.
- ▶ Unscrew screws ④.
- ▶ Remove cover ⑤.
- ▶ Turn the bulb anti-clockwise, applying slight pressure, and remove it from the bulb holder.

- ▶ Insert the new bulb into the bulb holder and, applying slight pressure, turn it clockwise until it engages.
- ▶ Position cover ⑤ and secure with screws ④.
- ▶ Position protective bar ② and secure with nuts ③.

Licence plate lighting

Station wagon/panel van

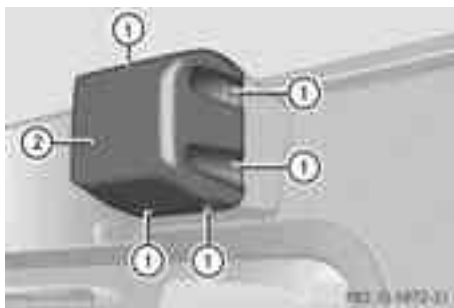

Example: licence plate lighting

- ▶ Switch off the lights.
- ▶ Unscrew screws ①.
- ▶ Remove outer cover ②.

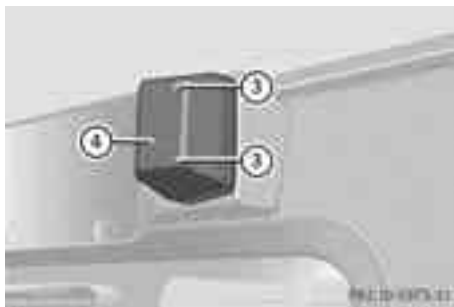

- ▶ Unscrew screws ③.
- ▶ Remove inner cover ④.
- ▶ Turn the bulb anti-clockwise, applying slight pressure, and remove it from the bulb holder.
- ▶ Insert the new bulb into the bulb holder and turn it clockwise until it engages.

- ▶ Fasten inner cover (4) with screws (3).
- ▶ Fasten outer cover (2) with screws (1).

6x6 chassis cab with crewcab

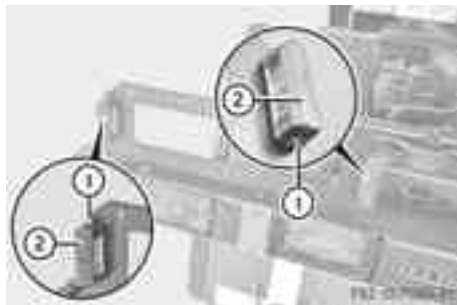

- ▶ Switch off the lights.
- ▶ Remove bolt (1).

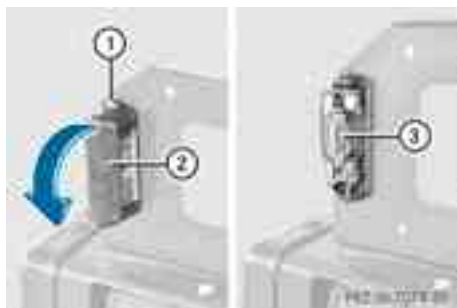

- ▶ Remove cover (2).
- ▶ Pull bulb (3) out of the bulb holder.
- ▶ Insert new bulb (3) into the bulb holder.
- ▶ Secure cover (2) with bolt (1).

Replacing rear bulbs (chassis-cab with 12 V electrical system)

- ❗ When fitting the lens, make sure that the seal is positioned correctly.
- ❗ Do not fasten the screws too tightly. You could otherwise damage the lens.

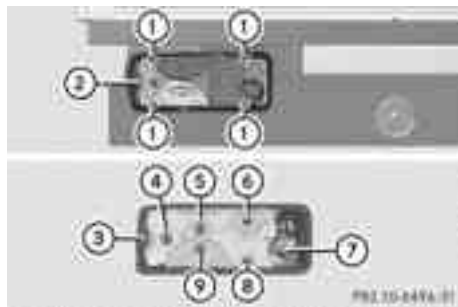

- ① Screws
- ② Lens
- ③ Outline lamp
- ④ Turn signals
- ⑤ Brake lamp
- ⑥ Tail lamp
- ⑦ Rear foglamp
- ⑧ Licence plate lamp
- ⑨ Reversing lamp
- ▶ Switch off the lights.
- ▶ Unscrew screws (1).
- ▶ Remove lens (2).
- ▶ Turn the corresponding bulb anti-clockwise, applying slight pressure, and remove it from the bulb holder.
- ▶ Insert the new bulb into the bulb holder and turn it clockwise until it engages.
- ▶ Fit lens (2).
- ▶ Replace and tighten screws (1).

Windscreen wipers

Switching the windscreen wipers on/off

- ❗ Do not operate the windscreen wipers when the windscreen/rear window is dry, as this could damage the wiper blades. Moreover, dust that has collected on the windscreen/rear window can scratch the glass if wiping takes place when the windscreen/rear window is dry.

If it is necessary to operate the windscreen wipers/rear window wiper in dry weather conditions, always use washer fluid.

! If the windscreen wipers leave smears on the windscreen/rear window after the vehicle has been washed in an automatic car wash, this may be due to wax or other residue. Clean the windscreen/rear window with washer fluid after an automatic car wash.

If the wiper blades are worn, the windscreen will no longer be wiped properly. This could prevent you from observing the traffic conditions, thereby causing an accident. Replace the wiper blades twice a year, ideally in spring and autumn.

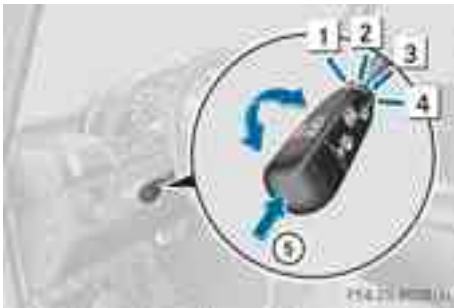

Combination switch

- 1 Continuous wipe, fast
- 2 Continuous wipe, slow
- 3 Intermittent wiping
- 4 Windscreen wipers off
- 5 Single wipe/ to wipe the windscreen using washer fluid

Switching the rear window wiper on/off

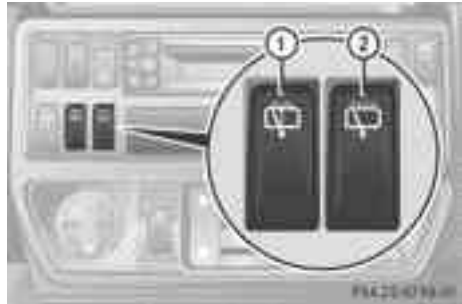

Station wagons and panel vans only

- ▶ Turn the key to position **1** or **2** in the ignition lock.
- ▶ **To switch on intermittent wiping:** press the upper section of switch **2**.
- ▶ **To switch off intermittent wiping:** move switch **2** to the centre position.
- ▶ **To switch off continuous wipe:** press the lower section of switch **2**.
- ▶ **To switch off continuous wipe:** move switch **2** to the centre position.
- ▶ **Wiping with washer fluid:** press and hold the upper section of switch **1** until the rear window is clean.

The rear window is wiped for a further five seconds after the switch is released.

Replacing the wiper blades

Important safety notes

WARNING

If the windscreen wipers begin to move while you are changing the wiper blades, you can be trapped by the wiper arm. There is a risk of injury.

Always switch off the windscreen wipers and ignition before changing the wiper blades.

- !** To avoid damaging the windscreen wiper blades, make sure that you touch only the wiper arm of the windscreen wiper.

! Never open the bonnet if a windscreen wiper arm has been folded away from the windscreen.

Never fold a windscreen wiper arm without a wiper blade back onto the windscreen/rear window.

Hold the windscreen wiper arm firmly when you change the wiper blade. If you release the windscreen wiper arm without a wiper blade and it falls onto the windscreen, the windscreen may be damaged by the force of the impact.

Mercedes-Benz recommends that you have the wiper blades changed at a qualified specialist workshop.

Removing the wiper blade

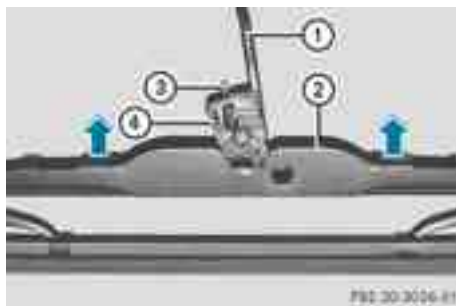

- ① Wiper arm
- ② Wiper blade
- ③ Locking spring
- ④ Hinge piece

- ▶ Remove the key from the ignition lock.
- ▶ Fold wiper arm ① away from the windscreen until it engages.
- ▶ Position wiper blade ② at right angles.
- ▶ Press locking spring ③.
- ▶ Slide wiper blade ② with hinge piece ④ from wiper arm ①.

Fitting the wiper blade

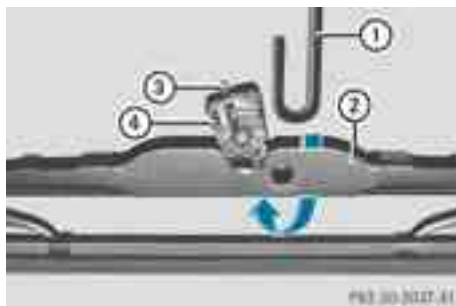

- ① Wiper arm
- ② Wiper blade
- ③ Locking spring
- ④ Hinge piece

- ▶ Slide wiper arm ① into new wiper blade ② with hinge piece ④.
- ▶ Engage locking spring ③ into the end of the wiper arm.
- ▶ Make sure that wiper blade ② is seated correctly.
- ▶ Fold wiper arm ① back onto the windscreen.

Problems with the windscreen wipers

The windscreen wipers are obstructed

Leaves or snow, for example, may be obstructing the windscreen wiper movement. The wiper motor has been deactivated.

- ▶ For safety reasons, you should remove the key from the ignition lock.
- ▶ Remove the cause of the obstruction.
- ▶ Switch the windscreen wipers back on.

The windscreen wipers are inoperative

The windscreen wiper drive is malfunctioning.

- ▶ Select another wiper speed on the combination switch.
- ▶ Have the windscreen wipers checked at a qualified specialist workshop.

Useful information	78
Heating/air-conditioning system overview	78
Heating and air-conditioning sys- tem controls	79
Adjusting the air vents	83

Useful information

- i** This Owner's Manual describes all models, series and optional equipment for your vehicle that were available at the time of going to press. Country-specific differences are possible. Note that your vehicle may not be fitted with all features described. This is also the case for systems and functions relevant to safety.
- i** Read the information on qualified specialist workshops: (▷ page 15).

Heating/air-conditioning system overview

Important safety notes

Observe the settings recommended on the following pages. The windows could otherwise mist up. This could prevent you from observing the traffic conditions, thereby causing an accident.

The heating and air-conditioning system heats or cools the vehicle interior.

The heating and air-conditioning system can be operated when the engine is running.

- i** Ventilate the vehicle for a brief period during warm weather. This will accelerate the cooling process.

Heating/air-conditioning system control panel

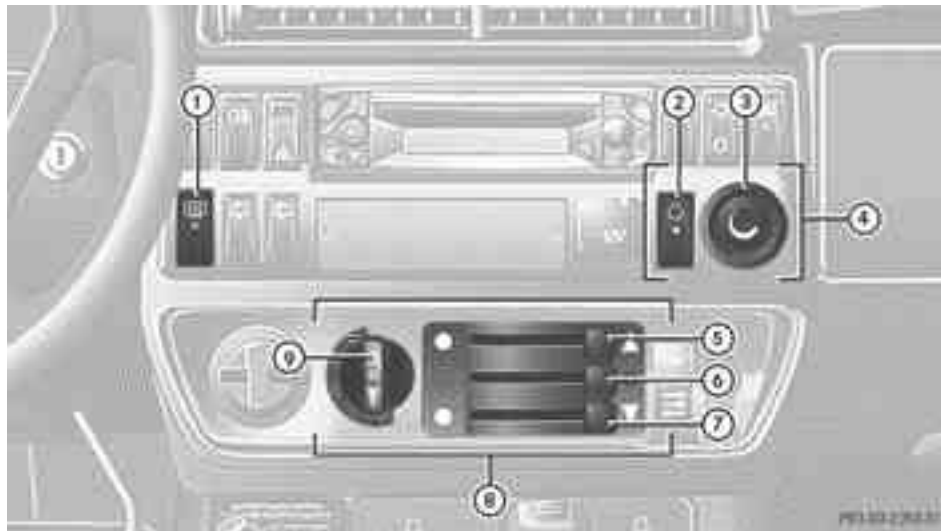

- ① To switch the rear window heating on/off (▷ page 81)
- ② Air-conditioning system: switches air-recirculation on/off (▷ page 81)
- ③ Air-conditioning system temperature control: increases/reduces the temperature (▷ page 80)
- ④ Air-conditioning system
- ⑤ Airflow slider, demister vents: adjusts the airflow
- ⑥ Heating system temperature slider: increases/reduces the temperature (▷ page 80)
- ⑦ Airflow slider, footwell vents: adjusts the airflow
- ⑧ Heating system (▷ page 79)
- ⑨ Switches the blower on/off and adjusts the airflow (▷ page 80)

Heating and air-conditioning system controls



Notes on using the heating/air-conditioning system

- ❗ Only use the "demisting" settings briefly until the windscreen is clear again. This prevents the battery from discharging unnecessarily.
Only use the air-recirculation mode briefly, e.g. if there are unpleasant outside odours or when in a tunnel. The windows could otherwise mist up, as no fresh air is fed into the vehicle in air-recirculation mode.





The rear window heating has a high current draw. You should therefore switch it off as soon as the rear window is clear.

Turning the heating system on/off

- ❗ When the heating system is switched off, the air supply and air recirculation are also switched off. Only select this setting briefly. Otherwise, the windows may mist up.

- ▶ Make sure the key is in position **2** in the ignition lock.
- ▶ **To switch on:** turn the  blower switch to the level required.
- ▶ **To switch off:** turn the  blower switch to level **0**.
- ▶ Increase or reduce the temperature (▷ page 80).

Increasing/reducing the temperature

- i** Use the "Heating and air-conditioning system control panel" overview graphic for position information (▷ page 79)
- ▶ **To increase:** slide heating system temperature slider  to the right.
- ▶ **Additionally, for vehicles with an air-conditioning system:** turn air-conditioning system temperature control  anti-clockwise.
- ▶ **To reduce:** slide heating system temperature slider  to the left.
- ▶ **Additionally, for vehicles with an air-conditioning system:** turn air-conditioning system temperature control  clockwise.

Activating/deactivating the cooling with air dehumidification function

Points to observe before use

WARNING

If you deactivate the cooling with air-dehumidification function, the air inside the vehicle will not be cooled or dehumidified. The windows can mist up more quickly. This may prevent you from observing the traffic conditions, thereby causing an accident.



- !** Switch cooling on for at least ten minutes every month. Otherwise, the air-conditioning system could be damaged.

The "Cooling with air dehumidification" function is only available when the engine is running.

When cooling is switched on, the air inside the vehicle is cooled and dehumidified.

Condensation may drip from the underside of the vehicle when cooling mode is active. This is normal and not a sign that there is a malfunction.

Switching on/off



- ▶ Make sure the key is in position **2** in the ignition lock.
- ▶ **To switch on:** turn air-conditioning system temperature control  clockwise (▷ page 79).
- ▶ **To switch off:** turn air-conditioning system temperature control  anti-clockwise (▷ page 79).
- i** If you want to cool your vehicle quickly, you can also switch on the air-recirculation mode briefly.

Problems with the "Cooling with air dehumidification" function

If refrigerant leaks out of the air-conditioning system, the compressor switches off and the cooling with air dehumidification function can no longer be switched on.

- ▶ Visit a qualified specialist workshop.

Setting the airflow

- ▶ Turn the key to position **2** (▷ page 87) in the ignition lock.
- ▶ **To switch on:** turn the  blower switch to the level required.
- ▶ **To increase/reduce:** turn the  blower switch to the next higher or the next lower level.
- ▶ **To switch off:** turn the  blower switch to level **0**.

When you switch the blower off, the air supply and the air circulation are switched off at the same time.

- i** Only switch the ventilation off briefly. The windows could otherwise mist up.

Demisting the windscreen

The following settings can be used to defrost the windscreen or to demist the inside of the windscreen and the side windows:

- i** You should only select the demisting function until the windscreen is clear again.
- ▶ Make sure that air-recirculation mode is deactivated, so that outside air can flow into the vehicle (▷ page 81).
- ▶ Turn control ② on the centre air vents all the way down (▷ page 83).
- ▶ Move slider ① on the side air vents to the centre (▷ page 83).
- ▶ Turn the  blower switch to level **IV**.
- ▶ Slide demister vent airflow slider ⑤ as far as it will go to the right (▷ page 79).
- ▶ Slide heating system temperature slider ⑥ as far as it will go to the right to the red point (▷ page 79).

Demisting the windows

Windows misted up on the inside

- ▶ Make sure that air-recirculation mode is switched off, so that outside air can flow into the vehicle (▷ page 81).
- ▶ Turn the  blower switch to level **IV**.
- ▶ Slide demister vent airflow slider ⑤ as far as it will go to the right (▷ page 79).
- ▶ Turn control ② on the centre air vents all the way down (▷ page 83).
- ▶ Tilt the side air vents towards the side windows (▷ page 83).
- ▶ Slide heating system temperature slider ⑥ to the right (▷ page 79).

- i** You should only select this setting until the windscreen is clear again.

Windows misted up on the outside





- ▶ Make the setting as described previously under "Windows misted up on the inside".
- ▶ Activate the windscreen wipers.
- i** You should only select this setting until the windscreen is clear again.

Switching the rear window heating on/off

Switching on/off

WARNING





Clear all windows of ice or snow before setting off. Otherwise, impaired visibility could endanger you and others.

- i** The rear window heating has a high current draw. You should therefore switch it off as soon as the window is clear.
- ▶ **To switch on:** turn the key to position **2** (▷ page 87) in the ignition lock.
- ▶ Press the upper section of the  switch. The indicator lamp in the  switch lights up.
- ▶ **To switch off:** press the lower section of the  switch. Indicator lamp in the  switch goes out.

Activating/deactivating air-recirculation mode

WARNING

Only switch over to air-recirculation mode briefly at low outside temperatures. Otherwise, the windows could mist up, thus impairing visibility and endangering yourself and others. This may prevent you from observing the traffic conditions, thereby causing an accident.

- ▶ **To activate:** make sure that the key is in position **2** in the ignition lock.
- ▶ Press the upper section of the  switch. The indicator lamp in the  switch lights up.
- ▶ **To switch off:** press the lower section of the  switch. Indicator lamp in the  switch goes out.

i You can deactivate the flow of fresh air if unpleasant odours are entering the vehicle from outside. The air already inside the vehicle will then be recirculated.

Auxiliary heating

Important safety notes

WARNING

Exhaust fumes are produced when the auxiliary heating is in operation. Inhaling these exhaust fumes can be poisonous. You should therefore switch off the auxiliary heating in confined spaces without an extraction system, e.g. a garage.

WARNING

When operating the auxiliary heating parts of the vehicle can get very hot. Make sure that the exhaust system does not under any circumstances come into contact with easily ignitable material such as dry grass or fuels. The material could otherwise ignite and set the vehicle alight. Choose your parking spot accordingly.

Operating the auxiliary heating is thus prohibited at filling stations or when your vehicle is being refuelled. You must therefore switch off the auxiliary heating at filling stations.

- i** Switch the auxiliary heating on regularly once a month for about ten minutes.
The auxiliary heating must not be switched on when fording.

The auxiliary heating heats the air in the vehicle interior without using the heat of the running engine. The auxiliary heating is operated



directly using the vehicle's fuel. For this reason, the tank content must be at least at reserve fuel level to ensure that the auxiliary heating functions.

The auxiliary heating switches off automatically after 50 minutes. This time limit can be altered. To do this, visit a qualified specialist workshop.

Switching the auxiliary heating on and off



Auxiliary heating button in the centre console control panel

- ▶ **To switch on:** switch on the battery main switch (▷ page 87).
- ▶ Slide heating temperature slider  to the right (▷ page 79).
- ▶ Turn the  blower switch to level I.
- ▶ Press the auxiliary heating button. The auxiliary heating is switched on. The indicator lamp in the button lights up.
- ▶ **To switch off:** press the auxiliary heating button again. The indicator lamp in the button goes out. The auxiliary heating remains on for a few minutes and then switches off.
- i** If you switch off the battery main switch when the auxiliary heating is switched on, the auxiliary heating continues to operate for the remaining operating time. The vehicle's electrical system remains connected to the battery for eight minutes after the auxiliary heating is switched off.

Adjusting the air vents

Important safety notes

WARNING

Very hot or very cold air can flow from the air vents. This could cause burns or frostbite to bare skin in the immediate vicinity of the vents. Keep bare skin away from these air outlets. If necessary, direct the airflow away to a different area of the vehicle interior.

General notes

In order to ensure the direct flow of fresh air through the air vents into the vehicle interior, please observe the following notes:

- keep the air inlet grille on the bonnet free of blockages, such as ice, snow or leaves.
 - never cover the vents or ventilation grilles in the vehicle interior.
- i** To provide virtually draught-free ventilation, position the slider for the centre air vents in the central position and the adjustment catches of the side air vents in the horizontal position.

Setting the centre air vents

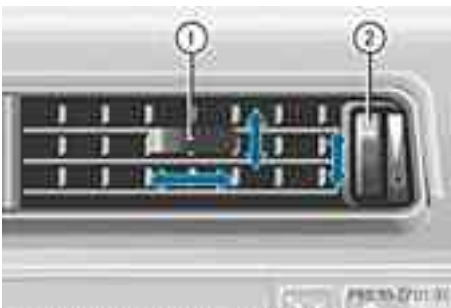

Example: right centre air vent

► **To open/close:** turn thumbwheel ② up or down.

► **To set the air direction:** move slider ① for the centre air vent to the right, left, up or down.

- i** Either fresh air or, if the air-conditioning system is switched on, cooled air flows through the centre air vents. No heated air flows through the centre air vents.

Setting the side air vents

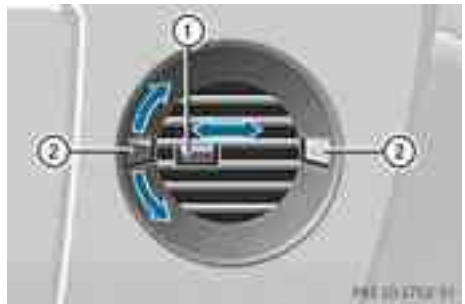

Example: right side air vent

The side air vents can be turned as required to adjust the airflow.

► **To open/close:** move slider ① to the right or to the left.

► **To adjust the air direction:** turn the side air vents to the right or left using aiming pads ②.

Useful information	86
Running-in notes	86
Driving	86
Automatic transmission	91
Refuelling	96
Parking	100
Driving tips	101
Off-road driving systems	110
Towing a trailer	113

Useful information

- i** This Owner's Manual describes all models, series and optional equipment for your vehicle that were available at the time of going to press. Country-specific differences are possible. Note that your vehicle may not be fitted with all features described. This is also the case for systems and functions relevant to safety.
- i** Read the information on qualified specialist workshops: (▷ page 15).

Running-in notes

Important safety notes

Brake pads/linings and discs that are new, or have been replaced, only achieve optimum braking effect after several hundred kilometres of driving. Compensate for the reduced braking effect by applying greater force to the brake pedal.

The first 1,500 km

If you treat the engine with sufficient care from the very start, you will be rewarded with excellent performance for the remainder of the engine's life.

- Drive at varying vehicle speeds and engine speeds for the first 1,500 km.
- Avoid overstressing the vehicle during this period, e.g. driving at full throttle.
- Change gear in good time, as soon as the rev counter needle is $\frac{2}{3}$ of the way to the red area of the rev counter.
- Do not shift down a gear manually in order to brake.
- Try to avoid depressing the accelerator pedal beyond the point of resistance (kick-down).
- The shift ranges **3**, **2** or **1** should only be engaged when driving slowly, e.g. when driving in mountainous terrain.

After 1,500 km, you may gradually bring the vehicle up to full road and engine speeds.

- i** You should also observe these notes on running in if the engine or parts of the drivetrain on your vehicle have been replaced.

Driving

Important safety notes

WARNING

Objects in the driver's footwell can restrict the pedal travel or obstruct a depressed pedal. The operating and road safety of the vehicle is jeopardised. There is a risk of an accident. Make sure that all objects in the vehicle are stowed correctly, and that they cannot enter the driver's footwell. Fit the floor mats securely and as specified in order to ensure sufficient clearance for the pedals. Do not use loose floor mats.

WARNING

Unsuitable footwear can hinder correct usage of the pedals, e.g.:

- shoes with thick soles
- shoes with high heels
- slippers

There is a risk of an accident.

Wear suitable footwear to ensure correct usage of the pedals.

WARNING

If you switch off the ignition while driving, safety-relevant functions are only available with limitations, or not at all. This could affect, for example, the power steering and the brake boosting effect. You will require considerably more effort to steer and brake. There is a risk of an accident.

Do not switch off the ignition while driving.

⚠ WARNING

If the parking brake has not been fully released when driving, the parking brake can:

- overheat and cause a fire
- lose its hold function.

There is a risk of fire and an accident. Release the parking brake fully before driving off.

! Warm up the engine quickly. Do not use the engine's full performance until it has reached operating temperature.

Only set the automatic transmission to the respective drive positions when the vehicle is stationary.

Where possible, avoid spinning the drive wheels when pulling away on slippery roads. Otherwise, you could damage the drive train.

! Avoid high engine speeds when the engine is cold. The engine's service life could otherwise be significantly shortened. Do not use the engine's full performance until it has reached operating temperature.

Battery main switch

Vehicles with a 24 V electrical system may be equipped with an integrated battery main switch or a battery main switch on the centre console.

Vehicles with a 12 V electrical system do not have a battery main switch.



▶ To switch on: turn battery main switch ③ to position ②.

The vehicle's 24 V electrical system is supplied with voltage from the battery.

i Make sure that the switch for the winch socket is switched off. The battery could drain.

▶ **To switch off:** make sure that the ignition is switched off (▶ page 87).

▶ Turn battery main switch ③ to position ①.

The vehicle's 24 V electrical system is disconnected from the battery.

i If the auxiliary heating is switched on or a differential lock is engaged, it takes longer to disconnect the 24 V electrical system from the battery. If a differential lock is engaged, disconnection takes an extra 45 seconds. If the auxiliary heating is switched on, the battery is fully disconnected 8 minutes after the auxiliary heating has been switched off.

The hazard warning lamps only operate if the battery main switch is switched on.

Key positions



- ① To remove the key, integrated battery main switch off
- ② Integrated battery main switch on
- ③ Ignition and drive position: voltage supply for all consumers, including airbags
- ④ Starting the engine

i The key can only be removed if you have turned it to position **0** in the ignition lock.

To unlock the steering wheel, move the steering wheel slightly to the left and right while turning the key to position **1**.

On vehicles with an integrated battery main switch, the hazard warning lamps may still be switched on when the key is in position **0** even when the battery main switch is switched off. The dipped and main-beam headlamps as well as side lamps can be switched on when the hazard warning lamps are switched on.

i The indicator and warning lamps light up in the instrument cluster when you switch on the ignition. They go out when the engine is running. This shows that the indicator and warning lamps for each system are operational.

Starting the engine

Important safety notes

WARNING

Combustion engines emit poisonous exhaust gases such as carbon monoxide. Inhaling these exhaust gases leads to poisoning. There is a risk of fatal injury. Therefore never leave the engine running in enclosed spaces without sufficient ventilation.

! Do not depress the accelerator pedal when starting the engine.

Starting procedure

► Shift the automatic transmission to position **P**.
Transmission position **P** appears in the display.

i You can also start the engine when the automatic transmission is in position **N**.

i For further information about the automatic transmission, see (▷ page 91).

i If you depress the brake when starting the engine, pedal travel is unusually long and there is less pedal resistance.

► Make sure that the parking brake is applied.

► Turn the key to position **2** in the ignition lock.

The  preglow indicator lamp in the instrument cluster lights up.

► When the  preglow indicator lamp goes out, turn the key to position **3** and release it.

The engine starts automatically. If the engine does not start after a predetermined time, the starting procedure ends automatically. You can interrupt the starting procedure manually at any time.

► **To interrupt the starting procedure:** turn the key in the ignition lock to position **0**.

i You can start the engine without preglow if the engine is warm.

Pulling away

Automatic transmission

WARNING

If the engine speed is above the idling speed and you engage transmission position **D** or **R**, the vehicle could pull away suddenly. There is a risk of an accident.

When engaging transmission position **D** or **R**, always firmly depress the brake pedal and do not simultaneously accelerate.

! Only shift the automatic transmission to reverse gear **R** or park position **P** when the vehicle is stationary. Otherwise, the automatic transmission could be damaged.

► Depress the brake pedal and keep it depressed.

► Shift the automatic transmission to position **D** or **R**.

i Before driving off, wait until the gear change is fully completed.

- ▶ Release the parking brake (▷ page 101).
 - ▶ Release the brake pedal.
 - ▶ Carefully depress the accelerator pedal.
- i** It is only possible to shift the automatic transmission from position **P** to a different position if you depress the brake pedal. Only then is the selector lever lock released.
- i** Upshifts take place at higher engine speeds after a cold start. This helps the catalytic converter to reach its operating temperature more quickly.

Problems with the engine

Problem	Possible causes/consequences and ► Solutions
<p>The engine does not start. You can hear the starter motor.</p>	<ul style="list-style-type: none"> • There is a malfunction in the engine electronics. • There is a malfunction in the fuel supply. <p>► Turn the key back to position 0 in the ignition lock before attempting to start the engine again.</p> <p>► Try to start the engine again (▷ page 88). Avoid excessively long and frequent attempts to start the engine, as this will drain the battery (▷ page 87).</p> <p>If the engine does not start after several attempts:</p> <p>► Consult a qualified specialist workshop.</p>
<p>The engine does not start. The starter motor can be heard. The yellow reserve fuel warning lamp is lit and the needle of the fuel gauge shows 0.</p>	<p>The fuel tank is empty.</p> <ul style="list-style-type: none"> ► Refuel the vehicle. ► Bleed the fuel system (▷ page 100).
<p>The engine does not start. You cannot hear the starter motor.</p>	<p>The on-board voltage is too low because the batteries are too weak or discharged.</p> <ul style="list-style-type: none"> ► Start the engine using the emergency start facility (▷ page 163). ► Jump-start the vehicle (▷ page 163). <p>If the engine does not start despite attempts to jump-start it:</p> <p>► Consult a qualified specialist workshop.</p>
<p>The engine is not running smoothly and is misfiring.</p>	<p>There is a malfunction in the engine electronics or in a mechanical component of the engine management system.</p> <ul style="list-style-type: none"> ► Only depress the accelerator pedal slightly. Otherwise, non-combusted fuel may get into the catalytic converter and damage it. ► Have the cause rectified immediately at a qualified specialist workshop.

Problem	Possible causes/consequences and ► Solutions
The coolant temperature display shows a value above 120 °C.	<p>The coolant level is too low. The coolant is too hot and the engine is no longer being cooled sufficiently.</p> <ul style="list-style-type: none"> ► Stop as soon as possible and allow the engine and the coolant to cool down. ► Check the coolant level (► page 143). Observe the warning notes as you do so and top up the coolant if necessary. <p>If the coolant level is correct, the radiator fan may be faulty. The coolant is too hot and the engine is no longer being cooled sufficiently.</p> <ul style="list-style-type: none"> ► If the coolant temperature is below 120 °C, you can continue driving to the nearest qualified specialist workshop. ► Avoid heavy loads on the engine as you do so, e.g. driving in mountainous terrain and stop-start traffic.

Automatic transmission

Important safety notes

WARNING

Objects in the driver's footwell can restrict the pedal travel or obstruct a depressed pedal. The operating and road safety of the vehicle is jeopardised. There is a risk of an accident. Make sure that all objects in the vehicle are stowed correctly, and that they cannot enter the driver's footwell. Fit the floor mats securely and as specified in order to ensure sufficient clearance for the pedals. Do not use loose floor mats.

- i** Bear in mind that power transmission between the engine and the transmission is interrupted when the engine is switched off. For this reason, shift the automatic transmission to **P** when the engine is switched off and the vehicle is stationary. Apply the parking brake to prevent the vehicle from rolling away.

Selector lever

Overview of transmission positions



Selector lever

P Park position with selector lever lock

R Reverse gear

N Neutral

D Drive

Transmission position display

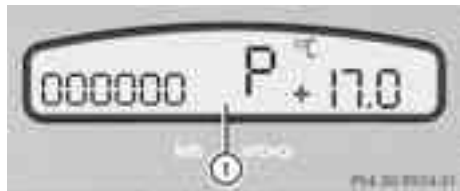

① Transmission position/shift range

Current shift range ① is shown in the instrument cluster display.

When the selector lever is in position **D**, you can influence the gearshifts made by the automatic transmission by:

- restricting the shift range
- changing gear yourself

Transmission positions

P

Park position

This prevents the vehicle from rolling away when stopped. Do not shift the transmission into position **P** (> page 91) unless the vehicle is stationary.

- ❗ The key can only be removed if the transmission is in position **P**. When there is no key in the ignition lock, the selector lever is locked in position **P**.

Have the vehicle electronics checked immediately at a qualified specialist workshop.

R

Reverse gear

Only shift the transmission to **R** when the vehicle is stationary.

N

Neutral

No power is transmitted from the engine to the drive wheels.

Releasing the brakes will allow you to move the vehicle freely, e.g. to push it or tow it.

Do not shift the transmission to **N** while driving. Otherwise, the automatic transmission could be damaged.

Shift into **N** briefly, if:

- there is a risk of the vehicle skidding, e.g. on slippery roads in winter.
- you want to engage the transfer case.

⚠ Rolling in neutral **N** can lead to damage to the transmission.

D

Drive

The automatic transmission changes gear automatically. All forward gears are available.

Changing gear

The automatic transmission shifts to the individual gears automatically when it is in transmission position **D**. Gearshifting is determined by:

- a shift range restriction, if selected
- the position of the transfer case (**HIGH** or **LOW**)
- the position of the accelerator pedal
- the road speed

Driving tips

Accelerator pedal position

Your style of driving influences how the automatic transmission shifts gear:

- little throttle: early upshifts
- more throttle: late upshifts

Kickdown

Use kickdown for maximum acceleration:

- ▶ Depress the accelerator pedal beyond the pressure point.
The transmission shifts to a lower gear depending on the engine speed.
- ▶ Ease off the accelerator pedal once the desired speed is reached.
The automatic transmission shifts back up.

Towing a trailer

- ▶ Drive in the middle of the engine speed range on uphill gradients.
- ▶ Shift down to shift range **3** or **2** depending on the uphill or downhill gradient (▷ page 93).
- ▶ Shift the transfer case into off-road driving position **LOW** on extreme uphill gradients or steep downhill gradients (▷ page 110).

Shift ranges

Introduction

When the automatic transmission is in position **D**, it is possible to restrict or derestrict the shift range.

The shift range selected is shown in the display.

Driving situations

- | | |
|----------|--|
| 3 | To use the engine's braking effect |
| 2 | The braking effect of the engine can be utilised on downhill gradients or when driving: <ul style="list-style-type: none"> • on steep mountain roads • in mountainous terrain • in arduous conditions |
| 1 | The braking effect of the engine can be utilised on extremely steep downhill gradients and long downhill stretches. |

Restricting the shift range

- ▶ Press the selector lever to the left towards **D-**.
The automatic transmission shifts down one gear and restricts the shift range to the relevant gear.
- i** If the engine exceeds the maximum engine speed when shifting down, the automatic transmission protects against engine damage by not shifting down.
- i** If the maximum engine speed for the shift range is reached and you continue to accelerate, the automatic transmission shifts up in order to prevent the engine from over-revving, even if the shift range is restricted.

Extending the shift range

- ▶ Press the selector lever to the right towards **D+**.
The automatic transmission shifts up one gear and restricts the shift range to the relevant gear.

Clearing the shift range restriction

- ▶ Press and hold the selector lever towards **D+** until **D** is shown once more in the multifunction display.

The automatic transmission shifts from the current shift range directly to **D**.

Selecting the ideal shift range

- ▶ Press the selector lever to the left towards **D-** and hold it in position.

The automatic transmission shifts to the gear which allows optimum acceleration and deceleration. To do this, the automatic transmission shifts down one or more gears.

- i** The automatic transmission cannot shift down beyond second gear. To shift to first gear, you have to pull the left steering wheel gearshift paddle.

Problems with the automatic transmission	
Problem	Possible causes/consequences and ► Solutions
The transmission has problems shifting gear.	The transmission is losing oil. ► Have the transmission checked at a qualified specialist workshop immediately.
The acceleration ability is deteriorating. The transmission no longer changes gear.	The transmission is in emergency mode. It is only possible to shift into second gear and reverse gear. ► Stop. ► Shift the transmission to position P . ► Turn the key to position 0 in the ignition lock. ► Wait at least ten seconds before restarting the engine. ► Shift the transmission to position D or R . If D is selected, the transmission shifts into second gear; if R is selected, the transmission shifts into reverse gear. ► Have the transmission checked at a qualified specialist workshop immediately.
You hear a warning tone.	You have: <ul style="list-style-type: none"> • switched off the engine • opened the driver's door • not moved the selector lever to position P ► Move the selector lever to P .

Releasing the parking lock manually

If a fault occurs, you can release the selector lever lock manually to move it out of position **P** to, for example, tow the vehicle.



- Apply the parking brake.
- Press marking ① down to the stop and hold.
The selector lever can now be moved freely until it is returned to position **P**.

ADR (working speed governor)

ADR prevents a reduction in engine speed, e.g. when the alternator is under high load. The switches are located on the centre console.

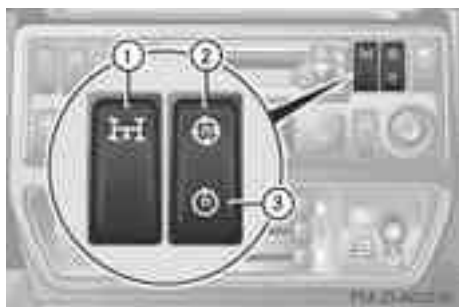

- ① To activate ADR
- ② To increase the engine speed
- ③ To lower the engine speed

- ▶ Make sure that the vehicle is stationary.
- ▶ Move the selector lever to **P** (▷ page 92).
- ▶ Press the upper half of switch ①.

ADR is activated. The engine idling speed is controlled automatically. The **ADR** indicator lamp in the instrument panel lights up.

If ADR is activated you can increase to a maximum of 1800 rpm or lower to a minimum of 900 rpm as necessary.

- ▶ **To increase the engine speed:** press the upper half of switch ②.
- ▶ **To lower the engine speed:** press the lower half of switch ③.

Refuelling

Important safety notes

WARNING

Fuel is highly flammable. If you handle fuel incorrectly, there is a risk of fire and explosion.

You must avoid fire, naked flames, creating sparks and smoking. Switch off the engine and, if applicable, the auxiliary heating before refuelling.

WARNING

Fuels are poisonous and hazardous to health. There is a danger of injury.

Do not swallow fuel or let it come into contact with skin, eyes or clothing. Do not inhale fuel vapours. Keep fuels out of the reach of children.





If you or others come into contact with fuel, observe the following:

- Wash the fuel off any affected areas of skin with water and soap immediately.
- If you get fuel in your eyes, rinse them thoroughly with clean water immediately. Seek immediate medical attention.
- If fuel is swallowed, seek immediate medical attention. Do not induce vomiting.
- Change any clothing that has come into contact with fuel immediately.

WARNING

If you mix diesel fuel with petrol, the flash point of this fuel mixture is lower than that of pure diesel fuel. When the engine is running, components in the exhaust system may overheat unnoticed. There is a risk of fire.

Never refuel with petrol. Never add petrol to diesel fuel.

-  Do not use petrol to refuel vehicles with a diesel engine. Never mix diesel with petrol. Even small amounts of the wrong fuel result in damage to the fuel injection system.
-  Do not switch on the ignition if you accidentally refuel with the wrong fuel. Otherwise, the fuel will enter the fuel lines. Notify a qualified specialist workshop and have the fuel tank and fuel lines drained completely.
-  Overfilling the fuel tank could damage the fuel system.
-  Take care not to spill any fuel on painted surfaces. You could otherwise damage the paintwork.

! Use a filter when adding fuel from a fuel can. The fuel lines and/or the diesel injection system could otherwise be blocked by particles from the fuel can.

Further information on fuel and fuel quality (▷ page 191)

Preheater block

! Do not close the bonnet. Otherwise, you may damage the connection cable and a resulting short circuit may damage the engine electrical system. Lower the bonnet without closing it and secure the cable to prevent it from becoming crushed.



The preheater block makes it possible to keep the engine at operating temperature at outside temperatures of down to -40°C . The engine is heated electrically. Power is supplied by a power cable connected to a 230 V power supply.

The preheater block's power socket is in the engine compartment on the right when viewed in the direction of travel.

- ▶ Open the bonnet (▷ page 140).
- ▶ Open cover (1) in the direction of the arrow.

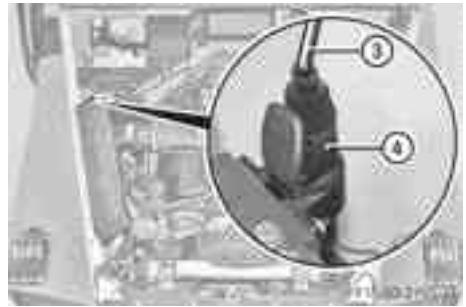

- ▶ Insert connection cable (3) with plug (4) into power socket (2).
- ▶ Connect the vehicle to a 230 V power supply using connection cable (3).

The preheater block is switched on. The engine is maintained at operating temperature.

- ▶ Carefully lower the bonnet.

Refuelling

Vehicles with a fuel filler flap



Example: station wagon

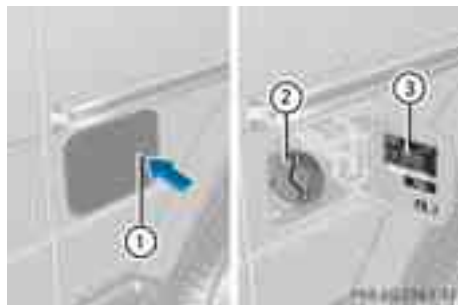

Example: fuel filler flap

- ① Fuel filler flap
- ② Fuel filler cap
- ③ Tyre pressure table

► Press fuel filler flap ① in the direction of the arrow.

The fuel filler flap opens slightly.

► Open the fuel filler flap.

i **Chassis-cab/platform truck:** a table with the tyre pressures can be found in the "Wheels and tyres" section (► page 184).

Vehicles without a fuel filler flap



Example: chassis cab/platform truck



Example: 6x6 chassis cab with crewcab

- ② Fuel tank cap
- ④ Additional fuel tank cap

Opening the fuel filler cap

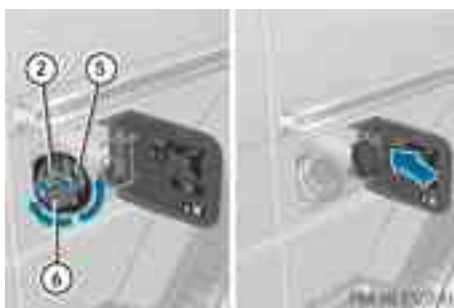

Example: fuel filler cap

- Turn lock cover ⑥ to the side.
- Turn key ⑤ in fuel filler cap ② anti-clockwise and remove fuel filler cap ②.

or

- ▶ Turn key ⑤ in fuel filler cap ④ anti-clockwise and remove fuel filler cap ④.
- ▶ For vehicles with a fuel filler flap, insert fuel filler cap ② into the bracket on the inside of the filler flap.
- ▶ For vehicles with a fuel filler flap, remove key ⑤ from fuel filler cap ②.

Refuelling

- ▶ Completely insert the filler neck of the fuel pump nozzle into the tank and refuel.
- ❗ Do not add any more fuel after the pump stops filling for the first time. Otherwise, fuel may leak out.

Closing

- ▶ Replace fuel filler cap and turn it clockwise as far as it will go.
- ▶ Turn key ⑤ in the lock of fuel filler cap clockwise and lock the fuel filler cap.
- ▶ Remove key ⑤ from the fuel filler cap.
- ▶ Turn lock cover ⑥ back over the lock.
- ▶ For vehicles with a fuel filler flap, close the fuel filler flap.

Fuel transfer (6x6 chassis cab with crewcab)

The 6x6 chassis cab with crewcab has an additional fuel tank.

Fuel can be transferred from the additional fuel tank to the fuel tank:

- if the fuel tank is approximately only a quarter full of fuel
- at the latest when the fuel tank lamp lights up in the instrument cluster.



- ▶ Make sure that the engine is running.
- ▶ Press switch ①. Approximately 42 litres of fuel are transferred from the additional fuel tank to the fuel tank: During the transfer process, the white indicator lamp in switch ① lights up.
- ▶ To transfer additional fuel, press switch ① again.
- ❗ Fuel gauge ② only shows the correct fuel level when the vehicle is on level ground. If the fuel level is not displayed correctly:
 - ▶ Switch off the engine
 - ▶ Start the engine again.

Problems with the fuel and fuel tank

Problem	Possible causes/consequences and ► Solutions
Fuel is leaking from the vehicle.	<p> Risk of explosion or fire</p> <p>The fuel line or the fuel tank is defective.</p> <ul style="list-style-type: none"> ► Turn the key to position 0(▷ page 87) in the ignition lock immediately and remove it. ► Do not restart the engine under any circumstances. ► Consult a qualified specialist workshop.
The engine does not start.	<p>The fuel tank has been run dry.</p> <ul style="list-style-type: none"> ► Refuel the vehicle with at least 20 litres of diesel. ► Turn the ignition on for around 10 seconds(▷ page 87). ► Start the engine continuously for up to 40 seconds until it runs smoothly. <p>If the engine does not start:</p> <ul style="list-style-type: none"> ► Turn the ignition on again for approximately 10 seconds(▷ page 87). ► Start the engine again continuously for up to 40 seconds until it runs smoothly. <p>If the engine does not start after three attempts:</p> <ul style="list-style-type: none"> ► Consult a qualified specialist workshop.

Parking

Important safety notes

 **WARNING**

Flammable materials, e.g. leaves, grass or twigs, may ignite if they come into contact with hot parts of the exhaust system or exhaust gases for extended periods. There is a risk of fire.

Park the vehicle so that no flammable materials come into contact with hot parts of the vehicle. In particular, do not park on dry areas of grass or harvested grainfields.

 **WARNING**

If you switch off the ignition while driving, safety-relevant functions are only available with limitations, or not at all. This could affect, for example, the power steering and the brake

boosting effect. You will require considerably more effort to steer and brake. There is a risk of an accident.

Do not switch off the ignition while driving.

To ensure that the vehicle is secured against rolling away unintentionally:

- the parking brake must be applied.
- the transmission must be in position **P** and the key must be removed from the ignition lock
- the transfer case must not be in position **N**.
- on uphill or downhill gradients, turn the front wheels towards the kerb.

Switching off the engine

Important safety notes

WARNING

If you switch off the ignition while driving, safety-relevant functions are only available with limitations, or not at all. This could affect, for example, the power steering and the brake boosting effect. You will require considerably more effort to steer and brake. There is a risk of an accident.

Do not switch off the ignition while driving.



Vehicles with automatic transmission

- ▶ Shift the transmission to position **P**.
 - ▶ Turn the key to position **0** in the ignition lock (▷ page 87) and remove it. The immobiliser is activated.
 - ▶ Apply the parking brake firmly.
 - ▶ Turn the steering wheel until the steering wheel lock engages.
 - ▶ Switch off the battery main switch (▷ page 87).
- i** Always remove the key when you park the vehicle, in order to prevent the battery discharging.

Parking brake



- i** When you apply parking brake ② to brake the vehicle, the brake lamps do not light up.

- ▶ **To apply:** pull parking brake ② up firmly. If the key is in position **2** in the ignition lock, then the  indicator lamp in the instrument cluster is lit.
- ▶ **To release:** depress the brake pedal and keep it depressed. The selector lever lock is released.
- ▶ Pull parking brake ② up firmly.
- ▶ Press release button ① on parking brake ② and move parking brake ② down to the stop. The  indicator lamp in the instrument cluster goes out.

- i** If you pull away with parking brake ② applied, a warning tone sounds.

Parking up the vehicle

If you leave the vehicle parked up for longer than four weeks, the battery may be damaged by exhaustive discharging.

- ▶ Disconnect the battery.
- or
- ▶ Connect the battery to a trickle charger.
- i** You can obtain information about trickle chargers from a qualified specialist workshop.

If you leave the vehicle parked up for longer than six weeks, the vehicle may suffer damage as a result of lack of use.

- ▶ Visit a qualified specialist workshop and seek advice.

Driving tips

Short journeys

- !** **Vehicles with a diesel particle filter:** if the vehicle is mostly driven for short distances, it is possible that malfunctions may occur during the automatic cleaning of the diesel particle filter. This may lead to fuel collecting in the engine oil and cause

engine failure. Therefore, if you frequently drive short distances, you should take a 20 minute trip on a motorway or rural road at least every 500km.

Braking

Important safety notes

WARNING

If you shift down on a slippery road surface in an attempt to increase the engine's braking effect, the drive wheels could lose their grip. This increases the risk of skidding and having an accident.

Do not shift down for additional engine braking on a slippery road surface.

Downhill gradients

On long and steep downhill gradients, especially if the vehicle is laden or towing a trailer, you must select shift range **1, 2 or 3** (> page 93) in good time.

This will use the braking effect of the engine, so less braking will be required to prevent the vehicle from gaining speed. This relieves the load on the brake system and prevents the brakes from overheating and wearing too quickly. If you need additional braking, depress the brake pedal repeatedly rather than continuously.

Heavy and light loads

WARNING

The braking system can overheat if you leave your foot on the brake pedal while driving. This increases the braking distance and could even cause the braking system to fail. There is a risk of an accident.

Never use the brake pedal as a footrest. Do not simultaneously depress both the brake pedal and the accelerator pedal while driving.

If the brakes have been subjected to a heavy load, do not stop the vehicle immediately, but

drive on for a short while. This allows the air-flow to cool the brakes more quickly.

If the brakes have been used only moderately, you should occasionally test their effectiveness. To do this, brake more firmly from a higher speed. This improves the grip of the brakes.

Wet road surfaces

If driving in heavy rain for a prolonged period of time without braking, there may be a delayed reaction from the brakes when braking for the first time. This may also occur after the vehicle has been washed.

You have to depress the brake pedal more firmly. Maintain a greater distance from the vehicle in front.

After driving on a wet road or having the vehicle washed, brake firmly while paying attention to the traffic conditions. This will warm up the brake discs, thereby drying them more quickly and protecting them against corrosion.

Limited braking performance on salt-treated roads

If you drive on salt-treated roads, a layer of salt may form on the brake discs and pads. This can increase the braking distance considerably.

- Apply the brakes occasionally in order to prevent any salt build-up. Ensure that you do not endanger other road users when doing so.
- Carefully depress the brake pedal at the end of the journey and when starting the next journey.
- Maintain a much greater distance to the vehicle in front.

New brake pads/linings

New brake pads/brake pads and discs that have been replaced only achieve optimum braking effect after several hundred kilometres of driving. Compensate for the reduced

braking effect by applying greater force to the brake pedal.

For safety reasons, Mercedes-Benz recommends that you only have brake pads/linings fitted to your vehicle which have been approved for Mercedes-Benz vehicles or which correspond to an equivalent quality standard. Brake pads/linings which have not been approved for Mercedes-Benz vehicles or which are not of an equivalent quality could affect your vehicle's operating safety.

Parking brake

WARNING

If you must brake the vehicle with the parking brake, the braking distance is considerably longer and the wheels could lock. This increases the risk of skidding and an accident.

Only use the parking brake to brake the vehicle when the service brake is faulty. Do not apply the parking brake too firmly. If the wheels lock, release the parking brake until the wheels begin turning again.

When you apply the parking brake to brake the vehicle, the brake lamps do not light up.

If you drive on wet roads or dirt-covered surfaces, road salt and/or dirt could get into the parking brake.

In order to prevent corrosion and a reduction in the braking power of the parking brake, observe the following:

- pull the parking brake upwards with the release button depressed from time to time before beginning the journey (> page 101).
- drive for approximately 100 m at a maximum speed of 20 km/h.

Tyre traction

WARNING

Whereas the vehicle can be fully controlled at a certain speed on dry roads, you must reduce your speed on wet or icy roads to achieve the

same road safety. You could otherwise cause an accident.

Pay particular attention to the road conditions at temperatures around freezing point.

If ice has formed on the road surface (e.g. from fog), a thin film of water rapidly forms on the ice when you brake, considerably reducing tyre traction. Drive with particular care in such weather conditions.

Driving on slippery surfaces

- ❗ If possible, do not let the drive wheels spin. Otherwise, you could damage the drive train.
- ▶ Engage the differential locks if necessary (> page 112).

Driving on wet roads

Aquaplaning

If water has accumulated to a certain depth on the road surface, there is a danger of aquaplaning occurring, even if:

- you are driving at low speeds
- the tyres have adequate tread depth

For this reason, do not drive in tyre ruts and brake carefully.

Driving on flooded roads

❗ Bear in mind that vehicles travelling in front or in the opposite direction create waves. This may cause the maximum permissible water depth to be exceeded.

These notes must be observed under all circumstances. You could otherwise damage the engine, the electronics or the transmission.

If you have to drive on stretches of road on which water has collected, please bear in mind that:

- the maximum permissible fording depth in still water is 60 cm
- you should drive no faster than walking pace

Off-road fording

! The water depth must not exceed 60 cm. Note that the possible fording depth is less in flowing water.

! Under no circumstances should you accelerate before entering the water. The bow wave could cause water to enter and damage the engine and neighbouring assemblies.

! Do not open any of the vehicle's doors while fording. Otherwise, water could get into the vehicle interior and damage the vehicle's electronics and interior equipment.

! During or after fording, the red battery charge indicator lamp in the instrument cluster may light up.

The poly-V-belt is wet and is slipping on the drive pulley.

- Drive on slowly.
- Accelerate gently.
- Do not switch off the engine.

The poly-V-belt will dry out after fording. The red battery charge indicator lamp goes out after 15 seconds.



Fording depth must not exceed 60 cm when the vehicle is loaded and ready to drive.

Loaded and ready to drive means: a full tank, all fluids topped up and the driver is in the vehicle.

i You may only drive through freshwater.

- Observe the safety notes (▷ page 106) and the general notes (▷ page 106) on off-road driving.
- Establish how deep the water is and the characteristics of the body of water before fording.
- Switch off the air-conditioning system.
- Shift the transfer case to **LOW** (▷ page 110).
- Engage the differential locks, if necessary (▷ page 112).
- Restrict the shift range to **1** or **2** (▷ page 93).
- Avoid high engine speeds.
- Enter and exit the water at a flat place and at a steady walking pace.
- Drive slowly and at a constant speed through the water.
- Do not stop and do not switch off the engine.
- Water offers a high degree of resistance, the ground is slippery and, in some cases, unstable. Therefore, it is difficult and dangerous to pull away in the water.
- Ensure that a bow wave does not form as you drive.
- Clean any mud from the tyre tread after fording.
- Apply the brakes to dry them after fording.

After fording



- ▶ Pull clamp ① upwards.
- ▶ Remove rubber plug ②.
The water runs out of the drain holes.
- ▶ Wipe up any remaining water with a cloth.
- ▶ Press rubber plug ② back into the drain hole.
- ▶ Fold down clamp ① and press it down.

When fording, waves can form which may result in water entering the footwells. You can drain off the water by opening drain holes in the footwells.

Winter driving

General notes

DANGER

If the exhaust pipe is blocked or adequate ventilation is not possible, poisonous gases such as carbon monoxide (CO) may enter the vehicle. This is the case, e.g. if the vehicle becomes trapped in snow. There is a risk of fatal injury.

If you leave the engine or the auxiliary heating running, make sure the exhaust pipe and area around the vehicle are clear of snow. To ensure an adequate supply of fresh air, open a window on the side of the vehicle that is not facing into the wind.

WARNING

If you have fitted snow chains to the front wheels, they may scrape against the vehicle

body or chassis components. This could cause damage to the vehicle or the tyres. There is a risk of an accident.

To avoid hazardous situations:

- never fit snow chains on the front wheels
- fit snow chains to the rear wheels in pairs.

At the onset of winter, have your vehicle winterproofed at a qualified specialist workshop. Observe the notes in the "Winter operation" section (▷ page 176).

Driving with summer tyres

Observe the notes in the "Winter operation" section (▷ page 176).

Slippery road surfaces

WARNING

If you shift down on a slippery road surface in an attempt to increase the engine's braking effect, the drive wheels could lose their grip. This increases the risk of skidding and having an accident.

Do not shift down for additional engine braking on a slippery road surface.

You should drive particularly carefully on slippery road surfaces. Avoid sudden acceleration, steering and braking manoeuvres.

If the vehicle threatens to skid or cannot be stopped when moving at low speed:

- ▶ Move the transmission to position **N**.
- ▶ Try to bring the vehicle under control by using corrective steering.

 For more information on driving with snow chains, see (▷ page 176).

Off-road driving

Important safety notes

WARNING

If you drive up a steep incline at an angle or turn on a steep incline, the vehicle could slip sideways, tip and overturn. There is a risk of an accident.

When driving up an incline, drive into the line of fall (upwards or downwards in a straight line) and do not turn.

When driving off-road, sand, mud and water, possibly mixed with oil, for example, could get into the brakes. This may lead to a reduction in braking performance or total brake failure as a result of increased wear. The braking characteristics will vary, depending on the substances that get into the brakes. Clean the brakes after driving off-road. If you notice grinding noises or a reduction in braking performance, have the brake system checked at a qualified specialist workshop immediately. Adapt your driving style to the altered braking characteristics.

Driving off-road increases the possibility of damage to the vehicle, which may cause assemblies or systems to fail. Adapt your driving style to the conditions of the terrain. Drive carefully. Have vehicle damage rectified immediately at a qualified specialist workshop.

Observe the following when on hilly roads:

- Do not shift the transmission to position **N**.
- If the gradient is too steep for your vehicle, back up in reverse gear.
- Do not continuously depress the brake pedal, as doing so could cause you to lose control.

General notes

Environmental note

Protection of the environment is of primary importance. Treat nature with respect. Observe all prohibiting signs.

Read this section before driving your vehicle off-road. Practise by travelling over more gentle off-road terrain first.

The following driving systems are specially adapted to off-road driving:

- Transfer case (▷ page 110)
- Differential locks (▷ page 111)

Observe the following notes:

- stop your vehicle and, if necessary, shift the transfer case to **LOW**(▷ page 110) before driving off-road.
- engage the differential locks, if necessary (▷ page 112).

 When the differential locks are engaged, ABS and BAS are deactivated. This allows the front wheels to lock briefly, so that they can dig into a loose surface. However, please note that locked wheels skid and can no longer steer.

- Make sure that items of luggage and loads are stowed safely and are well secured (▷ page 134).
- To avoid damaging the vehicle, make sure there is always sufficient ground clearance.
- Always keep the engine running and in gear when driving on a downhill gradient.
- Always keep the engine running and in gear when driving on a slope.
- Drive slowly and evenly, if necessary at walking pace.
- Ensure that the wheels are in contact with the ground at all times.
- Drive with extreme care on unknown off-road routes where visibility is poor. For safety reasons, get out of the vehicle first and survey the off-road route.

- Check the depth of water before fording rivers and streams.
- When fording, do not stop and do not switch off the engine.
- Look out for obstacles such as rocks, holes, tree stumps and furrows.
- Always keep the doors, the rear door and the windows closed while the vehicle is in motion.
- Do not stray from marked routes or paths.
- Match your speed to the terrain. The rougher, steeper or more ruts on the terrain, the slower your speed should be.
- Drive slowly and at a constant speed through the water. Ensure that a bow wave does not form as you drive.
- On sand, drive quickly to overcome the rolling resistance. Otherwise, the vehicle could dig itself into the sand.
- Do not jump with the vehicle as this will interrupt the vehicle's propulsion.
- Avoid high engine speeds. Drive at appropriate engine speeds.
- Always check the vehicle for damage after off-road driving.

i Information about retrofitting special all-terrain tyres is available from any qualified specialist workshop.

i Do not use the HOLD function when driving off-road, on steep uphill or downhill gradients or on slippery or loose surfaces. The HOLD function cannot hold the vehicle on such surfaces.

Checklist before driving off-road

! If the engine oil warning lamp lights up during the journey, stop the vehicle in a safe place as soon as is possible. Check the engine oil level. The warning given by the engine oil warning light must not be ignored. Continuing your journey when the symbol is shown may result in engine damage.

- ▶ **Engine oil level:** check the engine oil and top it up if necessary.
Only then does the engine receive enough oil when the vehicle is standing on a steep incline.
- ▶ **Tyre-change tool kit:** check that the jack is working and make sure you have the wheelbrace, a robust tow cable and a folding spade in the vehicle.
- ▶ **Wheels and tyres:** check the tyre tread depth and tyre pressure.
- ▶ Check for damage and remove any foreign objects, e.g. small stones, from the wheels/tyres.
- ▶ Replace any missing valve caps.
- ▶ Replace dented or damaged wheels.
- ▶ Carry a sound spare wheel.

Checklist after driving off-road

Driving over rough terrain places greater demands on your vehicle than driving on normal roads. After driving off-road, check the vehicle. This allows you to detect damage promptly and reduce the risk of an accident to yourself and other road users.

- ▶ Shift the transfer case to **HIGH** (▷ page 110).
- ▶ Disengage the differential locks (▷ page 113).
- ▶ Clean the headlamps and rear lights and check for damage.
- ▶ Clean the front and rear licence plates.
- ▶ Clean the wheels and tyres with a water jet and remove any foreign objects.
- ▶ Clean the wheels, tyres, wheel arches and the vehicle underside with a water jet; check for any foreign objects and damage.
- ▶ Check whether twigs or other parts of plants have become trapped. These increase the risk of fire and can damage fuel pipes, brake hoses or the rubber bellows of the axle joints and propeller shafts.

- ▶ After the trip, examine without fail the entire undercarriage, wheels, tyres, brakes, bodywork structure, steering, chassis and exhaust system for damage.
- ▶ After driving for extended periods across sand, mud, gravel, water or in similarly dirty conditions, have the brake discs, wheels, brake pads/linings and axle joints checked and cleaned.
- ▶ If you notice strong vibrations after off-road driving, check for foreign objects in the wheels and drive train and, if necessary, remove them.
Foreign objects can disturb the balance and cause vibrations.

Driving on sand

Observe the following rules when driving on sand:

- Shift the transfer case to **LOW**(▷ page 110).
- Avoid high engine speeds.
- Limit the shift range of the automatic transmission according to the off-road conditions.
- Drive quickly to overcome the rolling resistance. Otherwise, the vehicle could dig itself into the sand.
- Drive in the tracks of other vehicles if possible. When doing so, make sure that:
 - the tyre ruts are not too deep
 - the sand is firm enough
 - your vehicle has sufficient ground clearance

Tyre ruts and gravel roads

- ❗ Check that the ruts are not too deep and that your vehicle has sufficient clearance. Otherwise, your vehicle could be damaged or bottom out and get stuck.

Observe the following rules when driving along ruts in off-road terrain or on roads with loose gravel:

- Shift the transfer case to **LOW**(▷ page 110).
- Avoid high engine speeds.
- Observe the safety notes (▷ page 106) and the general notes (▷ page 106) on off-road driving.
- Restrict the shift range of the automatic transmission to **1**(▷ page 93).
- Drive slowly.
- Where ruts are too deep, drive with the wheels on one side on the middle section of turf if possible.

Driving over obstacles

- ❗ Obstacles could damage the floor of the vehicle or components of the chassis. Ask passengers for guidance when driving over large obstacles. Any damage to the vehicle always increases the risk of an accident.

- ❗ Drive with particular care when driving over an obstacle while driving up or down a steep slope.

The vehicle could otherwise tilt and slide sideways or tip over.

Observe the following rules when driving over tree stumps, large stones and other obstacles:

- Observe the safety notes (▷ page 106) and the general notes (▷ page 106) on off-road driving.
- Shift the transfer case to **LOW**(▷ page 110).
- Avoid high engine speeds.
- Restrict the shift range to **1**(▷ page 93).
- make sure that you have enough ground clearance before driving across an obstacle.
- Drive very slowly.
- Try to drive straight over the centre of obstacles: front wheel first, then rear wheel.

Travelling uphill

Approach/departure angle



The table shows front approach/departure angles ① and rear approach/departure angles ② at maximum load. This information only provides an indication. The respective approach and departure angles vary according to the vehicle tyres and optional equipment.

	①	②
Panel van	35°	31°
Station wagon	35°	31°
Chassis cab (vehicles with 12 V electrical system)	44°	32°
Chassis cab (vehicles with 24 V electrical system)	44°	36°
6x6 chassis cab with crewcab	41°	35°

- Observe the safety notes (▷ page 106) and the general notes (▷ page 106) on off-road driving.
- Follow the line of fall when driving on slopes and steep inclines.
- Before driving on extreme uphill and downhill gradients, shift the transfer case to **LOW** (▷ page 110).
- Engage the differential locks, if necessary (▷ page 112).

- Drive slowly.
- Accelerate gently and make sure that the wheels are gripping.
- Avoid high engine speeds, except when driving on sandy and muddy routes with high driving resistance.
- Use the braking power of the engine when driving down a slope. Observe the engine speed; do not overrev the engine.
- Select a shift range appropriate to the gradient.
- Before tackling steep downhill gradients, select shift range 1 (▷ page 93).
- Always check the brakes after driving off-road.

Maximum gradient-climbing capability

On good road surfaces and with the **LOW** gear selected, the maximum gradient-climbing capability is 80%.

Hilltops

When driving up an uphill gradient, slightly reduce pressure on the accelerator immediately before reaching the brow of the hill. Make use of the vehicle's own impetus to travel over the brow.

This style of driving prevents:

- the vehicle from lifting off the ground on the brow of a hill
- loss of traction
- the vehicle from travelling too quickly down the other side.

Driving downhill

- Before tackling steep downhill gradients, select shift range 1 (▷ page 93).
This way you use the engine's braking effect to reduce the speed. If this is not sufficient, brake gently. When doing so,

make sure that the vehicle is facing in the direction of the line of fall.

- Observe the notes on driving in mountainous terrain (▷ page 109).
- Drive slowly.
- Do not drive at an angle down steep inclines. Steer into the line of fall and drive with the front wheels aligned straight. Otherwise, the vehicle could slip sideways, tip and overturn.
- Check that the brakes are working normally after a long downhill stretch.

Off-road driving systems

Transfer case

General notes

The vehicle has permanent all-wheel drive. The front and rear axles are constantly driven. For further information on driving off-road, see (▷ page 106).

Shift ranges

WARNING

If you do not wait for the transfer case gear change process to complete, the transfer case could remain in the neutral position. The power transmission to the driven wheels is then interrupted. There is a danger of the vehicle rolling away unintentionally. There is a risk of an accident.

Wait until the transfer case shift process is completed.

Do not turn off the engine while changing gear and do not shift the automatic transmission to another gear.

H**HIGH**

Position for all normal on-road driving conditions.

L**LOW**

Low-range position for driving off-road.

Also for use on steep uphill or downhill gradients, especially when towing a trailer.

! When the transfer case is in the off-road driving position **LOW** range, the automatic transmission does not shift up, even when the engine has reached the over-revving limit. There is then a risk of engine damage. Make sure that you do not exceed the maximum permissible engine speed.

The vehicle travels around half the speed of on-road driving range **HIGH**. The tractive power is correspondingly higher.

N**Neutral**

Neutral position

No power is transmitted to the drive wheels.

Shifting the transfer case

Important safety notes

WARNING

When the transfer case is in the neutral position, power transmission to the driven wheels is interrupted. As a result, the vehicle could roll away. There is a risk of an accident.

Secure the vehicle with the parking brake, and on uphill or downhill gradients, also secure it with a device such as a wheel chock.

General notes

The transfer case switches are on the control panel on the centre console.



Activating the off-road gear ratio

! Only carry out the gear selection if:

- the engine is running.
- the vehicle is rolling.
- the automatic transmission is in selector lever position **N**.
- you are driving at less than 40 km/h.

You could otherwise damage the transfer case.

- ▶ Press the **LOW** switch on the control panel. During the shifting procedure, the **LOW** indicator lamp flashes three times per second in the instrument cluster.

Once the shifting procedure has been completed, the **LOW** indicator lamp lights up in the instrument cluster.

Deactivating off-road gear ratio

! Only carry out the gear selection if:

- the engine is running.
- the vehicle is rolling.
- the automatic transmission is in selector lever position **N**.
- you are driving at less than 70 km/h.

You could otherwise damage the transfer case.

- ▶ Press the **HIGH** transfer case switch on the control panel. During the shifting procedure, the **LOW** indicator lamp flashes three times per second in the instrument cluster.

Once the shifting procedure has been completed, the **LOW** indicator lamp in the instrument cluster goes out.

If a shifting procedure is unsuccessful, the transfer case shifts back into the neutral position. The **LOW** indicator lamp in the instrument cluster then flashes once per second.

Shifting to neutral

- ▶ Turn the key to position **2** (▷ page 87) in the ignition lock.
- ▶ Apply the parking brake.
- ▶ Depress the brake pedal.
- ▶ Move the selector lever to **N** (▷ page 91).
- ▶ Press the **LOW** switch for approximately five seconds.

When the shift procedure is complete, the **LOW** indicator lamp in the instrument cluster flashes once per second.

- i** If the transfer case is in **neutral**, the key is in the ignition lock and you open the driver's door, a warning tone sounds.

Differential locks

General notes

! To prevent damage to the transfer case, you may only operate the vehicle on a roller dynamometer (single-axle roller dynamometer) if:

- the axle that is not being driven is raised.
or
- the corresponding propeller shaft is disconnected and the transfer case differential lock is engaged.

Otherwise, the transfer case can be damaged.

Differential locks improve the traction of the vehicle.

Your vehicle is equipped with a differential lock each for:

- the transfer case: this controls the balance between the front and rear axles.
- the rear axle: this controls the balance between the wheels on the rear axle.
- the front axle: this controls the balance between the wheels on the front axle.

Engaging the differential locks

Important safety notes

WARNING

If you engage the differential lock when driving on a firm, high-traction surface, the steerability of the vehicle is severely impaired. You could lose control of the vehicle, especially when engaging on a bend. There is a risk of an accident.

Disengage the differential lock immediately when driving on a firm, high-traction surface.

WARNING

When the differential locks are engaged, ABS and BAS are deactivated. This could cause the wheels to lock and increases the braking distance. There is a risk of an accident.

Disengage the differential locks immediately on firm surfaces with good grip.

! Only engage the differential locks when:

- you are driving at walking pace.
- the driven wheels are not spinning.
- you are not driving on a firm road surface.

! The differential locks can also be engaged or disengaged when the blackout lighting setting is selected. The indicator lamps in the buttons and the warning lamps in the instrument cluster are switched off if you have engaged the differential lock.

General notes

The switches are on the control panel of the centre console.

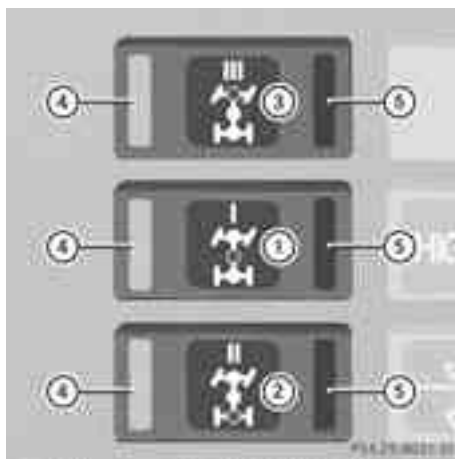

- ① Differential lock for the transfer case
- ② Differential lock for the rear axle
- ③ Differential lock for the front axle
- ④ Activation indicator lamps (yellow)
- ⑤ Function indicator lamps (red)

Engage the differential locks:

- off-road
- to deactivate ABS and BAS when off-road
- when fording

For further information on driving off-road, see (▷ page 106).



i You can only engage the differential locks in the following order: ①, ②, ③.

Differential lock for the transfer case

► **To engage:** press button ①.

Yellow activation indicator lamp ④ of button ① lights up.

Red function indicator lamp ⑤ of button ① lights up once the differential is locked.

The  warning lamp and the  indicator lamp then light up in the instrument cluster.

The differential lock for the transfer case is engaged.

ABS is deactivated.

Vehicle steerability is severely restricted. Drive carefully and accelerate gently for optimum traction.

- i** You can now engage the differential lock for rear axle ② and the differential lock for front axle ③ as required.

Differential lock for the rear axle

- ▶ **To engage:** press button ②. Yellow activation indicator lamp ④ lights up first, followed by red function indicator lamp ⑤ of button ②.

The differential lock for the rear axle is engaged.



Differential lock for the front axle

- ▶ **To engage:** press button ③. Yellow indicator lamp ④ lights up first, followed by red function indicator lamp ⑤ of button ③.

The differential lock for the front axle is engaged.

Disengaging the differential locks

You can disengage the differential locks in the following order: ③, ②, ①.

- ▶ **To simultaneously disengage all differential locks:** press button ①. Yellow activation indicator lamps ④ go out. Red function indicator lamps ⑤ go out once the differential locks have disengaged. After approximately three seconds of normal driving, ABS is activated. The  warning lamp and the  indicator lamp in the instrument cluster go out. All differential locks are disengaged.

If red function indicator lamps ⑤ do not go out when disengaging the differential locks:

- ▶ Observe the traffic situation.
- ▶ Make slight steering movements while the vehicle is in motion. Red function indicator lamps ⑤ go out when the differential locks are disengaged.

Towing a trailer

Notes on towing a trailer

Important safety notes

WARNING

The braking system can overheat if you leave your foot on the brake pedal while driving. This increases the braking distance and could even cause the braking system to fail. There is a risk of an accident.

Never use the brake pedal as a footrest. Do not simultaneously depress both the brake pedal and the accelerator pedal while driving.

WARNING

You could lose control of the vehicle/trailer combination if it begins to swerve. The vehicle/trailer combination could even overturn. There is a risk of an accident.

On no account should you attempt to straighten out the vehicle/trailer combination by increasing speed. Decrease your speed and do not countersteer. Brake if necessary.

WARNING

If the ball coupling has not been correctly fitted and has not been secured with the bolt supplied and the corresponding spring cotter, the trailer can detach. There is a risk of an accident.

Always fit and secure the ball coupling as described. Before beginning each journey, make sure that the fitted ball coupling is secured with the bolt supplied and the corresponding spring cotter.

You will find the applicable permissible values, which must not be exceeded, in the vehicle documents. You will find the values approved by the manufacturer on the vehicle identification plates and those for the towing vehicle in the "Technical data" section (▷ page 191).

Couple and uncouple the trailer carefully. If you do not couple the trailer to the towing vehicle correctly, the trailer could become detached.

Make sure that the following values are not exceeded:

- the permissible trailer drawbar noseweight
- the permissible trailer load
- the permissible rear axle load of the towing vehicle
- the maximum permissible gross vehicle weight of both the towing vehicle and the trailer

When towing a trailer, your vehicle's handling characteristics will be different in comparison to when driving without a trailer.

The vehicle/trailer combination:

- is heavier
- is restricted in its acceleration and gradient-climbing capability
- has an increased braking distance
- is affected more by strong crosswinds
- demands more sensitive steering
- has a larger turning circle

This can impair the vehicle's handling characteristics.

When towing a trailer, always adjust your speed to the current road and weather conditions. Do not exceed the maximum permissible speed for your vehicle/trailer combination.

General notes

! Use a drawbar noseweight as close to the maximum permissible noseweight as possible. Do not use a noseweight of less than

80 kg; otherwise, the trailer may come loose.

Note that the payload and the rear axle load are reduced by the actual payload.

- i** When towing a trailer, set the tyre pressure on the rear axle of the towing vehicle for a maximum load; see the tyre pressure table in the fuel filler flap (▷ page 177).

You will find installation dimensions and loads in the technical data (▷ page 198).

The maximum permissible trailer drawbar noseweight on the ball coupling is 140 kg.

However, the actual noseweight must not exceed the value given on the trailer identification plate or the trailer tow hitch. The lowest weight applies.

- i** When towing a trailer, set the tyre pressure on the rear axle of the towing vehicle for a maximum load; see the tyre pressure table in the fuel filler flap (▷ page 177).

- i** On vehicles without level control, the height of the ball coupling will alter according to the load placed on the vehicle. If necessary, use a trailer with a height-adjustable drawbar.

Driving tips

- ▶ On long and steep downhill gradients, select shift range **1, 2 or 3** (▷ page 93) in good time.
- ▶ If necessary, shift the transfer case to **LOW** (▷ page 110).

You make use of the braking effect of the engine and therefore need to brake less. This relieves the load on the brake system and prevents the brakes from overheating and wearing too quickly. If you need additional braking, depress the brake pedal repeatedly rather than continuously.

The maximum permissible speed for vehicle/trailer combinations depends on the type of trailer. Before beginning the journey, check the trailer's documents to see what the maximum permitted speed is. Observe the legally

prescribed maximum speed in the relevant country.

For certain Mercedes-Benz vehicles, the maximum permissible rear axle load is increased when towing a trailer. Refer to the "Technical data" section to find out whether this applies to your vehicle. If, while towing a trailer, there is an added maximum rear axle load, the vehicle/trailer combination may not exceed a maximum speed of 100 km/h for reasons concerning the operating permit. This also applies in countries in which the permissible maximum speed for vehicle/trailer combinations is above 100 km/h.

When towing a trailer, your vehicle's handling characteristics will be different in comparison to when driving without a trailer and it will consume more fuel.

Driving tips

If the trailer swings from side to side:

- ▶ Do not accelerate.
- ▶ Do not countersteer.
- ▶ Brake if necessary.
- Maintain a greater distance from the vehicle in front than when driving without a trailer.
- Avoid braking abruptly. If possible, brake gently at first to allow the trailer to run on. Then, increase the braking force rapidly.
- The values given for gradient-climbing capabilities from a standstill refer to sea level. When driving in mountainous areas, note that the power output of the engine, and consequently the vehicle's gradient-climbing capability, decrease with increasing altitude.

Trailer tow hitches

General notes

- ❗ Clean the trailer tow hitch if it is dirty.

Ball coupling trailer tow hitch



Example: ball coupling trailer tow hitch with 12-pin socket

- ① 12-pin socket, 24 V
- ② Ball coupling

Hook-type trailer tow hitch



Example: hook-type trailer tow hitch with 12-pin socket

- ① 12-pin socket, 24 V
- ② Hook

Coupling/decoupling a trailer

Important safety notes

WARNING

If you uncouple a trailer with an engaged overrun brake, you could trap your hand between the vehicle and the trailer drawbar. This poses a risk of injury.

Do not uncouple a trailer with an engaged overrun brake.

! Do not disconnect a trailer with an engaged overrun brake. Otherwise, your vehicle could be damaged by the rebounding of the overrun brake.

Coupling up a trailer

- ▶ Make sure that the transmission is in position **P**.
- ▶ Apply the parking brake.
- ▶ Position the trailer level behind the vehicle.
- ▶ Couple up the trailer.
- ▶ Establish the electrical connection between the vehicle and the trailer.

Decoupling a trailer

- ▶ Make sure that the transmission is in position **P**.
- ▶ Apply the parking brake.
- ▶ Secure the trailer against rolling away.
- ▶ Remove the trailer cable and decouple the trailer.

Trailer power supply

! You can connect accessories with a maximum power consumption of 360 W to the permanent power supply.

You must not charge a trailer battery using the power supply.

Depending on the equipment fitted, your vehicle has a 12-pin (24 V) and/or a 13-pin (12 V) trailer socket.

The 12-pin trailer socket of your vehicle is equipped at the factory with a permanent power supply.

The permanent power supply is supplied via trailer socket pin K.

You can find more information about fitting the trailer electrics at a qualified specialist workshop.

Trailer with 7-pin connector

General notes

You can make a connection to the 13-pin socket on the ball coupling using an adapter or, if necessary, an adapter cable. Both can be obtained at a qualified specialist workshop.

Fitting the adapter

! Make sure that there is sufficient cable play so that the cable cannot become detached when cornering.



- ▶ Open the socket cover.
- ▶ Insert the connector with lug ① into groove ② on the socket and turn the connector clockwise to the stop.
- ▶ Let the cover engage.
- ▶ If you are using an adapter cable, secure the cable to the trailer with cable ties.

Useful information	118
Important safety notes	118
Displays and operation	118
Warning and indicator lamps in the instrument cluster	120

Useful information

- i** This Owner's Manual describes all models, series and optional equipment for your vehicle that were available at the time of going to press. Country-specific differences are possible. Note that your vehicle may not be fitted with all features described. This is also the case for systems and functions relevant to safety.
- i** Read the information on qualified specialist workshops: (▷ page 15).

Important safety notes

WARNING

No information will be displayed if either the instrument cluster or the display is inoperative.

As a result, you will not be able to see warning and indicator lamps or information about the driving conditions, such as speed or outside temperature. Driving characteristics may be impaired. Adjust your driving style and vehicle speed accordingly.

Contact a qualified specialist workshop immediately.

WARNING

The operating safety of your vehicle could be impaired if maintenance work is carried out incorrectly. This could cause you to lose control of your vehicle and cause an accident. Moreover, the safety systems may no longer be able to protect you or others as they are designed to do.

Always have service work carried out at a qualified specialist workshop.

- !** If a blackout lighting setting has been selected, the instrument cluster lighting is switched off.

The instrument cluster and the display do not show any information.

You will find an illustration of the instrument cluster in the "At a glance" section (▷ page 19).

Displays and operation

Displaying the coolant temperature

The coolant temperature gauge is in the instrument cluster on the top right-hand side.

The reading may rise up to 120 °C under normal driving conditions if the coolant has been filled correctly.

At high outside temperatures and when driving uphill, the coolant temperature may rise to the end of the scale.

Rev counter

- !** Do not drive in the overrevving range. Doing so will damage the engine.

The rev counter shows the current engine speed. The diesel supply is interrupted to protect the engine when the maximum engine speed is reached.

Outside temperature display

WARNING

At temperatures just above freezing point, the street may be icy, especially in wooded areas or on bridges. If you do not adapt your driving style to the conditions, the vehicle could skid. For this reason, adapt your driving style and speed to the weather conditions.

The outside temperature display is in the display (▷ page 119).

Changes in the outside temperature are displayed after a short delay.

Activating the display



Example: instrument cluster recess

- ① Example: display with standard display
- ② To adjust the instrument cluster lighting: brighter
- ③ To adjust the instrument cluster lighting: dimmer
- ④ Inoperative
- ⑤ Total distance recorder/trip meter selector button, reset button

The display is activated when you:

- switch on the ignition
- switch on the battery main switch

Total distance recorded/trip meter

Distance recorder

- ▶ Press button ⑤ on the lower section of the instrument cluster (▷ page 119).
The display alternates between the total distance recorder and the trip meter display.

ASSYST service interval display

- ▶ Press button ⑤ twice in rapid succession.
The ASSYST service interval display (▷ page 145) is displayed.

Resetting the trip meter

- ▶ Press button ⑤ on the lower section of the instrument cluster (▷ page 119) repeatedly until the trip meter is displayed.
- ▶ Press button ⑤ again and keep it pressed until the display is reset.

Instrument cluster lighting





The lighting in the instrument cluster, in the displays and the controls in the vehicle interior can be adjusted using the brightness control knob.







With buttons ② and ③ at the lower section of the instrument cluster (▷ page 119), you can adjust the brightness of the instrument lighting.



- ▶ Make sure that the key is in position **2** in the ignition lock.
- ▶ Make sure that the side lamps, dipped-beam headlamps or main-beam headlamps are switched on.
- ▶ **Brighter:** press button ②.
- ▶ **Dimmer:** press button ③.

Warning and indicator lamps in the instrument cluster



Safety systems





Problem	Possible causes/consequences and ► Solutions
 <p>The yellow brake wear warning lamp is lit while the engine is running.</p>	<p>The brake pads/linings have reached their wear limit.</p> <ul style="list-style-type: none"> ► Have the brake pads/linings replaced as soon as possible at a qualified specialist workshop.
 <p>The red brake system warning lamp is lit while the engine is running.</p>	<p>There is an insufficient amount brake fluid in the fluid reservoir.</p> <p> WARNING</p> <p>The braking efficiency may be impaired. There is a risk of an accident.</p> <ul style="list-style-type: none"> ► Pull over and stop the vehicle safely as soon as possible, paying attention to road and traffic conditions. Do not continue driving under any circumstances. ► Secure the vehicle against rolling away (▷ page 100). ► Do not top up the brake fluid. Topping up will not rectify the fault. ► Consult a qualified specialist workshop.
 <p>The yellow ABS indicator lamp is lit while the engine is running.</p>	<p>ABS (Anti-lock Brake System) has been deactivated due to a fault. Therefore, EBD (electronic brake force distribution) is also switched off.</p> <p> WARNING</p> <p>The brake system continues to function normally, but without the functions listed above. The wheels could therefore lock if you brake hard, for example.</p> <p>The steerability and braking characteristics may be severely affected. The braking distance may increase in an emergency braking situation.</p> <p>There is an increased danger of skidding and risk of an accident.</p> <ul style="list-style-type: none"> ► Drive on carefully. ► Visit a qualified specialist workshop. <p>If the ABS control unit is malfunctioning, other systems may also not be available, e.g. the automatic transmission.</p>





Problem	Possible causes/consequences and ► Solutions
 <p>The yellow ABS indicator lamp is lit while the engine is running.</p>	<p>ABS is temporarily unavailable. BAS and EBD (Electronic Brake force Distribution), for example, are therefore also deactivated. The on-board voltage is too low.</p> <p> WARNING</p> <p>The brake system continues to function normally but without the functions listed above. The front and rear wheels could therefore lock, for example, if you brake hard.</p> <p>The steerability and braking characteristics may be severely affected. The braking distance may increase in an emergency braking situation.</p> <p>There is a risk of an accident.</p> <ul style="list-style-type: none"> ► Drive on carefully. ► Switch off consumers that are not required, e.g. the rear window heating or interior lighting. ABS will be available again as soon as the vehicle's on-board electrical system voltage increases. <p>If the warning lamp is still on:</p> <ul style="list-style-type: none"> ► Drive on carefully. ► Visit a qualified specialist workshop.
  <p>The red brake system warning lamp and the yellow ABS indicator lamp light up while the engine is running.</p>	<p> Risk of accident</p> <p>EBD has been deactivated due to a malfunction. ABS is also inoperative.</p> <p>The brake system continues to function normally, but without the functions listed above. The wheels could therefore lock if you brake hard, for example.</p> <ul style="list-style-type: none"> ► Drive on carefully. ► Visit a qualified specialist workshop immediately.
  <p>The yellow ABS indicator lamp and the yellow ABS warning lamp are lit while the vehicle is in motion.</p>	<p>You have engaged the differential locks. ABS is deactivated.</p> <ul style="list-style-type: none"> ► Disengage the differential locks. Subsequently ABS is reactivated.

Problem	Possible causes/consequences and ► Solutions
 <p>The red parking brake warning lamp comes on while the vehicle is moving. A warning tone also sounds.</p>	<p>You are driving with the parking brake applied.</p> <ul style="list-style-type: none"> ► Release the parking brake. The warning lamp goes out and the warning tone ceases.
 <p>The red SRS warning lamp does not light up in key position 2, flickers or is lit when the engine is running.</p>	<p>There is a malfunction in the SRS (Supplemental Restraint System).</p> <p> WARNING</p> <p>The airbags may either be triggered unintentionally or, in the event of an accident, may not be triggered. This poses an increased risk of injury.</p> <ul style="list-style-type: none"> ► Drive on carefully. ► Have SRS checked at a qualified specialist workshop immediately. <p>For further information about the Supplemental Restraint System; see (▷ page 24).</p>

Engine

Problem	Possible causes/consequences and ► Solutions
 <p>The yellow engine diagnostics warning lamp lights up while the engine is running.</p>	<p>There may be a fault, for example:</p> <ul style="list-style-type: none"> • in the fuel injection system • in the exhaust system <p>The emission limit values may be exceeded and the engine may be running in emergency mode.</p> <ul style="list-style-type: none"> ► Have the vehicle checked as soon as possible at a qualified specialist workshop.
 <p>The yellow reserve fuel warning lamp lights up while the engine is running.</p>	<p>The fuel level has dropped into the reserve range. The fuel gauge needle does not move any further down.</p> <p>Operation of the auxiliary heating is deactivated if the fuel level drops into the reserve range.</p> <ul style="list-style-type: none"> ► Refuel at the nearest filling station.
 <p>The preglow indicator lamp does not light up in key position 2.</p>	<p>The preglow indicator lamp is faulty.</p> <ul style="list-style-type: none"> ► Visit a qualified specialist workshop immediately.

Problem	Possible causes/consequences and ► Solutions
 <p>The preglow indicator lamp lights up while the engine is running.</p>	<p>The preglow system is malfunctioning.</p> <ul style="list-style-type: none"> ► Visit a qualified specialist workshop immediately.
 <p>The red battery warning lamp lights up while the engine is running.</p>	<p>The battery is not being charged. Possible causes:</p> <ul style="list-style-type: none"> • faulty alternator • torn poly-V-belt • an electronics fault <ul style="list-style-type: none"> ► Stop. ► Check the poly-V-belt. ► If it is torn: do not drive on. ► Consult a qualified specialist workshop. ► If it is not damaged: have the vehicle checked immediately at a qualified specialist workshop.
 <p>The red battery warning lamp lights up during or after fording.</p>	<p>The poly-V-belt is wet and is slipping on the drive pulley.</p> <ul style="list-style-type: none"> ► Drive on carefully. ► Accelerate gently. ► Do not switch off the engine. <p>The poly-V-belt will dry out after fording. The red battery charge indicator lamp goes out after 15 seconds.</p>
 <p>The red coolant warning lamp comes on while the engine is running.</p>	<p>The coolant level is too low.</p> <p>The coolant is too hot and the engine is no longer being cooled sufficiently.</p> <ul style="list-style-type: none"> ► Stop the vehicle immediately, paying attention to road and traffic conditions, and switch off the engine. ► Apply the parking brake. ► Leave the vehicle and keep a safe distance from the vehicle until the engine has cooled down. ► Check the coolant level and top up the coolant, observing the warning notes (► page 143). ► If you have to top up the coolant frequently, have the engine cooling system checked. ► Drive to the nearest qualified specialist workshop. ► Avoid subjecting the engine to heavy loads, e.g. driving in mountainous terrain, and stop-start driving.

Problem	Possible causes/consequences and ► Solutions
 <p>The red coolant warning lamp lights up while the engine is running.</p>	<p>If the warning lamp lights up regularly, the engine cooling system is leaking.</p> <ul style="list-style-type: none"> ► Have the engine cooling system checked at a qualified specialist workshop.
 <p>The red coolant warning lamp lights up while the engine is running.</p>	<p>If the coolant level is correct, the radiator fan may be faulty.</p> <ul style="list-style-type: none"> ► If the coolant temperature is less than 120 °C, you can continue driving to the nearest qualified specialist workshop. ► Avoid subjecting the engine to heavy loads, e.g. driving in mountainous terrain, and stop/start driving.
 <p>The red oil level warning lamp lights up while the engine is running.</p>	<p>The engine oil level has dropped to a critical level. There is a danger of engine damage.</p> <ul style="list-style-type: none"> ► Check the engine oil level (▷ page 142) and top up the oil if necessary (▷ page 143). ► Have the engine checked for leaks if the engine oil needs topping up more often than usual.
 <p>The yellow fuel/water separator warning lamp lights up while the engine is running.</p>	<p>The amount of water that has settled in the water separator has reached the maximum level. The water must be drained off.</p> <ul style="list-style-type: none"> ► Visit a qualified specialist workshop immediately.
 <p>The yellow air filter warning lamp lights up while the engine is running.</p>	<p>The engine air filter is dirty.</p> <ul style="list-style-type: none"> ► Have the air-cleaner filter element replaced as soon as possible at a qualified specialist workshop.
	<p>The air filter drain hoses are dirty.</p> <ul style="list-style-type: none"> ► Clean the air filter drain hoses.

Vehicle	
Problem	Possible causes/consequences and ► Solutions
<p>LOW</p> <p>The yellow transfer case indicator lamp flashes once per second.</p>	<p>The gear change process was cancelled due to a malfunction. The transfer case is in the neutral position.</p> <p>► Repeat the gear change process (▷ page 110).</p>
<p>LOW</p> <p>The yellow transfer case indicator lamp flashes every two seconds.</p>	<p>The transfer case is malfunctioning and running in emergency mode.</p> <p>► Do not shift the transfer case. ► Have the transfer case checked as soon as possible at a qualified specialist workshop.</p>
<p></p> <p>The yellow washer fluid level warning lamp lights up while the engine is running.</p>	<p>The washer fluid level in the washer fluid reservoir has fallen to one third of the reservoir capacity.</p> <p>► Top up the washer fluid (▷ page 144).</p>

Useful information	128
Loading guidelines	128
Stowage areas	129
Features	136

Useful information

- i** This Owner's Manual describes all models, series and optional equipment for your vehicle that were available at the time of going to press. Country-specific differences are possible. Note that your vehicle may not be fitted with all features described. This is also the case for systems and functions relevant to safety.
- i** Read the information on qualified specialist workshops: (▷ page 15).

Loading guidelines

⚠ WARNING

If objects, luggage or loads are not secured or not secured sufficiently, they could slip, tip over or be flung around and thereby hit vehicle occupants. There is a risk of injury, especially when braking or abruptly changing directions.

Always store objects so that they cannot be flung around. Secure objects, luggage or loads against slipping or tipping before the journey.

⚠ WARNING

If you load the vehicle unevenly, driving characteristics such as steering and braking behaviour may be severely impaired. There is a risk of an accident.

Load the vehicle evenly. Secure the load so that it cannot slip.

⚠ WARNING

Combustion engines emit poisonous exhaust gases such as carbon monoxide. If the tail-gate/rear door is open when the engine is running, particularly if the vehicle is moving, exhaust fumes could enter the passenger compartment. There is a risk of poisoning.

Turn off the engine before opening the tail-gate/rear door. Never drive off with the tail-gate/rear door open.

! The non-slip mats cannot be used for securing loads and must be replaced should the following become apparent:

- signs of deformation or development of squashed areas
- traces of cracking
- cutting

After an accident, have the following checked at a specialist workshop:

- damaged load compartment floor
- damaged load surface
- lashing eyelets
- lashing material

Otherwise, when you next transport a load, it may not be sufficiently secured.

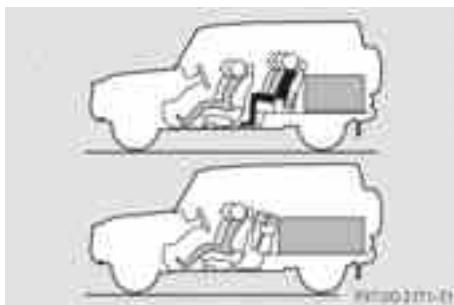

Load distribution (example: station wagon)

Driving, braking and steering characteristics change depending on:

- type of load
- weight
- the centre of gravity of the load

You should therefore load your vehicle as shown in the illustrations.

Observe the following notes when transporting a load:

- when transporting a load, never exceed the maximum permissible gross vehicle weight or the permissible axle loads for the vehicle (including occupants).
- position heavy loads as far forwards as possible and as low down in the luggage compartment as possible.

- the load must not protrude above the upper edge of the seat backrests.
- always place the load against the front or rear seat backrests.
- always place the load behind unoccupied seats if possible.
- if possible, always transport the load in the load compartment with the seat backrests folded up and engaged.

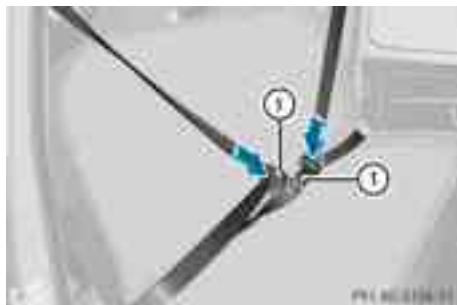

If the rear bench seat is not occupied:

- ▶ Insert ① the belt tongues into the buckles of the opposite seat belt in a diagonal pattern.
- ▶ Secure the load with sufficiently tear-resistant and wear-resistant lashing material.
- ▶ Pad any sharp edges.
- take measures to prevent a load slipping by keeping the load compartment floor dry, swept clean and free from oil and dust and by using anti-slip mats.
- check the securing of loads before every journey and at regular intervals during a long journey.
- adjust the cone of light from the headlamps to suit the vehicle load (▷ page 61).
- adjust the tyre pressure to suit the vehicle load (▷ page 177).

For platform vehicles:

- where possible, load the platform in such a way that the centre of gravity is in the middle.
- take care when loading rocks, rubble or bulky waste. Do not drop them onto the platform from a great height.
- use tensioning chains as required to prevent the loading tailgate from bending outwards.
- make sure that the platform dropsides are closed during the journey (▷ page 45).

- i** Lashing material that has been checked in accordance with applicable standards is available at any qualified specialist workshop.
- i** Information on professional load-securing can be obtained from the manufacturers of transportation aids or lashing material for load-securing, for example.

Stowage areas

Stowage compartments

Important safety notes

WARNING

If you do not correctly store objects in the vehicle interior, they can slip or be flung around, thus striking vehicle occupants. There is a risk of injury, especially when braking or abruptly changing directions.

- Always store objects so that they cannot be flung around in these or in similar situations.
- Always make sure that objects do not protrude from stowage compartments, luggage nets or stowage nets.
- Close lockable stowage compartments while driving.
- Stow and secure objects that are heavy, hard, pointy, sharp-edged, fragile or too large in the luggage compartment.

Observe the loading guidelines (▷ page 128).

Front stowage compartments

Glove compartment

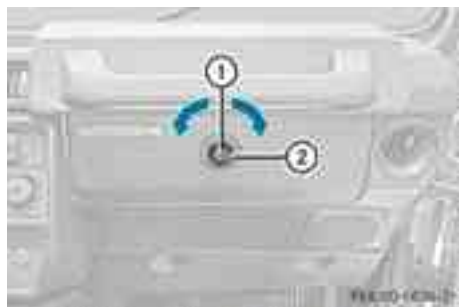

You can lock and unlock the glove compartment using designated key ①.

- ▶ **To open:** turn handle ② anti-clockwise and fold the cover down.
- ▶ **To close:** fold the cover up and press until it engages.

Door stowage compartments



① Door stowage compartment

There is a door stowage compartment on both of the front doors.

Rear stowage compartments

Map pockets

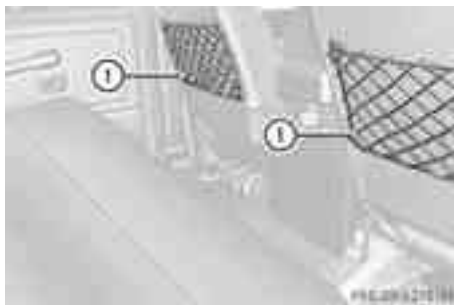

① Map pockets

Enlarging the luggage compartment

Important safety notes

⚠ WARNING

Combustion engines emit poisonous exhaust gases such as carbon monoxide. If the tail-gate/rear door is open when the engine is running, particularly if the vehicle is moving, exhaust fumes could enter the passenger compartment. There is a risk of poisoning.

Turn off the engine before opening the tail-gate/rear door. Never drive off with the tail-gate/rear door open.

Observe the loading guidelines (▷ page 128).

The rear bench seat or the individual seats in the rear compartment can be folded forward to increase capacity of the rear compartment. The following changes are possible:

- fold the seat backrest forward
- fold the rear bench seat/individual seat in the rear compartment forward completely

Folding the seat backrest forwards

Rear bench seat

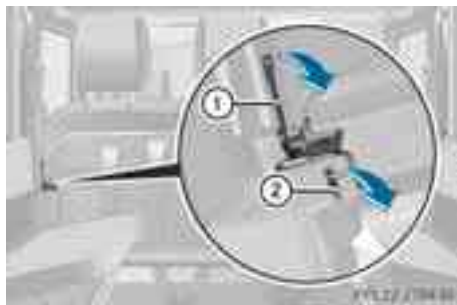

Seat backrest release lever

- ① Long lever
- ② Short lever

i Station wagon: open the rear doors. This allows you better access to the release lever.

- ▶ Remove the head restraints (▷ page 53).
- ▶ Pull short lever ② in the direction of the arrow and hold it.
- ▶ Pull long lever ① in the direction of the arrow and fold the seat backrest forwards.

Individual seats in the rear compartment



Example: station wagon

- ① Seat backrest release lever
- ② Individual seat release lever

- ▶ Pull release lever ①.
The corresponding seat backrest is released.
- ▶ Fold the seat backrest forward until it engages.

Folding back the seat backrest

! Make sure that the seat belt does not become trapped when folding the rear seat backrest back. Otherwise, it could be damaged.

- ▶ **Rear bench seat:** fold the seat backrest backwards.
- ▶ **Individual seat in the rear compartment:** pull release lever ① and fold the seat backrest backwards.
- ▶ Fold the seat backrest back until it engages audibly in the seat catch.
- ▶ **Rear bench seat:** fit the head restraints (▷ page 53).

Folding the rear bench seat forwards



- ▶ Fold the backrest forwards.
- ▶ Lift the back of the rear bench seat and fold it forward in the direction of the arrow.
- i** When the rear bench seat is folded forwards, you can stow the rear head restraints in the brackets on the underside of the seat backrest.

Folding the rear bench seat into an upright position

WARNING

If the rear bench seat/rear seat and seat backrest are not engaged they could fold forwards, e.g. when braking suddenly or in the event of an accident.

- The vehicle occupant would thereby be pushed into the seat belt by the rear bench seat/rear seat or by the seat backrest. The seat belt cannot protect as intended and could result in additional injury.
- Objects or loads in the boot/luggage compartment cannot be restrained by the seat backrest.

This poses an increased risk of injury.

Before every trip, make sure that the seat backrests and the rear bench seat/rear seat are engaged before every trip.

- ▶ Fold the rear bench seat back.
The seat catch engages audibly.
- ▶ Fold the backrest backwards (▷ page 131).
- ▶ Fit the head restraints (▷ page 53).

Folding the individual seat in the rear compartment forwards

WARNING

If the rear bench seat/rear seat and seat backrest are not engaged they could fold forwards, e.g. when braking suddenly or in the event of an accident.

- The vehicle occupant would thereby be pushed into the seat belt by the rear bench seat/rear seat or by the seat backrest. The seat belt cannot protect as intended and could result in additional injury.
- Objects or loads in the boot/luggage compartment cannot be restrained by the seat backrest.

This poses an increased risk of injury.

Before every trip, make sure that the seat backrests and the rear bench seat/rear seat are engaged before every trip.

- ▶ Fold back the individual seat in the rear compartment until it engages audibly in the seat catch.
- ▶ Fold the backrest backwards (▷ page 131).
- ▶ Make sure that the head restraints are fitted (▷ page 53).

Folding individual seats in the rear compartment into position

WARNING

If the rear bench seat/rear seat and seat backrest are not engaged they could fold forwards, e.g. when braking suddenly or in the event of an accident.

- The vehicle occupant would thereby be pushed into the seat belt by the rear bench seat/rear seat or by the seat backrest. The seat belt cannot protect as intended and could result in additional injury.
- Objects or loads in the boot/luggage compartment cannot be restrained by the seat backrest.

This poses an increased risk of injury.

Before every trip, make sure that the seat backrests and the rear bench seat/rear seat are engaged before every trip.

- ▶ Fold back the individual seat in the rear compartment until it engages audibly in the seat catch.
- ▶ Fold the backrest backwards (▷ page 131).
- ▶ Make sure that the head restraints are fitted (▷ page 53).

Securing a load

Important safety notes

! Observe the notes regarding the maximum load capacity of individual lashing points.

If you combine several lashing points to secure a load, you must always observe the maximum loading capacity of the weakest lashing point.

For example, when the brakes are fully applied, forces act which can be many times that of the weight force of the load.

To distribute the load evenly, always use several lashing points. Load the lashing points as evenly as possible.

Distribute the load on the lashing eyelets evenly.

Do not tamper with or repair lashing points, lashing eyelets or lashing material. Have maintenance work as well as modifications, installations and conversions carried out at a qualified specialist workshop (▷ page 15).

As the driver, you are fundamentally responsible for the load being secured against slipping, tipping, rolling or falling down. This applies to both usual traffic conditions as well as to swerving or full brake application and on bad roads.

If you do not secure loads in compliance with the applicable requirements and technical rules, you may become liable to prosecution. This is dependent on legislation and the resulting consequences.

Therefore, always observe the relevant country-specific legal requirements.

When using suitable transportation aids and lashing material, always observe the operating instructions of the respective manufacturer. Pay particular attention to the notes on materials which are ready to be discarded.

Transportation aids and lashing material must not be used if there is, for example:

- no identification or the identification is illegible
- yarn breakage, damage to the load-bearing seams or other traces of crack formation
- cuts, deformation, crushing or other damage
- damage to the tensioning elements or fasteners.

These transportation aids and lashing materials are ready to be discarded, must not be used and should be replaced.

If you use transportation aids and lashing materials that are ready to be discarded, the load is not secured sufficiently.

Observe the following notes on securing loads:

- secure the load using the lashing eyelets.
- do not use elastic straps or nets to secure a load. These are only intended as anti-slip protection for light loads.
- use only lashing material with a minimum tensile strength of $F_{perm} = 600 \text{ daN}$ and an elongation of approximately 7%.
- do not route lashing materials across sharp edges or corners.
- pad sharp edges for protection.
- only use lashing material that has been checked in accordance with applicable standards, e.g. lashing nets or lashing straps.
- load compartment trays which cover the lashing eyelets must be removed before securing the load.
- fill the spaces between the load and the load compartment walls and the wheel mountings in a form-locking way. Only use dimensionally stable transportation aids for this, such as chocks, wooden fixings or padding.
- secure the load, depending on the vehicle equipment, in all directions at the lashing

points or the lashing eyelets in the load compartment or on the load area.

- always use the lashing eyelets and lashing points that are located as near as possible to the load.

i Loose loads on a platform load area can be secured with an approved lashing net or a tarpaulin.

Lashing eyelets in the load compartment



There are six lashing eyelets in the load compartment.

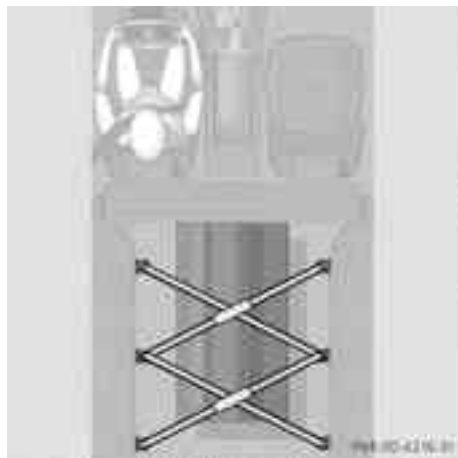

Guide the load restraints in a cross pattern over the load, as shown in the illustration.

Securing rails in the load compartment

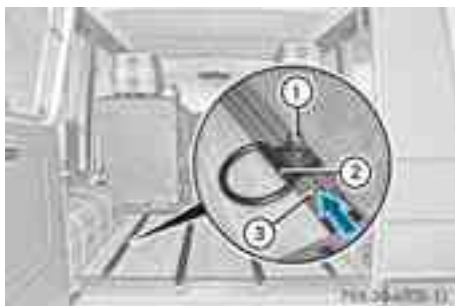

- ▶ **To fit the lashing eyelet:** insert lashing eyelet ② into securing rail ③ in the direction of the arrow.
- ▶ Move lashing eyelet ② into the desired position.
- ▶ Tighten cap nut ①.
Lashing eyelet ② is fastened.

Platform truck lashing eyelets

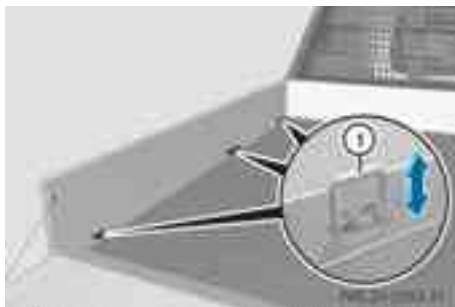

① Lashing eyelet

There are three lashing eyelets attached to each side of the platform.

i The maximum tensile load (permissible nominal tensile load) of the lashing eyelets on the platform is 800 daN each.

i Lashing eyelets ① are flush when not in use.

- ▶ When they are to be used, pull up relevant lashing eyelet ① by its loop.
- ▶ Always fasten lashing nets or tarpaulins to all available lashing eyelets ①. Make sure

that the mounting hooks are secured to prevent unintentional release.

Platform truck lashing points



① Lashing point

- i If you have removed the platform dropsides, you can also use the lashing points at the bottom left and right on the cross members.
- ▶ Always fasten lashing nets or tarpaulins by all available lashing points ①. Make sure that the mounting hooks are secured to prevent unintentional release.

Stowage compartment (platform truck)

⚠ WARNING

If the maximum permissible load of the stowage compartment is exceeded or the stowage compartment is not locked, the cover cannot restrain the objects. Objects could slip onto the road surface. There is a risk of an accident and injury.

Always comply with the maximum permissible load of the stowage compartment. Before starting the journey, make sure that the stowage compartment is locked.



A stowage compartment for accessories is located at the front on the right underneath the platform. It has a permissible load weight of 10 kg.

- ▶ **To open:** hold stowage compartment flap ① with one hand.
- ▶ With the other hand, pull stowage compartment flap frame ③ upwards by handle ②.
- ▶ Open stowage compartment flap ① slightly and carefully release it. The stowage compartment flap ① folds fully downwards.
- i Open flap ① approximately 45° and tilt flap frame ③ slightly downward. The flap frame holds flap ① in the semi-open position.
- ▶ **To close:** with one hand, pull up stowage compartment flap frame ③ fully by handle ②.
- ▶ With the other hand, push stowage compartment flap ① closed and keep it closed.
- ▶ Fold stowage compartment flap frame ③ fully downwards until it engages.
- ▶ Ensure that the locking mechanisms on the left and right underneath the stowage compartment are engaged.
- i The content of the stowage compartment can be secured with a U-lock on the eyelet by the handle ②.

Roof carrier

⚠ WARNING

When a load is transported on the roof, the vehicle's centre of gravity rises and the handling changes. If you exceed the maximum roof load, the handling as well as steering and braking characteristics are severely affected. There is a risk of an accident.

Always observe the maximum roof load and adapt your driving style.

An incorrectly secured roof carrier or roof load may become detached from the vehicle. Use a roof carrier approved by Mercedes-Benz. You must observe the installation instructions of the roof carrier manufacturer and the maximum roof load of 200 kg.

Features

Sun visors

Sun visor overview

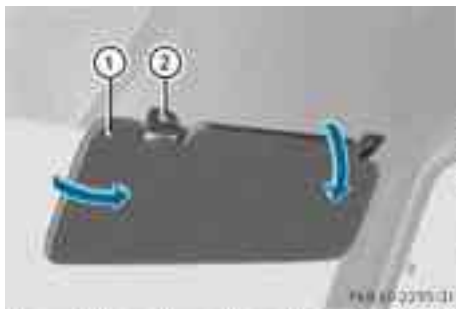

- ① Sun visor
- ② Bracket

Glare from the side

- ① Sun visor
- ② Bracket
- ▶ Fold down sun visor ①.
- ▶ Pull sun visor ① from bracket ②.
- ▶ Swing sun visor ① to the side.

Sockets

General notes

❗ If accessories are connected, make sure that a maximum current draw of 15 A is not exceeded. Otherwise, you will overload the fuse.

If you use the sockets for long periods when the engine is switched off, the battery may discharge.

12 V socket



You can use the 12 V socket for accessories up to a maximum of 180 W.

- ▶ Lift up cover ① of the 12 V socket.

24 V power socket



You can use the 24 V socket for accessories with a maximum power consumption of 360 W.

- ▶ Lift up cover ① of the 24 V socket.

24 V interface (panel van / station wagon)

- !** If accessories are connected, make sure that a maximum current draw of 40 A is not exceeded. Otherwise, you will overload the fuse.



You can use the 24 V interface for additional consumers with a maximum power consumption of 960 W.

- Unscrew cover cap ①.

Winch socket

! WARNING

Only use the winch when the vehicle is stationary. Make sure that:

- the winch is attached properly
- the vehicle is properly secured against rolling away

Always observe the notes on operation and safety in the operating instructions of the winch manufacturer.



The winch socket is located at the front on the right-hand side under the bumper.

- i** If the engine is switched off, only use the winch briefly. The battery may otherwise discharge.
- Unscrew cover ① of winch socket ② anti-clockwise and fold it to one side.



The winch socket is deactivated. You must activate it before use.

- i** Use the adapter plug of the winch cable if necessary.
- **To activate:** press the upper section of switch ①.
The indicator lamp in switch ① lights up.
- **To deactivate:** press the lower section of switch ①.
Indicator lamp in the ① switch goes out.

Walk-on bonnet

- !** Do not exceed a load of 120 kg on the bonnet. Only walk on the bonnet when it is closed and locked. You could otherwise damage the bonnet.
- i** The bonnet is reinforced so that it can take your weight. The area with the roughened surface provides better grip.
- i** The walk-on bonnet can be used for better access to the roof rack, for instance.

- ▶ Only mount the bonnet from the centre at the front.
- ▶ Only stand on the area intended for this purpose.

Bodystyling bar

- ❗ If the bodystyling bar must be removed, contact a qualified specialist workshop.

Assembly tool

General notes



On vehicles with the radio aerial on the wing, assembly tool ① is included in the scope of delivery and assists in removing and securing the radio aerial. The assembly tool is on the vehicle key ring.

Removing/securing the radio aerial



To remove the radio aerial:

- ▶ Place assembly tool ① around radio aerial ②.
- ▶ With assembly tool ①, loosen radio aerial ② anti-clockwise.
- ▶ Remove the assembly tool from the radio aerial.
- ▶ Manually unscrew the radio aerial anti-clockwise.

To secure the radio aerial:

- ▶ Manually screw the radio aerial in clockwise.
- ▶ Place assembly tool ① around radio aerial ②.
- ▶ With assembly tool ①, screw in radio aerial ② clockwise until tight.
- ▶ Remove the assembly tool from the radio aerial.

Floormat on the driver's side

⚠ WARNING

Make sure that there is sufficient clearance around the pedals when floormats are used, and that the floormats are properly secured. The floormats must be correctly secured at all times using the securing knob and retainers. Before you drive off, check the floormats and secure them if necessary. A floormat which is not properly secured can slip and thereby interfere with the movement of the pedals. Do not place floormats on top of one another.

Useful information	140
Engine compartment	140
Service	145
Care	147

Useful information

- i** This Owner's Manual describes all models, series and optional equipment for your vehicle that were available at the time of going to press. Country-specific differences are possible. Note that your vehicle may not be fitted with all features described. This is also the case for systems and functions relevant to safety.
- i** Read the information on qualified specialist workshops: (▷ page 15).

Engine compartment

Bonnet

Important safety notes

⚠ WARNING

An unlocked bonnet may open while driving and block your view. There is a risk of an accident.

Never unlock the bonnet while driving.

⚠ WARNING

Certain components in the engine compartment may be very hot, e.g. the drive system and radiator. When carrying out work in the engine compartment there is a risk of injury. If possible, let the drive system cool down and only touch the following described components.

⚠ WARNING

If you open the bonnet while the engine is overheating or while there is a fire in the engine compartment, you could come into contact with hot gases or other leaking service products. There is a danger of injury. Allow an overheating engine to cool down before opening the bonnet. If there is a fire in the engine compartment, leave the bonnet closed and notify the fire brigade.

⚠ WARNING

The ignition system and the fuel injection system operate with a high voltage. If you touch the live components, you could receive an electric shock. There is a danger of injury. Never touch components of the ignition system or the fuel injection system when the ignition is switched on.

⚠ WARNING

When the bonnet is open, and the windscreen wipers are set in motion, you can be injured by the wiper linkage. There is a risk of injury. Always switch off the windscreen wipers and the ignition before opening the bonnet.

- !** Make sure that the windscreen wipers are not folded away from the windscreen. Otherwise, you could damage the windscreen wipers or the bonnet.

Do not touch the following when the ignition is switched on:

- ignition coils
- spark plug connectors
- diagnostics socket

Opening the bonnet



The bonnet release lever is located in the driver's footwell.

- ▶ Make sure that the windscreen wipers are switched off.
- ▶ Pull release lever ① on the bonnet. The bonnet is released.

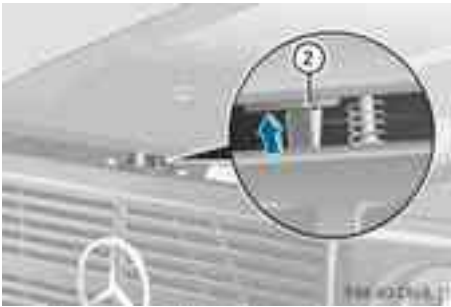

Vehicles with gas struts

- ▶ Lift the bonnet slightly.
- ▶ Push bonnet catch handle ② in the direction of the arrow and lift the bonnet. The gas strut opens the bonnet automatically.

Vehicles with a bonnet support

- ▶ Lift the bonnet slightly.
- ▶ Push bonnet catch ② in the direction of the arrow and lift the bonnet.

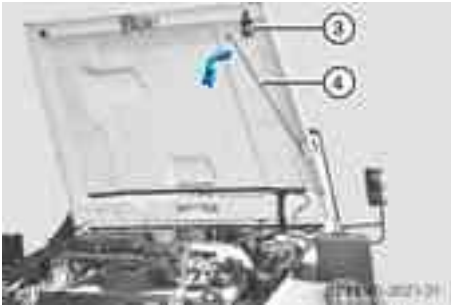

- ▶ Pull bonnet support ④ from bracket ③.



- ▶ Insert bonnet support ④ into recess ⑤.

Opening the bonnet fully

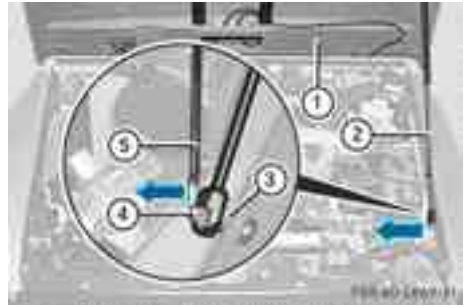

Vehicles with a gas-filled strut

- ▶ Lift safety clip ④ with a suitable tool, e.g. screwdriver ⑤, in the direction of the arrow.
- ▶ Push gas-filled strut ② off ball fixture ③ in the direction of the arrow.
- ▶ Raise bonnet ① carefully, until it rests against the windscreen. The bonnet is open fully.
- ▶ **To secure the gas-filled strut:** push gas-filled strut ② onto ball fixture ③ until it engages audibly.

Vehicles with a bonnet support

- ▶ Fold back the bonnet carefully, until it rests against the windscreen. The bonnet is open fully.

Closing the bonnet

WARNING

An unlocked bonnet may open while driving and block your view. There is a risk of an accident.

Never unlock the bonnet while driving.

Vehicles with a gas-filled strut

- ▶ Make sure that gas-filled strut ② is engaged on ball fixture ③ (▷ page 141).
- ▶ Lower the bonnet and let it fall from a height of approximately 20 cm.
- ▶ Check that the bonnet has engaged properly.
If the bonnet can be raised slightly, it is not properly engaged. Open it again and close it with a little more force.

Vehicles with a bonnet support

- ▶ Make sure that bonnet support ④ is engaged in fixture ③ (▷ page 141).
- ▶ Lower the bonnet and let it fall from a height of approximately 20 cm.
- ▶ Check that the bonnet has engaged properly.
If the bonnet can be raised slightly, it is not properly engaged. Open it again and close it with a little more force.

Radiator

- ❗ Do not cover up the radiator. Do not use thermal mats, insect protection covers or anything similar. Doing so can cause the Onboard Diagnostics System to display inaccurate values. Some of these values are legally required and must always be correct.

Engine oil

Notes on oil level

Depending on your driving style, the vehicle consumes up to 0.8 litres of oil per 1,000 km. The oil consumption may be higher than this when the vehicle is new or if you frequently drive at high engine speeds.

Checking the oil level using the oil dipstick

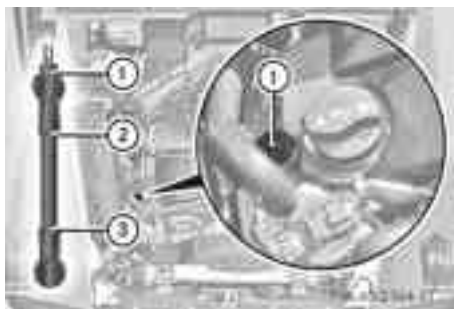





When checking the oil level:

- park the vehicle on a level surface.
 - the engine should be switched off for approximately five minutes if the engine is at normal operating temperature.
 - the engine should be switched off for at least 30 minutes if the engine is not at operating temperature, e.g. if you only start the engine briefly.
- ▶ Pull dipstick ① out of the dipstick tube.
 - ▶ Wipe off dipstick ①.
 - ▶ Slowly slide dipstick ① into the guide tube to the stop, and take it out again.
If the level is between MIN mark ③ and MAX mark ②, the oil level is correct.
 - ▶ Top up the oil if necessary.

Checking the oil level using the instrument cluster



- ▶ Turn the key to position **2** in the ignition lock.
- ▶ Wait approximately ten seconds until the  and  symbols light up in the instrument cluster display.
- ▶ Press selector button  on the instrument cluster twice within a second.
- ▶ Top up the oil if necessary.

If the  symbol flashes in the instrument cluster display, correct measurement was not possible.

- ▶ Repeat the measurement after about five minutes if the engine is at normal operating temperature.
- ▶ Repeat the measurement after approximately 30 minutes if the engine is not at normal operating temperature.

The amount to be added (if required) is shown in the display:

Display	
OK	The oil level is correct.
-1.0 L	Add 1.0 litre of engine oil.
-1.5 L	Add 1.5 litres of engine oil.
-2.0 L	Add 2.0 litres of engine oil.
HI	Have excess oil siphoned off.

Adding engine oil

Environmental note

When topping up the oil, take care not to spill any. If oil enters the soil or waterways, it is harmful to the environment.

- !** Do not add too much oil. If the oil level is above the "max" mark on the dipstick, too much oil has been added. This can lead to damage to the engine or the catalytic converter. Have excess oil siphoned off.



- ▶ Turn cap  anti-clockwise and remove it.
- ▶ Top up with the amount of oil required.

Observe the specifications in the on-board computer when doing so or fill carefully to the maximum mark on the oil dipstick.

For further information on engine oil, see (> page 194).

- i** The difference between the minimum mark and the maximum mark on the oil dipstick is approximately 1.5 litres.
- ▶ Replace cap  on the filler neck and tighten clockwise. Make sure that the cap locks securely into place.

Other service products

Checking the coolant level

WARNING

The engine cooling system is under pressure, particularly if the engine is warm. You could be scalded by hot coolant spraying out when opening the cap. There is a danger of injury. Allow the engine to cool before opening the cap. Wear gloves and protective eyewear when opening. Slowly turn the cap half a turn to allow pressure to escape.



- ▶ Park the vehicle on a level surface. Only check the coolant level if the vehicle is on a level surface and the engine has cooled down.
- ▶ Slowly turn cap ① half a turn anti-clockwise to allow excess pressure to escape.
- ▶ Turn cap ① further anti-clockwise and remove it. If the coolant is at the level of marker bar ② when cold, there is enough coolant in coolant expansion tank.
- ▶ If necessary, top up with coolant that has been tested and approved by Mercedes-Benz.
- ▶ Replace cap ① and turn it clockwise as far as it will go.

For further information on coolant, see (▷ page 195).

Topping up the windscreen washer system/headlamp cleaning system

⚠ WARNING

Windscreen washer concentrate is highly flammable. If it comes into contact with hot engine components or the exhaust system it could ignite. There is a risk of fire and injury. Make sure that no windscreen washer concentrate is spilled next to the filler neck.

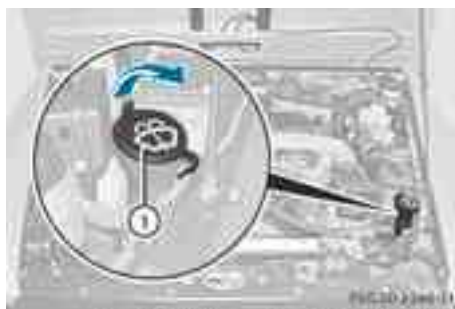

Example: washer fluid reservoir

- ▶ **To open:** pull cap ① upwards by the tab.
- ▶ Top up with the premixed washer fluid.
- ▶ **To close:** press cap ① onto the filler neck until it engages.

The washer fluid reservoir is used for both the windscreen washer system and the headlamp cleaning system.

Further information on windscreen washer fluid/antifreeze (▷ page 196).

Air filter

Dirt, water and other residue from the air filter are ejected via two valves. If the valves become clogged by pollutants, dirt, water and other residue collect in the drain hoses of the valves. The valves must then be cleaned.

- ⚠ The air filter valves must be cleaned especially after off-road driving. Inadequate care may result in dirt, water and other residue entering the air-cleaner housing, and this may cause engine damage.

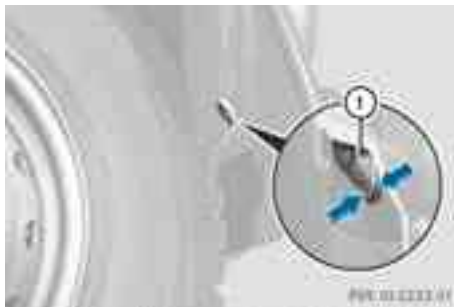

The air filter valves are located in the wheel arch on the right-hand side, when viewed in the direction of travel.

To clean the valves:

- ▶ Turn the steering to the right.
- ▶ Squeeze dust valve ①.
- ▶ Dirt, water and other residue are expelled.
- ① Clean dust valve ① with water if soiled.



- ▶ Squeeze water valve ②.
- ▶ Water, dirt, and other debris is expelled.
- ① Clean water valve ② with water if soiled.

Service

ASSYST service interval display

Service messages

Information on the type of service and service intervals (see separate Service Booklet).

You can obtain further information from a Mercedes-Benz Service Centre.

The ASSYST service interval display informs you of the next service due date.

Whenever a service is due, this is shown in the display approximately a month beforehand.

If a service due date has been exceeded, you also hear a warning tone.

If a service due date has been exceeded, you also see the following messages in the display:

- after switching on the ignition, the service message flashes for a few seconds.
- a minus sign before the service due date.



Maintaining the time-dependent service schedule:



- ▶ Note down the service due date displayed before disconnecting the battery.

Or:

- ▶ After reconnecting the battery, subtract the battery disconnection periods from the service date shown on the display.

- ① The service message does not provide information about the engine oil level. Do not confuse the service indicator with the  engine oil level display. This can be called up separately (▶ page 142).

A short time after switching on the ignition, you will see the service message for a few seconds in display ①.

-  Minor service
-  Major service

- ① The service due date is displayed in kilometres, depending on the total distance driven. If the remaining distance is not reached within a year, the remaining time in days is shown automatically.

The ASSYST service interval display does not take into account any periods of time during which the battery is disconnected.

Hiding a service message

- ▶ Press selector button ② below the display (▷ page 145).

Displaying service messages

- ▶ Switch the ignition on.
The standard display appears in the display.
- ▶ Briefly press selector button ② below the display twice.
The service due date appears.

Resetting a service message

! If the ASSYST service interval display has been inadvertently reset, this setting can be corrected at a Mercedes-Benz Service Centre.

Have service work carried out as described in the Service Booklet. This may otherwise lead to increased wear and damage to the major assemblies or the vehicle.

If the service carried out on your vehicle is not performed at a Mercedes-Benz Service Centre, you can reset the service message yourself.

- ▶ Switch the ignition on.
The standard display appears in the display (▷ page 119).
- ▶ Immediately press selector button ② below the display twice briefly.
- ▶ Turn the key in the ignition lock back to position **0** within the next ten seconds to reset.
- ▶ Press down and hold selector button ②.
- ▶ Switch on the ignition again and at the same time keep selector button ② pressed down.
The service message with the current remaining distance or remaining time is shown in the instrument panel display.
After approximately ten seconds you will hear an acoustic signal. A service message

showing a new value is shown in the instrument panel display.

- ▶ Release selector button ②.
The service message is now reset.

Information about Service

The prescribed service interval is based on normal operation of the vehicle. Service work will need to be performed more often if the vehicle is operated under arduous conditions or increased loads, for example:

- regular city driving with frequent intermediate stops
- if the vehicle is primarily used to travel short distances
- for frequent operation in mountainous terrain or on poor road surfaces
- if the engine is often left idling for long periods

In these or similar operating conditions, have the air filter, engine oil and oil filter, for example, changed more frequently. The tyres must be checked more frequently if the vehicle is operated under increased loads. Further information can be obtained at a qualified specialist workshop, e.g. a Mercedes-Benz Service Centre.

Fuel/water separator

Environmental note

Dispose of service products in an environmentally-responsible manner.

! If you continue driving without having the fuel/water separator serviced, this could cause damage to the engine. Any resulting damage is not covered by the warranty.



When you switch on the ignition, the fuel/water separator warning lamp in the instrument cluster lights up for a second (function check) and then goes out.

The fuel/water separator needs servicing if:

- warning lamp ① does not go out after you switch on the ignition.
 - warning lamp ① lights up while the engine is running.
- Visit a qualified specialist workshop as soon as possible.

Care

General notes

! For cleaning your vehicle, do not use any of the following:

- dry, rough or hard cloths
- abrasive cleaning agents
- solvents
- cleaning agents containing solvents

Do not scrub.

Do not touch the surfaces or protective films with hard objects, e.g. a ring or ice scraper. You could otherwise scratch or damage the surfaces and protective film.

! Do not park up the vehicle for an extended period straight after cleaning it, particularly after having cleaned the wheels with wheel cleaner. Wheel cleaners could cause increased corrosion of the brake discs and brake pads/linings. For this reason, you

should drive for a few minutes after cleaning. Braking heats the brake discs and the brake pads/linings, thus drying them. The vehicle can then be parked up.

Environmental note

Dispose of empty packaging and cleaning cloths in an environmentally responsible manner.

Regular care of your vehicle is a condition for retaining the quality in the long term.

Use care products and cleaning agents recommended and approved by Mercedes-Benz.

Care of the exterior

Automatic car wash

⚠ WARNING

Braking efficiency is reduced after the vehicle has been washed. There is a risk of an accident.

After washing the vehicle, brake carefully while paying attention to the traffic conditions in order to restore full braking efficiency.

! Make sure that the automatic car wash is suitable for the size of the vehicle. Fold in the exterior mirrors before the vehicle is washed. The exterior mirrors could otherwise be damaged.

! Make sure that the automatic transmission is in position **N** when washing your vehicle in a tow-through car wash. The vehicle could be damaged if the transmission is in another position.

! Make sure that:

- the side windows are closed completely.
- the blower for the ventilation/heating is switched off.
- the windscreen wiper switch is at position **0**.

The vehicle could otherwise be damaged.

You can wash the vehicle in an automatic car wash from the very start.

Wash off excess dirt before cleaning the vehicle in an automatic car wash.

After using an automatic car wash, wipe off wax from the windscreen and the wiper blades. This will prevent smears and reduce wiping noises caused by residue on the windscreen.

High-pressure cleaning equipment

WARNING

The water jet of circular-jet nozzles (dirt grinders) can cause damage not visible from the outside to tyres or chassis components. Components damaged in this way can unexpectedly fail. There is a risk of an accident.

Do not use high-pressure cleaners with circular-jet nozzles to clean the vehicle. Have damaged tyres or chassis components replaced immediately.

! Always maintain a distance of at least 30 cm between the vehicle and the high-pressure cleaner nozzle. Information about the correct distance is available from the equipment manufacturer.

Move the high-pressure cleaner nozzle around when cleaning your vehicle.

Do not aim directly at any of the following:

- tyres
- door gaps, joints etc.
- electrical components
- battery
- connectors
- lights
- seals
- trim elements
- ventilation slots

Damaged seals or electrical components can lead to leaks or failures.

Cleaning the wheels

! Do not use acidic wheel cleaning products to remove brake dust. This could damage wheel bolts and brake components.

! Do not park up the vehicle for an extended period straight after cleaning it, particularly after having cleaned the wheels with wheel cleaner. Wheel cleaners could cause increased corrosion of the brake discs and brake pads/linings. For this reason, you should drive for a few minutes after cleaning. Braking heats the brake discs and the brake pads/linings, thus drying them. The vehicle can then be parked up.

Cleaning the paintwork

! Do not affix:

- stickers
- films
- magnetic plates or similar items

to painted surfaces. You could otherwise damage the paintwork.

Scratches, corrosive deposits, areas affected by corrosion and damage caused by inadequate care cannot always be completely repaired. In such cases, visit a qualified specialist workshop.

- ▶ Remove impurities immediately, where possible, whilst avoiding rubbing too hard.
- ▶ Soak insect remains with insect remover and rinse off the treated areas afterwards.
- ▶ Soak bird droppings with water and rinse off the treated areas afterwards.
- ▶ Remove coolant, brake fluid, tree resin, oils, fuels and greases by rubbing gently with a cloth soaked in petroleum ether or lighter fluid.
- ▶ Use tar remover to remove tar stains.
- ▶ Use silicone remover to remove wax.

Care and treatment of matt paintwork

! Never polish the vehicle or the light alloy wheels. Polishing makes the paintwork shiny.

! Never use paint cleaner, buffing or polishing products, or gloss preserver, e.g. wax. These products are only suitable for high-gloss surfaces. Their use on vehicles with matt finish leads to considerable surface damage (shiny, spotted areas).

Always have paintwork repairs carried out at a qualified specialist workshop.

! Do not use wash programs with a hot wax treatment under any circumstances.

If your vehicle has a clear matt finish, observe the following instructions in order to avoid damage to the paintwork due to incorrect care.

These notes also apply to light-alloy wheels with a clear matt finish.

i The vehicle should preferably be washed by hand using a soft sponge, car shampoo and plenty of water.

i Use only insect remover and car shampoo from the range of recommended and approved Mercedes-Benz care products.

Cleaning the windows

! WARNING

If the windscreen wipers are set in motion when cleaning the windscreen or wiper blades, you could become trapped. There is a danger of injury.

Always switch off the windscreen wipers and the ignition before cleaning the windscreen or wiper blades.

! Do not use dry cloths, abrasive products, solvents or cleaning agents containing solvents to clean the inside of the windows. Do not touch the insides of the windows with hard objects, e.g. an ice scraper or

ring. There is otherwise a risk of damaging the windows.

! Clean the water drainage channels of the windscreen and the rear window at regular intervals. Deposits such as leaves, petals and pollen may under certain circumstances prevent water from draining away. This can lead to corrosion damage and damage to electronic components.

► Clean the inside and outside of the windows with a damp cloth and a cleaning agent that is recommended and approved by Mercedes-Benz.

Sliding window: once every three weeks, clean:

- the seals and contact areas of the sliding window with a damp cloth
- the sliding window guides

Cleaning the wiper blades

! WARNING

If the windscreen wipers are set in motion when cleaning the windscreen or wiper blades, you could become trapped. There is a danger of injury.

Always switch off the windscreen wipers and the ignition before cleaning the windscreen or wiper blades.

! Do not pull on the wiper blade. Otherwise, the wiper blade could be damaged.

! Do not clean wiper blades too often and do not rub them too hard. Otherwise, the graphite coating could be damaged. This could cause wiper noise.

! Hold the wiper arm securely when folding back. The windscreen could be damaged if the wiper arm hits against it suddenly.

- ▶ Fold the wiper arms away from the windscreen.
- ▶ Clean the wiper blades carefully using a damp cloth.
- ▶ Fold the windscreen wipers back again before switching on the ignition.

Cleaning the headlamps

- ❗ Only use cleaning agents or cleaning cloths which are suitable for plastic headlamp lenses. Unsuitable cleaning agents or cleaning cloths could scratch or damage the plastic headlamp lenses.
- ▶ Clean the headlamp lenses with a damp sponge and a mild cleaning agent, e.g. Mercedes-Benz car shampoo or cleaning cloths.

Cleaning the trailer coupling

Environmental note

Dispose of oily and greasy cloths in an environmentally-responsible manner.

- ❗ Do not clean the ball coupling with a high-pressure cleaner. Do not use solvents.
- ❗ Please note the care instructions in the trailer coupling manufacturer's operating instructions.

The ball coupling must be cleaned if it becomes dirty or corroded.

- ▶ Remove any rust using a wire brush.
- ▶ Remove dirt with a clean, lint-free cloth or a brush.
- ▶ After cleaning, lightly oil or grease the following:
 - **on trailer ball couplings:** the ball
 - **on hook-type trailer tow hitches:** the inside of the hook and the moving parts
- ▶ Check that the vehicle's trailer tow hitch is working properly.

- ❗ Maintenance of the ball coupling, hook and trailer tow hitch can also be performed at a qualified specialist workshop.

Interior care

Cleaning the display

- ❗ For cleaning, do not use any of the following:
 - alcohol-based thinner or petrol
 - abrasive cleaning agents
 - commercially-available household cleaning agents
 These may damage the display surface. Do not put pressure on the display surface when cleaning. This could lead to irreparable damage to the display.
- ▶ Before cleaning the display, make sure that it is switched off and has cooled down.
- ▶ Clean the display surface using a commercially available microfibre cloth and TFT/LCD display cleaner.
- ▶ Dry the display surface using a dry microfibre cloth.

Cleaning the plastic trim

WARNING

When cleaning the steering wheel boss and dashboard, do not use cockpit sprays or cleaning agents containing solvents. Cleaning agents containing solvents cause the surface to become porous, and as a result plastic parts may break away and be thrown around the interior when an airbag is deployed, which may result in severe injuries.

- ❗ Do not affix the following to plastic surfaces:
 - stickers
 - films
 - scented oil bottles or similar items
 You could otherwise damage the plastic.

! Do not allow cosmetics, insect repellent or sunscreen to come in contact with the plastic trim. This maintains the high-quality look of the surfaces.

- ▶ Wipe the plastic trim with a damp, lint-free cloth, e.g. a microfibre cloth.
- ▶ **Heavy soiling:** use car care and cleaning products recommended and approved by Mercedes-Benz.
The surface may change colour temporarily. Wait until the surface is dry again.

Cleaning the seat covers

General notes

! Do not use microfibre cloths to clean genuine leather, artificial leather or DINAMICA covers. If used often, these can damage the cover.

- i** Note that regular care is essential to make sure that the appearance and comfort of the covers are retained over time.

Genuine leather seat covers

! To retain the natural appearance of the leather, observe the following cleaning instructions:

- Clean genuine leather covers carefully with a damp cloth and then wipe the covers down with a dry cloth.
- Make sure that the leather does not become soaked. It may otherwise become rough and cracked.
- Only use leather care agents that have been tested and approved by Mercedes-Benz. You can obtain these from a qualified specialist workshop.

Leather is a natural product.

It has natural surface properties, e.g.:

- unevenness in structure
- marks caused by growth and injury
- subtle colour differences

These are characteristics of leather and not material faults.

Seat covers from other materials

- !** Observe the following when cleaning:
 - Clean artificial leather covers with a cloth moistened with a solution containing 1% detergent (e.g. washing-up liquid).
 - Clean cloth covers with a microfibre cloth moistened with a solution containing 1% detergent (e.g. washing-up liquid). Rub carefully, and always wipe entire seat sections to avoid leaving visible lines. Leave the seat to dry afterwards. Cleaning results depend on the type of dirt and how long it has been there.
 - Clean Alcantara® covers with a damp cloth. Make sure that you wipe entire seat sections to avoid leaving visible lines.

Cleaning the seat belts

- !** Do not clean the seat belts using chemical cleaning agents. Do not dry the seat belts at temperatures above 80 °C or in direct sunlight.
- ▶ Use clean, lukewarm water and soap solution.

Useful information	154
Where will I find...?	154
Flat tyre	159
Battery	160
Jump-starting	163
Towing and tow-starting	166
Electrical fuses	169

Useful information

- i** This Owner's Manual describes all models, series and optional equipment for your vehicle that were available at the time of going to press. Country-specific differences are possible. Note that your vehicle may not be fitted with all features described. This is also the case for systems and functions relevant to safety.
- i** Read the information on qualified specialist workshops: (▷ page 15).

Where will I find...?

Warning triangle

Removing the warning triangle

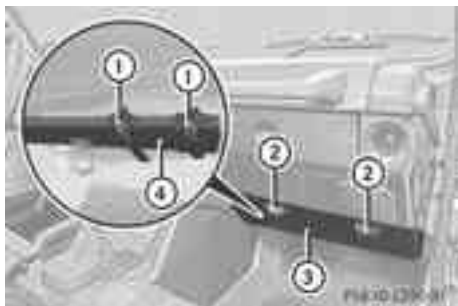

- ▶ Turn fasteners ② 90° using a suitable object, e.g. a coin.
- ▶ Remove cover ③.
- ▶ Unclip tensioning straps ①.
- ▶ Remove warning triangle ④.

Setting up the warning triangle



- ▶ Fold feet ③ down and out to the side.
- ▶ Pull side reflectors ② up to form a triangle and lock them at the top using press-stud ①.

First-aid kit

The first-aid kit is located in the stowage compartment in the front-passenger door.



- ▶ Remove first-aid kit ① from the stowage space.
- i** Check the expiry date on the first-aid kit at least once a year. Replace the contents if necessary, and replace any missing items.

Fire extinguisher

The fire extinguisher is located under the rear of the driver's seat.



Fire extinguisher (vehicles with a stowage compartment)

- ▶ **Vehicles with a stowage compartment:** press release button ②. The tab opens.
- ▶ Remove fire extinguisher ① by handle ③.



Fire extinguisher (vehicles with a folding seat)

- ▶ **Vehicles with a folding seat:** fold the driver's seat forwards (▷ page 53).
- ▶ Pull fire extinguisher ① by handle ② in the direction of the arrow out of bracket ③.

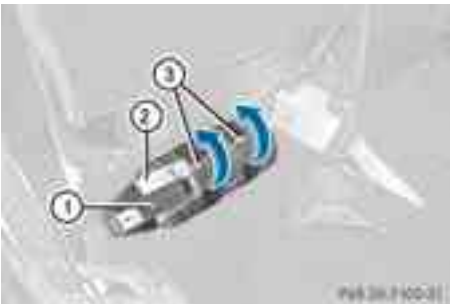

Fire extinguisher (vehicles with a holder on the driver's seat)

- ▶ **Vehicles with a holder on the driver's seat:** fold up folding straps ③.

The tabs open up.

- ▶ Remove fire extinguisher ② by handle ①.

i Have fire extinguisher ③ refilled after each use and checked every one or two years. It may otherwise fail in an emergency.

Observe the legal requirements for each individual country.

Vehicle tool kit

General notes

The vehicle tool kit contains:

- vehicle tool kit with:
 - pump lever for vehicle jack
 - two-piece screwdriver
 - plug-in blade
 - offset screwdriver
 - two-piece wheel wrench (size 19)
 - wheel wrench (size 17)
- jack

Vehicle tool kit

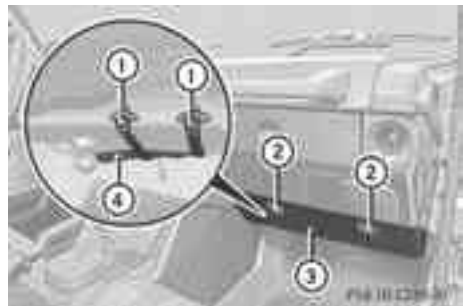

Vehicles with a stowage space in the footwell

- ▶ Turn fasteners ② 90° using a suitable object, e.g. a coin.
- ▶ Remove cover ③.
- ▶ Unclip tensioning straps ①.
- ▶ Remove vehicle tool kit ④.



Vehicles with stowage compartments under the driver's seat

- ▶ Turn rotary knob (2) anti-clockwise and fold cover (1) up.



- ▶ Remove vehicle tool kit (3).

Jack



Vehicles with stowage compartments: the jack is in the stowage compartment under the front-passenger seat.

- ▶ Turn rotary knob (2) anti-clockwise and fold cover (1) up.

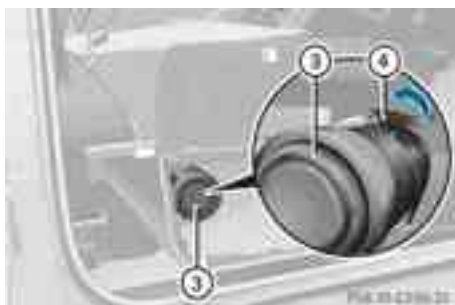

- ▶ Lift tab (4) as indicated by the arrow and unhook it.
- ▶ Remove jack (3).

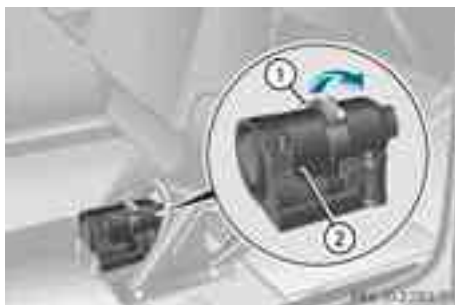

Vehicles with a folding seat: the jack is at the rear under the front-passenger seat.

- ▶ Fold the front-passenger seat forwards (▷ page 53).
- ▶ Lift tab (1) as indicated by the arrow and unhook it.
- ▶ Remove jack (2).

Wheel chocks

The wheel chocks are intended to secure the vehicle, e.g. while changing a wheel.

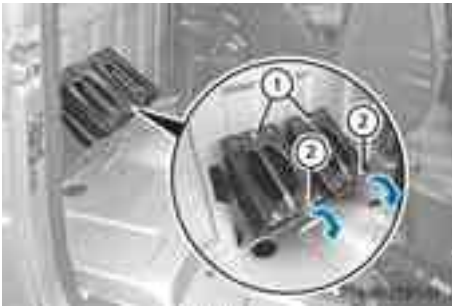

Example: station wagon

- ▶ Fold the folding seat forwards (▷ page 53).
- ▶ Remove wheel chocks ① one at a time by pulling down respective locking spring ② and taking out corresponding wheel chock ①.

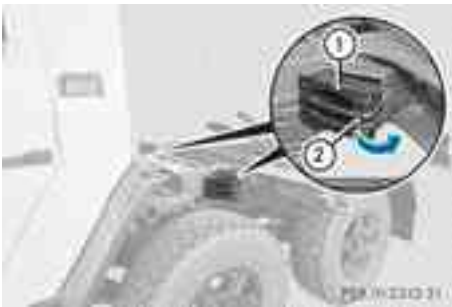

Example: 6x6 chassis-cab with crewcab

- ▶ Pull locking spring ② downwards and remove corresponding wheel chock ①.
- ❗ When stowing, make sure that each wheel chock ① is properly secured by its own locking spring ② in the respective bracket.

Spare wheel bracket in the rear compartment

General notes

Do not exceed a maximum speed of 80 km/h if a spare wheel of a different size is fitted.

- ❗ When changing a wheel, you should also observe the safety notes in the "Flat tyre" section (▷ page 178).

The spare wheel is on the outer side of the rear door.

Removing the cover

Protective tyre cover



- ▶ Pull rubber ring ① of protective tyre cover ② apart.
- ▶ Pull off protective tyre cover ②.

Removing the spare wheel

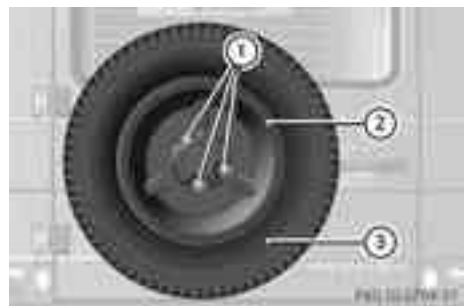

Spare wheel (example: station wagon)

- ▶ Unscrew screws ①.
- ▶ Remove cover plate ②.
- ▶ Remove spare wheel ③.

Fitting the wheel

After changing a wheel:

- ▶ Secure the damaged wheel on the spare wheel bracket with wheel nuts ①. When doing so, make sure that the wheel cannot come loose.
- ▶ Cover the wheel with the tyre protection cover.
- ▶ For safety reasons, regularly check to ensure that the wheel is securely fastened.



- ▶ Screw one of bolts ① back in. Underride guard ② is secured and cannot fold down again.

Spare wheel carrier under the vehicle

General notes

- ❗ When changing a wheel, you should also observe the safety notes in the "Flat tyre" section (▶ page 159).

The spare wheel is on the outside, under the vehicle on the left behind the cab.

Folding up the underride guard



- ▶ Remove four bolts ① using the two-piece wheel wrench (size 19) from the vehicle tool kit (▶ page 155).
- ▶ Fold up underride guard ②.

Removing the spare wheel

- ❗ Always pull the spare wheel carrier as far forwards as possible before folding it down. Otherwise, the exhaust pipe could be damaged.



- ▶ Remove bolt ④.
- ▶ Pull spare wheel carrier ③ as far forwards as it will go.
- ▶ Fold down spare wheel carrier ③. When doing so, make sure that spare wheel ⑤ does not press against exhaust pipe ⑥.

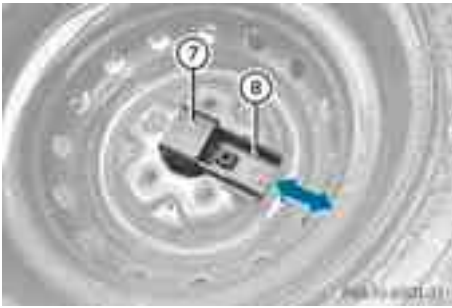

- ▶ Remove retainer (8) from bracket (7).
- i** The spare wheel is heavy. If necessary, request the assistance of a second person.
- ▶ Remove spare wheel (5).

Securing the spare wheel

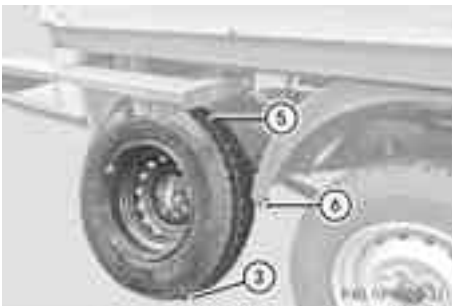

- ▶ Lay spare wheel (5) on spare wheel carrier (3).
When doing so, make sure that spare wheel (5) does not press against exhaust pipe (6).
- ▶ Fold spare wheel carrier (3) upwards by approximately 20 cm.
Spare wheel (5) on the spare wheel carrier slides over bracket (7).
- ▶ Slide retainer (8) as far as it will go into bracket (7).
- ▶ Fold up spare wheel carrier (3) to a position it where can be slid under the vehicle.
- ▶ Slide spare wheel carrier (3) as far as it will go under the vehicle.

- ▶ Screw in bolt (4).
- ▶ For safety reasons, regularly check to ensure that the spare wheel is securely fastened.

i After changing the wheel, you can secure the faulty wheel on the spare wheel carrier.

Folding down the underride guard

- ▶ Hold underride guard (2).
- ▶ Remove bolt (1) (▶ page 158).
- ▶ Fold down underride guard (2).
- ▶ Screw in all four bolts (1).

Flat tyre

Preparing the vehicle

- ▶ Stop the vehicle as far away as possible from traffic on solid, non-slippery and level ground.
- ▶ Switch on the hazard warning lamps (▶ page 61).
- ▶ Apply the parking brake.
- ▶ Bring the front wheels into the straight-ahead position.
- ▶ Move the selector lever to **P**.
- ▶ Switch off the engine.
- ▶ Remove the key from the ignition lock.
The steering wheel lock stays active for as long as the key is removed.
- ▶ All occupants must get out of the vehicle.
Make sure that they are not endangered as they do so.
- ▶ Make sure that no one is near the danger area while a wheel is being changed. Anyone who is not directly assisting in the wheel change should, for example, stand behind the barrier.
- ▶ Get out of the vehicle. Pay attention to traffic conditions when doing so.

- ▶ Close the driver's door.
- ▶ Place the warning triangle (▷ page 154) or warning lamps at a suitable distance. Observe legal requirements.

Battery

Important safety notes

Work on the battery, e.g. removing or installing, requires specialist knowledge and the use of special tools. Therefore, always have work on the battery carried out at a qualified specialist workshop.

If ABS is malfunctioning, the wheels could lock when braking. This limits the steerability of the vehicle when braking and may increase the braking distance.

WARNING

During the charging process, a battery produces hydrogen gas. If a short circuit occurs or sparks are created, the hydrogen gas can ignite. There is a risk of an explosion.

- Make sure that the positive terminal of a connected battery does not come into contact with vehicle parts.
- Never place metal objects or tools on a battery.
- It is important that you observe the described order of the battery terminals when connecting and disconnecting a battery.
- When jump-starting, make sure that the battery poles with identical polarity are connected.
- It is particularly important to observe the described order when connecting and disconnecting the jump leads.
- Never connect or disconnect the battery terminals while the engine is running.



WARNING

Electrostatic build-up can lead to the creation of sparks, which could ignite the highly explosive gases of a battery. There is a risk of an explosion.

Before handling the battery, touch the vehicle body to remove any existing electrostatic build-up.

WARNING

Battery acid is caustic. There is a risk of injury. Avoid contact with the skin, eyes or clothing. Do not inhale any battery gases. Do not lean over the battery. Keep children away from batteries. Wash battery acid immediately with water and seek medical attention.

-  Have the battery checked regularly at a qualified specialist workshop. Observe the service intervals in the Service Booklet or contact a qualified specialist workshop for more information.
 -  Always have work on the battery carried out at a qualified specialist workshop. Should it, in exceptional circumstances, be absolutely necessary to disconnect the battery yourself, please observe the following:
 - switch off the engine and remove the key. Check that all the indicator lamps in the instrument cluster are off. Otherwise, you may damage electronic components such as the alternator, for example.
 - first, disconnect the negative terminal clamp, followed by the positive terminal clamp. Never swap the terminal clamps. The vehicle electronics may otherwise be damaged.
 - on vehicles with automatic transmission, the transmission is locked in position **P** after disconnecting the battery. The vehicle is secured against rolling away. You can then no longer move the vehicle.
- The battery and the cover of the positive terminal clamp must be fitted securely during operation.
-  Have the batteries checked and, if necessary, replaced at a qualified specialist workshop every two years or at least every 20,000 km.

**Environmental note**

Batteries contain pollutants. It is illegal to dispose of them with the household rubbish. They must be collected separately and disposed of in an environmentally responsible recycling system.



Dispose of batteries in an environmentally responsible manner. Take discharged batteries to a qualified specialist workshop or to a collection point for used batteries.

In order for the batteries to achieve the maximum possible service life, they must always be sufficiently charged.

Comply with safety precautions and take protective measures when handling batteries.

**WARNING**

Fire, naked flames and smoking are prohibited when handling the battery. Avoid creating sparks.



Battery acid is caustic. Avoid contact with the skin, eyes or clothing.



Wear eye protection.



Keep children away.



Observe this Owner's Manual.

The vehicle battery, like other batteries, can discharge over time if you do not use the vehicle. In such cases, have the battery disconnected at a qualified specialist workshop.

You can also charge the battery with a charger recommended by Mercedes-Benz. For more information, please contact a qualified specialist workshop.

The highly flammable gas mixture is created during the charging process and when jump-starting.

For safety reasons, Mercedes-Benz recommends that you only use batteries which have been tested and approved for your vehicle by Mercedes-Benz. These batteries provide increased impact protection to prevent vehicle occupants from suffering acid burns should the battery be damaged in the event of an accident.

Have the batteries' charge checked more frequently if you use the vehicle mainly for short trips or if you leave it standing idle for a lengthy period.

Disconnect the batteries from the on-board electrical system using the battery main switch (▷ page 87) if you leave it standing idle. Consult a qualified specialist workshop if you wish to leave your vehicle parked up for a long period of time.

- i** When you park the vehicle, remove the key if you do not require any electrical consumers. The vehicle will then use very little energy, thus conserving battery power.

Mercedes-Benz recommends that you do not carry out work on batteries yourself, e.g. removing or charging. Have this work performed at a qualified specialist workshop.

Charging the battery**⚠ WARNING**

During charging and jump-starting, explosive gases can escape from the battery. There is a risk of an explosion.

Particularly avoid fire, naked flames, creating sparks and smoking. Ensure there is sufficient ventilation while charging and jump-starting. Do not lean over a battery.

⚠ WARNING

Battery acid is caustic. There is a risk of injury. Avoid contact with the skin, eyes or clothing. Do not inhale any battery gases. Do not lean over the battery. Keep children away from batteries. Wash battery acid immediately with water and seek medical attention.

⚠ WARNING

A discharged battery can freeze at temperatures below freezing point. When jump-starting the vehicle or charging the battery, gases can escape from the battery. There is a risk of an explosion.

Allow the frozen battery to thaw out before charging it or jump-starting.

! Only use battery chargers with a maximum charging voltage of 14.8 V.

! Only charge the installed battery with a battery charger which has been tested and approved by Mercedes-Benz. These battery chargers allow the battery to be charged while still installed in the vehicle.

A battery charger unit specially adapted for Mercedes-Benz vehicles and tested and approved by Mercedes-Benz is available as an accessory. Contact a Mercedes-Benz Service Centre for information and availability.

Charge the battery in accordance with the operating instructions for the battery charger.

- ▶ Read the operating instructions for the battery charger.
- ▶ Open the bonnet (▷ page 140).
- ▶ Connect the battery charger to the positive terminal and earth point in the same order as when connecting the donor battery in the jump-starting procedure (▷ page 163).

Problems with the 24 V batteries

Problem	Possible causes/consequences and ► Solutions
 The red warning lamp for the 24 V batteries in the control panel lights up while the engine is running.	<p>The batteries are no longer being charged. Possible causes:</p> <ul style="list-style-type: none"> • faulty alternator • torn poly-V-belt • wiring fault • an electronics fault <p>► Stop.</p> <p>► Check the poly-V-belt.</p> <p>► If it is torn: do not drive on.</p> <p>► Consult a qualified specialist workshop.</p> <p>► If it is OK: have the vehicle checked immediately at a qualified specialist workshop.</p>

Jump-starting

Emergency start facility

- !** After starting with the emergency start facility, all three batteries must be separately charged with a battery charger. The cause of the 12 V battery in the centre console discharging must be remedied.

If the 12 V battery in the centre console is discharged, you can start the vehicle using the emergency start facility.

- **To start with the emergency start facility:** switch off all power consumers.
- Switch on the battery main switch (▷ page 87).

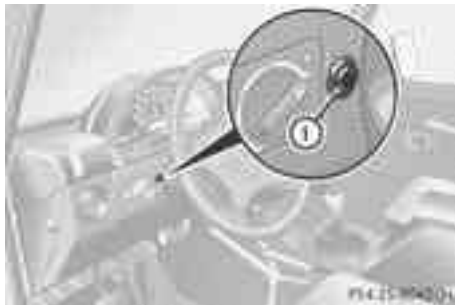

- Press button ① and hold it down.
 - Start the engine (▷ page 88).
 - Keep button ① pressed for a further five seconds after the engine has started.
- i** If starting using the emergency start facility is no longer possible, another vehicle can be used to provide jump-start assistance.

Jump-starting

Important safety notes

WARNING

Battery acid is caustic. There is a risk of injury. Avoid contact with the skin, eyes or clothing. Do not inhale any battery gases. Do not lean over the battery. Keep children away from batteries. Wash battery acid immediately with water and seek medical attention.

WARNING

During charging and jump-starting, explosive gases can escape from the battery. There is a risk of an explosion.

Particularly avoid fire, naked flames, creating sparks and smoking. Ensure there is sufficient ventilation while charging and jump-starting. Do not lean over a battery.

! Avoid repeated and lengthy starting attempts. Only use the jump-starting procedure for the battery in the engine compartment.

Do not use a rapid-charging device to start the engine.

If starting the engine with the emergency start facility is no longer possible, a jump-start can be achieved by attaching the jump leads to the jump-starting terminals.

Jump-starting is also possible from:

- another vehicle
- an external battery

If the vehicle is equipped with a jump-starting socket, it is also possible for another vehicle with a jump-starting socket and a special jump lead to jump-start your vehicle.

Observe the following points:

- ▶ You may only jump-start the vehicle when the engine and catalytic converter are cold.
- ▶ Do not start the engine if the battery is frozen. Let the battery thaw first.
- ▶ **12 V on-board electrical system:** jump-starting may only be performed from batteries with a nominal voltage of 12 V.
- ▶ **24 V on-board electrical system:** jump-starting may only be performed from batteries with a nominal voltage of 24 V.
- ▶ Only use jump leads that have a sufficient cross-section and insulated terminal clamps.
- ▶ Make sure that the jump leads cannot come into contact with parts, such as the pulley or the fan. These parts move when the engine is started and while it is running.
- ▶ If the battery is fully discharged, leave the battery that is being used to jump-start connected for a few minutes before

attempting to start. This charges the empty battery a little.

i Jump-starting cables and further information regarding jump starting can be obtained at any qualified specialist workshop.

- ▶ Make sure that the two vehicles do not touch.
- ▶ Apply the parking brake.
- ▶ Move the selector lever to **P**.
- ▶ Switch off all electrical consumers (e.g. radio, blower, etc.).
- ▶ Open the bonnet (▷ page 140).

Jump-starting using the jump-starting terminals

The jump-starting terminals are on the right-hand side in the engine compartment when viewed in the direction of travel.

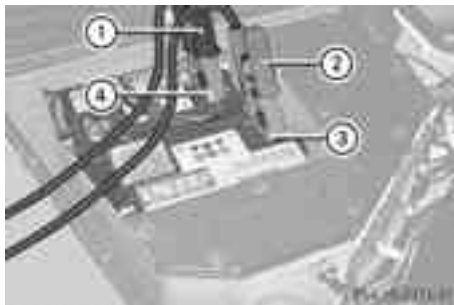

Example: 24 V battery

- ▶ Remove the cover from positive terminal ④ on your vehicle.
- ▶ Connect positive terminal ④ on your vehicle to the positive terminal of the donor battery using jump lead ①, beginning with your own battery.
- ▶ Start the engine of the donor vehicle and run it at idling speed.
- ▶ Connect negative terminal ③ on your vehicle to the negative terminal of the donor battery using jump lead ②, connecting the jump lead to the donor battery first.

- ▶ Switch on the battery main switch (▷ page 87).
- ▶ **12 V on-board electrical system:** start the engine.
- ▶ **24 V on-board electrical system:** start the engine using the emergency start facility (▷ page 163).
- ▶ First disconnect the jump lead from the negative terminals and then from the positive terminals. Begin with your vehicle's battery each time.
- ▶ Have the 12 V batteries or 24 V batteries checked at a qualified specialist workshop.

Jump-starting using a jump-starting socket

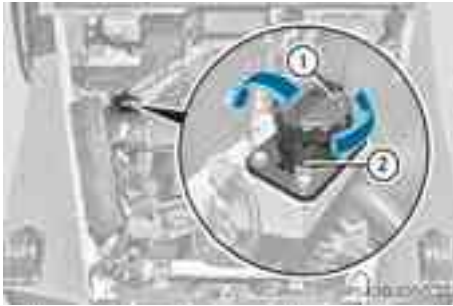

- i** To start the vehicle using jump-starting socket (2), both vehicles must be equipped with a jump-starting socket. A special jump lead with plug connectors is required.
- ▶ Start the engine of the donor vehicle and run it at idling speed.
- ▶ Turn cover (1) anti-clockwise and swing it to the side.



- ▶ Connect the jump-starting sockets of both vehicles with special jump lead (3). Connect the donor vehicle first.
- ▶ Switch on the battery main switch (▷ page 87).

The jump-starting socket is deactivated. You must activate it before use.

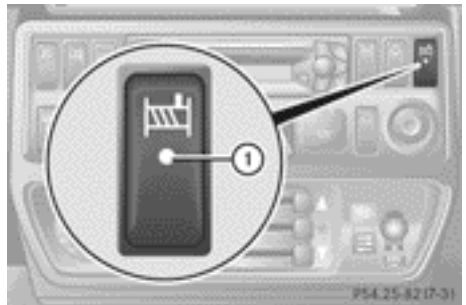

- ▶ **To activate the jump-starting socket:** press the upper section of switch (1). The indicator lamp in switch (1) lights up.
- ▶ Start the engine using the emergency start facility (▷ page 163).
- ▶ Detach special jump lead (3) from the jump-starting sockets of both vehicles. Disconnect your own vehicle first.
- ▶ Have the 24 V batteries checked at a qualified specialist workshop.

Towing and tow-starting

Important safety notes

! You may tow the vehicle for a maximum of 50km. A towing speed of 50 km/h must not be exceeded.

For towing distances over 50 km, the entire vehicle must be lifted up and transported.

! Only secure the tow cable or towing bar to the towing eyes or to the coupling jaw. You could otherwise damage the vehicle.

! Do not use the towing eyes for recovery purposes as this could damage the vehicle. If in doubt, recover the vehicle with a crane.

! When towing, pull away slowly and smoothly. If the tractive power is too high, the vehicles could be damaged.

! Your vehicle is equipped with an automatic transmission. Therefore, you must not have the vehicle tow-started. The transmission may otherwise be damaged.

WARNING

If the weight of the vehicle to be towed or tow-started is greater than the permissible gross weight of your vehicle:

- the towing eye could detach itself
- the vehicle/trailer combination could overturn.

There is a risk of an accident.

When towing or tow-starting another vehicle, its weight should not be greater than the permissible gross weight of your vehicle.

Information on your vehicle's gross vehicle weight rating can be found on the vehicle identification plate (▷ page 191).

Observe the legal requirements for the relevant countries when towing.

It is better to have the vehicle transported than to have it towed.

If the transfer case can be shifted into neutral **N**, you can tow the vehicle.

If the transfer case cannot be shifted into neutral **N**, you can tow the vehicle with one axle raised. Please bear the following in mind:

- remove the propeller shaft between the transfer case and the rolling axle.
- turn the key to position **1** in the ignition lock (▷ page 87).

If the battery has been disconnected or is discharged, the selector lever is locked in position **P**. You can release the parking lock manually (▷ page 95).

Coupling jaw



- ▶ Fold registration plate holder ① upwards until it clicks into place.
- ▶ **To remove the coupling pin:** turn coupling pin ② 90° and pull it up and out.
- ▶ **To attach the coupling pin:** push coupling pin ② in as far as it will go. Coupling pin ② engages.

If it does not engage:

- ▶ Turn coupling pin ② approximately 90° until it clicks into place.

Towing eyes

Towing eyes, front



Station wagon

- ① Towing eyes

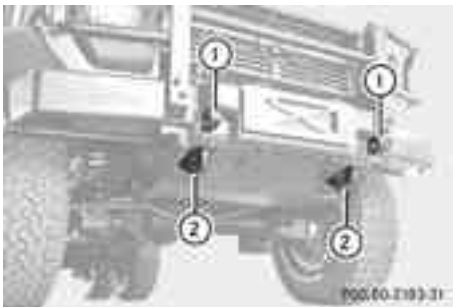

Chassis cab 6x6 with crewcab

- ① Towing eyes
- ② Raising/lashing point

Towing eyes, rear

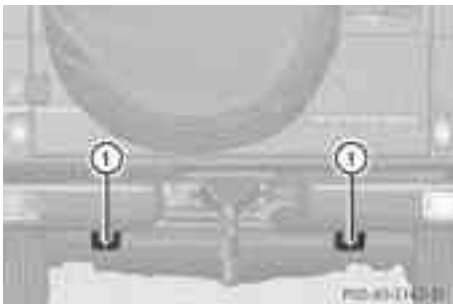

Example: station wagon

- ① Towing eyes

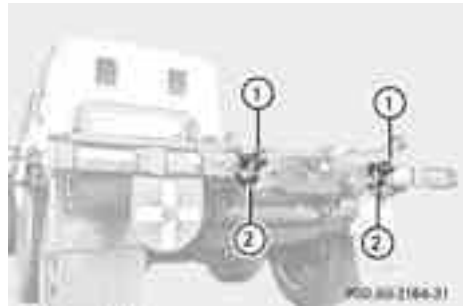

Example: chassis cab 6x6 with crewcab

- ① Towing eyes
- ② Raising/lashing point

Towing the vehicle with both axles on the ground

It is important that you observe the safety instructions when towing away your vehicle (▷ page 166).

- ▶ Switch on the hazard warning lamps (▷ page 61).
- ▶ Turn the key to position **2** in the ignition lock (▷ page 87).
- ▶ When the vehicle is stationary, depress the brake pedal and keep it depressed.
- ▶ Shift the automatic transmission to position **N**.
- ▶ Release the brake pedal.
- ▶ Release the parking brake (▷ page 101).

- i** The transmission can only change gear when the battery has sufficient charge.
If you cannot move the selector lever to **N**, you must remove the propeller shafts to the driven axles.

Transporting the vehicle

- !** Only lash the vehicle down by the wheels or wheel rims, as well as the intended lashing points. Do not lash the vehicle down by parts of the vehicle such as axle or steering components. Otherwise, the vehicle could be damaged.

Use the towing eyes to pull the vehicle if it needs to be transported on a trailer or transporter (▷ page 167).

- ▶ Apply the parking brake.
- ▶ Turn the key to position **2** in the ignition lock (▷ page 87).
- ▶ Move the selector lever to **N**.
- ▶ Shift the transfer case to neutral position **Neutral** (▷ page 111).
- ▶ Secure the towing cable to the towing eyes or coupling jaw.
- ▶ Make sure that the vehicle cannot roll away.
- ▶ Release the parking brake.
- ▶ Load the vehicle onto the transporter.

As soon as the vehicle is loaded:

- ▶ Apply the parking brake.
- ▶ Shift the automatic transmission to position **P**.
- ▶ Turn the key to position **0** in the ignition lock and remove it (▷ page 87).
- ▶ Secure the vehicle.

Station wagon: the lashing points for transportation are on the sidewall. They can be found at the height of the A and B-pillars, near the rear wheel and on the chassis under the vehicle.



Lashing points (example: Station wagon)

- ① Rear lashing points
- ② Side lashing points
- ③ Lower lashing points

Chassis cab 6x6 with crewcab: the lashing points for transportation are located at the front and back (▷ page 167), on the side of the chassis under the vehicle and side rear.

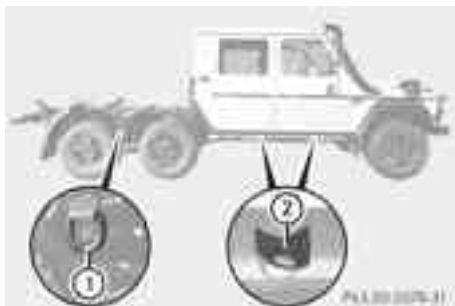

Lashing points (example: chassis cab 6x6 with crewcab)

- ① Side rear raising/lashing point.
- ② Side lashing points

Adjusting the chassis cab 6x6 with crewcab side rear raising/lashing point



- ▶ Pull out securing split pin ①.



- ▶ Pull out bolt ②.
- ▶ Pull out raising/lashing point ④ until the bolt recess is in position ③.
- ▶ Insert bolt ② into position ③.



- ▶ Insert securing split pin ① once again.

Recovering a vehicle that has become stuck

! When recovering a vehicle that has become stuck, pull it as smoothly and evenly as possible. If the tractive power is too high, the vehicles could be damaged.

If the drive wheels get trapped on loose or muddy ground, recover the vehicle with the utmost care, especially so if the vehicle is laden.

Never attempt to recover a vehicle with a trailer attached.

Pull out the vehicle backwards, if possible, using the tracks it made when it became stuck.

Towing in the event of malfunctions

General notes

- !** Always use new self-locking nuts when fitting the propeller shafts.
- ▶ Observe the safety notes as you do so (▷ page 166).
- i** Consult a Mercedes-Benz Service Centre.

Engine damage, gear damage or electrical faults

- ▶ Move the selector lever to position **N** (▷ page 91).
- ▶ Shift the transfer case to **neutral** (▷ page 111).

In the event of damage to the transfer case

Have the propeller shafts between the axles and the transfer case removed.

In the event of damage to the front axle

Have the propeller shaft between the rear axle and the transfer case removed.

Have the vehicle towed with the front axle raised.

In the event of damage to the rear axle

Have the propeller shaft between the front axle and the transfer case removed.

Then, have the vehicle towed with the rear axle raised and with wheel rollers under the front axle.

Electrical fuses

Important safety notes

⚠ WARNING

If you manipulate, bridge or replace a faulty fuse with a fuse of a higher amperage, the electric cables could be overloaded. This may result in a fire. There is a risk of an accident and injury.

Always replace faulty fuses with specified new fuses of the correct amperage.

- !** Only use fuses that have been approved for Mercedes-Benz vehicles and which have the correct fuse rating for the system concerned. Otherwise, components or systems could be damaged.

The fuses in your vehicle serve to disconnect faulty circuits. If a fuse blows, all the components on the circuit and their functions will fail.

Blown fuses must be replaced with fuses of the same rating, which you can recognise by the colour and fuse rating. The fuse ratings are listed in the fuse allocation chart.

If the newly inserted fuse also blows, have the cause traced and rectified at a qualified specialist workshop, e.g. a Mercedes-Benz Service Centre.

Before replacing a fuse

- ▶ Park the vehicle and apply the parking brake.
- ▶ Switch off all electrical consumers.
- ▶ Remove the key from the ignition lock.
All indicator lamps in the instrument cluster must be off.

The fuses are located in various fuse boxes:

- Main fuse box in the centre console
- Fuse box in the front-passenger footwell

The fuse allocation chart is on the underside of the lower cover of the main fuse box in the centre console (▶ page 170).

Spare fuses and the fuse removal device are in the main fuse box in the centre console (▶ page 170).

Main fuse box in the centre console

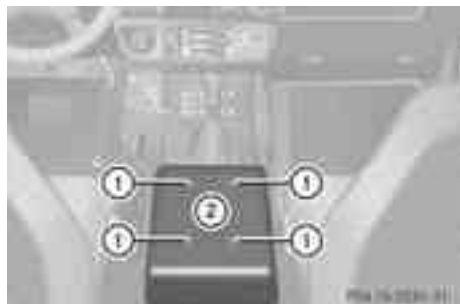

- ▶ To open: remove screws ①.
- ▶ Remove upper cover ②.

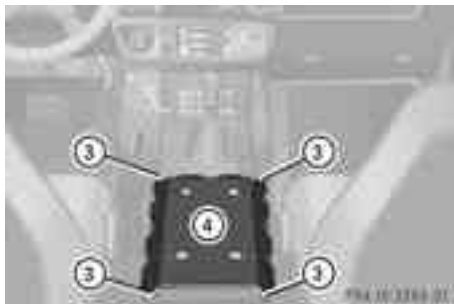

- ▶ Unscrew screws ③.
- ▶ Remove lower cover ④.



- ① Fuse extractor
- ② Spare fuses
- ③ Test socket

i You can check fuses in test socket ③.

If fuses are intact, an indicator lamps lights up.

Fuse box in the front-passenger footwell

i Mercedes-Benz recommends that you have fuses changed at a qualified specialist workshop.

The fuse box is in the front-passenger footwell behind the cover below the glove compartment.

- i** The fuse allocation of the fuse box in the front-passenger footwell may vary, depending on the equipment fitted.

Useful information	174
Important safety notes	174
Operation	174
Winter operation	176
Tyre pressure	177
Changing a wheel	178
Wheel and tyre combinations	182

Useful information

- i** This Owner's Manual describes all models, series and optional equipment for your vehicle that were available at the time of going to press. Country-specific differences are possible. Note that your vehicle may not be fitted with all features described. This is also the case for systems and functions relevant to safety.
- i** Read the information on qualified specialist workshops: (▷ page 15).

Important safety notes

WARNING

If wheels and tyres of the wrong size are used, the wheel brakes or suspension components may be damaged. There is a risk of an accident.

Always replace wheels and tyres with those that fulfil the specifications of the original part.

When replacing wheels, make sure to fit the correct:

- designation
- type

When replacing tyres, make sure to fit the correct:

- designation
- manufacturer
- type

Warning

A flat tyre severely impairs the driving, steering and braking characteristics of the vehicle. There is a risk of an accident.

Do not drive with a flat tyre. Immediately replace the flat tyre with your spare wheel, or consult a qualified specialist workshop.

Accessories that are not approved for your vehicle by Mercedes-Benz or are not being

used correctly can impair the operating safety.

Before purchasing and using non-approved accessories, visit a qualified specialist workshop and enquire about:

- suitability
- legal stipulations
- factory recommendations

Information on the dimensions and types of wheels and tyres for your vehicle can be found in the "Wheel/tyre combinations" section (▷ page 182).

Information on air pressure for the tyres on your vehicle can be found:

- on the tyre pressure label on the fuel filler flap
- in the "Tyre pressure" section

Modification work on the brake system and wheels is not permitted, nor is the use of spacer plates or brake dust shields. This invalidates the general operating permit for the vehicle.

- i** Further information on wheels and tyres can be obtained at any qualified specialist workshop.

Operation

Notes on driving

Check the tyre pressures when the vehicle is heavily laden and, if necessary, adjust.

While driving, pay attention to vibrations, noises and unusual handling characteristics, e.g. pulling to one side. This may indicate that the wheels or tyres are damaged. If you suspect that a tyre is defective, reduce your speed. Stop the vehicle as soon as possible to check the wheels and tyres for damage. Hidden tyre damage could also be causing the unusual handling characteristics. If you find no signs of damage, have the tyres and wheels checked at a specialist workshop.

When parking your vehicle, make sure that the tyres do not get deformed by the kerb or

other obstacles. If it is necessary to drive over kerbs, speed humps or similar elevations, try to do so slowly and at an obtuse angle. Otherwise, the tyres, particularly the sidewalls, may be damaged.

Regular checking of wheels and tyres

WARNING

Damaged tyres can cause tyre inflation pressure loss. As a result, you could lose control of your vehicle. There is a risk of accident.

Check the tyres regularly for signs of damage and replace any damaged tyres immediately.

- Regularly check the wheels and tyres of your vehicle for damage at least every 14 days, as well as after driving off-road or on rough roads. Damage includes cuts, punctures, cracks and bulges on tyres or severe corrosion or deformation on wheels, for example. Damaged wheels can cause a loss of tyre pressure.
- Regularly check the tyre tread depth and the condition of the tread across the whole width of the tyre (▷ page 175). In order to inspect the inner side of the tyre surface, turn the steering wheel to full lock.
- All wheels must have a valve cap to protect the valve against dirt and moisture. Do not fit anything onto the valve other than the standard valve cap or a valve cap approved by Mercedes-Benz for your vehicle.
Do not fit anything onto the valve, such as tyre pressure monitoring systems.
- You should regularly check the pressure of all your tyres including the spare wheel, particularly prior to long trips. Adjust the tyre pressure as necessary (▷ page 177).

The service life of tyres depends on various factors, including the following:

- driving style
- tyre pressure
- tyre mileage

Tyre tread

WARNING

Insufficient tyre tread will reduce tyre traction. The tyre is no longer able to dissipate water. This means that on wet road surfaces, the risk of aquaplaning increases, in particular where speed is not adapted to suit the driving conditions. There is a risk of accident.

If the tyre pressure is too high or too low, tyres may exhibit different levels of wear at different locations on the tyre tread. Thus, you should regularly check the tread depth and the condition of the tread across the entire width of all tyres.

Minimum tyre tread depth for:

- summer tyres: 3 mm
- M+S tyres: 4 mm

For safety reasons, replace the tyres before the legally prescribed limit for the minimum tyre tread depth is reached..

Selecting, fitting and replacing tyres

- Only fit tyres and wheels of the same type and make.
- Only fit approved tyres of the correct size onto the wheels.
- Tyres are coated with a protective layer at the factory. Run in new tyres at moderate speeds for the first 100 km. They only reach their full performance after this distance.
- Do not drive with tyres which have too little tread depth. This otherwise significantly reduces the traction on wet roads (aquaplaning).
- Replace the tyres after six years at the latest, regardless of wear. This also applies to the spare wheel.

Winter operation

General notes

Have your vehicle winterproofed at a qualified specialist workshop at the onset of winter. Observe the notes in the "Changing a wheel" section (▷ page 178).

Driving with summer tyres

At temperatures below +7 °C, summer tyres lose elasticity and therefore traction and braking power. Change the tyres on your vehicle to M+S tyres. Using summer tyres at very cold temperatures could cause tears to form, thereby damaging the tyres permanently. Mercedes-Benz cannot accept responsibility for this type of damage.

M+S tyres

WARNING

M+S tyres with a tyre tread depth of less than 4 mm are not suitable for use in winter as they do not provide sufficient traction. There is a risk of accident.

M+S tyres with a tread depth of less than 4 mm must be replaced.

WARNING

The wheel or tyre size, as well as the tyre type of the emergency spare wheel, spare wheel and the wheel to be changed may differ. Fitting an emergency spare wheel or spare wheel may severely impair the driving characteristics. There is a risk of accident.

To prevent hazardous situations:

- you should adapt your driving style and drive carefully.
- never fit more than one emergency spare wheel or spare wheel that differs from the wheel to be changed.

- only use an emergency spare wheel or spare wheel that differs from the wheel to be changed for a brief period.
- have the emergency spare wheel or spare wheel of a different size replaced at the nearest qualified specialist workshop. You must make sure the wheel has the correct wheel and tyre dimensions and tyre type.

At temperatures below +7 °C, use winter tyres or all-season tyres. Both types of tyre are identified by the M+S marking.



Only winter tyres bearing the  snowflake symbol in addition to the M+S marking provide the best possible grip in wintry road conditions. These tyres have been developed specifically for driving in snow. Only these tyres will allow driving safety systems such as ABS and EBD to function optimally in winter. Use M+S tyres of the same make and tread on all wheels to maintain safe handling characteristics.

Always observe the maximum permissible speed specified for the M+S tyres you have fitted.

If the maximum permissible speed of the M+S tyres is lower than that of the vehicle, affix an appropriate warning sign in the driver's field of vision. This can be obtained at a qualified specialist workshop.

When you have fitted the M+S tyres:

▶ Check the tyre pressures (▷ page 177).

-  You can obtain information about winter tyres that have been approved by Mercedes-Benz especially for your vehicle at any Mercedes-Benz Service Centre.
-  For further information about tyres, see (▷ page 184).

Snow chains

For safety reasons, Mercedes-Benz recommends that you only use snow chains that have been specially approved for your vehicle

by Mercedes-Benz, or that are of a corresponding standard of quality.

- only use snow chains when the road surface is completely snow-covered. Remove the snow chains as soon as possible when you come to a road that is not snow-covered.
- local regulations may restrict the use of snow chains. Observe the appropriate regulations if you wish to fit snow chains.
- do not exceed the maximum permissible speed of 50 km/h.

If you intend to fit snow chains, please bear the following points in mind:

- snow chains cannot be fitted to all wheel/tyre combinations (▷ page 182).
- fit the snow chains on all four wheels for maximum tractive power and driving stability. Observe the manufacturer's fitting instructions.

Tyre pressure

Tyre pressure specifications

Important safety notes

WARNING

Underinflated or overinflated tyres pose the following risks:

- the tyres may burst, especially as the load and vehicle speed increase.
- the tyres may wear excessively and/or unevenly, which may greatly impair tyre traction.
- the driving characteristics, as well as steering and braking, may be greatly impaired.

There is a risk of an accident.

Observe the recommended tyre pressure and check the tyre pressure of all the tyres including the spare wheel:

- at least every two weeks
- when the load changes
- before embarking on a longer journey
- for changed operating conditions, e.g. off-road driving

If necessary, correct the tyre pressure.

WARNING

If you fit unsuitable accessories onto tyre valves, the tyre valves may be overloaded and malfunction, which can cause tyre pressure loss. Due to their design, retrofitted tyre pressure monitors keep the tyre valve open. This can also result in tyre pressure loss. There is a risk of accident.

Only screw standard valve caps or valve caps specifically provided by Mercedes-Benz for your vehicle onto the tyre valve.

WARNING

If the tyre pressure drops repeatedly, the wheel, valve or tyre may be damaged. Tyre pressure that is too low may result in a tyre blow-out. There is a risk of accident.

- Check the tyre for foreign objects.
- Check whether the wheel is losing air or the valve is leaking.

If you are unable to rectify the damage, contact a qualified specialist workshop.

Environmental note

Check the tyre pressure regularly, at least every 14 days.

General notes

You will find a table of recommended tyre pressures for various operating conditions on the inside of your vehicle's fuel filler flap^{8, 9}

⁸ Not chassis cab.

⁹ Not chassis cab 6x6 with crewcab.

typically wear more on the shoulders and the rear tyres in the centre.

On vehicles that have the same size wheels, you can interchange the wheels every 5,000 to 10,000 km, depending on the degree of tyre wear. Ensure the direction of rotation is maintained.

Clean the contact surfaces of the wheel and the brake disc or brake drum thoroughly every time a wheel is interchanged. Check the tyre pressures.

Direction of rotation

Tyres with a specified direction of rotation have additional benefits, e.g. if there is a risk of aquaplaning. You will only gain these benefits if the correct direction of rotation is observed.

An arrow on the sidewall of the tyre indicates its correct direction of rotation.

You may fit the spare wheel against the direction of rotation. Observe the time restriction on use as well as the speed limitation specified on the spare wheel.

Storing wheels

Store tyres that are not being used in a cool, dry and preferably dark place. Protect the tyres against oil, grease, petrol and diesel.

Cleaning the wheels

WARNING

The water jet of circular-jet nozzles (dirt grinders) can cause damage not visible from the outside to tyres or chassis components. Components damaged in this way can unexpectedly fail. There is a risk of an accident.

Do not use high-pressure cleaners with circular-jet nozzles to clean the vehicle. Have damaged tyres or chassis components replaced immediately.

Fitting a wheel

Preparing the vehicle

- ▶ Prepare the vehicle as described (▷ page 159).
- ▶ If a trailer is coupled to the vehicle, uncouple it.
- ▶ Remove the vehicle tool kit and the jack (▷ page 155).
- ▶ Secure the vehicle to prevent it from rolling away.
- ▶ Remove the spare tyre from the spare wheel bracket at the rear (▷ page 157) or from the spare wheel bracket underneath the vehicle (▷ page 158).

Securing the vehicle against rolling away

If your vehicle is equipped with wheel chocks, these can be found behind the folding seat or on the vehicle's chassis (chassis cab 6x6 with crewcab) (▷ page 156).

The wheel chocks are an additional measure for securing the vehicle from rolling away, e.g. when changing a wheel.

- ▶ **On level ground:** place chocks or other suitable items under the front and rear of the wheel that is diagonally opposite the wheel you wish to change.
- ▶ **On downhill gradients:** place chocks or other suitable items in front of the wheels of the front and rear axle.

Raising the vehicle

WARNING

If you do not position the jack correctly at the appropriate jacking point of the vehicle, the jack could tip over with the vehicle raised. There is a risk of injury.

Only position the jack at the appropriate jacking point of the vehicle. The base of the jack must be positioned vertically, directly under the jacking point of the vehicle.

The following must be observed when raising the vehicle:

- to raise the vehicle, only use the vehicle-specific jack that has been tested and approved by Mercedes-Benz. If the jack is used incorrectly, it could tip over while the vehicle is raised.
- the jack is designed only to raise and hold the vehicle for a short time while a wheel is being changed. It is not suited for performing maintenance work under the vehicle.
- avoid changing the wheel on uphill and downhill slopes.
- before raising the vehicle, secure it from rolling away by applying the parking brake and positioning wheel chocks. Never release the parking brake while the vehicle is raised.
- the jack must be placed on a firm, flat and non-slip surface. On a loose surface, a large, load-bearing underlay must be used. On a slippery surface, a non-slip underlay must be used, e.g. rubber mats.
- Do not use wooden blocks or similar objects as a jack underlay. Otherwise, the jack will not be able to achieve its load-bearing capacity due to the restricted height.
- make sure that the distance between the underside of the tyres and the ground does not exceed 3 cm.
- never place your hands or feet under the raised vehicle.
- never lie under the raised vehicle.
- never start the engine when the vehicle is raised.
- never open or close a door or the tailgate when the vehicle is raised.
- make sure that no persons are in the vehicle when the vehicle is raised.

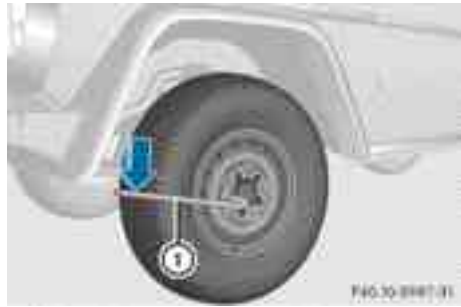

- Using wheel wrench ①, loosen the wheel bolts/wheel nuts on the wheel you wish to change by about one full turn. Do not unscrew the wheel bolts/wheel nuts completely.

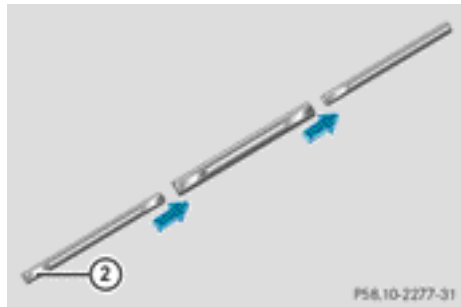

Pump lever ②

- Assemble the pump lever for the jack. It can be found with the vehicle tool kit (▷ page 155).



- ▶ Turn pressure release screw ③ clockwise as far as it will go using notch ② on the pump lever.
Pressure release screw ③ is closed.
- ❗ Do not turn pressure release screw ③ by more than one to two revolutions. Otherwise, hydraulic fluid could escape.



Front axle (station wagon)



Rear axle (station wagon)

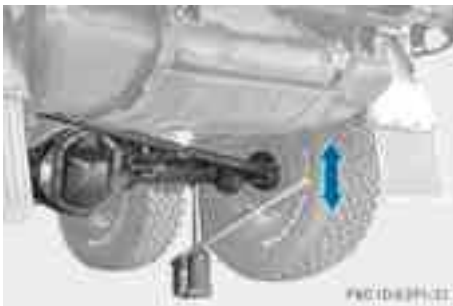

Rear axle (chassis cab 6x6 with crewcab)

- ▶ Position the jack at the front or rear axle tubes.
- ❗ The chassis cab 6x6 with crewcab has two rear axles. The jack can be positioned at the axle tube of a rear axle
- ❗ The jack must always stand vertically, even on uphill gradients.
- ▶ Raise the vehicle by pumping in the direction of the arrow until the tyre is 3 cm off the ground at the most.

Removing a wheel

- ❗ Do not place wheel bolts/wheel nuts in sand or on a dirty surface. The bolt/nut and wheel hub threads could otherwise be damaged when you screw them in.
- ▶ Unscrew the wheel bolts/wheel nuts completely.
- ▶ Remove the wheel.

Fitting a new wheel

⚠ WARNING

Oiled or greased wheel bolts/wheel nuts as well as damaged wheel bolts/wheel nut threads or wheel hub/wheel bolt threads could cause the wheel bolts/wheel nuts to loosen. As a result, you could lose a wheel while driving. There is a risk of an accident. Never oil or grease wheel bolts/wheel nuts. In the event of damage to the threads, contact a qualified specialist workshop immediately. Have damaged wheel screws/wheel nuts/wheel bolts or the damaged wheel hub thread replaced. Do not drive any further.

⚠ WARNING

If you tighten the wheel bolts or wheel nuts when the vehicle is raised, the jack could tip over. There is a risk of injury. Only tighten the wheel bolts or wheel nuts when the vehicle is on the ground.

Always pay attention to the instructions and safety notices in "Changing a wheel" (▷ page 178).

Only use wheel bolts/wheel nuts that have been designed for the wheel and the vehicle. For safety reasons, Mercedes-Benz recommends that you only use wheel bolts/wheel nuts which have been approved for Mercedes-Benz vehicles and the respective wheel.

- ▶ Clean the wheel and wheel hub contact surfaces.
- ▶ Place the new wheel on the wheel hub and push it on.
- ▶ Tighten the wheel bolts/wheel nuts until they are finger-tight.

Lowering the vehicle

WARNING

The wheels could work loose if the wheel nuts and bolts are not tightened to the specified tightening torque. There is a risk of accident. Have the tightening torque immediately checked at a qualified specialist workshop after a wheel is changed.

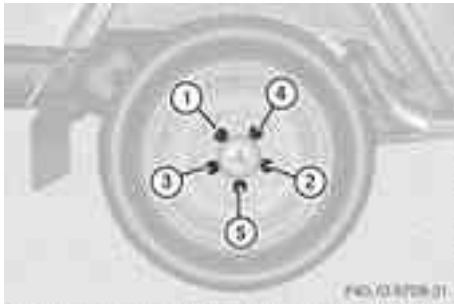

- ▶ Open the pressure release screw on the jack using the pump lever (▷ page 179) by approximately one turn.
- ▶ Place the jack to one side.
- ▶ Tighten the wheel bolts/wheel nuts evenly in a crosswise pattern in the sequence indicated (① to ⑤). The tightening torque must be **180 Nm** for pressed steel wheels,

130 Nm for light-alloy wheels with wheel bolts and **150 Nm** for light-alloy wheels with wheel nuts.

- ▶ Push the jack piston back in and close the drain plug.
- ▶ Use the bolts to secure the defective wheel to the spare wheel bracket at the rear (▷ page 157) or the spare wheel bracket underneath the vehicle (▷ page 158).
- ▶ Stow the jack and the vehicle tools in the vehicle again.
- ▶ Check the tyre pressure of the newly fitted wheel and adjust it if necessary. Observe the recommended tyre pressure (▷ page 184).

Wheel and tyre combinations

General notes

- ❗ For safety reasons, Mercedes-Benz recommends that you only use tyres, wheels and accessories which have been specially approved by Mercedes-Benz for your vehicle.

Only use tyres, wheels or accessories tested and approved by Mercedes-Benz. Certain characteristics, e.g. handling, vehicle noise emissions or fuel consumption, may otherwise be adversely affected. In addition, when driving with a load, tyre dimension variations could cause the tyres to come into contact with the bodywork and axle components. This could result in damage to the tyres or the vehicle.

Mercedes-Benz accepts no liability for damage resulting from the use of tyres, wheels or accessories other than those tested and approved.

Further information on wheels, tyres and approved combinations can be obtained from any qualified specialist workshop.

- ❗ Large wheels: the lower the section width for a certain wheel size, the lower the ride comfort is on poor road surfaces. Roll com-

fort and suspension comfort are reduced and the risk of damage to the wheels and tyres as a result of driving over obstacles increases.

- !** Retreaded tyres are neither tested nor recommended by Mercedes-Benz, since previous damage cannot always be detected on retreaded tyres. As a result, Mercedes-Benz cannot guarantee vehicle safety if retreaded tyres are fitted. Do not fit used tyres if you have no information about their previous usage.
- i** You will find a table of tyre pressure on the inside of your vehicle's fuel filler flap^{10, 11} and in the "Tyre pressure" section (▷ page 184). For further information on tyre pressure, see (▷ page 177). Check tyre pressures regularly and only when the tyres are cold.
- i** Notes on the vehicle equipment – always equip the vehicle:
 - with tyres of the same size on a given axle (left/right).
 - fit the same type of tyres on your vehicle at a given time (winter tyres, all-weather tyres, All Terrain tyres)

The tyre and wheel combinations listed in the tables below apply to the following models:

V1	Panel van Station wagon
V2	Chassis cab
V3	Chassis cab 6x6 with crewcab

- i** Not all wheel/tyre combinations can be fitted at the factory in all countries.

¹⁰ Not chassis cab.

¹¹ Not chassis cab 6x6 with crewcab.

Tyres

i The spare wheel must be inflated to the maximum tyre pressure given in the table in the "Tyre pressure" section.

Summer tyres	Pressed steel wheel	V1	V2
225/75 R16 116 N	6J x 16 H2 ET 63	•	–
225/75 R16 110 R	6J x 16 H2 ET 63	•	–
235/75 R17.5 130 M	17.5 x 6.75 H	–	•

Summer tyres	Light-alloy wheels	V1	V2	V3
265/70 R16 112 T	7.5J x 16 H2 ET 63	•	–	–
285/75 R16 122 R	7.5J x 16 H2 ET 63	–	–	•
	7.5J x 16 ET 63	–	–	•

i The spare wheel matches the standard tyres.

i You can obtain information about tyres and tyre dimensions that are not listed here at any Mercedes-Benz Service Centre.

Tyre pressure

Wheels	Tyre size	Permissible gross weight	Tyre pressure	
			Front	Rear
Pressed steel wheel 6J x 16 H2 ET 63	225/75 R16 116 N ^{12, 13}	3560 kg	4.0 bar	4.5 bar
	225/75 R16 110 R ^{12, 13}	3200 kg 3500 kg 3560 kg	4.0 bar	4.5 bar
Pressed steel wheel 17.5 x 6.75 H	235/75 R17.5 ¹⁴	4300 kg	3.7 bar	5.0 bar

¹² Not chassis-cab.

¹³ Not chassis cab 6x6 with crewcab.

¹⁴ Chassis-cab only.

Wheels	Tyre size	Permissible gross weight	Tyre pressure	
			Front	Rear
Light-alloy wheels 7.5J x 16 H2	265/70 R16	3200 kg 3500 kg 3560 kg	3.0 bar	3.5 bar
Light-alloy wheels 7.5J x 16 H2 ET 63 7.5J x 16 ET 63	285/75 R16 ¹⁵	6500 kg	3.5 bar	4.2 bar

i The stated tyre pressures are minimum pressures on fully laden vehicles and must not fall below this during normal road use.

¹⁵ Only chassis cab 6x6 with crewcab.

Useful information	188
Information on technical data	188
Genuine Mercedes-Benz parts	188
Vehicle electronics	189
Identification plates	191
Service products and capacities	191
Vehicle data	196
Trailer tow hitch	198

Useful information

- i** This Owner's Manual describes all models, series and optional equipment for your vehicle that were available at the time of going to press. Country-specific differences are possible. Note that your vehicle may not be fitted with all features described. This is also the case for systems and functions relevant to safety.
- i** Read the information on qualified specialist workshops: (▷ page 15).

Information on technical data

- i** The technical data was determined in accordance with EU Directives. All data applies to the vehicle's standard equipment. The data may therefore differ for vehicles with optional equipment. You can obtain further information from a Mercedes-Benz Service Centre.

Genuine Mercedes-Benz parts

WARNING

Driving safety may be impaired if non-approved parts, tyres and wheels or safety-relevant accessories are used.

This could lead to malfunctions in safety-relevant systems, e.g. the brake system. This could cause you to lose control of your vehicle and cause an accident.

For this reason, Mercedes-Benz recommends that you use genuine Mercedes-Benz parts or parts of equal quality. Only use tyres, wheels and accessories that have been specifically approved for your vehicle.

Environmental note

Daimler AG also supplies reconditioned assemblies and parts which are of the same quality as new parts. For these, the same warranty applies as for new parts.

! The use of non-approved parts could affect your vehicle's operating safety. Therefore, Mercedes-Benz recommends genuine Mercedes-Benz parts and conversion parts and accessories that have been approved for your vehicle.

! Airbags and seat belt tensioners, as well as control units and sensors for these restraint systems, may be installed in the following areas of your vehicle:

- doors
- door pillars
- door sills
- seats
- dashboard
- instrument cluster
- centre console

Do not install accessories such as audio systems in these areas. Do not carry out repairs or welding. You could impair the operating efficiency of the restraint systems.

Have accessories retrofitted at a qualified specialist workshop.

Mercedes-Benz tests genuine parts and conversion parts and accessories that have been specifically approved for your vehicle for their reliability, safety and suitability. Despite ongoing market research, Mercedes-Benz is unable to assess other parts. Mercedes-Benz accepts no responsibility for the use of parts that have been independently or officially approved.

In Germany, certain parts are only officially approved for installation or modification if they comply with legal requirements. This also applies to some other countries. All genuine Mercedes-Benz parts meet the approval requirements. The use of non-approved parts may invalidate the vehicle's general operating permit.

This is the case:

- if they cause a change of the vehicle type from that for which the vehicle's general operating permit was granted
- if other road users could be endangered
- if the emission or noise levels are adversely affected

Always specify the vehicle identification number (VIN) (> page 191) and the engine number (> page 191) when ordering genuine Mercedes-Benz parts.

Vehicle electronics

Tampering with the engine electronics

WARNING

Modifications to electronic components, their software as well as wiring could effect their function and/or the operation of other networked components. This could in particular also be the case for systems relevant to safety. They might not function properly any more and/or jeopardise the operational safety of the vehicle. There is an increased risk of an accident and injury.

Do not attempt to modify the wiring as well as electronic components or their software. Always have work on electrical and electronic components carried out at a qualified specialist workshop.

WARNING

The function of systems or components can be affected by conversions or modifications to the vehicle. They might not function properly any more and/or jeopardise the operational safety of the vehicle. There is an increased risk of an accident and injury.

Conversions or modifications should always be carried out at qualified specialist workshop.

-  Only have work carried out on the engine electronics and its associated parts, such

as control units, sensors and connector leads, at a qualified specialist workshop. Vehicle components may otherwise wear more quickly and the vehicle's operating permit may be invalidated.

Retrofitting two-way radios and mobile phones (RF transmitters)

WARNING

If you use the RF transmitter in the vehicle in an improper way, its electromagnetic radiation can disrupt vehicle electronics, e.g. if:

- the RF transmitter is not connected to an exterior aerial
- the exterior aerial is fitted incorrectly or is not a low-reflection aerial

This can jeopardise the operating safety of the vehicle. There is a risk of an accident.

Have the low-reflection exterior aerial fitted at a qualified specialist workshop. When operating in the vehicle, always connect the RF transmitter to the low-reflection exterior aerial.

WARNING

If RF transmitters are tampered with or not properly retrofitted, the electromagnetic radiation they emit can interfere with the vehicle electronics. This may jeopardise the operational safety of the vehicle. There is a risk of an accident.

You should have all work on electrical and electronic components carried out at a qualified specialist workshop.

-  The operating permit may be invalidated if the instructions for installation and use of RF transmitters are not observed.

In particular, the following conditions must be complied with:

- only approved wavebands may be used.
- observe the maximum permissible output in these wavebands.
- only approved aerial positions may be used.

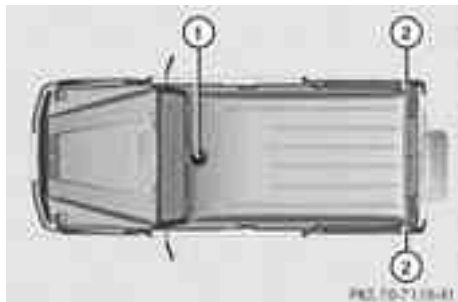

Example: station wagon

- ① Front roof area
- ② Rear wing

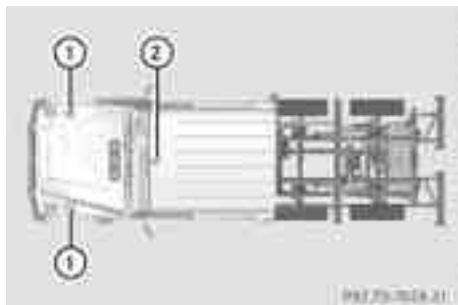

Chassis-cab 6x6 with crewcab

- ① Front wings
- ② Front roof area

i When fitting an aerial on the front roof area of vehicles with a sliding sunroof, observe the sweeping range of the roof.

On the rear wing, it is recommended that you position the aerial on the side of the vehicle closest to the centre of the road.

Use Technical Specification ISO/TS 21609 (Road Vehicles - "EMC guidelines for fitting aftermarket radio frequency transmitting equipment") when retrofitting RF (radio fre-

quency) transmitters. Comply with the legal requirements for add-on parts.

If your vehicle has fittings for two-way radio equipment, use the power supply or aerial connections intended for use with the basic wiring. Be sure to observe the manufacturer's additional instructions when installing.

Deviations with respect to wavebands, maximum transmission outputs or aerial positions must be approved by Mercedes-Benz.

The maximum transmission output (PEAK) at the base of the aerial must not exceed the following values:

Waveband	Maximum transmission output (PEAK)
Short wave 3 MHz–54 MHz	100 W
4 m waveband 68 MHz–87.5 MHz	30 W
2 m waveband 144 MHz–174 MHz	50 W
70 cm waveband 400 MHz–460 MHz	35 W

The following can be used in the vehicle without restrictions:

- RF transmitters with a maximum transmission output of up to 100 mW
- mobile phones (GSM/DCS/PCS/UMTS/LTE)

Identification plates

Vehicle identification plate with vehicle identification number (VIN) and paint code number



- Open the front right-hand door.
You will see vehicle identification plate ①.



Example: vehicle identification plate

- ① Vehicle identification plate
 - ② Vehicle manufacturer
 - ③ EU type approval number
 - ④ Vehicle identification number (VIN)
 - ⑤ Maximum permissible gross vehicle weight
 - ⑥ Maximum permissible gross weight of vehicle/trailer combination
 - ⑦ Maximum permissible front axle load
 - ⑧ Maximum permissible rear axle load
 - ⑨ Paint code
- i** The data shown on the vehicle identification plate is example data. This data is different for every vehicle and can deviate from the data shown here. You can find the

data applicable to your vehicle on the vehicle's identification plate.

Vehicle identification number (VIN)

In addition to the information on the vehicle identification plate, the vehicle identification number (VIN) is also stamped onto the chassis on the right when viewed in the direction of travel.



- ① Vehicle identification number (VIN)

Engine number

The engine number is stamped onto the crankcase. You can obtain further information from any qualified specialist workshop.

Service products and capacities

Important safety notes

⚠ WARNING

Service product can be poisonous and hazardous to health. There is a risk of injury. Observe the instructions on the respective original container when using, storing and disposing off service products. Always store service products in the sealed original container. Always keep service products out of the reach of children.

♻ Environmental note

Dispose of service products in an environmentally-responsible manner.

Service products include the following:

- Fuels
- Lubricants (e.g. engine oil, transmission oil)
- Coolant
- Brake fluid
- Windscreen washer fluid
- Climate control system refrigerant

Components and service products must be matched. Mercedes-Benz recommends that you use products tested and approved by Mercedes-Benz. They are listed in this Mercedes-Benz Owner's Manual in the appropriate section.

You can identify service products approved by Mercedes-Benz by the following inscriptions on the container:

- MB-Freigabe (e.g. MB-Freigabe 229.51)
- MB Approval (e.g. MB Approval 229.51)

Other designations or recommendations indicate a level of quality or a specification in accordance with an MB Sheet Number (e.g. MB 229.5). They have not necessarily been approved by Mercedes-Benz.

Further information can be obtained from any Mercedes-Benz Service Centre or on the Internet at <http://bevo.mercedes-benz.com>.

Fuel

Important safety notes

WARNING

Fuel is highly flammable. If you handle fuel incorrectly, there is a risk of fire and explosion.

You must avoid fire, naked flames, creating sparks and smoking. Switch off the engine and, if applicable, the auxiliary heating before refuelling.

WARNING

Fuels are poisonous and hazardous to health. There is a danger of injury.

Do not swallow fuel or let it come into contact with skin, eyes or clothing. Do not inhale fuel vapours. Keep fuels out of the reach of children.

If you or others come into contact with fuel, observe the following:

- Wash the fuel off any affected areas of skin with water and soap immediately.
- If you get fuel in your eyes, rinse them thoroughly with clean water immediately. Seek immediate medical attention.
- If fuel is swallowed, seek immediate medical attention. Do not induce vomiting.
- Change any clothing that has come into contact with fuel immediately.

Tank capacity

Total capacity	Approx. 95 l
Of which reserve fuel	Approx. 13 l
Additional fuel tank	
Chassis-cab 6x6 with crew-cab	Approx. 53 l

Diesel (EN 590, DIN 51628)

Fuel grade

WARNING

If you mix diesel fuel with petrol, the flash point of this fuel mixture is lower than that of pure diesel fuel. When the engine is running, components in the exhaust system may overheat unnoticed. There is a risk of fire.

Never refuel with petrol. Never add petrol to diesel fuel.

- When refuelling, only use diesel fuel that conforms to the European standard EN 590 or is of equivalent quality. Fuel that does not conform to EN 590 can lead to increased wear as well as damage to the engine and exhaust system.

! Do not use the following:

- marine diesel
- heating oil
- bio-diesel
- vegetable oil
- petrol
- paraffin
- kerosene

Do not mix such fuels with diesel fuel and do not use any special additives. This can otherwise lead to engine damage. This does not include flow improver additives. For further information, see "Flow improvers".

! **Vehicles with a diesel particle filter:** in countries outside the EU, only refuel with low-sulphur Euro diesel with a sulphur content under 50 ppm; otherwise the emission control system could be damaged.

Usually you will find information about the fuel grade on the pump. If you cannot find the label on the petrol pump, ask the filling station staff.

Information on refuelling (▷ page 96).

Information on refuelling (▷ page 98).

Low outside temperatures

In winter months, diesel fuel with an improved cold flow quality is available. In Europe, the EN 590 standard defines various climate-dependent temperature categories. Malfunctions can be avoided by refuelling with diesel fuel that corresponds to the climatic specifications outlined in EN 590. At unusually low outside temperatures, it is possible that the flow characteristics of the diesel fuel could be insufficient. Accordingly, diesel fuel from warmer areas may not be suitable for operation in colder climatic conditions.

i Further information on country-specific fuel properties can be obtained from oil companies, e.g. at filling stations.

Flow improvers

Flow improvers can be added to improve the cold resistance of diesel fuel. The effectiveness of flow improvers cannot be guaranteed with all fuels.

Only use flow improvers tested and approved by Mercedes-Benz. During use, please observe the information on operation.

Correct dosage and thorough mixing are decisive factors in ensuring improvement in low-temperature resistance. Under certain circumstances, an excessive dosage may actually decrease low-temperature resistance and should therefore be avoided. Follow the manufacturer's dosing instructions.

Mix the additive into the diesel in good time, before the flow characteristics of the diesel become insufficient. Otherwise, malfunctions can only be rectified by heating the entire fuel system, e.g. by parking in a heated garage.

More information about recommended flow improvers can be obtained from any qualified specialist workshop.

Notes on fuel consumption

⌚ Environmental note

CO₂ (carbon dioxide) is the gas which scientists believe to be principally responsible for global warming (the greenhouse effect). Your vehicle's CO₂ emissions are directly related to fuel consumption and therefore depend on:

- efficient use of the fuel by the engine
- driving style
- other non-technical factors, such as environmental influences, road conditions or traffic flow

You can minimise your vehicle's CO₂ emissions by driving carefully and having it serviced regularly.

The vehicle will use more fuel than usual in the following situations:

- at very low outside temperatures
- in urban traffic

- on short journeys
- in mountainous terrain
- when towing a trailer

i Only for certain countries: you can find the current consumption and emission values of your vehicle in the COC documents (EU CERTIFICATE OF CONFORMITY). These documents are delivered with your vehicle.

The consumption figures were in each case based on the currently applicable version:

- for vehicles that comply with standards up to and including the Euro 4 standard, in accordance with EU Directive RL 80 / 1268 / EEC
- for vehicles that comply with or exceed the Euro 5 standard, in accordance with Regulation (EC) No. 715/2007

Deviations from these values may occur under normal operating conditions.

Engine oil

General notes

The quality of the engine oil is decisive for the function and service life of an engine. After extensive tests, Mercedes-Benz approves engine oils that correspond to the current technical standard.

Therefore, only Mercedes-Benz approved engine oils may be used in Mercedes-Benz engines.

Further information on tested and approved engine oils can be obtained from any Mercedes-Benz Service Centre. Mercedes-Benz recommends that you have the oil change carried out at a qualified specialist workshop. Mercedes-Benz approval is indicated on the oil container by the inscription "MB Approval" and the corresponding designation, e.g. MB Approval 229.51.

You can call up an overview of approved engine oils on the Internet at <http://bevo.mercedes-benz.com> by entering the designation, e.g. 229.5.

The table shows which engine oils have been approved for your vehicle.

Diesel engines	MB Approval
G 300 CDI	228.51, 229.31, 229.51

i In the event that the:

- engine oil brand
- grade (MB Sheet Number)
- SAE classification (viscosity)

is not available, you can use another mineral or synthetic engine oil which has been approved by Mercedes-Benz. You must then have an oil change carried out at the earliest possible opportunity.

Mixing oils reduces the benefits of high-grade engine oil.

Capacities

The following values refer to an oil change including the oil filter.

Vehicle model	Capacity including oil filter
G 300 CDI	7.0 l

Additives

i Do not use any additives with the engine oil. This could damage the engine.

Engine oil viscosity

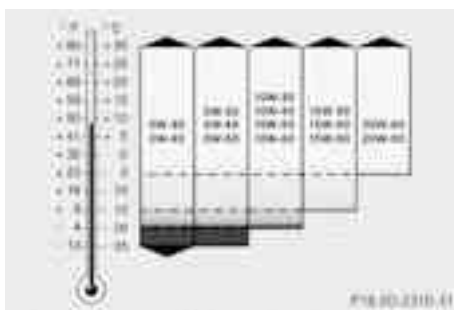

Viscosity describes the flow characteristics of a fluid. If an engine oil has a high viscosity rating, it flows slowly; the lower the viscosity, the faster it flows.

Engine oil selection is based on the respective outside temperatures and in accordance with the SAE classification (viscosity). The table shows you which SAE classifications are to be used. The low-temperature properties of engine oils can be significantly impaired during operation due to, for example, ageing or soot and fuel accretion. It is therefore strongly recommended to observe regular oil changes using an approved engine oil with the appropriate SAE classification.

Brake fluid

WARNING

The brake fluid continuously absorbs moisture from the air. This results in the boiling point of the brake fluid lowering. If the boiling point of the brake fluid is too low, vapour pockets may form when the brakes are subjected to a heavy load. This would impair braking efficiency. There is a risk of an accident. Have the brake fluid renewed at the prescribed intervals.

Observe the important safety notes for service products (▷ page 191).

Only use brake fluid approved by Mercedes-Benz according to MB Approval 331.0.

Information about approved brake fluid can be obtained at any qualified specialist workshop or on the Internet at: <http://bevo.mercedes-benz.com>.

-  Have the brake fluid regularly replaced at a qualified specialist workshop.

Coolant

Important safety notes

WARNING

If antifreeze comes into contact with hot components in the engine compartment, it may ignite. There is a risk of fire and injury.

Let the engine cool down before you top up the antifreeze. Make sure that antifreeze is not spilled next to the filler neck. Thoroughly clean the antifreeze from components before starting the engine.

-  Only add coolant that has been premixed with the desired antifreeze protection. You could otherwise damage the engine.

Further information on coolants can be found in the Mercedes-Benz Specifications for Service Products, MB Specifications for Service Products 310.1, e.g. on the Internet at <http://bevo.mercedes-benz.com>. Or contact a qualified specialist workshop.

-  Always use a suitable coolant mixture, even in countries where high temperatures prevail.

Otherwise, the engine cooling system is not sufficiently protected from corrosion and overheating.

-  The engine cooling system is filled with coolant, which must be renewed after 15 years or after 250,000 kilometres at the latest.

The coolant is a mixture of water and antifreeze/corrosion inhibitor. It is responsible for the following:

- anti-corrosion protection
- antifreeze protection
- raising the boiling point

If antifreeze/corrosion inhibitor is present in the correct concentration, the boiling point of the coolant will be around 130 °C.

The antifreeze/corrosion inhibitor concentration in the engine cooling system should:

- be at least 50 %. This will protect the engine cooling system against freezing down to approximately -37 °C.
- not exceed 55 % (antifreeze protection down to -45 °C). Heat will otherwise not be dissipated as effectively.

If the vehicle has lost coolant, top it up with equal amounts of water and antifreeze/corrosion inhibitor. Mercedes-Benz recommends an antifreeze/corrosion inhibitor in accordance with MB Specifications for Service Products 310.1.

The coolant is checked at every maintenance interval at a qualified specialist workshop.

- i** When the vehicle is first delivered, it is filled with a coolant mixture that ensures adequate antifreeze and corrosion protection.

Washer fluid

Important safety notes

WARNING

Windscreen washer concentrate is highly flammable. If it comes into contact with hot engine components or the exhaust system it could ignite. There is a risk of fire and injury. Make sure that no windscreen washer concentrate is spilled next to the filler neck.

- !** Only use washer fluid that is suitable for plastic lamp lenses, e.g. MB SummerFit or MB WinterFit. Unsuitable washer fluid could damage the plastic lenses of the headlamps.
- !** Do not use distilled or de-ionised water in the washer fluid reservoir. Otherwise, the level sensor may be damaged.
- !** Only the washer fluids SummerFit and WinterFit can be mixed. Otherwise, the spraying nozzles could become blocked.

At temperatures above freezing:

- ▶ Fill the washer fluid reservoir with a mixture of water and washer fluid, e.g. MB SummerFit.
- ▶ Mix 1 part MB SummerFit to 100 parts water.

At temperatures below freezing:

- ▶ Fill the washer fluid reservoir with a mixture of water and washer fluid, e.g. MB WinterFit.

Adapt the mixing ratio to the outside temperature.

- ▶ Down to -10 °C: mix 1 part MB WinterFit to 2 parts water.
- ▶ Down to -20 °C: mix 1 part MB WinterFit to 1 part water.
- ▶ Down to -29 °C: mix 2 parts MB WinterFit to 1 part water.

- i** Add washer fluid concentrate, e.g. MB SummerFit or MB WinterFit, to the washer fluid all year round.

Vehicle data

Vehicle data, long-wheelbase panel van

Vehicle dimensions	
Vehicle length (ECE)	4636-4770 mm
Vehicle width including exterior mirrors	1960 mm
Vehicle height	1930-1977 mm
Ground clearance	213 mm
Wheelbase	2850 mm

- i** The dimensions specified may vary depending on vehicle equipment.

Vehicle weights	
Unladen weight (in accordance with EC directive)	2585 kg
The unladen weight includes the driver (68kg), luggage (7kg) and all fluids (fuel tank 90% full). Items of optional equipment increase the unladen weight and reduce the maximum payload.	
Maximum roof load	200 kg
Vehicle-specific weight information can be found on the vehicle identification plate (▷ page 191).	

Vehicle weights	
Unladen weight (in accordance with EC Directive)	2590 kg
The unladen weight includes the driver (68 kg), luggage (7 kg) and all fluids (fuel tank 90 % full). Items of optional equipment increase the unladen weight and reduce the maximum payload.	
Maximum roof load	200 kg
Vehicle-specific weight information can be found on the vehicle identification plate (▷ page 191).	

Vehicle data, station wagon	
Vehicle dimensions	
Vehicle length (ECE)	4643-4770 mm
Vehicle width including exterior mirrors	1960 mm
Vehicle height	1930-1977 mm
Ground clearance	213 mm
Wheelbase	2850 mm

i The vehicle dimensions given may vary depending on vehicle equipment.

Vehicle data, chassis-cab	
Vehicle dimensions	
Vehicle length (ECE)¹⁶	5053-5226 mm
Platform truck vehicle length (ECE)	5362 mm
Vehicle width including exterior mirrors	2514 mm
Vehicle height	2053-2212 mm
Ground clearance	244 mm
Wheelbase	3428 mm

i Vehicle dimensions may vary depending on vehicle equipment.

¹⁶ Not platform truck.

Vehicle weights	
Unladen weight (in accordance with EC directive)	without body 2280 kg
The unladen weight includes the driver (68 kg), luggage (7 kg) and all fluids (fuel tank 90%). Items of optional equipment increase the unladen weight and reduce the maximum payload.	with platform 2620 kg
Vehicle-specific weight information can be found on the vehicle identification plate (▷ page 191).	
Maximum roof load	100 kg

Vehicle weights	
Unladen weight (in accordance with EC directive)	3650 kg
The unladen weight includes the driver (68 kg), luggage (7 kg) and all fluids (fuel tank 90%). Items of optional equipment increase the unladen weight and reduce the maximum payload.	
Maximum roof load	200 kg
Vehicle-specific weight information can be found on the vehicle identification plate (▷ page 191).	

Vehicle data, chassis cab 6x6 with crewcab	
Vehicle dimensions	
Vehicle length (ECE)	6229 mm
Vehicle width including exterior mirrors	2514 mm
Vehicle height	2030 – 2090 mm
Ground clearance	264 mm
Wheelbase	3120/1100 mm

i Vehicle dimensions may vary depending on vehicle equipment.

Trailer tow hitch

Mounting dimensions

WARNING

Only have a trailer tow hitch retrofitted at a qualified specialist workshop.

! If you have a trailer tow hitch retrofitted, observe the anchorage points on the chassis frame.

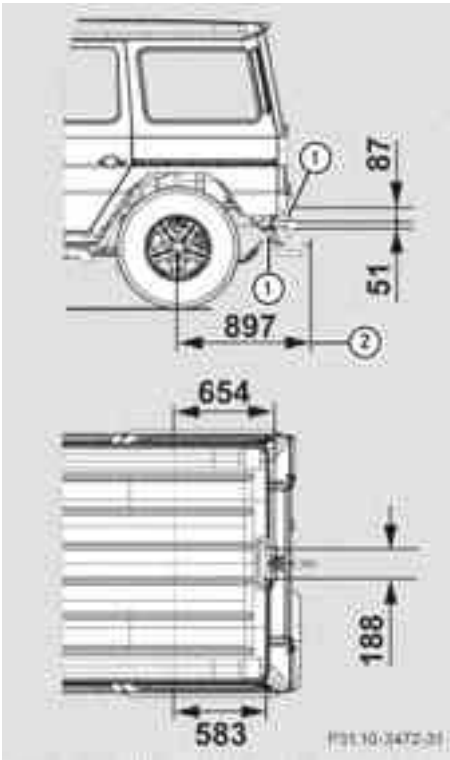

Station wagon ball coupling trailer tow hitch

- ① Anchorage points
- ② Overhang dimension

For trailer tow hitches fitted at the factory, the overhang dimension including protective covering is 897 mm.

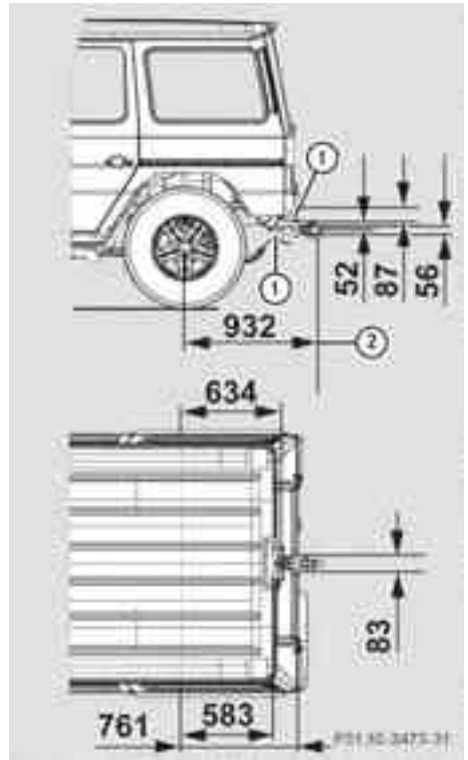

Station wagon hook trailer tow hitch

- ① Anchorage points
- ② Overhang dimension

For trailer tow hitches fitted at the factory, the overhang dimension is 932 mm.

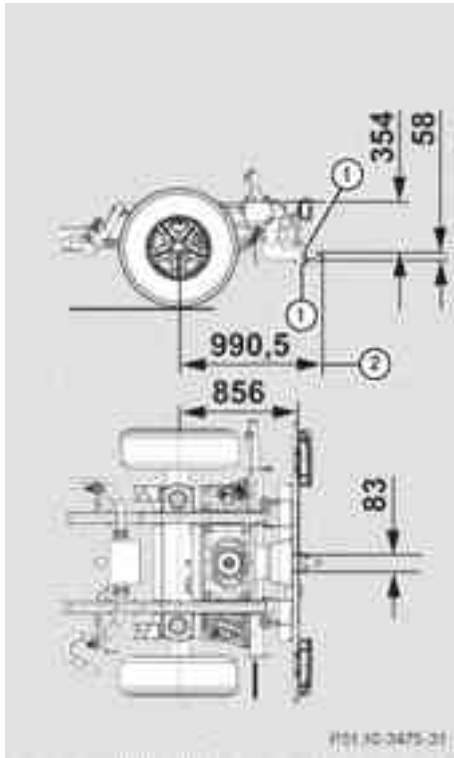

Chassis-cab ball coupling trailer tow hitch

- ① Anchorage points
- ② Overhang dimension

For trailer tow hitches fitted at the factory, the overhang dimension is 990.5 mm.

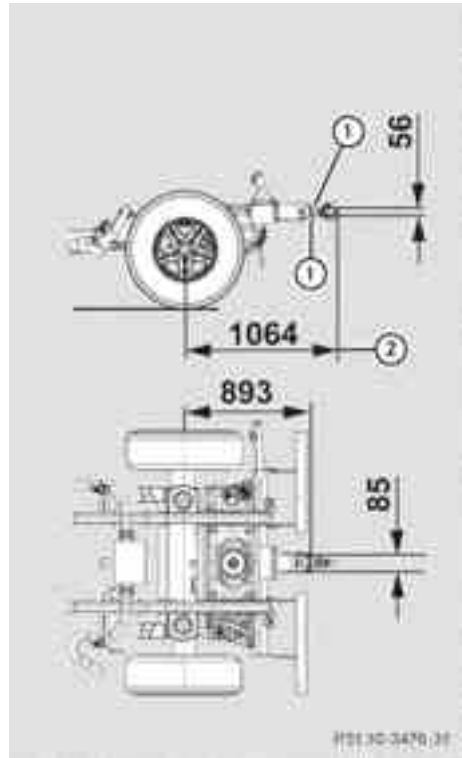

Chassis-cab hook trailer tow hitch

- ① Anchorage points
- ② Overhang dimension

For trailer tow hitches fitted at the factory, the overhang dimension is 1,064 mm.

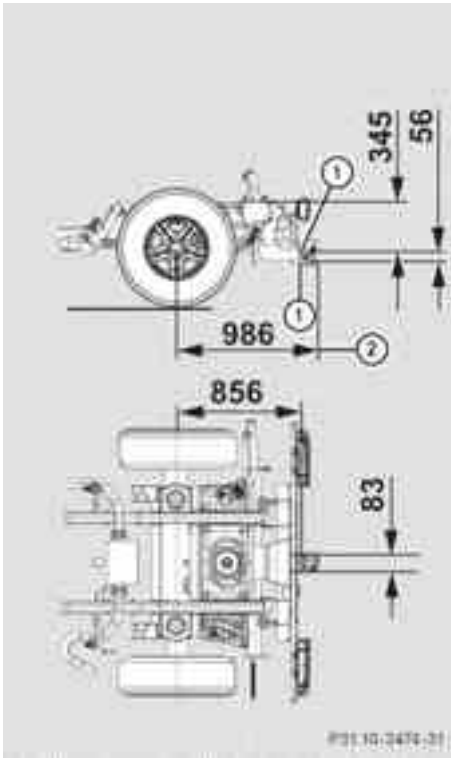

Chassis-cab coupling jaw trailer tow hitch

- ① Anchorage points
- ② Overhang dimension

For trailer tow hitches fitted at the factory, the overhang dimension is 986 mm.

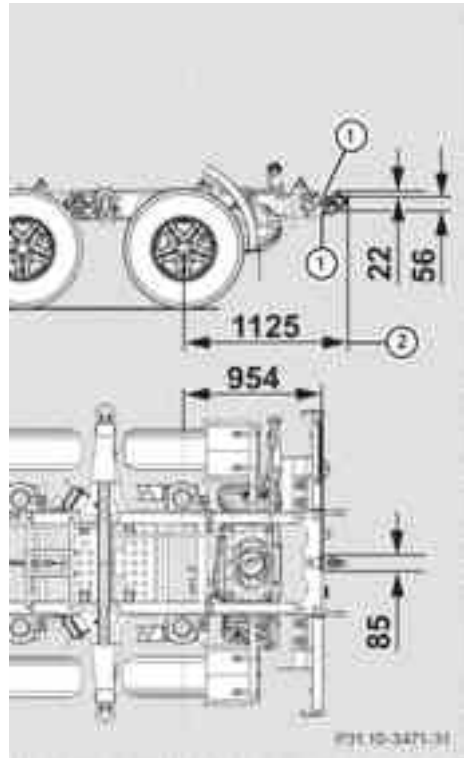

Chassis-cab 6x6 with crewcab hook trailer tow hitch

- ① Anchorage points
- ② Overhang dimension

For trailer tow hitches fitted at the factory, the overhang dimension is 1,125 mm.

Trailer loads

Long-wheelbase panel van

Permissible trailer load, unbraked	750 kg
Permissible trailer load, braked	3140 kg ¹⁷

¹⁷ Trailer load without noseweight.

Long-wheelbase panel van	
Maximum drawbar nose-weight	140 kg
Permissible rear axle load when towing a trailer	2120 kg ¹⁸ 2145 kg ¹⁸
Maximum gross vehicle weight when towing a trailer	6700 kg

Station wagon	
Permissible trailer load, unbraked	750 kg
Permissible trailer load, braked (vehicles with a 24 V electrical system)	3140 kg ¹⁷
Permissible trailer load, braked (vehicles with a 12 V electrical system and a permissible gross weight of 3200 kg)	3500 kg ¹⁹
Permissible trailer load, braked (vehicles with a 12 V electrical system and a permissible gross weight of 3500 kg)	3200 kg ¹⁷
Maximum drawbar nose-weight	140 kg
Permissible rear axle load when towing a trailer	2120 kg ¹⁸ 2145 kg ¹⁸
Maximum gross vehicle weight when towing a trailer	6700 kg

Chassis cab	
Permissible trailer load, unbraked	750 kg
Permissible trailer load, braked	2400 kg ¹⁷
Maximum drawbar nose-weight	140 kg
Permissible rear axle load when towing a trailer	2800 kg
Maximum gross vehicle weight when towing a trailer	6700 kg

Chassis-cab 6x6 with crewcab	
Permissible trailer load, unbraked	750 kg
Permissible trailer load, braked	2500 kg ¹⁷
Maximum drawbar nose-weight	140 kg
Permissible rear axle load when towing a trailer	2800/ 2800 kg
Maximum gross vehicle weight when towing a trailer	9000 kg

¹⁸ The permissible rear axle load when towing a trailer depends on the tyres of the vehicle. See the vehicle identification plate.

¹⁷ Trailer load without noseweight.

¹⁹ Trailer load including noseweight.

Internet

Further information about Mercedes-Benz vehicles and about Daimler AG can be found on the following websites:

<http://www.mercedes-benz.com>

Editorial office

You are welcome to forward any queries or suggestions you may have regarding this Owner's Manual to the technical documentation team at the following address:

Daimler AG, HPC: R822,
D-70546 Stuttgart, Germany

Not to be reprinted, translated or otherwise reproduced, in whole or in part, without written permission of Daimler AG.

As at 08.06.2012

Nur für internen Gebrauch / For internal use only



4615845581

Order no. 6515 4146 02 Part no. 461 584 55 81 Edition ÄJ 2012-1a

Nur für internen Gebrauch / For internal use only