



S-Class

Owner's Manual



Mercedes-Benz

Nur für internen Gebrauch / For internal use only

Symbols

In this Owner's Manual, you will find the following symbols:

WARNING

Warning notices draw your attention to hazards that may endanger your health or life, or the health or life of others.

Environmental note

Environmental notes provide you with information on environmentally aware actions or disposal.

 Notes on material damage alert you to dangers that could lead to damage to your vehicle.

 These symbols indicate useful instructions or further information that could be helpful to you.

▶ This symbol designates an instruction you must follow.

▶ Several consecutive symbols indicate an instruction with several steps.

(▷ page) This symbol tells you where you can find further information on a topic.

▷▷ This symbol indicates a warning or an instruction that is continued on the next page.

Display This text indicates a message on the multifunction/COMAND display.

Parts of the software in the vehicle are protected by copyright © 2005

The FreeType Project

<http://www.freetype.org>. All rights reserved.

Welcome to the world of Mercedes-Benz

First of all, familiarise yourself with your vehicle. Read the Owner's Manual, particularly the safety and warning notes, before you drive off. This will help you to obtain the maximum pleasure from your vehicle and avoid endangering yourself and others.

The equipment or model designation of your vehicle may vary according to:

- model
- order
- country variant
- availability

The illustrations in this manual show a left-hand-drive vehicle. On right-hand-drive vehicles, the layout of components and controls differs accordingly.

Mercedes-Benz is constantly updating its vehicles to the state of the art.

Mercedes-Benz therefore reserves the right to introduce changes in the following areas:

- design
- equipment
- technical features

The equipment in your vehicle may therefore differ from that shown in the descriptions and illustrations.

The following are integral components of the vehicle:

- Owner's Manual
- Service Booklet
- Equipment-dependent supplements

Keep these documents in the vehicle at all times. If you sell the vehicle, always pass the documents on to the new owner.

i You can get to know the important features of your vehicle in the interactive Owner's Manual on the Internet at:

**[http://www.mercedes-benz.de/
betriebsanleitung](http://www.mercedes-benz.de/betriebsanleitung)**

The technical documentation team at Daimler AG wishes you safe and pleasant motoring.

2215840196Z102



Nur für internen Gebrauch / For internal use only

Index 4

Introduction 30

At a glance 35

Safety 47

Opening and closing 79

Seats, steering wheel and mirrors .. 101

COMAND 115

Lights and windscreen wipers 289

Climate control 303

Driving and parking 321

On-board computer and displays 391

Stowing and features 453

Maintenance and care 475

Breakdown assistance 491

Wheels and tyres 515

Technical data 529

- 1, 2, 3 ...**
- 12 V socket**
see Socket
- 4ETS**
see ETS/4ETS (Electronic Trac-
tion System)
- 4MATIC (permanent four-wheel
drive)** 361
- 4MATIC off-road system** 361
- A**
- ABC**
see Active Body Control (ABC)
- ABS (Anti-lock Braking System)**
Display message 410
Function/notes 69
Important safety notes 69
Warning lamp 444
- Activating/deactivating air-recir-
culation mode** 311
- Activating/deactivating cooling
with air dehumidification** 307
- Active Blind Spot Assist**
Activating/deactivating (on-
board computer) 405
Display message 431
Function/notes 380
Towing a trailer 382
- Active Body Control (ABC)**
Display message 428
Function/notes 360
- Active Driving Assistance package** . 379
- Active Lane Keeping Assist**
Activating/deactivating (on-
board computer) 405
Display message 430
Function/notes 382
Towing a trailer 385
- Active light function** 293
- Active multicontour seat** 108, 286
- Active Service System PLUS**
see ASSYST PLUS service interval
display
- ADAPTIVE BRAKE** 73
- Adaptive brake lamps** 71
- Adaptive Damping System (ADS)** 359
- Adaptive Highbeam Assist**
Display message 423
Function/notes 294
- Adaptive Main-beam Assist**
Switching on/off (on-board com-
puter) 407
- AdBlue®**
Display message 425
Service indicator 481
- AdBlue® service indicator** 481
- Additional speedometer** 407
- Additives (engine oil)** 539
- Address**
Entering (example) 154
see Address book
- Address book**
Calling up 209
Connecting a call 211
Creating an entry 210
Deleting an entry 211
Entering characters 132
Entry as a home address 177
Importing contacts 207
Introduction 207
Starting route guidance 212
Voice entry 212
- Adjusting the balance** 136
- Adjusting the bass** 135
- Adjusting the brightness (TV,
video)** 242
- Adjusting the colour (TV, video)** 242
- Adjusting the contrast (TV, video)** ... 242
- Adjusting the fader** 136
- Adjusting the sound settings**
Balance and fader 136
Treble and bass 135
- Adjusting the treble (sound)** 135
- Adjusting the volume**
COMAND 135
Headphones 142
Navigation messages 135
Traffic announcements 135
Using the remote control (Rear
Seat Entertainment System) 140

- Airbags**
 Front airbag (driver, front passenger) 51
 Important safety guidelines 50
 Kneebag 52
 Sidebag 52
 Triggering 49
 Windowbag 53
- Air-conditioning system**
 see Climate control
- Air distribution**
 Setting 309
 Setting (COMAND) 279
- Air filter (white display message) ...** 425
- Airflow**
 Setting 309
 Setting (COMAND) 279
- AIRMATIC**
 Display message 427
 Function/notes 358
- Air pressure**
 see Tyre pressure
- Air vents**
 Glove compartment 318
 Important safety notes 317
 Rear 318
 Setting 317
 Setting the centre air vents 318
 Setting the side air vents 318
- Alarm system**
 see ATA (Anti-Theft Alarm system)
- Alertness Assistant**
 see ATTENTION ASSIST
- Alternative route** 171
- Ambient light setting (COMAND)** 276
- AMG menu (on-board computer)** 400
- Anti-glare film** 474
- Anti-lock Braking System**
 see ABS (Anti-lock Braking System)
- Anti-Theft Alarm system**
 see ATA (Anti-Theft Alarm system)
- Aquaplaning** 343
- Ashtray** 463
- Assistance menu (on-board computer)** 404
- ASSYST PLUS**
 see ASSYST PLUS service interval display
- ASSYST PLUS service interval display**
 Displaying service messages 482
 Hiding service messages 482
 Notes 482
 Service messages 482
- ATA (Anti-Theft Alarm system)**
 Activating/deactivating 76
 Function 76
 Interior motion sensor 76
 Switching off the alarm 76
 Tow-away protection 76
- ATTENTION ASSIST**
 Activating/deactivating 405
 Display message 426
 Function/notes 370
- Audio**
 Radio mode 217
- Audio database**
 see MUSIC REGISTER
- Audio DVD**
 Pause function 226
 Playback options 230
 Safety notes 223
 Setting the audio format 230
 Stop function 226
 Switching to 224
- Audio menu (on-board computer) ...** 398
- Authorised workshop**
 see Qualified specialist workshop
- AUTO lights**
 Display message 423
 see Lights
- Automatic engine start (ECO start/stop function)** 326
- Automatic engine switch-off (ECO start/stop function)** 326
- Automatic headlamp mode** 291
- Automatic transmission**
 Accelerator pedal position 332
 Automatic drive program 333
 Changing gear 332
 DIRECT SELECT lever 329
 Display message 438

- Drive position (ECO start/stop function) 330
 - Driving tips 332
 - Emergency running mode 336
 - Engaging drive position 330
 - Engaging neutral 330
 - Engaging park position automatically 330
 - Engaging reverse gear 330
 - Engaging the park position 329
 - Kickdown 332
 - Manual drive program 334
 - Neutral (ECO start/stop function) . 330
 - Problem (fault) 336
 - Program selector button 332
 - Pulling away 325
 - Shift ranges 333
 - Starting the engine 324
 - Steering wheel gearshift paddles ... 333
 - Trailer towing 332
 - Transmission position display 331
 - Transmission positions 331
 - Automatic transmission emergency running mode** 336
 - Autostore** 221
 - see Channel presets (TV)
 - see Station memory (radio)
 - AUX (audio)**
 - Notes/socket 241
 - Switching to 241
 - AUX (video)**
 - Connecting an external video source 253
 - Setting the picture 242
 - Setting the volume and sound 254
 - Showing/hiding the menu 254
 - Switching to 254
 - Auxiliary heating**
 - Activating/deactivating 313
 - Activating/deactivating (on the centre console) 313
 - Display message 440
 - Heater booster function 315
 - Important safety notes 312
 - Problem (display message) 317
 - Remote control 313
 - Setting the departure time 282, 315
 - Auxiliary ventilation**
 - Activating/deactivating 313
 - Activating/deactivating (on the centre console) 313
 - Heater booster function 315
 - Problem (display message) 317
 - Remote control 313
 - Axle load, permissible (trailer towing)** 545
- B
- Back button** 118
 - Bag hook** 459
 - Ball coupling**
 - Folding in 389
 - Folding out 387
 - Bang & Olufsen sound system** 138
 - BAS (Brake Assist System)** 70
 - Basic carrier**
 - see separate operating instructions
 - Basic settings**
 - see Settings
 - BAS PLUS (Brake Assist System PLUS)** 70
 - Battery (key)**
 - Checking 83
 - Important safety notes 83
 - Replacing 83
 - Battery (vehicle)**
 - Charging 506
 - Display message 424
 - Important safety notes 504
 - Jump starting 507
 - Belt**
 - see Seat belt
 - Belt force limiters (activation)** 49
 - Belt tensioner**
 - Activation 49
 - Function 58
 - Bird's-eye view (navigation)** 183
 - Blind**
 - see Roller sunblind
 - Blind Spot Assist**
 - Activating/deactivating 405
 - Display message 431

- Notes/function 376
 - Trailer towing 378
 - see Active Blind Spot Assist
 - BlueTEC (AdBlue®)** 537
 - Bluetooth®**
 - Activating/deactivating 147
 - Authorising (registering) a device .. 148
 - Conditions (general) 147
 - Conditions (telephone) 194
 - Connecting another mobile phone . 197
 - Connecting devices 147
 - De-authorising (de-registering) a device 150
 - External authorisation (general) 149
 - External authorisation (telephone) . 196
 - General information 147
 - Interface 192
 - Introduction 192
 - Receiving vCards 208
 - Searching for devices 148
 - Settings 147
 - Switching between Bluetooth® and convenience telephony 198
 - Telephone basic menu 198
 - Telephony 194
 - Telephony notes 192
 - Bluetooth® SAP V3 telephone module**
 - see Separate operating instructions
 - Bonnet**
 - Closing 477
 - Display message 440
 - Opening 476
 - Boot**
 - Emergency release 91
 - Important safety notes 88
 - Limiting the opening angle 278
 - Locking separately 90
 - Opening/closing (automatically from inside) 90
 - Opening/closing (automatically from outside) 90
 - Boot lid**
 - Display message 439
 - Opening/closing 88
 - Opening dimensions 543
 - Boot lid opening limiter** 278
 - Boot load (maximum)** 541
 - Brake Assist System**
 - see BAS (Brake Assist System)
 - Brake fluid**
 - Display message 416
 - Notes 539
 - Brake lamps**
 - Adaptive 71
 - Display message 421
 - Brakes**
 - ABS 69
 - BAS 70
 - BAS PLUS 70
 - Brake fluid (notes) 539
 - Display message 410
 - Driving tips 342
 - High-performance brake system 343
 - Important safety notes 342
 - Parking brake 340
 - Warning lamp 444
 - Breakdown**
 - see Flat tyre
 - see Towing away
 - Breakdown assistance**
 - see Mercedes-Benz Contact
 - Bulbs**
 - see Changing bulbs
- C**
- Call**
 - Accepting/ending/rejecting 200
 - see Telephone
 - Calling up a fault**
 - see Display messages
 - Calling voicemail** 201
 - Call list**
 - Display details 209
 - Introduction 213
 - Call lists**
 - Opening and selecting an entry 213
 - Saving an entry in the address book 213
 - Capacities (technical data)** 533
 - Car**
 - see Vehicle

- Care**
- Automatic car wash 483
 - Carpets 489
 - Display 487
 - Exterior lighting 486
 - Gear or selector lever 488
 - High-pressure cleaner 484
 - Interior 487
 - Matt paintwork 485
 - Night View Assist Plus 487
 - Notes 483
 - Paint 485
 - Plastic trim 488
 - Reversing camera 487
 - Roof lining 489
 - Seat belt 489
 - Seat cover 488
 - Sensors 487
 - Steering wheel 488
 - Tail pipes 487
 - Trim pieces 488
 - Washing by hand 484
 - Wheels 485
 - Windows 485
 - Wiper blades 486
 - Wooden trim 488
- Car key**
see Key
- Car wash (care)** 483
- CD**
- Copy protection 232
 - Fast forward/fast rewind 228
 - General information 232
 - Inserting 223
 - Inserting/loading (Rear Seat Entertainment System) 258
 - Multisession 230
 - Notes on compact discs 232
 - Operating the player/changer (on-board computer) 399
 - Pause function 226
 - Playback options 230
 - Player/changer operation (COMAND) 223
 - Removing/ejecting (Rear Seat Entertainment System) 259
 - Safety notes 223
 - Selecting a media type 227
 - Selecting a track 227
 - Sound settings (balance, bass, fader, treble) 135
 - Switching to 224
- Cell phone**
see Mobile phone
- Central locking**
- Automatic locking feature (COMAND) 276
 - Locking/unlocking (key) 80
- Centre console** 42
- Changing batteries (remote control, headphones)** 254
- Changing bulbs**
- Important safety notes 297
 - Main-beam headlamps (bi-xenon) .. 298
 - Main-beam headlamps (Intelligent Light System) 298
 - Overview of bulb types 297
- Changing direction**
- Announcement phase 167
 - Change of direction phase 167
 - Preparation phase 167
- Changing the picture format (TV, video)** 242
- Character bar** 130
- Characters**
- Entering 130
 - Entering (address book, phone book) 132
 - Entering (navigation) 130
- Child-proof locks**
- Important safety notes 67
 - Rear doors 67
- Children**
- In the vehicle 59
 - Restraint systems 59
- Child seat**
- Automatic recognition 61
 - Display message 418
 - ISOFIX 63
 - On the front-passenger seat 61
 - Problem (malfunction) 65
 - Recommendations 66
 - Suitable positions 65
 - Top Tether 63
- Cigarette lighter** 463

Cleaning	
Mirror turn signal	486
Climate control	
Automatic air conditioning	305
Auxiliary heating/ventilation	312
COMAND	278
Controlling automatically	307
Controlling centrally (COMAND)	280
Convenience opening/closing (air-recirculation mode)	311
Cooling with air dehumidification ..	307
Cooling with air dehumidification (COMAND)	280
Demisting the windows	310
Demisting the windscreen	310
Important safety notes	304
Indicator lamp	307
Main menu	279
Notes on using automatic climate control	306
Overview of systems	304
Problems with cooling with air dehumidification	307
Problem with the rear window heating	311
Rear compartment (COMAND)	281
Rear control panel	305
Setting the air distribution	309
Setting the airflow	309
Setting the airflow (COMAND)	281
Setting the air vents	317
Setting the footwell temperature (COMAND)	280
Setting the temperature	308
Switching air-recirculation mode on/off	311
Switching on/off	306
Switching residual heat on/off	312
Switching the rear window heat- ing on/off	310
Coat hooks	456
Cockpit	
Overview	36
see Instrument cluster	
COMAND	
At a glance (overview)	117
Back button	118
Basic functions	134
Components	117
Display	121
Example of operation	129
Function buttons	119
Menu overview	122
Remote control	125
Switching on/off	134
System settings	143
COMAND controller	118
COMAND display	
Cleaning instructions	125
Setting	143
Swivelling and folding in	124
COMAND operating system	117
Combination switch	292
Compass function	187
Conference connection	202
Constant headlamp mode	
see Daytime driving lights	
Consumption statistics (on-board computer)	396
Convenience closing feature	93
Convenience opening/closing (air- recirculation mode)	311
Convenience opening feature	92
Convenience telephone	
Importing contacts	207
Convenience telephony	192
Connecting a mobile phone	215
Introduction	192
Switching between Bluetooth® and convenience telephony	198
Text message (SMS)	204
Transferring a call	203
Coolant (engine)	
Checking the level	480
Display message	423
Notes	540
Temperature (on-board computer) .	400
Temperature gauge	392
Coolbox	465
Cooling	
see Climate control	
Copy protection (CD/DVD)	232
Cornering light function	
Display message	420
Function/notes	294

- Cruise control**
 - Cruise control lever 345
 - Deactivating 346
 - Display message 434
 - Driving system 344
 - Important safety notes 344
 - LIM indicator lamp 345
 - Selecting 345
 - Setting a speed 345
 - Storing and maintaining current speed 345
 - Cup holder**
 - Centre console 461
 - Important safety notes 461
 - Rear compartment 461
- D**
- DAB radio (Digital Audio Broadcasting)**
 - Searching for an ensemble 219
 - Selecting a station 219
 - Sub-programmes 223
 - see Radio
 - Dashboard**
 - see Cockpit
 - Data**
 - see Technical data
 - Data carrier**
 - Audio DVD 230
 - MUSIC REGISTER 232
 - Daytime driving lights**
 - Display message 422
 - Switching on/off (on-board computer) 406
 - Switching on/off (switch) 291
 - Dealership**
 - see Qualified specialist workshop
 - Display switch-off**
 - Exterior lighting (COMAND) 275
 - Interior lighting (COMAND) 275
 - Destination (navigation)**
 - Displaying information 171
 - Entering a destination by address .. 154
 - Entering a destination using the map 160
 - Entering an intermediate stop 161
 - Entering a POI 163
 - Saving 179
 - Selecting from the destination memory 159
 - Selecting from the list of last destinations 160
 - Destination memory (navigation)**
 - Deleting an entry 180
 - Entering/saving your home address 157
 - Previous destinations 180
 - Diagnostics connection** 31
 - Dialling a number (telephone)** 200
 - Diesel** 535
 - Diesel particle filter** 341
 - Digital radio**
 - see DAB radio (Digital Audio Broadcasting)
 - Digital speedometer** 396
 - Digital TV**
 - see TV
 - Dipped-beam headlamps**
 - Display message 420
 - Setting for driving abroad (symmetrical) 290
 - Setting for driving on the right/left 406
 - Switching on/off 291
 - DIRECT SELECT lever**
 - see Automatic transmission
 - Disc**
 - CD/DVD 232
 - MP3 230
 - Display**
 - Selecting the design 143
 - Settings 143
 - Display (cleaning instructions)** 487
 - Displaying the arrival time** 171
 - Displaying the distance to the destination** 171
 - Display message**
 - General information 409
 - Hiding (on-board computer) 409
 - Display messages**
 - ASSYST PLUS service interval display 482
 - Calling up (on-board computer) 409
 - Driving systems 426

- Engine 423
- Key 441
- Lights 419
- Safety systems 410
- Tyres 435
- Vehicle 438
- Distance**
see Route overview
- Distance display (on-board computer)** 404
- Distance recorder**
see Trip meter
- Distance warning signal (warning lamp)** 450
- DISTRONIC PLUS**
 - Deactivating 355
 - Display message 432
 - Displays in the multifunction display 354
 - Driving tips 356
 - Function/notes 348
 - Important safety notes 348
 - Selecting 350
 - Setting the specified minimum distance 354
 - Warning lamp 450
- Dolby® Digital** 136
- Door**
 - Automatic locking (switch) 87
 - Central locking/unlocking (key) 80
 - Control panel 44
 - Display message 440
 - Emergency locking 88
 - Emergency unlocking 88
 - Important safety notes 86
 - Opening (from the inside) 87
 - Power closing 87
- Drinks holder**
see Cup holder
- Drive program**
 - Automatic 333
 - Manual 334
- Driver's door**
see Door
- Driver's seat**
see Seats
- Drive system**
 - Active Blind Spot Assist 380
- Driving abroad**
 - Service24h 483
 - Symmetrical dipped beam 290
- Driving Assistance package** 376
- Driving safety system**
 - BAS PLUS (Brake Assist System PLUS) 70
 - Electronic Brake-force Distribution 73
 - ESP® (Electronic Stability Program) 72
 - ETS/4ETS (Electronic Traction System) 72
 - Important safety guidelines 69
- Driving safety systems**
 - ABS (Anti-lock Braking System) 69
 - ADAPTIVE BRAKE 73
 - Adaptive brake lamps 71
 - BAS (Brake Assist System) 70
 - Overview 69
 - PRE-SAFE® Brake 74
- Driving system**
 - Active Lane Keeping Assist 382
 - Driving Assistance package 376
- Driving systems**
 - Active Body Control 360
 - Active Driving Assistance package 379
 - AIRMATIC 358
 - ATTENTION ASSIST 370
 - Blind Spot Assist 376
 - Cruise control 344
 - Display message 426
 - DISTRONIC Plus 348
 - HOLD function 357
 - Lane Keeping Assist 378
 - Night View Assist Plus 373
 - Parking Guidance 365
 - PARKTRONIC 361
 - Reversing camera 369
 - Speed Limit Assist 371
 - SPEEDTRONIC 346
- Driving tips**
 - Aquaplaning 343
 - Automatic transmission 332

Brakes	342
DISTRONIC PLUS	356
Downhill gradient	342
Driving abroad	290
Driving in winter	344
Driving on flooded roads	343
Driving on wet roads	343
General	341
Icy road surfaces	344
Limited braking efficiency on salted roads	342
New brake pads/linings	343
Running-in tips	322
Snow chains	519
Symmetrical dipped beam	290
Towing a trailer	385
Tyre grip	343
Wet road surface	342
DTMF tone transmission	203
DVD	
Changer	223
Copy protection	232
Fast forward/fast rewind	228
Handling	188
Inserting	223
Inserting/loading (Rear Seat Entertainment System)	258
Notes on discs	232
Removing/ejecting (Rear Seat Entertainment System)	259
Selecting a media type	227
Selecting a track	227
Sound settings (balance, bass, fader, treble)	135
DVD audio	
Operating (on-board computer)	399
DVD video	
Operating (on-board computer)	399
Dynamic route guidance/TMC	
Displaying traffic reports	175
Displays on the map	174
Introduction	174
Reading out traffic reports	177
Switching on/off	174
Dynamic route planning	
see Dynamic route guidance/TMC	

E**EASY-ENTRY feature**

Activating (COMAND)	274
Function/notes	110

EASY-EXIT feature

Activating (COMAND)	274
Crash-responsive	111
Function/notes	110

EBD (electronic brake force distribution)

Display message	413
Function/notes	73

ECO function 273**ECO start/stop function**

Deactivating/activating	327
General information	325

Electrical fuses

see Fuses

Electronic brake force distribution

see EBD (electronic brake force distribution)

Electronic Stability Program

see ESP® (Electronic Stability Program)

Electronic Traction System

see ETS/4ETS (Electronic Traction System)

Emergency key

Unlocking the driver's door	88
-----------------------------------	----

Emergency key element

Function/notes	82
----------------------	----

Emergency release

Driver's door	88
---------------------	----

Emergency spare wheel

Notes/data	527
Storage location	493

Emergency unlocking

Boot	91
Vehicle	88

Engine

Display message	423
ECO start/stop function	325
Engine number	533
Jump-starting	507
Running irregularly	328
Starting problems	328
Starting the engine with the key	324
Starting with KEYLESS GO	324

- Stopping 339
 - Tow-starting (vehicle) 511
 - Warning lamp (engine diagnostics) 450
 - Engine electronics**
 - Notes 531
 - Problem (fault) 328
 - Engine oil**
 - Additives 539
 - Checking the oil level 477
 - Checking the oil level using the dipstick 478
 - Checking the oil level using the on-board computer 478
 - Display message 424
 - Filling capacity 538
 - Notes about oil grades 538
 - Notes on oil level/consumption 477
 - Temperature (on-board computer) . 400
 - Topping up 479
 - Viscosity 539
 - Entering the frequency** 220
 - Entry**
 - Deleting 131
 - Saving 133
 - Environmental protection**
 - Note 30
 - Returning an end-of-life vehicle 30
 - ESP® (Electronic Stability Program)**
 - Deactivating/activating 404
 - Deactivating/activating (notes) 72
 - Display message 410
 - ETS/4ETS 72
 - Function/notes 72
 - Important safety guidelines 72
 - Trailer stabilisation 73
 - Warning lamp 446
 - ETS/4ETS (Electronic Traction System)** 72
 - Exhaust tail pipe (cleaning instructions)** 487
 - Exterior lighting**
 - see Exterior lighting
 - Exterior mirror parking position**
 - Adjusting (COMAND) 274
 - Exterior mirrors**
 - Adjusting 111
 - Anti-dazzle mode (automatic) 112
 - Folding in/out (automatically) 112
 - Folding in/out (electrically) 111
 - Out of position (troubleshooting) ... 112
 - Parking position 112
 - Storing settings (memory function) 113
- F**
- Factory setting (reset function)** 150
 - Fast forward**
 - Audio mode (CD, DVD, MP3) 228
 - Rear Seat Entertainment System ... 263
 - Video DVD 250
 - Fast rewind**
 - Audio mode (CD, DVD, MP3) 228
 - Rear Seat Entertainment System ... 263
 - Video DVD 250
 - Fatigue Assist**
 - see ATTENTION ASSIST
 - Fault message**
 - see Display messages
 - Favourites (COMAND)** 119
 - Filler cap**
 - see Fuel filler flap
 - Fire extinguisher** 492
 - First-aid kit** 492
 - Flat tyre**
 - Changing a wheel/fitting the spare wheel 498
 - MOExtended run-flat system 503
 - Preparing the vehicle 494
 - Raising the vehicle 500
 - TIREFIT kit 494
 - Floormat** 473
 - Foglamps**
 - Extended range 294
 - Switching on/off 291
 - Folding table** 456
 - Frequencies**
 - Garage door opener 469
 - Mobile phone 531
 - Two-way radio 531
 - Front foglamps**
 - Display message 421

- Front-passenger seat**
 Adjusting from the driver's seat 105
 Adjusting from the rear compartment 105
- Front windscreen**
 see Windscreen
- Fuel**
 Additives 535
 Displaying the current consumption 396
 Displaying the range 396
 Fuel gauge 38
 Grade (petrol) 534
 Important safety notes 533
 Notes about consumption 536
 Notes for AMG vehicles 535
 Problem (malfunction) 338
 Quality (diesel) 535
 Refuelling 336
 Tank content/reserve fuel 534
- Fuel filler flap Opening/closing** 337
- Fuel filter (white display message)** . 425
- Fuel level**
 Calling up the range (on-board computer) 396
 Gauge 38
- Fuel reserve**
 see Fuel
- Fuel tank**
 Capacity 534
 Problem (malfunction) 338
- Function buttons (COMAND)** 119
- Fuses**
 Allocation chart 512
 Before changing 512
 Dashboard fuse box 512
 Fuse box in the engine compartment 513
 Fuse box in the rear compartment . 512
 Important safety notes 511
- G**
- Garage door opener**
 Clearing the memory 469
 Frequencies 469
 Important safety notes 467
 Opening/closing the garage door .. 469
 Programming (button in the rear-view mirror) 467
- Gear indicator (on-board computer)** 400
- Gear or selector lever (cleaning instructions)** 488
- Genuine Mercedes-Benz parts** 530
- Glove compartment** 454
- GPS reception** 151
- Gracenote Media Database** 229
- H**
- Handbrake**
 see Parking brake
- Hands-free microphone, switching on/off** 201
- Harman/kardon® Logic 7® surround sound system**
 see Surround sound (harman/kardon® surround sound system)
- Hazard warning lamps** 293
- Heading up (navigation)** 183
- Headlamp**
 Cleaning system (function) 292
- Headlamp cleaning system**
 Notes 540
- Headlamps**
 Misting up 296
 Topping up the cleaning system 481
 see Automatic headlamp mode
- Headphones**
 Changing batteries 254
 Function overview 142
 Indicator lamp 142
 Selecting a screen 142
 Switching on/off 142
- Head restraints**
 Adjusting 106
 Adjusting (electrically) 106
 Adjusting (rear) 107
 NECK-PRO 106
 NECK-PRO luxury 106
 see NECK-PRO head restraints/
 NECK-PRO luxury head restraints
- Heater booster function** 315

- Heating**
see Climate control
- High-pressure cleaners** 484
- Hill start assist** 325
- HOLD function**
Display message 429
Function/notes 357
- Home**
see Home address
- Home address**
Entering and saving 157
Selecting from the destination
memory 159
- I**
- Ignition lock**
see Key positions
- Immobiliser** 75
- In-car hotspot**
see Separate operating instructions
- Indicator and warning lamps**
DISTRONIC PLUS 450
Engine diagnostics 450
Fuel tank 450
- Indicator lamps**
Display message 420
see Warning and indicator lamps
- Indicators**
see Turn signals
- Insect protection on the radiator** 477
- Instrument cluster**
Overview 38
Warning and indicator lamps 40
- Instrument lighting**
see Instrument cluster lighting
- Intelligent Light System**
Activating/deactivating 406
Display message 422
Overview 293
Setting the dipped-beam head-
lamps for driving on the right/left . 406
- Interface (USB, iPod®)**
see Media Interface
- Interior lighting** 275, 296
Ambient light (COMAND) 276
Automatic control system 296
Manual control 297
- Overview 296
Reading lamp 296
- Interior motion sensor**
Function 76
Priming/deactivating the interior
motion sensor (COMAND) 277
- Intermediate stop**
Deleting 163
Entering 161
- iPod®**
Alphabetic track selection 239
Connecting to Media Interface 236
Selecting a category/playlist 238
Supported variants 236
- ISOFIX child seat securing system** 63
- J**
- Jack**
Storage location 493
Using 500
- Jump start (engine)**
see Jump starting (engine)
- Jump starting (engine)** 507
- K**
- Key**
Changing the battery 83
Checking the battery 83
Convenience closing feature 93
Convenience opening feature 92
Display message 441
Door central locking/unlocking 80
Emergency key element 82
Loss 85
Modifying the programming 82
Positions (ignition lock) 323
Problem (malfunction) 85
Starting the engine 324
- KEYLESS-GO**
Convenience closing 93
Locking 81
Start/Stop button 323
Starting the engine 324
Unlocking 81

Key positions

Key	323
KEYLESS GO	323

Kickdown

Driving tips	332
Manual drive program	334

Kneebag	52
----------------------	----

L**Lamps**

see Warning and indicator lamps

Lane-change assistant

see Blind Spot Assist

Lane detection (automatic)

see Lane Keeping Assist

Lane Keeping Assist

Activating/deactivating	405
Display message	430
Function/information	378

Lap time (RACETIMER)	400
-----------------------------------	-----

Lashing eyelets	459
------------------------------	-----

Letter bar

see Character bar

Licence plate lamp (display mes-

sage)	421
--------------------	-----

Lighting

see Lights

Lights

Activating/deactivating the Intel-	
ligent Light System	406
Active light function	293
Automatic headlamp mode	291
Cornering light function	294
Dipped-beam headlamps	291
Driving abroad	290
Foglamps	291
Foglamps (extended range)	294
Hazard warning lamps	293
Headlamp flasher	293
Light switch	290
Main-beam headlamps	292
Motorway mode	294
Parking lamps	290
Rear foglamp	292
Switching Adaptive Highbeam	
Assist on/off	407

Switching the daytime driving	
lights on/off (on-board computer) .	406

Switching the daytime driving	
lights on/off (switch)	291

Turn signals	292
--------------------	-----

see Changing bulbs

see Interior lighting

Light sensor (display message)	423
---	-----

LIM indicator lamp

Cruise control	345
DISTRONIC PLUS	350
Variable SPEEDTRONIC	347

Limiting the speed

see SPEEDTRONIC

LINGUATRONIC

Settings	145
----------------	-----

Loading guidelines	454
---------------------------------	-----

Locator lighting setting (COMAND) .	276
--	-----

Locking

see Central locking

Locking (doors)

Automatic	87
Emergency locking	88
From inside (central locking but-	
ton)	87

Locking centrally

see Central locking

Locking verification signal (on-

board computer)	408
------------------------------	-----

Logic 7® (harman/kardon® sur-

round sound system)

see Surround sound (harman/
kardon® surround sound system)

Lubricant additives

see Additives

Luggage compartment

Power closing feature	87
-----------------------------	----

Luggage net	457
--------------------------	-----

Lumbar support

Adjusting	108
-----------------	-----

Lumbar supports (COMAND)	283
---------------------------------------	-----

M	
M+S tyres	518
Main-beam headlamps	
Changing bulbs (bi-xenon)	298
Changing bulbs (Intelligent Light System)	298
Display message	421
Switching Adaptive Highbeam Assist on/off	294
Switching on/off	292
Maintenance	
see ASSYST PLUS service interval display	
Map	
Moving	161
Map (navigation)	
Adjusting the scale	182
Arrival time/distance to the destination	184
City model	186
Display	183
Geo-coordinate display	185
Heading	183
Information in the display	184
Moving	182
North orientation	183
Notes	181
POI symbols	184
RDS-TMC displays	174
Road display	185
Saving the crosshair position	182
Setting to the vehicle destination ..	182
Topographical map	186
Massage function (PULSE)	286
Matt finish (cleaning instructions) ..	485
Media Interface	
Active partition	240
Alphabetical track selection	239
Connecting an external audio source	236
Connecting an external video source	253
Connection options	235
iPod®	235
Mode	235
Notes on USB devices	241
Playback options	240
Selecting categories	238
Selecting folders	238
Selecting music files	238
Selecting playlists	238
Switching on	236
USB mass storage device	235
Media list	
Audio mode (CD, DVD, MP3)	227
Video DVD	250
Memory card (audio)	399
Memory function	113
Menu item	
Selecting	126
Mercedes-Benz Contact	216
Mercedes-Benz Service Centre	
see Qualified specialist workshop	
Message memory (on-board computer)	409
Messages	
see Display messages	
Microphone, switching on/off	201
Mirrors	
see Exterior mirrors	
see Rear-view mirror	
see Vanity mirror	
Mobile phone	
Frequencies	531
Installation	531
Menu (on-board computer)	402
Notes/placing in the bracket	466
Transmission output (maximum)	531
Modifying the programming (key)	82
MOExtended run-flat system	503
Motorway information	187
Motorway mode	294
MP3	
Bit/sampling rates	231
Copyright	231
Disc	230
Fast forward/fast rewind	228
File systems	230
Formats	231
Notes	230
Operating	399
Pause function	226
Playback options	230
Safety notes	223

- Selecting a media type 227
- Selecting a track 227
- Sound settings (balance, bass, fader, treble) 135
- Switching to 224
- Multicontour seat**
- Front 284
- Multi-contour seat**
- Rear compartment 107
- Multifunction display**
- Function/notes 394
- Lane recommendations 169
- Multifunction steering wheel**
- Adjusting the volume 135
- Operating the on-board computer . 393
- Overview 41
- Using the telephone 200
- Multisession CD** 230
- Music library**
- see MUSIC REGISTER
- MUSIC REGISTER**
- Copying music data 233
- Deleting all music files 234
- Deleting individual music files 235
- Folder functions 234
- General notes 232
- Memory space info 234
- Playback options 235
- Switching on 232
- Music search** 228
- Muting** 134
- My address (navigation)**
- see Home address

N

Navigation

- Adjusting the volume of the navigation announcements 135
- Alternative route 171
- Basic settings 152
- Blocking a route section affected by a traffic jam 170
- Compass function 187
- Destination memory 177
- Displaying destination information (arrival time, distance to destination) 171
- Dynamic route guidance/TMC 174
- Entering/saving your home address 157
- Entering a destination 153
- Entering a destination by address .. 154
- Entering a destination using the map 160
- Entering an intermediate stop 161
- Entering a POI 163
- Entering characters (character bar) 130
- General notes 151
- GPS reception 151
- Installing map software 187
- Lane recommendation 168
- Map settings 181
- Motorway information 187
- Off-road/off-map (off-road destination) 173
- On-board computer 397
- Previous destinations 180
- Reading out traffic reports 177
- Repeating announcements 170
- Route guidance 166
- Route overview 172
- Safety notes 151
- Selecting a destination from the destination memory 159
- Selecting a destination from the list of last destinations 160
- Selecting your home address 159
- Setting route options (avoiding: motorways, toll roads, tunnels, ferries) 152
- Setting the route type (short route, fast route, dynamic route or economic route) 152
- Showing/hiding the menu 152
- Starting route calculation 156
- Switching announcements on/off . 170
- Switching on 152
- Troubleshooting 191
- NECK-PRO head restraints**
- Operation 54
- Resetting after being triggered 54
- NECK-PRO luxury head restraints**
- Operation 54
- Resetting after being triggered 54

- New aluminium style carrier bars**
see Separate installation instructions
- Night View Assist Plus**
Activating/deactivating 374
Cleaning 487
Display message 427
Function/notes 373
Problem (fault) 376
- North orientation (navigation)** 183
- Notes on running in a new vehicle** .. 322
- Number keypad** 130
- O**
- Occupant safety**
Children in the vehicle 59
Important safety notes 48
- Odometer** 396
see Total distance recorder
see Trip meter
- Off-road** 173
- Oil**
see Engine oil
- On-board computer**
AMG menu 400
Assistance menu 404
Audio menu 398
Displaying a service message 482
Display messages 409
DISTRONIC PLUS 354
Important safety notes 392
Menu overview 395
Message memory 409
Navigation menu 397
Operating the TV 399
Operating video DVD 399
Operation 393
RACETIMER 400
Service menu 405
Settings menu 406
Standard display 396
Telephone menu 402
Trip menu 396
- Opening limiter for boot lid** 278
- Operating safety**
Diagnostics connection 31
- Operating system**
see On-board computer
- Outside lighting**
Delayed switch-off (COMAND) 275
- Outside temperature display** 393
- Overhead control panel** 43
- Override feature**
Rear side windows 68
- P**
- Paint code** 532
- Paintwork (cleaning instructions)** ... 485
- Panic alarm** 69
- Panorama sliding sunroof**
Important safety information 94
Opening/closing 96
Problem (malfunction) 98
Rain closing feature 96
Resetting 98
- Park Assist**
Parking Guidance 365
- Parking** 339
Important safety notes 339
Parking brake 340
Position of exterior mirror, front-
passenger side 112
Reversing camera 369
see PARKTRONIC
- Parking aid**
see Exterior mirrors
see PARKTRONIC
- Parking brake**
Display message 413
Electric parking brake 340
- Parking Guidance**
Display message 431
Important safety notes 365
Trailer towing 369
- Parking lamps**
Display message 422
Switching on/off 290
- Parking position**
Exterior mirrors (COMAND) 274
- PARKTRONIC**
Deactivating/activating 363
Driving system 361
Function/notes 361
Important safety notes 361
Problem (fault) 365

- Sensor range 362
 - Trailer towing 364
 - Warning display 363
 - PASSENGER AIRBAG OFF warning lamp** 61
 - Pause function**
 - Audio mode (CD, DVD, MP3) 226
 - Rear Seat Entertainment System ... 263
 - Video DVD 251
 - Permanent four-wheel drive**
 - see 4MATIC (permanent four-wheel drive)
 - Petrol** 534
 - Phone**
 - see Telephone
 - Phone book**
 - Calling up 209
 - Creating an entry 210
 - Deleting an entry 211
 - Entering characters 132
 - Introduction 207
 - Picture settings (TV, video)** 242
 - Plastic trim (cleaning instructions)** . 488
 - Playback options**
 - Audio mode (CD, DVD, MP3) 230
 - POI (navigation)**
 - Assigning a category 164
 - Entering 163
 - Entering a POI using the map 166
 - List 165
 - Power closing feature** 87
 - Power socket**
 - Boot 465
 - Power windows**
 - see Side windows
 - PRE-SAFE® (preventive occupant safety system)**
 - Display message 417
 - Operation 53
 - PRE-SAFE® Brake**
 - Activating/deactivating 405
 - Display message 417
 - Function/notes 74
 - Warning lamp 450
 - Preventive occupant safety system**
 - see PRE-SAFE® (preventive occupant safety system)
 - Previous destinations (navigation)** .. 180
 - Programmable button** 119
 - Program selector button** 332
 - Pulling away (automatic transmission)** 325
 - PULSE**
 - see Massage function (PULSE)
- Q**
- Qualified specialist workshop** 32
- R**
- RACETIMER (on-board computer)** 400
 - Radar sensor system**
 - Activating/deactivating 408
 - Country overview 545
 - Display message 430
 - Radiator cover** 477
 - Radio**
 - Calling up the station list 129
 - Radio text 222
 - RDS (Radio Data System) 221
 - Selecting a station 398
 - Setting a station 219
 - Sound settings (balance, bass, fader, treble) 135
 - Storing stations 221
 - Switching on 217
 - Switching wavebands 218
 - Traffic Programme 222
 - Radio-controlled devices (fitting)** 473
 - Radio Data System**
 - see RDS (Radio Data System)
 - Rain closing feature**
 - Panorama sliding sunroof 96
 - Sliding sunroof 95
 - RDS (Radio Data System)**
 - General notes 221
 - Switching on/off 221
 - RDS-TMC**
 - see TMC (Traffic Message Channel)
 - Reading lamp** 296

- Rear compartment**
 Activating/deactivating the air conditioning 306
 Setting the air distribution 309
 Setting the airflow 309
 Setting the air vents 318
 Setting the temperature 308
- Rear-compartment seat belt status indicator** 58
- Rear foglamp**
 Display message 422
 Display message (12-button multifunction steering wheel) 422
 Switching on/off 292
- Rear seat**
 Adjusting 104
- Rear Seat Entertainment System**
 Adjusting the sound settings 256
 Audio mode (CD, DVD, MP3) 258
 AUX mode 271
 Changing batteries (remote control, headphones) 254
 Changing the picture format 257
 Components/overview 139
 Multiple users 256
 Overview of picture settings 256
 Remote control 140
 Screen 140
 Setting the audio format 265
 System settings 257
 TV AUX mode 270
 TV mode 266
 Using headphones 255
 Using the main loudspeaker 255
 Video DVD mode 261
 Wireless headphones 142
 see Separate operating instructions
- Rear seats**
 Overview 46
- Rear-view mirror** 112
- Rear window blind** 462
 see Rear window roller sunblind
 see Roller sunblind
- Rear window heating**
 Problem (fault) 311
 Switching on/off 310
- Redialling (telephone)** 200
- Refuelling**
 Fuel gauge 38
 Important safety notes 336
 Refuelling process 337
 see Fuel
- Remote control**
 Auxiliary heating/ventilation 313
 Changing the batteries (auxiliary heating) 315
 Garage door opener 467
 Programming (garage door opener) 467
- Remote operation**
 Selecting a screen (Rear Seat Entertainment System) 140
 Switching a screen on/off (Rear Seat Entertainment System) 141
- Replacing the battery (auxiliary heating remote control)** 315
- Reserve (fuel tank)**
 see Fuel
- Reserve fuel**
 Display message 425
 Warning lamp 450
- Reset function** 150
- Resetting (factory settings)** 150
- Residual heat (climate control)** 312
- Restraint system**
 see SRS (Supplemental Restraint System)
- Rev counter** 392
- Reversing camera**
 Cleaning instructions 487
 Function/notes 369
- Reversing lamp (display message)** .. 422
- Roadmap**
 see Map
- Roller blind**
 see Roller sunblind
- Roller sunblind**
 Panorama sliding sunroof 97
 Rear window 462
 Rear window (COMAND) 274
- Roller sunblind of the panorama sliding sunroof**
 Operating (front roller sunblind) 97
 Operating (rear roller sunblind) 97

- Roof carrier** 460
 - Roof lining and carpets (cleaning instructions)** 489
 - Roof load (maximum)** 541
 - Route (navigation)**
 - Displaying the distance to the destination 171
 - Route overview 172
 - Selecting an alternative route 171
 - Setting route options (avoiding: motorways, toll roads, tunnels, ferries) 152
 - Setting the route type (short route, fast route, dynamic route or economic route) 152
 - Starting calculation 156
 - see Route guidance (navigation)
 - Route guidance**
 - Cancel 169
 - Continue 169
 - Destination reached 170
 - Lane recommendations 168
 - Off-road 173
 - Route guidance (navigation)** 397
 - Route guidance (on-board computer)** 397
 - Route information**
 - see Dynamic route guidance/TMC
- S
- Safety**
 - Children in the vehicle 59
 - Child restraint systems 59
 - Safety notes**
 - Audio CD/DVD and MP3 mode 223
 - Operating safety 116
 - Video DVD mode 248
 - Safety systems**
 - see Driving safety systems
 - Screen**
 - Selecting for remote operation (Rear Seat Entertainment System) . 140
 - Switching on/off (Rear Seat Entertainment System) 126
 - see Display
 - SD memory card**
 - Loading 224
 - Searching for an ensemble (DAB radio)** 219
 - Seat**
 - Active multicontour seat 108, 286
 - Adjusting (rear compartment) 104
 - Selecting (COMAND) 284
 - Seat belt**
 - Adjusting the driver's and front-passenger seat belt 57
 - Adjusting the height 57
 - Automatic comfort-fit feature 59
 - Belt force limiter 58
 - Belt tensioner 58
 - Cleaning 489
 - Display message 417
 - Fastening 57
 - Important safety guidelines 55
 - Rear seat belt status indicator 58
 - Releasing 58
 - Switching belt adjustment on/off (on-board computer) 408
 - Warning lamp 443
 - Warning lamp (function) 58
 - Seats**
 - Adjusting (electrically) 104
 - Adjusting lumbar support 108
 - Adjusting the head restraint 106
 - Cleaning the cover 488
 - Correct driver's seat position 102
 - Important safety notes 103
 - Multicontour seat 107
 - Seat heating problem 109
 - Seat ventilation problem 109
 - Storing settings (memory function) 113
 - Switching seat heating on/off 108
 - Switching the seat ventilation on/off 109
 - Selecting channels**
 - TV 244
 - TV (Rear Seat Entertainment System) 267
 - Selecting stations**
 - Radio 219
 - Sensors (cleaning instructions)** 487
 - Service**
 - see ASSYST PLUS service interval display

- Service Centre**
 - see Qualified specialist workshop
- Service menu (on-board computer)** . 405
- Service products**
 - AdBlue® special additives 537
 - Brake fluid 539
 - Coolant (engine) 540
 - Engine oil 538
 - Fuel 533
 - Important safety notes 533
 - Washer fluid 540
- Settings**
 - Basic TV settings 247
 - Display 143
 - Menu overview 122
 - On-board computer 406
 - Picture (COMAND) 242
 - Picture (Rear Seat Entertainment System) 256
 - Sound settings 135
 - System settings 143
- Setting the audio format**
 - Audio DVD 230
 - Rear Seat Entertainment System ... 265
 - Video DVD 252
- Setting the date format** 144
- Setting the day design** 143
- Setting the language**
 - COMAND 150
 - Rear Seat Entertainment System ... 265
- Setting the night design** 143
- Setting the read-aloud speed** 145
- Setting the reception region (TV)**
 - Rear Seat Entertainment System ... 270
- Setting the vehicle level** 360
- Setting the volume**
 - Telephone calls 135
 - Video-AUX 254
- Short journeys (diesel particle filter)** 341
- Sidebag** 52
- Side windows**
 - Convenience closing 93
 - Convenience opening 92
 - Important safety notes 91
 - Opening/closing 92
- Problem (malfunction) 94
- resetting 94
- Skibag** 458
- Sliding sunroof**
 - Important safety information 94
 - Opening/closing 95
 - Problem (malfunction) 98
 - Rain closing feature 95
 - Resetting 96
 - see Panorama sliding sunroof
- Snow chains** 519
- Socket**
 - Centre console 464
 - Glove compartment 464
 - Points to observe before use 464
 - Rear compartment 465
- Sound characteristics**
 - see Sound settings
- Sound menu** 135
- Sound settings**
 - Calling up the sound menu 135
 - Rear Seat Entertainment System ... 256
 - Surround sound 136
- Spare wheel**
 - Notes/data 527
 - Storage location 493
 - see Emergency spare wheel
- Specialist workshop** 32
- Spectacles compartment** 455
- Speed, controlling**
 - see Cruise control
- Speed Limit Assist**
 - Activating/deactivating the warning function 404
 - Displaying 404
 - Display message 429
 - Display message in the multifunction display 372
 - Important safety notes 371
 - Notes (navigation) 185
- Speedometer**
 - Activating/deactivating the additional speedometer 407
 - Digital 396
 - In the Instrument cluster 38
 - Selecting the unit of measurement 407
 - see Instrument cluster

SPEEDTRONIC	
Deactivating variable	348
Display message	433
Function/notes	346
Important safety notes	346
LIM indicator lamp	347
Permanent	348
Selecting	347
Storing the current speed	347
Variable	347
SPLITVIEW	123
SRS (Supplemental Restraint System)	
Display message	418
Introduction	49
Warning lamp	449
Warning lamp (function)	49
Starting (engine)	324
Steering (display message)	440
Steering wheel	
Adjusting (electrically)	110
Button overview	41
Cleaning	488
Gearshift paddles	333
Important safety notes	109
Steering wheel heating	110
Storing settings (memory function)	113
Steering wheel gearshift paddles	333
Steering wheel heating	
Switching on/off	110
Stop function	
Audio DVD	226
Rear Seat Entertainment System ...	263
Video DVD	250
Stopwatch (RACETIMER)	400
Storing channels	
TV	245
TV (Rear Seat Entertainment System)	268
Storing stations	
Radio	221
Stowage areas	454
Stowage compartment	
Spectacles compartment	455
Stowage compartments	
Armrest (under)	456
Centre console	455
Cup holder	461
Door	456
Glove compartment	454
Important safety information	454
Luggage net	457
Rear	457
Stowage space	
Rear seat backrest	457
Rear seats (between)	457
Stowage well	460
Stowage well beneath the boot floor	460
Summer opening	
see Convenience opening feature	
Summer tyres	518
Sun blind	
Rear side windows	92
Sun visor	462
Supplement Restraint System	
see SRS (Supplemental Restraint System)	
Surround sound	
see Surround sound (harman/kardon® surround sound system)	
Surround sound (harman/kardon® surround sound system)	
Notes	136
Switching on/off	137
Suspension tuning	
Active Body Control	360
AIRMATIC	359
Switching between summer and standard time	144
Switching off the alarm (ATA)	76
Switching wavelength (radio)	218
System settings	
Bluetooth®	147
Date	143
Language	150
LINGUATRONIC (voice control)	145
Programmable button (COMAND) ..	119
Text reader speed	145
Time	143
Time zone	144

T

Tail lamps

Display message 421

Tank

see Fuel tank

Technical data

Capacities 533

Notes 530

Trailer loads 543

Tyres/wheels 525

Vehicle data 541

Telephone

Accepting/ending call 200

Accepting a call 403

Accepting or rejecting a waiting call 202

Adjusting the volume for calls 135

Basic menu (Bluetooth® interface) 198

Basic menu (convenience telephony) 215

Calling (outgoing call) 200

Calling voicemail 201

Conference connection 202

Connecting a mobile phone (convenience telephony) 215

Connecting a Mobile phone (general information) 195

Deregistering (de-authorising) a mobile phone 197

Ending an active call 202

Entering a number 200

External authorisation (Bluetooth®) 196

Function restrictions 193

General notes 192

Keypad 120

Menu (on-board computer) 402

Number from the phone book 403

Operating options 193

Overview of functions 201

Reception and transmission volume 199

Redialling 403

Rejecting/ending a call 403

Rejecting a call 200

Safety notes 192

Sending DTMF tones 203

Switching between Bluetooth® and convenience telephony 198

Switching hands-free microphone on/off 201

Telephone compartment 456

Text message (SMS) 204

Toggleing 202

Transferring a call (convenience telephony) 203

Using the telephone 200

see Bluetooth®

see Call list

Telephone mode

Redialling 200

Telephone module with Bluetooth® SIM Access Profil

see Separate installation instructions

Teletext 247

TV (Rear Seat Entertainment System) 270

Television

see TV

Temperature

Coolant 392

Coolant (on-board computer) 400

Engine oil (on-board computer) 400

Outside temperature 393

Setting (climate control) 308

Setting (COMAND) 278

TEMPOMAT

Function/notes 344

Text message

see SMS

Text message (SMS)

Call sender 207

Deleting 207

Reading 205

Reading aloud 205

Storing the sender as a new address book entry 207

Writing 206

Text messages (SMS)

Notes and requirements 204

Theft-deterrent system

ATA (Anti-Theft Alarm system) 76

Immobiliser 75

- Tilt/sliding sunroof**
see Sliding sunroof
- Time**
Setting 144
Setting summer/standard time 144
Setting the format 144
Setting the time 143
Setting the time/date format 144
Setting the time zone 144
- Timing (RACETIMER)** 400
- TIREFIT kit** 494
- TMC (Traffic Message Channel)**
Displaying traffic reports 175
Displays on the map 174
Reading out traffic reports 177
Switching dynamic route guidance on/off 174
- Tone**
see Sound settings
- Top Tether** 63
- Total distance recorder** 396
- Tow-away protection**
Notes 76
Switching on/off (on-board computer) 277
- Towing**
Important safety notes 509
With the rear axle raised 510
- Towing a trailer**
Active Blind Spot Assist 382
Active Lane Keeping Assist 385
Axle load, permissible 545
- Towing away**
Fitting the towing eye 509
Removing the towing eye 510
With both axles on the ground 510
- Tow-starting**
Emergency engine starting 511
Important safety notes 509
- Track**
Selecting (CD, DVD, MP3) 227
- Traffic Announcement (TA)**
Interrupting 222
Notes 222
Switching on/off 222
- Traffic jam function** 170
- Traffic jam icon**
Showing on route 175
- Traffic jam message**
Reading out on route 177
- Traffic jam messages**
see Dynamic route guidance/TMC
- Traffic jams**
Showing in the map 174
- Traffic Message Channel**
see TMC (Traffic Message Channel)
- Traffic messages**
see Dynamic route guidance/TMC
- Traffic Programme (TA)**
Switching off 134
- Traffic reports**
Reading out on route 177
Showing in the map 174
Showing on route 175
- Trailer towing**
7-pin connector 389
Blind Spot Assist 378
Coupling up a trailer 388
Decoupling a trailer 388
Driving tips 385
ESP® 73
Folding in the ball coupling 389
Folding out the ball coupling 387
Important safety notes 385
Lights display message 420
Mounting dimensions 543
Parking Guidance 369
Parktronic 364
Power supply 389
Shift range 332
Trailer loads 543
- Transmission**
see Automatic transmission
- Transporting the vehicle** 511
- Trim pieces (cleaning instructions)** . 488
- Trip computer (on-board computer)** 396
- Trip meter**
Calling up 396
Resetting (on-board computer) 397
- Trip odometer**
see Trip meter

- Turn signals**
Switching on/off 292
- TV**
Automatic picture shutoff 242
Fixing a channel 247
Information about the current programme 246
Operating (on-board computer) 399
Picture settings 242
Programme preview 246
Rear Seat Entertainment System ... 266
Reception quality 242
Selecting a channel (COMAND) 244
Selecting channels (Rear Seat Entertainment System) 267
Setting the reception region 247
Showing/hiding the menu 243
Showing/hiding the navigation menu 243
Storing a channel (COMAND) 245
Storing channels (Rear Seat Entertainment System) 268
Switching on 243
Teletext 247
- Two-way radio**
Frequencies 531
Installation 531
Transmission output (maximum) ... 531
- Type identification plate**
see Vehicle identification plate
- Tyre pressure**
Calling up (on-board computer) 522
Display message 435
Not reached (TIREFIT) 497
Pressure loss warning 521
Reached (TIREFIT) 497
Recommended 520
- Tyre pressure monitor**
Function/notes 522
Restarting 524
Warning lamp 451
- Tyres**
Checking 517
Direction of rotation 525
Display message 435
Grip 343
Important safety notes 516
M+S tyres 518
Replacing 524
Service life 517
Storing 525
Tyre size (data) 525
Tyre tread 517
see Flat tyre
- U**
- Unladen weight** 541
- Unlocking**
Emergency unlocking 88
From inside the vehicle (central unlocking button) 87
- USB**
see Media Interface
- V**
- Vanity mirror (in sun visor)** 462
- Variable SPEEDTRONIC**
see SPEEDTRONIC
- Vehicle**
Correct use 32
Data acquisition 33
Display message 438
Electronics 531
Emergency unlocking 88
Equipment 30
Implied warranty 33
Individual settings 406
Leaving parked up 341
Locking (in an emergency) 88
Locking (key) 80
Lowering 502
Pulling away 325
Raising 500
Registration 32
Towing away 509
Transporting 511
Unlocking (in an emergency) 88
Unlocking (key) 80
Vehicle data 541
- Vehicle battery**
see Battery (vehicle)
- Vehicle data** 541
- Vehicle dimensions** 541
- Vehicle emergency locking** 88

Vehicle identification number	
see VIN	
Vehicle identification plate	532
Vehicle level	
Active Body Control (ABC)	360
AIRMATIC	358
Display message	428
Vehicle level (display message)	427
Vehicle tool kit	493
Vehicle weights	541
Vents	
see Air vents	
Video	
see Video DVD	
Video-AUX	
Setting the picture	242
Video DVD	
Automatic picture shutoff	242
Data carrier	248
DVD menu	251
Fast forward/rewind	250
Function restrictions	249
Interactive content	253
Operation	248
Pause function	251
Playing conditions	248
Rear Seat Entertainment System ...	261
Safety notes	248
Selecting	250
Selecting a film/title	251
Selecting a scene/chapter	251
Setting the audio format	252
Setting the language	252
Setting the picture	242
Showing/hiding the menu	249
Showing/hiding the navigation menu	249
Stop function	250
Subtitles	253
Switching on	249
VIN	532
Voice control	
see LINGUATRONIC	

W

Waiting call	202
Warning and indicator lamps	
ABS	444
Brakes	444
Distance warning signal	450
ESP®	446
ESP® OFF	447
LIM (cruise control)	345
LIM (DISTRONIC PLUS)	350
LIM (variable SPEEDTRONIC)	347
Overview	40
PASSENGER AIRBAG OFF	61
Reserve fuel	450
Seat belt	443
SRS	449
Tyre pressure monitor	451
Warning triangle	492
Washer fluid	
Display message	441
Wheel bolt tightening torque	502
Wheel chock	499
Wheels	
Changing/replacing	524
Changing a wheel	498
Checking	517
Cleaning	485
Fitting a new wheel	501
Important safety notes	516
Removing a wheel	501
Storing	525
Tightening torque	502
Wheel size/tyre size	525
Windowbag	
Display message	419
Operation	53
Windows	
Cleaning	485
see Side windows	
Windscreen	
Demisting	310
Infrared reflective	473
Windscreen washer fluid	
see Windscreen washer system	
Windscreen washer system	481
Notes	540

Windscreen wipers

Problem (malfunction)	301
Replacing the wiper blades	300
Switching on/off	299

Winter operation

Important safety notes	518
Radiator cover	477
Slippery road surfaces	344
Snow chains	519

Winter tyres

Limiting the speed (on-board computer)	407
M+S tyres	518

Wiper blades

Cleaning	486
Important safety notes	300

Wooden trim (cleaning instructions)

488

Workshop

see Qualified specialist workshop

Protection of the environment

Notes

Environmental note

Daimler's declared policy is one of comprehensive environmental protection.

Our objectives are to use the natural resources which form the basis of our existence on this planet sparingly and in a manner which takes the requirements of both nature and humanity into consideration.

You too can help to protect the environment by operating your vehicle in an environmentally-responsible manner.

Fuel consumption and the rate of engine, transmission, brake and tyre wear depend on the following factors:

- operating conditions of your vehicle
- your personal driving style

You can influence both factors. Therefore, please bear the following in mind:

Operating conditions:

- avoid short trips, as these increase fuel consumption.
- observe the correct tyre pressure.
- do not carry any unnecessary weight in the vehicle.
- monitor the vehicle's fuel consumption.
- remove the roof rack once you no longer need it.
- a regularly serviced vehicle will contribute to environmental protection. You should therefore adhere to the service intervals.
- all maintenance work should be carried out at a qualified specialist workshop.

Personal driving style:

- do not depress the accelerator pedal when starting the engine.
- do not warm up the engine when the vehicle is stationary.
- drive carefully and maintain a safe distance from the vehicle in front.
- avoid frequent, sudden acceleration.

- change gear in good time and use each gear only up to $\frac{2}{3}$ of its maximum engine speed.
- switch off the engine in stationary traffic.

Returning an end-of-life vehicle

Mercedes-Benz will take back your Mercedes-Benz to dispose of it in an environmentally responsible manner, in accordance with the European Union (EU) End of Life Vehicles Directive.

The End of Life Vehicles Directive applies to vehicles with a gross vehicle weight of up to 3.5 t, in accordance with national regulations. For several years, Mercedes-Benz has been meeting all the legal requirements for a design which allows for recycling and re-use. There is a network of return points and disassembly plants which can recycle your vehicle in an environmentally-responsible manner. The options for recycling vehicles and parts are constantly being developed and improved. This means that your Mercedes-Benz will also continue to meet even the increased recycling quotas in the future in good time. You can obtain further information from your national Mercedes-Benz homepage or your national hotline number.

Vehicle equipment

This Owner's Manual describes all models and all standard and optional equipment of your vehicle available at the time of publication of the Owner's Manual. Country-specific deviations are possible. Please note that your vehicle may not be equipped with all features described. This is also the case for systems and functions relevant to safety. The equipment in your vehicle may therefore differ from that shown in the descriptions and illustrations.

All the systems found in your vehicle are listed in the original purchase agreement of your vehicle.

Should you have any questions concerning equipment and operation, please consult a Mercedes-Benz Service Centre.

The Owner's Manual and the Service Booklet are important documents and should be kept in the vehicle.

Operating safety

Safety notes

WARNING

All work on the vehicle and, in particular, work relevant to safety or on safety-related systems must be carried out at a qualified specialist workshop. The specialist workshop must have the necessary specialist knowledge and tools to carry out the work required. Mercedes-Benz recommends that you use a Mercedes-Benz Service Centre for this purpose.

WARNING

Some safety systems only function when the engine is running. You should therefore never switch off the engine when driving. Otherwise, the safety systems of your vehicle may not function correctly and as a result will no longer protect you and other persons as intended. In addition, there is a risk that you may lose control of your vehicle and thus cause an accident.

WARNING

Work carried out incorrectly, or alterations made to the vehicle, e.g. re-routing of cables under coverings, could cause the safety systems of your vehicle to stop working properly. The safety systems would thus no longer protect you and other persons as intended. In addition, there is a risk that you may lose control of your vehicle and thus cause an accident.

All work and alterations to the vehicle, e.g. installations or modifications, should there-

fore be carried out at a qualified specialist workshop.

WARNING

If work on electronic equipment and its software is carried out incorrectly, this equipment could stop working. The electronic systems are networked via interfaces. Tampering with these electronic systems could cause malfunctions in systems which have not been modified. Malfunctions such as these can seriously jeopardise the vehicle's operating safety and therefore your own safety.

You should therefore have all work and modifications to electronic components carried out at a qualified specialist workshop.

Declarations of conformity

Vehicle components which receive and/or transmit radio waves

The following information applies to all components of the vehicle and the COMAND system which receive and/or transmit radio waves:

The components of this vehicle which receive and/or transmit radio waves are compliant with the basic requirements and other relevant provisions of Directive 1999/5/EC. You can obtain further information from any Mercedes-Benz Service Centre.

Electromagnetic compatibility

The electromagnetic compatibility of the vehicle components has been tested and certified in accordance with the current version of Directive 72/245/EEC or the equivalent ECE-R 10 regulation.

Diagnostics connection

WARNING

If you connect equipment to the diagnostics connection, it can affect the operation of the

vehicle systems. This can impair the operating safety of your vehicle while driving. There is a risk of accident.

Do not connect any equipment to the diagnostics connection.

WARNING

Loose equipment or equipment cables that are connected to the diagnostics connection can obstruct the area around the pedals. The equipment or the cables could get between the pedals in the event of sudden braking or acceleration. As a result, the movement of the pedals may be impaired. There is a risk of accident.

Do not attach any equipment or cables in the driver footwell.

! If the engine is switched off and equipment on the diagnostics connection is used, the starter battery may discharge.

The diagnostics connection is only intended for the connection of diagnostic equipment at a qualified specialist workshop.

Connecting equipment to the diagnostics connection can, for example, lead to emissions monitoring information being reset. This may lead to the vehicle failing to meet the requirements of the next emissions test during the main inspection.

Qualified specialist workshop

A qualified specialist workshop has the necessary specialist knowledge, tools and qualifications to correctly carry out the work required on your vehicle. This is especially the case for work relevant to safety.

Observe the information in the Service Booklet.

Always have the following work carried out at a qualified specialist workshop:

- work relevant to safety
- service and maintenance work
- repair work

- alterations, installation work and modifications
- work on electronic components

Mercedes-Benz recommends that you use a Mercedes-Benz Service Centre.

Vehicle registration

Mercedes-Benz may ask its Service Centres to carry out technical inspections on certain vehicles to improve their quality or safety.

If you did not purchase your vehicle from an authorised specialist dealer and your vehicle has never been inspected at a Mercedes-Benz Service Centre, it is possible that your vehicle is not registered in your name with Mercedes-Benz. Mercedes-Benz can only inform you about vehicle checks if it has your registration data.

It is advisable to register your vehicle with a Mercedes-Benz Service Centre.

Inform Mercedes-Benz as soon as possible about any change in address or vehicle ownership.

Correct use

WARNING

Various warning stickers are affixed to your vehicle. Their purpose is to draw your attention, and the attention of others, to various dangers. Therefore, do not remove any warning stickers unless the sticker clearly states that you may do so.

If you remove the warning stickers, you or others could be injured by failing to recognise certain dangers.

WARNING

Hybrid vehicles: ensure that you read the "HYBRID" supplement. You could otherwise fail to recognise dangers.

When driving your vehicle observe the following information:

- the safety notes in this manual
- the "Technical data" section in this manual
- traffic rules and regulations
- laws and safety standards pertaining to motor vehicles

Implied warranty

! Follow the instructions in this manual about the proper operation of your vehicle as well as about possible vehicle damage. Damage to your vehicle that arises from culpable contraventions against these instructions are not covered either by Mercedes-Benz implied warranty or by the New or Used-Vehicle Warranty.

Data stored in the vehicle

Fault data

Components critical for vehicle operation are equipped with fault data memories as standard. There are also data storage devices which record the technical reactions of vehicle components to certain driving situations (e.g. airbag deployment or ESP[®] intervention).

This data is used exclusively to:

- assist in the rectification of faults and defects
- help Mercedes-Benz optimise and develop vehicle functions

The data cannot be used to trace the vehicle's movements.

When your vehicle is serviced by Mercedes-Benz, this technical information can be read out from the fault memory. This is performed by authorised employees of the Mercedes-Benz service network using special diagnostic computers.

After a fault has been rectified, the information is deleted from the memory. Other memory data is constantly overwritten.

Other devices that store data

Depending on the equipment level, your vehicle may feature communications and/or entertainment systems (e.g. navigation devices, telephone systems). These allow you to save and edit data required for the operation of the respective device.

Further information on operation (e.g. on deleting data) can be found in the separate operating instructions.

Cockpit	36
Instrument cluster	38
On-board computer and COMAND	41
Centre console	42
Overhead control panel	43
Door control panel	44
Rear seats	46

Cockpit

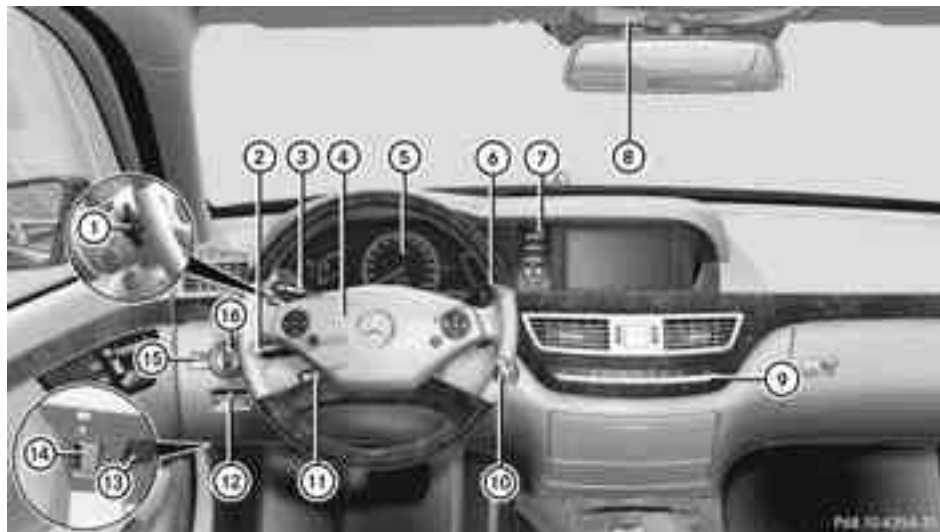

	Function	Page
①	Steering wheel gearshift paddles	333
②	Combination switch	292
③	Cruise control lever	345
④	Horn	
⑤	Instrument cluster	38
⑥	DIRECT SELECT lever	329
⑦	Control panel for:	
	Vehicle level	358
	Suspension tuning	359
	PARKTRONIC	361
	Swivels the COMAND display	124
	COMAND display brightness	124
	Instrument lighting	124

	Function	Page
⑧	Overhead control panel	43
⑨	Automatic climate control	304
⑩	Ignition lock	323
	Start/Stop button	323
⑪	Adjusts the steering wheel	109
	Steering wheel heating	110
⑫	Electric parking brake	340
⑬	Diagnostic socket	31
⑭	Opens the bonnet	476
⑮	Night View Assist Plus	373
⑯	Light switch	290

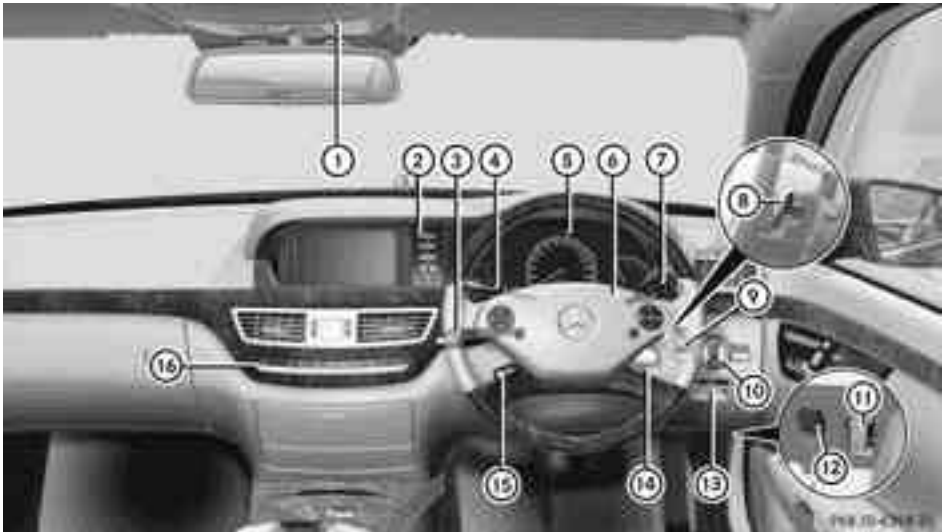

	Function	Page		Function	Page
①	Overhead control panel	43	⑧	Steering wheel gearshift paddles	333
②	Control panel for: Vehicle level	358	⑨	Night View Assist Plus	373
	Suspension tuning	359	⑩	Light switch	290
	PARKTRONIC	361	⑪	Opens the bonnet	476
	Swivels the COMAND display	124	⑫	Diagnostic socket	31
	COMAND display brightness	124	⑬	Electric parking brake	340
	Instrument lighting	124	⑭	Ignition lock Start/Stop button	323 323
③	Combination switch	292	⑮	Adjusts the steering wheel Steering wheel heating	109 110
④	Cruise control lever	345	⑯	Automatic climate control	304
⑤	Instrument cluster	38			
⑥	Horn				
⑦	DIRECT SELECT lever	329			

Instrument cluster

Displays

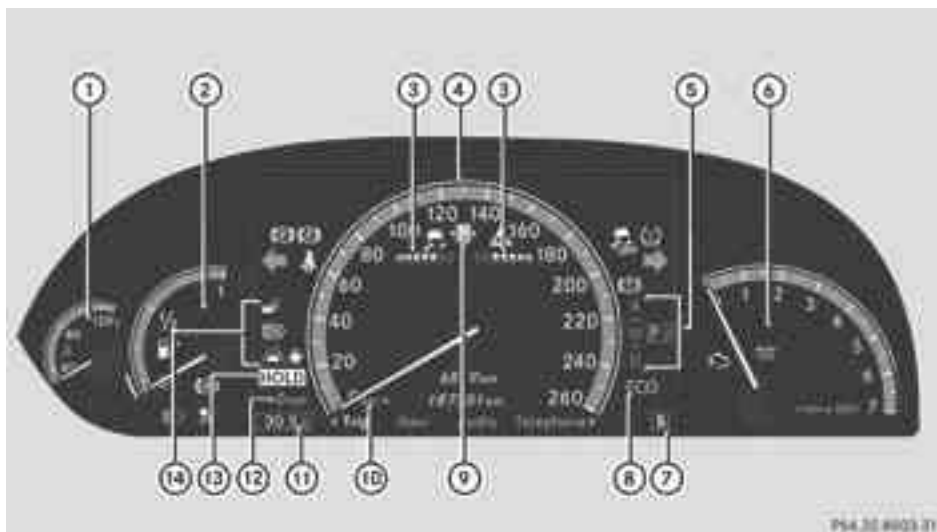

i Instrument cluster: kilometres

	Function	Page
①	Coolant temperature	392
②	Fuel gauge	
③	PARKTRONIC	361
④	Multifunction display Speedometer	394
⑤	Transmission position	331
⑥	Rev counter	392
⑦	Drive program	332
⑧	ECO start/stop function	325
⑨	Parking Guidance	365

	Function	Page
⑩	Unit of measurement for the speedometer	407
⑪	Outside temperature	393
⑫	Additional speedometer	407
⑬	HOLD function PRE-SAFE® Brake	357 74
⑭	Speed Limit Assist Adaptive Highbeam Assist Lane Keeping Assist or Active Lane Keeping Assist ATTENTION ASSIST ¹	371 294 378, 382 370

¹ Not available on hybrid vehicles.

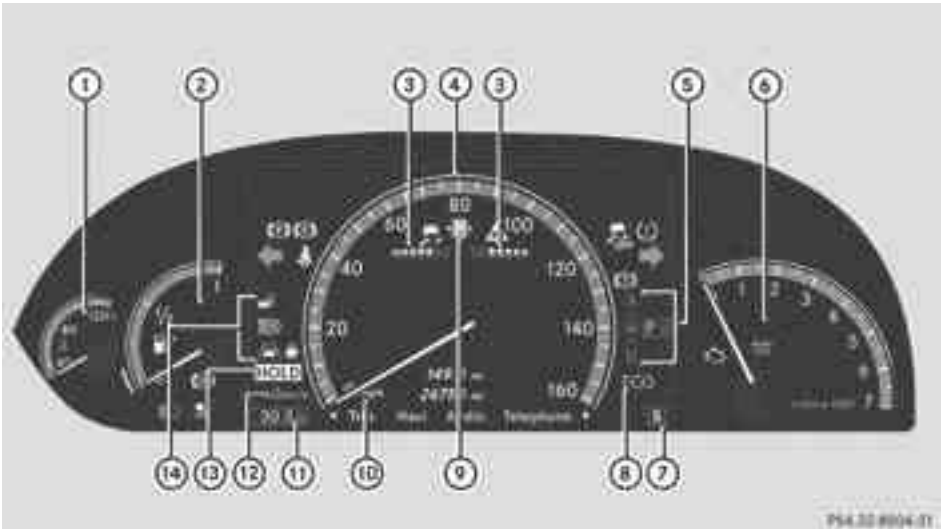

i Instrument cluster: miles

	Function	Page
①	Coolant temperature	392
②	Fuel gauge	
③	PARKTRONIC	361
④	Multifunction display Speedometer	394
⑤	Transmission position	331
⑥	Rev counter	392
⑦	Drive program	
⑧	ECO start/stop function	325
⑨	Parking Guidance	365

	Function	Page
⑩	Unit of measurement for the speedometer	407
⑪	Outside temperature	393
⑫	Additional speedometer	407
⑬	HOLD function PRE-SAFE® Brake	357
⑭	Speed Limit Assist Adaptive Highbeam Assist Lane Keeping Assist or Active Lane Keeping Assist ATTENTION ASSIST ²	371 294 378, 382 370

² Not available on hybrid vehicles.

Warning and indicator lamps

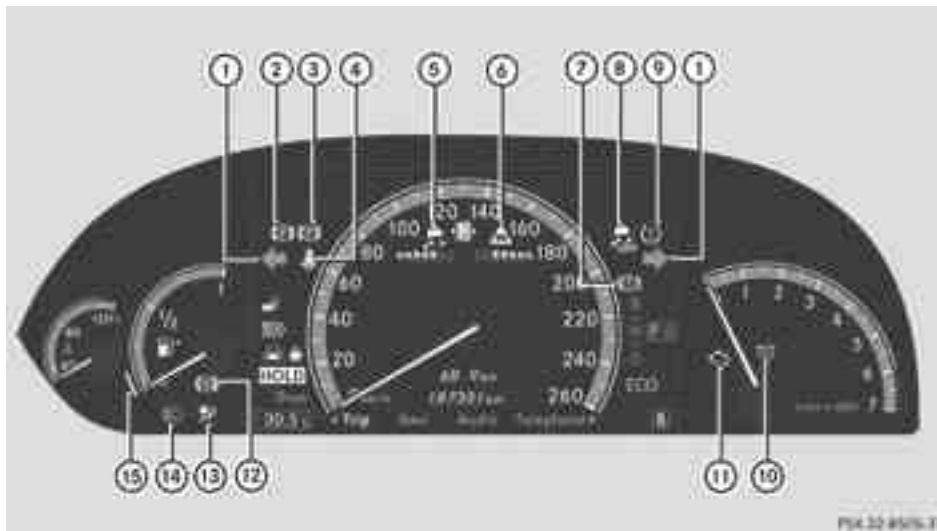

	Function	Page
①	Turn signal	292
②	Electric parking brake (red)	444
③	Electric parking brake (yellow)	444
④	Seat belt	443
⑤	ESP®	446
⑥	Distance warning signal	450
⑦	Brakes	444
⑧	ESP® OFF	446

	Function	Page
⑨	Tyre pressure monitor	451
⑩	Diesel engine: preglow	324
⑪	Engine diagnostics	450
⑫	ABS	444
⑬	SRS	449
⑭	Main-beam headlamps	292
⑮	Reserve fuel	450

On-board computer and COMAND

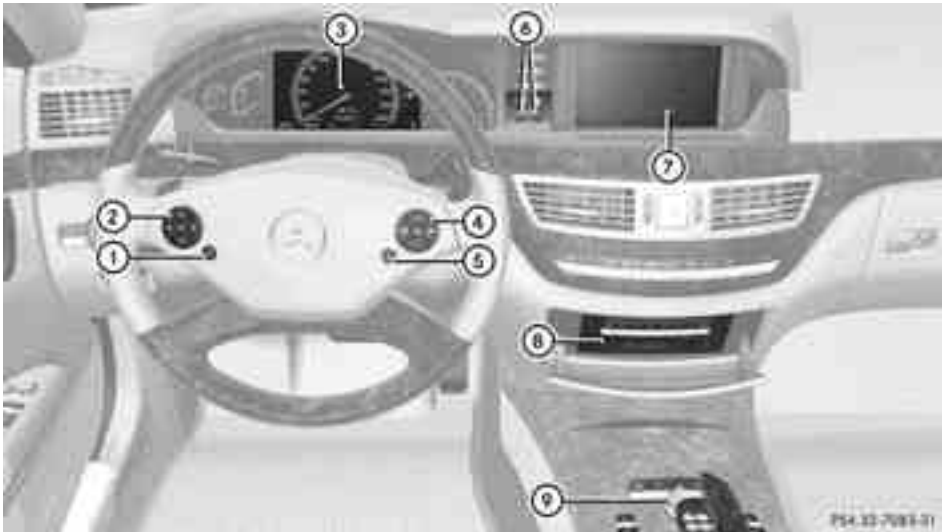

	Function	Page
①	Back Switches off LINGUA-TRONIC; see the separate operating instructions	393
②	Selects a menu	393
	Selects a function or scrolls through lists	393
	OK	393
	Confirms a selection	393
	Hides display messages	409
③	Multifunction display	394
④	Rejects or ends a call	402
	Exits telephone book/redial memory	402
	Makes or accepts a call	
	Switches to the redial memory	

	Function	Page
	Adjusts the volume or operates RACE-TIMER on AMG vehicles	400
	Mute	
⑤	Switches on LINGUA-TRONIC; see the separate operating instructions	
⑥	Swivels the COMAND display	124
	Adjusts the brightness of the instrument lighting and the COMAND display	124
⑦	COMAND display	121
⑧	CD and DVD player/changer	223
⑨	COMAND controller and COMAND function buttons	118, 119

Centre console

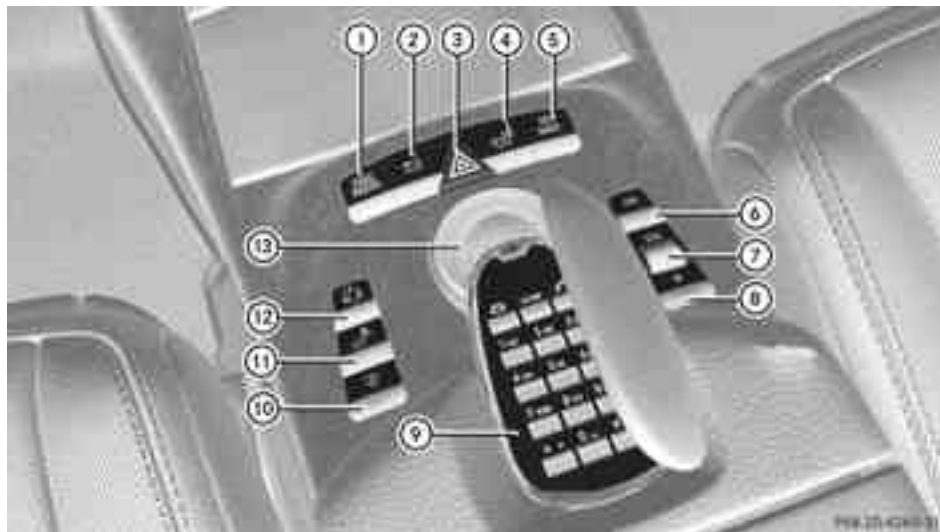









	Function	Page
①	Function button for the radio and CD/DVD/SD card	119
②	Back button	118
③	Hazard warning lamps	293
④	Lumbar support Multicontour seat	283 284
⑤	Function button for the telephone and navigation system	152
⑥	Activates/deactivates COMAND	134

	Function	Page
⑦	Adjusts the volume	135
⑧	Programmable button	119
⑨	Telephone keypad	120
⑩	Rear window roller sunblind	462
⑪	Retracts the rear seat head restraints	107
⑫	Selects the drive program	332
⑬	COMAND controller	118

Overhead control panel











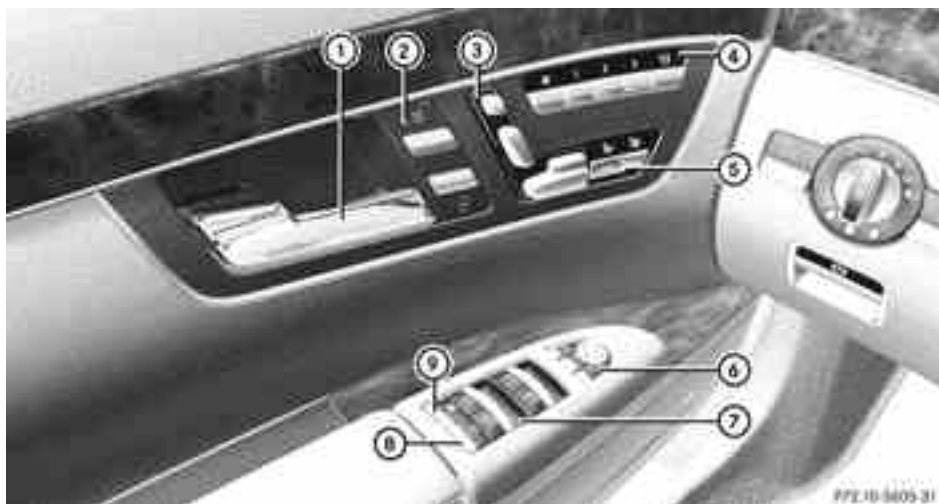





	Function	Page
①	Spectacles compartment	455
②	 Switches the left-hand reading lamp on/off	296
③	 Switches the rear interior lighting on/off	297
④	 Switches the front interior lighting on/off	297
⑤	 Opens/closes the sliding sunroof	95
	 Opens/closes the panorama sliding sunroof with roller sunblinds	96





	Function	Page
⑥	 Switches the automatic interior lighting control on/off	296
⑦	 Extends/retracts the rear roller sunblind of the panorama sliding sunroof	97
⑧	 Switches the right-hand reading lamp on/off	296
⑨	Rear-view mirror	
⑩	Buttons for the garage door opener	467

Door control panel

Front









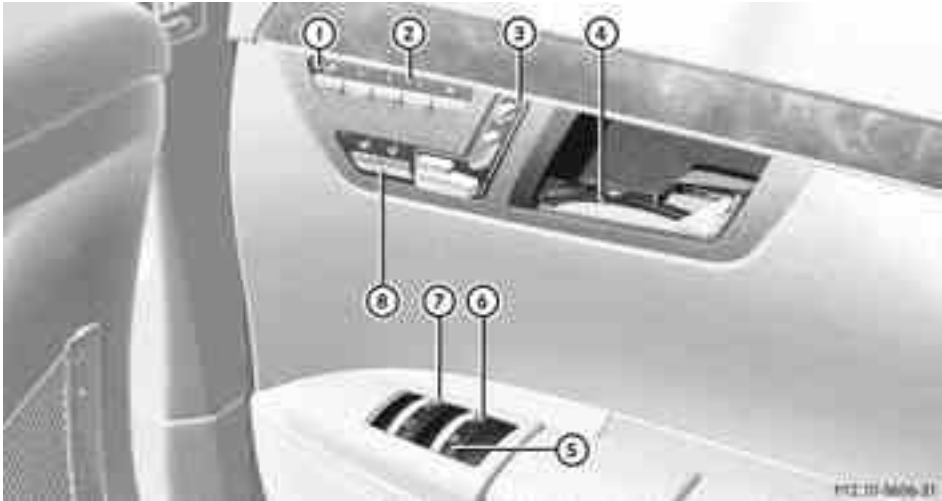

	Function	Page
①	Opens the door	87
②	  Unlocks/locks the vehicle	87
③	Adjusts the seat electrically	104
④	    Memory function	113
	 Adjusts the front-passenger seat from the driver's seat	105
⑤	 Seat heating	108
	 Seat ventilation	109
⑥	    Adjusts and folds the exterior mirrors in/out electrically	111

	Function	Page
⑦	 Opens/closes the side windows	91
	 Opens/closes the roller sunblinds in the rear side windows	
⑧	 Opens the boot lid	90
	 Vehicles with boot lid remote closing feature: opens/closes the boot lid	90
⑨	 Override feature for the controls in the rear compartment	68

Rear



	Function	Page
①	 Adjusts the front-passenger seat from the rear	105
②	 Memory function	113
③	Adjusts the seat electrically	104
④	Opens the door	87
⑤	 Roller sunblind	462
⑥	 Operates the rear roller sunblind of the panorama sliding sunroof from the rear	97

	Function	Page
⑦	 Opens/closes the side windows  Opens/closes the roller sunblinds in the rear side windows	91 92
⑧	 Adjusts seat heating  Adjusts seat ventilation	108 109

Rear seats



	Function	Page
①	DVD player	
②	Cup holder in the rear seat armrest	461
③	Control panel for multicon-tour seat in the rear compartment	107

	Function	Page
④	Stowage compartment in the rear seat armrest	457
⑤	Stowage box in the seat backrest	457
	Cover for skibag	458
	Coolbox	

Useful information	48
Occupant safety	48
Children in the vehicle	59
Panic alarm	69
Driving safety systems	69
Anti-theft systems	75

Useful information

- i** This Owner's Manual describes all models and all standard and optional equipment available to your vehicle at the time of publication of the Owner's Manual. Country-specific deviations are possible. Please note that your vehicle may not be equipped with all features described. This also applies to safety-relevant systems and functions.
- i** Please read the information on qualified specialist workshops (▷ page 32).

Occupant safety

Important safety notes

The seat belts, together with SRS (Supplemental Restraint System), are complementary, co-ordinated restraint systems (▷ page 49). They reduce the risk of injury in specific, pre-defined types of accident situations and thereby increase occupant safety. However, seat belts and airbags generally do not protect against objects penetrating the vehicle from the outside.

To ensure that the restraint systems can deliver their full potential protection, make sure that:

- the seat and head restraint are adjusted properly (▷ page 102).
 - the seat belt has been fastened properly (▷ page 57).
 - the airbags can inflate unrestricted if deployed (▷ page 50).
 - the steering wheel is adjusted properly (▷ page 102).
 - the restraint systems have not been modified.
- i** An airbag increases the protection of vehicle occupants wearing a seat belt. However, airbags are only an additional restraint system which complements, but does not replace, the seat belt. All vehicle

occupants must wear their seat belt correctly at all times, even if the vehicle is equipped with airbags. The airbags are not deployed in all types of accidents. For example, if the protective capacity of correctly fastened seat belts is not increased by deploying the airbags, the airbags will not deploy. Airbag deployment only provides increased protection if the seat belt is worn correctly because:

- the seat belt helps to keep the vehicle occupant in the best position in relation to the airbag.
- in a head-on collision, for example, the seat belt prevents the vehicle occupant from being propelled towards the point of impact. It can thus reduce the risk of injury.

In accidents in which an airbag is deployed, it provides increased protection only if the seat belt is worn correctly.

WARNING

If service work is not carried out correctly, the operating safety of your vehicle may be affected. This could cause you to lose control of your vehicle and cause an accident. Moreover, the safety systems may no longer be able to protect you or others as they are designed to do.

Always have service work carried out at a qualified specialist workshop.

WARNING

Modifications to or work performed incorrectly on the following parts can result in the restraint systems not functioning as intended:

- the restraint system, consisting of seat belts and their anchorage points, belt tensioners, belt force limiters and airbags
- the wiring
- networked electronic systems

Airbags and belt tensioners could fail to deploy or be triggered in an accident despite the deceleration force being sufficient to trigger the systems, or could be triggered unin-

tentionally. For this reason, never make any modifications to the restraint systems.

Therefore, you must not tamper with electronic components or their software.

SRS (Supplemental Restraint System)

Introduction

SRS consists of:

- the  SRS warning lamp
- airbags
- airbag control unit (with crash sensors)
- belt tensioners
- belt force limiters

SRS reduces the risk of occupants coming into contact with the vehicle's interior in the event of an accident. It can also reduce the effect of the forces to which occupants are subjected during an accident.

SRS warning lamp



SRS functions are checked regularly when you switch on the ignition and when the engine is running. Therefore, malfunctions can be detected in good time.

The  SRS warning lamp in the instrument cluster lights up when the ignition is switched on. It goes out no later than a few seconds after the engine is started.

WARNING

If SRS is malfunctioning, individual systems may be triggered unintentionally or might not be triggered in the event of an accident with a high rate of vehicle deceleration.

A malfunction has occurred if:

- the  SRS warning lamp does not light up when the ignition is switched on.
- the engine is running and the  SRS warning lamp does not go out after a few seconds.
- the engine is running and the  SRS warning lamp lights up again.

In this case, have SRS checked immediately at a qualified specialist workshop.

Triggering of belt tensioners, belt force limiters and airbags

During the first stage of a collision, the airbag control unit evaluates important physical data relating to vehicle deceleration or acceleration, such as:

- duration
- direction
- magnitude

Based on the evaluation of this data, the airbag control unit pre-emptively triggers the belt tensioners in the first stage.

- i** The front belt tensioners can only be triggered if the seat belt tongues on the front seats are correctly engaged in the seat belt buckles.

If there is an even higher rate of vehicle deceleration or acceleration in a longitudinal direction, the front airbags are also deployed.

Your vehicle has adaptive, two-stage front airbags. The airbag control unit evaluates vehicle deceleration or acceleration in the event of a collision. In the first deployment stage, the front airbag is filled with enough propellant gas to reduce the risk of injuries. The front airbag is fully deployed if a second deployment threshold is exceeded within a few milliseconds.

The belt tensioner and airbag triggering thresholds are variable and are adapted to the rate of deceleration or acceleration of the vehicle. This process is pre-emptive in nature. The triggering process must take place in good time at the start of the collision.

- i** Airbags are not deployed in all types of accidents. Also, not all airbags are deployed together in an accident. The different airbag systems work independently of each other.

How the airbag system works is determined by the severity of the collision detected, especially the vehicle deceleration or acceleration, and the apparent type of accident:

- head-on collision
- side impact
- overturn

The rate of vehicle deceleration or acceleration and the direction of the force are essentially determined by:

- the distribution of forces during the collision
- the collision angle
- the deformation characteristics of the vehicle
- the characteristics of the object with which the vehicle has collided

Factors which can only be seen and measured after a collision has occurred do not play a decisive role in the deployment of an airbag, nor do they provide an indication of airbag deployment.

The vehicle may be deformed significantly, e.g. the bonnet or the wing, without an airbag being deployed. This is the case if only parts which are relatively easily deformed are affected and the rate of deceleration is not high. Conversely, airbags may be deployed even though the vehicle suffers only minor deformation. This is the case if, for example, very rigid vehicle parts such as longitudinal body members are hit, and sufficient deceleration occurs as a result.

Airbags

Important safety notes

Airbag deployment slows down and restricts the movement of the vehicle occupant.

If the airbags are deployed, you will hear a bang and a small amount of powder may also be released. Only in rare cases will the bang affect your hearing. The powder that is

released generally does not constitute a health hazard. The  SRS warning lamp lights up.

The airbag installation locations are identified by the AIRBAG symbol.

WARNING

Airbags provide additional protection; they are not, however, a substitute for seat belts.

Observe the following notes to reduce the risk of serious or even fatal injury caused by airbag deployment:

- all vehicle occupants – in particular, pregnant women – must wear their seat belt correctly at all times and lean back against the backrest, which should be positioned as close to the vertical as possible. The head restraint must support the back of the head at about eye level.
- always secure children less than 1.50 m tall or under 12 years of age in suitable child restraint systems.
- all vehicle occupants must select a seat position that is as far away from the airbag as possible. The driver's seat position must allow the vehicle to be driven safely. The driver's chest should be as far away from the centre of the driver's airbag cover as possible.
- move the front-passenger seat as far back as possible. This is especially important if you have secured a child in a child restraint system on the front-passenger seat.
- vehicle occupants – in particular, children – must not lean their heads into the area of the window in which the sidebag/window-bag is deployed.
- rearward-facing child restraint systems must not be fitted to the front-passenger seat unless the front-passenger airbag has been disabled. On the front-passenger seat, the front-passenger airbag is disabled if a child restraint system with a transponder for automatic child seat recognition is fitted to the front-passenger seat in a vehicle equipped with automatic child seat

recognition. The  PASSENGER AIRBAG OFF indicator lamp must be continuously lit.

If the front-passenger seat of your vehicle does not have automatic child seat recognition, or your rearward-facing child restraint system does not have automatic child seat recognition, children must be secured in a child restraint system on a suitable seat in the rear. If you secure a forward-facing child restraint system to the front-passenger seat, you must move the front-passenger seat as far back as possible.

- make sure there are no heavy or sharp-edged objects in the pockets of clothing.
- do not lean forwards, e.g. over the cover of the driver's/front-passenger front airbag, particularly when the vehicle is in motion.
- do not put your feet on the dashboard.
- only hold the steering wheel on the outside. This allows the airbag to be fully deployed. You could be injured if the airbag is deployed and you are holding the inside of the steering wheel.
- do not lean on the doors from inside the vehicle.
- make sure that there are no people, animals or objects between the vehicle occupants and the area where the airbags are deployed.
- do not place any objects between the seat backrest and the door.
- do not hang any hard objects, for example, coat hangers, on the grab handles or coat hooks.
- do not attach accessories, e.g. cup holders, to the doors.

It is not possible to rule out a risk of injury being caused by an airbag, due to the high speed at which the airbag must be deployed.

WARNING

Airbag functionality can only be assured if the following parts are not covered and no badges or stickers are attached to them:

- padded steering wheel boss
- kneebag cover below the steering column
- front-passenger airbag cover
- outer side of front seat bolsters
- side trim next to the rear seat backrest
- roof frame cover between the front A-pillar and the C-pillar in the rear compartment

WARNING

When an airbag deploys, a small amount of powder is released. The powder may cause short-term breathing difficulties to persons suffering from asthma or other pulmonary conditions.

In order to prevent potential breathing difficulties, you should leave the vehicle as soon as it is safe to do so. You can also open the window to allow fresh air to enter the vehicle interior. The powder does not constitute a health hazard and does not indicate that there is a fire in the vehicle.

WARNING

The airbag parts are hot after the airbag has been deployed. Do not touch them as you could burn yourself.

Have the airbags replaced at a qualified specialist workshop. Otherwise, occupants are not protected by the airbags in the event of another accident.

Front airbags

The front airbags increase protection for the driver's and front-passenger's head and chest.



Driver's airbag ① deploys in front of the steering wheel; front-passenger front airbag ② deploys in front of and above the glove compartment.

They are deployed:

- at the start of an accident with a high rate of vehicle acceleration or deceleration in a longitudinal direction
- if the system determines that airbag deployment can offer additional protection to that provided by the seat belt
- if the seat belt is fastened
- independently of other airbags in the vehicle

If the vehicle overturns, the front airbags are generally not deployed. The front airbags are deployed if the system detects high vehicle deceleration in a longitudinal direction.

Front-passenger airbag ② is only activated if the system determines that the front-passenger seat is occupied. The  PASSENGER AIRBAG OFF indicator lamp on the centre console is not lit (▷ page 61). This means that a child restraint system without automatic child seat recognition has been fitted to the front-passenger seat, or that a child restraint system with automatic child seat recognition has been fitted incorrectly.

! Do not place heavy objects on the front-passenger seat. The system may then detect that the seat is occupied and if there is an accident, the restraint systems on the front-passenger side could be deployed.

Have restraint systems that have been triggered replaced.

Driver's kneebag

i The driver's kneebag is only available in certain countries.

The driver's kneebag increases protection of the driver against:

- knee injuries
- thigh injuries
- lower leg injuries



Driver's kneebag ① is always deployed along with the driver's airbag and inflates underneath the steering column.

Sidebags

WARNING

If you wish to use seat covers, Mercedes-Benz recommends that, for safety reasons, you only use seat covers that have been approved for Mercedes-Benz vehicles.

The seat covers must have a special tear seam for sidebags. Otherwise, the sidebags cannot deploy correctly and would fail to provide the intended protection in the event of an accident. Appropriate seat covers can be obtained, for example, from a Mercedes-Benz Service Centre.

WARNING

Sensors to control the airbags are located in the doors. Therefore, do not make any modifications to the doors or door trim, e.g. retro-

fitting loudspeakers. Damage to the doors can affect operation of the sidebags.

When deployed, the sidebags offer additional protection for the thorax of the vehicle occupants on the side of the vehicle on which the impact occurs. However, they do not protect the:

- head
- neck
- arms

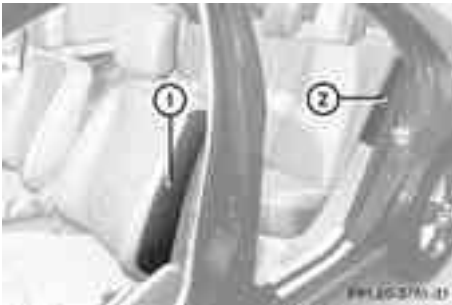

Front sidebags ① and rear sidebags ② deploy next to the outer seat cushions.

The sidebags are deployed:

- on the side on which an impact occurs
- at the start of an accident with a high rate of lateral vehicle deceleration or acceleration, e.g. in a side impact
- independently of the use of the seat belt
- independently of the front airbags
- independently of the belt tensioners

If the vehicle overturns, the sidebags are generally not deployed. Exception: if the system detects high vehicle deceleration or acceleration in a lateral direction and determines that deployment can offer additional protection to that provided by the seat belt.

Windowbags

The windowbags enhance the level of protection for the head, but not chest or arms, of the vehicle occupants on the side of the vehicle on which the impact occurs.

The windowbags are integrated into the side of the roof frame and deploy in the area from the A-pillar to the C-pillar.

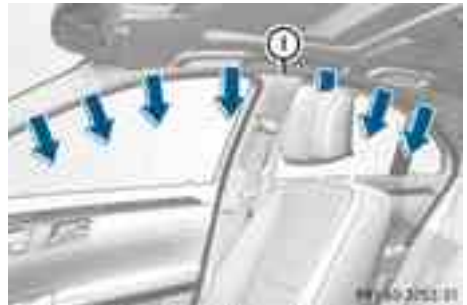

Windowbags ① are deployed:

- on the side on which an impact occurs
- at the start of an accident with a high rate of lateral vehicle deceleration or acceleration, e.g. in a side impact
- regardless of whether the front-passenger seat is occupied
- independently of seat belt use
- if the vehicle overturns, and the system determines that it can provide the vehicle occupants additional protection to that provided by the seat belt
- independently of the front airbags

PRE-SAFE® (preventative occupant protection)

PRE-SAFE® takes pre-emptive measures to protect occupants in certain hazardous situations.

PRE-SAFE® intervenes:

- when BAS PLUS intervenes powerfully on vehicles with DISTRONIC PLUS
- if, on vehicles with DISTRONIC PLUS, the radar sensor system detects an imminent danger of collision in certain situations
- in critical driving situations, e.g. when physical limits are exceeded and the vehicle understeers or oversteers severely

PRE-SAFE® takes the following measures depending on the hazardous situation detected:

- the front seat belts are pre-tensioned.
- the front-passenger seat or the electrically adjustable outer seats in the rear are adjusted if they are in an unfavourable position.
- vehicles with a multicontour seat or active multicontour seat: the air pressure in the side bolsters of the seat cushion and backrest is increased.
- vehicles with multicontour seats in the rear: the air pressure in the backrest side bolsters of the outer seats in the rear is increased.
- if the vehicle skids, the sliding sunroof/panorama sliding sunroof and the side windows are closed so that only a small gap remains.

If the hazardous situation passes without resulting in an accident, PRE-SAFE® slackens the belt pretensioning. The air pressure in the side bolsters on the multicontour seat/active multicontour seat is reduced again. All settings made by PRE-SAFE® can then be reversed.

If the seat belts are not released:

- ▶ Move the backrest back slightly, but only when the vehicle is stationary. The belt pretensioning is reduced and the locking mechanism is released.

WARNING

When adjusting the seat, make sure that nobody can become trapped.

- ❗ Make sure that there are no objects in the footwell or behind the seats when moving the seat back. There is a risk that the seats and/or the objects could be damaged.

More information about seat-belt adjustment, a convenience function integrated into PRE-SAFE®, can be found in the "Seat-belt adjustment" section (▷ page 57).

NECK-PRO head restraints/NECK-PRO luxury head restraints

NECK-PRO head restraints/NECK-PRO luxury head restraints increase protection of the driver's and front-passenger's head and neck. In the event of a rear collision of a certain severity, the NECK-PRO head restraints/NECK-PRO luxury head restraints on the driver's and front-passenger seats are moved forwards and upwards. This provides better head support.

WARNING

Only use head restraint covers which have been tested and approved by Mercedes-Benz for your vehicle model.

The use of non-approved head restraint covers may prevent NECK-PRO head restraints/NECK-PRO luxury head restraints from triggering properly. The NECK-PRO head restraints/NECK-PRO luxury head restraints can therefore not provide the intended protection.

Consult a Mercedes-Benz Service Centre regarding availability.

If the NECK-PRO head restraints/NECK-PRO luxury head restraints have been triggered in an accident, reset the NECK-PRO head restraints/NECK-PRO luxury head restraints on the driver's and front-passenger seats (▷ page 54). Otherwise, the additional protection will not be available in the event of another rear-end collision. NECK-PRO head restraints/NECK-PRO luxury head restraints that have been triggered are moved forwards and can no longer be adjusted.

Resetting triggered NECK-PRO head restraints

Important safety notes

Mercedes-Benz recommends that you have NECK-PRO head restraints/NECK-PRO luxury head restraints checked at a qualified specialist workshop, e.g. a Mercedes-Benz

Service Centre, if your vehicle is involved in a rear-end collision.

NECK-PRO head restraints

- i** Resetting the NECK-PRO head restraints requires a lot of strength. If you have difficulty resetting the NECK-PRO head restraints, have this work carried out at a qualified specialist workshop, e.g. a Mercedes-Benz Service Centre.

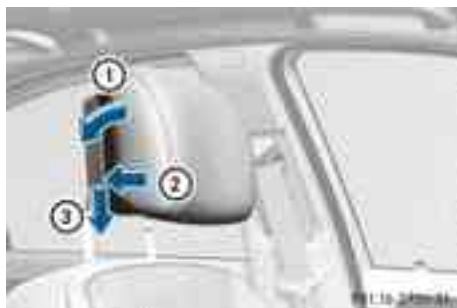

- ▶ Press the base of the NECK-PRO head restraint cushion back in the direction of arrow ② as far as it will go.
- ▶ Push the NECK-PRO head restraint cushion down into the guide in the direction of arrow ③ as far as it will go.
- ▶ Firmly fold the NECK-PRO head restraint cushion back in the direction of arrow ① until it engages.
- ▶ Repeat this procedure for the second NECK-PRO head restraint.

NECK-PRO luxury head restraints

- i** If you have difficulty resetting the NECK-PRO luxury head restraints, have this work carried out at a qualified specialist workshop, e.g. a Mercedes-Benz Service Centre.



- ▶ Remove resetting tool ① from the vehicle tool kit in the boot.
- ▶ Slide resetting tool ① into guide ② between the NECK-PRO luxury head restraint and the rear cover of the head restraint.
- ▶ Push resetting tool ① downwards until you hear the head restraint deployment mechanism engage.
- ▶ Pull out resetting tool ①.
- ▶ Firmly press the NECK-PRO luxury head restraint cushion back ③ until it engages.
- ▶ Repeat this procedure for the second NECK-PRO luxury head restraint.
- ▶ Put resetting tool ① back into the vehicle tool kit.

Seat belts

Important safety notes

Seat belts are the most effective means of restraining the movement of vehicle occupants in the event of an accident. This reduces the risk of vehicle occupants coming into contact with parts of the vehicle interior.

WARNING

A seat belt which is not worn correctly, or which has not been engaged in the seat belt buckle correctly, cannot provide the intended level of protection. Under certain circumstances, this could cause severe or even fatal injuries in the event of an accident.

Therefore, make sure that all occupants – in particular, pregnant women – wear their seat belts correctly at all times.

- The seat belt must fit snugly on your body and must not be twisted. Therefore, avoid wearing bulky clothing, e.g. a winter coat. The shoulder section of the belt must be routed across the centre of your shoulder – on no account across your neck or under your arm – and pulled tight against your upper body. The lap belt must always pass across your lap as low down as possible, i.e. over your hip joints – not across your abdomen. If necessary, push the seat belt slightly downwards and adjust it by pulling it in the direction the seat belt retracts.
- Do not route the seat belt strap over sharp or fragile objects. Please make sure that such objects are not on or in your clothing, e.g. spectacles, pens or keys etc. The seat belt strap could become damaged and tear during an accident and you or other vehicle occupants could be injured.
- Only one person should use each seat belt at any one time. Children must never travel sitting on the lap of another occupant. The child will not be secured in the event of an accident, heavy braking or sudden change of direction. This may result in the child or other occupants being seriously or fatally injured.
- Persons under 1.50 m tall cannot wear the seat belts correctly. For this reason secure persons less than 1.50 m tall in specially designed, suitable restraint systems.
- Children under 1.50 m tall and younger than twelve years of age cannot wear the seat belts correctly. For this reason secure them in special suitable child restraint systems installed on a suitable seat. Additional information can be found in the Operating Instructions in the chapter "Safety", "Children in the Vehicle". Observe the installa-

tion instructions of the child restraint system manufacturer.

- Do not secure an object with a seat belt if the seat belt is also being used by one of the vehicle's occupants.

WARNING

The seat belt does not offer the intended level of protection unless the backrest is almost vertical. Under certain circumstances, this could cause severe or even fatal injuries in the event of an accident.

Before starting a journey, make sure that the seat is properly adjusted and that the backrest is almost vertical.

WARNING

A dirty or damaged seat belt or one that has been modified or subjected to a load in an accident no longer offers the intended level of protection. Under certain circumstances, this could cause severe or even fatal injuries in the event of an accident.

For this reason, check regularly that the seat belts are not damaged or dirty.

Always have damaged seat belts or seat belts that have been subjected to a load in an accident replaced at a qualified specialist workshop.

For safety reasons, Mercedes-Benz recommends that you only use seat belts which have been approved by Mercedes-Benz for your vehicle.

Fastening seat belts



- ▶ Adjust the seat and move the backrest to an almost vertical position (▷ page 102).
- ▶ Pull the seat belt smoothly through belt sash guide ①.
- ▶ Without twisting it, guide the shoulder section of the seat belt across the middle of your shoulder and the lap section across your hips.
- ▶ Engage belt tongue ② in buckle ③. Seat-belt adjustment: if necessary, the driver's and front-passenger seat belts automatically adjust to the upper body (▷ page 57).
- ▶ If necessary, adjust the seat belt to the appropriate height (▷ page 57).
- ▶ If necessary, pull upwards on the shoulder section of the seat belt to tighten the belt across your body.

For more information about releasing the seat belt with release button ④, see "Releasing seat belts" (▷ page 58).

Seat belt adjustment

The seat-belt adjustment function adjusts the driver's and front-passenger seat belt to the upper body of the occupants.

The belt strap is tightened slightly when:

- you engage the belt tongue in the belt buckle and you then turn the key to position **2** in the ignition lock.
- the key is in position **2** in the ignition lock and you then engage the belt tongue in the buckle.

The seat-belt adjustment will apply a certain tightening force if any slack is detected between the occupant and the seat belt. Do not hold on to the seat belt tightly while it is adjusting. You can switch the seat-belt adjustment on and off in the on-board computer (▷ page 408).

The seat-belt adjustment is an integral part of the PRE-SAFE® convenience function. More information about PRE-SAFE® can be found in the "PRE-SAFE® (preventative occupant protection)" section (▷ page 53).

Belt height adjustment

You can adjust the seat belt height on the driver's seat and the front-passenger seat.



Adjust the height so that the upper part of the seat belt is routed across the centre of your shoulder.

- ▶ **To raise:** slide the belt sash guide upwards. The belt sash guide engages in various positions.
- ▶ **To lower:** press and hold belt sash guide release ①.
- ▶ Slide the belt sash guide downwards.
- ▶ Release belt sash guide release ① and make sure that the belt sash guide has engaged.

Releasing the seat belts

- ▶ Press release button ④ (> page 57) and guide belt tongue ② back towards belt sash guide ①.
- !** Make sure that the seat belt is fully rolled up. Otherwise, the seat belt or belt tongue will be trapped in the door or in the seat mechanism. This could damage the door, the door trim panel and the seat belt. Damaged seat belts can no longer fulfil their protective function and must be replaced. Visit a qualified specialist workshop.

Belt warning for the driver and front passenger

The  seat belt warning lamp in the instrument cluster is a reminder for all occupants to fasten their seat belts. It may light up continuously or flash. In addition, there may be a warning tone.

The  seat belt warning lamp goes out and the warning tone ceases when the driver and the front passenger have fastened their seat belt.

For certain countries only: regardless of whether the driver and the front passenger have fastened their seat belts, the  seat belt warning lamp lights up for six seconds after the engine is started. It then goes out if the driver and the front passenger have fastened their seat belts.

- i** For more information on the  seat belt warning lamp, see "Warning and indi-

cator lamps in the instrument cluster, seat belt" (> page 443).

Rear seat belt status indicator

The rear-compartment seat belt status indicator tells you if the rear passengers have their seat belts fastened.

The rear-compartment seat belt status indicator indicates the rear seat on which the belt is fastened.

The rear-compartment seat belt status indicator appears in the multifunction display for around 30 seconds if:

- you drive off and reach a speed of approximately 10 km/h.
- the rear passengers fasten or unfasten their seat belts while the vehicle is in motion.
- someone gets in or out of the vehicle and the vehicle drives off again.



Example: the passengers on the left and right rear seats have their seat belts fastened

You can also cancel the rear seat belt status indicator immediately (> page 409).

- i** The status indicator for the rear-compartment seat belts is only available for certain countries.

Belt tensioners, belt force limiters

The front seat belts and the outer seat belts in the rear are equipped with belt tensioners. The belt tensioners tighten the seat belts in an accident, pulling them close against the body.

Belt tensioners do not correct incorrect seat positions or incorrectly fastened seat belts.

Belt tensioners do not pull vehicle occupants back towards the backrest.

If the seat belt is also fitted with a belt force limiter and this is triggered, the force exerted by the seat belt on the vehicle occupant is reduced.

The belt force limiters on the front seats are synchronised with the front airbags. They take on a part of the deceleration force, resulting in the force exerted on the occupant being distributed over a greater area.

The belt tensioners can only be activated when:

- the ignition is switched on.
- the restraint systems are operational; see "SRS warning lamp" (▷ page 49).
- the belt tongue is engaged in the buckle on each of the three-point seat belts in the front.

The belt tensioners on the outside seats in the rear compartment are triggered independently of the lock status of the seat belts.

The belt tensioners are triggered depending on the type and severity of an accident:

- if, in the event of a head-on or rear-end collision, the vehicle decelerates or accelerates rapidly in a longitudinal direction during the initial stages of the impact
- if, in the event of a side impact, on the side opposite the impact the vehicle decelerates or accelerates rapidly in a lateral direction
- if in certain situations where the vehicle overturns and the system determines that it can provide additional protection

If the airbags are deployed, you will hear a bang, and a small amount of powder may also be released. Only in rare cases will the bang affect your hearing. The powder that is released generally does not constitute a health hazard. The  SRS warning lamp lights up.

WARNING

If the seat belt tensioners have been triggered, they provide no additional protection in the event of another accident. Therefore, have belt tensioners which have been triggered replaced at a qualified specialist workshop.

Comply with safety regulations when disposing of belt tensioners. Any Mercedes-Benz Service Centre can provide details of these regulations.

- !** If the front-passenger seat is not occupied, do not engage the seat belt tongue in the buckle on the front-passenger seat. Otherwise, the belt tensioner could be triggered in the event of an accident.

Automatic comfort-fit feature

The front seat belts have an automatic comfort-fit feature. In vehicles with a rear bench seat with electrically adjustable outer seats, the seat belts for the outer seats have an automatic comfort-fit feature. The automatic comfort-fit feature reduces the retraction force of the seat belts. This results in increased seat belt comfort.

Children in the vehicle

Child restraint systems

Important safety notes

WARNING

To reduce the risk of serious or even fatal injury to the child in the event of a sudden change in direction, braking or an accident:

- children less than 1.50 m tall and under twelve years of age must always be secured in special child restraint systems on a suitable vehicle seat. This is necessary because the seat belts are not designed for children.
- do not secure children less than 1.50 m tall and under twelve years of age on the front-

passenger seat. Exception: if the vehicle is equipped with automatic child seat recognition on the front-passenger seat and the child is secured in a child restraint system with transponders for automatic child seat recognition

- if you secure a forward-facing child restraint system to the front-passenger seat, you must move the front-passenger seat as far back as possible.
- children must never travel sitting on the lap of another occupant. Due to the forces which occur in the event of a sudden change of direction, heavy braking or an accident, it would not be possible to restrain the child. The child could be thrown against parts of the vehicle interior and be seriously or even fatally injured.

WARNING

The child restraint system cannot perform its protective function if it is not correctly fitted to a suitable vehicle seat. The child cannot be restrained in the event of an accident, heavy braking or sudden changes of direction. The child could be seriously or even fatally injured. For this reason, when fitting a child restraint system, observe the manufacturer's installation instructions and the correct use of the child restraint system.

Child restraint systems should be fitted to the rear seats. Children are generally better protected there.

The entire base of the child restraint system must always rest on the seat cushion. Therefore, never place objects, e.g. a cushion, under the child restraint system.

Only use child restraint systems with the original cover designed for them. Only replace damaged covers with genuine Mercedes-Benz covers.

We recommend the use of child restraint systems which have been approved for Mercedes-Benz vehicles.

If a child is travelling in your vehicle, secure the child using a child restraint system which is appropriate to the size, age and weight of the child and recommended for Mercedes-Benz vehicles. You should preferably fit the restraint system to a suitable rear seat. Make sure that the child is secured in a child restraint system throughout the trip.

Mercedes-Benz recommends that you only use the child restraint systems listed at (▷ page 66).

You can obtain further information about the correct child restraint system from any Mercedes-Benz Service Centre.

- i** It is advisable to use Mercedes-Benz care products to clean child restraint systems. You can obtain information about this at any Mercedes-Benz Service Centre.

WARNING

Do not leave children unsupervised in the vehicle, even if they are secured in a child restraint system. They could injure themselves on parts of the vehicle. They could also be seriously or even fatally injured by prolonged exposure to extreme heat or cold.

Do not expose the child restraint system to direct sunlight. Parts of the child restraint system could heat up and the child could burn herself/himself on them.

If a child opens a door, the child or other persons could be injured as a result. They could get out and injure themselves or be injured by a passing vehicle.

Also observe the notes on HOLD. Relevant information can be found in the index.

WARNING

Unsecured or incorrectly positioned loads increase the risk of injury for children and all other occupants in the event of:

- an accident
- a braking manoeuvre
- a sudden change of direction

Do not carry heavy or hard objects in the vehicle interior unless they are secured. You will find further information under "Loading guidelines" in the index.

Child seat on the front-passenger seat



Warning notice on the front-passenger sun visor



Warning symbol for a rearward-facing child restraint system

WARNING

If the front-passenger airbag is not disabled:

- a child secured in a child restraint system on the front-passenger seat could be seriously and even fatally injured by the front-passenger airbag deploying. This is especially a risk if the child is in the immediate vicinity of the front-passenger airbag when it deploys.
- never secure a child on the front-passenger seat in a rearward-facing child restraint system. Only secure a rearward-facing child restraint system on a suitable rear seat.
- always move the front-passenger seat to the rearmost position if you secure a child

in a forward-facing child restraint system on the front-passenger seat.

The front-passenger airbag is not disabled:

- on vehicles without automatic child seat recognition on the front-passenger seat
- in vehicles with automatic child seat recognition in the front-passenger seat, if no special child restraint system with transponders for automatic child seat recognition in the front-passenger seat has been fitted
- on vehicles with automatic child seat recognition on the front-passenger seat, if the PASSENGER AIRBAG OFF indicator lamp  is not lit.

To make you aware of this danger, a corresponding warning sticker has been affixed on the dashboard and on both sides of the sun visor on the front-passenger side.

Information about recommended child restraint systems is available at any Mercedes-Benz Service Centre.



Do not use a rearward-facing child restraint system for a child on a seat which is already protected by an airbag.

Automatic child seat recognition on the front-passenger seat



If your vehicle does not have automatic child seat recognition³ on the front-passenger seat, this is indicated by a special sticker. The sticker is affixed to the side of the dashboard on the front-passenger side. The sticker is visible when you open the front-passenger door.



The front-passenger seat sensor system for child restraint systems detects whether a special Mercedes-Benz child seat with a transponder for automatic child seat recognition has been fitted. In this case, the  PASSENGER AIRBAG OFF indicator lamp  lights up. The front-passenger front airbag is disabled.

WARNING

If the  PASSENGER AIRBAG OFF indicator lamp does not light up when the child restraint system is fitted, the front-passenger airbag has not been disabled. If the front-passenger airbag deploys, the child could be seriously or even fatally injured.

Proceed as follows:

- do not use a rearward-facing child restraint system on the front-passenger seat.
- fit a rearward-facing child restraint system on a suitable rear seat.

or

- only use a forward-facing child restraint system on the front-passenger seat and

move the front-passenger seat to the rear-most position.

- have the automatic child seat recognition checked at a qualified specialist workshop.

To ensure that the automatic child seat recognition on the front-passenger seat functions/communicates correctly, never place objects, e.g. a cushion, under the child restraint system. The entire base of the child restraint system must always rest on the seat cushion. An incorrectly fitted child restraint system cannot perform its intended protective function in the event of an accident, and could lead to injuries.



 If the front-passenger front airbag is disabled by the automatic child seat recognition, the following remain enabled on the front-passenger side:

- the sidebag
- the windowbag
- the belt tensioner

WARNING

Do not place electronic devices on the front-passenger seat, e.g.:

- laptops, when switched on
- mobile phones
- cards with transponders, e.g. ski passes or access cards

Signals from electronic equipment can cause interference in the automatic child seat recognition sensor system. This can lead to a system malfunction. This may cause the  PASSENGER AIRBAG OFF indicator lamp to light up without there being a child seat with transponders for automatic child seat recognition fitted. The front-passenger airbag will not then deploy during an accident. It is also possible that the  SRS warning lamp lights up and/or the  PASSENGER AIRBAG OFF indicator lamp does not light up

³ Vehicles without automatic child seat recognition on the front-passenger seat: if you turn the key to position 2 in the ignition lock, the  PASSENGER AIRBAG OFF indicator lamp lights up briefly but has no function. It does not indicate that there is automatic child seat recognition on the front-passenger seat.

briefly when you turn the key in the ignition lock to position 2.

ISOFIX child seat securing system for the rear seats

ISOFIX is a standardised securing system for specially designed child restraint systems on the rear seats. Securing rings for two ISOFIX child restraint systems are fitted on the left and right of the rear seats.

WARNING

A child restraint system secured by the ISOFIX child seat securing system does not provide sufficient protection for children weighing more than 22 kg. For this reason, do not secure children weighing more than 22 kg in a child restraint system secured by the ISOFIX child seat securing system. If the child weighs more than 22 kg, secure the child restraint system using a three-point seat belt.

WARNING

The child restraint system cannot perform its protective function if it is not correctly fitted to a suitable vehicle seat. The child cannot be restrained in the event of an accident, heavy braking or sudden changes of direction. The child could be seriously or even fatally injured. For this reason, when fitting a child restraint system, observe the manufacturer's installation instructions and the correct use of the child restraint system.

For reasons of safety, only use child restraint systems with the ISOFIX child seat securing system on the rear seats.

We recommend that you use the ISOFIX child restraint systems that have been recommended for Mercedes-Benz.

An incorrectly fitted child restraint system could come loose and seriously or even fatally injure the child or other vehicle occupants.

When fitting the child restraint system, always make sure that it is engaged correctly in the securing rings on both sides.

WARNING

Please note that if child restraint systems, or their retaining systems, are damaged or subjected to a load in an accident, they may not be able to provide their protective function. This could result in serious or even fatal injuries to the secured child in the event of an accident, heavy braking or a sudden change in direction.

For this reason, have child restraint systems and their anchorages which have been damaged or subjected to a load in an accident checked immediately at a qualified specialist workshop.

-  Vehicles with a centre seat in the rear: when fitting the ISOFIX child restraint system, make sure that the seat belt for the centre seat does not get trapped. Otherwise, the seat belt could be damaged.

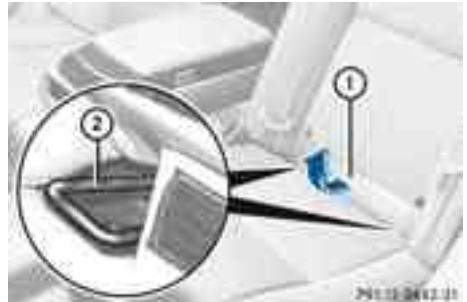

- Fold upholstery cover ① and the Velcro fastener upwards.
- Install the ISOFIX child restraint systems on both securing rings ②. Comply with the manufacturer's instructions when installing the ISOFIX child restraint system.

Top Tether

Top Tether provides an additional connection between the child restraint system secured with ISOFIX and the rear seat. It helps reduce the risk of injury even further.

The Top Tether anchorage points are located in the rear compartment behind the head restraints.



- ▶ Vehicles with electrically adjustable rear seats: move the rear seat backrests to an upright position (▷ page 104).
- ▶ Remove respective covering cap ① of the Top Tether anchorage.
- ▶ Place covering cap ① in a suitable place (e.g. in the glove compartment).

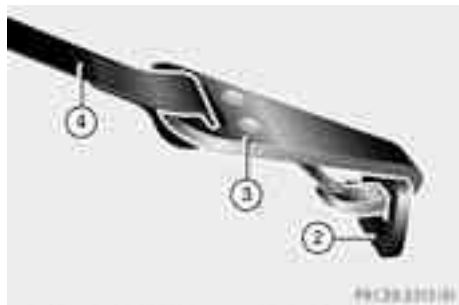

- ▶ Move the head restraint upwards.
- ▶ Route Top Tether belt ④ under the head restraint between the two head restraint bars.
- ▶ Hook Top Tether hook ③ of Top Tether belt ④ into Top Tether anchorage ②.

Ensure that:

- Top Tether hook ③ is hooked into Top Tether anchorage ② as shown.
 - Top Tether belt ④ is not twisted.
 - Top Tether belt ④ can move freely between the rear seat backrest and the head restraint.
- ▶ Fit the ISOFIX child restraint system with Top Tether. Comply with the manufacturer's installation instructions when doing so. Make sure that Top Tether belt ④ is tight.

The child restraint system with Top Tether belt ④ has been removed:

- ▶ Slide covering cap ① onto Top Tether anchorage ②.

WARNING





Vehicles with electrically adjustable vehicle seats in the rear compartment:

Never adjust the seat position after fitting the child restraint system. This could:

- damage the child restraint system
- inadvertently loosen or tighten the belt
- loosen the child restraint system
- move the child restraint system into an incorrect position

All the above points reduce the child restraint system's effectiveness and therefore increase the risk of severe injury in the event of an accident.

Problems with child seat recognition

Problem	Possible causes/consequences and ► Solutions
<p>The  PASSENGER AIRBAG OFF indicator lamp on the centre console is lit.</p>	<p>A special Mercedes-Benz child seat with a transponder for automatic child seat recognition has been fitted to the front-passenger seat. The front-passenger airbag has therefore been disabled as desired.</p> <p> Risk of injury</p> <p>There is no child seat fitted to the front-passenger seat. Automatic child seat recognition is malfunctioning.</p> <p>It is also possible that the  SRS warning lamp lights up and/or the  PASSENGER AIRBAG OFF indicator lamp does not light up briefly when you switch the ignition on.</p> <p>► Remove electronic equipment from the front-passenger seat, e.g.</p> <ul style="list-style-type: none"> • laptop • mobile phone • cards with transponders, such as ski passes or access cards <p>If the  PASSENGER AIRBAG OFF indicator lamp is still lit:</p> <p>► Visit a qualified specialist workshop.</p>

Suitable positioning of the child restraint systems

Key to the letters used in the table:

- X Seat which is unsuitable for children in this weight category.
- U Suitable for child restraint systems in the Universal category that are approved for use in this weight category.
- L Suitable for child restraint systems as recommended, see the following table of "Recommended child restraint systems" (► page 66).

Weight categories	Seat positions			
	Front-passenger seat		Rear seat	
	Front-passenger air-bag is not disabled:	The front-passenger air-bag is disabled ⁴	Left, right	Centre
Group 0: up to 10 kg	X	U ⁵	U, L ⁶	X
Group 0+: up to 13 kg	X	L ⁵	U, L ⁶	X
Group I: 9 to 18 kg	U ⁵ , L ⁵	U ⁵ , L ⁵	U, L ⁶	L
Group II: 15 to 25 kg	U ⁵ , L ⁵	U ⁵ , L ⁵	U, L ⁶	L
Group III: 22 to 36 kg	U ⁵ , L ⁵	U ⁵ , L ⁵	U, L ⁶	L

"Universal" category child restraint systems can be recognised by their orange approval label.



Example: approval label on the child restraint system

Recommended child restraint systems

When installing a child restraint system on the front-passenger seat:

- Adjust the front-passenger seat to its highest and rearmost position and the head restraint to its highest position.

⁴ Vehicles with automatic child seat recognition on the front-passenger seat: a child restraint system of the "Universal" category with a transponder for automatic child seat recognition must be fitted. The  PASSENGER AIRBAG OFF indicator lamp must be lit.

⁵ Move the front-passenger seat to the rearmost and highest position. Move the head restraints to the highest position.

⁶ Not suitable for electrically adjustable rear seats.

Weight categories	Manufacturer	Type	Approval number (E1 ...)	Order number (A 000 ...)	Automatic child seat recognition
Group 0: up to 10 kg up to approximately 6 months	Britax Römer	BABY SAFE PLUS ⁷	03 301146	970 10 00	Yes
			04 301146		
Group 0+: up to 13 kg up to approximately 15 months	Britax Römer	BABY SAFE PLUS ⁷	03 301146 04 301146	970 10 00	Yes
Group I: 9to 18 kg between approximately 9 months and 4 years	Britax Römer	DUO PLUS ⁷	03 301133	970 11 00	Yes
			04 301133	970 16 00	No
Group II/III: 15to 36 kg between approximately 4and 12 years	Britax Römer	KID ⁷	03 301148	970 12 00	Yes
			04 301148	970 17 00	No

Child-proof locks

Important safety notes

WARNING

Do not leave children unsupervised in the vehicle, even if they are secured in a child restraint system. They could injure themselves on parts of the vehicle. They could also be seriously or even fatally injured by prolonged exposure to extreme heat or cold.

Do not expose the child restraint system to direct sunlight. Parts of the child restraint system could heat up and the child could burn herself/himself on them.

If a child opens a door, the child or other persons could be injured as a result. They could

get out and injure themselves or be injured by a passing vehicle.

Also observe the notes on HOLD. Relevant information can be found in the index.

Child-proof locks for the rear doors

You secure each door individually with the child-proof locks on the rear doors. A door secured with a child-proof lock cannot be opened from inside the vehicle. When the vehicle is unlocked, the door can be opened from the outside.

⁷ Move the front-passenger seat to the rearmost and highest position.



- ▶ **To activate:** press the child-proof lock lever up in the direction of arrow ①.
 - ▶ Make sure that the child-proof locks are working properly.
 - ▶ **To deactivate:** press the child-proof lock lever down in the direction of arrow ②.
- i** Except United Kingdom: if you press the  central unlocking button on the driver's or front-passenger door, the child-proof locks on the rear doors are deactivated temporarily.

WARNING

If the child-proof locks are deactivated by pressing the  central unlocking button, both rear doors are unlocked. The rear doors can now be opened from the inside.

If children open a door, they could:

- injure other people
- get out of the vehicle and thereby injure themselves or be injured by a passing vehicle

Do not leave children unsupervised in the vehicle. Children could deactivate the child-proof locks on the rear doors and unlock the vehicle by pressing the central unlocking button. They could then open the doors and endanger themselves or others.

Override feature for the rear side windows

For the rear compartment, you can disable operation of:

- the rear side windows
- the cigarette lighter in the rear
- the adjustment of the front-passenger seat from the rear compartment
- the sunblinds:
 - in the roof
 - of the rear window
 - of the rear side windows

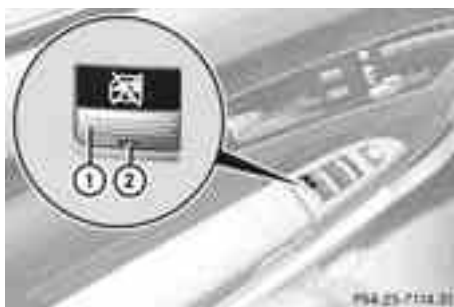

- ▶ **To activate/deactivate:** press button ①. If indicator lamp ② is lit, the rear-compartment functions are disabled. The rear side windows can then only be operated using the switches on the driver's door. If indicator lamp ② is off, the functions are enabled. The rear side windows can be operated using the switches in the rear compartment.

Panic alarm



▶ **To activate:** press **PANIC** button ① for at least one second.

An alarm sounds and the exterior lighting flashes.

▶ **To deactivate:** press **PANIC** button ① again.

or

▶ Insert the key into the ignition lock.

or

▶ Press the KEYLESS-GO Start/Stop button.
The KEYLESS-GO key must be in the vehicle.

i The panic alarm function is only available in Mexico.

Driving safety systems

Driving safety systems overview

In this section, you will find information about the following driving safety systems:

- ABS (**A**nti-**l**ock **B**raking **S**ystem)
- BAS (**B**rake **A**ssist **S**ystem)
- BAS PLUS (**B**rake **A**ssist **S**ystem Plus)
- Adaptive brake lamps
- ESP® (**E**lectronic **S**tability **P**rogram)
- EBD (**e**lectronic **b**rake **f**orce **d**istribution)
- ADAPTIVE BRAKE
- PRE-SAFE® Brake

Important safety notes

⚠ WARNING

Hybrid vehicles: ensure that you read the "HYBRID" supplement. You could otherwise fail to recognise dangers.

If you fail to adapt your driving style or if you are inattentive, the driving safety systems can neither reduce the risk of accident nor override the laws of physics. Driving safety systems are merely aids designed to assist driving. You are responsible for the distance to the vehicle in front, for vehicle speed and for braking in good time. Always adapt your driving style to suit the prevailing road and weather conditions and maintain a safe distance from the vehicle in front. Drive carefully.

i The driving safety systems described only work as effectively as possible when there is adequate contact between the tyres and the road surface. Pay particular attention to the information regarding tyres, recommended minimum tyre tread depths etc. in the "Wheels and tyres" section (> page 516).

In wintry driving conditions, always use winter tyres (M+S tyres) and, if necessary, snow chains. Only in this way will the driving safety systems described in this section work as effectively as possible.

ABS (Anti-lock Braking System)

Important safety notes

i Observe the "Important safety notes" section (> page 69).

⚠ WARNING

If ABS is faulty, the wheels could lock when braking. The steerability and braking characteristics may be severely impaired. Additionally, further driving safety systems are deactivated. There is an increased danger of skidding and accidents.

Drive on carefully. Have ABS checked immediately at a qualified specialist workshop.

When ABS is malfunctioning, other systems, including driving safety systems, will also become inoperative. Observe the information on the ABS warning lamp (▷ page 444) and display messages which may be shown in the instrument cluster (▷ page 410).

ABS regulates brake pressure in such a way that the wheels do not lock when you brake. This allows you to continue steering the vehicle when braking.

ABS works from a speed of about 8 km/h upwards, regardless of road-surface conditions. ABS works on slippery surfaces, even when you only brake gently.

The  warning lamp in the instrument cluster lights up when the ignition is switched on. It goes out when the engine is running.

Brakes

► **If ABS intervenes:** continue to depress the brake pedal with force until the braking situation is over.

► **To make a full brake application:** depress the brake pedal with full force.

If ABS intervenes when braking, you will feel a pulsing in the brake pedal.

The pulsating brake pedal can be an indication of hazardous road conditions and functions as a reminder to take extra care while driving.

BAS (Brake Assist System)

i Observe the "Important safety notes" section (▷ page 69).

WARNING

If BAS is malfunctioning, the braking distance in an emergency braking situation is increased. There is a risk of accident.

In an emergency braking situation, depress the brake pedal with full force. ABS prevents the wheels from locking.

BAS operates in emergency braking situations. If you depress the brake pedal quickly, BAS automatically boosts the braking force, thus shortening the stopping distance.

The brakes will function as usual once you release the brake pedal. BAS is deactivated.

BAS PLUS (Brake Assist System Plus)

BAS PLUS is only available on vehicles with DISTRONIC PLUS.

i Observe the "Important safety notes" section (▷ page 69).

BAS PLUS provides braking assistance in hazardous situations at speeds greater than 7 km/h and uses radar sensor technology to assess the traffic situation.

With the help of the radar sensor system, BAS PLUS can detect obstacles that are in the path of your vehicle for an extended period of time.

At speeds up to approximately 70 km/h, BAS PLUS may also detect stationary obstacles, for example, stopped or parked vehicles.

Should you approach an obstacle and BAS PLUS has detected a risk of collision, BAS PLUS calculates the braking force necessary to avoid a rear-end collision.

- **If you are driving at a speed over 30 km/h:** if you depress the brake sharply, BAS PLUS automatically raises the brake pressure to a value adapted to the traffic situation.
- **If you are driving at a speed under 30 km/h:** if you depress the brake, BAS PLUS is activated. Braking will be carried out at the last possible moment.

If BAS PLUS demands particularly high braking force, preventative passenger protection measures (PRE-SAFE®) are activated simultaneously.

- ▶ Keep the brake pedal depressed until the emergency braking situation is over. ABS prevents the wheels from locking.

The brakes will work normally again if:

- you release the brake pedal.
- there is no longer any danger of a rear-end collision.
- no obstacle is detected in front of your vehicle.

BAS PLUS is then deactivated.

Vehicles with COMAND and a navigation system: the radar sensor system is switched off automatically in the vicinity of radio telescope facilities (▷ page 545).

Vehicles without COMAND and a navigation system and vehicles for Australia: the radar sensor system and on-board computer must be switched off in the vicinity of radio telescope facilities (▷ page 408).

For BAS PLUS to assist you when driving, the radar sensor system must be switched on and operational; see "Radar sensor system" in the index.

WARNING

Adaptive Brake Assist cannot always clearly identify objects and complex traffic situations. In these cases, Adaptive Brake Assist may not intervene. There is a risk of an accident.

Always pay careful attention to the traffic situation and be ready to brake.

In particular, the detection of obstacles can be impaired if there is:

- dirt on the sensors or anything else covering the sensors
- snow or heavy rain
- interference by other radar sources
- the possibility of strong radar reflections, for example, in multi-storey car parks
- a narrow vehicle travelling in front, e.g. a motorcycle
- a vehicle travelling in front on a different line

WARNING

BAS PLUS does not react:

- to people or animals
- to oncoming vehicles
- to crossing traffic
- when cornering

As a result, BAS PLUS may not intervene in all critical situations. There is a risk of an accident.

Always pay careful attention to the traffic situation and be ready to brake.

Following damage to the front end of the vehicle, have the configuration and operation of the radar sensors checked at a qualified specialist workshop. This also applies to collisions at slow speeds where there is no visible damage to the front of the vehicle.

If BAS PLUS is not available due to a malfunction in the radar sensor system, the brake system remains available with full brake boosting effect and BAS.

Adaptive brake lamps

-  Adaptive brake lamps are only available in certain countries.

If you brake sharply from a speed of more than 50 km/h or if braking is assisted by BAS or BAS PLUS, the brake lamps flash rapidly. In this way, traffic travelling behind you is warned in an even more noticeable manner.

If you brake sharply from a speed of more than 70 km/h to a standstill, the hazard warning lamps are activated automatically. If the brakes are applied again, the brake lamps light up continuously. The hazard warning lamps switch off automatically if you travel faster than 10 km/h. You can also switch off the hazard warning lamps using the hazard warning switch button (▷ page 293).

ESP® (Electronic Stability Program)**Important safety notes**

i See the "Important safety notes" section (▷ page 69).

⚠ WARNING

If ESP® is malfunctioning, ESP® is unable to stabilise the vehicle. In addition, other driving safety systems are switched off. This increases the risk of skidding and an accident.



Drive on carefully. Have ESP® checked at a qualified specialist workshop.

! Vehicles with 4MATIC: switch off the ignition when the parking brake is being tested using a dynamometer.

Application of the brakes by ESP® may otherwise destroy the brake system.

Vehicles without 4MATIC: when towing your vehicle with the rear axle raised, it is important that you observe the notes on ESP® (▷ page 510).

ESP® is deactivated if the  warning lamp in the instrument cluster lights up continuously when the engine is running.

If the  warning lamp and the  warning lamp are lit continuously, ESP® is not available due to a malfunction.

Observe the information on warning lamps (▷ page 447) and display messages which may be shown in the instrument cluster (▷ page 410).

If ESP® detects that the vehicle is deviating from the direction desired by the driver, one or more wheels are braked to stabilise the vehicle. The engine output is also modified to keep the vehicle on the desired course within physical limits. ESP® assists the driver when pulling away on wet or slippery roads. ESP® can also stabilise the vehicle during braking.

If ESP® intervenes, the  ESP® warning lamp flashes in the instrument cluster.

If ESP® intervenes:

- ▶ Do not deactivate ESP® under any circumstances.
 - ▶ When pulling away, only depress the accelerator pedal as far as is necessary.
 - ▶ Adapt your driving style to suit the prevailing road and weather conditions.
- i** Only use wheels with the recommended tyre sizes. Only then will ESP® function properly.

ETS/4ETS (Electronic Traction System)

Traction control is part of ESP®.

Traction control brakes the drive wheels individually if they spin. This enables you to pull away and accelerate on slippery surfaces, for example if the road surface is slippery on one side. On vehicles with 4MATIC, more drive torque is also transferred to the wheel or wheels with traction.

Traction control remains active if you deactivate ESP®.

Deactivating/activating ESP®

i Observe the "Important safety notes" section (▷ page 69).

⚠ WARNING

If you deactivate ESP®, ESP® no longer stabilises the vehicle. There is an increased risk of skidding and an accident.

Only deactivate ESP® in the situations described in the following.

▶ **To deactivate:** (▷ page 404).

The  ESP® OFF warning lamp in the instrument cluster lights up.

S 63 AMG: deactivate ESP® when driving on designated roads when the vehicle's own oversteering and understeering characteristics are desired. Driving without ESP® requires an extremely qualified and experienced driver who is able to cope with these critical driving conditions.

► To activate: (▷ page 404).

The  ESP® OFF warning lamp in the instrument cluster goes out.

ESP® is activated automatically when the engine is started.

If ESP® is deactivated and one or more wheels start to spin, the  ESP® warning lamp in the instrument cluster flashes. In such situations, ESP® will not stabilise the vehicle.

It may be best to deactivate ESP® in the following situations:

- when using snow chains
- in deep snow
- on sand or gravel

If you deactivate ESP®:

- ESP® no longer improves driving stability.
- traction control is still activated.
- ESP® still provides support when you brake.
- the engine's torque is no longer limited, and the drive wheels can spin. The spinning of the wheels results in a cutting action, which provides better grip.

Vehicles with ECO start/stop function: the ECO start/stop function switches the engine off automatically when the vehicle comes to a stop. When pulling away again, the engine starts automatically. ESP® remains in its previously selected status. Example: if ESP® was deactivated before the engine was switched off, ESP® remains deactivated when the engine is switched on again.

ESP® trailer stabilisation** WARNING**

If road and weather conditions are poor, trailer stabilisation will not be able to prevent the vehicle/trailer combination from swerving. Trailers with a high centre of gravity can tip over before ESP® can detect this. There is a risk of an accident.

Always adapt your driving style to the prevailing road and weather conditions.

If your vehicle/trailer combination begins to lurch, you can only stabilise the vehicle/trailer combination by depressing the brake firmly.

In this situation, ESP® assists you and can detect if the vehicle/trailer combination begins to lurch. ESP® slows the vehicle down by braking and limiting the engine output until the vehicle/trailer combination has stabilised.

Trailer stabilisation is active above speeds of about 65 km/h.

Trailer stabilisation does not work if ESP® is deactivated or disabled because of a malfunction.

EBD (electronic brake force distribution)

- ❗ Observe the "Important safety notes" section (▷ page 69).

 WARNING

If EBD has malfunctioned, the rear wheels can still lock, e.g. under full braking. This increases the risk of skidding and an accident.

You should therefore adapt your driving style to the different handling characteristics. Have the brake system checked at a qualified specialist workshop.

Observe information regarding indicator and warning lamps (▷ page 444) as well as display messages (▷ page 413).

EBD monitors and controls the brake pressure on the rear wheels to improve driving stability while braking.

ADAPTIVE BRAKE

ADAPTIVE BRAKE enhances braking safety and offers increased braking comfort. In addition to the braking function, ADAPTIVE BRAKE

also has the HOLD function (▷ page 357) and hill start assist (▷ page 325).

PRE-SAFE® Brake

i Observe the "Important safety notes" section (▷ page 69).

PRE-SAFE® Brake is only available in vehicles with DISTRONIC PLUS.

PRE-SAFE® Brake can help you to minimise the risk of a collision with a vehicle ahead or reduce the effects of such a collision. If PRE-SAFE® Brake has detected a risk of collision, you will be warned visually and acoustically as well as by automatic braking. PRE-SAFE® Brake cannot prevent a collision without your intervention.

This function will issue a warning if:

- at speeds of around 30 km/h or more, over several seconds, the distance maintained to the vehicle travelling in front is insufficient.

The  distance warning lamp then lights up in the instrument cluster.

- at a speed of approximately 7 km/h or higher, you very quickly approach a vehicle in front.

An intermittent warning tone will then sound and the  distance warning lamp will light up in the instrument cluster.

- ▶ Brake immediately in order to increase the distance from the vehicle in front.

or

- ▶ Take evasive action provided it is safe to do so.

From a speed of approximately 7 km/h, if the driver and passengers have fastened their seat belts, PRE-SAFE® Brake can brake the vehicle automatically from a speed of up to approximately 200 km/h.

Due to the nature of the system, particularly complicated driving conditions may cause unnecessary warnings or the unnecessary intervention of PRE-SAFE® Brake.

You can prevent the intervention of the PRE-SAFE® Brake at any time by:

- depressing the accelerator pedal further
- activating kickdown
- releasing the brake pedal.

The braking action of PRE-SAFE® Brake is ended automatically if:

- you manoeuvre to avoid the obstacle.
- there is no longer any danger of a rear-end collision.
- there is no longer an obstacle detected in front of your vehicle.

With the help of the radar sensor system, PRE-SAFE® Brake can detect obstacles that are in front of your vehicle for an extended period of time.

At speeds up to approximately 70 km/h, PRE-SAFE® Brake can also detect stationary obstacles, for example, stopped or parked vehicles.

If you approach an obstacle and PRE-SAFE® Brake detects a risk of a collision, the system will initially alert you both visually and acoustically. If you do not brake or take evasive action, the system will warn you by automatically braking the vehicle gently. If there is an increased risk of collision, preventative passenger protection measures (PRE-SAFE®) are activated (▷ page 53). If, at speeds over 30 km/h, a risk of collision remains and you do not brake, take evasive action or significantly accelerate, automatic braking may be performed up to a level of automatic emergency braking. Automatic emergency braking is not performed until immediately prior to an accident that can no longer be avoided.

WARNING

PRE-SAFE® Brake will initially brake your vehicle by a partial application of the brakes if a danger of collision is detected. There may be a collision unless you also brake. Automatic emergency braking cannot prevent a collision. There is a risk of an accident.

Always apply the brakes yourself and try to take evasive action.

WARNING

PRE-SAFE® Brake cannot always clearly identify objects and complex traffic conditions.

In these cases, PRE-SAFE® Brake may:

- give an unnecessary warning and then brake the vehicle
- neither give a warning nor intervene

There is a risk of an accident.

Always pay particular attention to the traffic situation and be ready to brake, especially if PRE-SAFE® Brake warns you. Terminate the intervention in a non-critical driving situation.

In particular, the detection of obstacles can be impaired if there is:

- dirt on the sensors or anything else covering the sensors
- snow or heavy rain
- interference by other radar sources
- the possibility of strong radar reflections, for example, in multi-storey car parks
- a narrow vehicle travelling in front, e.g. a motorcycle
- a vehicle travelling in front on a different line

WARNING

PRE-SAFE® Brake does not react:

- to people or animals
- to oncoming vehicles
- to crossing traffic
- when cornering

As a result, PRE-SAFE® Brake may neither give warnings nor intervene in all critical situations. There is a risk of an accident.

Always pay careful attention to the traffic situation and be ready to brake.

In order to maintain the appropriate distance to the vehicle in front and thus prevent a collision, you must apply the brakes yourself.

► **To activate/deactivate:** activate or deactivate PRE-SAFE® Brake in the on-board computer (▷ page 405).

After activation, the  symbol is displayed on the left in the instrument cluster.

For PRE-SAFE® Brake to assist you when driving, the radar sensor system must be switched on (▷ page 408) and be operational.

Vehicles with COMAND and a navigation system: the radar sensor system is switched off automatically in the vicinity of radio telescope facilities (▷ page 545).

Vehicles without COMAND and a navigation system and vehicles for Australia: the radar sensor system and on-board computer must be switched off in the vicinity of radio telescope facilities (▷ page 408).

Following damage to the front end of the vehicle, have the configuration and operation of the radar sensors checked at a qualified specialist workshop. This also applies to collisions at slow speeds where there is no visible damage to the front of the vehicle.

Anti-theft systems

Immobiliser

The immobiliser prevents your vehicle from being started without the correct key.

► **To activate with the key:** remove the key from the ignition lock.

► **To activate with KEYLESS-GO:** switch the ignition off and open the driver's door.

► **To deactivate:** switch on the ignition.

 The immobiliser is always deactivated when you start the engine.

ATA (Anti-Theft Alarm system)

A visual and audible alarm is triggered if the alarm system is primed and you open:

- a door
- the vehicle with the emergency key element
- the boot lid
- the bonnet

The alarm is not switched off, even if you close the open door that has triggered it, for example.

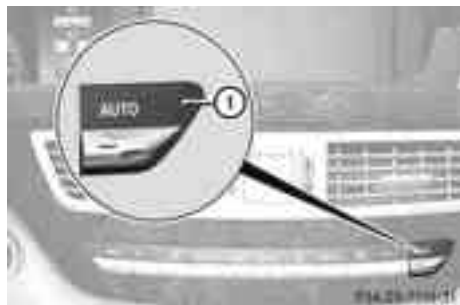

► **To prime:** lock the vehicle with the key or KEYLESS-GO.

Indicator lamp ① flashes. The alarm system is primed after approximately 30 seconds.

► **To switch off:** unlock the vehicle with the key or KEYLESS-GO.

► **To stop the alarm using the key:** insert the key into the ignition lock. The alarm is switched off.

or

► Press the  or  button on the key. The alarm is switched off.

► **To stop the alarm using KEYLESS-GO:** grasp the outside door handle. The key must be outside the vehicle. The alarm is switched off.

or

► Press the Start/Stop button on the dashboard. The key must be inside the vehicle. The alarm is switched off.

Tow-away protection

An audible and visual alarm is triggered if your vehicle's angle of inclination is altered while tow-away protection is primed. This occurs if the vehicle is jacked up on one side, for example.

► **To prime:** lock the vehicle with the key or KEYLESS-GO.

Tow-away protection is primed after approximately 30 seconds.

► **To switch off:** unlock the vehicle with the key or KEYLESS-GO.

Tow-away protection is switched off automatically.

To prevent a false alarm, deactivate tow-away protection manually if your vehicle:

- is being transported
- is being loaded onto a ferry or car transporter, for example
- is parked on a movable surface, e.g. in a split-level garage

You can prime and deactivate tow-away protection using the on-board computer (► page 277).

Interior motion sensor

When the interior motion sensor is primed, a visual and audible alarm is triggered if movement is detected in the vehicle interior. This occurs if someone reaches into the vehicle interior, for example.

To activate:

► Make sure that:

- the side windows are closed.
- the sliding sunroof/panorama sliding sunroof is closed.

This will prevent false alarms.

► Lock the vehicle with the key or KEYLESS-GO.

To deactivate:

- ▶ Unlock the vehicle with the key or KEYLESS-GO.
The interior motion sensor is switched off automatically.

To prevent a false alarm, deactivate the interior motion sensor if you lock your vehicle and:

- people or animals remain in the vehicle.
- the side windows remain open.
- the sliding sunroof/panorama sliding sunroof remains open.

You can deactivate the interior motion sensor via the on-board computer (▷ page 277).

- i UK only:** your vehicle is equipped with a double lock function. The doors cannot be opened from the inside if the vehicle was locked with the key or with KEYLESS-GO (▷ page 87). Deactivate the interior motion sensor before you lock the vehicle. The doors can then be opened from the inside after the vehicle has been locked from the outside. Observe the "Important safety notes" (▷ page 86).

Useful information	80
Key	80
Doors	86
Boot	88
Side windows	91
Sliding sunroof	94

Useful information

- i** This Owner's Manual describes all models and all standard and optional equipment available to your vehicle at the time of publication of the Owner's Manual. Country-specific deviations are possible. Please note that your vehicle may not be equipped with all features described. This also applies to safety-relevant systems and functions.
- i** Please read the information on qualified specialist workshops (▷ page 32).

Key

Key functions

The key centrally locks/unlocks:

- the doors
- the boot lid
- the fuel filler flap

WARNING

Only for the United Kingdom: if the vehicle has been locked with the key or with KEY-LESS-GO, the double lock function is activated as standard. It is then not possible to open the doors from inside the vehicle.

Therefore, do not leave any people behind in the vehicle, particularly children, elderly people or people requiring special assistance. As a result, they may not be able to free themselves in the event of an emergency. They could be seriously or even fatally injured by prolonged exposure to extremely high or low temperatures, for example. In this case, rescuing people from outside the vehicle is difficult.

Deactivate the interior motion sensor before you lock the vehicle. The doors can then be opened from the inside after the vehicle has been locked from the outside.

WARNING

If children are left unsupervised in the vehicle, they could:



- open a door from inside the vehicle at any time, even if it has been locked
- start the vehicle using a key which has been left in the vehicle
- release the electric parking brake

They could thereby endanger themselves and others. Never leave children unsupervised in the vehicle. Always take the key with you when leaving the vehicle, even if you are only leaving it for a short time.

WARNING

If a key ring is too heavy or too large, the weight acting on the key could cause it to turn in the ignition lock or catch on the steering wheel. This could cause the engine to be switched off suddenly. You may lose control of the vehicle and cause an accident. Do not attach any heavy or large key rings to the key that is inserted in the ignition.



- ①  To lock the vehicle
- ②  To unlock the boot lid
- ③  To unlock the vehicle

When unlocking, the turn signals flash once. When locking, they flash three times.

When it is dark, the surround lighting also comes on if it is activated in COMAND (▷ page 276).

If you activate the acoustic locking confirmation function you will hear the following, depending on the date of production of the vehicle:

- an acoustic signal when locking
or
- one acoustic signal when unlocking and three when locking

The audible signal can be activated and deactivated using the on-board computer (▷ page 408).

► **To unlock centrally:** press the  button.

If you do not open the vehicle within approximately 40 seconds of unlocking:

- the vehicle is locked again.
- the anti-theft system is primed again.

► **To lock centrally:** press the  button.

KEYLESS-GO

Important notes on the use of KEYLESS-GO

WARNING

Only for the United Kingdom: if the vehicle has been locked with the key or with KEYLESS-GO, the double lock function is activated as standard. It is then not possible to open the doors from inside the vehicle.

Therefore, do not leave any people behind in the vehicle, particularly children, elderly people or people requiring special assistance. As a result, they may not be able to free themselves in the event of an emergency. They could be seriously or even fatally injured by prolonged exposure to extremely high or low temperatures, for example. In this case, rescuing people from outside the vehicle is difficult.

Deactivate the interior motion sensor before you lock the vehicle. The doors can then be opened from the inside after the vehicle has been locked from the outside.

• Do not keep the KEYLESS-GO key together with:

- electronic devices, e.g. a mobile phone or another key
- metallic objects, e.g. coins or metal foil

This can affect the functionality of KEYLESS-GO.

• Bear in mind that the engine can be started by any of the vehicle occupants if there is a KEYLESS-GO key in the vehicle.

Locking and unlocking centrally

You can start, lock or unlock the vehicle using KEYLESS-GO. To do this, you only need carry the key with you. You can combine the KEYLESS-GO functions with those of a conventional key, e.g. using KEYLESS-GO to unlock and pressing the  button to lock.

When locking or unlocking with KEYLESS-GO, the distance between the key and the corresponding door handle must not be greater than 1 m.

KEYLESS-GO checks whether a valid key is in the vehicle by periodically establishing a radio connection between the vehicle and the key. This happens:

- when the external door handles are touched
- when starting the engine
- while the vehicle is in motion





- ▶ **To unlock the vehicle:** pull the door handle.
- ▶ **To lock the vehicle:** touch sensor surface ①.
- ▶ **Convenience closing feature:** touch recessed sensor surface ② for an extended period (▷ page 93).



If you pull on the handle of the boot lid, only the boot of the vehicle is unlocked.

If the vehicle has been parked for a long time, the sensor surfaces are deactivated automatically. In order to unlock the door, pull the door handle. In order to reactivate the sensor surface, switch the ignition on again.



Changing the settings of the locking system

You can change the setting of the locking system in such a way that only the driver's door and the fuel filler flap are unlocked. This is useful if you frequently travel on your own.

- ▶ **To change the setting:** press and hold down the  and  buttons simultaneously for approximately six seconds until the battery check lamp flashes twice (▷ page 83).

i If the setting of the locking system is changed within the signal range of the vehicle, pressing the  or  button locks or unlocks the vehicle.



The key now functions as follows:

- ▶ **To unlock the driver's door:** press the  button once.
- ▶ **To unlock centrally:** press the  button twice.
- ▶ **To lock centrally:** press the  button.

The KEYLESS-GO function is changed as follows:

- ▶ **To unlock the driver's door:** pull the door handle on the driver's door.
- ▶ **To unlock centrally:** pull the door handle on the front-passenger door or on the rear doors.
- ▶ **To lock centrally:** touch the outer sensor surface on one of the door handles.

Restoring factory settings

- ▶ Press the  and  buttons simultaneously for approximately six seconds until the battery check lamp flashes twice.

Emergency key element

General notes

If you use the emergency key element to unlock and open the driver's door or the boot lid, the anti-theft alarm system will be triggered (▷ page 76).

There are several ways to turn off the alarm:

- ▶ **To turn the alarm off with the key:** press the  or  button on the key.

or

- ▶ Insert the key into the ignition lock.

or

- ▶ **To deactivate the alarm with KEYLESS-GO:** press the Start/Stop button in the ignition lock. The key must be in the vehicle.

or

- ▶ Lock or unlock the vehicle using KEYLESS-GO. The key must be outside the vehicle.

Removing the emergency key element



- ▶ Push release catch ① in the direction of the arrow and at the same time, remove emergency key element ② from the key.

Battery of the key

Important safety notes

Have the batteries changed at a qualified specialist workshop.

WARNING

Batteries are toxic and contain caustic substances. For this reason, keep batteries out of the reach of children.

If a battery has been swallowed, visit a doctor immediately.

Environmental note





Batteries contain pollutants. It is illegal to dispose of them with the household rubbish. They must be collected separately and disposed of in an environmentally responsible recycling system.



Dispose of batteries in an environmentally responsible manner. Take discharged batteries to a qualified specialist workshop or to a collection point for used batteries.



Checking the battery



- ▶ Press the  or  button. The battery is working properly if the battery check lamp ① lights up briefly

If battery check lamp ① does not light up briefly during the test, the battery is discharged.

- ▶ Changing the battery (▶ page 83)

i If the key battery is checked within the signal reception range of the vehicle, pressing the  or  button locks or unlocks the vehicle.

Replacing the battery

You require a CR 2025 3 V cell battery.

- ▶ Take the emergency key element out of the key (▶ page 82).









- ▶ Press emergency key element ② into the opening in the key in the direction of the

arrow until battery tray cover ① opens.
When doing so, do not hold cover ① shut.

- ▶ Remove battery tray cover ①.



- ▶ Repeatedly tap the key against your palm until battery ③ falls out.
- ▶ Insert the new battery with the positive terminal facing upwards. Use a lint-free cloth to do so.
- ▶ Make sure that the surface of the battery is free from lint, grease and all other forms of contamination.
- ▶ Insert the front tabs of battery tray cover ① and then press to close it.
- ▶ Insert the emergency key element into the key.
- ▶ Check the function of all key buttons on the vehicle.

Problems with the key	
Problem	Possible causes/consequences and ► Solutions
You cannot lock or unlock the vehicle using the key.	<p>The key battery is discharged or nearly discharged.</p> <ul style="list-style-type: none"> ► Try again to lock/unlock the vehicle using the remote control function of the key. Point the tip of the key at the driver's door handle from close range and press the  /  button. <p>If this does not work:</p> <ul style="list-style-type: none"> ► Check the key battery (▷ page 83) and replace it if necessary (▷ page 83). ► Lock (▷ page 88) or unlock (▷ page 88) the vehicle using the emergency key element.
	<p>The key is faulty.</p> <ul style="list-style-type: none"> ► Lock (▷ page 88) or unlock (▷ page 88) the vehicle using the emergency key element. ► Have the key checked at a qualified specialist workshop.
You can no longer lock or unlock the vehicle using KEYLESS-GO.	<p>KEYLESS-GO is in standby mode because the vehicle has not been unlocked for an extended period.</p> <ul style="list-style-type: none"> ► Pull the door handle twice and then insert the key into the ignition lock.
	<p>There is interference from a powerful source of radio waves.</p> <ul style="list-style-type: none"> ► Lock/unlock the vehicle using the remote control function of the key. Point the tip of the key at the driver's door handle from close range and press the  /  button.
	<p>There is a fault with KEYLESS-GO.</p> <ul style="list-style-type: none"> ► Lock/unlock the vehicle using the remote control function of the key. Point the tip of the key at the driver's door handle from close range and press the  /  button. ► Have KEYLESS-GO checked at a qualified specialist workshop. <p>If this does not work:</p> <ul style="list-style-type: none"> ► Check the key battery (▷ page 83) and replace it if necessary (▷ page 83). ► Lock (▷ page 88) or unlock (▷ page 88) the vehicle using the emergency key element.
You have lost a key.	<ul style="list-style-type: none"> ► Have the key deactivated at a qualified specialist workshop. ► Report the loss immediately to the vehicle insurers. ► If necessary, have the locks changed as well.

Problem	Possible causes/consequences and ► Solutions
You have lost the emergency key element.	<ul style="list-style-type: none"> ► Report the loss immediately to the vehicle insurers. ► If necessary, have the locks changed as well.
The engine cannot be started using the key.	<p>The on-board voltage is too low.</p> <ul style="list-style-type: none"> ► Remove the key and reinsert it into the ignition lock. ► Start the engine within 30 seconds of inserting the key into the ignition lock. ► Repeat if necessary. <p>If the engine does not start after several attempts:</p> <ul style="list-style-type: none"> ► Check the starter battery and charge it if necessary (▷ page 504). <p>or</p> <ul style="list-style-type: none"> ► Jump-start the vehicle (▷ page 507). <p>or</p> <ul style="list-style-type: none"> ► Consult a qualified specialist workshop.
The engine cannot be started using KEYLESS-GO. The key is in the vehicle.	<p>A door is open. Therefore, the key cannot be detected as easily.</p> <ul style="list-style-type: none"> ► Close the door and try to start the vehicle again. <p>There is interference from a powerful source of radio waves.</p> <ul style="list-style-type: none"> ► Start your vehicle with the key in the ignition lock.

Doors

Important safety notes

WARNING

Only for the United Kingdom: if the vehicle has been locked with the key or with KEYLESS-GO, the double lock function is activated as standard. It is then not possible to open the doors from inside the vehicle.

Therefore, do not leave any people behind in the vehicle, particularly children, elderly people or people requiring special assistance. As a result, they may not be able to free themselves in the event of an emergency. They could be seriously or even fatally injured by prolonged exposure to extremely high or low temperatures, for example. In this case, rescuing people from outside the vehicle is difficult.

Deactivate the interior motion sensor before you lock the vehicle. The doors can then be opened from the inside after the vehicle has been locked from the outside.

WARNING

If children are left unsupervised in the vehicle, they could:

- open a door from inside the vehicle at any time, even if it has been locked
- start the vehicle using a key which has been left in the vehicle
- release the electric parking brake

They could thereby endanger themselves and others. Never leave children unsupervised in the vehicle. Always take the key with you when leaving the vehicle, even if you are only leaving it for a short time.

Unlocking and opening the doors from the inside

For all countries except the United Kingdom: you can open a door from inside the vehicle even if it has been locked.

Only for the United Kingdom: if the vehicle has been locked with the key or with KEYLESS-GO, the double lock function is activated as standard. It is then not possible to open the doors from inside the vehicle. Deactivate the interior motion sensor (▷ page 277) before you lock the vehicle. The doors can then be opened from the inside after the vehicle has been locked from the outside.

You can only open the rear doors from inside the vehicle if they are not secured by the child-proof locks (▷ page 67).



► Pull door handle ②.

If the door is locked, locking knob ① pops up. The door is unlocked and can be opened.

Centrally locking and unlocking the vehicle from the inside

You can centrally lock or unlock the vehicle from the inside.

The central locking/unlocking button does not lock or unlock the fuel filler flap.

- ❗ You cannot unlock the vehicle centrally from the inside if the vehicle has been locked with the key or KEYLESS-GO.

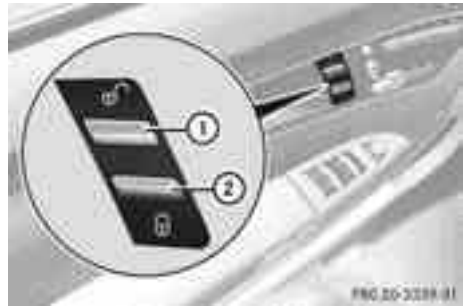

► **To unlock:** press button ①.

► **To lock:** press button ②.

Automatic locking feature

The vehicle is locked automatically when the ignition is switched on and the wheels are turning.

You could therefore be locked out when:

- the vehicle is being pushed.
- the vehicle is being towed.
- the vehicle is being tested on a dynamometer.

You can switch off the automatic locking function via COMAND (▷ page 276).

Power closing feature

The power closing feature pulls the doors and boot lid into their locks automatically even if they are only partly closed.

⚠ WARNING

Make sure that nobody can become trapped as you close the doors and boot lid.

If there is a danger of being trapped, pull the door handle on the inside or outside or pull the boot lid handle.

Do not activate the power closing feature by tampering with the lock mechanism. You could otherwise injure yourself.

⚠ WARNING

Make sure that the doors and boot lid are always fully closed. Otherwise, a door or the boot lid could open during the journey and endanger yourself or others.

- ▶ **Power closing feature (doors):** push the door past the first detent position of the lock.
The power closing feature will pull the door fully closed.
- ▶ **Power closing feature (boot lid):** lightly push the boot lid closed.
The power closing feature will pull the boot lid fully closed.

Unlocking the driver's door (emergency key element)

If the vehicle can no longer be unlocked with the key, use the emergency key element.

If you use the emergency key element to unlock and open the driver's door, the anti-theft alarm system will be triggered (▷ page 76).

- ▶ Take the emergency key element out of the key (▷ page 82).
- ▶ Insert the emergency key element into the lock of the driver's door as far as it will go.



- ▶ Firmly turn the emergency key element anti-clockwise as far as it will go to position **1** and hold it in this position.
- i** On right-hand-drive vehicles, turn the emergency key element clockwise.

- ▶ Pull the door handle quickly.
The locking knob pops up.
The door is unlocked.
- ▶ Turn the emergency key element back and remove it.
- ▶ Pull the door handle again.
- ▶ Insert the emergency key element into the key.

Locking the vehicle

If the vehicle can no longer be locked with the key, you can lock it by taking the following steps. If the central locking in the vehicle is malfunctioning, you cannot lock the boot.

- ▶ Press down the locking knobs on the open rear doors.
- ▶ Close the rear doors.
- ▶ Open the front-passenger door.
- ▶ Close the driver's door and the boot lid.
- ▶ Press down the locking knob of the driver's door inside the vehicle.
- ▶ Press down the locking knob of the open front-passenger door.
- i** Make sure that you have the key on your person and that it has not been left in the vehicle.
- ▶ Close the front-passenger door.
- ▶ Make sure that the doors and the boot are locked.

i If you lock the vehicle as described above, the fuel filler flap is not locked. The anti-theft alarm system is not primed.

Boot**Important safety notes**

Do not leave the key in the boot. You could otherwise lock yourself out.

⚠ WARNING

Exhaust fumes could enter the vehicle interior if the engine is running and the boot lid is

open. This could poison you. Therefore, you should make sure that the boot lid is always closed when the engine is running.

- ❗ The boot lid swings upwards when opened. Therefore, make sure that there is sufficient clearance above the boot lid.
- i You will find details on the boot lid opening dimensions in the Technical data section (▷ page 543).

You can limit the opening angle of the boot lid. This could be useful, for example, if there is insufficient space above the boot lid. You can switch the **Boot lid opening limiter** function on or off via COMAND (▷ page 278).

Vehicles without the boot lid remote closing feature: the boot lid can be:

- opened and closed manually from outside
- opened automatically from outside
- opened automatically from inside
- locked separately
- unlocked with the emergency key element

Vehicles with the boot lid remote closing feature: the boot lid can be:

- opened and closed manually from outside
- opened and closed automatically from outside
- opened and closed automatically from inside
- locked separately
- unlocked with the emergency key element

Opening/closing manually

Opening

- ▶ Press the  button on the key.





- ▶ Pull handle ①.
- ▶ Raise the boot lid.

Closing

 **WARNING**

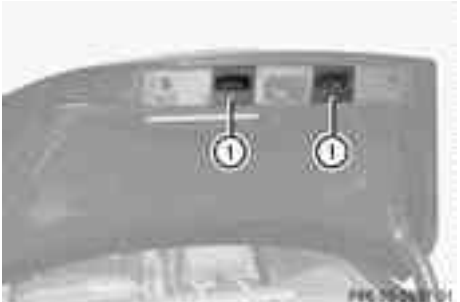
Make sure that nobody can become trapped when closing the boot lid.



- ▶ Pull the boot lid down using recess ①.
- ▶ If necessary, lock the vehicle with the  button on the key (▷ page 80) or with KEYLESS-GO (▷ page 81).
- i If a KEYLESS-GO key is detected in the boot, the boot lid cannot be locked and then opens again.

Opening/closing automatically from the outside

Important safety notes

WARNING

Monitor the boot lid opening and closing procedures to make sure that nobody can become trapped. To stop the opening or closing procedure, press the closing button on the boot lid again or pull the handle on the outside of the boot lid.

! The boot lid swings upwards when opened. Therefore, make sure that there is sufficient clearance above the boot lid.

i You will find details on the boot lid opening dimensions in the Technical data section (▷ page 543).

Opening

You can open the boot lid with the key.

▶ Press and hold the  button on the key until the boot lid opens.

Closing

You can close the boot lid automatically by using the closing button⁸ or locking button⁹.



▶ **To close:** press closing button ① in the boot lid.

▶ **To close and lock simultaneously:**

Press locking button ② in the boot lid.

i If you leave a KEYLESS-GO key in the boot, the boot lid will not lock.

Opening/closing automatically from the inside

WARNING

Monitor the boot lid closing procedure to make sure that nobody can become trapped. Release the boot lid remote operating button to stop the closing procedure.

You can open and close the boot lid from the driver's seat when the vehicle is stationary and unlocked.



▶ **To open:** press remote operating switch for boot lid ① until the boot lid opens.

▶ **To close:** press remote operating switch for boot lid ① until the boot lid is closed.

Locking the boot separately

i The separate boot locking function is only available in certain countries.

You can lock the boot separately. If you then unlock the vehicle centrally, the boot remains locked and cannot be opened.

⁸ For vehicles with the boot lid remote closing feature only.

⁹ For vehicles with the boot lid remote closing feature and KEYLESS-GO only.

- ▶ Close the boot lid.
- ▶ Take the emergency key element out of the key (▷ page 82).

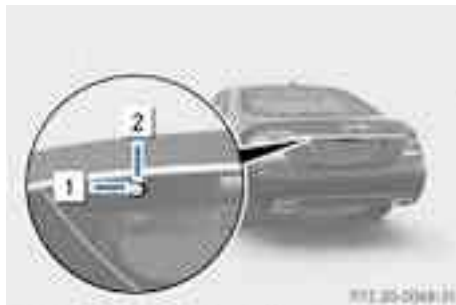

- ▶ Insert the emergency key element into the boot lid lock as far as the stop.
- ▶ Turn the emergency key element clockwise from position **1** to position **2**.
- ▶ Pull out the emergency key element.
- ▶ Insert the emergency key element into the key.

Unlocking the boot (emergency key element)

! The boot lid swings upwards when opened. Therefore, make sure that there is sufficient clearance above the boot lid.

If the boot cannot be unlocked with the key or KEYLESS-GO, use the emergency key element.

If you use the emergency key element to unlock and open the boot lid, the anti-theft alarm system will be triggered (▷ page 76).

- ▶ Take the emergency key element out of the key (▷ page 82).
- ▶ Insert the emergency key element into the boot lid lock as far as the stop.



- ▶ Turn the emergency key element anti-clockwise from position **1** as far as it will go to position **2**. The boot is unlocked.
- ▶ Turn the emergency key element back to position **1** and remove it.
- ▶ Insert the emergency key element into the key.

Side windows

Important safety notes

WARNING

Make sure that nobody can become trapped between the side window and the door frame when a side window is opened. Do not touch or lean against the side window during the opening procedure. You could become trapped between the side window and the door frame as the side window moves down. If there is a risk of becoming trapped, release the switch or pull the switch upwards to close the side window again.

WARNING

Make sure that nobody can become trapped as you close a side window. If there is a risk of becoming trapped, release the switch or press it again to open the side window again.

WARNING

Children may injure themselves if they open or close the side windows.

Never leave children unsupervised in the vehicle. Always take the key with you when leaving the vehicle, even if you are only leaving it for a short time.

WARNING

Do not leave children unsupervised in the vehicle, even if they are secured in a child restraint system. The children could:

- be seriously or even fatally injured on parts of the vehicle
- be seriously or even fatally injured by prolonged exposure to extremely high or extremely low temperatures
- press the central unlocking switch and thereby override the child-proof locks and open the door

If children open a door, they could:

- seriously or even fatally injure other people
- get out of the vehicle and injure themselves, or be seriously or even fatally injured by a passing vehicle

Activate the child-proof locks/override feature if children are travelling in the vehicle. They could otherwise open doors or side windows while the vehicle is in motion and thereby injure themselves or others.

Opening and closing the side windows

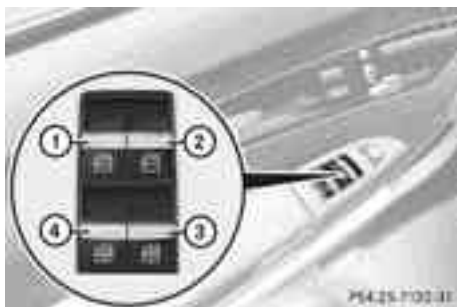

- ① Front left
- ② Front right

- ③ Rear right
- ④ Rear left

The switches for all side windows are located on the driver's door. There is also a switch on each door for the corresponding side window. The switches on the driver's door take precedence.

i The side windows cannot be operated from the rear when the override feature for the side windows is activated (▷ page 68).

► Turn the key to position **1** or **2** in the ignition lock.

► **To open:** press the corresponding switch.

► **To close:** pull the corresponding switch.

i If you press the switch beyond the point of resistance, an automatic opening/closing process is started in the corresponding direction. You can stop automatic operation by pressing again.

i You can continue to operate the side windows after switching off the engine or removing the key. This function remains active for five minutes or until the driver's or front-passenger door is opened.

Sunblinds on the rear side windows

► **To close fully:** pull the corresponding switch when the side window is closed.

► **To open fully:** press the corresponding switch.

i You can use the switches on the rear doors to close the rear roller sunblinds for the opposite side.

Convenience opening feature

You can ventilate the vehicle before you start driving. To do this, the key is used to carry out the following functions simultaneously:



- unlock the vehicle
- open the side windows

- open the sliding sunroof or the panorama sliding sunroof and the roller sunblinds
- switch on the seat ventilation for the driver's seat

i The convenience opening feature can only be operated using the key. The key must be close to the driver's door handle.

- ▶ Point the tip of the key at the driver's door handle.
- ▶ Press and hold the  button until the side windows and the sliding sunroof or the panorama sliding sunroof are in the desired position.

If one of the sunblinds is closed, the sunblind will open first.

- ▶ Press and hold the  button again until the side windows and the sliding sunroof or the panorama sliding sunroof are in the desired position.
- ▶ **To interrupt convenience opening:** release the  button.

Convenience closing feature

General notes

When you lock the vehicle, you can simultaneously:



- close the side windows
- close the sliding sunroof or the panorama sliding sunroof

On vehicles with roller sunblinds, you can then close the roller sunblinds.

WARNING

When using the convenience closing feature, make sure that nobody can become trapped. Proceed as follows if there is a risk of entrapment:

With the key:

- release the  button.
- press and hold the  button until the side windows and the sliding sunroof or the

panorama sliding sunroof and the roller sunblinds open again.

With KEYLESS-GO:

- release the sensor surface on the door handle.
- pull the door handle immediately and hold it.



The side windows and the sliding sunroof or the panorama sliding sunroof and the roller sunblinds open.

Using the key

i The key must be close to the driver's door handle.

- ▶ Point the tip of the key at the driver's door handle.
- ▶ Press and hold the  button until the side windows and the sliding sunroof or the panorama sliding sunroof are fully closed.
- ▶ Make sure that all the side windows and the sliding sunroof or panorama sliding sunroof are closed.

On vehicles with roller sunblinds:

- ▶ Press the  button again until the roller sunblinds close.
- ▶ **To interrupt convenience closing:** release the  button.

Using KEYLESS-GO

The KEYLESS-GO key must be outside the vehicle. All the doors must be closed.



- ▶ Touch recessed sensor surface ① on the door handle until the side windows and the sliding sunroof or the panorama sliding sunroof are fully closed.

i Make sure you only touch recessed sensor surface ①.

- ▶ Make sure that all the side windows and the sliding sunroof or panorama sliding sunroof are closed.

On vehicles with roller sunblinds:

- ▶ Touch the recessed sensor surface on the door handle again until the roller sunblinds close.
- ▶ **To interrupt the roller sunblind closing procedure:** pull the exterior door handle and hold it firmly.

Resetting the side windows

You must reset each side window if:

- a side window cannot be closed automatically
- a side window opens again slightly after being closed manually
- ▶ Close all the doors.
- ▶ Turn the key to position **1** or **2** in the ignition lock.
- ▶ Pull the corresponding switch on the door control panel until the side window is completely closed. (▷ page 92).
- ▶ Hold the switch for an additional second.

If the side window opens again slightly:

- ▶ Immediately pull the corresponding switch on the door control panel until the side window is completely closed (▷ page 92).
- ▶ Hold the switch for an additional second.
- ▶ If the corresponding side window remains closed after the button has been released, the side window has been reset correctly. If this is not the case, repeat the steps above again.

Problems with the side windows

Problem: a side window cannot be closed because it is blocked by objects, e.g. leaves in the window guide.

- ▶ Remove the objects.
- ▶ Close the side window.

Problem: a side window cannot be closed and you cannot see the cause.

WARNING

Closing the side windows with increased force or without the anti-entrapment feature could lead to serious or even fatal injury. Make sure that nobody can become trapped when closing the side windows.

If a side window is obstructed during closing and reopens again slightly:

- ▶ Immediately after the window blocks, pull the corresponding switch again until the side window has closed.
The side window is closed with increased force.

If a side window is obstructed again during closing and reopens again slightly:

- ▶ Immediately after the window blocks, pull the corresponding switch again until the side window has closed.
The side window is closed without the anti-entrapment feature.

Sliding sunroof

Important safety notes

Your vehicle may be fitted with a sliding sunroof or a panorama sliding sunroof. In the following section, the term "sliding sunroof" refers to both types of sliding sunroof.

WARNING

Make sure that nobody can become trapped when opening and closing the sliding sunroof. If there is a risk of entrapment, release the switch immediately. During automatic opera-

tion, push the switch briefly in any direction to stop the sliding sunroof.

WARNING

Children could injure themselves if they operate the sliding sunroof.

Never leave children unsupervised in the vehicle. Always take the key with you when leaving the vehicle, even if you are only leaving it for a short time.

WARNING

The glass in the panorama sunroof could break in an accident. If you are not wearing a seat belt, there is a risk that you could be thrown through the opening in the event of the vehicle overturning. Therefore, always wear a seat belt to reduce the risk of injuries.

! Only open the panorama sliding sunroof if it is free of snow and ice. Otherwise, malfunctions may occur.

Do not allow anything to protrude from the sliding sunroof. Otherwise, the seals could be damaged.

i Resonance noises can occur in addition to the usual airflow noises when the sliding sunroof is open. They are caused by minor pressure fluctuations in the vehicle interior. Change the position of the sliding sunroof or open a side window slightly to reduce or eliminate these noises.

Operating the sliding sunroof

Opening and closing

i You can continue to operate the sliding sunroof after switching off the engine or removing the key. This function remains active for five minutes or until you open a front door.



Overhead control panel

- ① To raise
- ② To open
- ③ To close/lower

► Turn the key to position **1** or **2** in the ignition lock.

► Press or pull the  switch in the corresponding direction.

i If you press the  switch beyond the point of resistance, an automatic opening/closing process is started in the corresponding direction. You can stop automatic operation by pressing again.

When opened automatically, the sliding sunroof opens up to the position in which it was last stopped.

The sun protection cover automatically opens along with the sliding sunroof. You can open or close the sun protection cover manually when the sliding sunroof is raised or closed.

Rain-closing feature

When the key is in position **0** in the ignition lock or is removed, the sliding sunroof closes automatically:

- if it starts to rain
- at extreme outside temperatures
- after six hours
- if there is a malfunction in the power supply

The rear of the sliding sunroof is then raised in order to ventilate the vehicle interior.

i If the sliding sunroof is obstructed when being closed by the rain-closing feature, it

opens again slightly. The rain-closing feature is then deactivated.

The sliding sunroof does not close if:

- it is raised at the rear.
- it is blocked.
- no rain is falling on the area of the wind-screen being monitored by the rain sensor, e.g. because the vehicle is under a bridge.

Resetting

Reset the sliding sunroof if it does not move smoothly.

- ▶ Turn the key to position **2** in the ignition lock.
- ▶ Raise the sliding sunroof fully at the rear (▷ page 95).
- ▶ Keep the  switch pressed for another second.
- ▶ Make sure that the sliding sunroof can be fully opened and closed again (▷ page 95).
- ▶ If this is not the case, repeat the steps above again.

! If the sliding sunroof still cannot be opened or closed fully after resetting, contact a qualified specialist workshop.

Operating the panorama sliding sunroof

Opening and closing

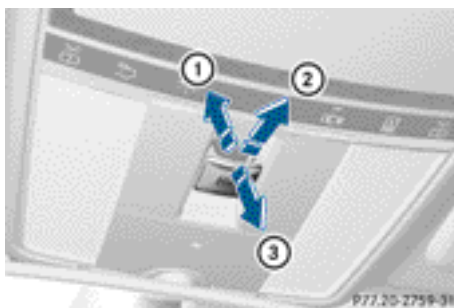

Overhead control panel

- ① To raise
- ② To open
- ③ To close/lower

- ▶ Turn the key to position **1** or **2** in the ignition lock.
- ▶ Push or pull the  switch in the corresponding direction.

i If you press the  switch beyond the point of resistance, an automatic opening/closing process is started in the corresponding direction. You can stop automatic operation by pressing again.

Rain closing feature

When the key is in position **0** in the ignition lock or is removed, the panorama sliding sunroof closes automatically:

- if it starts to rain
- at extreme outside temperatures
- after six hours
- if there is a malfunction in the power supply

The panorama sliding sunroof remains raised at the rear in order to allow ventilation of the vehicle interior.

i If the panorama sliding sunroof is obstructed when being closed by the rain closing feature, it opens again slightly. The rain closing feature is then deactivated.

The panorama sliding sunroof does not close if:

- it is raised at the rear.
- it is blocked.
- no rain is falling on the area of the wind-screen being monitored by the rain sensor, e.g. because the vehicle is under a bridge.

Operating the panorama sliding sunroof roller sunblinds

General notes

The roller sunblinds shield the vehicle interior from sunlight.

WARNING

Make sure that nobody can become trapped as you open or close the roller sunblinds. If there is a risk of entrapment, release the switch and press the opening switch.

Operating the front roller sunblind

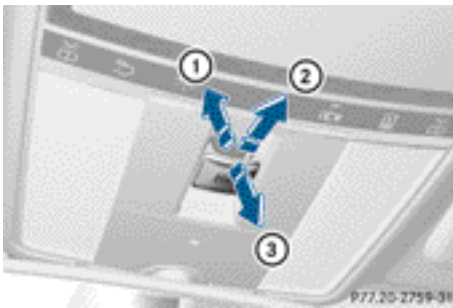

Overhead control panel

- ① To open
- ② To open
- ③ To close

i The front roller sunblind can only be closed when the panorama sliding sunroof is closed.

- ▶ Turn the key to position **1** or **2** in the ignition lock.
- ▶ Press or pull the  switch in the corresponding direction.

i When you open the roller sunblind in the direction of arrow **①**, the panorama sliding sunroof is raised at the rear after the opening procedure.

Operating the rear roller sunblind

Operating from the front



Overhead control panel

- ▶ **To open or close:** press button **①**.
The rear roller sunblind opens or closes fully.
- ▶ **To stop:** press button **①** again.

i You must first open or close the rear roller sunblind fully before you can move it in the other direction.

Operating from the rear compartment



Door control panel in rear





- ▶ **To open/close manually:** press or pull switch **①** to the point of resistance and

hold it until the rear roller sunblind has reached the desired position.

- ▶ **To open/close fully:** press or pull switch ① beyond the point of resistance and release it.

Resetting the panorama sliding sunroof or the front roller sunblind

Reset the panorama sliding sunroof or the front roller sunblind if the panorama sliding sunroof or the roller sunblinds does not move smoothly.

- ▶ Turn the key to position **1** or **2** in the ignition lock.
- ▶ Pull the  switch repeatedly to the point of resistance in the direction of arrow ③ (▷ page 96) until the panorama sliding sunroof is fully closed.
- ▶ Keep the  switch pulled for an additional second.
- ▶ Pull the  switch in the direction of arrow ③ (▷ page 97) repeatedly until the front roller sunblind is closed.
- ▶ Keep the  switch pulled for an additional second.
- ▶ Make sure that the panorama sliding sunroof (▷ page 96) and the front roller sunblind (▷ page 97) can be fully opened again.
- ▶ If this is not the case, repeat the steps above again.

Resetting the rear sunblind



Door control panel in rear

- ▶ Turn the key to position **1** or **2** in the ignition lock.
- ▶ Pull switch ① repeatedly until the rear roller sunblind is fully closed.
- ▶ Keep switch ① pulled for an additional second.
- ▶ Make sure that the rear roller sunblind can be opened fully again (▷ page 97).
- ▶ If this is not the case, repeat the steps above again.

Problems with the sliding sunroof

Your vehicle may be fitted with a sliding sunroof or a panorama sliding sunroof. In the following section, the term "sliding sunroof" refers to both types of sliding sunroof.

Problem: the sunroof cannot be closed and you cannot see the cause.

WARNING

You could be severely or even fatally injured when closing the sliding sunroof with increased closing force or if the anti-entrapment feature is deactivated. Make sure that nobody can become trapped when closing the sliding sunroof.

If the sliding sunroof is obstructed during closing and reopens again slightly:

- ▶ Immediately after the sliding sunroof blocks, pull the  switch in the overhead control panel down to the point of resistance and hold it until the sliding sunroof is closed.
The sliding sunroof is closed with increased force.

If the sliding sunroof is obstructed again during closing and reopens again slightly:

- ▶ Immediately after the sliding sunroof blocks, pull the  switch in the overhead control panel down to the point of

resistance and hold it until the sliding sunroof is closed.

The sliding sunroof is closed without the anti-entrapment feature.

Useful information	102
Correct driver's seat position	102
Seats	103
Steering wheel	109
Mirrors	111
Memory function	113

Useful information

i This Owner's Manual describes all models and all standard and optional equipment available to your vehicle at the time of publication of the Owner's Manual. Country-specific deviations are possible. Please note that your vehicle may not be equipped with all features described. This also applies to safety-relevant systems and functions.

i Please read the information on qualified specialist workshops (▷ page 32).

Correct driver's seat position



Observe the safety guidelines on seat adjustment (▷ page 103).

► Make sure that seat ③ is adjusted properly.

Electrical seat adjustment (▷ page 104)

When adjusting the seat, make sure that:

- you are as far away from the driver's airbag as possible.
- you are sitting in a normal upright position.

- you can fasten the seat belt properly.
- you have moved the backrest to an almost vertical position.
- you have set the seat angle so that your thighs are gently supported.
- you can depress the pedals properly.

► Check whether the head restraint is adjusted properly (▷ page 106).

When doing so, make sure that you have adjusted the head restraint so that the back of your head is supported at eye level by the centre of the head restraint.

Observe the safety guidelines on steering wheel adjustment (▷ page 109).

► Make sure that steering wheel ① is adjusted properly.

Adjusting the steering wheel electrically (▷ page 110)

When adjusting the steering wheel, make sure that:

- you can hold the steering wheel with your arms slightly bent.
- you can move your legs freely.
- you can see all the displays in the instrument cluster clearly.

Observe the safety guidelines for seat belts (▷ page 55).

► Check whether you have fastened seat belt ② properly (▷ page 57).

The seat belt should:

- fit snugly across your body
- be routed across the middle of your shoulder
- be routed in your pelvic area across the hip joints

► Before starting off, adjust the rear-view mirror and the exterior mirrors (▷ page 111) in such a way that you have a good view of road and traffic conditions.

► **Vehicles with a memory function:** save the seat, steering wheel and exterior mirror settings (▷ page 113).

Seats

Important safety notes

 **WARNING**

The seats can still be adjusted when there is no key in the ignition lock. For this reason, children should never be left unsupervised in the vehicle. They could adjust the seats and become trapped.

 **WARNING**

Only adjust the driver's seat when the vehicle is stationary. You will otherwise be distracted from the road and traffic conditions and you could lose control of the vehicle as a result of the seat moving. This could cause an accident.

 **WARNING**

If you adjust the seat height carelessly, you or others could be trapped and thereby injured. Children in particular could unintentionally press the buttons to electrically adjust the seats and become trapped.

Take care that:

- while moving the seats, your hands do not get under the lever assembly of the seat adjustment system.
- children in the vehicle do not slide their hands under the levers.

 **WARNING**

Make sure that nobody can become trapped when adjusting the seats.

Observe the notes on airbags.

Secure children as recommended; see the "Children in the vehicle" section.

 **WARNING**

Make sure that the back of your head is supported at eye level by the central area of the head restraint. If your head is not supported correctly by the head restraint, you could suffer a severe neck injury in the event of an

accident. Never drive if the head restraints are not engaged and set correctly.

 **WARNING**

Occupants should only travel sitting on seats which have the head restraints fitted. On a seat which is occupied, move the head restraint into the upright position. This reduces the risk of injury to the passenger in the event of an accident.

 **WARNING**

Make sure that nobody can become trapped when folding the head restraints up or back.

 **WARNING**

A seat belt can only offer its intended degree of protection when the backrest is almost vertical and the occupant is sitting upright. Avoid seat positions that do not allow the seat belt to be routed correctly. Adjust the backrest so that it is as upright as possible. Never travel with the backrest reclined too far backwards. You could otherwise be seriously or even fatally injured in the event of an accident or sudden braking.

 To avoid damage to the seats and the seat heating, observe the following information:

- do not spill any liquids on the seats. If liquid is spilled on the seats, dry them as soon as possible.
- if the seat covers are damp or wet, do not switch on the seat heating. The seat heating should also not be used to dry the seats.
- clean the seat covers as recommended; see the "Interior care" section.
- do not transport heavy loads on the seats. Do not place sharp objects on the seat cushions, e.g. knives, nails or tools. The seats should only be occupied by passengers, if possible.
- when the seat heating is in operation, do not cover the seats with insulating mate-

rials, e.g. blankets, coats, bags, seat covers, child seats or booster seats.

! Make sure that there are no objects in the footwell or behind the seats when moving the seat back. There is a risk that the seats and/or the objects could be damaged.

i The head restraints in the front seats are fitted with the NECK-PRO system. For this reason, it is not possible to remove the head restraints from the front seats.

For design reasons, the rear-compartment head restraints cannot be removed.

For more information, contact a qualified specialist workshop.

Adjusting the seat



- ① Head restraint height
- ② Seat height
- ③ Seat cushion angle
- ④ Seat cushion length
- ⑤ Seat fore-and-aft adjustment
- ⑥ Backrest angle

i If PRE-SAFE® has been activated, the front-passenger seat and the electrically adjustable rear seats are moved into a more favourable position.

i You can store the seat settings using the memory function (▷ page 113).

i When the key is in position **1** or **2** in the ignition lock, the front-passenger seat head restraint is lowered if:

- the front-passenger seat belt is not engaged.
- no occupant is detected on the front-passenger seat.
- the vehicle is stationary.

When the key is in position **1** or **2** in the ignition lock: if the front-passenger seat belt is engaged or if an occupant is detected on the front-passenger seat, the front-passenger seat head restraint moves back to the original position.

i To ensure the largest possible range of seat settings, certain seat adjustment functions will automatically activate other seat adjustment functions.

i Depending on the seat fore-and-aft setting, the head restraint height is adjusted automatically.

Adjusting the rear seat electrically

You can only adjust the outer seats in the rear electrically.

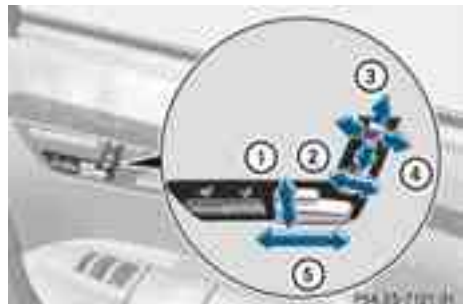

- ① Seat cushion angle
- ② Backrest angle
- ③ Folding the head restraint up or back
- ④ Head restraint angle
- ⑤ Seat fore-and-aft adjustment

Adjusting the front-passenger seat from the driver's seat

⚠ WARNING

When adjusting a front-passenger seat that is occupied, make sure that it is as far away from the front-passenger airbag as possible. The front passenger could otherwise sustain serious or fatal injuries in the event of an accident or braking manoeuvre.

Make sure that nobody can become trapped when adjusting the seat.

The front-passenger seat can be adjusted when there is no key in the ignition lock. For this reason, children should never be left unsupervised in the vehicle. They could become trapped if the seats move.

- !** Do not move the front-passenger seat fully forwards if there are objects in the luggage net in the front-passenger footwell. The objects could otherwise be damaged.

You can use the seat switches on the driver's side to adjust the front-passenger seat.



► **To activate/deactivate:** press button ①.

If the indicator lamp in button ① is lit, you can access the following functions for the front-passenger seat:

- seat adjustment
- seat heating/ventilation
- memory function

Adjusting the front-passenger seat from the rear

⚠ WARNING

When adjusting a front-passenger seat that is occupied, make sure that it is as far away from the front-passenger airbag as possible. The front passenger could otherwise sustain serious or fatal injuries in the event of an accident or braking manoeuvre.

Make sure that nobody can become trapped when adjusting the seat.

The front-passenger seat can be adjusted when there is no key in the ignition lock. For this reason, children should never be left unsupervised in the vehicle. They could become trapped if the seats move.

- !** Do not move the front-passenger seat fully forwards if there are objects in the luggage net in the front-passenger footwell. The objects could otherwise be damaged.

You can use the override button to disable this function (▷ page 67).

The button is located in the rear door on the front-passenger side.

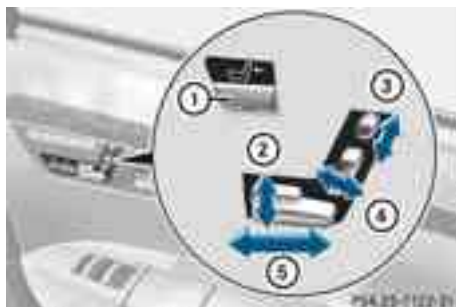

- ① To select the front-passenger seat or rear-compartment seat
- ② Seat height
- ③ Head restraint height
- ④ Backrest angle
- ⑤ Seat fore-and-aft adjustment

- ▶ **To select the front-passenger seat:**
press button ①.
The front-passenger seat is selected if the indicator lamp in the button lights up.
- ▶ Adjust the front-passenger seat with buttons ②, ③, ④ and ⑤.
- ▶ **To select the rear-compartment seat:**
press button ①.
The rear-compartment seat is selected again.

Adjusting the head restraints

Adjusting the head restraints electrically

- ▶ **To adjust the head restraint height:** slide the switch for head restraint adjustment (> page 104) up or down in the direction of the arrow.

Adjusting the NECK-PRO head restraints

Adjusting



- ▶ Pull or push the bottom of NECK-PRO head restraint ①.

Resetting

The NECK-PRO head restraints are moved forwards in the event of a rear collision in the direction of travel and have to be reset afterwards (> page 54).

Adjusting the NECK-PRO luxury head restraints

Adjusting

⚠ WARNING

When folding back the side cushions, do not hold the area between the side cushion and the cushion holder. There is a danger of becoming trapped.



You can adjust side bolsters ① of the NECK-PRO luxury head restraints individually.

- ▶ **To adjust the side bolsters of the head restraint:** push or pull side bolsters ① into the desired position.
- ▶ **To move forwards and backwards:** pull or push the NECK-PRO luxury head restraints in the direction of arrow ②.

Resetting

The NECK-PRO luxury head restraints are moved forwards in the event of a rear collision in the direction of travel and have to be reset afterwards (> page 54).

Rear seat head restraints

Folding back the rear seat head restraints from the front



- ▶ Make sure that the key is in position 1 or 2 in the ignition lock.
- ▶ Press button ①.

Folding the rear seat head restraints into position electrically (outer head restraints)

- ▶ Press and hold button ① until the head restraints have folded into position.
- i** If a rear-seat passenger inserts the seat belt into the buckle, the head restraint on the corresponding outer seat folds up automatically.

Folding the rear seat head restraints into position manually

Only the centre rear seat head restraint can be folded into position manually.



- ▶ Pull the head restraint up until it engages.

Adjusting the luxury head restraints in the rear compartment

WARNING

When folding back the head restraint side bolsters, do not put your hands between the side bolster and the cushion holder. There is a danger of becoming trapped.



You can adjust side bolsters ① of the luxury head restraint individually.

- ▶ **To adjust the side bolsters of the head restraint:** push or pull side bolsters ① into the desired position.
- ▶ **To adjust the head restraint angle:** hold the head restraint by the upper edge and slide it forwards or back in the direction of arrow ②.

Adjusting the multicontour seat

You can adjust the multicontour seat using COMAND (▶ page 284).

Adjusting the multicontour seat in the rear compartment

You can use the buttons on the centre console to adjust the multicontour seats for the outer seats in the rear compartment.



- ▶ **To select a rear-compartment seat:** push or pull rocker switch ① or ⑦ forwards or backwards.
The indicator lamp in the selected button lights up briefly.
- ▶ **To adjust the side bolsters of the seat backrest:** push or pull rocker switch ⑥ forwards or backwards.
- ▶ **To adjust the backrest contour:** push or pull rocker switch ⑤ forwards or backwards.
- ▶ **To adjust the position of the backrest contour:** push or pull rocker switch ④ forwards or backwards.
- ▶ **To activate/deactivate the gentle massage function:** push or pull rocker switch ③ forwards or backwards.
- ▶ **To activate/deactivate the strong massage function:** push or pull rocker switch ② forwards or backwards.

Adjusting the active multicontour seat

You can adjust the active multicontour seat using COMAND (▷ page 286).

- ❗ If PRE-SAFE® has been activated, the air pressure in the air chambers of the multicontour seat or active multicontour seat is increased. These air chambers are located in the side bolsters of the seat cushion and backrest.

Adjusting the lumbar support

You can adjust the lumbar support using COMAND (▷ page 283).

Switching the seat heating on/off

Switching on/off

⚠ WARNING

Repeatedly setting the seat heating to level **3** may result in excessive seat temperatures. The health of passengers that have limited temperature sensitivity or a limited ability to react to excessively high temperatures may be affected or they may even suffer burn-like injuries. Therefore, do not use seat heating level **3** repeatedly.

The three red indicator lamps in the button indicate the heating level you have selected.

- ❗ If the battery voltage is too low, the seat heating may switch off.



The system automatically switches down from level **3** to level **2** after approximately eight minutes.

The system automatically switches down from level **2** to level **1** after approximately ten minutes.

The system automatically switches off approximately 20 minutes after it is set to level **1**.

- ▶ Make sure that the key is in position 1 or 2 in the ignition lock.
- ▶ **To switch on:** press button ① repeatedly until the desired heating level is set.
- ▶ **To switch off:** press button ① repeatedly until all the indicator lamps go out.

Problems with the seat heating

The seat heating has switched off prematurely. The vehicle's electrical system voltage is too low because too many electrical consumers are switched on.

- ▶ Switch off electrical consumers that you do not need, such as the rear window heating or interior lighting.

tilation of the driver's seat automatically switches to the highest level.

- ▶ **To switch off:** press button ① repeatedly until all the indicator lamps go out.

Problems with the seat ventilation

The seat ventilation has switched itself off prematurely. The vehicle's electrical system voltage is too low because too many electrical consumers are switched on.

- ▶ Switch off electrical consumers which you do not need, such as the rear window heating or interior lighting.

Switching the seat ventilation on/off

Switching on/off

The three blue indicator lamps in the buttons indicate the ventilation level you have selected.

- ① If the battery voltage is too low, the seat ventilation may switch off.



- ▶ Make sure that the key is in position 1 or 2 in the ignition lock.
- ▶ **To switch on:** press button ① repeatedly until the desired ventilation level is set.
- ① You can open the side windows and the sliding sunroof using the "Convenience opening" feature (▷ page 92). The seat ven-

Steering wheel

Important safety notes

⚠ WARNING

The electrically adjustable steering wheel can still be adjusted when there is no key in the ignition lock. Therefore, do not leave children unsupervised in the vehicle, as they could become trapped if the steering wheel is adjusted.

⚠ WARNING

Only adjust the steering wheel when the vehicle is stationary and do not pull away until the steering wheel adjustment mechanism is locked in position. You might otherwise drive without the steering wheel adjustment mechanism being locked in position. As a result, you could be distracted from road and traffic conditions by an unintentional movement of the steering wheel and thereby cause an accident.

However, the steerability of the vehicle is not affected.

Adjusting the steering wheel



- ① To adjust the steering wheel position (fore-and-aft adjustment)
- ② To adjust the steering wheel height

i Related topics:

- EASY-ENTRY/EXIT feature (▷ page 110)
- Storing settings (▷ page 113)
- Operating the on-board computer (▷ page 393)

Steering wheel heating

Switching on/off



- ▶ Make sure that the key is in position **2** in the ignition lock.
- ▶ **To switch on/off:** turn the lever in the direction of arrow ① or ②. Indicator lamp ③ lights up or goes out.

i The steering wheel heating is switched off automatically after about 24 minutes.

EASY-ENTRY/EXIT feature

Important safety notes

The EASY-ENTRY/EXIT feature makes getting in and out of your vehicle easier.

You can activate and deactivate the EASY-ENTRY/EXIT feature using COMAND (▷ page 274).

⚠ WARNING

Make sure that nobody can become trapped when you activate the EASY-ENTRY/EXIT feature.

If there is a risk of entrapment by the steering column, move the steering wheel adjustment lever or press the position button of the memory function.

If there is a risk of entrapment by the seat, you can also cancel the adjustment procedure by moving the switch for seat adjustment. The steering column and driver's seat stop moving immediately.

Never leave children unsupervised in the vehicle. They could open the driver's door and thereby unintentionally activate the EASY-ENTRY/EXIT feature and become trapped.

! Do not activate the EASY-ENTRY/EXIT feature, if the seat backrest is reclined too far backwards. This can damage the front or rear seats. You must first move the backrest to a vertical position.

Position of the steering wheel and the driver's seat when the EASY-ENTRY/EXIT feature is active

The steering wheel tilts upwards and the driver's seat moves backwards if you:

- remove the key from the ignition lock
- open the driver's door when the key is in the ignition lock or KEYLESS-GO is in position **1**

i The steering wheel only moves upwards if it has not already reached the upper end stop. The driver's seat only moves back-

wards if it is not already in the rearmost position.

Position of the steering wheel and the driver's seat for driving

If you insert the key into the ignition lock with the driver's door closed, depending on the setting, the position of the steering wheel and the driver's seat will be changed to the previously set position.

The last position of the steering wheel or seat is stored if:

- the ignition is switched off or
- the setting is stored with the memory function.

Crash-responsive EASY-EXIT feature

If the crash-responsive EASY-EXIT feature is triggered in an accident, the steering column will move upwards when the driver's door is opened. This occurs irrespective of the position of the key in the ignition lock. This makes it easier to exit the vehicle and rescue the occupants.

The crash-responsive EASY-EXIT feature is only operational if the EASY-EXIT/ENTRY feature is activated in the on-board computer.

Mirrors

Exterior mirrors

Adjusting the exterior mirrors

WARNING

The exterior mirrors reduce the size of the image. Objects are actually closer than they appear. You could misjudge the distance from vehicles driving behind and cause an accident, e.g. when changing lane. For this reason, make sure of the actual distance from the vehicle driving behind by glancing over your shoulder.

The convex exterior mirrors provide a larger field of vision.

The exterior mirrors are automatically heated if the rear window heating is switched on and the outside temperature is low.

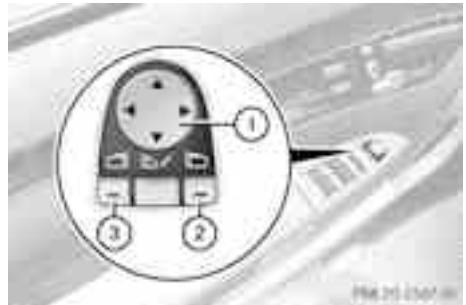

- ▶ Make sure that the key is in position 1 or 2 in the ignition lock.
- ▶ Press button ② for the right-hand exterior mirror or button ③ for the left-hand exterior mirror. The indicator lamp lights up in the button that has been pressed.
- ▶ Press adjustment button ① up, down, to the left or right until you have adjusted the exterior mirror to the correct position. You should have a good overview of traffic conditions.

Folding the exterior mirrors in or out electrically



- ▶ Make sure that the key is in position 1 or 2 in the ignition lock.
- ▶ Briefly press button ①. Both exterior mirrors fold in or out.

- i** Make sure that the exterior mirrors are always folded out fully while driving. They could otherwise vibrate.

Folding the exterior mirrors in or out automatically

When the "Automatic mirror folding" function is activated in COMAND (▷ page 274):

- the exterior mirrors fold in automatically as soon as you lock the vehicle from the outside.
- the exterior mirrors fold out again automatically as soon as you unlock the vehicle and then open the driver's or front-passenger door.

- i** If the exterior mirrors have been folded in manually, they do not fold out.

Exterior mirror out of position

If an exterior mirror has been pushed out of position, proceed as follows:

- ▶ Press the mirror-folding button (▷ page 111) repeatedly until you hear the mirror engage in position. The mirror housing is engaged again and you can adjust the exterior mirrors as usual (▷ page 111).

Automatic anti-dazzle mirrors

⚠ WARNING

If incident light from headlamps is prevented from striking the sensor in the rear-view mirror, for instance, by luggage piled too high in the vehicle, the mirror's automatic anti-dazzle function will not operate.

Incident light could then blind you. This may distract you from the traffic conditions and, as a result, you may cause an accident.

The rear-view mirror and the exterior mirror on the driver's side automatically go into anti-dazzle mode if the ignition is switched on and

incident light from headlamps strikes the sensor in the rear-view mirror.

The mirrors do not go into anti-dazzle mode if reverse gear is engaged or the interior lighting is switched on.

Parking position for the exterior mirror on the front-passenger side

Setting and storing the parking position

You can position the front-passenger side exterior mirror in such a way that you can see the rear wheel on that side as soon as you engage reverse gear. You can store this position.



- ▶ Make sure that the vehicle is stationary and that the key is in position **2** in the ignition lock.
- ▶ Press button **3** for the exterior mirror on the front-passenger side.
- ▶ Engage reverse gear. The exterior mirror on the front-passenger side moves to the preset parking position.
- ▶ Use adjustment button **2** to adjust the exterior mirror. You should see the rear wheel and the kerb in the exterior mirror. The parking position is stored.

- i** If you shift the transmission to another position, the exterior mirror on the front-passenger side returns to the driving position.

- i** You can also store the parking position using memory button **M 1**.

- ▶ Make sure that the key is in position **2** in the ignition lock.
- ▶ With the exterior mirror on the front-passenger side activated, use adjustment button **(2)** to adjust the exterior mirror. You should see the rear wheel and the kerb in the exterior mirror on the front-passenger side.
- ▶ Press memory button **M** **(1)** and one of the arrows on adjustment button **(2)** within three seconds.
The parking position is stored if the exterior mirror does not move.

If the mirror moves out of position, repeat the steps.

Calling up a stored parking position setting

- ▶ Turn the key to position **2** in the ignition lock.
- ▶ Adjust the exterior mirror on the front-passenger side with the corresponding button (▷ page 111).
- ▶ Engage reverse gear.
The exterior mirror on the front-passenger side moves to the stored parking position.

The exterior mirror on the front-passenger side moves back to its original position:

- as soon as you exceed a speed of 15 km/h
- about ten seconds after you have disengaged reverse gear
- if you press button **(4)** for the exterior mirror on the driver's side

Memory function

Storing settings

WARNING

The memory function can still be used when the key has been removed. For this reason, children should never be left unsupervised in the vehicle. They could otherwise become

trapped when adjusting the seat or the steering wheel.

WARNING

Only use the memory function on the driver's side when the vehicle is stationary. You could otherwise be distracted from the traffic conditions by the steering wheel and seat moving of their own accord, and as a result, cause an accident.

With the memory function, you can store up to three different settings, e.g. for three different people.

The following settings are stored as a single memory preset:

- seat, backrest, head restraint position and contour of the backrest in the lumbar region
- active multicontour seat: activated/deactivated
- multicontour seat: the side bolsters of the seat cushion and the backrest as well as the contour of the backrest in the lumbar and shoulder regions
- driver's side: steering wheel position
- driver's side: position of the exterior mirrors on the driver's and front-passenger sides



- ▶ Adjust the seat (▷ page 104).
- ▶ On the driver's side, adjust the steering wheel (▷ page 110) and the exterior mirrors (▷ page 111).
- ▶ Briefly press the **M** memory button and then press storage position button **1, 2** or

3 within three seconds until you hear an acknowledgement tone.

The settings are stored in the selected storage position.

Calling up a stored setting

- ▶ Press and hold the relevant storage position button **1**, **2** or **3** until the seat, steering wheel and exterior mirrors are in the stored position.

i If you release the storage position button, the seat, steering wheel and mirror setting functions stop immediately. The multicon-tour seat setting or lumbar support adjustment is still carried out.

Useful information	116
Introduction	116
At a glance	117
System settings	143
Navigation	151
Telephone	192
Audio	217
Video	242
Rear Seat Entertainment System	254
Vehicle	272

Useful information

- i** This Owner's Manual describes all models and all standard and optional equipment available to your vehicle at the time of publication of the Owner's Manual. Country-specific deviations are possible. Please note that your vehicle may not be equipped with all features described. This also applies to safety-relevant systems and functions.
- i** Please read the information on qualified specialist workshops (▷ page 32).

Introduction

Operating safety

Important safety notes

WARNING

Your attention must always be focused on the traffic conditions.

Only use COMAND or the telephone when the road and traffic conditions permit.

Bear in mind that, at a speed of only 50 km/h, your vehicle covers a distance of nearly 14 m per second. The navigation system will not provide you with information about stop signs, give-way signs, traffic regulations or road safety features. It is up to you to pay attention to these while driving the vehicle. Only enter a new destination when the vehicle is stationary.

WARNING

Vehicles with HYBRID: ensure that you read the "HYBRID" supplement. You may otherwise fail to recognise dangers.

There is a radio included in the audio function of COMAND.

This radio can be operated by anyone in accordance with the relevant EC directive.

The device conforms to currently applicable harmonised standards.

Therefore, adherence to the relevant specifications for electromagnetic compatibility is guaranteed for this device.

As a result, interference caused by your equipment to other electrical/electronic equipment can be largely prevented. Interference to your equipment caused by other electrical/electronic equipment can also be largely prevented.

The equipment is approved by the vehicle manufacturer in accordance with European Automotive EMC Directive 95/54/EC. Operation according to its intended purpose is thus approved for your vehicle. The equipment does not require certification.

The equipment conforms to the relevant equipment-specific EMC specifications in accordance with the following European standards:

EN 55013

EN 55020

Declarations of conformity

Wireless vehicle components

The following information applies to all components of the vehicle and of COMAND which receive and/or transmit radio waves: the components of this vehicle that receive and/or transmit radio waves are compliant with the basic requirements and all other relevant conditions of Directive 1999/5/EC. You can obtain further information from a Mercedes-Benz Service Centre.

Electromagnetic compatibility

The electromagnetic compatibility of the vehicle components has been tested and approved in accordance with Directive 72/245/EEC or the equivalent ECE-R 10 regulation, in their current respective valid version.

Correct use

Observe the following information when using COMAND:

- the safety notes in this manual
 - national road traffic regulations
- i** Improper work on electronic components or other systems (e.g. radio, DVD changer) and their software may result in malfunction or failure. Even systems that have not been modified could be affected because the electronic systems are connected. Electronic malfunctions can seriously jeopardise the operational safety of your vehicle.
- i** Only have work or changes to electronic components carried out at a qualified specialist workshop.
- i** Protection against theft: this device is equipped with technical provisions to protect it against theft. You can obtain further information about protecting against theft from a qualified specialist workshop.

Function restrictions

For safety reasons, some COMAND functions are restricted or unavailable while the vehicle is in motion. You will notice this, for example, because you will not be able to select certain menu items. In some cases, COMAND will also display a message to this effect.

To protect the integrated hard drive against damage, COMAND deactivates it at very high temperatures. The following functions will be temporarily unavailable:

- Navigation
- LINGUATRONIC
- Address book
- MUSIC REGISTER

At a glance

COMAND operating system

Overview



	Function	Page
①	COMAND display	123
②	COMAND controller and function buttons	118
③	Telephone keypad	120

Components of COMAND

COMAND consists of:

- the COMAND display/SPLITVIEW
- the single DVD drive or DVD changer
- the COMAND controller
- the COMAND function buttons

- the telephone keypad
- connections in the glove compartment (USB, additional USB, jack plug and iPod® connection)
- a remote control for the front passenger and for use with the Rear Seat Entertainment System
- two sets of cordless headphones for the Rear Seat Entertainment System
- cordless headphones for the front passenger
- two screens (Rear Seat Entertainment System)
- CD/DVD drive (Rear Seat Entertainment System)
- audio/video connections on the screen (Rear Seat Entertainment System)
- audio/video connections on the drive (Rear Seat Entertainment System)

You can use COMAND to operate the following main functions:

- the navigation system
- the audio function in the following modes: radio and DAB radio mode, disc (audio CD/DVD and MP3 mode), memory card (MP3 mode), MUSIC REGISTER, Bluetooth® audio, Media Interface and audio AUX
- the telephone with text message function and the address book
- the video function in TV, video DVD and video AUX modes
- the system settings

You can call up the main functions:

- using the corresponding function buttons or
- using the main function bar in the COMAND display

COMAND controller

You can use the COMAND controller to select the menu items in the COMAND display.

You can call up menus or lists, scroll through menus or lists and exit menus or lists.



The COMAND controller can be:

- pressed briefly or pressed and held
- turned clockwise or anti-clockwise
- slid left or right
- slid forwards or back
- slid diagonally

In the instructions, operating sequences are described as follows:

- ▶ Press the button.
Audio mode is activated.
- ▶ Select **Audio** by sliding and turning the COMAND controller and press to confirm.
The audio menu appears.

Back button



- ① Back button

- ▶ **To exit the menu:** press back button ① briefly.
COMAND changes to the next higher menu level in the current operating mode.

i You can also exit a menu by sliding \leftarrow \odot \rightarrow or \uparrow \odot \downarrow the COMAND controller.

► **To switch to the basic display:** press and hold back button ①.

COMAND changes to the basic display of the current operating mode.

Function buttons

The COMAND function buttons allow you to select a main function directly.

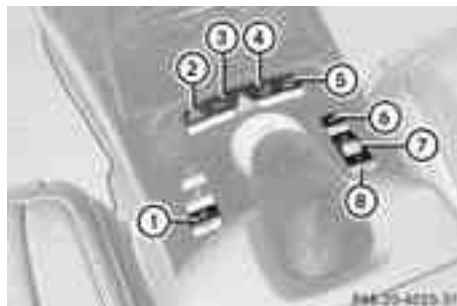

- ① Function button for roller sunblind
- ② Function button for radio and CD/DVD or SD card
- ③ Back button
- ④ Lumbar support/multicontour seat
- ⑤ Function button for telephone and navigation system
- ⑥ On/off button for COMAND
- ⑦ Volume control
- ⑧ Programmable button (► page 119)

Example:

► **To select the radio or CD menu directly:** press $\boxed{\text{DISC RADIO}}$ button ② once or twice.

Assigning the programmable button (favourites)





① Programmable button

You can assign the following predefined functions to the $\boxed{*}$ programmable button:

- **ECO:** you can activate or deactivate the ECO start/stop function.
 - **Message, driver's seat:** you can switch the massage function for the driver's seat on and off.
 - **Message, front passenger's seat:** you can switch the massage function for the front-passenger seat on and off.
 - **Message, driver's and front passenger's seat:** you can switch the massage function for the driver's and front-passenger seats on and off.
 - **Display off:** you can switch the COMAND display off or on.
 - **Tow-away protection:** you can prime or deactivate tow-away protection.
 - **Interior motion sensor:** you can prime or deactivate the interior motion sensor.
 - **Tow-away protection / interior motion sensor:** you can prime or deactivate tow-away protection and the interior motion sensor.
 - **Repeat navigation command:** you can have the most recent recommendation by the navigation system repeated.
- **To assign the programmable button:** select **Vehicle** by sliding \odot \downarrow and turning

🔑 the COMAND controller and press  to confirm.

- ▶ Select **System** and press  to confirm.
- ▶ Select **Favourites button** and press  to confirm.

The list of predefined functions appears.
The  dot in front of the list entry indicates the current setting.

- ▶ **To change the setting:** turn 🔑 the COMAND controller and select the desired function.
- ▶ **To store the setting and exit the menu:** press  the COMAND controller.

Telephone keypad



- ① Telephone keypad
- ② Folding cover

COMAND display

General notes

! Do not use the space in front of the display for storage. Objects placed here could damage the display or impair its function. Avoid any direct contact with the display surface. Pressure on the display surface may result in impairments to the display, which could be irreversible.

Wearing polarised sunglasses may impair your ability to read the display.

The display has an automatic temperature-controlled switch-off feature. The screen's brightness dims automatically if the display overheats. The display may temporarily switch off completely.

Display overview

The COMAND display shows the function currently selected and its associated menus. The COMAND display is divided into several areas.

The radio display is shown in the example.



- ① Status bar
- ② To call up the audio menu
- ③ Main function bar
- ④ Display/selection window
- ⑤ Radio menu bar
- ⑥ Air-conditioning function bar

Status bar ① shows the current settings for radio and telephone operation.

The main functions navigation, audio, telephone and video feature additional menus. This is indicated by triangle ②. The following table lists the available menu items.

Main function bar ③ allows you to call up the desired main function.

In the example, the Audio main function is set to radio mode and display/selection window ④ is active.

Radio menu bar ⑤ allows you to operate the radio functions.

The air-conditioning functions can be operated in air-conditioning function bar ⑥.

Menu overview

The table lists the menus available after calling up the main navigation, audio, telephone, video or system function in the main function bar.

Navi	Audio	Telephone	Video	Vehicle
Mode	Radio (including DAB radio)	Telephone on	TV	ECO
Map orientation	Disc	Telephone off	Video DVD	Multicontour seat/lumbar settings
Special destination symbols on the map	Memory card		AUX	Rear window blind
Text information on map	MUSIC REGISTER		Video off	EASY-ENTRY/EXIT system
<input checked="" type="checkbox"/> Speed Limit Assist	Media Interface			Exterior lighting delayed switch-off time
<input checked="" type="checkbox"/> Topographical map	USB			Interior lighting delayed switch-off
<input checked="" type="checkbox"/> Town view	Rear			Ambient lighting
<input checked="" type="checkbox"/> Motorway information	AUX			<input checked="" type="checkbox"/> Automatic mirror fold-in function
<input checked="" type="checkbox"/> Automatic reading aloud of traffic reports	Audio off			<input checked="" type="checkbox"/> Locator lighting
<input checked="" type="checkbox"/> Volume limiter				<input checked="" type="checkbox"/> Automatic locking
Map version				<input checked="" type="checkbox"/> Interior motion sensor

Navi	Audio	Telephone	Video	Vehicle
				<input checked="" type="checkbox"/> Tow-away protection
				<input checked="" type="checkbox"/> Boot lid opening limiter

SPLITVIEW

SPLITVIEW allows you to simultaneously use different COMAND functions on the front-passenger side and on the driver's side. Depending on the viewing angle of the display (from the driver's seat or from the front-passenger seat), you will see two different displays.

For example, the "Navi" function can be used from the driver's side while the "Video" function is used on the front-passenger side.

Use the remote control to operate COMAND from the front-passenger side with SPLITVIEW.



Please bear the following in mind

- Volume adjustment for the cordless headphones can be carried out on the headphones. Before putting on the headphones, make sure that the volume has not been set too high.
- The remote control can be used for the volume adjustment of corded headphones.
- You can only use media from the driver's and front-passenger sides separately if the media are from different sources. Example: on the driver's side, an audio CD is being played on the DVD changer. This means that on the front-passenger side, the DVD changer cannot be used to play a different medium, for instance a video DVD. However, other media can be used at the same time on the front-passenger side, including radio, memory card, MUSIC REGISTER, Media Interface, USB or AUX.
- If you use the same medium on both sides, you can both carry out the respective settings.

- There must be intervisibility between the headphones and the display so that COMAND can optimally transmit music and speech via an infrared signal to the front-passenger's headphones. For this reason, please also observe that the headphones have left and right sides, and use them correctly.
- Only entertainment functions, i.e. audio, TV and video, may be used separately with SPLITVIEW.
- The multifunction steering wheel can only be used for functions which relate to the driver's side.

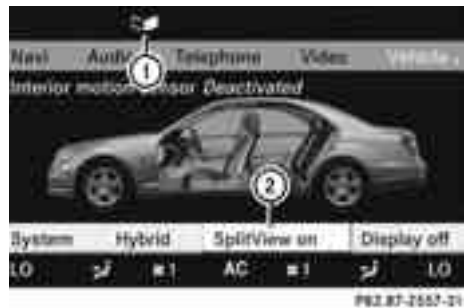
Switching SPLITVIEW on/off



- ▶ **To switch on SPLITVIEW:** select **Vehi-
cle** from the main function bar by turning  the COMAND controller and press  to confirm.
The "Vehicle" menu appears.
- ▶ Select **SPLITVIEW on**.
SPLITVIEW symbol ① appears in the display, and display ② switches to **SPLITVIEW off**.
- ▶ **To switch off SPLITVIEW:** select **Vehi-
cle** from the main function bar by turning

🔊 the COMAND controller and press  to confirm.

The "Vehicle" menu appears.

- ▶ Select **SPLITVIEW off**.
Display  switches to **SPLITVIEW on**.

i If COMAND has already been switched on, you can also use the remote control to switch SPLITVIEW on and off (▷ page 125).

The SPLITVIEW screen remains on for approximately 30 minutes after the key has been turned to position **0** in the ignition lock. After this time or after the key has been removed, the settings on the front-passenger side are saved for approximately 30 minutes longer. After this period, reactivation on the front-passenger side means that the settings from the driver's side will be used.

Cordless headphones for the front passenger

There are different cordless headphones for the front passenger and the rear compartment.



The cordless headphones for the front passenger can be identified by SPLITVIEW symbol  on the headband.

The cordless headphones for the front passenger cannot be used in the rear compartment. Equally, the headphones for the rear compartment cannot be used by the front passenger.

Swivelling the COMAND display and setting the brightness

You can swivel the COMAND display¹⁰. The buttons are located beside the COMAND display.

Swivelling

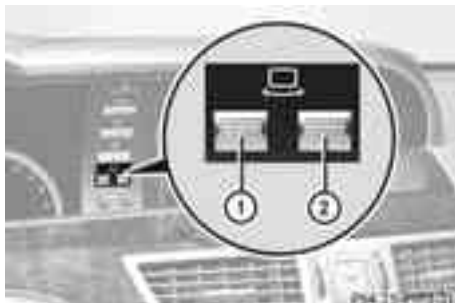

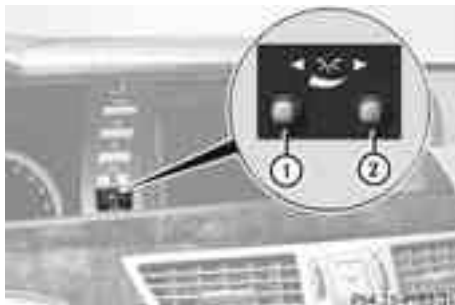

- ① To swivel the display to the left
- ② To swivel the display to the right

Setting the brightness



- ① Brightness of the instrument cluster lighting
- ② Brightness of the COMAND display

Brighter or dimmer:

- ▶ Turn control  or  clockwise or anti-clockwise.

i If Night View Assist Plus is activated, only the brightness of the multifunction display is adjusted with control .

¹⁰ Not with SPLITVIEW.

Display design

When the default settings are selected, the display automatically switches between day design and night design.

You can change these settings using COMAND (▷ page 143).

Cleaning instructions

! Do not touch the COMAND display. The display has a very sensitive high-gloss surface; there is a risk of scratching. If you have to clean the screen, however, use a mild cleaning agent and a soft, lint-free cloth.

The display must be switched off and have cooled down before you start cleaning. Clean the display screen, when necessary, with a commercially available microfibre cloth and cleaning agent for TFT/LCD displays. Then, dry the surface with a dry microfibre cloth.

Avoid using alcoholic thinners, petrol or abrasive cleaning agents. These could damage the display surface. Do not apply pressure to the display surface when cleaning it, as this could cause irreversible damage.

Remote control

Overview

You can use the remote control to operate the COMAND display, SPLITVIEW and either one of the rear-compartment screens.



- ① To switch the screen on/off (Rear Seat Entertainment System only)
 - ② To switch the button lighting on/off
 - ③ To select the screen for remote control operation (**COMAND**, **SPLITVIEW**, **L REAR** and **REAR R** can be selected)
 - ④ To select a menu or menu item
 - ⑤ To confirm a selection or setting
 - ⑥ Mute
 - ⑦ To adjust the volume (for corded head-phones only)
 - ⑧ **COMAND**: to set the station, skip track, fast forward/rewind, for example. **Rear Seat Entertainment System**: skip track, fast forward/rewind
 - ⑨ **COMAND**: to select a station from pre-sets, select a track, enter directly, enter a phone number, for example. **Rear Seat Entertainment System**: to select a track, enter directly
 - ⑩ To exit a menu (back)
- Point the remote control at the corresponding screen and execute the functions by pressing the corresponding buttons.
- i** The remote control's function may be restricted depending on the angle at which it is pointed at the respective screen.

Selecting the screen for the remote control

- ▶ Turn thumbwheel ③ until the desired display is highlighted in the window.

To switch the screen on/off (Rear Seat Entertainment System only)

If the key is in the ignition lock in position **0** or **1** or if the key is not in the ignition lock, the rear screens will switch off after 30 minutes. Before the screens switch off, they show a message to this effect.

You can switch the screens back on. However, this will discharge the starter battery.

- ▶ Point the remote control at the rear-compartment screen which has been selected for remote operation.
- ▶ Press button ① on the remote control. The respective rear screen switches on or off.

i You can only switch the screens on using the remote control if the ignition is switched on.

To switch the button lighting on/off

- ▶ Press button ② on the remote control. Depending on the previous status, the button lighting is switched on or off.
- i** If you do not use the remote control for about 15 seconds, the button lighting switches off automatically.

Mute

- ▶ Press button ⑥ on the remote control. The sound is switched on/off.

Adjusts the volume

This function is available for SPLITVIEW and for the Rear Seat Entertainment System in conjunction with corded headphones.

- ▶ Press one of buttons ⑦ on the remote control.

The volume of the currently selected audio or video source changes.

For COMAND, you can also adjust the volume of phone calls, traffic reports and navigation announcements.

Selecting a menu/menu item and confirming your selection

- ▶ Press the     buttons to select the menu/menu item and press the  button to confirm.

Functions with the and button

You can use the remote control to execute the same functions as the COMAND control panel.

Mode	Function
Audio mode	Selects the station or station list (FM and DAB radio mode) (▷ page 219)
	Selects a station using the station search function (▷ page 219)
	Selects a track by skipping to a track (▷ page 227)
	Fast forward/rewind (▷ page 228)
Video mode	Sets a TV channel (▷ page 244)
	Select a scene or chapter (video DVD mode) (▷ page 251)
	Fast-forward/rewind (video DVD mode) (▷ page 250)

Functions of the number keypad

You can use the remote control to execute the same functions as the COMAND control panel.





Mode	Function
Audio mode	Selects stations via the station presets (▷ page 219)
	Sets stations by entering the frequency manually (▷ page 220)
	Stores stations manually (▷ page 221)
	Selects a track (▷ page 227)
	Selects a data medium via the media list (▷ page 227)
Video mode	Sets a TV channel (▷ page 244)
	Sets a TV channel via channel or programme number entry (▷ page 244)
	Selecting a teletext page (▷ page 247)
Telephone mode	Telephone number entry (▷ page 200)
Character entry	Enters characters (direct entry) (▷ page 130)

Operating COMAND

Selecting a main function

Initial situation

You would like to change from the telephone menu to the vehicle settings, for example.

- ▶ Slide   the COMAND controller and switch to the main function bar.
- ▶ Select **Vehicle** in the main function bar by turning  the COMAND controller and press  to confirm.
The "Vehicle" menu appears.



- ① "Vehicle" menu
- ② Display/selection window



Calling up the menu of a main function



- ① To call up the audio menu
- ② Main function bar

If one of the main functions navigation, audio, telephone or video is switched on, triangle ① appears next to the entry. You can now select an associated menu.



The following example illustrates how to call up the audio menu.

- ▶ Press the  function button.
 - or
 - ▶ Select **Audio** in the main function bar by sliding  the COMAND controller and press  to confirm.
- The Audio menu appears.





- ① Current audio operating mode
- ② Main function bar
- ③ Audio menu

The  dot indicates the current audio mode.



- ▶ Select another audio mode, e.g. **Radio**, by turning  the COMAND controller and press  to confirm.

Selects a menu item

The following example describes how to select a station from the station presets in radio mode.

- ▶ Press the  function button.
 - ▶ Select **Presets** by sliding  and turning  the COMAND controller and press  to confirm.
- The station preset memory appears.



- ① Selection bar
 - ▶ Select a station by turning  the COMAND controller and press  to confirm.
- The station is set.

Example of operation

Initial situation

You would like to switch from the vehicle function to the radio function and select a station from the station list, for example. The following operating example describes how to:

- call up the audio function
- switch on radio mode
- select a station from the station list



Calling up the audio function

- ▶ Select **Audio** in the main function bar by sliding $\uparrow \odot$ and turning $\left\{ \odot \right\}$ the COMAND controller and press \odot to confirm. The basic display of the current audio operating mode, e.g. audio CD, appears.



Switches to radio mode

Option 1

- ▶ Press the **DISC RADIO** function button. The radio display appears.

- ▶ Repeated pressing of this function button switches between radio and the most recently active audio source.

Option 2

- ▶ Select **Audio** again by sliding $\uparrow \odot$ the COMAND controller and press \odot to confirm. The Audio menu appears.



- ① Current audio operating mode
- ② Main function bar
- ③ Audio menu

- ▶ Press \odot the COMAND controller and confirm **Radio**. The radio basic display appears with the waveband last selected.



Calling up the station list

- ▶ Select **Radio** by sliding $\odot \downarrow$ and turning $\left\{ \odot \right\}$ the COMAND controller and press \odot to confirm. The radio menu appears. **Station list** is highlighted.

- ▶ Confirm **Station list** by pressing . The station list appears.
- ▶ Select the station by turning the COMAND controller and press to confirm. The selected station is played. The radio basic display appears.

Entering characters in navigation mode (entering a town)

General information

The following paragraphs describe how to enter characters using town input for **BERLIN** as an example.

If you want to use the address entry menu (page 153) to enter a town, a street or a house number, for example, COMAND provides either a list with a character bar (option 1) or a selection list (option 2).

You can enter the characters using either the character bar or the number keypad. In the selection list, you select an entry to copy it to the address entry menu.

Option 1: town list with character bar

- ▶ Call up the town list with character bar (page 153). The alphabetically sorted town list shows the first available entries.



Entering characters using the character bar

- ▶ Select **B** by turning the COMAND controller and press to confirm.



- ① Character entered by the user **B**
- ② Characters automatically added by COMAND **AABE**
- ③ List entry that most closely resembles the current entry by the user
- ④ To switch to the selection list
- ⑤ To delete an entry
- ⑥ To change the character set (Latin/Cyrillic)
- ⑦ Characters not currently available
- ⑧ Characters currently available
- ⑨ Character bar
- ⑩ To cancel an entry
- ⑪ Currently selected character
- ⑫ List

List **⑫** shows all available town names beginning with a **B**. The list entry most closely resembling the current entry by the user **③** is always highlighted at the top of the list (**BAABE** in the example).

All characters currently entered by the user are shown in black (letter **B** **①** in the example). Letters added by COMAND are shown in grey **②** (letters **AABE** in the example).

Character bar **⑨** shows the letters still available for selection in black **⑧**. These can be selected. In the example, the letter **A** is highlighted **⑪**. Which characters remain available depends on the characters already entered by the user and on the data stored in the digital map. Characters that are no longer available are shown in grey **⑦**.

- ▶ Select **E, R, L, I, N** in succession, confirming each by pressing .



Entering characters using the number keypad

- ▶ Press number key  on the telephone keypad twice in quick succession to select the letter **B**.
The character appears at the bottom of the display when the key is pressed. The first available letter is highlighted.













You see which characters you can enter with that key. Each time the key is pressed, the next character is selected.



Example: key :

- press once = A
- press twice = B
- press three times = C
- ▶ Wait until the character display goes out. The entries matching your input are shown in the list.
- ▶ Enter **E, R, L, I, N** using the corresponding keys.

Further functions in the list with character bar

- ▶ **To delete characters:** select  by sliding  and turning  the COMAND controller and press  to confirm.
- ▶ **To delete an entry:** select  and press and hold  the COMAND controller until the entire entry has been deleted.
- ▶ **To switch the character set:** select  and press  to confirm.
This will switch the character set from Latin to Cyrillic and back.
- ▶ **To cancel an entry:** select the  symbol in the bottom left of the character bar and press  to confirm.

or

- ▶ Press the  back button.
The address entry menu appears.
- ▶ **To accept the first list entry:** press and hold  the COMAND controller until the address entry menu appears.
The accepted list entry is shown there.

Calling up the list as a selection list

Select the desired town from the selection list.



If there are several entries for a town or if several towns of the same name are stored, then  is highlighted in the character bar.

- ▶ Press  the COMAND controller.

It is also possible to switch the town list to the selection list at any time during character input.

- ▶ Slide  the COMAND controller repeatedly until the town list appears as a selection list.

or

- ▶ Select  in the character bar by turning  the COMAND controller and press  to confirm.

Option 2: town list as selection list

COMAND either shows the selection list automatically or you can call up the selection list from the list with character bar.

The example shows the selection list after the town **BERLIN** has been entered. The entry is highlighted automatically. The  icon indicates that there are several entries.



- Confirm **BERLIN** by pressing  the COMAND controller.

The address entry menu appears. You can now enter a street, for example.



- i** You will find further information in the "Destination entry" section (► page 153).

Entering characters in the address and the phone book

Introduction

The following section describes how to enter characters in the phone book/address book when creating a new entry.

Creating a new entry in the phone book

- Call up the input menu with data fields (► page 210).

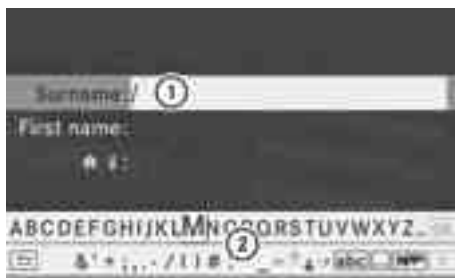

Phone book: input menu with data fields

- ① Selected data field with cursor
- ② Character bar

Creating a new entry in the address book

- Call up the input menu with data fields (► page 210).





Input menu with data fields

- ① Selected data field with cursor
- ② Character bar

Entering characters

The example describes how to enter the surname **Schulz**.

- Select **S** by turning  and sliding  the COMAND controller and press  to confirm.
S is entered into the data field. All characters are shown in black and can always be selected in the character bar.

The character bar offers characters corresponding to the respective data field (letters or digits).



- ① To switch the character bar to upper-case/lower-case letters
- ② To switch the character bar from upper/lower-case letters to digits
- ③ Changing the language of the character bar
- ④ To delete a character/an entry
 - ▶ Select **C** and confirm by pressing the COMAND controller. The letter **C** is added to **S** in the data field.
 - ▶ Repeat the process until the name has been entered in full.

- ▶ **To enter a phone number:** select the digits one by one in the corresponding data field by turning and sliding the COMAND controller and press to confirm.

Switching data fields

If you want to enter a first name after you have entered a surname, for example, proceed as follows to switch between the data fields:

Option 1

- ▶ Select or in the character bar and press to confirm. The input menu shows the data field selected.



- ① Cursor in the next data field
- ② To store an entry
- ③ and icons to select a data field

Option 2

- ▶ Slide the COMAND controller repeatedly until the character bar disappears.
- ▶ Select the data field by sliding and press to confirm.

To store an entry

- ▶ Select in the character bar by turning the COMAND controller and press to confirm. The entry is stored in the address book.

Further functions available in the character bar

- ▶ **To switch the character bar to upper/lower-case characters:** select or and press to confirm.
- ▶ **To switch the character set:** select and press to confirm. The character set switches between upper/lower-case letters and digits.
- ▶ **To change the language of the character bar:** select and press to confirm.
- ▶ Select the language by turning the COMAND controller and press to confirm.



- ▶ **To reposition the cursor within the data field:** select or and press to confirm.



- ① Cursor (repositioned)
- ② and icon to reposition the cursor

- ▶ Delete the character/entry (▷ page 211).

Basic functions of COMAND

Switching COMAND on/off

- ▶ Press the function button on the centre console.
- i** If you switch off COMAND, playback of the current audio or video source will also be switched off. You cannot switch off COMAND while making a call via COMAND. You can also make phone calls using the buttons on the multifunction steering wheel when COMAND is switched off (▷ page 393).

Mute

Switching audio and video sources on/off

- ▶ Press the button on the multifunction steering wheel. The sound from the respective audio or video source is switched on or muted.
- i** If the sound is off, the system displays the symbol in the status line. If you change the audio or video source, or adjust the volume, the sound automatically switches on again.
- i** Even if the sound is switched off, you will still hear traffic and navigation system announcements.

Switching off Traffic Programme and navigation announcements completely

- ▶ **Traffic Programme:** press the button until the message disappears from the status bar of the display. A confirmation tone sounds.
- ▶ **Navigation announcements:** during an announcement, press the button on the multifunction steering wheel.

Switching Traffic Programme and navigation announcements on again

- ▶ **Traffic Programme:** press and hold down the button until the display appears in the status bar. A confirmation tone sounds.
- ▶ **Navigation messages:** select the symbol in the navigation menu bar and press to confirm.
- i** The navigation announcements are activated again if you switch COMAND off and on again or start a new route guidance.

Adjusting the volume

Adjusting the volume for the audio or video source



- ▶ **To adjust:** turn thumbwheel ①.

or

- ▶ Press the **+** or **-** button on the multifunction steering wheel.
The volume of the currently selected audio or video source changes.

You can also adjust the volume for the following:

- traffic announcements
- navigation announcements
- phone calls
- LINGUATRONIC voice control (see the separate operating instructions)

Adjusting the volume for traffic announcements and navigation announcements

- ① You can set the volume of traffic and navigation announcements relative to the volume of the audio or video source.

During traffic or navigation announcements:

- ▶ Turn thumbwheel ①.

or

- ▶ Press the **+** or **-** button on the multifunction steering wheel.

Adjusting the volume for phone calls

You can adjust the volume for hands-free mode during a telephone call.

- ▶ Turn thumbwheel ①.

or

- ▶ Press the **+** or **-** button on the multifunction steering wheel.

Adjusting the sound settings

Calling up the sound menu

You can make various sound settings for the different audio and video sources. This means that it is possible to set more bass for radio mode than for audio CD mode, for example. You can call up the respective sound menu from the menu of the desired mode.

The example describes how to call up the sound menu in radio mode.

- ▶ Press the **DISC RADIO** function button.

The radio display appears. You will hear the last station played on the last waveband selected.



- ▶ Select **Sound** by sliding **⊙** and turning **⌚** the COMAND controller and press **⊙** to confirm.

You can now set the treble and bass or the balance and fader for radio mode.

Adjusting treble and bass

- ▶ Select **Treble** or **Bass** in the sound menu by turning **⌚** the COMAND controller and press **⊙** to confirm.

An adjustment scale appears.



To set the treble

- ① Last setting selected
- ② Current setting

► Select a setting by turning **⏪** or **⏩** the COMAND controller and press **⏹** to confirm. The setting is stored and you exit the menu.

Adjusting balance and fader

The balance function is used to control whether the sound is louder on the driver's or on the front-passenger side.

The fader function is used to control whether the sound is louder in the front or in the rear of the vehicle.

► Select **Balance/fader** in the sound menu by turning **⏪** or **⏩** and press **⏹** to confirm.

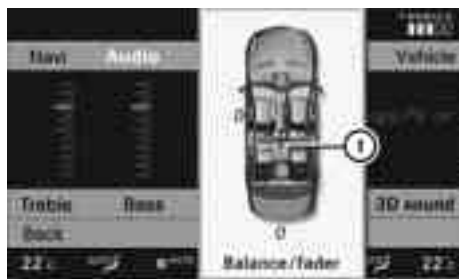

- ① Current setting

► Select a setting by sliding **↑** or **↓** or **←** or **→** the COMAND controller and press **⏹** to confirm. The setting is stored and you exit the menu.

Surround sound

General notes

If your vehicle is equipped with the harman/kardon® Logic 7® surround sound system, you can provide the optimum sound experience for every passenger.

The harman/kardon® Logic 7® surround sound system is available for the following operating modes:

- radio (FM only)
- DAB radio
- audio CD
- audio DVD (MLP™, dts™, PCM and Dolby® Digital audio formats)
- MP3
- Media Interface
- TV
- video DVD (PCM, dts™ and Dolby® Digital audio formats)
- AUX

Because some DVDs contain both stereo and multichannel audio formats, it may be necessary to set the audio format (► page 230).

i The **Logic7® On** function enables types of playback such as stereo recordings with a surround sound experience for every passenger. It enables optimum playback of music and films on CD, audio DVD or video DVD with multichannel audio formats, such as MLP™, dts™ or Dolby® Digital. This results in sound characteristics as the sound engineer intended when the original was recorded.

i If you select **Logic7® Off**, the sound system plays the tracks as stored on the medium. Due to the design of the passenger compartment, an optimum audio experience cannot be guaranteed for all passengers.

i Discs which support the audio formats mentioned have the following logos:



Dolby® Digital



dts™

Switching the surround sound on/off

Example: switching on surround sound for radio mode

- ▶ Press the function button.

The radio display appears. You will hear the last station played on the last waveband selected.

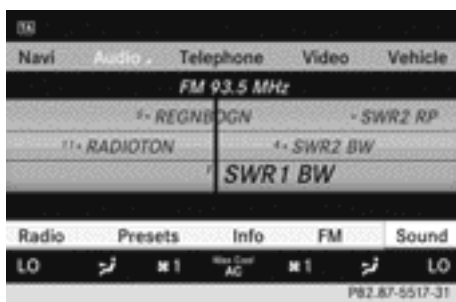

- ▶ Select **Sound** by sliding and turning the COMAND controller and press to confirm.
- ▶ Select **3D sound** and press to confirm.



- ① Current setting

- ▶ Select the **Logic7® On** or **Logic7® Off** setting by turning the COMAND controller and press to confirm.

Depending on your selection, surround sound is switched on or off and the menu is exited.

- ▶ **To exit the menu without saving:** press the back button or slide the COMAND controller.

- ⓘ Please bear the following in mind:

When Logic7® is switched on, the balance and fader settings should be set to the centre of the vehicle interior to provide the optimum audio experience for all passengers.

You will achieve the best sound results by playing high-quality audio and video DVDs. MP3 tracks should have a bit rate of at least 128 kbit/s.

Surround-sound playback does not function for mono signal sources, such as the medium wave range (MW) in radio mode. If radio reception is poor, e.g. in a tunnel, you should switch off Logic7®, as it may otherwise switch between stereo and mono and cause temporary sound distortions.

On some stereo recordings, the sound characteristics may differ from conventional stereo playback.

Bang & Olufsen sound system



Vehicles with a Bang & Olufsen sound system:

There are two settings available with **True Image™** sound technology:

- **reference**

This setting provides a crisp, clear, luxury high-end sound setting for a studio atmosphere in your vehicle.

- **3D sound**

This setting enables a wide-ranging sound experience for playing music and videos.

The **Sound Mode** function can be used to optimise the selected sound setting for one seat. The settings **front**, **all** and **rear** can be selected.

The Bang & Olufsen sound system provides the following operating modes:

- radio (FM only)
- audio CD
- audio DVD (MLP™, dts™, PCM and Dolby® Digital audio formats)
- MP3
- Media Interface
- video DVD (PCM, dts™ and Dolby® Digital audio formats)
- AUX

Because some DVDs contain both stereo and multichannel audio formats, it may be necessary to set the audio format (> page 230).

Discs which support the audio formats mentioned have the following logos:



Dolby® Digital



dts™



MLP™

Selecting settings for the Bang & Olufsen sound system

Calling up the menu

- ▶ Select **Sound**.
 - ▶ Highlight **Bang&Olufsen**.
 - ▶ Press .
- A menu appears.

A • dot in front of an entry indicates the current setting.

Selecting the setting for True Image™

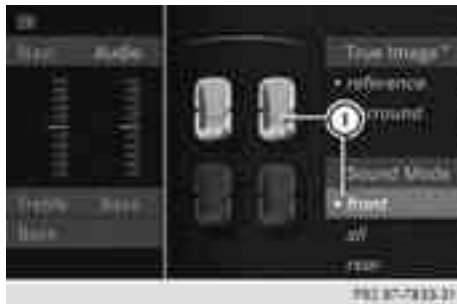

- ▶ Turn or slide and highlight **reference** or **3D sound**.
- ▶ Press .

Focusing the sound setting



① Current position of the sound setting

► Select **Sound Mode** in the menu.

► Turn  or slide  and highlight **front**, **all** or **rear**.

► Press .

► **To exit the menu:** press the  back button beside the COMAND controller.

or

► Slide .

i Please bear the following in mind:

You will achieve the best sound results on your Bang & Olufsen sound system by playing high-quality audio DVDs and CDs.

MP3 tracks should have a bit rate of at least 224 kbit/s.

When playing using an iPod®, the bit rate should also be at least 224 kbit/s.

For optimum playback quality:

- Deactivate the **EQ** setting on the iPod®.

Surround-sound playback does not function for mono signal sources, such as the medium wave range in radio mode.

On some stereo recordings, the sound characteristics may differ from conventional stereo playback.

Rear Seat Entertainment System

Components

Overview

The Rear Seat Entertainment System comprises:

- two screens for the rear behind the front-seat head restraints
- the remote control
- a CD/DVD drive
- AUX jacks on both screens (display AUX) and on the CD/DVD drive (drive AUX)
- two sets of cordless headphones

Rear-compartment screens

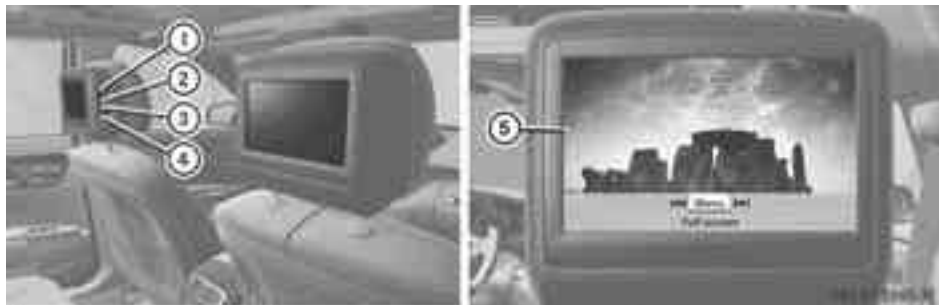

- ① Socket for corded headphones
- ② V jack for video signal
- ③ L jack for audio signal, left
- ④ R jack for audio signal, right
- ⑤ Rear compartment screen

You can connect an additional set of corded headphones to each rear-compartment screen. The connection socket is for headphones with 3.5 mm stereo jack plugs and an impedance of 32 ohms.

Remote control

Overview

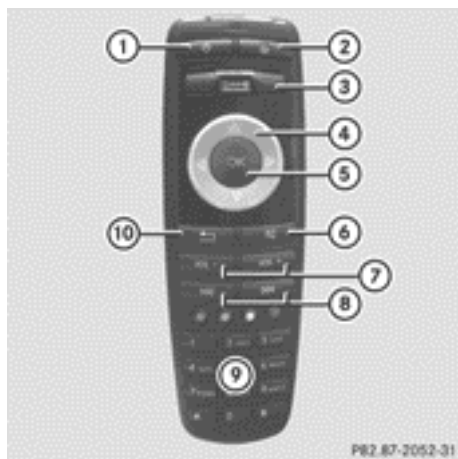

- ① To switch the screen on/off
- ② To switch the button lighting on/off
- ③ To select the screen for remote control operation (**COMAND**, **SPLITVIEW**, **L REAR** and **REAR R** can be selected)

- ④ To select a menu or menu item
- ⑤ To confirm a selection or setting
- ⑥ To switch sound on/off (for corded headphones)
- ⑦ To adjust the volume (for corded headphones)
- ⑧ To skip, fast-forward/fast-rewind
- ⑨ To select a track; to enter directly
- ⑩ To exit a menu (back)

Selecting the screen for the remote control

You can use the remote control to operate one of the two rear screens at a time. To do so, you must switch the remote control to the desired screen.

- ▶ To select the left-hand screen: turn thumbwheel ③ until "L REAR" is highlighted in the window.
- ▶ To select the right-hand screen: turn thumbwheel ③ until "REAR R" is highlighted in the window.

Switching the screen on/off

If the key in the ignition lock is in position **0** or **1** or if the key is not in the ignition lock, the rear screens will switch off after 30 minutes. Before the screens switch off, they show a message to this effect.

You can switch the screens back on. However, this will discharge the starter battery.

- ▶ Point the remote control at the rear-compartment screen which has been selected for remote operation.
- ▶ Press button ① on the remote control. The respective rear screen switches on or off.
- ❗ You can only switch the screens on using the remote control if the ignition is switched on.

Switching the button lighting on/off

- ▶ Press button ② on the remote control. Depending on the previous status, the button lighting is switched on or off.
- ❗ If you do not use the remote control for about 15 seconds, the button lighting switches off automatically.

Switching the sound on/off (corded headphones only)

- ▶ Press button ⑥ on the remote control. The sound is switched on/off.

Selecting a menu/menu item and confirming your selection

- ▶ Press the     buttons to select the menu/menu item and press the  button to confirm.

CD/DVD drive and AUX jacks

The CD/DVD drive is located in the centre behind the front seats.

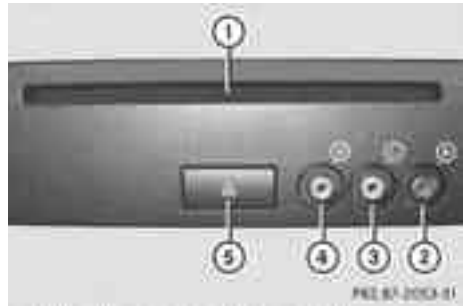

- ① CD/DVD slot
- ② AUX, right-hand (R) jack for audio signal
- ③ AUX, left-hand (L) jack for audio signal
- ④ AUX, jack for video signal (V)
- ⑤ CD/DVD eject button

The AUX jacks shown are for the AUX drive. Identical jacks can be found on the right-hand side of the rear-compartment screens (AUX display), (▷ page 140).

Cordless headphones

Overview

The cordless headphones for the rear compartment can be recognised by the "DIGITAL AUDIO" inscription on the battery compartment cover and by the fact that there is no SPLITVIEW symbol (▷ page 123)(▷ page 123).



- ① Volume control
- ② To select a screen for the headphones
- ③ Battery compartment cover
- ④ To switch the cordless headphones on/off
- ⑤ Indicator lamp with various displays (▷ page 142)

► Open both sides of the headphones and adjust the fit of the headphones by pulling the headphone band in the direction of the arrow.

Switching the cordless headphones on/off

- Press button ④.
Depending on the previous status, the headphones are switched on or off. To save the battery, the headphones are switched off automatically if they do not receive a signal within three minutes.

Adjusting the volume of the headphones

- Turn volume control ① until you have reached the desired volume.
- i** If you have connected corded headphones to a rear-compartment screen, you

can adjust the volume by pressing buttons ⑦ on the remote control (▷ page 125).

Selecting a screen for the headphones

- Move push slider ② to **L** (left-hand screen) or **R** (right-hand screen).

Indicator lamp displays

The indicator lamp displays the following possible stati for the batteries and headphones:

Display	Status
Green	The batteries are fine.
Red	The batteries are almost discharged.

Display	Status
Continuously lit either green or red	The headphones are switched on and connected to a screen.
Flashes either green or red	The headphones are searching for the connection to a screen.
No display (dark)	The headphones are switched off or the batteries are discharged.

Connecting additional headphones

You can connect an additional set of corded headphones to each rear-compartment screen (▷ page 140).







Changing batteries

Batteries are required for the remote control and for the two sets of cordless headphones. For changing batteries: (▷ page 254)

System settings

Display settings









Switching the display on/off

- ▶ Select **Vehicle** by turning  the COMAND controller and press  to confirm.
- ▶ Select **Display off** by turning  the COMAND controller and press  to confirm.
- ▶ **To switch on the display:** press  or  turn the COMAND controller.

Display design

Your COMAND display features optimised designs for operation during daytime and night-time hours. You can customise the

design to suit your personal preferences by manually selecting day or night design or opt for an automatic setting.

- ▶ Select **Vehicle** by turning  the COMAND controller and press  to confirm.
- ▶ Select **System** by turning  the COMAND controller and press  to confirm.
- ▶ Select **Display** and press  to confirm.
- ▶ Select **Day design**, **Night design** or **Automatic** by turning  the COMAND controller and press  to confirm. The  icon indicates the current setting.

Design	Explanation
Day design	The display is set permanently to day design.
Night design	The display is set permanently to night design.
Automatic	The display design changes depending on the brightness around the vehicle.

-  In the **Automatic** setting, COMAND evaluates the readings from the automatic vehicle light sensor and switches between the display designs automatically.

Time settings

General information

If COMAND is equipped with a navigation system and has GPS reception, COMAND automatically sets the time and date. You can also adjust the time yourself in 30-minute increments, but the date cannot be changed.

-  If you set the time in 30-minute increments, any time zone settings and settings

for changing between summer and standard time are lost (► page 144).

i The following navigation system functions require the time, time zone and summer/standard time to be set correctly in order to work properly:

- route guidance on routes with time-dependent traffic guidance
- calculation of expected time of arrival

Setting the time

- Select **Vehicle** in the main function bar by turning **Ⓜ** the COMAND controller and press **Ⓜ** to confirm.
- Select **System** by turning **Ⓜ** the COMAND controller and press **Ⓜ** to confirm.
- Select **Time** by turning **Ⓜ** the COMAND controller and press **Ⓜ** to confirm.
- Select **Time** and press **Ⓜ** to confirm.



- ① Setting the time
 - ② Current date (set automatically by COMAND)
- Set the time by turning **Ⓜ** the COMAND controller and press **Ⓜ** to confirm.

Setting the time/date format

- Select **Vehicle** in the main function bar by turning **Ⓜ** the COMAND controller and press **Ⓜ** to confirm.
- Select **System** by turning **Ⓜ** the COMAND controller and press **Ⓜ** to confirm.
- Select **Time** by turning **Ⓜ** the COMAND controller and press **Ⓜ** to confirm.
- Select **Format** and press **Ⓜ** to confirm. The **•** symbols show the current settings.





Abbreviation	Meaning
DD/MM/YYYY	Day/Month/Year (date format)
HH/MM	Hours/Minutes (time format)

You can set the 24-hour or the AM/PM format.

- Set the format by turning **Ⓜ** the COMAND controller and press **Ⓜ** to confirm.





Setting the time zone and switching between summer and standard time

- Select **Vehicle** in the main function bar by turning **Ⓜ** the COMAND controller and press **Ⓜ** to confirm.
- Select **System** by turning **Ⓜ** the COMAND controller and press **Ⓜ** to confirm.
- Select **Time** by turning **Ⓜ** the COMAND controller and press **Ⓜ** to confirm.

- ▶ Select **Time zone** and press  to confirm. The country list appears. The  dot indicates the current setting.
- ▶ Select the country you are currently in by turning  the COMAND controller and press  to confirm. A time zone list may also be displayed, depending on the country selected.
- ▶ Select the time zone and press  to confirm.

Further steps depend on whether the navigation system currently has GPS reception and on which country you have selected.





You have the following two options:





- ▶ **To change manually:** select **Summer Time** or **Standard Time** and press  to confirm.
- ▶ **To switch automatic changeover on/off:** select **Automatic summer/winter time changeover** or **Automatic summer/winter time changeover** by turning  the COMAND controller and press  to confirm. The  dot indicates the current setting.

i If you have switched off the automatic changeover function, you must change from summer to standard time and vice versa manually using the "Set time" function (▷ page 144).

Text reader settings

Setting the text reader speed







- ▶ Select **Vehicle** by turning  the COMAND controller and press  to confirm.
- ▶ Select **System** and press  to confirm.
- ▶ Select **Text reader** and press  to confirm.

- ▶ Select **Set text reader speed** and press  to confirm. A list appears. The  dot indicates the current setting.
- ▶ Select a setting by turning  the COMAND controller and press  to confirm.

LINGUATRONIC settings

Opening/closing the help window

The help window provides information in addition to the audible instructions during individualisation as well as later, when you are using voice control.

- ▶ Select **Vehicle** in the main function bar by turning  the COMAND controller and press  to confirm.
- ▶ Select **System** by turning  the COMAND controller and press  to confirm.
- ▶ Select **Linguatronic** by turning  the COMAND controller and press  to confirm.
- ▶ Select **Help window** and press  to confirm. You have switched the help window on or off .



Individualisation







Introduction

Using individualisation, you can fine tune LINGUATRONIC to your own voice and thus improve voice recognition. This means that other users' voices will not be recognised as easily and, therefore, this function can be switched off.

Individualisation comprises two parts and takes approximately 5 minutes. It consists of training the system to recognise a certain number of digit sequences and voice commands.

Starting new individualisation

Individualisation can only be started when the vehicle is stationary. Before starting, switch off all devices or functions which could interfere, such as the radio or the navigation system. After starting the session, the system guides you through the training with spoken instructions.

- ▶ Select **Vehicle** in the main function bar by turning  the COMAND controller and press  to confirm.
- ▶ Select **System** by turning  the COMAND controller and press  to confirm.
- ▶ Select **Linguatronic** and press  to confirm.
- ▶ Select **Start new individualisation** and press  to confirm.
You see and hear a prompt asking whether you would like further information.
- ▶ Select **Yes** or **No** and press  to confirm.
If you select **No**, the first part of individualisation begins. You will be asked whether you would like to train digits or voice commands.

If you select **Yes**, you will see and hear information on the individualisation process. The first part of individualisation then begins automatically.

- ▶ **To close the display:** press  the COMAND controller.
You will be asked whether you would like to train digits or voice commands.



At the end of the first part, a prompt will appear asking whether you wish to begin the second part.

- ▶ Select **Yes** or **No** and press  to confirm.
If you select **No**, individualisation will be cancelled. The data from the first part is stored automatically.
If you select **Yes**, the second part will begin.

Individualisation is completed at the end of the second part. You will see a message to this effect. The data from the second part is stored automatically.

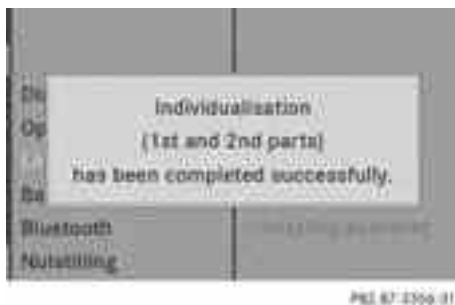







Cancelling the first or second part of individualisation

- ▶ Confirm **Cancel** by pressing  the COMAND controller.
A prompt appears asking whether you really wish to cancel.

- ▶ Select **Yes** or **No** and press  to confirm. If you select **Yes**, individualisation will be cancelled. The data from the part during which you exited is not stored. If you select **No**, the current part begins again.

Deleting existing individualisation data

- ▶ Select **Vehicle** by turning  the COMAND controller and press  to confirm.
- ▶ Select **System** and press  to confirm.
- ▶ Select **Linguatronic** and press  to confirm.
- ▶ Select **Delete individualisation** and press  to confirm. A prompt appears asking whether you really wish to delete.
- ▶ Select **Yes** or **No** and press  to confirm. If you select **No**, the process will be aborted. If you select **Yes**, the individualisation is deleted. You will see a message to this effect.

Bluetooth® settings

General information about Bluetooth®

Bluetooth® technology is the standard for short-range wireless data transmission of up to approximately 10 metres. Bluetooth® allows, for example, the exchange of vCards. Bluetooth® is a registered trademark of Bluetooth Special Interest Group (SIG) Inc.



Requirements for a Bluetooth® connection







You can connect mobile phones, laptops and PDAs with COMAND.

To do so, the following conditions need to be met:

- Bluetooth®-capable devices, e.g. mobile phones, need to comply with a certain profile in order to be connected to COMAND. Every Bluetooth® device has its own specific Bluetooth® name.
- Bluetooth® must be activated in COMAND and on the respective Bluetooth® device; see the separate operating instructions.
- the Bluetooth® device must be "visible" to COMAND in order for COMAND to find and display it. For the setting procedures, please see the operating instructions for the Bluetooth® device.

- ❗ Once a mobile phone has been connected, reception and transmission volume may change.

Activating/deactivating Bluetooth®

- ▶ Select **Vehicle** in the main function bar by turning  the COMAND controller and press  to confirm.
- ▶ Select **System** by turning  the COMAND controller and press  to confirm.
- ▶ Select **Bluetooth** by turning  the COMAND controller and press  to confirm.
- ▶ Select **Bluetooth activated** and press  to confirm. This switches Bluetooth® on or off .

Connecting Bluetooth® devices

General information

Before using your Bluetooth® device with COMAND for the first time, you will need to connect it.

Connecting comprises:

- searching for a Bluetooth® device
- subsequently authorising it

i A maximum of 15 devices can be available for selection from the device list.

You can obtain more detailed information about suitable mobile phones and about connecting Bluetooth®-capable mobile phones to COMAND from your Mercedes-Benz Service Centre or on the Internet (<http://www.mercedes-benz.com/connect>).

Searching for Bluetooth® devices

- ▶ Activate Bluetooth® (▷ page 147).
- ▶ Select **Vehicle** in the main function bar by turning **⏻** the COMAND controller and press **⏻** to confirm.
- ▶ Select **System** by turning **⏻** the COMAND controller and press **⏻** to confirm.
- ▶ Select **Bluetooth** by turning **⏻** the COMAND controller and press **⏻** to confirm.
- ▶ Select **Search for Bluetooth devices** and press **⏻** to confirm.
- ▶ Select **Update** and press **⏻** to confirm. COMAND searches for Bluetooth® devices within range. After a short while, the Bluetooth® device list appears.



FIG. 87-0415-01

Example of display: Bluetooth® device list

- ① Currently connected • and authorised device (✓ icon)
- ② Newly detected device in range, not yet authorised (□ icon)
- ③ Device not within range but previously authorised (□, appears in grey)

The Bluetooth® device list shows all devices within range and all previously authorised devices, whether or not they are in range.

If the Bluetooth® device list is already full, you will be requested to de-authorise a device. If COMAND does not detect your Bluetooth® device, external authorisation may be necessary (▷ page 149).

Authorising a Bluetooth® device (registering)



- ▶ In the Bluetooth® device list, select not yet authorised device ② by turning **⏻** the COMAND controller.
- ▶ Select **Options** by sliding **⊙→** the COMAND controller and press **⏻** to confirm.
- ▶ Select **Authorise** and press **⏻** to confirm. or
- ▶ Press **⏻** to confirm the selected device. The input menu for the passkey appears.



The passcode is any one to sixteen-digit number combination which you can determine yourself. You must enter the same number combination in COMAND and in the Bluetooth® device to be authorised (see mobile phone operating instructions).

- i** Some mobile phones require the input of a four-digit passcode or longer number sequences.
- i** If you want to re-authorise a device following de-authorisation (▷ page 150), you can select a different passcode.
- ▶ **To enter a passcode in COMAND:** press the number keys in turn.
 - can be selected after the first number has been entered.

or



- ▶ Select the digits one by one by turning  the COMAND controller and press  to confirm.
- ▶ **To confirm an entry in COMAND:** select using the COMAND controller and press  to confirm.

or







- ▶ Select **SEND** on the telephone keypad.
- ▶ Enter the same passcode into the Bluetooth® device (see the operating instructions for the respective device). The device is authorised.

External authorisation

If COMAND does not detect your Bluetooth® device, this may be due to particular security settings on your Bluetooth® device. In this case, you can test if your Bluetooth® device can find COMAND. The Bluetooth® device name of COMAND is "MB Bluetooth".

- ▶ Select **Update**.
- ▶ Select **Options** by sliding  the COMAND controller and press  to confirm.
- ▶ Select **External authorisation** and press  to confirm.
- ▶ Start the Bluetooth® scan process on the Bluetooth® device (see separate operating instructions of the respective device).
- ▶ Select COMAND ("MB Bluetooth").
- i** The order in which the passkey is entered depends on the mobile phone.
- ▶ Enter the passkey on the Bluetooth® device when prompted.
- ▶ Confirm the **Do you want to authorise XX?** question in COMAND with **Yes**.
- ▶ Enter the passkey in COMAND.

Displaying the details of a Bluetooth® device

- ▶ In the Bluetooth® device list, select the desired device by turning  the COMAND controller.
- ▶ Select **Options** by sliding  the COMAND controller and press  to confirm.
- ▶ Select **Details** and press  to confirm. The detailed display for this device appears.
- ▶ **To close the detailed view:** turn  or slide  the COMAND controller.

De-authorising (de-registering) a Bluetooth® device

Mercedes-Benz recommends that you de-authorise devices, e.g. mobile phones, both in COMAND and on the respective Bluetooth® device itself. Subsequent authorisation may otherwise fail.

- ▶ In the Bluetooth® device list, select the authorised device by turning **⏏** the COMAND controller.
- ▶ Select **Options** by sliding **⊙→** the COMAND controller and press **⏏** to confirm.
- ▶ Select **De-authorise** and press **⏏** to confirm.
A prompt appears asking whether you really wish to revoke authorisation for this device.
- ▶ Select **Yes** or **No** and press **⏏** to confirm.
If you select **Yes**, the authorisation for the device will be revoked.
If you select **No**, the process will be aborted.

i If a Bluetooth® device has been de-authorised and is no longer in range, it will no longer be shown in the Bluetooth® device list after the next search.

System language settings

This function allows you to determine the language for the menu displays and the navigation messages. The selected language affects the characters available for entry.

If you change the system language, the language for LINGUATRONIC will be also be changed. If the selected language is not supported by LINGUATRONIC, "English" will be selected.

- ▶ Select **Vehicle** by turning **⏏** the COMAND controller and press **⏏** to confirm.
- ▶ Select **System** and press **⏏** to confirm.

- ▶ Select **Language** and press **⏏** to confirm. The list of languages appears. The **•** dot indicates the current setting.
- ▶ Select the language by turning **⏏** the COMAND controller and press **⏏** to confirm.
COMAND loads the selected language and sets it.

i In Arabic as well as some other countries, the selection option **English (Arabic map)** is available when setting the system language. This language setting shows the menus and input data in COMAND in English and the map in Arabic for certain countries. The destination is entered in English.

Reset function

You can reset COMAND to the factory settings. Amongst other things, this will delete all personal data (e.g. station presets, address book entries, entries in the destination memory and in the list of previous destinations in the navigation system). Resetting is recommended before selling or transferring ownership of your vehicle, for example.

- ▶ Select **Vehicle** in the main function bar by turning **⏏** the COMAND controller and press **⏏** to confirm.
- ▶ Select **System** by turning **⏏** the COMAND controller and press **⏏** to confirm.
- ▶ Select **Reset** and press **⏏** to confirm.
A prompt appears asking whether you wish to reset.
- ▶ Select **Yes** or **No** and press **⏏** to confirm.
If you select **No**, the process will be aborted.
If you select **Yes**, another prompt appears asking whether you really wish to reset.
- ▶ Select **Yes** or **No** and press **⏏** to confirm.
If you select **Yes**, a message will be shown. COMAND is reset and restarted.
If you select **No**, the process will be aborted.

Navigation

Introduction

Safety notes

WARNING

For safety reasons, only enter a new destination when the vehicle is stationary. You may otherwise be distracted from the traffic conditions, cause an accident and injure yourself and others.

COMAND calculates the route to the destination without taking account of the following, for example:

- traffic lights
- stop and give way signs
- parking or stopping restrictions
- lane narrowing
- other road and traffic rules and regulations

COMAND may give incorrect driving recommendations if the data on the digital map does not correspond to the actual conditions. For example, a route may have been diverted or the direction of a one-way street may have changed.

For this reason, you must always observe the respective road and traffic rules and regulations during your journey. Road and traffic rules and regulations always have priority over system driving recommendations.

General notes

Operational readiness of the navigation system

In vehicles for certain countries, the navigation system is not operational immediately after delivery because the digital map is not pre-installed.

If this is the case, the following message appears in the display after you switch to navigation mode:

The map software must be installed. Please insert the DVD containing the map software.

► **To install the map software:** proceed as described in the "Installing new map software" section (▷ page 187).

The navigation system must determine the position of the vehicle before first use or whenever operational status is restored. Therefore, you may have to drive for a while before precise route guidance is possible.

GPS reception

Correct functioning of the navigation system depends, amongst other things, on GPS reception. In certain situations, GPS reception may be impaired, there may be interference or there may be no reception at all, e.g. in tunnels or multi-storey car parks.

Entry restriction

On vehicles for certain countries, there is a restriction on entering data.

The restriction is active above a vehicle speed of about 5 km/h. The restriction is deactivated as soon as the vehicle speed drops below about 3 km/h.

When the restriction is active, certain entries cannot be made. This will be indicated by the fact that certain menu items are greyed out and cannot be selected.



The following functions, for example, may therefore not be available while the vehicle is in motion:

- entering the destination town and street
- entering a destination via the map
- entering special destinations in the vicinity of a town or via a name search
- editing entries
- direct entry using the number keypad

Switching to navigation mode

- ▶ Press the  function button once or twice.

or

- ▶ Select **Navi** in the main function bar by sliding  and turning  the COMAND controller and press  to confirm. In both cases, you will see the map either with or without the menu shown.

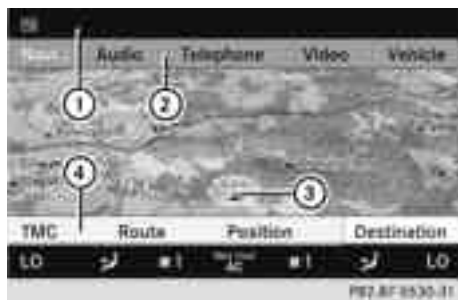

Map showing the menu; route guidance inactive

- ① Status bar
- ② Main function bar
- ③ Current vehicle position
- ④ Navigation menu bar



Map without the menu; route guidance inactive



- ① Current vehicle position
- ② Map orientation selected
- ③ Map scale selected

"Route guidance active" means that you have entered a destination and that COMAND has calculated the route. The display then shows

the route, changes of direction and lane recommendations. Navigation announcements guide you to your destination.

"Route guidance inactive" means that no destination has been entered and that no route has been calculated.

Showing/hiding the menu

- ▶ **To hide the menu:** slide  the COMAND controller over the map. The **Full screen** menu item is shown.
- ▶ Confirm the **Full screen** menu item shown by pressing . The map can be seen in the full-screen display.
- ▶ **To show the menu:** press  the COMAND controller when the map is shown in full-screen.

Basic settings

Route mode

Setting route type and route options

You can select the following route types:

- **Fast route:** COMAND calculates a route with the shortest (minimised) journey time.
- **Dynamic route:** same route type as **Fast route**. During route guidance, COMAND also takes RDS-TMC traffic announcements into account¹¹. Thus, the navigation system is able to guide you around a blocked section, for example. If a faster route is determined due to a received RDS-TMC traffic announcement, the navigation system changes the route. If possible, it will bypass blocked roads.
- **Eco Route:** the ECO route is an economical route that takes traffic announcements into account (see dynamic route).
- **Short route:** COMAND calculates a route with the shortest possible (minimised) route distance.





¹¹ RDS-TMC traffic announcements are not available in all countries.

In addition to route types, route options can also be set.

You can select the following route options:



- Avoid motorways
- Avoid toll roads
- Avoid routes requiring special toll sticker
- Avoid tunnels
- Avoid ferries.

If you select route options with a tick, the corresponding types of roads will be avoided in the route guidance where possible.

- ▶ **To call up the route mode menu:** press the  function button once or twice.
- ▶ Select **Navi** in the main function bar by sliding  and turning  the COMAND controller and press  to confirm.
- ▶ Select **Mode** and press  to confirm.



Route mode menu

- ① To select the route type
- ② To set route options
- ▶ Select a route type and press . The  icon indicates the current setting.
- ▶ Select the route option(s) and press  to confirm. The route options are switched on or off , depending on the previous status.
- ❗ If you change the route type and/or the route options while route guidance is active (the route has been calculated), COMAND will calculate a new route.

If you change the route type and/or the route options while route guidance is inactive (no destination has been entered yet), COMAND uses the new setting for the next route guidance.

- ❗ The route calculated may, for example, include ferry connections, even if the **Avoid ferries** route option is switched on.

In some cases, e.g. when calculating particularly long routes, COMAND may not be able to take all the selected route options into account. A note then appears in the COMAND display.

- ▶ **To exit the menu:** slide    the COMAND controller.

Entering a destination

Introduction to destination entry

WARNING

For safety reasons, only enter a new destination when the vehicle is stationary. You could otherwise be distracted from the traffic conditions, cause an accident and injure yourself and others.

The following destination entry options are available:

- entering a destination by address
- entering a destination from the destination memory
- Entering a destination from the list of last destinations
- Entering a destination using the map
- Entering an intermediate stop
- entering a special destination

- ❗ In some countries, the **English (Arabic map)** selection option is available when setting the system language. This language setting shows the menus and input data in COMAND in English and the map in Arabic for certain countries. The destina-

tion is entered in English and the navigation messages are in Arabic.

entering a destination by address

Introduction

When entering an address as the destination, you have the following options:

- entering the country, town/postcode, street and house number
- entering the country, town/postcode and street
- entering the country, town/postcode and centre
- entering the country, town/postcode, street and junction
- entering the country, town/postcode
- entering the country, street and town/postcode

Country and town/postcode are sufficient to start navigating. You can enter either a town or a postcode. By entering further address data such as the street and house number, you can specify the destination more precisely.

- i** Note that you can only enter a street, house number, junction or centre once you have entered a country and a town or postcode.
- i** You can only enter those towns, streets, postcodes etc. that are stored in the digital map. This means that for some countries, you cannot enter postcodes, for example.

Example of entering an address

The following is a step-by-step example of how to enter an address. The destination address is as follows:





Germany

Berlin

Unstrutstraße 1

You can of course enter any country, town, street and house number desired and enter, for example, your home address (Home address).

Calling up the address entry menu

- ▶ **To activate navigation mode:** press the  function button once or twice.
 - ▶ **To show the menu:** press  the COMAND controller.
 - ▶ Select **Destination** by turning  the COMAND controller and press  to confirm.
 - ▶ Select **Address input** and press  to confirm.
- The address entry menu appears. If you have previously entered a destination, this will be shown in the display.





Address entry menu

Depending on the sequence in which you enter the address and on the data status of the digital map, some menu items may not be available at all or may not yet be available.

Example: after country selection, the **No.**, **Centre**, **Junction**, **POI** (special destination), **Save** and **Start** menu items are not yet available. The **Postcode** menu item will not be available unless the digital map contains postcodes.

To select the country

- ▶ Select **Country** in the address entry menu by turning  and sliding  the COMAND controller and press  to confirm.
- You see the list of countries with the character bar.



Instructions for entering characters using town input as an example can be found in the "Entering characters in navigation mode (entering a town)" section (▷ page 130).

- ▶ **To switch to the country list as a selection list:** select **ok** in the character bar by turning **⤵** the COMAND controller and press **⏎** to confirm.

or

- ▶ Slide **⬆** the COMAND controller once or twice.



- ▶ Select **GERMANY** by turning **⤵** the COMAND controller and press **⏎** to confirm.

The address entry menu appears again.

GERMANY has now been entered.

Enter location

- ▶ Select **Town** in the address entry menu by turning **⤵** and sliding **⬆** the COMAND controller and press **⏎** to confirm. You see the list of towns with the character bar.

Town list with character bar

- ▶ Enter **BERLIN**. Instructions for entering characters can be found in the "Entering characters in navigation mode (entering a town)" section (▷ page 130).



- ▶ Confirm the entry with **⏎**. The address entry menu appears again.

To enter a street name

- ▶ Select **Street** in the address entry menu by turning **⤵** and sliding **⬆** the COMAND controller and press **⏎** to confirm.

You will see the street list either with the character bar (option 1) or as a selection list (option 2).

Option 1: street list with character bar

- ▶ Enter **UNSTRUTSTRASSE**. Instructions for entering characters using town input as an example can be found in the "Entering characters in navigation mode (entering a town)" section (▷ page 130).



Option 2: street list as selection list



Street list

- ▶ Select **UNSTRUTSTRASSE** by turning **Ⓢ** and pressing **Ⓢ** to confirm.
- ▶ Irrespective of the option, press **Ⓢ** to confirm your selection. The address entry menu appears again. **UNSTRUTSTRASSE** has now been entered.

Entering a house number

- ▶ Select **No.** in the address entry menu by turning **Ⓢ** and sliding **↑** and **↓** the COMAND controller and pressing **Ⓢ** to confirm. The character bar appears.
- ▶ Enter a house number. Instructions for entering characters using town input as an example can be found in the "Entering characters in navigation mode (entering a town)" section (▷ page 130).
- ▶ Confirm the entry with **Ⓢ**. The address entry menu appears again. **1** has now been entered.

To start route calculation

You can now have COMAND calculate the route to the address entered or save the address first, e.g. as your home address (home address) (▷ page 157). COMAND checks whether the destination is unambiguous. If the destination is ambiguous, further information is requested to define the destination unambiguously, e.g. an area of town or a postcode.



Address entry menu with destination address

- ① Destination address
- ② To start route calculation
- ▶ In the address entry menu, confirm **Start** by pressing **Ⓢ**. If no other route has been calculated, route calculation starts immediately (Option 1). If another route has already been calculated (route guidance is active), a prompt appears (option 2).

Option 1 – no route guidance active: route calculation starts. While route calculation is in progress, an arrow will indicate the direction to your destination. Below this, you will see the **Fast route is being calculated** message.

Once the route has been calculated, route guidance begins. If the vehicle is travelling on a non-digitised road, the system displays the linear distance to the destination, the direction of the destination and the **Street unknown** message.

Option 2 – route guidance is already active: if route guidance is already active, a prompt will appear asking whether you wish to terminate the currently active route guidance.

- ▶ Select **Yes** or **No** and press **Ⓢ** to confirm. If you select **Yes**, COMAND will stop route guidance and start route calculation for the new destination. If you select **No**, COMAND will continue with the active route guidance.

i Route calculation takes a certain amount of time. The time depends on the distance from the destination, for example. COMAND calculates the route using the digital map data.

The calculated route may differ from the ideal route, e.g. due to roadworks or incomplete map data. Please also refer to the notes about the digital map (▷ page 187).

Entering and storing your home address

You can either enter your home address for the first time (option 1) or edit a previously stored home address (option 2).

- ▶ **Option 1:** enter the address, e.g. a town, street and house number (▷ page 154).
- ▶ Once you have entered the address, select **Save** in the address entry menu by turning **⏮** and sliding **⬆** the COMAND controller and press **⏭** to confirm.
- ▶ Select **Save as "My Address"** and press **⏭** to confirm.
COMAND stores your home address as **My address** in the destination memory.
- ▶ **Option 2:** proceed as described under "Option 1".
A prompt appears asking whether the current home address should be overwritten.
- ▶ Select **Yes** and press **⏭** to confirm.
After selecting **Yes**, the **Save successful** message appears.

Entering a postcode

Entering a postcode will delete a previously entered town.

- ▶ Select **Postcode** in the address entry menu by turning **⏮** and sliding **⬆** the COMAND controller and press **⏭** to confirm.
You see the list of postcodes with the character bar.

List of postcodes with character bar

- ▶ Enter a postcode. Instructions for entering characters using town input as an example

can be found in the "Entering characters in navigation mode (entering a town)" section (▷ page 130).



- ▶ Confirm the entry with **⏭**.
If COMAND is able to assign the postcode unambiguously to a specific address, the address entry menu appears again. The postcode appears in place of the town's name.
If COMAND cannot assign the postcode unambiguously to a specific address, the address entry menu also appears again. The postcode is automatically entered. You can now enter the street for a more precise location. Only streets in the area covered by the entered postcode are available.
- ▶ Start route calculation (▷ page 156).

Entering a centre

Entering a centre will, for example, delete a previously entered street.

- ▶ Select **Centre** (centre) in the address entry menu by turning **⏮** and sliding **⬆** the COMAND controller and press **⏭** to confirm.
You will see the centre list either with the character bar (option 1) or as a selection list (option 2).

Option 1: centre list with character bar

- ▶ Enter a centre. Instructions for entering characters using town input as an example can be found in the "Entering characters in navigation mode (entering a town)" section (▷ page 130).



Option 2: centre list as a selection list



- ▶ Select a centre by turning the COMAND controller.
- ▶ Irrespective of the option, press to confirm your selection. The address entry menu appears again. The centre selected has been entered.
- ▶ Start route calculation ([▷ page 156](#)).

Entering a junction name

Entering a junction will delete a previously entered house number.

- ▶ Select **Junction** (junction) in the address entry menu by turning and sliding the COMAND controller and press to confirm.

You will see the junction list either with the character bar (option 1) or as a selection list (option 2).

Option 1: junction list with character bar

- ▶ Enter a junction. Instructions for entering characters using town input as an example can be found in the "Entering characters in

navigation mode (entering a town)" section ([▷ page 130](#)).



Option 2: junction list as selection list



- ① icon indicating more selection options
- ▶ Select a junction by turning the COMAND controller and press to confirm. Entries with the icon cannot be uniquely assigned. Another selection list is shown.
- ▶ Select an entry by turning the COMAND controller and press to confirm. The address entry menu appears again. The junction selected has been entered.
- ▶ Start route calculation ([▷ page 156](#)).

Ambiguity of town names

If several towns share the same name, you can also directly input or select a street name. COMAND then selects the town where the respective street is found.



- ▶ Enter a town as described above (▷ page 154).
- ▶ Select **ALL**.
- ▶ Enter or select the street name.
- ▶ Select the appropriate town.

If you know the town well, you can continue directly after selecting the town from the list.

Entering the street before the town

You can also enter the street name for an address directly without first entering a town. This is particularly useful if you wish to enter an address with an unusual street name. COMAND then searches automatically for towns with the respective street name.







- ▶ Select or enter the country as described above (▷ page 154).
- ▶ Select or enter the street.

Selecting a destination from the destination memory (e.g. home address)

Introduction

The destination memory always contains an entry named "My address". You may wish to assign your home address to this entry, for example (▷ page 157), and select it for route guidance. This entry is always located at the top of the list in the destination memory.

- ▶ **To activate navigation mode:** press the  function button once or twice.
- ▶ **To show the menu:** press  the COMAND controller.
- ▶ Select **Destination** in the navigation system menu bar by turning  the COMAND controller and press  to confirm.
- ▶ Select **From memory** and press  to confirm.
You will see the destination memory list either with the character bar (option 1) or as a selection list (option 2).

Option 1: destination memory list with character bar

- ▶ Enter a destination, e.g. "My address". Instructions for entering characters using town input as an example can be found in the "Entering characters in navigation mode (entering a town)" section (▷ page 130).



Option 2: destination memory list as a selection list



Destination memory list

- ▶ Select **My address** by turning $\left[\text{Ⓞ} \right]$ the COMAND controller.
- ▶ Irrespective of the option, press Ⓞ to confirm your selection. The address entry menu appears again. "My address" has been entered.



- ① Destination address
- ② To start route calculation

- ▶ **To start route calculation:** select **Start** and press Ⓞ to confirm.

Entering a destination from the list of last destinations

- ▶ **To activate navigation mode:** press the $\left[\text{TEL NAVI} \right]$ function button once or twice.
- ▶ **To show the menu:** press Ⓞ the COMAND controller.
- ▶ Select **Destination** in the navigation system menu bar by turning $\left[\text{Ⓞ} \right]$ the

COMAND controller and press Ⓞ to confirm.

- ▶ Select **From last destinations** and press Ⓞ to confirm.
- ▶ Select the desired destination by turning $\left[\text{Ⓞ} \right]$ the COMAND controller and press Ⓞ to confirm. The address entry menu appears again. The destination address selected has been entered.

- ▶ **To start route calculation:** select **Start** and press Ⓞ to confirm.

Once the route has been calculated, route guidance begins (▷ page 166).

- i** Further information on the "Last destinations" memory can be found on (▷ page 180).

- ▶ **To navigate to another street in the same town or to another house number on the same street:** call up an address destination from the last destinations.

- ▶ Select **Edit** by turning $\left[\text{Ⓞ} \right]$ and sliding $\uparrow \text{Ⓞ} \downarrow$ the COMAND controller and press Ⓞ to confirm.

All destination entry functions are available.

- ▶ Edit/enter the destination as described for destination entry (▷ page 153).

Entering a destination using the map

Calling up the map

- ▶ **To activate navigation mode:** press the $\left[\text{TEL NAVI} \right]$ function button once or twice.
- ▶ **To show the menu:** press Ⓞ the COMAND controller.
- ▶ Select **Destination** in the navigation system menu bar by turning $\left[\text{Ⓞ} \right]$ the COMAND controller and press Ⓞ to confirm.
- ▶ Select **Using map** and press Ⓞ to confirm. You see the map with the crosshair.

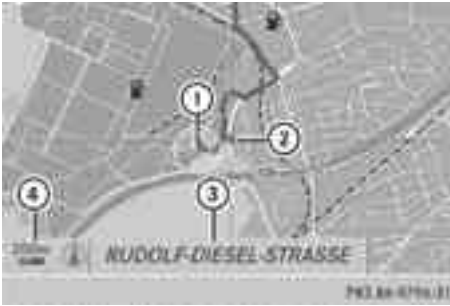

- ① Current vehicle position
- ② Crosshair
- ③ Details of the crosshair position
- ④ Map scale selected

Display ③ depends on the settings selected in "Map information in the display" (▷ page 184). The current road name can be shown, provided the digital map contains the necessary data, or the coordinates of the crosshair if the geo-coordinate display is switched on and the GPS signal is strong enough.

Moving the map and selecting the destination

- ▶ **To move the map:** slide ←→, ↑↓ or ↻ the COMAND controller.
- ▶ **To set the map scale:** as soon as you turn ↻ the COMAND controller, the scale bar appears.
- ▶ Turn ↻ until the desired scale is set. Turning clockwise zooms out from the map; turning anti-clockwise zooms in.
- ▶ **To select a destination:** press ↻ the COMAND controller.
If the crosshair is outside of the digital map, no complete route can be calculated for the destination.
- ▶ Select **OK** and press ↻ to confirm.
If the destination is within the limits of the digital map, COMAND attempts to assign the destination to the map.
If there are several navigation destinations for a crosshair, the selection is made using

a list of street names or special destination names.

If the destination can be assigned, you will see the address entry menu with the address of the destination. If not, you will see the [Destination from map](#) entry.

- ▶ **To start route calculation:** select **Start** and press ↻ to confirm.

Entering an intermediate stop

Introduction

When route guidance is active, you can enter an intermediate stop. Intermediate stops can be predefined destinations from the following categories that COMAND offers for selection:

- [Mercedes-Benz service](#)
- [Hospital](#)
- [Filling station](#)
- [Car park](#)
- [Restaurant](#)

However, you can also enter destinations other than the predefined ones. To do this select the menu item [Other](#).

You can use the intermediate stop function to influence route guidance to the main destination. When you have reached your intermediate stop, COMAND automatically recalculates the route to the main destination.

Entering predefined destinations

- ▶ **To activate navigation mode:** press the  function button once or twice.
- ▶ **To show the menu:** press ↻ the COMAND controller.
- ▶ Select [Destination](#) in the navigation system menu bar by turning ↻ the COMAND controller and press ↻ to confirm.
- ▶ Select [Stopover](#) and press ↻ to confirm.

Option 1: no intermediate stop has been entered yet.



Intermediate stop categories

- ▶ Select a category; see option 2.

Option 2: an intermediate stop has already been entered.

- ▶ Select **Change stopover** and press to confirm.
- ▶ **To select a category:** select a category by turning the COMAND controller and press to confirm.

COMAND first searches in the selected category for destinations along the route. If there are no destinations available there, COMAND searches for destinations within a radius of up to 100 km of the vehicle position.

If COMAND finds destinations, a list appears on the right-hand side of the display. The currently selected special destination is highlighted on the left-hand side of the map.

The intermediate stops are listed according to increasing distance from the current vehicle position. Approximate distances are shown with the additional character >.

- ▶ Select the intermediate stop by turning the COMAND controller and press to confirm.
The address entry menu appears, showing the destination address.
- ▶ **To start route calculation:** select **Start** and press to confirm.

If COMAND does not find any destinations, you will see a message to this effect.

- ▶ Confirm **OK** by pressing .
- ▶ Select a different category.

Entering another destination as an intermediate stop







- ▶ **To activate navigation mode:** press the function button once or twice.
- ▶ **To show the menu:** press the COMAND controller.
- ▶ Select **Destination** in the navigation system menu bar by turning the COMAND controller and press to confirm.
- ▶ Select **Stopover** and press to confirm.
- ▶ Select **Other** and press to confirm.
- ▶ Select **Address input**, **From memory**, **From last destinations** or **From POIs**.

Selection	Step
Address entry	▶ Enter a destination by address (> page 154).
From memory	▶ Select a destination from the destination memory (> page 159).
From last destinations	▶ Select a destination from the list of last destinations (> page 160).
From POIs	▶ Enter a special destination (> page 163).

- ▶ **To start route calculation:** once you have entered a destination, select **Start** and press to confirm.





Deleting an intermediate stop

If an intermediate stop has already been entered, you can delete it.

- ▶ **To activate navigation mode:** press the  function button once or twice.
- ▶ **To show the menu:** press  the COMAND controller.
- ▶ Select **Destination** in the navigation system menu bar by turning  the COMAND controller and press  to confirm.
- ▶ Select **Stopover** and press  to confirm.
- ▶ Select **Delete stopover** and press  to confirm.
COMAND deletes the intermediate stop and recalculates the route to the main destination.

Entering a POI

Initiating special destination entry

- ▶ **To activate navigation mode:** press the  function button once or twice.
- ▶ **To show the menu:** press  the COMAND controller.
- ▶ Select **Destination** in the navigation system menu bar by turning  the COMAND controller and press  to confirm.
- ▶ Select **From POIs** and press  to confirm.
A menu appears.

Entering a special destination in the vicinity of the destination

Entering a special destination in the vicinity of the destination is only possible when route guidance is active.

- ▶ Select **Destination area** from the menu and press  to confirm.



- ▶ Continue with assigning the special destination category. (▷ page 164)

Entering a special destination in the vicinity of the current position

- ▶ Select **Current position** and press  to confirm.
- ▶ Continue with assigning the special destination category. (▷ page 164)

Entering a special destination in the vicinity of a specific town

Option 1

- ▶ Select **Other town** in the menu and press  to confirm.
- ▶ Select the country, if desired (▷ page 154).
- ▶ **To enter a town:** select **Town** and press  to confirm.

Proceed as described in the "Entering a town" section (▷ page 154).



- ▶ After entering the town, select the special destination category (▷ page 164).

Option 2

- ▶ Enter an address in the address entry menu, e.g. a town, street and house number (▷ page 154).
- ▶ Select **POI** and press  to confirm.
- ▶ Select the special destination category (▷ page 164).

Entering a special destination using name search

This function allows you to access all the special destinations available on the digital map.

- ▶ Select **By name** from the menu and press  to confirm.
You will see a list of further selection options.
- ▶ Select the desired option and press  to confirm.
- ▶ Enter the name using the character bar.

Entering a special destination using the phone number search

This function gives you access to all special destinations that have a phone number.

- ▶ Select **By telephone number** and press  to confirm.
You will see a list of phone numbers.
- ▶ Enter the phone number using the character bar.

Assigning a special destination category

Introduction

The categories and special destinations available depend on the distance from the vehicle position you have set for the special destination.









- Special destination in the vicinity of the destination:
Alphabetically sorted categories, as well as special destinations in the vicinity of the target destination and sorted by distance are available.
- Special destination in the vicinity of the current position:
Alphabetically sorted categories are available, as well as special destinations in the vicinity of the vehicle position arranged by distance.
- Special destination within a given town:
If you have only entered the country and the town, alphabetically sorted categories and alphabetically sorted special destinations within the town are available.

If you have entered more than the country and the town, alphabetically sorted categories and special destinations in the vicinity of the address entered and arranged in order of distance are available.

- Special destination using name search:
An alphabetically sorted list of all special destinations is available.

The list sorts special destinations with the same name and in the same category according to distance, starting with those nearest to you.

Selecting a category

- ▶ Select a main category by turning    the COMAND controller.
- ▶ Confirm the entry with .
If the selected main category does not contain any sub-categories, the special destination list appears.
If the selected main category contains sub-categories, a list of the subcategories appears with the input speller.
- ▶ Select a category by turning    the COMAND controller.
- ▶ Confirm the entry with .

The special destination list appears. It contains the special destinations available in the sub-category that are within the search radius.

- i** Search radius means: COMAND searches within a radius of 100 km.
If COMAND does not find any special destinations within this radius, it extends its search range to approximately 200 km. If COMAND finds one special destination within this radius, it finishes the search.
- i** If you select the **ALL** list item, the special destination list contains all special destinations for all subcategories in the **Restaurant** main category which lie within the search radius.

Special destination list

Introduction

The illustration below shows an example of the special destination list for the **Restaurant** main category in the vicinity of the vehicle's current position.



Example display

- ① Special destination category
- ② Direction display to special destination starting from the current position
- ③ Linear distance to the special destination
- ④ Special destination
- ⑤ Selected category or sub-category

i Displays ② and ③ are not visible if you have entered a special destination within a given town and only the country and town have been entered.

Depending on the special destination selected, COMAND uses different reference points in determining the linear distance to the destination:

- vicinity of current position: the linear distance is the distance of the special destination from the current vehicle position.
- vicinity of destination: the linear distance is the distance from the destination entered to the special destination.

Selecting a special destination

- ▶ Select a special destination by turning the COMAND controller and press to confirm.

The complete address of the special destination selected is shown.



- ① Special destination with address
- ② To start route calculation
- ③ To store an address in the destination memory
- ④ To display details
- ⑤ Phone call
- ⑥ To display a special destination's position on the map

- ▶ **To start route calculation:** select **Start** and press to confirm.
- ▶ **To store an address in the destination memory:** select **Save** and press to confirm. You can now select storage options (▷ page 179).
- ▶ **To show the detailed view:** select **Details** and press to confirm.
- ▶ **To make a call:** select **Call** and press to confirm (only available if the special destination contains a telephone book entry and a telephone is connected to COMAND). COMAND switches to telephone mode (▷ page 200).
- ▶ **To call up the map:** select **Map** and press to confirm.
- ▶ You can move the map and select the destination (▷ page 160).

Selecting a special destination using the map

You can select special destinations that are available in the selected (visible) section of the map.

► **To activate navigation mode:** press the



function button once or twice.

► **To show the menu:** press the COMAND controller.



① Highlighted special destination

► Slide the COMAND controller forwards and thereby activate the display window. The map with highlighted special destination ① is shown.

► **To highlight the next special destination:** select **Next** in the menu bar by turning and sliding the COMAND controller and press to confirm.

► **To highlight the previous special destination:** select **Previous** in the menu bar by turning and sliding the COMAND controller and press to confirm.

► **To display details of a special destination:** select **Details** in the menu bar by turning and sliding the COMAND controller and press to confirm.

Route guidance

General notes

WARNING

COMAND calculates the route to the destination without taking account of the following, for example:

- traffic lights
- stop and give way signs
- parking or stopping restrictions
- lane narrowing
- other road and traffic rules and regulations

COMAND may give incorrect driving recommendations if the data on the digital map does not correspond to the actual conditions, e.g. the road layout has changed.

For this reason, you must always observe the respective road and traffic rules and regulations during your journey. Road and traffic rules and regulations always have priority over system driving recommendations.

Route guidance begins once a route has been calculated (► page 156).

COMAND guides you to your destination by means of navigation commands in the form of audible navigation announcements and route guidance displays.

The route guidance displays can only be seen if the display is switched to navigation mode.

If you do not follow the navigation announcements or if you leave the calculated route, COMAND automatically calculates a new route to the destination.

If the digital map contains the corresponding information, the following applies:

- when selecting a route, COMAND tries to avoid roads that only have limited access, e.g. roads closed to through traffic and non-residents.
- roads that have time restrictions (e.g. closed on Sundays and public holidays) are avoided for route guidance.

Change of direction

Introduction

Changes of direction have three phases:

- Preparation phase
- Announcement phase
- change-of-direction phase

Preparation phase

COMAND prepares you for the upcoming change of direction. Based on the example display below, the change of direction is announced with a message. You see the full-screen map.

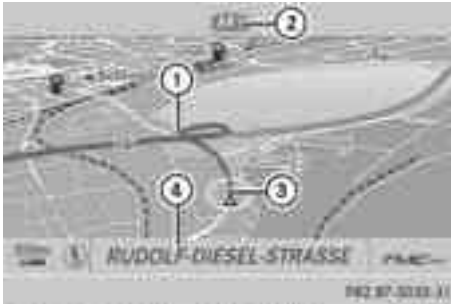

Example display: preparation phase

- ① Point at which the change of direction takes place (light blue dot)
- ② Next road
- ③ Current vehicle position (the tip of the triangle indicates the vehicle's direction of travel)
- ④ Current road

The display in ④ depends on the setting selected under "Text information on the map" (▷ page 184).

Announcement phase

COMAND announces the imminent change of direction. Based on the example display below, the change of direction is announced beforehand by the **Please turn right in 400 metres** message.

The display is now split into two sectors. In the left half, you see the normal map view. The right half shows an enlarged section of

the area around the junction (Crossing Zoom) or a 3D image of the road's course with the route indicating the next manoeuvre.

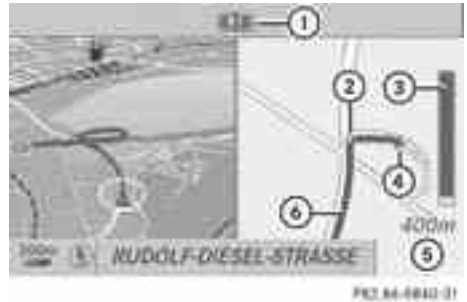

Example display: announcement phase

- ① Next road
 - ② Point at which the change of direction takes place (light blue dot, shown in both the left and right displays)
 - ③ Graphic representation of the distance to the next change of direction
 - ④ Change of direction (turn right here)
 - ⑤ Distance to the next change of direction
 - ⑥ Route (highlighted in blue, shown in both the left and right displays)
- i** The filled-in section of visual display for distance ③ gets shorter, the nearer you get to the announced change of direction.

change-of-direction phase

COMAND announces the imminent change of direction. Based on the example display below, the change of direction is announced 40 metres before the change of direction with the **Now turn right** message. The display is split into two halves, as in the announcement phase.

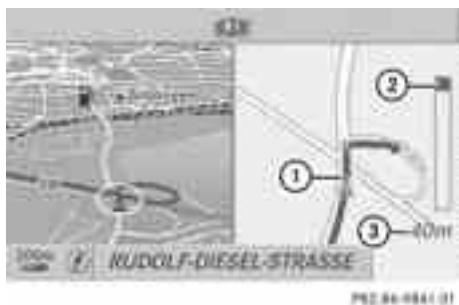

Example display: change-of-direction phase

- ① Current vehicle position: the tip of the triangle indicates the vehicle's direction of travel
- ② Graphic representation of the distance to the next change of direction
- ③ Distance to the next change of direction



Example display: roundabout

Once the change of direction is completed, COMAND automatically switches back to full-screen display.

Lane recommendations

Overview

On multilane roads, COMAND can display lane recommendations for the next change of direction. The corresponding data must be available in the digital map.

COMAND displays lane recommendations ⑥, based on the next two changes of direction. The number of lanes applies to the point at which the next change of direction is required.



Example of display: day design

- ① Point of the next change of direction
- ② Point of the change of direction after next
- ③ Direction display, number of junction and of motorway
- ④ Graphic representation of the distance to the next change of direction
- ⑤ Distance to the next change of direction
- ⑥ Recommended lane (dark blue)
- ⑦ Next change of direction (in this case, exit to the right)
- ⑧ Possible lanes (light blue)
- ⑨ Not recommended lanes (light brown)
- ⑩ Current vehicle position (the tip of the triangle indicates the vehicle's direction of travel)

i The multifunction display also shows lane recommendations, Only the recommended lanes are displayed here. (▷ page 397).

Display and description of lane recommendations

The colours used in the lane recommendation display vary depending on whether day or night design is switched on.

Lane	Day design	Night design
Recommended lane ⑥ In this lane, you will be able to complete the next two changes of direction without changing lanes.	Dark blue	Light blue
Possible lane ⑧ In this lane, you will only be able to complete the next change of direction without changing lanes.	Light blue	Dark blue
Lane not recommended ⑨ In this lane, you will not be able to complete the next change of direction without changing lane.	Light brown	Grey

Additional example displays

During the change of direction, there may be additional lanes which are displayed differently.







① New lane (dark blue)

Display in the multifunction display





The lane recommendations are also shown in the multifunction display. You will find further information in the "On-board computer" section (▷ page 397).

Canceling or continuing route guidance

Canceling route guidance

- ▶ **To activate navigation mode:** press the  function button once or twice.
- ▶ **To show the menu:** press  the COMAND controller.
- ▶ Select **Destination** in the navigation system menu bar by turning  the COMAND controller and press  to confirm.
- ▶ Select **Cancel route guidance** and press  to confirm.

Continuing route guidance

- ▶ **To activate navigation mode:** press the  function button once or twice.
- ▶ **To show the menu:** press  the COMAND controller.
- ▶ Select **Destination** in the navigation system menu bar by turning  the COMAND controller and press  to confirm.

- ▶ Select **Continue route guidance** and press  to confirm.
COMAND calculates the route.

Destination or area of destination reached

When you reach your destination, COMAND displays a chequered flag and route guidance is automatically ended.



For certain special destinations (e.g. airports), the **Destination reached** display is shown as well as the chequered flag.

Navigation announcements





Repeating navigation announcements

- i** Audible navigation announcements are muted during a telephone call.

If you have missed an announcement, you can call up the current announcement at any time.

- ▶ **To show the menu:** press  the COMAND controller.
- ▶ In the  navigation menu bar, press  to confirm.

Switching navigation announcements on/off





- ▶ **To switch off:** during the announcement, press the  button on the multifunction steering wheel.
You will briefly see the message: **The driving instructions have been muted.**
- ▶ **To switch on:** press  the COMAND controller.
- ▶ In the  navigation menu bar, press  to confirm.
- i** COMAND automatically switches the navigation announcements back on when:
 - it receives RDS-TMC traffic reports during dynamic route guidance

(▷ page 174) and recalculates the route accordingly.

- you have a new route calculated.
- you start the engine again after having left the vehicle.

Reducing volume during a navigation announcement

The volume of an active audio or video source can be automatically reduced during a navigation announcement.





- ▶ Select **Navi** in the main function bar by sliding  and turning  the COMAND controller and press  to confirm.
- ▶ Select **Audio fadeout** and press  to confirm.
The function is switched on or off , depending on the previous status.

Setting the volume manually

- ▶ Set the volume during a navigation announcement.
- or
- ▶ In the map display when the menu is shown, select  and adjust the volume.

Avoiding a section of the route blocked by a traffic jam



This function blocks a section of the route ahead of you. You can set the length of the blocked route section. If possible, COMAND calculates a detour around the blocked section of the route.

- ▶ **To activate navigation mode:** press the  function button once or twice.
- ▶ **To show the menu:** press  the COMAND controller.
- ▶ Select **Route** in the navigation system menu bar by turning  the COMAND controller and press  to confirm.
- ▶ Select **Detour** and press  to confirm.
- ▶ **To block a section of the route:** select **Longer** or **Shorter** repeatedly and confirm

using  until the desired section has been selected.





- i** The total length of the section that can be blocked is defined by the digital map. The menu items are available accordingly.



- ① Length of the blocked route section
 - ② Name of route section
 - ③ Blocked route section
- ▶ **To start route calculation:** select **Start** and press .
 - ▶ **To delete the blocked section:** select **Delete** while the message is shown and press  to confirm.
COMAND calculates the route without the block.

Selecting an alternative route

With the "Alternative route" function, routes other than the original one can be calculated.



- ▶ **To activate navigation mode:** press the  function button once or twice.
- ▶ **To show the menu:** press  the COMAND controller.
- ▶ Select **Route** in the navigation system menu bar by turning  the COMAND controller and press  to confirm.
- ▶ Select **Alternative route** and press  to confirm.

You see the selected route. The display now shows a split-screen view. On the left-hand side, one or more alternative routes are shown from start to destination. The cur-

rent route is highlighted dark blue; other alternative routes appear light blue.



- ① Distance, expected arrival time and expected journey duration
- ② Displays incidents which are on the route
- ③ Displays the selected route settings

- ▶ **To select the next or previous alternative route:** select **Next** or **Previous** and press  to confirm.
Possible alternative routes are shown in the following order: **Current route**, **Fast route**, **Eco route**, **Short route** and **Alternative route**.
- ▶ **To select the original route:** select **Back** a corresponding number of times and press  to confirm.
- ▶ **To start route guidance using the selected alternative route:** select **Start** and press  to confirm.
COMAND accepts the alternative route.

- i** The change of route mode in the alternative route menu only applies to the current route guidance. For example, if the original route was a short route, the next route will also be calculated as a short route. This is also the case if a dynamic route is selected in the alternative route menu.

Displaying destination information

Prerequisite: you have entered a destination (> page 153) and possibly an intermediate stop (> page 161).

- ▶ **To activate navigation mode:** press the



function button once or twice.

- ▶ **To show the menu:** press the COMAND controller.

- ▶ Select **Info** in the menu bar by turning the COMAND controller and press to confirm.

Destination information is displayed.

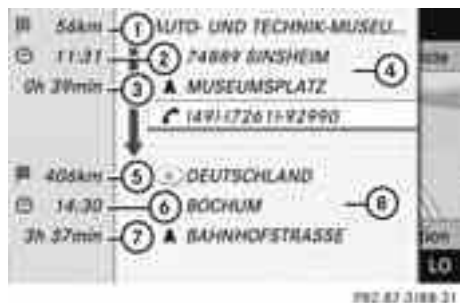

Example display: destination information

- ① Distance to intermediate stop
- ② Estimated time of arrival at the intermediate stop
- ③ Expected remaining journey time to intermediate stop
- ④ Intermediate stop
- ⑤ Distance to main destination
- ⑥ Estimated time of arrival at the main destination
- ⑦ Expected remaining journey time to main destination
- ⑧ Main destination

If a telephone number is entered for the address displayed, you can also select and call the number using COMAND.

- ▶ **To call the destination:** select the telephone number using the COMAND controller and press to confirm.

- ▶ **To close the destination information:** slide the COMAND controller or press the back button.

Route overview

You can use the overview of the route to move along the route section by section and to see details of the route sections.

You have entered a destination

(▷ page 153) or a special destination

(▷ page 163) and possibly an intermediate

stop (▷ page 161).

- ▶ **To activate navigation mode:** press the function button once or twice.

- ▶ **To show the menu:** press the COMAND controller.

- ▶ Select **Route** in the navigation system menu bar by turning the COMAND controller and press to confirm.

- ▶ Select **Route info** and press to confirm.



Example display: route overview

At the top of the display, you will see information about the highlighted route section, for example the distance to be driven on the road and road designation. The highlighted route section is marked in white with a red border on the map.

- ▶ **To view the next or previous route section:** select **Next** or **Previous** and press to confirm.

- ▶ **Info** If the first or last route section is highlighted, you cannot select **Previous** or **Next**.

- ▶ **To zoom in or out of the map:** select or and press to confirm.

- ▶ **To close the route overview:** select **Back** and press to confirm.

Where am I?

You can view your current position whether or not route guidance has been interrupted.



- ① Current position
- ② Next junction or exit
- ③ Most recent junction or exit
- ④ Current street

- ▶ **To activate navigation mode:** press the function button once or twice.

- ▶ **To show the menu:** press the COMAND controller.

- ▶ Select **Position** in the navigation system menu bar by turning the COMAND controller and press to confirm.

- ▶ Select **Where am I?** and press to confirm.

Off-road

Route guidance to a destination that is not on a digitised road

COMAND can guide you to destinations which are within the area covered by the digital map, but which are not themselves recorded on the map.

These destinations are known as off-road destinations, which you can enter using the map, for example. In these cases, COMAND guides you for as long as possible with navigation

announcements and displays on roads known to the system.



Example display: route guidance to an off-road destination

- ① Off-road destination
- ② Off-road route section (dashed blue)
- ③ Current vehicle position (the tip of the triangle indicates the vehicle's direction of travel)

A direction arrow is shown shortly before you reach the last known point on the map. The direction arrow shows the linear direction to the destination.

Route guidance from an off-road location to a destination

If the vehicle position is within the area covered by the digital map, but the map does not contain any information about that location, the vehicle is in an off-road location.

COMAND is also able to guide you to a destination even from an off-road location.

At the start of route guidance, you will see the **Street unknown** message, an arrow and the distance to the destination. The direction arrow shows the linear direction to the actual destination.

The continuous blue line on the map starts at the street which you left last.

As soon as the vehicle is back on a road known to the system, route guidance continues in the usual way.

Off-road during route guidance

Due to roadworks, for example, there may be differences between the data on the digital map and the actual course of the road.

In such cases, the system will temporarily be unable to locate the vehicle position on the digital map and thus considers the vehicle to be in an off-road position.

In the display, you will see the **Street unknown** message, an arrow and the distance to the destination. The arrow shows the compass heading to the last road you were driving on.

As soon as the system can assign the vehicle position to the map again, route guidance continues in the usual way.

Dynamic route guidance

Introduction

An RDS-TMC radio station transmits free-of-charge RDS-TMC traffic reports in addition to the radio programme. COMAND can receive the RDS-TMC traffic reports and take them into consideration for dynamic (traffic-dependent) route guidance. The navigation system can, for example, guide you around a traffic jam.

In Germany, COMAND uses the high-quality traffic data from T-Systems Traffic for the TMCPPro traffic jam warning system. This data is available 24 hours a day. In contrast to the public TMC service, TMCPPro uses exclusive traffic data that is detected with an automated sensor network, in addition to the messages generated by the TMC service. The traffic data received from the traffic jam warning services named above could differ.

There may also be differences between the traffic reports received and the actual road and traffic conditions.

The respective traffic data being received appears at the bottom right of the display with

the symbols "TMCPPro" or "TMC". If there is no reception, no symbol is displayed.

Switching dynamic route guidance on/off

- ▶ **To switch on:** select the **Dynamic route** or **Eco route**¹² route type (▷ page 152).
- ▶ **To switch off:** select the **Fast route** or **Short route** route type (▷ page 152).

i COMAND calculates a new route if you change the route type setting with route guidance active. If you change the route type setting when route guidance is inactive, COMAND uses the new setting for the next route guidance.

RDS-TMC displays on the map

COMAND can show certain traffic incidents on the map. These displays can be seen on map scales 50 m (0.05 miles) to 20 km (20 miles).

- ▶ **To set the map scale:** turn **[⊙]** the COMAND controller in the full screen view until the desired scale is selected.



Example display: traffic jam on the route

i COMAND uses corresponding icons to highlight the entire section of the affected route, regardless of how long the incident actually is. The icons are placed on the side of the carriageway affected by the incident.

¹² RDS-TMC and dynamic (traffic-dependent) route guidance is not available in all countries.

The following illustration shows the RDS-TMC icons used.

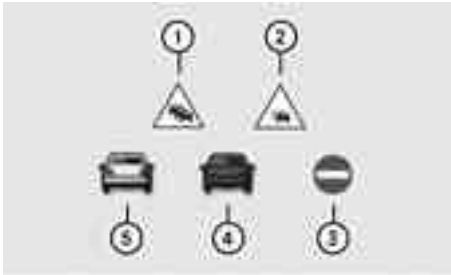

PS2 87-3194 31

RDS-TMC icons

- ① Traffic jam on the route (symbol has red outline)
- ② Slow-moving traffic on the route (symbol has red outline)
- ③ Road closure on the route
- ④ Traffic jam
- ⑤ Slow-moving traffic

Blocked route sections are shown by red crosses (XXXXXX) on the corresponding section.

Displaying RDS-TMC traffic reports

Displaying the report list

► **To activate navigation mode:** press the function button once or twice.

► **To show the menu:** press the COMAND controller.

► Select **TMC** in the navigation system menu bar by turning the COMAND controller and press to confirm.
COMAND scans for RDS-TMC stations within receiver range.

No RDS-TMC station found: a message to this effect appears.

► To close the message: confirm **OK** by pressing the COMAND controller.

RDS-TMC station found: COMAND scans for traffic reports.

If there are no traffic reports, you will see a message to this effect.

► To close the message: confirm **OK** by pressing the COMAND controller.

If there are traffic reports, you will see a list. The content of the list depends on whether route guidance is active.

List when route guidance is not active

The list shows all the roads, areas or regions for which reports are available.

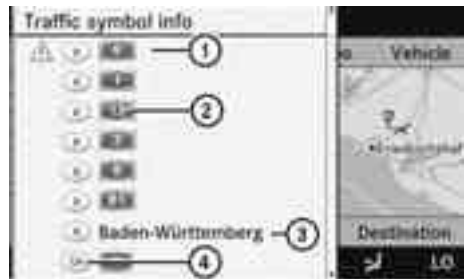

PS2 87-5048 31

- ① Warning message, e.g. message that a vehicle is travelling on the wrong side of the road
- ② Road affected
- ③ Area or region concerned
- ④ Country designation (only appears if there are reports from different countries)

A report may also relate to an area or region rather than a road, e.g. impaired visibility due to fog.

► **To show traffic report:** select a road (area, region) by turning the COMAND controller and press to confirm.

► **To show TMC icons:** select **TMC symbol info** by turning the COMAND controller and press to confirm.



Example display

- ① Affected section of motorway
- ② Icon for incident (traffic jam in the example shown)
- ③ Icon display for the section of route affected

► **To show the next/previous incident:** select **Next** or **Previous** (if available) and press to confirm.

► **To show the detailed view:** select **Details** and press to confirm.

► **To scroll the map:** select **Map** and press to confirm.

You can move the map (> page 161) to enable further traffic reports to be displayed.

List when route guidance is active

The list of messages on the route shows the roads, areas or regions on the route for which traffic reports are available.



- ① To display messages on route
- ③ To read aloud all messages regarding route (> page 177)

- ② To display all traffic reports (including those not concerning the route)
- ④ Information about the symbols displayed

► **To show all traffic reports:** select **Display all messages** and press to confirm.

You will see a list of all roads, areas or regions for which reports are available, including those that do not affect the route.

► **To show a traffic report:** select a street, an area or a region and press to confirm. You will find an example of a traffic report below.

► **To exit the list:** slide to the COMAND controller once or several times.

Example message



- ① Country designation
- ② Road, area or region for which there is a traffic report
- ③ Report 1 of 1 (example) for the road affected
- ④ Report text
- ⑤ Icon for report type (e.g. warning message)

The icons for possible report types are shown below.

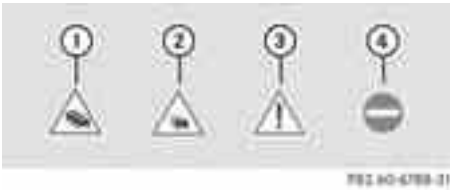

- ① Traffic jam
- ② Slow-moving traffic
- ③ Warning message
- ④ Road blocked

► **To scroll within a report or to access the next report:** turn the COMAND controller.

► **To return to the list of messages:** press or slide the COMAND controller.

Reading out traffic reports on the route

Calling up traffic reports

The read-aloud function is only available when route guidance is active. You can set the language (► page 150) and the text reader speed (► page 145).

► **To activate navigation mode:** press the function button once or twice.

► **To show the menu:** press the COMAND controller.

► Select **TMC** in the navigation system menu bar by turning the COMAND controller and press to confirm.

► Select **Read aloud all messages regarding route** and press to confirm. COMAND reads out the messages in sequence.

i The **Read aloud all messages regarding route** menu item has no function if there are no reports relating to the route.

► **To end reading aloud:** select **Cancel read-aloud function** and press to confirm.

or

► Press the button briefly.

The read-aloud function automatically interrupts COMAND as it recalculates the route following a new RDS-TMC traffic announcement.

Automatic read-aloud function

You can have TMC traffic reports on your route read aloud automatically. Announcements are made as you approach traffic incidents.

► **To switch the automatic read-aloud function on/off:** select **Navi** in the main function bar by sliding and turning the COMAND controller and press to confirm.

► Select **Read aloud traffic messages automatically** and press to confirm. The function is switched on or off , depending on the previous status.

Destination memory

Home address (My address)

Entering the home address via address entry

► Enter the home address as a destination, e.g. as a town, street and house number (► page 153). Then, save the home address without starting route guidance (► page 157).

Adopting an address book entry as a home address

► **To activate navigation mode:** press the function button once or twice.

► **To show the menu:** press the COMAND controller.

- ▶ Select **Destination** in the navigation system menu bar by turning **⏪** the COMAND controller and press **⏩** to confirm.
- ▶ Select **From memory** and press **⏩** to confirm.
- ▶ Slide **⏪** the COMAND controller repeatedly until the destination memory list appears as a selection list.



- ▶ Select **My address** by turning **⏪** the COMAND controller and press **⏩** to confirm.
- i** If you have not yet entered any characters, the **My address** entry is automatically highlighted in the selection list.

If no home address has been stored yet, you can now assign an address book entry. If a home address already exists, it is displayed and you can alter it.

- i** If you select **New entry**, you are also offered the option of entering the home address for the first time. You can then save the home address without starting route guidance.
- ▶ **To enter the home address for the first time:** select **Assign to address book entry** and press **⏩** to confirm.
- ▶ Select **Home** or **Work** and press **⏩** to confirm.

- ▶ **To change the home address:** select **Change** and press **⏩** to confirm.
 - ▶ Select **Assign to address book entry** and press **⏩** to confirm.
 - i** If you select **New entry**, you are also offered the option of changing the home address by entering an address. You can then save the home address without starting route guidance.
 - ▶ Select **Home** or **Work** and press **⏩** to confirm.
- In both cases, you will see the address book either with the character bar or as a selection list.

- ▶ **To select an address book entry:** proceed as described in the "Searching for an address book entry" section (▷ page 209).

- ▶ **To confirm the selection:** press **⏩** the COMAND controller.
- If no home address has been stored, COMAND saves the entry. You will see a message and then the address menu with the selected address. **Start** is highlighted automatically.
- If a home address has already been stored, you will see a prompt asking you whether the **My address** entry should be overwritten.

- ▶ Select **Yes** or **No** and press **⏩** to confirm.
- If you select **Yes**, COMAND overwrites the destination. You will see a message and then the address menu with the selected address. **Start** is highlighted automatically.
- If you select **No**, the list will reappear.

Selecting the home address for route guidance

- ▶ Proceed as described in the "Selecting a destination from the destination memory" section (▷ page 159).

Storing a destination in the destination memory

Note

This function also stores the destination in the address book.

After destination entry

- ▶ The destination has been entered and is shown in the address entry menu (▷ page 159).
- ▶ Select **Save** by sliding $\odot \downarrow$ and turning $\{\odot\}$ the COMAND controller and press \odot to confirm.
You can now select storage options.

During route guidance

- ▶ **To show the menu:** press \odot the COMAND controller.
- ▶ Select **Destination** in the navigation system menu bar by turning $\{\odot\}$ the COMAND controller and press \odot to confirm.
- ▶ Select **Save destination** and press \odot to confirm.
You can now select storage options.

From the list of previous destinations

- ▶ **To show the menu:** press \odot the COMAND controller.
- ▶ Select **Destination** in the navigation system menu bar by turning $\{\odot\}$ the COMAND controller and press \odot to confirm.
- ▶ Select **From last destinations** and press \odot to confirm.
The list of last destinations appears.
- ▶ Select a destination by turning $\{\odot\}$ the COMAND controller and press \odot to confirm.
The destination address is shown.
- ▶ Select **Save** and press \odot to confirm.
You can now select storage options.

Selecting storing options

- ▶ **To save the destination without a name:** select **Save without name** and press \odot to confirm.
COMAND stores the destination in the destination memory and uses the address as the destination name.
- ▶ **To save the destination as My address:** select **Save as "My Address"** and press \odot to confirm.
COMAND stores the destination in the destination memory as **My address**. If the entry already contains navigable data (symbol \downarrow), a prompt appears asking you whether the entry should be overwritten.
- ▶ Select **Yes** or **No** and press \odot to confirm.
If you select **Yes**, the entry is overwritten. If you select **No**, the process will be aborted.
- ▶ **To save the destination with a name:** select **Save with name** and press \odot to confirm.
- ▶ Select a category, e.g. **Home**, and press \odot to confirm.
The input menu appears with data fields and the character bar.

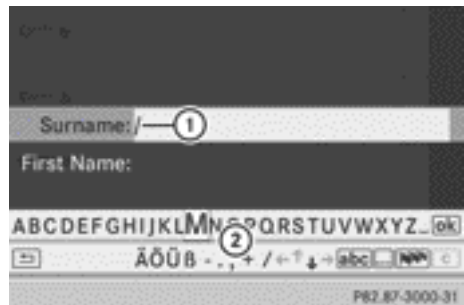

Example display: saving a destination with a name



- ① Selected data field with cursor
- ② Character bar
- ▶ Proceed as described under "Entering characters using the character bar" in the

"Entering characters in navigation mode (entering a town)" section (▷ page 153).



- ▶ Then, select **OK** and press  to confirm. COMAND stores the destination under the name entered.

Assigning a destination to an address book entry





An address with complete address data that is suitable for navigation can be assigned to a pre-existing address book entry. You can then later start route guidance to this address straight from the address book (▷ page 212).

- ▶ Select **Assign to address book entry** and press  to confirm.
- ▶ Select a category, e.g. **Home**, and press  to confirm. You will see the address book either with the character bar or as a selection list.
- ▶ **To select an address book entry:** proceed as described in the "Searching for an address book entry" section (▷ page 209). COMAND stores the data if the address book entry selected does not yet contain navigable address data. If the selected address book entry already contains navigable address data, a prompt will appear asking whether you wish to overwrite the existing data.
- ▶ Select **Yes** or **No** and press  to confirm. If you select **Yes**, COMAND stores the data.

Deleting a destination or the home address from the destination memory

- ▶ **To activate navigation mode:** press the  function button once or twice.
- ▶ **To show the menu:** press  the COMAND controller.
- ▶ Select **Destination** in the navigation system menu bar by turning  the

COMAND controller and press  to confirm.

- ▶ Select **From memory** and press  to confirm. You will see the destination memory list either with the character bar (option 1) or as a selection list (option 2).
- ▶ **Option 1: destination memory list with character bar:** proceed as described in the "Entering characters using the character bar" section (▷ page 130).
- ▶ **Option 2: destination memory list as selection list:** select a destination by turning  the COMAND controller and press  to confirm. You see the address data of the selected entry.
- ▶ Select **Delete** and press  to confirm. A prompt appears asking whether you wish to delete the destination.
- ▶ Select **Yes** or **No** and press  to confirm. If you select **Yes**, COMAND deletes the destination. You will see a message to this effect. If you select **No**, the process is aborted.
- ▶ **i** If the navigable address data for the destination being deleted is also assigned to an address book entry, COMAND will also delete this data from there. If the corresponding address book entry does not contain any further data, such as telephone numbers, COMAND deletes the entire address book entry.

Previous destinations

Introduction





COMAND automatically stores the previous destinations for which the route calculation has been started. If the memory is full, COMAND deletes the oldest destination. You can also save a destination from the list of

previous destinations in the destination memory. It will be stored there permanently.

Storing a destination permanently in the destination memory

- ▶ Proceed as described in the "From the list of previous destinations" section (▷ page 179).





Storing the vehicle position in the list of previous destinations

- ▶ **To activate navigation mode:** press the  function button once or twice.
- ▶ **To show the menu:** press  the COMAND controller.
- ▶ Select **Position** in the navigation system menu bar by turning  the COMAND controller and press  to confirm.
- ▶ Select **Store vehicle position** and press  to confirm.
COMAND stores the current vehicle position as a destination in the list of previous destinations.



Storing the crosshair position in the list of previous destinations

Route guidance not active









A crosshair appears on the map if you have moved the map manually. You can store the crosshair position as a destination in the list of previous destinations.

- ▶ **To show the menu:** press  the COMAND controller.
- ▶ Select **Position** in the navigation system menu bar by turning  the COMAND controller and press  to confirm.
- ▶ Select **Save crosshair position** and press  to confirm.

Route guidance is active

- ▶ Select **Destination** in the navigation system menu bar by turning  the COMAND controller and press  to confirm.
- ▶ Select **Save destination** and press  to confirm.

Deleting one of the previous destinations

- ▶ **To activate navigation mode:** press the  function button once or twice.
- ▶ **To show the menu:** press  the COMAND controller.
- ▶ Select **Destination** in the navigation system menu bar by turning  the COMAND controller and press  to confirm.
- ▶ Select **From last destinations** and press  to confirm.
The list of last destinations appears.
- ▶ Select the desired destination and press  to confirm.
The destination address appears.
- ▶ Select **Delete** and press  to confirm.
A prompt appears asking whether the entry should be deleted.
- ▶ Select **Yes** or **No** and press  to confirm.
If you select **Yes**, the entry is deleted.
If you select **No**, the process is aborted.

Map operation and settings

Note

Company logos displayed on the map are trademarks of the respective companies and used solely for the purpose of indicating the location of these companies. The use of such logos on the map does not indicate approval of, support of or advertising by these companies for the navigation system itself.

Setting the map scale

- ▶ **To hide the menu:** slide $\uparrow \odot$ the COMAND controller and, when the **Full screen** menu item is shown, press \odot .
- ▶ **To call up the scale bar:** as soon as you turn \odot the COMAND controller, scale bar ④ appears.
- ▶ Turn \odot until the desired scale is set.

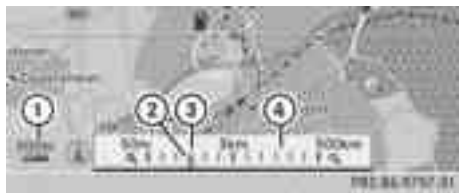

- ① Currently set map scale expressed as a number with unit, in this case 500 m
- ② New map scale
- ③ Currently set map scale as indicated by the needle on the scale bar
- ④ Scale bar

Unit of measurement ① in the COMAND display depends on the selection made for the instrument cluster.

Moves the map

Showing the crosshair

- ▶ **To hide the menu:** slide $\uparrow \odot$ the COMAND controller and, when the **Full screen** menu item is shown, press \odot .
- ▶ **To move the map:** slide $\leftarrow \odot \rightarrow$, $\uparrow \odot \downarrow$ or \odot the COMAND controller. A crosshair appears on the map. If you slide it again, the map moves in the corresponding direction under the crosshair.

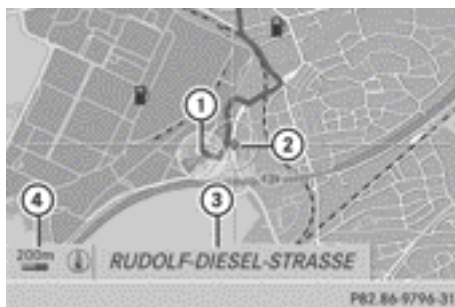

Map with crosshair

- ① Current vehicle position
- ② Crosshair
- ③ Details of the crosshair position
- ④ Map scale selected

Display ③ may be the name of a street, for example, provided the digital map contains the necessary data. Or it may show the geo-coordinate position of the crosshair if the **Geo-coordinates** display is switched on (▷ page 185).

Hiding the crosshair and centring the map on the vehicle position or destination

- ▶ Press the \leftarrow back button.

The crosshair disappears and the map is set to the vehicle position.



or

- ▶ Set the map to the vehicle position; see the explanation below.

Setting the map to the vehicle position, intermediate stop or destination position





Centring the map on the vehicle position

- ▶ **To show the menu:** press \odot the COMAND controller.
- ▶ Select **Position** in the navigation system menu bar by sliding $\odot \downarrow$ and turning \odot the COMAND controller and press \odot to confirm.

- ▶ Select **Vehicle position map** and press  to confirm or, if the crosshair is shown, press the  back button. This hides the crosshair.





Centring on an intermediate stop

This function requires that a route to an intermediate stop has been calculated.

- ▶ **To show the menu:** press  the COMAND controller.
- ▶ Select **Position** in the navigation system menu bar by sliding  and turning  the COMAND controller and press  to confirm.
- ▶ Select **Stopover map** and press  to confirm. The crosshair is centred on the destination.

Centring on the destination

This function requires that a route to a destination has been calculated.

- ▶ **To show the menu:** press  the COMAND controller.
- ▶ Select **Position** in the navigation system menu bar by sliding  and turning  the COMAND controller and press  to confirm.
- ▶ Select **Destination map** and press  to confirm. The crosshair is centred on the destination.

Map display











Setting the map orientation





Map orientation

- ① Current map orientation

The following display modes are possible:

-  North orientation (the map view is displayed so that north is always up).
 -  Orientation in direction of travel (the map is displayed so that the direction of travel is always up; the orange point of the icon points north).
 -  Bird's-eye view (the map is displayed so that the direction of travel is always up; the map projection reproduces the curvature of the earth and the orange point of the icon points north).
 -  3D map (the map is displayed with elevation and terrain modelling. The orange point of the icon points north).
- ▶ **To show the menu:** press  the COMAND controller.
 - ▶ Select **Navi** in the main function bar by sliding  and turning  the COMAND controller and press  to confirm.
 - ▶ Select **Map orientation** and press  to confirm. A  dot indicates the current setting.



- ▶ Select **North up**, **Heading up**, **Bird's-eye view** or **3-D map** by turning  the COMAND controller and press  to confirm.
- ▶ **To exit the menu:** slide  the COMAND controller. The map orientation changes accordingly.

Setting the special destination icons in the map

You can set the special destinations you wish to have displayed as symbols on the map. Special destinations are, for example, filling stations, hotels, cinemas and restaurants.

The following settings are possible:

- **Standard symbols**

Symbol display determined by the factory settings.



- **Personal symbols**

You can determine the symbols yourself.

- **No symbols**

The map does not show any symbols.



► **To show the menu:** press  the COMAND controller.

► Select **Navi** in the main function bar by sliding  and turning  the COMAND controller and press  to confirm.

► Select **POI symbols on map** and press  to confirm.

► Select **Standard symbols, Personal symbols** or **No symbols**.

If you select **Personal symbols**, the list of special destinations appears.

► **To switch the icon display on/off:** select a special destination by turning  the COMAND controller and press  to confirm.

Depending on the previous state of the symbols, they will either be shown or hidden . You can switch on the symbol displays for more than one special destination.

i The list shows all symbols that are contained on the digital map across all countries. However, not all special destinations are available in all countries. As a result, certain special destination symbols may not be displayed on the map, even if the symbol display is switched on.



► **To exit the menu:** press the  back button.

Map information in the display

Showing text information

During route guidance, you can have map information displayed at the bottom edge of the display.

► **To show the menu:** press  the COMAND controller.

► Select **Navi** in the main function bar by sliding  and turning  the COMAND controller and press  to confirm. The main area is active.

► Select **Navi** again and press  to confirm. The navigation menu opens.

► Select **Text information on map** and press  to confirm.

A • dot indicates the current setting.

► Select **Arrival time/distance, Current street, Geo-coordinates** or **None** and press  to confirm.

► **To exit the menu:** slide  the COMAND controller.

Arrival time/distance to the destination



Arrival time/distance display switched on

① Icon for destination

② Distance to the destination

③ Estimated time of arrival

You can only see this display during route guidance. While scrolling the map (▷ page 182), you will see additional data, e.g. road names, depending on the crosshair position, if the digital map supports this data.

Road display



Road display active

- ① Road name or designation

Geo-coordinate display



Geo-coordinate display active

- ① Current height above average sea level (rounded to the nearest 50 m)
- ② Current vehicle position: latitude coordinates
- ③ Current vehicle position: longitude coordinates
- ④ Number of GPS satellites currently being used

There must be sufficient GPS reception for all displays to be shown. If this is not the case, the display will be greyed out. Height display ① may vary from the actual value, because the navigation system uses the GPS signals for the calculation.

While scrolling the map (▷ page 182), you will see the geo-coordinates of the crosshair position. Height display ① and number of satellites used ④ are not displayed.

"None" menu option



Display switched off

- ① Current map orientation

i While scrolling the map, you can see additional data, depending on the position of the crosshair, such as a road name, if the digital map supports this data.

Speed Limit Assist

Information and requirements

If COMAND supports Speed Limit Assist and the function is switched on in COMAND, it can show the permissible speed limit in the display.

i The display appears if Speed Limit Assist detects traffic signs stating the maximum permissible speed. Speed Limit Assist detects these traffic signs using a camera.

Restricted speed limits may also be displayed.

Restrictions include:

- **when wet** – applies only if the road is wet
- **when icy** – applies only if the road is slippery (due to cold)
- **in fog** – applies only in foggy weather
- **temporary** – applies only during certain times
- **Limited** – COMAND cannot identify the type of restriction

If corresponding data is available, you see the information at the bottom left of the COMAND display directly above the map scale indicator, e.g. "120" or "80 when wet".



i The speed limits displayed may be incorrect if:

- the data is outdated.
- the camera has failed to identify a traffic sign correctly.

Further information about the Speed Limit Assist (▷ page 371).

Switching Speed Limit Assist on/off

► **To show the menu:** press  the COMAND controller.

► Select **Navi** in the main function bar by sliding  and turning  the COMAND controller and press  to confirm.



► Select **Speed Limit Assist** and press  to confirm.
Depending on the previous state, switch the option on or off .

Switching the topographical map on/off

The topographical map uses different colours to depict elevation. The colour key generally reflects the topography's dominant vegetation or the ground's perceived colour when seen from the air, for example:

- green for lowland
- yellow or brown for hills
- grey or white for mountains

► **To show the menu:** press  the COMAND controller.

► Select **Navi** in the main function bar by sliding  and turning  the COMAND controller and press  to confirm.

► Select **Topographical map** and confirm with .

Depending on the previous state, switch the option on or off .



Example of topographic map

Switching the city model on/off



When the city model is switched on, the map shows buildings as 3D models.

i The city model is only shown in the "3D map" map orientation.

It is available for map scales 50 m and 100 m.

The data required for displaying buildings is not available for all towns.

► **To show the menu:** press  the COMAND controller.

► Select **Navi** in the main function bar by sliding  and turning  the COMAND controller and press  to confirm.

► Select **City (3D)** and press  to confirm.
Depending on the previous state, switch the option on or off .



- ① Hills
- ② Buildings
- ③ Important buildings

Showing the map data version

- ▶ **To show the menu:** press the COMAND controller.
- ▶ Select **Navi** in the main function bar by sliding and turning the COMAND controller and press to confirm.
- ▶ Select **Map version** and press to confirm.
The map data version number is shown. Information about new versions of the digital map can be obtained from a Mercedes-Benz Service Centre.

Additional settings

Motorway information

When driving on motorways, you can have the nearest filling stations, rest areas, etc. shown on the right-hand side of the display. Your current distance to them is also shown on the right-hand side of the display.

- ▶ **To activate navigation mode:** press the function button once or twice.
- ▶ **To show the menu:** press the COMAND controller.
- ▶ Select **Navi** in the main function bar by sliding and turning the COMAND controller and press to confirm.
- ▶ Select **Motorway information** and press to confirm.
Depending on the previous state, switch the option on or off .

Compass function

You can display the current compass direction heading in which the front of the vehicle is facing.



- ① Current compass heading
- ② Geo-coordinates

In the compass view, you can see the current direction of travel, the current height above sea level and the co-ordinates of the vehicle position, for example.

- ▶ **To activate navigation mode:** press the function button once or twice.
- ▶ **To show the menu:** press the COMAND controller.
- ▶ Select **Position** in the navigation system menu bar by sliding and turning the COMAND controller and press to confirm.
- ▶ Select **Compass** and press to confirm.
- ▶ **To exit the display:** confirm **Back** by pressing or press the button.

Installing new map software

Digital map data

The maps generated by the map software become outdated in the same way as conventional road maps. Optimal route guidance can only be provided by the navigation system in conjunction with the most up-to-date map software.

Information about new versions of map software can be obtained from a Mercedes-Benz Service Centre.

You can have your map software updated there with a DVD, or you can update it yourself.

Entitlement to the free update

In some countries, it is possible to update the map data free of charge. For the first three years after your vehicle is registered, you are entitled to all available updates to the map software there. They are usually installed free of charge during your vehicle's annual service. You can also arrange a separate appointment for this at your Mercedes-Benz Service Centre. The free updates relate to the vehicle and not to an individual. If there is a change of ownership within the three years after first registration, the new owner is entitled to the map software updates.

The update can only be performed:

- at a Mercedes-Benz Service Centre
- for European navigation data

The map software is not provided on DVD.

Once the entitlement to free updates has expired, you can purchase updates at your Mercedes-Benz Service Centre.

Availability of free updates

Enter your e-mail address at www.mercedes-benz-accessories.com/comand-infomail. You will receive a one-off e-mail containing information on how to update the map software. Go to www.mercedes-benz-accessories.com/navigation-updates also, to find out if map software updates for your vehicle are available at your Mercedes-Benz partner.

Further information on the availability of this service can be obtained from a Mercedes-Benz Service Centre.

If the free update is not available in your country, please read the following sections. They provide information on how to purchase updates.

Updating process

WARNING







Never leave the engine running in enclosed spaces. The exhaust gases contain carbon monoxide. Inhaling exhaust fumes consti-

tutes a health hazard and could lead to loss of consciousness or even death.

The update process may take some time (over an hour), depending on the size of the digital map. During this time, you will only be able to switch on radio mode and to accept incoming calls. The update will be completed more quickly if the vehicle is stationary.

If the starter battery is not sufficiently charged, COMAND may end the process automatically. This preserves the battery. If this occurs, restart the update with the engine running.

Displaying information on the map version currently in use

- ▶ **To activate navigation mode:** press the  function button once or twice.
- ▶ **To show the menu:** press  the COMAND controller.
- ▶ Select **Nav**i in the main function bar by sliding  and turning  the COMAND controller and press  to confirm.
- ▶ Select **Map version** and press  to confirm.

Notes on handling DVDs

- Only hold DVDs by the edge.
- Handle DVDs carefully to prevent read errors.
- Avoid getting scratches, fingerprints and dust on DVDs.
- Use a commercially available cleaning cloth to clean discs. When cleaning CDs, you should wipe in straight lines from the centre outwards rather than in a circular motion.
- Place DVDs back in their cases after use.
- Protect DVDs from heat and direct sunlight.

Map software copy protection

Map software for COMAND is subject to a charge. The map software has just one activation code which is usable in one vehicle only, and is not transferable. You can obtain

the six-digit activation code from a Mercedes-Benz Service Centre. If you have lost the activation code, contact a Mercedes-Benz Service Centre. If COMAND does not accept the activation code that you have received, also contact a Mercedes-Benz Service Centre.

Your vehicle is supplied with map software at the factory. Depending on the country, map software for your region is either pre-installed or the map software is supplied as a DVD. You do not require an activation code for the map software that is provided with your vehicle. If the map software on your vehicle has been installed at the factory and you wish to reinstall it, this also does not necessitate entry of the activation code.

Installation process

- ▶ Load the map software DVD in the DVD drive (▷ page 223).

COMAND checks the DVD and shows a corresponding message in the display.

Map software is not compatible with the navigation system

You will see a message that the map software cannot be installed.

- ▶ **To confirm the message:** press . COMAND ejects the DVD.
- ▶ Take the DVD out of the slot.
- ▶ Insert a DVD which is compatible with the vehicle's navigation system.

Map software is not compatible with the current system software

You will see a message that the system software and the map software are not compatible.

- ▶ **To confirm the message:** press . COMAND ejects the DVD.
- ▶ Take the DVD out of the slot.
- ▶ Have the system software updated at a Mercedes-Benz Service Centre.

The map software cannot be installed until the system software has been updated.

Map software compatible with the navigation system and the current system software

COMAND checks whether the map data on the DVD is already installed.

Map data is already installed

You will see a message that the map data is already installed. A prompt will also appear asking you whether you wish to continue with the map software installation.

- ▶ Select **Yes** or **No**.
 - If you select **Yes**, the existing map data is overwritten.
 - If you select **No**, COMAND automatically ejects the DVD and the installation of the map software is cancelled.
- ▶ Take the DVD out of the slot.

Map data is not installed yet

In the display, you will see a comparison of the version statuses of the map software DVD and the map software installed in COMAND. A prompt then appears asking whether the map software installation should be carried out.

- ▶ Select **Yes** or **No**.
 - If you select **Yes**, the map data is installed.
 - If you select **No**, COMAND automatically ejects the DVD and the installation of the map software is cancelled.
- ▶ Take the DVD out of the slot.

If an activation code is required for the map software, a prompt appears in the display requesting the code to be entered.



- ▶ Enter the activation code and confirm the entry with **ok**.

The map software is installed.

If you enter an incorrect activation code, the prompt to enter the activation code appears again. If the activation code is entered incorrectly three times, the prompt asking you to enter the activation code appears after a time delay. The time delay increases every time the activation code is entered incorrectly, from five minutes up to a maximum of five hours.

Installing map data

Just before the copying process starts, COMAND restarts the system.

While the installation is running, you will see a message to this effect and a progress bar.

- ▶ **To cancel the installation process:** eject the DVD.

- ▶ Take the DVD out of the slot.

i If you interrupt the installation process, the navigation system will not be operational. You can continue an interrupted installation process at a later date.

- ▶ **Installation process with multi-DVD map data:** once the content of the first DVD has been installed, a message appears prompting you to insert the second DVD. Follow the instructions on the display.

- ▶ **To allow the installation to run to the end without cancelling:** take no further action.

When the installation process is successfully completed, you will see a message to this effect.

- ▶ **To confirm the message:** press . COMAND ejects the DVD.

- ▶ Take the DVD out of the slot. The installation is complete.

When the installation process is not successfully completed, you will see a message to this effect.

- ▶ **To confirm the message:** press . COMAND ejects the DVD.

- ▶ Take the DVD out of the slot.

Problems with the navigation system	
Problem	Possible causes/consequences and ► Solutions
COMAND is unable to continue route guidance after the journey has been interrupted.	<p>Route guidance is cancelled if you interrupt the journey for more than two hours.</p> <p>"Interrupting the journey" refers to stopping the vehicle and switching off COMAND. "Continuing route guidance" refers to switching COMAND back on and driving on.</p> <ul style="list-style-type: none"> ► Continue route guidance (▷ page 169). <p>COMAND determines the vehicle's position. Depending on the driving situation, this may take some time.</p> <p>Route guidance may be restricted during the determination of the vehicle's location.</p> <p>When positioning is complete, route guidance is resumed with navigation announcements and route guidance displays.</p>
COMAND is unable to determine the vehicle's position.	<p>COMAND has to redetermine the position of the vehicle if the vehicle has been transported (e.g. by ferry, by motorail or after towing).</p> <ul style="list-style-type: none"> ► Start the vehicle and pull away. <p>COMAND determines the vehicle's position. Depending on the driving situation, this may take some time.</p> <p>Route guidance may be restricted during the determination of the vehicle's location.</p> <p>When positioning is complete, route guidance is resumed with navigation announcements and route guidance displays.</p>
The Navigation function unavailable message appears.	<p>COMAND has an integrated hard drive on which the digital map is stored.</p> <p>To protect the hard drive from damage, COMAND switches it off at very high temperatures. The navigation system will then be temporarily unavailable.</p> <ul style="list-style-type: none"> ► Let the vehicle and COMAND cool down. ► To hide the message: switch COMAND off and then on again. <p>If an area of the hard disk has a fault, COMAND can no longer access the map data in this area, for example when calculating a route.</p> <ul style="list-style-type: none"> ► To hide the message: switch COMAND off and then on again. <p>The navigation system will be operational again until it has to access the faulty area of the hard drive once more. The message will then reappear.</p> <ul style="list-style-type: none"> ► Consult a Mercedes-Benz Service Centre.

Problem	Possible causes/consequences and ► Solutions
You see a message informing you that the DVD containing the digital map is incompatible with the system software.	<p>The DVD containing the digital map cannot be used for the update.</p> <p>► To confirm the message: press  the COMAND controller.</p> <p>► Eject the DVD.</p> <p>► Have the system software updated at a Mercedes-Benz Service Centre.</p>
The installation of the map software has failed.	<p>The DVD is dirty or scratched.</p> <p>► Clean the DVD.</p> <p>► Restart installation.</p>
	<p>There is overheating due to excessive temperatures in the vehicle interior.</p> <p>► Wait until the vehicle interior has cooled down.</p> <p>► Restart installation.</p>
	<p>COMAND's integral hard drive is faulty.</p> <p>► Consult a Mercedes-Benz Service Centre.</p>

Telephone

General notes

Introduction

COMAND offers two types of telephony:

- Bluetooth® interface telephony
- Convenience telephony

Basic telephony, in conjunction with a Bluetooth®-capable mobile phone, enables you to phone via the Bluetooth interface. Using the Bluetooth® interface and a suitable mobile phone, you can use the hands-free system, import contacts from the mobile phone and receive vCards.

If your vehicle is equipped with convenience telephony, you can obtain mobile phone brackets for specific mobile phones at your Mercedes-Benz Service Centre and have them installed in the armrest.

In the bracket, the mobile phone battery is charged and a connection is made to the vehicle's exterior aerial.

With a suitable mobile phone, convenience telephony offers you the functions of importing contacts and text messages (receiving or sending and reading or writing) in addition to the hands-free system.

- i** If your vehicle is equipped with convenience telephony, you can still connect a Bluetooth®-capable mobile phone to COMAND via the Bluetooth® interface.

You can obtain more detailed information about suitable mobile phones and about connecting Bluetooth®-capable mobile phones to COMAND from your Mercedes-Benz Service Centre or on the Internet (<http://www.mercedes-benz.com/connect>).

Safety notes

WARNING

You must observe the legal requirements for the country in which you are currently driving when operating mobile communications equipment in the vehicle.

If it is permitted to operate communications equipment while the vehicle is in motion, you may only operate such equipment when road and traffic conditions permit. You may otherwise be distracted from the traffic conditions, cause an accident and injure yourself and others.

Two-way radios or fax machines without low-reflection exterior aerials may interfere with the vehicle electronics and thereby compromise the operational safety of the vehicle and your safety. Therefore, only use these if they are properly connected to a separate, low-reflection exterior aerial.

WARNING

Excessive electromagnetic radiation may constitute a health hazard to yourself and others.

There is scientific discussion surrounding the possible health risks posed by electromagnetic fields. You can reduce this risk by using an exterior aerial.

Therefore, only use mobile communication equipment if it is connected to the exterior aerial of the vehicle.

Call disconnection while the vehicle is in motion

A call may be disconnected if:

- there is insufficient network coverage in certain areas.
- you move from one transmitter/receiver area (cell) into another and no channels are free.
- you use a SIM card which is not compatible with the network available.
- you are using a mobile phone with "Twin-card" and the mobile phone with the second SIM card is already logged into the network.

Operating options





You can operate the telephone by:

- using the COMAND controller:

turn .

slide  or .

press .

- the  or  button on the telephone keypad on the centre console
- the  or  button on the multifunction steering wheel
- using LINGUATRONIC (see the separate LINGUATRONIC operating instructions)
- rear-compartment handset

Unless otherwise indicated, the descriptions and illustrations in this section refer to COMAND and the telephone keypad. This also means that to carry out the functions described here, you must always be in the Telephone menu. The fastest way to access the Telephone menu is to press the  function button.

Function restrictions

You will not be able to use the telephone, will no longer be able to use the telephone, or you may have to wait before using it, in the following situations:

- when the mobile phone is switched off
- when the "Bluetooth®" function is switched off in COMAND
- when the "Bluetooth®" function is switched off on the mobile phone when telephoning via the Bluetooth® interface
- if the mobile phone is not logged into a mobile phone network

i The telephone automatically tries to log on to a network. If no network is available, you will not be able to make a "999" or "112" emergency call. If you attempt to make an outgoing call, the **No Service** message will appear for a short while.

- if you remove the key from the ignition lock during an active conversation in hands-free mode, the conversation may be continued for up to 30 minutes. At this point, it will be interrupted.

You can prevent this interruption as follows:

Bluetooth® interface telephony: switch the mobile phone to "Private mode" before switching off COMAND (see the mobile phone operating instructions).

Convenience telephony: remove the phone from its bracket before switching off COMAND.

If you wish to switch off COMAND during an active conversation in hands-free mode, the following message will appear: **You cannot switch off COMAND until you have finished your call.**

"999" or "112" emergency call

Making emergency calls without entering a PIN is only possible using the mobile phone. The following conditions must be fulfilled in order to make a **999** or **112** emergency call:

- the mobile phone must be switched on.
- a network must be available.
- a valid and operational SIM card must be inserted in the mobile phone.

If you cannot make an emergency call, you must arrange rescue measures yourself.

The **999** or **112** emergency call number is a public service. Any misuse is punishable by law.

Telephony via the Bluetooth® interface

Conditions

On the mobile phone

If your vehicle is equipped with convenience telephony and you wish to make calls via the Bluetooth® interface, your mobile phone should not be inserted in the mobile phone bracket or connected to the mobile phone bracket. Doing so could result in a malfunction, depending on the type of mobile phone.

For telephony via COMAND's Bluetooth® interface, a Bluetooth®-capable mobile phone is required.

Not all mobile phones available on the market are equally suitable. You can obtain more detailed information about suitable mobile phones and about connecting Bluetooth®-capable mobile phones to COMAND from your Mercedes-Benz Service Centre or on the Internet (<http://www.mercedes-benz.com/connect>).

The battery of the mobile phone should always be kept sufficiently charged in order to prevent malfunctions.

In preparation for telephoning via the Bluetooth® interface, you should check the following items on your mobile phone (see the mobile phone operating instructions):

- ▶ **Hands-Free Profile**
The mobile phone must support Hands-Free Profile 1.0 or above.
- ▶ **Information** Certain displays and functions (e.g. signal strength display, conference connection) are available, depending on the supported version of the Hands-Free Profile.
- ▶ **Bluetooth® visibility**
On certain mobile phones, the device itself must be made "visible" for other devices, as well as activating the Bluetooth® function (see the mobile phone operating instructions).
- ▶ **Bluetooth® device name**
Every Bluetooth® device has its own Bluetooth® device name. This device name is freely definable, but can be identical for all devices from the same manufacturer. It is therefore recommended that you change this name so that you can easily recognise your mobile phone (see the mobile phone operating instructions).
- ▶ **Switch on the mobile phone and enter the PIN when prompted to do so** (see the mobile phone operating instructions).

- ▶ Activate Bluetooth® functions and, where necessary, Bluetooth® visibility on the mobile phone (see the mobile phone operating instructions).

In COMAND

- ▶ Activate the Bluetooth® function in COMAND (▷ page 147).

To connect a mobile phone

General information

Before using your mobile phone with COMAND for the first time, you will need to connect it.







When you authorise a new mobile phone, it is connected automatically.

Connecting comprises:

- searching for a Bluetooth®-capable mobile phone
- subsequently authorising it

You can connect up to 15 mobile phones.



Searching for a mobile phone

- ▶ **To call up the telephone menu:** press the  function button once or twice.
- ▶ Select **Data/connections** in the telephone basic menu by sliding  and turning  the COMAND controller and press  to confirm.
- ▶ Select **Bluetooth telephones** and press  to confirm.
- ▶ Select **Update** and press  to confirm. COMAND searches for Bluetooth® telephones within range and adds them to the Bluetooth® telephone list.

The duration of the search depends on the number of Bluetooth® telephones within range and their characteristics.









Example of display: Bluetooth® telephones list

- ① Currently connected • and authorised mobile phone 
- ② Mobile phone not within range but previously authorised ( symbol appears in grey)
- ③ Newly detected mobile phone in range, not yet authorised 

The Bluetooth® telephones list shows all mobile phones within range and all previously authorised mobile phones, whether or not they are in range.

- ❗ If the Bluetooth® telephones list is already full, you will be requested to de-authorise a mobile phone (▷ page 197). If COMAND does not find your mobile phone, external authorisation (▷ page 196) may be necessary.

Authorising (registering) a mobile phone

- ▶ In the Bluetooth® telephones list, select the not yet authorised mobile phone by turning  and turning  the COMAND controller.
 - ▶ Select **Options** by sliding  the COMAND controller and press  to confirm.
 - ▶ Select **Authorise** and press  to confirm.
- or
- ▶ Press  to confirm the selected mobile phone.
The input menu for the passkey appears.

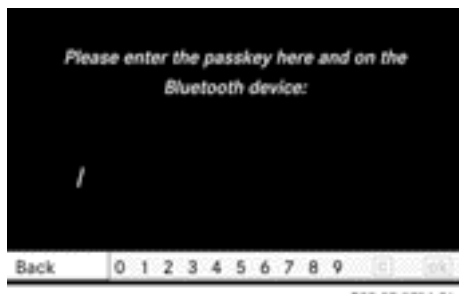

The passcode is any one to sixteen-digit number combination which you can determine yourself. You must enter the same number combination in COMAND and in the Bluetooth®-capable mobile phone (see the operating instructions of the mobile phone).

- Some mobile phones require the input of a four-digit passcode or longer number sequences.

If you want to re-authorise a mobile phone following de-authorisation, you can select a different passcode.

- ▶ **To enter a passcode in COMAND:** press the number keys in turn.
 can be selected after the first number has been entered.

or

- ▶ Select the digits one by one by turning the COMAND controller and press to confirm.
- ▶ **To confirm an entry in COMAND:** select using the COMAND controller and press to confirm.

or

- ▶ Select **SEND** on the telephone keypad.
- ▶ Now enter the same passcode in the mobile phone.

To make entries on the mobile phone: if the Bluetooth® connection is successful, you will be requested to enter the passcode (see mobile phone operating instructions).

- ▶ Enter the same passcode on the mobile phone that you entered in COMAND.

- After entering the passcode, you may also need to enter a confirmation in your mobile phone to connect calls. Please check your mobile phone display.

If the **Error during authorisation process** message appears on the COMAND display, you may have exceeded the allowed time. Repeat the procedure.

The mobile phone is connected to COMAND (authorised). You can now phone using the COMAND hands-free system.

External authorisation

If COMAND does not detect your mobile phone, this may be due to particular security settings on your mobile phone. In this case, you can test if your mobile phone can find COMAND. The Bluetooth® device name of COMAND is **MB Bluetooth**.

Observe the following: some mobile phones require that you reconnect to COMAND after you have entered the passcode (see the mobile phone operating instructions). The mobile phone cannot otherwise be authorised.

- ▶ Press the function button on the COMAND controller once or twice.
- ▶ Select **Data/connections** in the telephone basic menu by sliding and turning the COMAND controller and press to confirm.
- ▶ Select **Bluetooth telephones** and press to confirm.
- ▶ Select **Update**.
- ▶ Select **Options** by sliding and press to confirm.
- ▶ Select **External authorisation** and press to confirm.
- ▶ Start the Bluetooth® search on the mobile phone (see the mobile phone operating instructions).
- ▶ Select COMAND (**MB Bluetooth**) on the mobile phone.

- i** The order in which the passkey is entered depends on the mobile phone.
- ▶ Enter the passkey on the mobile phone when prompted.
- ▶ Confirm the **Do you want to authorise XX?** question in COMAND with **Yes**.
- ▶ Enter the passkey in COMAND.

Automatic reconnection

COMAND always searches for the last connected mobile phone.

If no connection can be made to the most recently connected mobile phone, the system searches for the mobile phone which was connected before that one.

Connecting another mobile phone

If you have authorised more than one mobile phone, you can switch between the individual phones.

- i** You can only switch to another authorised phone if you are not currently making a call.
- ▶ Select the mobile phone in the Bluetooth® telephones list by turning **⏻** the COMAND controller and press **⏻** to confirm.
The selected mobile phone is searched for and connected if it is within Bluetooth® range and if Bluetooth® is activated.
Only one mobile phone can be connected at any one time. The currently connected mobile phone is indicated by the **•** dot in the Bluetooth® telephones list (▷ page 195).

To display details

- ▶ Select **Data/connections** in the telephone basic menu by sliding **⊙↓** and turn-

ing **⏻** the COMAND controller and press **⏻** to confirm.

- ▶ Select **Bluetooth telephones** and press **⏻** to confirm.
- ▶ Select the desired mobile phone in the Bluetooth® telephones list.
- ▶ Select **Options** by sliding **⊙→** and press **⏻** to confirm.
- ▶ Select **Details** and press **⏻** to confirm.
The following information concerning the selected mobile phone is shown:
 - Bluetooth® name
 - Bluetooth® address
 - equipment class, e.g. telephone, computer
 - availability
 - authorisation status
- ▶ **To close the detailed view:** turn **⏻** or slide **⊙→** the COMAND controller.

De-registering (de-authorising) a mobile phone

Mercedes-Benz recommends de-authorisation in COMAND and on the mobile phone. Subsequent authorisation may otherwise fail.

- ▶ **To call up the telephone menu:** press the **TEL NAVI** function button once or twice.
- ▶ Select **Data/connections** in the telephone basic menu by sliding **⊙↓** and turning **⏻** the COMAND controller and press **⏻** to confirm.
- ▶ Select **Bluetooth telephones** and press **⏻** to confirm.
- ▶ Select the desired mobile phone in the Bluetooth® telephones list.

- ▶ Select **Options** by sliding and press to confirm.
- ▶ Select **De-authorise** and press to confirm.
A prompt appears asking whether you really wish to revoke authorisation for this device.
- ▶ Select **Yes** or **No**.
If you select **Yes**, the device will be deleted from the Bluetooth® telephones list.
If you select **No**, the process will be aborted.

i Before re-authorising the mobile phone, you should also delete the device name **MB Bluetooth** from your mobile phone's Bluetooth® list.

Telephone basic menu (Bluetooth® interface)

- ▶ **To call up the telephone menu:** press the function button once or twice.

If the mobile phone is ready for use, the following display appears:

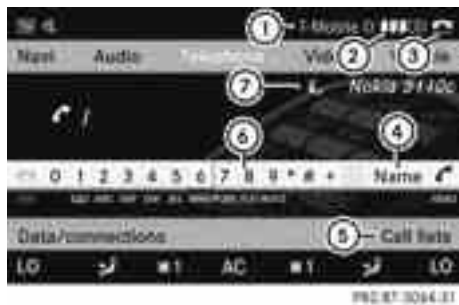

Example display: telephone basic menu (Bluetooth® interface)

- ① Network provider icon
- ② Signal strength of mobile phone network
- ③ Receiver icon or
- ④ To display the COMAND phone book
- ⑤ To display call lists

- ⑥ Character bar with characters for phone number entry
- ⑦ Bluetooth® name of the currently connected mobile phone

i Displays ① and ② are shown, depending on the mobile phone connected.

Bars ② display the current signal strength of the mobile phone network. If all the bars are filled, you have optimum reception. If all the bars are empty, there is very poor reception or none at all.

Receiver icon ③ shows whether a call is active/being connected or not .

Switching between Bluetooth® and convenience telephony

General notes

If your vehicle is additionally equipped with convenience telephony, you can switch to another telephony mode. You can then select another mobile phone in the Bluetooth® phone list.

Switching telephony type during operation

To switch the telephony type during operation, select the desired device in the Bluetooth® telephone list.

- ▶ Call up the Bluetooth® telephones list (▷ page 195).
- ▶ Select a mobile phone by turning the COMAND controller and press to confirm.

Switching telephony type when switching on

Note

COMAND starts the respective telephony mode depending on whether a mobile phone bracket is inserted.

Bracket for the mobile phone is inserted

COMAND starts convenience telephony.

If no mobile phone is in the mobile phone bracket, the following message appears: **Telephone not inserted**. Approximately two minutes after you start the engine, you are asked if you want to switch to Bluetooth® telephony.

If you confirm by selecting **Yes**, the **Ready for Bluetooth telephony...** message will appear. COMAND will search for the two mobile phones last connected via the Bluetooth® interface. If one of the two mobile phones is found, the telephone basic menu for Bluetooth® telephony (▷ page 198) appears. If neither of the two mobile phones is found, the **Ready for Bluetooth telephony...** message remains on the display. You now have to connect your mobile phone (▷ page 195).

If there is a mobile phone in the bracket, the telephone basic menu for convenience telephony (▷ page 215) appears.

Mobile phone bracket is not inserted

COMAND starts Bluetooth® interface telephony and searches for the last two mobile phones to have been connected via the Bluetooth® interface. If one of the two mobile phones is found, the telephone basic menu for Bluetooth® telephony (▷ page 215) appears. If neither of the two mobile phones is found, the **Ready for Bluetooth telephony...** message remains on the display. You now have to connect your mobile phone (▷ page 195).

i The Bluetooth® connection with the mobile phone remains active until the next time COMAND is switched off unless you connect a different mobile phone via the phone list. During Bluetooth® connection, only the Bluetooth® interface functions are available.

Reception and transmission volume

The following information is valid for Bluetooth® interface telephony and convenience telephony.

Once the mobile phone has been authorised, you can optimise the transmission and reception volume settings. To find out about the best possible settings for your mobile phone, contact a Mercedes-Benz Service Centre or visit <http://www.mercedes-benz.com/connect>.

i Incorrect settings may have a significant impact on the quality of calls.

- ▶ Press the **TEL NAVI** function button.
- ▶ Select **Data/connections** in the telephone basic menu by sliding **⊙↓** and turning **⌂⊙** the COMAND controller and press **⊙** to confirm.
- ▶ Select **Bluetooth telephones** and press **⊙** to confirm.
- ▶ Select an authorised mobile phone from the list by turning **⌂⊙**.
- ▶ Select **Options** by sliding **⊙→** and press **⊙** to confirm.
- ▶ Select **Reception volume** or **Transmission volume** and press **⊙** to confirm.

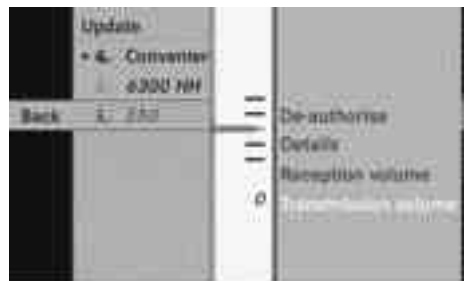

- ▶ **To set the volume on scale:** select by sliding **↑⊙↓** the COMAND controller and press **⊙** to confirm.

Telephone operation

Incoming call

Rejecting or accepting a call

When there is an incoming call, you see a corresponding window in the display.



- ▶ **To reject:** select **Reject** by turning the COMAND controller and press to confirm.

or

- ▶ Press the button on the telephone keypad or on the multifunction steering wheel.

- ▶ **To accept:** confirm **Accept** by pressing .

or

- ▶ Press the button on the telephone keypad.

or

- ▶ Press the or button on the multifunction steering wheel.

Once you have accepted the call, you can use hands-free mode. The call volume can be adjusted (▶ page 135). For more information, see the "Functions available during a call" section (▶ page 201).

The display shows the phone number or the name and phone number (if the entry is stored in the address book) or shows the **Unknown** (phone number withheld) message.

- i** You can also accept a call as described above when COMAND is showing the display of a different main application. The

display switches to the telephone display after a call is accepted using the COMAND controller or the telephone keypad. After the call is finished, you see the display of the previous main application again.

Making a call

Entering a telephone number using the telephone keypad

- ▶ Call up the telephone basic menu:
 - convenience telephony (▶ page 215)
 - telephony via the Bluetooth® interface (▶ page 198)
- ▶ Enter all the digits of the phone number using the telephone keypad.

- ▶ **To make a call:** press the button on the telephone keypad or on the multifunction steering wheel.

Entering a telephone number using the telephone basic menu

- ▶ Call up the telephone basic menu:
 - convenience telephony (▶ page 215)
 - telephony via the Bluetooth® interface (▶ page 198)

- ▶ Select the digits one by one by turning and sliding the COMAND controller and press to confirm.

- ▶ **To make a call:** select **SEND** from the telephone basic menu and press to confirm.

or

- ▶ Press the button on the telephone keypad or on the multifunction steering wheel.

Redial



- ▶ Call up the telephone basic menu:
 - convenience telephony (▶ page 215)
 - telephony via the Bluetooth® interface (▶ page 198)

- ▶ Press the  button on the telephone keypad.

or

- ▶ Select **SEND** from the telephone basic menu and press  to confirm.

In both cases, the calls dialled list appears. The most recently dialled number is at the top.

- ▶ **To select a call:** select an entry by turning  the COMAND controller and press  to confirm.

- i** The redialling function is also available using the on-board computer (▶ page 403).

Calling voicemail

This function is only available if it is supported by the mobile phone network provider.

You can only call voicemail if the voicemail number is stored as preset 1 on the SIM card.

- ▶ Press and hold the  button on the telephone keypad.

or

- ▶ Use the COMAND controller to select 1 and confirm until dialling commences.

Connecting a call to an entry on a call list or in the COMAND phone book

- ▶ Open a call list and select an entry (▶ page 213).

or

- ▶ Call up the COMAND phone book and select an entry (▶ page 209).

Functions available during a call

Overview



Telephone operation with a single call

- ① Person you are calling
- ② Icon for active telephone connection
- ③ **NEW** to call other parties¹³
- ④ To switch hands-free microphone on/off
- ⑤ To send DTMF tones (not possible with all mobile phones)
- ⑥ Ending a call

Switches the hands-free microphone on/off

This function is also available during an active phone call.

- ▶ Call up the telephone basic menu:
 - convenience telephony (▶ page 215)
 - telephony via the Bluetooth® interface (▶ page 198)
- ▶ **To switch off:** select **Mike off** and press  to confirm.

or



- ▶ Press the  button on the multifunction steering wheel.

If the microphone is switched off, the display shows the  symbol and the **The microphone has been switched off** message appears for a short period.



¹³ This function is only available if the telephone supports HFP1.5 and above.

- ▶ **To switch on:** select **Mike on** and press  to confirm.

or

- ▶ Press the  button on the multifunction steering wheel.
The  symbol disappears. You will briefly see the **The microphone is on** message.

Ends an active call

- ▶ Select  in the telephone basic menu and press  to confirm.

or

- ▶ Press the  button on the telephone keypad or on the multifunction steering wheel.

Call waiting, toggling and conference connections with several people

These functions are only available if they are supported by the mobile phone network provider. Furthermore, they are only available if the mobile phone supports HFP 1.5 or higher.

You can be called by more than one person (call waiting) while you are making a telephone call. In the same way, you can call another party while already on the phone with someone.

You can either toggle between these two conversations or interconnect them to create a conference call.

You can simultaneously switch back and forth between two parties or conduct a conference call with up to five others.

Call Waiting¹⁴

If you are on the telephone and you receive another call, the call waiting display will appear. You also hear a tone.

- ▶ **To reject:** select **Reject** and press  to confirm.

or

- ▶ Press the  button on the telephone keypad or on the multifunction steering wheel.

- ▶ **To accept:** select **Accept** and press  to confirm.

or

- ▶ Press the  button on the telephone keypad or on the multifunction steering wheel.
This will put the active call on hold. You now have two calls. The accepted call is active and the first call is on hold.

- i** If your mobile phone does not support HFP 1.5 or above, then the call which was active is cancelled as soon as the second call is accepted.

Calling additional parties

You can call a second person while on the phone with someone else. This action puts the previous call on hold.

- ▶ Select **NEW** from the telephone basic menu and press  to confirm.

or

- ▶ Select **SEND** on the telephone keypad.
- ▶ Enter the phone number manually (▷ page 200) or via the phone book (▷ page 211) or from the call lists (▷ page 213).



Switching between two parties (toggling)

If you have added another party to your previously active call, the telephone menu then looks like this:



- ① Active party
- ② Party on hold

¹⁴ This function is only available if Call Waiting has been activated on the mobile phone.

- ▶ **To switch to the other party:** select ② by turning  the COMAND controller and press  to confirm.

or

- ▶ Select **SEND** on the telephone keypad.

or

- ▶ Press the  button on the multifunction steering wheel.

Interconnecting to create a conference

You can interconnect calls which are active and those which are on hold. This permits several parties to hear one another and speak with one another.



- ① Active party
- ② Party on hold
- ③ To interconnect parties by creating a conference connection

- ▶ **To interconnect parties by creating a conference connection:** select **Conference** ③ by turning  the COMAND controller and press  to confirm.

Sending DTMF tones

This function is not supported by all mobile phones.

Answering machines or other devices can be controlled by DTMF tones, e.g. for remote query functions.

If you would like to listen to the messages on your answering machine, for example, select the corresponding number.



- ▶ Select **DTMF** from the telephone basic menu during a conversation.



- ① To transmit individual characters using the character bar
- ② To transmit a phone book entry as a character string

- ▶ **To transmit individual characters:** once a connection has been established to the answer phone, select the desired characters in the character bar and press  to confirm.

or

- ▶ **To send a phone book entry as a DTMF sequence:** select **Name** by turning  the COMAND controller and press  to confirm.

- ▶ Select the desired phone book entry and press  to confirm. The entry is sent as a DTMF character string.

- ▶ **To switch back to the call display:** select .

- i** You can also send DTMF tones by pressing the corresponding button on the telephone keypad or using LINGUATRONIC (see the separate operating instructions).

Transferring a call (convenience telephony)

Note

When using a bracket connected to the mobile phone via Bluetooth®: if you wish to continue a call in private mode, you will need to perform the necessary steps on the mobile

phone (see the mobile phone operating instructions).

From the hands-free system to the mobile phone

- ▶ Remove the mobile phone from the bracket and, if necessary, switch the mobile phone to "Private mode" (see the mobile phone operating instructions).

The **No telephone inserted** message appears in the COMAND display. Subsequent operation is only possible using the mobile phone.

From the mobile phone to the hands-free system

- ▶ Insert the mobile phone into the bracket. Once the call has been transferred to the hands-free system, all the functions will be available to you which are described in the "Functions available during a call" section (> page 201).

i It is also possible to continue calls that have been made using the Bluetooth® interface as private calls. To do this, you must deactivate Bluetooth® (> page 147).

Text messages (convenience telephony)

Information and requirements

The following conditions must be fulfilled in order to use the functions:

- the mobile phone is inserted in the bracket and switched on.
- the PIN has been entered.
- the mobile phone is logged into a mobile phone network.

When the mobile phone is connected, the 200 most recent text messages which are currently stored on the phone are loaded to COMAND's text message inbox and displayed. Text messages with more than one part reduce the number of text messages shown. Loading may take several minutes.

When the mobile phone is connected to COMAND via the bracket, newly received text messages will be displayed in COMAND's text message inbox. In addition, a tone sounds and the  icon appears.



Displaying the text message (SMS) inbox

Overview

- ▶ Press the  function button.
- ▶ Select **Text messages** in the telephone basic menu by turning  the COMAND controller and press  to confirm. The text message menu appears.







- ① New text message ( symbol for unread text message)
- ② Number of text messages in the inbox folder
- ③ Outbox
- ④ Drafts
- ⑤ To write a new text message
- ⑥ Text message inbox

- ▶ Select **Inbox** by turning  the COMAND controller and press  to confirm.





- ① Shortened text or sender of the selected text message
- ② Date and time at which the selected text message was received
- ③ Highlighted text message/symbol  for unread text message
- ④ Text messages already read

Reading a text message (SMS)

- ▶ Select a text message in the text message inbox by turning  the COMAND controller and press  to confirm. The text message appears.
- ▶ **To scroll through the display or select phone numbers in a text message:** slide  the COMAND controller. The display scrolls up or down line by line, or skips to the next or previous telephone number and automatically highlights it.
- ▶ **To return to the list:** slide  the COMAND controller.

Listening to a text message







- You can set the language (▶ page 150) and the speed of the read-aloud function (▶ page 145).
- ▶ Press  while a text message is being displayed, select **Read aloud** and press  to confirm. COMAND reads out the text message.
 - ▶ **To cancel the read-aloud function:** press the  button.

or





- ▶ Press  to confirm.

Switching the display

You can switch between displaying the text message sender or the text message content. The sender display shows the sender of the text message. If the sender is stored in the COMAND phone book, the name is displayed. Otherwise, the telephone number appears.

- ▶ Select a text message in the text message inbox by turning  the COMAND controller.
- ▶ **To switch to the text display:** select **Options** by sliding  the COMAND controller and press  to confirm.
- ▶ Select **Display text** and press  to confirm. The view changes.
- ▶ **To switch to the sender display:** select **Options** by sliding  the COMAND controller and press  to confirm.
- ▶ Select **Display sender** and press  to confirm. The view changes.



To display details

- COMAND can also show a shortened sender display in full.
- ▶ Select a text message in the text message inbox by turning  the COMAND controller.
 - ▶ Select **Options** by sliding  the COMAND controller and press  to confirm.
 - ▶ Select **Details** and press  to confirm. The detailed display appears.
 - ▶ **To close the detailed view:** slide  the COMAND controller.

Returning to the telephone basic menu



- ▶ Press the  back button.

Writing a new text message

- ▶ Select **New** in the "SMS" menu by turning  the COMAND controller and press  to confirm.



Entering the recipient

- ① Recipient of the new text message
 - ② To enter a telephone number using the address book
 - ③ Character bar
- ▶ **To enter the text message recipient via the phone book:** select ② by turning  the COMAND controller and press  to confirm.
 - ▶ Select the desired recipient from the phone book (▶ page 209).
 - ▶ **To enter the recipient's phone number manually:** use the COMAND controller to select the desired digits with character bar ③.

or

- ▶ Use the telephone keypad to enter the desired digits.
- i** You can also respond directly to a text message; the recipient will then be automatically accepted. To do this, simply select **Options** and then **Reply** in the text message inbox.



Entering a message

- ① Character bar
 - ② Text field for the text message
 - ③ To select or create text modules
 - ④ To insert a line break
 - ⑤ To switch between uppercase and lowercase letters
 - ⑥ To switch between numbers and letters
 - ⑦ To change the language of the characters
 - ⑧ Deleting characters
 - ⑨ Number of characters that can still be entered
- ▶ Use character bar ① to enter the desired text into text field ②.
 - ▶ Select **OK** and press  to confirm. The text message is sent.



i COMAND uses the standard GSM character set to send text messages. If other characters are used, COMAND automatically converts these into related characters.

i Text messages with more than one part cannot be forwarded.



If text messages are received that contain characters that are not in the GSM character set, these are replaced with underscores when the text message is forwarded.

Managing text messages



Calling a text message (SMS) sender

- ▶ Press  the COMAND controller while the text message is being displayed.
- ▶ Select **Call** and press  to confirm.
The telephone makes the call to the sender.

Storing the sender as a new address book entry





- ▶ Press  the COMAND controller while the text message is being displayed.
- ▶ Select **Save number** and press  to confirm.
- ▶ Select **New entry** and press  to confirm.
- ▶ Proceed as described in the "Storing as a new entry in the address book" section (▷ page 213).

Storing a text message sender in an existing address book entry

- ▶ Press  the COMAND controller while the text message is being displayed.
- ▶ Select **Save number** and press  to confirm.
- ▶ Select **Add** and press  to confirm.
- ▶ Proceed from the step "Select a number category" in the "Adding phone numbers to an address book entry" section (▷ page 213).

Deleting a text message (SMS)

This function is not supported by all mobile phones.

- ▶ Select a text message in the text message inbox by turning  the COMAND controller.
- ▶ Select **Options** by sliding  the COMAND controller and press  to confirm.
- ▶ Select **Delete** and press  to confirm.
A deletion prompt appears.
- ▶ Select **Yes** or **No** and press  to confirm.
If you select **Yes**, the text message is deleted.

If you select **No**, the process is aborted.

-  Text messages in the outbox or in drafts remain in COMAND even if you use COMAND with a different mobile phone. For this reason, you should delete any text messages before handing over or selling the vehicle.

Using the phone book and address book

The COMAND phone book is an extract of those entries from the address book which contain at least one telephone number.

In addition, the first entry in the phone book is "Mercedes-Benz Contact", which you can use to contact the Mercedes-Benz Customer Centre.

The address book organises and stores entries which are entered from different sources (mobile phone, SD memory card, Bluetooth® import, COMAND phone book, navigation). You can use these entries to make telephone calls and to navigate. You can create a maximum of 3000 address book entries.



Importing contacts automatically

COMAND automatically imports contacts from a mobile phone to the phone book.

Pre-requisite for this is that:

- basic telephony via the Bluetooth® interface is activated
- or convenience telephony using the mobile phone bracket is activated.

Depending on the mobile phone, this process may take some time. Depending on the mobile phone used, only the phone book entries in the mobile phone or these entries and the phone book entries from the SIM card are imported.

Automatically imported contacts in COMAND can be identified by the  /  symbol.

These entries are only available in COMAND when:

- basic telephony via the Bluetooth® interface is activated
- or convenience telephony using the mobile phone bracket is activated.

Importing contacts manually



- i** All the manually imported contacts remain in COMAND even if you use COMAND with a different mobile phone. The entries can be viewed without a mobile phone. Contacts created in COMAND can also be viewed without a mobile phone. For this reason, delete the phone book before selling or transferring ownership of your vehicle.

Existing contact data can be imported from the memory card manually.

- ▶ **To import data:** load the memory card.
 - ▶ Select **Data/connections** in the telephone basic menu by sliding $\odot \downarrow$ and turning $\left[\odot \right]$ the COMAND controller and press \odot to confirm.
 - ▶ Select **Download contacts** and press \odot to confirm.
 - ▶ Select **From Memory Card** and press \odot to confirm.
 - ▶ Select **Add** or **Overwrite** and press \odot to confirm.
- If the data has been imported, the **Import successful** message is displayed.

If the COMAND phone book memory is full, this message appears in the display: **Memory full. Not all contact data could be imported..**

- i** After the data has been imported, COMAND has to process it. The entries are only visible in the address/phone book when this is completed.

Receiving vCards via Bluetooth®

You can receive vCards from devices that support the sending of vCards via Bluetooth®. Such devices include PCs.

It is necessary to authorise the device in COMAND to do so. PCs have to be authorised via the Bluetooth® device list (\triangleright page 147).

Received vCards are imported into the address book.

Please bear the following in mind:

- Bluetooth® must be activated in COMAND and on the Bluetooth® device (\triangleright operating instructions of the device).
- the Bluetooth® device must be able to send vCards via Bluetooth® (\triangleright operating instructions of the device).
- the Bluetooth® device in the vehicle must be switched on.

- i** If you switch to another main function, e.g. navigation, while receiving vCards, the reception of vCards will be terminated.
- ▶ Select **Data/connections** in the telephone basic menu by sliding $\odot \downarrow$ and turning $\left[\odot \right]$ the COMAND controller and press \odot to confirm.
 - ▶ Select **Download contacts** and press \odot to confirm.
 - ▶ Select **Via Bluetooth** and press \odot to confirm.

This interrupts the Bluetooth® connection between COMAND and your active mobile phone. In turn, COMAND is ready to receive vCards from another Bluetooth® device.

- ▶ Start data transfer on the external Bluetooth device (▶ operating instructions of the device).
The data on the vCards is automatically transferred to the address book. The number of vCards received is displayed.



- ▶ **To cancel reception:** press .
- or
- ▶ Press the back button on the centre console.

Calling up contacts/details

You can call up contacts with the list or by using the character bar.



Phone book/address book basic display

- ① List
 - Entry with navigable data
 - Entry with voice tag; see the separate operating instructions for LINGUA-TRONIC
 - Address book entry
 - Mobile phone entry

- SIM card entry
- Entry imported via Bluetooth®
- Entry imported via memory card
- Entry with multiple phone numbers

- ② Two-line character bar
 - To change the language of the characters
 - To select the character set
 - To delete your selection
 - To confirm your selection
 - Back

Calling up contacts from a list

- ▶ Phone book: select **Name** in the telephone basic menu by sliding and turning the COMAND controller and press to confirm.
- ▶ Address book: select **Data/connections** in the telephone basic menu by sliding and turning the COMAND controller and press to confirm.
- ▶ Select **Address book** and press to confirm.
- ▶ **To switch from the character bar to the list:** slide the COMAND controller until the character bar is hidden.

- or
- ▶ Select .
- ▶ **To call a contact:** select by sliding or turning the COMAND controller and press to confirm.

i The phone book is also available via the on-board computer (▶ page 403).

Calling up contacts using the character bar

- ▶ Phone book: select **Name** in the telephone basic menu by sliding and turning the COMAND controller and press to confirm.
- ▶ Address book: select **Data/connections** in the telephone basic menu by sliding

⊙↕ and turning ↻⊙ the COMAND controller and press ⊙ to confirm.

▶ Select **Address book** and press ⊙ to confirm.

▶ **To select a character:** select by sliding ↑⊙↕ or ←⊙→ the COMAND controller and press ⊙ to confirm. Repeat this procedure until COMAND automatically switches over to the list.

You determine the first letter of the entry you are looking for with the first character you enter. If there are similar entries, the next character which is different will be displayed and offered for selection.

i You can also use the telephone number keypad to enter characters.

Creating new contacts/changing contacts

i In certain countries, this function is not available if the vehicle is travelling at more than approximately 5 km/h. As soon as the vehicle speed drops below about 3 km/h, the function is available again.

i You can enter address data directly into the address book. If you store contacts in the phone book, these are also saved in the address book.

i Automatically imported contacts cannot be edited. They have to be saved first before being copied to the COMAND address book.



▶ Call up the contact (> page 209)¹⁵.

▶ Select **Options** by sliding ⊙→ and turning ↻⊙ the COMAND controller and press ⊙ to confirm.

▶ Select **New entry** or **Edit** and press ⊙ to confirm.

The input menu with data fields appears.



① Entry mark (cursor)

② Data field

③ Two-line character bar

To select the language

To select the character set

To select uppercase and lowercase letters

Back

To delete your selection

To confirm your selection

④ Preset phone category

▶ Enter the respective data in the data fields.

▶ **To enter data in the data field:** select the respective characters from character bar ③.

▶ **To move the cursor in the data field:** select the respective characters from character bar ③.

▶ **To change data fields:** slide ↑⊙ the COMAND controller until the character bar is hidden.

¹⁵ Only available with the "Change contact" function.

- ▶ Slide \uparrow \odot \downarrow the COMAND controller and press \odot to confirm.
- or
- ▶ Press \downarrow in the character bar.
- ▶ **To cancel data entry:** select the \leftarrow symbol in character bar $\textcircled{3}$ and press \odot to confirm.
If one of the data fields contains data, a prompt will appear asking whether you wish to store the entry.
- ▶ **To save data entry:** select the ok symbol in character bar $\textcircled{3}$ and press \odot to confirm.
The entry is created in the phone book and in the address book.

Deleting contacts



- ▶ **To delete a group of contacts:** select **Data/connections** in the telephone basic menu by sliding \odot \downarrow and turning $\left\{ \odot \right\}$ the COMAND controller and press \odot to confirm.
- ▶ Select **Delete contacts** and press \odot to confirm.

You can select and delete the following types of contact here:

- **Internal contacts**
- **Imported from memory card**
- **Imported via Bluetooth**
- **Delete all**

- ▶ Confirm the selection by pressing \odot .
A prompt appears, asking whether the data should be deleted.
- ▶ Select **Yes** and press \odot to confirm.
- ▶ **To delete an individual contact:** select the entry (\triangleright page 209).
- ▶ Select **Options** by sliding \odot \rightarrow the COMAND controller and press \odot to confirm.
- ▶ Select **Delete** and press \odot to confirm.
A prompt appears, asking whether the data should be deleted.
- ▶ Select **Yes** and press \odot to confirm.
- i** Automatically imported contacts cannot be deleted (\triangleright page 207).

Calling a number stored in an entry

Using the phone book

- ▶ Select **Name** in the telephone basic menu by sliding \odot \rightarrow and turning $\left\{ \odot \right\}$ the COMAND controller and press \odot to confirm.
- ▶ Call up the contact (\triangleright page 209).
- ▶ **Contact with multiple telephone numbers (with the \blacksquare symbol):** press \odot .

or

- ▶ Press **SEND** on the telephone keypad.
A list of all telephone numbers is opened.
- ▶ Select the desired number by turning $\left\{ \odot \right\}$ the COMAND controller.
- ▶ Press \odot .

or

- ▶ Press **SEND** on the telephone keypad.
The number is dialled.
- ▶ **Contact with one telephone number (without the \blacksquare symbol):** press \odot .

or

- ▶ Press **SEND** on the telephone keypad.
The number is dialled.

- i** You can also use the phone book in the on-board computer to make a call (▷ page 403).

Using the address book

- ▶ Select **Data/connections** in the telephone basic menu by sliding $\odot \downarrow$ and turning $\{\odot\}$ the COMAND controller and press \odot to confirm.
- ▶ Select **Address book** and press \odot to confirm.
- ▶ Call contact (▷ page 209) and press \odot to confirm.
- ▶ Select the telephone number by turning $\{\odot\}$ the COMAND controller and press \odot to confirm.

Starting route guidance to an entry

- i** This function is available as soon as you have stored a destination in the destination memory (▷ page 179). COMAND also stores the destination in the address book with the complete navigable address data. In this case, navigation can be started without any further data input.

If the contact entry contains a postal address, e.g. as a result of importing a vCard, the system can also navigate to this address. If the data is incomplete or unclear, COMAND asks the user to enter the relevant address data. After the entry has been completed and navigation has been started, COMAND replaces the existing address with the navigable address if necessary.

- ▶ Search for an address book entry using the \odot symbol.
- ▶ Confirm the entry by pressing \odot . Telephone numbers and addresses are displayed.
- ▶ Select the address data field.

- ▶ Press the COMAND controller.
or
- ▶ Select **Options** by sliding $\odot \rightarrow$ the COMAND controller and press \odot to confirm.
- ▶ Select **Navigate** and press \odot to confirm.
- ▶ Select **Start** and press \odot to confirm.

Voice tags

- i** Voice tags are entered via LINGUATRONIC; see the separate operating instructions for LINGUATRONIC.

Adding or changing a voice tag



- i** You can add one voice tag per address book entry.
- ▶ Search for an address book entry with or without a voice tag (\odot) symbol).
- ▶ Select **Options** by sliding $\odot \rightarrow$ and turning $\{\odot\}$ the COMAND controller and press \odot to confirm.
- ▶ Select **Voice tag** and press \odot to confirm.
- ▶ Select **Add** or **Edit** and press \odot to confirm. Subsequent operation is voice-controlled. LINGUATRONIC guides you through the menus.

Deleting a voice tag

- ▶ Search for an address book entry with a voice tag.
- ▶ Select **Options** by sliding $\odot \rightarrow$ and turning $\{\odot\}$ the COMAND controller and press \odot to confirm.
- ▶ Select **Voice tag** and press \odot to confirm.
- ▶ Select **Delete** and press \odot to confirm. A deletion prompt appears.

Listening to a voice tag

- ▶ Search for an address book entry with a voice tag.
- ▶ Select **Options** by sliding $\odot \rightarrow$ and turning $\{\odot\}$ the COMAND controller and press \odot to confirm.

- ▶ Select **Voice tag** and press  to confirm.
- ▶ Select **Listen** and press  to confirm.
You will hear the voice tag.

Using call lists





Introduction

While the telephone is being used with COMAND, COMAND stores individual lists for both incoming and outgoing calls (including missed calls).

The respective menu item can only be selected if:



- calls have already been made or received in COMAND.
- the call lists have been imported from the telephone.

Opening the call list and selecting an entry

- ▶ **To call up the telephone menu:** press the  function button.
 - ▶ Select **Call lists** in the telephone basic menu by sliding  and turning  the COMAND controller and press  to confirm.
A menu appears.
 - ▶ Select **Incoming calls** or **Calls dialled** and press  to confirm.
The corresponding list appears.
- i** The list of calls made can also be opened by pressing the SEND button in the menu. This is possible as long as no phone numbers have been entered in the basic menu. The list of calls made can also be opened in the on-board computer.



Example display: list of calls made

- ① To close the list
 - ② Telephone number/name if known
 - ③ To call up options (e.g. save)
- ▶ Select an entry by sliding  the COMAND controller.
 - ▶ **To dial a phone number:** press the  button.
- or
- ▶ Press  to confirm.





Unanswered incoming calls have the  symbol in front of the name or phone number.



Saving a new phone number



Introduction



For incoming calls from a person who is not in the address book, COMAND displays the phone number in the call list. You can save this entry.



Storing a phone number as a new entry in the address book

- ▶ Open a call list and select an entry (> page 213).
- ▶ Select **Options** by sliding  the COMAND controller and press  to confirm.
- ▶ Select **Save number** and press  to confirm.
- ▶ Select **New entry** and press  to confirm.

- ▶ Select a category for the number, e.g. **Home**, and press  to confirm.
- ▶ Select a category for the phone, e.g. **Mobile number**, and press  to confirm.

Number category	Display (phone book and address book)
Unclassified	No symbol
Home	
Work	







Phone category	Display (phone book and address book)
Unclassified	No symbol
Mobile number	
Car	
Landline telephone number	
Preferred	<input checked="" type="checkbox"/>





- i** If you have not entered the phone number in a number and telephone category, the  symbol will appear in the display.
- ▶ Select **Next (save)** and press  to confirm.
An input menu with data fields is shown. The data field for the telephone number is filled in automatically.



- ① Data fields for surname, first name and company
 - ② Number category
 - ③ Phone category
 - ④ The data field for the telephone number is filled in automatically
 - ⑤ Two-line character bar
- ▶ Proceed as described under "Entering characters" in the "Entering characters in the address and phone books" section (▷ page 132).

Adding a phone number to an address book entry

- ▶ Open a call list and select an entry (▷ page 213).
- ▶ Select **Options** by sliding  to the COMAND controller and press  to confirm.
- ▶ Select **Save number** and press  to confirm.
- ▶ Select **Add** and press  to confirm.
The search menu for address book entries appears.
- ▶ Search for the desired entry (▷ page 209).
- ▶ Press  when you have finished searching.
- ▶ Select a category for the number, e.g. **Home**, and press  to confirm.

- ▶ Select a category for the phone, e.g. **Mobile number**, and press  to confirm.
- ▶ Select **Next (save)** and press  to confirm.
COMAND stores the data if there are fewer than five numbers assigned to the entry you are searching for.
You will see a message to this effect.
If five numbers are stored for the entry you are searching for, a prompt will appear asking whether you wish to overwrite one of the existing numbers.
- ▶ Select **Yes** or **No** and press  to confirm.
If you select **Yes**, a selection list with the five existing numbers appears.
If you select **No**, the process is cancelled.
- ▶ Select the number to be overwritten in the list by turning  the COMAND controller and press  to confirm.
COMAND overwrites the selected number with the new data.

Convenience telephony

Connecting a mobile phone

Establishing a connection







For convenience telephony with COMAND, a mobile phone bracket and a suitable mobile phone are required.

You can obtain more detailed information about suitable mobile phones and about connecting convenience telephones to COMAND from your Mercedes-Benz Service Centre or on the Internet at <http://www.mercedes-benz.com/connect>.

- ▶ Insert the bracket into the fixture in the armrest (see the vehicle Owner's Manual).
- ▶ Insert the mobile phone into the bracket (see the vehicle Owner's Manual).



Example

- ① To engage the mobile phone
 - ② Connector contact
 - ③ Mobile phone bracket
- ▶ Switch on the mobile phone (see the mobile phone operating instructions).
 - ▶ If Bluetooth® interface telephony is active: press the  function button on the centre console.
 - ▶ Select **Data/connections** in the telephone basic menu by sliding  and turning  the COMAND controller and press  to confirm.
 - ▶ Select **Bluetooth telephones** and press  to confirm.
 - ▶ Select **Convenience telephony** and press  to confirm.

Telephone basic menu (convenience telephony)

- ▶ Press the  function button.

When the mobile phone is inserted in the bracket and is operational, the following display is shown:

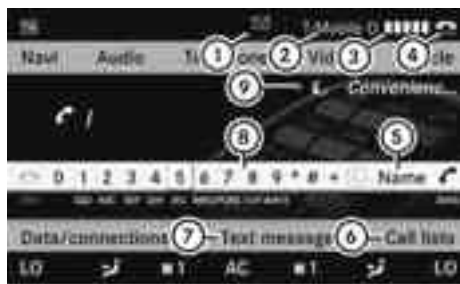

Example display: telephone basic menu, convenience telephony

- ① Received text message symbol
- ② Mobile phone network provider
- ③ Signal strength of mobile phone network
- ④ Receiver symbol (active) or (not active)
- ⑤ To display the COMAND phone book
- ⑥ To display call lists
- ⑦ Text message (SMS) menu
- ⑧ Character bar with characters for phone number entry
- ⑨ Convenience telephony display

Bars ③ display the current signal strength of the mobile phone network. If all bars are filled, you have optimum reception. If all bars are empty, there is very poor reception or none at all.

Receiver icon ④ shows whether a call is active/being connected or not .

The symbol is displayed if you have an unread text message. The symbol disappears once you have read the text message. The mail icon is displayed when the mobile phone's text message memory is full. The symbol disappears once you delete at least one text message.

The text message menu item is greyed out:

- when convenience telephony is active but no mobile phone is inserted in the mobile phone bracket
- when the inserted mobile phone is switched off

Contact Mercedes-Benz

Introduction

Mercedes-Benz Contact is ready to help at any time, e.g. if you have queries about your vehicle or if you need help in the event of a breakdown.

This function enables you to call the Mercedes-Benz Service Centre, subject to a fee. All important vehicle data is sent at the same time so that you receive optimum support.

The following data is transmitted:

- the vehicle identification number
- the total mileage
- the vehicle position
- the telephone number

You can make use of the function with an operational mobile phone connected to COMAND via the Bluetooth® interface or convenience telephony.

i Please note that Mercedes-Benz Contact is a Mercedes-Benz customer service. In emergencies, always call the national emergency services first, using the standard national emergency service telephone numbers.

i This service is available for vehicles from the following European countries:

- Belgium
- Germany
- France
- United Kingdom
- Ireland
- Italy
- Luxembourg
- Netherlands
- Austria
- Poland
- Switzerland
- Slovakia
- Spain

- Czech Republic
- Hungary

Calling the Mercedes-Benz Customer Centre

- ▶ Call up the COMAND phone book (▷ page 209)
The "MB Contact" entry is the first entry in the COMAND phone book. The entry is highlighted.

You now have two different ways of contacting the Mercedes-Benz Service Centre:

- ▶ Press  the COMAND controller.

or

- ▶ Press the  button on the telephone keypad.

This initiates a call. When the call is connected, a voice message prompts you to confirm the data transmission by entering the stated number via the COMAND control panel. After confirmation, COMAND sends the required vehicle data.

- i** Alternatively, you can initiate a call using the multifunction steering wheel (see the vehicle Owner's Manual).

Data transmission is shown in the display. This may take a moment. You can then select the desired service and are connected with a specialist at the Mercedes-Benz Customer Centre.

You can obtain further information on Mercedes-Benz Contact, the range of services offered and on using the function at your Mercedes-Benz Service Centre.

Audio

Radio mode and DAB radio mode

Introduction

- i** Portable electronic devices in the vehicle may seriously impair radio and DAB radio reception.

DAB (Digital Audio Broadcasting) is an optimised digital transmission standard designed for the mobile reception of radio transmissions. Several programmes are combined into so-called ensembles and transmitted on a single frequency. Digital radio stations can be transmitted nationally, regionally or locally.

Some stations only transmit programmes at certain times. If you have selected a station that is subsequently removed from the ensemble, it will no longer be received. You will continue to receive the other programmes in the ensemble. Select either a different programme or a different ensemble.

- i** DAB cannot be received everywhere in Europe.

Switching on radio mode and DAB radio mode

Option 1





- ▶ Press the  function button once or twice.

The radio or DAB radio display appears.

Radio mode: you will hear the last station played on the last waveband selected.

DAB radio mode: you will hear the last station played from the last ensemble selected.



Option 2

- ▶ Select **Audio** in the main function bar by sliding   and turning   the COMAND controller and press  to confirm.

If radio mode or DAB radio mode was the last mode selected, it is now active.

If another audio mode is switched on, you can now switch to radio mode in the audio menu.

You can select DAB radio mode in the radio display.

- ▶ Select **Audio** by sliding   the COMAND controller and press  to confirm.
The audio menu appears.



- ① Current audio operating mode
- ② Main function bar
- ③ Audio menu

► Select **Radio** by turning $\left[\odot \right]$ the COMAND controller and press $\left[\text{confirm} \right]$ to confirm.

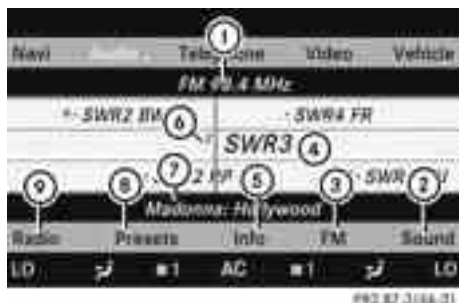

Radio mode

- ① Frequency of the selected station
 - ② Sound settings
 - ③ To show/switch waveband
 - ④ Name of the selected station
 - ⑤ Radio text transmitted from the station
 - ⑥ Preset position of the selected station
 - ⑦ Artist and track
 - ⑧ Preset options
 - ⑨ Radio options
- **To switch on DAB radio mode:** select **FM** in the radio display by sliding $\odot \updownarrow$ and turning $\left[\odot \right]$ the COMAND controller and press $\left[\text{confirm} \right]$ to confirm.

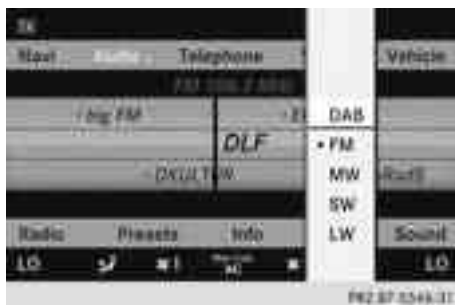

► Select **DAB** and press $\left[\text{confirm} \right]$ to confirm.

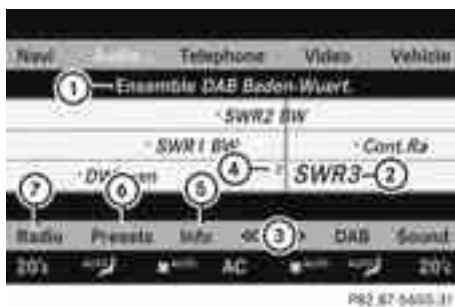

DAB radio display

- ① Name of the selected ensemble
- ② Abbreviated description of the selected station
- ③ To search for an ensemble
- ④ Number of the stored station
- ⑤ Text information of the selected station
- ⑥ Preset functions
- ⑦ Radio functions

Switching wavebands





You can switch the radio between the FM, MW, LW, SW and DAB wavebands.

- Select **Audio** by turning $\left[\odot \right]$ the COMAND controller and press $\left[\text{confirm} \right]$ to confirm.
- Select **Radio** and press $\left[\text{confirm} \right]$ to confirm.
- Select waveband display **FM**, **MW**, **LW**, **SW** or **DAB** and press $\left[\text{confirm} \right]$ to confirm.



- i** In the MW, LW and SW wavebands, COMAND shows the station frequency instead of the station name.

Searching for an ensemble (DAB radio mode)





An ensemble consists of multiple radio programmes. Every ensemble is transmitted in a certain area (national, regional or local) in the same way as a traditional AM/FM radio station.

- Select  or  in the DAB radio display by sliding  and turning  the COMAND controller and press  to confirm.

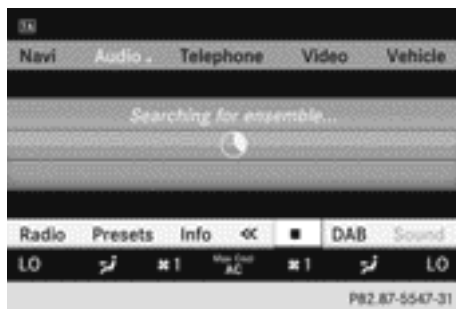
COMAND searches upwards or downwards for ensembles with adequate reception. You will see a message to this effect.

 or  changes to . The available stations of the next ensemble found are shown in the DAB radio display.



- **To cancel the search:** select  and press  to confirm. You will hear the last station played of the last ensemble selected. The  icon changes to  or .

Switching to an FM station automatically

If the reception of a DAB radio station deteriorates, COMAND automatically changes to the corresponding FM station if the following conditions are fulfilled:

- the FM station's frequency is available.
- the **Station fix** (▷ page 221) menu item is turned off

- i** If you want to use this function, do **not** switch to FM radio mode.

If there is no reception, the display shows the **No reception** message.







Selects a station

Selecting a station from the station list

The station list is available in the FM waveband and in DAB radio mode.

Radio mode: the list contains all the stations that can currently be received, and is sorted alphabetically. For stations without a programme service, the list shows the frequency instead of the name.

DAB radio mode: the list contains all the stations of an ensemble that can currently be received, and is sorted alphabetically.

- **Quick select:** turn  or slide  the COMAND controller while the display/selection window is active. The needle jumps to the left or right.
- **To make a selection in the station list:** select **Radio** by sliding  and turning  the COMAND controller and press  to confirm.
- Confirm **Station list** by pressing . The station list appears.



Example display: radio mode

① Currently selected station

② Memory slot in station presets

- ▶ Select the station by turning the COMAND controller and press to confirm.

Using the multifunction steering wheel

- ▶ Press or to select the **Audio** menu.

If station ② has been stored, the system displays the associated preset as well.

- ▶ Press and hold or .

Selects a station using the station search function

In radio mode, the station search function is only available for the MW, LW and SW wavebands.

Using the multifunction steering wheel

- ▶ Press or to select the **Audio** menu.

- ▶ Press and hold or .

Selecting stations via the station presets

- ▶ **Quick setting:** press a number key, e.g.

- ▶ **Directly in the station presets:** select **Presets** by sliding and turning

the COMAND controller and press to confirm.

or

- ▶ Press the COMAND controller when the display/selection window is active. The station preset memory appears. The
 - dot indicates under which preset the currently selected station is stored.
- ▶ Select a station by turning and press to confirm or press a number key, e.g.

Using the multifunction steering wheel

- ▶ Press or to select the **Audio** menu.

- ▶ Press or briefly.

Selecting stations by entering the frequency manually

This function is available in radio mode.

- ▶ Select **Radio** in the radio display by sliding and turning the COMAND controller and press to confirm.
- ▶ Select **Frequency input** and press to confirm. Irrespective of the option chosen, an input menu will appear.
- ▶ Enter a frequency using the number keys. COMAND tunes in to the frequency entered.

Waveband	Frequency
FM (VHF)	87.5 – 108.0 MHz
MW (medium wave)	531 – 1620 kHz
SW (short wave)	5800 – 6250 kHz
LW (long wave)	153 – 282 kHz

i You can only enter currently permitted numbers.

i If you enter a frequency in the MW, SW or LW wavebands that is outside the fre-

quency range, COMAND sets the next lower frequency.

Stores stations

Storing stations manually

There are 20 presets available for every waveband as well as for DAB radio mode.

► **Quick save:** press and hold a number key, e.g. **2**, until you hear a tone. For two-digit preset numbers, press the first number key briefly and then press and hold the second number key until you hear a tone. The station is stored.

► **Directly in the station presets:** press and hold **COMAND** the COMAND controller when the display/selection window is active.

or

► In the audio menu, select **Radio** by sliding **↕** or turning **COMAND** the COMAND controller and press **COMAND** to confirm.

► Select **Save station**.
The station preset memory appears. The

- dot indicates under which preset the currently selected station is stored.



Example display: station presets

- ① To store using Autostore
- ② Selected memory slot

► Select the memory slot by turning **COMAND** the COMAND controller and press **COMAND** to confirm.
The station is stored under the preset.

Storing stations automatically

This function automatically stores stations with adequate reception under the presets. The search starts at the lowest frequency. COMAND stores any stations found, beginning with preset 1. The storing process ends once the highest frequency has been reached or once ten stations have been found. Any stations stored manually under the presets will be lost. COMAND may not occupy all memory slots when storing.

► Select **Autostore** and press **COMAND** to confirm.
COMAND searches for stations with adequate reception. You will see a message to this effect. The available stations are automatically stored in the preset positions.

► **To cancel storing:** select **Cancel** and press **COMAND** to confirm.

Radio Data System (RDS)

General notes

The Radio Data System (RDS) provides inaudible additional information in the FM waveband. The system consists of a listening receiver and a monitoring receiver.

The monitoring receiver constantly scans the FM waveband and collects data from all the stations with adequate reception, e.g. reception quality and RDS data such as programme names and alternative frequencies. COMAND stores the data and constantly updates the memory. The audio receiver is therefore able to switch automatically to an alternative frequency with a better signal.

① RDS only functions for stations which transmit RDS data.

Switching RDS on/off

You can use the "Frequency fix" function to prevent COMAND from switching between different alternative frequencies of a station. This is useful, for example, when the same content is broadcast with a time delay, or when there is interference on one of the frequencies.

- ▶ Select **Radio** in the radio display by sliding and turning the COMAND controller and press to confirm.
- ▶ Select **Frequency fix** by turning the COMAND controller and press to confirm.
Depending on the previous state, switch **Frequency fix** on or off .

Traffic Programme

Note

Many FM stations transmit traffic announcements (TA). You can also hear these in DAB radio mode.

Switching traffic announcements on/off

- ▶ **Option 1:** select **Radio** by sliding and turning the COMAND controller and press to confirm.

The tick next to **TA** indicates that traffic announcement reception is switched on. You see the **TA** icon in the status bar.

- ▶ Select **TA** and press to confirm.
TA is switched on or off, depending on the previous status.
- ▶ **Option 2:** press and hold the button on the multifunction steering wheel until **TA** lights up or goes out in the status bar.
A tone sounds.

Once traffic announcements have been switched on, COMAND selects an RDS station.

The Traffic Programme is retrieved from:

- the currently selected FM station
- an RDS station from the network of the currently selected FM station
- the RDS station with the best reception quality

When traffic announcements are switched on, a traffic announcement will interrupt the audio signal from the currently activated audio or video source.

- ▶ Telephone conversations and navigation announcements are not interrupted.

A display message appears in the display in all audio operating modes.

Interrupting a traffic announcement

- ▶ Using the multifunction steering wheel, briefly press the button during a traffic announcement.

or

- ▶ Press the , or **OK** button on the multifunction steering wheel.
COMAND switches back to the audio source that was selected before the announcement. Any subsequent new announcements will continue to interrupt the audio source.

Radio text

This function is available in FM radio mode. Radio text consists of additionally transmitted data, e.g. information on the current programme, which is displayed in the COMAND display.

- ▶ Select **Info** in the radio display by sliding and turning the COMAND controller and press to confirm.
If the station supports radio text and information is available, the system displays it.



Radio text: example display

- ▶ **To return to the radio display:** press the button as often as necessary.

Radio Text Plus

Information such as the track and artist is shown in the display/selection window for certain RDS stations.

- ▶ **Activate/deactivate RDS:** (▷ page 221).

Sub-programmes (DAB radio mode)

Certain radio stations also broadcast sub-programmes. These include, for example, information on events taking place in a certain region or regional news.

- ▶ Select **Radio** in the DAB radio display by sliding and turning the COMAND controller and press to confirm.
- ▶ Select **Sub-programmes** and press to confirm.
The names of the main and sub-programmes appear, and you hear the corresponding information.
- ▶ Select a sub-programme by turning and press to confirm.

Audio CD/DVD and MP3 mode

Important safety notes

WARNING

COMAND is classified as a class 1 laser product. You must not open the casing. If you open the casing, or if the casing is faulty or damaged, there is a risk of exposure to invisible laser radiation. This may damage your eyes, or those of others.

COMAND does not contain any parts that can be serviced by the user. For safety reasons, all maintenance work must be carried out by qualified aftersales technicians.

WARNING

Only when the vehicle is stationary should you:

- load a disc
- eject a disc

There is a risk of being distracted from the road and traffic conditions if this is done while the vehicle is in motion.

Inserting/ejecting CDs/DVDs

Single DVD drive

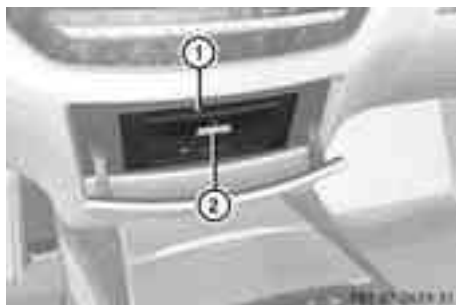

- ▶ **To load:** press button ②.
- ▶ Remove any CD/DVD which may be in slot ①.
- ▶ Insert the CD/DVD to be loaded into slot ①.
If the CD/DVD has been inserted properly and it is a permissible type, it will be drawn in and played.
- ▶ **To eject:** press button ②.
- ▶ Remove the CD/DVD from slot ①.
If the CD/DVD is not removed from slot ①, it will be automatically drawn in again after a short while and replayed.

DVD changer

The DVD changer has a fixed magazine with six trays.

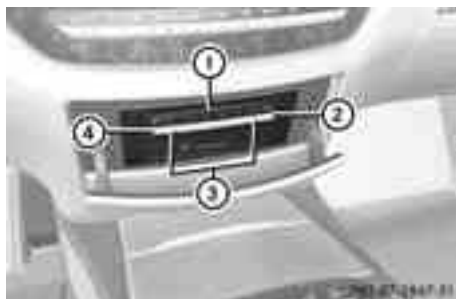

Magazine tray status ③:

- Indicator lamp off: magazine tray is empty.
- Indicator lamp constantly lit: magazine tray is loaded.

- ▶ **To load a single magazine tray:** press respective button ③.
- ▶ Remove any CD/DVD which may be in slot ①.
- ▶ Wait until the indicator lamp for button ③ which has been pressed flashes quickly.
- ▶ Insert the CD/DVD to be loaded into slot ①.
If the CD/DVD has been inserted properly and it is a permissible type, the last CD/DVD loaded will be played.

- ▶ **To load all six magazine trays:** press button ②.

The DVD changer checks the load status of all magazine trays and switches to the first empty tray.

- ▶ Wait until the indicator lamp for the respective button flashes quickly.
- ▶ Insert a disc into slot ①.
The DVD changer switches to the next empty magazine tray.
- ▶ Repeat the last two steps until all trays are loaded.
If the CD/DVD has been inserted properly and it is a permissible type, the last CD/DVD loaded will be played.

- ① If you remove one disc while playing another disc, the DVD changer interrupts playback. Playback continues once the disc has been removed.

- ▶ **To remove a disc:** press respective button ③.

- ▶ Remove the CD/DVD from slot ①.
If the CD/DVD is not removed from slot ①, it will be automatically drawn in again after a short while.

- ▶ **To remove all discs:** press button ④.
The DVD changer ejects the CD/DVD from the tray currently in use.

- ▶ Remove the CD/DVD from slot ①.
The DVD changer switches to the next loaded magazine tray and ejects the CD/DVD.
- ▶ Repeat the last step until the magazine is empty.

Loading and removing SD cards

- ① Not all SD memory cards are designed for the temperatures which may be reached in the vehicle.

Due to the wide range of SD cards available on the market, Mercedes-Benz cannot guarantee playback for all brands of SD memory card.



- ▶ **To load an SD card:** press the SD card into slot ①. The tapered side must point towards the right.
If the SD card contains MP3 tracks, COMAND will play them back.
- ▶ **To remove the SD card:** press the SD card into slot ① as far as it will go and then release it again.
- ▶ Pull out the card.

Activating audio CD/DVD or MP3 mode



Option 1

- ▶ Insert a CD/DVD (▷ page 223) or an SD card (▷ page 224) or connect a USB device (▷ page 235).
COMAND loads the medium inserted and starts to play it.





Option 2

- ▶ Press the  function button once or twice.
- ▶ Select an audio medium from the media list (▷ page 227).

Option 3

- ▶ Select **Audio** in the main function bar by sliding  and turning  the COMAND controller and press  to confirm. The last active audio source is now activated.

If another audio source is switched on, you can now switch to disc mode in the audio menu.

- ▶ Select **Audio** by sliding  and turning  the COMAND controller and press  to confirm. The audio menu appears.
- ▶ Select **Disc, Memory card, MUSIC REGISTER, Media Interface** or **USB** and press  to confirm. This switches to the desired audio source.
- ▶ Select an audio medium from the media list (▷ page 227).

Example display: audio CD mode

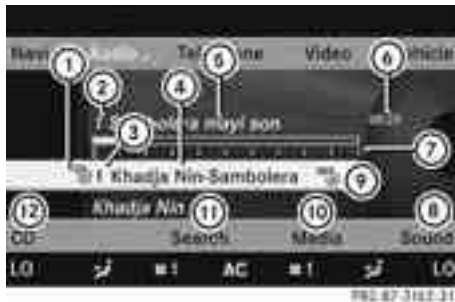

- ① Data medium type
- ② Track number
- ③ Disc number
- ④ Disc name (only if stored on the disc)
- ⑤ Track name (only if stored on the disc)
- ⑥ Track time

- ⑦ Graphic time and track display
- ⑧ Sound settings
- ⑨ Current playback option
- ⑩ Media selection
- ⑪ Music search
- ⑫ CD functions

Example display: audio DVD mode

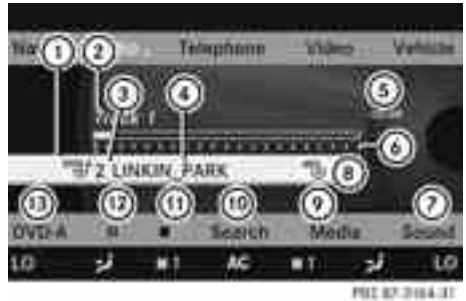

- ① Disc type
- ② Track name
- ③ Disc number
- ④ Disc name (only if stored on the disc)
- ⑤ Track time
- ⑥ Graphic time and track display
- ⑦ Sound settings
- ⑧ Current playback option
- ⑨ Media selection
- ⑩ Music search
- ⑪ Stop function
- ⑫ Pause function
- ⑬ Audio DVD mode

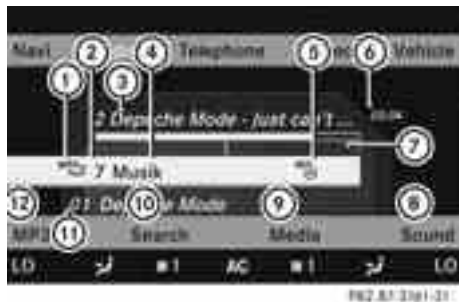

Example display: MP3 mode













- ① Disc type
- ② Disc number
- ③ File or track name (ID3 tags)
- ④ Disc or directory name
- ⑤ Current playback option
- ⑥ Track time
- ⑦ Graphic time and track display
- ⑧ Sound settings
- ⑨ Media selection
- ⑩ Music search
- ⑪ Artist (ID3 tags)
- ⑫ MP3 functions

Pause function

In audio CD/DVD and MP3 mode

















- ▶ **To pause playback:** briefly press the  button on the multifunction steering wheel.
- ▶ **To continue playback:** briefly press the  button on the multifunction steering wheel again.

Only in audio DVD mode

- ▶ **To pause playback:** switch on audio DVD mode (▷ page 224).
- ▶ Select  by sliding  and turning  the COMAND controller and press  to confirm.
The  display changes to .
- ▶ **To continue playback:** select  and press  to confirm.
Playback continues from the point where it was interrupted. The  display changes to .

Stop function

This function is only available in audio DVD mode.

- ▶ Switch on audio DVD mode (▷ page 224).
 - ▶ **To interrupt playback:** select  by sliding  and turning  the COMAND controller and press  to confirm.
The  display changes to .  remains highlighted.
 - ▶ **To continue playback:** select  and press  to confirm.
Playback continues from the point where it was interrupted.
 - ▶ **To stop playback:** while playback is interrupted, select  again and press  to confirm.
- or
- ▶ Select  and confirm by pressing  twice in rapid succession.
 is highlighted.
 - ▶ **To restart playback:** select  and press  to confirm.
Playback starts at the beginning of the DVD.

Selecting CD/audio DVD/MP3 discs

Selecting via the media list

- ▶ In **CD/audio DVD and MP3 mode**: select **Media** by sliding or turning the COMAND controller and press to confirm. The media list appears. The dot indicates the currently selected medium.



Media list

The media list shows the discs currently available.

Media list (when equipped with a DVD changer)

Magazine trays, positions 1 to 6: readable data media are audio CDs, MP3 CDs or MP3 DVDs, audio DVDs and video DVDs.

Memory card, position 7

MUSIC REGISTER, position 8

Media Interface, position 9

USB, position 10

- If a disc cannot be read, an entry appears after the display in the magazine tray.

Equipped with a single DVD drive

DVD drive, position 1: readable data media are audio CDs, MP3 CDs or MP3 DVDs, audio DVDs and video DVDs.

Memory card, position 2

MUSIC REGISTER, position 3

Media Interface, position 4

USB, position 5

- ▶ Select the data medium by turning the COMAND controller and press to confirm.

- If you select a video DVD, the system switches to video DVD mode (▷ page 248).

Selecting a track using the number keypad

- ▶ Press a number button, e.g. , when the display/selection window is active. The medium at the corresponding position in the media list is loaded and then played.

Selects a track

Selecting by skipping to a track

- ▶ **To skip forwards or back to a track**: slide or turn the COMAND controller when the display/selection window is active.

The skip forward function skips to the next track.

Skipping backwards restarts the current track (if it has been playing for more than 8 seconds) or starts the previous track (if the current track has only been playing for a shorter time).

If you activate the **Medium mix** or **Track list mix** playback option (MP3 mode only), the track order is random.

- ▶ **On the multifunction steering wheel**: switch COMAND to audio CD, audio DVD or MP3 mode (▷ page 224).
- ▶ Press or to select the **Audio** menu.
- ▶ Press the or button on the multifunction steering wheel.

Selecting by track list

- ▶ In audio mode, select **Search** by sliding $\odot \downarrow$ or turning $\{\odot\}$ the COMAND controller and press \odot to confirm.

- ▶ Select **Current track list**.

or

- ▶ Press \odot the COMAND controller in audio mode when the display/selection window is active.

- ▶ Select **Current track list** by turning $\{\odot\}$ the COMAND controller and press \odot to confirm.

- ▶ Select the track by turning $\{\odot\}$ and press \odot to confirm.

i In MP3 mode, the list shows all the tracks in alphabetical order.

- ▶ **On the multifunction steering wheel:** switch COMAND to audio CD, audio DVD or MP3 mode (▷ page 224).

- ▶ Press \blacktriangleleft or \blacktriangleright to select the **Audio** menu.

- ▶ Press and hold the \blacktriangleup or \blacktriangledown button until the desired track has been reached.

If you hold down \blacktriangleup or \blacktriangledown , the system runs through the list more quickly. Not all audio drives or data carriers support this function.

If track information is stored on the audio drive or data storage device, the multifunction display shows the number and name of the track.

Selecting a track using the number keypad

- ▶ Press the $\boxed{* +}$ button on the number keypad.

A numerical entry field appears. The number of positions offered corresponds to the number of tracks on the CD/DVD. Only numbers that correspond to a track number on the CD/DVD can be entered.

- ▶ Enter the desired track number using the number buttons.

Fast forward/rewind

- ▶ While the display/selection window is active, slide $\leftrightarrow \odot$ and hold the COMAND controller until the desired position has been reached.

Music search

You can use the following characteristics to search music:

- Keyword search
- Playlist
- Artists
- Albums
- Tracks
- Genres
- Year

- ▶ In audio mode, select **Search** by sliding $\odot \downarrow$ or turning $\{\odot\}$ the COMAND controller and press \odot to confirm.

A selection list appears.

- ▶ Select the desired characteristic by sliding $\odot \downarrow$ and turning $\{\odot\}$ the COMAND controller and press \odot to confirm.

For the search, the media inserted is scanned and the music track data is stored in a COMAND database. A medium that has already been scanned is not scanned again if another search is carried out. The scanning process may take some time for media with a large capacity. The search can be carried out after the scanning process is finished.

Selecting a folder

This function is only available in MP3 mode.

- ▶ Switch on MP3 mode (▷ page 224).
- ▶ Select **Search** by sliding $\odot \downarrow$ and turning $\{\odot\}$ the COMAND controller and press \odot to confirm.

- ▶ Select **Folder** by sliding $\odot \downarrow$ and turning $\{\odot\}$ the COMAND controller and press \odot to confirm.

You will see the tracks in the folder.



- ▶ Select a track by turning **[⊙]** and press **[⊙]** to confirm.
The track is played and the corresponding folder is now the active folder.

Gracenote Media Database

Introduction

This function is only available in audio CD mode.

There is a version of the music recognition software from Gracenote®, Emeryville, California, USA on the hard disk. You will recognise this by the logo which can be seen in the bottom right-hand corner of certain audio displays.



Many audio CDs contain CD text. COMAND uses the information contained therein to display the artist, album and track name.

If the audio CD does not contain any CD text information, COMAND can use the Gracenote Media Database to identify unknown audio tracks when running in audio CD mode. This is only possible if the relevant information is saved in the Gracenote Media Database and if the "Gracenote Media Database" function is activated.

If this is the case, COMAND will display the corresponding data such as artist, album and track name in the relevant displays and lists. If COMAND accesses the Gracenote Media Database when reading an audio CD, you will see the following message:



Selecting Gracenote® data to be displayed

If the inserted CD does not contain any Gracenote® data, the **Gracenote media database** menu item is shown in grey and cannot be selected.

- ▶ Switch on audio CD mode (▶ page 224).
- ▶ Select **CD** by sliding **[⊙]** and turning **[⊙]** the COMAND controller and press **[⊙]** to confirm.
- ▶ Select **Gracenote media database** by turning **[⊙]** the COMAND controller and press **[⊙]** to confirm.
Switch the function on or off .

Updating Gracenote® music recognition technology and the Gracenote Media Database

The digital data on the Gracenote Media Database becomes obsolete due to the release of new CDs. Optimum functionality can only be attained with up-to-date Gracenote® music recognition technology. Information about new versions can be obtained from a Mercedes-Benz Service Centre.

You can have your music recognition software updated there with a DVD, or you can update it yourself.

- i** The Gracenote Media Database is updated in conjunction with the navigation system's digital map (▷ page 187).

Setting the audio format

You can only set the audio format in audio DVD mode. The number of audio formats available depends on the DVD. The content of an audio DVD is called an "album", and this can be divided into up to nine groups. A group can contain music in different sound qualities (stereo and multichannel formats, for example), or bonus tracks. Each group can contain up to 99 tracks. If an audio DVD only contains one audio format, the "Group" menu item(s) cannot be selected.

- ▶ Switch on audio DVD mode (▷ page 224).
- ▶ Select **DVD-A** by sliding $\odot \downarrow$ and turning $\left[\odot \right]$ the COMAND controller and press \odot to confirm.
- ▶ Select **Group** by turning $\left[\odot \right]$ and press \odot to confirm.
The list of available groups appears. The
 - dot indicates the group currently selected.
- ▶ **To exit the menu:** slide $\leftarrow \odot \rightarrow$ the COMAND controller or press the $\left[\rightarrow \right]$ button.

Playback options

The following options are available to you:

- **Normal track sequence**

The tracks are played in the normal order (e.g. track 1, 2, 3, etc.).

In MP3 mode, the track order is determined by the order in which the tracks are written to the MP3 data carrier when it is created. Alphabetical order is the most common. Once all the tracks in a folder have been played, the tracks in the next folder are played.

- **Medium mix**

All the tracks on the medium are played in random order (e.g. track 3, 8, 5 etc.).

- **Track list mix** (MP3 mode only)

All the tracks that are listed in the current track list are played in random order.

- ▶ **To select options:** switch on audio CD/DVD or MP3 mode (▷ page 224).
- ▶ Select **CD**, **DVD-A** or **MP3** by sliding $\odot \downarrow$ and turning $\left[\odot \right]$ the COMAND controller and press \odot to confirm.
The options list appears. The • dot indicates the option selected.
- ▶ Select an option by turning $\left[\odot \right]$ and press \odot to confirm.
The option is switched on. For all options except "Normal track sequence", you will see a corresponding display in the display/selection window. See the example of the display in audio CD mode (▷ page 224).

- i** The "Normal track sequence" option is automatically selected when you change the medium you are currently listening to or when you select a different medium. If an option is selected, it remains selected after COMAND is switched on or off.

Notes on MP3 mode

Permissible discs

- CD-R and CD-RW
- DVD+R and DVD+RW
- DVD-R and DVD-RW
- SD memory card:
- USB stick
- iPod®
- MP3 player

Permissible file systems

- ISO 9660/Joliet standard for CDs
- UDF for audio and video DVDs
- FAT16 or FAT32 for storage media

Multisession CDs

For multisession CDs, the content of the first session determines how COMAND will process the CD. COMAND plays only one session and gives priority to the audio CD session.

If possible, use COMAND to play only CDs which have been written in one session.

File structure of a data carrier

When you create a disc with compressed music files, the tracks can be organised in folders. A folder can also contain subfolders. A disc can contain a maximum of 255 folders. Each folder can contain a maximum of 255 tracks and 255 subfolders.

The disc may contain no more than eight directory levels. Files beyond the eighth level will not be recognised by the system.

Track and file names

When you create a disc with compressed music files, you can assign names to the tracks and folders.

COMAND uses these names accordingly for the display. Folders which contain data other than MP3 or WMA tracks are not displayed by COMAND.

If MP3 or WMA files are stored in the root directory itself, the root directory will also be treated as a folder. COMAND will then show the name of the root directory as the folder name.

You must observe the following when assigning track names:

- track names must have at least 1 character.
- track names must have the extension "mp3" or "wma".
- there must be a full stop between the track name and the extension.

Example of a correct track name:
"Track 1.mp3".

- i** COMAND does not support ID3 tags.

Permissible formats

COMAND supports the following formats:

- MPEG1 Audio Layer 3 (MP3)
- Microsoft Windows Media Audio V8 and V9 (WMA) without copy protection

- i** If, as well as MP3 files, there are other music files in these audio formats stored on the disc, loading may require longer before the first track is played.

- i** The MPEG1 Audio Layer 3 (MP3) audio encoding method is under licence from Fraunhofer IIS (Institut Integrierte Schaltungen) and Thomson.

Permissible bit and sampling rates

COMAND supports **MP3** files of the following types:

- fixed and variable bit rates from 32 kbit/s to 320 kbit/s
- Sampling rates of 8 kHz to 48 kHz

COMAND supports **WMA** files of the following types:

- fixed bit rates from 5 kbit/s to 384 kbit/s
- Sampling rates of 8 kHz to 48 kHz

COMAND does **not** support **WMA** files of the following types:

- DRM (Digital Rights Management) encrypted files
- variable bit rate
- WMA Pro
- 5.1 Surround

- i** Only use tracks with a bit rate of at least 128 kbit/s and a sampling rate of at least 44.1 kHz. Lower rates can cause a noticeable deterioration in quality. This is especially the case if you have activated a surround sound function.

Notes on copyright

MP3 or WMA tracks that you create or play back are generally subject to copyright protection in accordance with the applicable international and national regulations.

In many countries, reproductions, even for private use, are not permitted without the prior consent of the copyright holder.

Make sure that you know about the applicable copyright regulations and that you comply with these.

If you own these rights yourself, e.g. for your own compositions and recordings, or if the copyright holder has granted you permission, these restrictions do not apply.

Notes on CDs/DVDs

Discs with copy protection are not compatible with the audio CD standard and therefore may not be able to be played by COMAND.

There may be playback problems when playing copied discs. There is a wide range of data carriers, disc-writing software and writers available. This variety means that there is no guarantee that the system will be able to play discs that you have copied yourself.

There may be playback problems if you play CDs that you have copied yourself with a storage capacity of more than 700 MB. CDs of this type do not conform to the currently applicable standards.

i On many DVD audio discs, the last track does not contain any music and COMAND then switches to the next disc. This is normal system behaviour and does not mean that there is a malfunction.

! Do not affix stickers or labels to the discs. They could peel off and damage the drive.

The drive is designed to hold discs which comply with the EN60908 standard. Therefore, you can only use discs with a maximum thickness of 1.3 mm.

If you insert thicker discs, e.g. those that contain data on both sides (DVD on one side and audio data on the other), they cannot be ejected and can damage the drive.

Do not use discs with a diameter of 8 cm, even with an adapter. Only use round discs with a diameter of 12 cm.

i COMAND is able to play back audio CDs in multichannel audio format.

MUSIC REGISTER

General notes

You can store music files in MP3 or WMA format in the MUSIC REGISTER. The memory has a capacity of approximately 7 GB.

! Retain the original music files in a secure location. An error in COMAND might result in the loss of the music files stored in the MUSIC REGISTER. Mercedes-Benz is not liable for any loss of data.

Switching to MUSIC REGISTER

► Select **Audio** in the main function bar by sliding **↑** and turning **⌚** the COMAND controller and press **⏵** to confirm.

If MUSIC REGISTER was the last mode selected, it is now switched on.

If another audio source is switched on, you can now switch on the MUSIC REGISTER in the audio menu.

► Select **Music Register** and press **⏵** to confirm.



Example display: MUSIC REGISTER

- ① Type of data carrier: MUSIC REGISTER
- ② Track number
- ③ Track name
- ④ Track time
- ⑤ Graphic time and track display
- ⑥ Current playback settings (no symbol for "Normal track sequence")
- ⑦ Sound settings
- ⑧ Media selection

- ⑨ Current folder
- ⑩ Search functions
- ⑪ Data carrier position in the media list
- ⑫ To call up the MUSIC REGISTER menu

Copying music data to the MUSIC REGISTER

Introduction

You can copy music files from discs in the DVD changer, the single DVD drive, the memory card or the COMAND USB, as long as they are in MP3 and/or WMA formats.

i While copying, several functions will not be available. If this is the case, you will see a message to this effect.

1. Selecting a data medium

- ▶ Select **Audio** by sliding $\uparrow\odot$ and turning $\left\{ \odot \right\}$ the COMAND controller and press \odot to confirm.
The audio menu appears.
- ▶ Select **Music Register** and press \odot to confirm.
- ▶ Select **Copy music files** and press \odot to confirm.

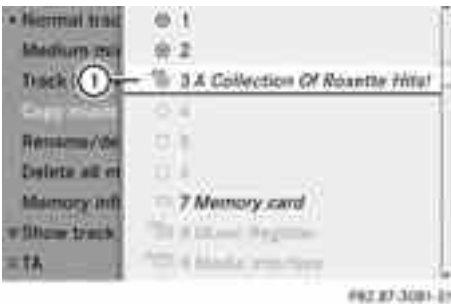

- ① Data medium selected
- ▶ **To select a disc:** slide $\uparrow\odot\downarrow$ or turn $\left\{ \odot \right\}$ and press \odot to confirm.
The data medium is loaded.

2. Selecting music files

- ▶ Select **All music files**.
This function copies all music files on the selected data carrier. The symbol in front of **All music files** is filled in.
- ▶ Select **Continue**.
The copying menu appears.

Folders can also be selected individually.

- ▶ **To select individual folders:** select the corresponding folder by sliding $\uparrow\odot\downarrow$ or turning $\left\{ \odot \right\}$ and press \odot to confirm.
A tick in front of the entry highlights the selection.

3. Starting the copying process



- ① To copy from a memory card
- ② To copy to the MUSIC REGISTER
- ③ Memory requirement, see "Calling up memory space info" (> page 234)
- ④ To start the copying process
- ⑤ Name of the data carrier from which data is being copied and storage location
- ⑥ To cancel copying of music files
- ⑦ Data carrier position in the media list
- ▶ Select **Start** and press \odot to confirm.
Copying begins. The progress bar indicates the status of the copying procedure.
- ▶ **To exit without copying files:** select **Back** and press \odot to confirm.

! Under no circumstances should you remove the memory card while you are copying data from it. This will generate unusable data in the MUSIC REGISTER.



① Progress bar

❗ It may take some time for the copying process to be completed, depending on the amount of data. The time required may vary depending on the data source. If there is not enough memory space, you will see a message to this effect.

- ▶ **To cancel copying:** select **Cancel**. Music files are stored in the MUSIC REGISTER up until the point of cancellation.

Deleting all music files

This function deletes all music files from the MUSIC REGISTER.

❗ The deletion procedure may take several minutes. In order to prevent malfunctions, do not use COMAND during this period.

- ▶ Select **Music Register** by sliding $\odot \downarrow$ and turning $\left\{ \odot \right\}$ the COMAND controller and press \odot to confirm.
- ▶ Select **Delete all music files** and press \odot to confirm. A query appears. **No** is highlighted. If you select **Yes**, all music files are deleted. You see the **Please wait...** message. Then, you see the **Deletion successful** message. If you select **No**, the process will be aborted.

Calling up memory space info

- ▶ Select **Music Register** by sliding $\odot \downarrow$ and turning $\left\{ \odot \right\}$ the COMAND controller and press \odot to confirm.
- ▶ Select **Memory information** and press \odot to confirm. The following is displayed:
 - storage capacity
 - available memory
 - occupied memory
 - content (folders, tracks)

Folder functions

Introduction

You can view the content of the MUSIC REGISTER, change folder or track names and delete individual folders or tracks.

Calling up a folder

- ▶ Select **Search** by sliding $\odot \downarrow$ and turning $\left\{ \odot \right\}$ the COMAND controller and press \odot to confirm.
- ▶ Select **Folder** and press \odot to confirm. You see the contents of the current folder.
- ▶ **To switch to the superordinate folder:** select the \uparrow icon and press \odot to confirm. The display changes to the next folder up.

Changing the folder/track name



- ① Folder selection symbol
 - ② Icon for music file
 - ③ Current folder
- ▶ Select **Music Register** by sliding $\odot \updownarrow$ and turning $\{\odot\}$ the COMAND controller and press \odot to confirm.
 - ▶ Select **Rename/delete files** by sliding $\odot \rightarrow$ the COMAND controller and press \odot to confirm.
 - ▶ Select a folder/track by turning $\{\odot\}$.
 - ▶ Select **Options** by sliding $\odot \rightarrow$ and press \odot to confirm.
 - ▶ Select **Edit** and press \odot to confirm.
 - ▶ Enter a name for the folder/track.
 - ▶ **To save the changes:** select **OK** and press \odot to confirm.

Deleting folders/tracks

- ▶ Select **Rename/delete files** by sliding $\odot \updownarrow$ and turning $\{\odot\}$ the COMAND controller and press \odot to confirm.
- ▶ Select the folder/track by turning $\{\odot\}$.
- ▶ Select **Options** by sliding $\odot \rightarrow$ and press \odot to confirm.
- ▶ Select **Delete** and press \odot to confirm. A query appears. **No** is highlighted. If you select **Yes**, the folders/tracks are deleted. You see the **Please wait...** message. Then, you see the **Deletion successful** message. If you select **No**, the process will be aborted.

Playback options

The following options are available:

- **Normal track sequence**
The tracks are played in the normal order (e.g. track 1, 2, 3, etc.).
 - **Medium mix**
All the tracks on the medium are played in random order.
 - **Track list mix** (MP3 mode only)
All the tracks that are listed in the current track list are played in random order.
- ▶ **To select options:** switch on the MUSIC REGISTER (▷ page 232).
 - ▶ Select **Music Register** by sliding $\odot \updownarrow$ and turning $\{\odot\}$ the COMAND controller and press \odot to confirm. The options list appears. The \bullet dot indicates the option selected.
 - ▶ Select an option and press \odot to confirm. The option is switched on. All options except **Normal track sequence** will be indicated by a corresponding icon in the display/selection window.

- ❗ The **Normal track sequence** option is automatically selected when you change the disc you are currently listening to or when you select a different medium. If an option is selected, it remains selected after COMAND is switched on or off.

Media Interface mode

Connection options

Overview

You will find the connection sockets in the glove compartment. Device-specific adapter cables are required to connect external devices to the Media Interface. These cables are included in the Media Interface scope of delivery.

- ❗ Store individual parts in a safe place.

Only use genuine Mercedes-Benz connection cables.

You can connect the following data carriers to COMAND via the Media Interface:

- iPod®
- USB devices (USB sticks, USB hard drives, MP3 players)

i iPod® is a registered trademark of Apple Inc., Cupertino, California, USA.

Supported iPod® variants

The following are examples of supported iPod® variants:

- iPod® nano
- iPod® classic
- iPod® touch
- iPhone®

Supported USB devices

The following USB devices are supported:

- USB sticks (flash memory)
- USB hard drives requiring a startup/permanent current of a maximum of 800 mA (it may be necessary to connect a separate power supply)
- certain MP3 players

i The Media Interface supports USB storage media of "USB Device Subclass 6". Information concerning USB Device Subclass 6 is available from the equipment manufacturer.

For further details and a list of supported devices, contact a Mercedes-Benz Service Centre or go to the website <http://www.mercedes-benz.com/connect>. Then, follow the instructions in the "Media Interface" section.

Connecting an external device

i Do not leave external devices in the vehicle as extreme temperatures (e.g. direct sunlight or extremely low outside temperatures) could cause them to malfunction

(see the operating instructions of the respective device). Mercedes-Benz accepts no liability for damage to external devices.

Never connect more than one device at a time. You will otherwise not be able to operate the external device.

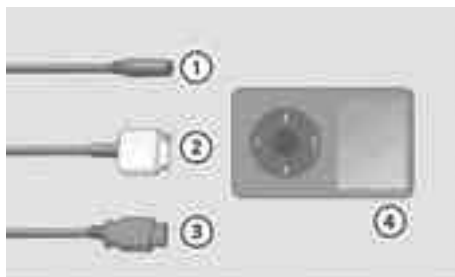

- ① 4-pole socket for 3.5 mm stereo jack, e.g. for MP3 players (audio and video)
- ② iPod® plug
- ③ USB socket
- ④ Example of device, iPod®

► Connect the external device with suitable socket ①, ② or ③.

COMAND activates the device automatically for sockets ② and ③.

COMAND does not activate the device automatically for socket ①.



If you remove a device from sockets ② and ③, the **No device connected** message appears.

i A connected iPod® or MP3 player should not be simultaneously operated via the

Media Interface and the remote control (e.g. Bluetooth® remote control), as this may produce unpredictable results.

- ❗ Connecting an exhaustively discharged iPod® or MP3 player can result in an extended initialisation period.

Error messages appear while the device is being activated if:

- COMAND does not support the device connected.
 - two devices are connected.
 - the connected device consumes too much power.
 - the Media Interface connection is faulty.
- ❗ Where necessary, consult a Mercedes-Benz Service Centre.

Switching to Media Interface mode

General notes

In extreme cases, starting up individual functions can take up to several minutes – this depends on the external device and its content (e.g. video podcasts).

Only use the original programs to populate an iPod or MP3 player. Otherwise, some or all functions may not be available.

Option 1

- ▶ Connect an external device (▷ page 236). COMAND activates the device. The basic display then appears.

Option 2

- ▶ Select **Audio** by sliding **↑** and turning **⌂** the COMAND controller and press **⏵** to confirm.
The audio menu appears.
- ▶ Select **Media Interface** and press **⏵** to confirm.

Option 3

- ▶ In the media list, (▷ page 227) turn **⌂** the COMAND controller to select the entry

under the corresponding position and press **⏵** to confirm.

COMAND activates the connected device. You will see a message to this effect. The basic display then appears.

If no device is connected, you will see the **Media Interface** entry instead of a device name.

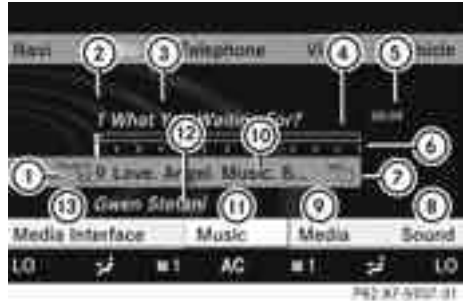

Example display: iPod mode

- ① Data medium type
- ② Track number
- ③ Track name
- ④ Graphic time display
- ⑤ Track time
- ⑥ Graphic track display
- ⑦ Current playback settings (no symbol for "Normal track sequence")
- ⑧ Sound settings
- ⑨ Media list
- ⑩ Album name (if available)
- ⑪ Categories, playlists and/or folders
- ⑫ Artist (if available)
- ⑬ Playback options

Type of device ① connected is indicated by the corresponding symbol for iPod, MP3 player or USB mass storage device.

- ❗ If the device connected does not contain any playable tracks, a message appears to this effect.

Selecting music files





Note

COMAND displays the data stored on the iPod®, MP3 player or USB mass storage device according to the filing structure used in the respective medium.



Selecting by skipping to a track

► **To skip forwards or back to a track:** turn  the COMAND controller when the display/selection window is active.

The skip forward function skips to the next track. The skip back function skips to the beginning of the current track if the track has been playing for more than eight seconds. If the track has been playing for less than eight seconds, it skips to the start of the previous track. If you have selected a playback option other than **Normal track sequence**, the track sequence is random.

- **On the multifunction steering wheel:** switch on Media Interface mode (> page 236).
- On the multifunction steering wheel, press the  or  button to select the **Audio** menu.
- On the multifunction steering wheel, press  or  to select a track.

Selecting using the number keypad

- **To make an entry:** press the  button. An input menu appears. The number of characters available for input depends on the number of tracks that can currently be selected.
- **To enter a track number:** press a number key, e.g. . The digit is entered in the first position in the input line.

- i** COMAND will ignore and not display an invalid digit.
- Enter more numbers if desired. The selected track is played.

Fast forward/rewind

► While the display/selection window is active, slide  and hold the COMAND controller until the desired position has been reached.

- i** On an iPod®, fast rewind only functions within the current track.

Selecting a category/playlist/folder

iPod® and selected MP3 players

For an iPod® or MP3 player, you can select tracks using categories or folders.

Depending on the device connected, the following categories may be available, for example:

- **Current tracklist**
- **Playlists** (e.g. **All**)
- **Artists**
- **Albums**
- **Tracks**
- **Podcasts**
- **Genres**
- **Composers**
- **Audiobooks**

- i** Some playback categories contain the entry **All**. If this entry has been selected, the entire content of the category selected will be played.

USB devices

For USB mass storage devices, you can select both folders as well as any existing playlists. COMAND can also display the album name and artist (metadata) during playback, if this information has been entered into the system.

Playlists are indicated in the display by a special icon. When you open the playlist, the corresponding tracks are displayed and playback begins once a track is selected. You can now select **Category mix** instead of **Random folder** as a playback option.

For USB mass storage devices, you can choose to display the metadata contained in the tags of the encoded music data, or to display the file and directory names during playback.

- ▶ **To display the album and artist name:** select **Media Interface** in the basic display by sliding $\odot \updownarrow$ and turning $\{\odot\}$ the COMAND controller and press \odot to confirm.
- ▶ Select **Display Metadata** and press \odot to confirm.

Selecting a category and opening a folder

- ▶ Press \odot the COMAND controller when the display/selection window is active.
- ▶ Select **Folder** by sliding $\odot \updownarrow$ and turning $\{\odot\}$ the COMAND controller and press \odot to confirm.
You will see the available categories or the folder content (e.g. other folders). The display's status bar shows the selected category or the folder name.

i The **Music** menu item is not available until the device has been activated.

- ▶ Select the category/folder by turning $\{\odot\}$ the COMAND controller and press \odot to confirm.
You will see the content of the selected category or selected folder.

i If the data needs to be read from the connected device, the **Please wait...** message appears.

- ▶ If necessary, repeat this step until the tracks in the desired folder/album appear.
- ▶ Select the track by turning $\{\odot\}$ the COMAND controller and press \odot to confirm.
The track is played.

- ▶ **To select one folder higher:** select the  icon and confirm with \odot .

i The  icon is always shown at the top of the respective folder.

Playing back the contents of a category or folder

- ▶ Select the category or folder by turning $\{\odot\}$ the COMAND controller.
- ▶ Press \odot the COMAND controller for longer than two seconds.
The content of the category or folder selected is played in accordance with the playback option (> page 240) selected.

Alphabetical track selection

iPod® and MP3 players

This function is available for alphabetically sorted categories and folders. This function is not available for albums or playlists, for example.

- ▶ Select a category, e.g. **Artists**, by turning $\{\odot\}$ the COMAND controller and press \odot to confirm.
The available artists are displayed.

- ▶ Press the corresponding number key once or several times to select the first letter of the artist's name (e.g. for an artist beginning with the letter "C", press number key  three times).

The available letters are listed at the lower edge of the display.

After a message, the first entry in the list which matches the letter entered is highlighted.

- i** If no corresponding entry exists, the last entry corresponding to a previous letter is highlighted instead.

- i** For iPods® and MP3 players, the quality of the search results is highly dependent on the version and language variant of the software (e.g. iTunes® version) used to populate the device.

USB mass storage device

This function is available for alphabetically sorted directories. This function is not available for albums or playlists, for example.

- ▶ In a directory, press the corresponding number key once or several times to select the first letter of the artist's name (e.g. for an artist beginning with the letter "C", press number key  three times).





The available letters are listed at the lower edge of the display.

If the directory only contains folders, COMAND searches for folders. After a message, the first entry which matches the letter entered is shown at the top of the list.

If no entry matches the entered letter, the first item in the list is the last entry to correspond to a selection.

Selecting an active partition (USB mass storage devices only)

You can select this function for USB mass storage devices when the storage device is partitioned. Up to four partitions (primary or logical; FAT format) are supported.







- ▶  The Windows formatting program supports FAT partitioning up to 32 GB as standard.
- ▶ Select **Media Interface** in the basic display by sliding  and turning  the COMAND controller and press  to confirm.
- ▶ Select **Select active partition** and press  to confirm.

Playback options

The following options are available:

- **Normal track sequence**
Normal track sequence: You hear the tracks in their normal order (numerical or alphabetical).
- **Random tracks:**
All the tracks on the medium are played in random order.
- **Category mix** or **Random folder** (for USB devices if **Folder** has been selected)





The tracks in the currently active category or folder, including any subfolders, are played in random order.

- ▶  For USB devices, the random playlists offer a maximum of 300 tracks chosen at random.
- ▶ **To select a playback option:** select **Media Interface** in the basic display by sliding  and turning  the COMAND controller and press  to confirm.
The options list appears. The  dot indicates the option selected.
- ▶ Select an option and press  to confirm.

Separate USB connection

In addition to the USB connection on the Media Interface, there is another USB connection in the glove compartment. This connection can also be used to play audio files. Electrical consumption at this connection must not exceed a continuous current of 500 mA. If the electrical consumption is higher, use a separate source to provide power for the USB device (e.g. 12 V power supply).



- ▶ **To select music from the USB port as the audio source:** select **Audio** by sliding  and turning  the COMAND controller and press  to confirm.
The audio menu appears.
- ▶ Select **USB** and press  to confirm.

Notes on USB devices

Data formats

The following data formats are supported:

- MP3: CBR, VBR (up to 320 kbit/s)
- WMA: CBR, VBR (up to 320 kbit/s)

Notes on USB devices

- In order to keep the initialisation time to a minimum, store only music data on a USB device.
- Approximately 10,000 tracks are supported. Multiple partitions should be used for larger numbers of tracks.
- Do not use USB extension leads or adapters. They can impair functionality.
- A background search of the USB device is performed and any playlists found are shown in a separate category in addition to the folders. Initialisation of larger USB mass storage devices containing a high number of files may take several minutes.

i DRM (Digital Rights Management) protected files are not supported by the Media Interface.

Audio AUX mode

Notes on audio AUX mode

You can connect an external audio source (AUX) to COMAND. The socket for this is located in the glove compartment.

If COMAND is equipped with a Media Interface, external audio sources are connected using the associated cable set. The audio cable set then replaces the audio AUX socket.

i You can find more information on the Internet at <http://www.mercedes-benz.com/connect> and in the "Media Interface mode" section (▷ page 235).

Activating audio AUX mode

When you connect an external audio source, audio AUX is not selected automatically.

- ▶ Select **Audio** in the main function bar by sliding **↑** and turning **⌂** the COMAND controller and press **⏻** to confirm.
- ▶ Select **Aux** using **⌂** and press **⏻** to confirm.

The audio AUX menu appears. The medium in the external audio source is played, if the source is connected and playback selected.



Please see the respective operating instructions for how to operate the external audio source.

You will find details on volume (▷ page 135) and sound (▷ page 135) settings in the "At a glance" section.

⚠ WARNING

External audio sources may have different volumes, which can mean that system messages such as traffic announcements and navigation system announcements are much louder. If necessary, please deactivate the system messages or adjust their volume manually.

Increasing the volume

In some cases, the volume of the AUX device may be quieter or louder, or the usual maximum possible volume cannot be reached. On some devices, it is possible to adjust the volume separately. In this case, start at a medium volume and increase it gradually.

This enables you to determine whether the system is able to play tones at high volume without distorting them.

Video

General notes

Automatic picture shutoff

If the vehicle is travelling faster than approximately 5 km/h, the picture automatically switches off in the following modes:

- TV mode
- Video DVD mode

The **In order not to distract the driver, the picture is faded out while the vehicle is in motion.** message appears in the display.







As soon as the vehicle speed drops below about 3 km/h, the picture switches back on again.

Basic settings











Picture settings

Adjusting the brightness, contrast or colour

The following describes the TV, video DVD and video AUX modes.

- ▶ Press  the COMAND controller to show the menu.
- ▶ Select **Video** by sliding  and turning  the COMAND controller and press  to confirm.
- ▶ Select **DVD-V** and press  to confirm.
- ▶ Select **Brightness, Contrast** or **Colour** by turning  the COMAND controller and press  to confirm.

Changing the picture format

- ▶ Press  the COMAND controller to show the menu.
- ▶ Select **Video** by sliding  and turning  the COMAND controller and press  to confirm.
- ▶ Select **Video DVD** and press  to confirm.
- ▶ Select **DVD-V** and press  to confirm. The DVD-V menu appears. The  dot in front of a menu item indicates the current setting.
- ▶ Select **Auto, 16:9 optimised, 4:3** or **Widescreen** and press  to confirm.
- ▶ Select a setting by turning  the COMAND controller and press  to confirm.

TV mode

Reception quality

Portable electronic devices in the vehicle may seriously impair TV reception.

The TV tuner is designed to receive analogue terrestrial TV channels (all standards) and digital TV channels conforming to the DVB-T standard¹⁶. If the reception deteriorates, the TV receiver automatically switches to an alternative frequency (digital or analogue transmission) transmitting the same programme content with better reception, as soon as a corresponding channel can be received.

The constantly changing reception conditions while the vehicle is in motion can interrupt the signal. A symbol is shown in the display if the reception conditions are poor.

¹⁶ DVB-T is not available in some countries, or is not available in all areas.

Switching to TV mode

- ▶ Select **Video** in the main function bar by sliding **↑** and turning **⌂** the COMAND controller and press **⏻** to confirm. If TV mode was the last mode selected, it will now be active. If another mode was switched on, you can now switch on TV mode in the video menu.
- ▶ Select **Video** and press **⏻** to confirm. The video menu appears.



Example of display: video menu

- ▶ Select **TV** and press **⏻** to confirm. You see the last TV channel selected, provided it can still be received.

Hiding/showing the navigation menu

- ▶ **To show:** turn **⌂** or slide **↑** the COMAND controller.
 - ▶ **To hide:** slide **↑** the COMAND controller.
- or
- ▶ Wait for approximately eight seconds.

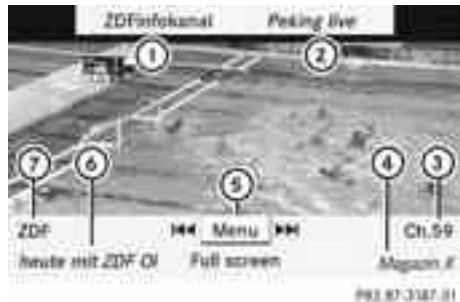

Navigation menu displayed

- ① Selected TV channel
- ② Current programme (digital TV receiver only)
- ③ Next station
- ④ Current programme on the next TV channel in the list (digital TV receiver only)
- ⑤ To show the menu
- ⑥ Current programme on the previous TV channel in the list (digital TV receiver only)
- ⑦ Previous TV channel in the list

Showing/hiding the menu

- ▶ **To show:** press **⏻** the COMAND controller.

or

- ▶ Select **Menu** while the navigation menu is shown and press **⏻** to confirm.
- ▶ **To hide:** slide **↑** the COMAND controller and confirm **Full screen** by pressing **⏻**.

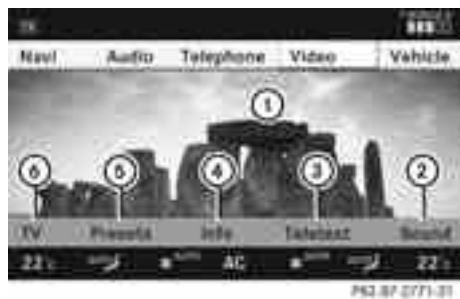

Menu system displayed

- ① Main area
- ② Sound settings

- ③ To switch on teletext
- ④ Information on the current programme (only for digital TV channels)
- ⑤ Channel preset list
- ⑥ TV options

Selecting TV channels

Selecting channels from the navigation menu

▶ Turn or slide the COMAND controller.

or

▶ Press the or button.

The TV tuner selects the previous or next channel from the alphabetical channel list.

Selecting a station from the station list

As soon as the vehicle or COMAND is in operation, the background reception function of the TV tuner lists the channels that can currently be received in the channel list.

The channel list contains the following information, if it is transmitted and can be received:

- the names of the channels that can be received
- the name of the current and next programme on each channel
- information text about the current programme
- the name of digital radio stations; these are listed below the TV channels

The background reception function requires a certain amount of time to update this information. COMAND can only display the information if the TV channels are transmitting it and if the reception conditions are adequate. The electronic TV programme guide (EPG) supplies the titles of the current and upcoming programmes, as well as the information text about the current programme.

The channel list is sorted alphabetically and contains:

- analogue TV channels (all standards)
- digital TV channels (DVB-T standard)
- digital radio stations (DVB-T standard).

i The radio stations are optically separated from the TV channels by a dotted line.

▶ **To set a channel using COMAND:** press the COMAND controller to show the menu.

▶ Select **TV** by sliding and turning the COMAND controller and press to confirm.

▶ Select **Station list** and press to confirm.

The station list appears. The • dot in front of a list entry indicates the currently selected channel. A number before the list entry shows the memory slot in the channel presets.

▶ Select the channel and press to confirm.

▶ **To set a channel using the multifunction steering wheel:** switch on TV mode in COMAND (▷ page 243).

▶ Press or to select the **Audio** menu.

▶ Press and hold or .

Selecting stations via the station presets

▶ **To set a channel using COMAND:** press the COMAND controller to show the menu.

▶ Select **Presets** by sliding and turning the COMAND controller and press to confirm.

The station preset memory appears. The • dot in front of a preset position indicates that the currently selected channel is stored there.



Station presets

- ▶ Select a channel by turning **⏪** the COMAND controller and press **⏩** to confirm.

or

- ▶ Press a number key, e.g. **2**.

- i** If you press number key **9**, for example, the preset view changes and the corresponding channel name becomes visible.

- ▶ **To set a channel using the multifunction steering wheel:** switch on TV mode in COMAND (▷ page 243).
- ▶ Press **⏪** or **⏩** to select the **Audio** menu.
- ▶ Press **▲** or **▼** briefly.

Selecting channels by entering the channel and programme number

Several programmes can be transmitted on one channel with digital TV. You can therefore enter a channel and the desired programme on this channel.

Only one programme can be sent on a channel with analogue TV. The programme entry function therefore has no effect.

- ▶ **Option 1:** press **⏩** the COMAND controller to show the menu.
- ▶ Select **TV** by sliding **⊙** and turning **⏪** the COMAND controller and press **⏩** to confirm.
- ▶ Select **Channel input** and press **⏩** to confirm.

- ▶ **Option 2:** press the ***** button while the TV is playing. Irrespective of the option, an input bar appears at the top of the screen.
- ▶ Press the corresponding number keys to enter the channel/programme number.
- ▶ Confirm by pressing **⏩** the COMAND controller or press and hold the number key until the character bar disappears. The channel is set.

- i** If you have not entered a programme number, the first programme with adequate reception will be set for a digital channel.

- i** You can enter channels or programmes available in your country even if the reception is currently not adequate.

If you enter channels that are either not intended for or not allowed in your country, the **Invalid channel number** message appears.

- ▶ To confirm the message: press **⏩** the COMAND controller.

Storing TV channels

Storing stations manually

There are twenty preset positions available.

- ▶ **To call up the channel presets:** press **⏩** the COMAND controller to show the menu.
- ▶ Select **Presets** by sliding **⊙** and turning **⏪** the COMAND controller and press **⏩** to confirm. The station preset memory appears. The
 - dot in front of a preset position indicates that the channel currently selected is stored there.
- ▶ **To select a preset:** turn **⏪** the COMAND controller.

- ▶ **To store a channel:** press and hold  the COMAND controller until you hear a tone.

or





- ▶ Press and hold a number key such as  until you hear a tone.

Then, the TV picture reappears.

- ❗ If you press number key , for example, the channel preset display changes and the corresponding preset becomes visible.





Storing stations automatically

This function automatically stores channels with adequate reception in order of their reception quality. Any channels stored manually in the preset memory will be lost.

- ▶ **To show the menu:** press  the COMAND controller.
- ▶ Select **Presets** by sliding  and turning  the COMAND controller and press  to confirm.
- ▶ Select **Autostore** and press  to confirm. COMAND searches for channels with adequate reception. The available channels are automatically stored in the preset positions.

Information about the current programme

This function is only available for digital TV channels and digital radio stations.





- ▶ **To show the menu:** press  the COMAND controller.
- ▶ Select **Info** by sliding  and turning  the COMAND controller and press  to confirm.

You will see the information if it is provided by the selected TV channel. If not, the information field remains empty.

- ❗ It may take a few seconds for the information to appear.

Displaying the current programme or programme preview

This function is only available for digital TV channels and digital radio stations. The programme preview is also referred to as the electronic programme guide (EPG).

- ▶ **To show the menu:** press  the COMAND controller.
- ▶ Select **TV** by sliding  and turning  the COMAND controller and press  to confirm.
- ▶ Select **Station list**.

The station list appears. It shows the current programme on the digital TV channels and digital radio stations which have adequate reception. The  dot in front of a list entry indicates the currently selected channel.



- ① Current TV channel
 - ② To display the programme preview
 - ③ Current programme
 - ④ Visual display of the elapsed programme time
- ▶ **To show the programme preview:** select **Display programme preview** and press  to confirm. The channel list shows the channel's next programme.



- ① TV channel
- ② Next programme
- ③ To display the current programme
- ④ The beginning and end of the programme

- ▶ **To show the current programme:** select **Display current programme** and press to confirm.
- ▶ **To close the display:** press the button.

Basic TV settings

Fixing the frequency

The TV tuner may automatically switch to an alternative channel with the same programme content but better reception, depending on reception quality. You can use **Channel fix** to prevent this channel switching. This is useful, for example, when the same content is broadcast with a time delay, or when there is interference on one of the frequencies.

- ▶ **To show the menu:** press the COMAND controller.
- ▶ Select **TV** by sliding and turning the COMAND controller and press to confirm.
- ▶ Select **Channel fix** and press to confirm.
- ▶ The function is switched on or off , depending on the previous status. When

the function is switched on, **FIX** appears in the display window.

- ▶ **To exit the menu:** slide the COMAND controller.

Setting the reception region

The correct reception region setting ensures that analogue TV channels can be received with the usual quality and functionality. COMAND is set to the correct reception region at the factory. If you are driving your vehicle in a different country or region, you should set COMAND accordingly. A Mercedes-Benz Service Centre can help you to select the correct reception region.

- ▶ **To show the menu:** press the COMAND controller.
- ▶ Select **TV** by sliding and turning the COMAND controller and press to confirm.
- ▶ Select **TV standard** and press to confirm.

A list appears, showing the reception regions. The dot in front of a list entry indicates the currently selected reception area or country.

- ▶ Select the reception area and press to confirm.
- A message appears to inform you that if the wrong country is set, correct reception will not be possible.
- ▶ Select **Yes** or **No** and press to confirm. If you select **Yes**, COMAND will switch to the country setting you have selected. If you select **No**, the country list will appear again.

Teletext

Introduction



Teletext can only be received if there is no interference in the picture reception. The teletext function receives all teletext pages for the channel currently set, excluding subpages, and stores them in the system mem-

ory. If you set a different channel, the memory is cleared and refilled.

Switching teletext on/off

- ▶ **To show the menu:** press  the COMAND controller.
- ▶ **To switch on:** select **Teletext** by sliding  and turning  the COMAND controller and press  to confirm.
- ▶ **To switch off:** press the  button. The TV picture appears.

Selecting a teletext page

- ▶ **To select a page directly:** press the corresponding number key.
- i** You can only enter pages that are permissible for teletext between 100 and 899.
- ▶ **To access the previous/next page:** turn  or slide  the COMAND controller.

Dynamic teletext page

A dynamic teletext page consists of several subpages. The display automatically changes to the next page after a certain time.

Video DVD mode

Safety notes

WARNING

COMAND is classified as a class 1 laser product. You must not open the casing. If you open the casing, or if the casing is faulty or damaged, there is a risk of exposure to invisible laser radiation. This may damage your eyes, or those of others.

COMAND does not contain any parts that can be serviced by the user. For safety reasons, all maintenance work must be carried out by qualified aftersales technicians.

WARNING

Only when the vehicle is stationary should you:

- load a disc
- eject a disc

There is a risk of being distracted from the road and traffic conditions if this is done while the vehicle is in motion.

Notes about discs

There may be playback problems when playing copied discs. There are a large variety of discs, DVD authoring software, writing software and writers available. This variety means that there is no guarantee that the system will be able to play discs that you have copied yourself.

! Do not affix stickers or labels to the discs, as they could peel off and damage COMAND. Stickers can cause the disc to bend, which can result in read errors and disc recognition problems.

! COMAND is designed to accommodate discs which comply with the EN 60908 standard. You can therefore only use discs with a maximum thickness of 1.3 mm.

If you insert thicker discs, e.g. those that contain data on both sides (DVD on one side and audio data on the other), they cannot be ejected and can damage COMAND.

Use round discs with a diameter of 12 cm. Do not use discs with a diameter of 8 cm, even with an adapter.

DVD playback conditions

There are video DVDs available on the market which do not conform to the current standards. Such DVDs may have picture, sound or other playback problems.

COMAND can play back video DVDs produced according to the following standards:

- region code 2 (for Europe) or region code 0 (no region code)

i If you insert a video DVD with a different region code, you will see a message to this effect.

- PAL or NTSC standard

You will generally find the relevant details either on the DVD itself or on the DVD case.

i COMAND is set to region code 2 at the factory. This setting can be changed at a Mercedes-Benz Service Centre. This will allow you to play video DVDs with a different region code, provided that they are produced in accordance with the PAL or NTSC standard. The region code can be changed a maximum of five times.

Function restrictions

Depending on the DVD, it is possible that certain functions or actions will be temporarily blocked or may not function at all. As soon as you try to activate these functions or actions, you will see the  symbol in the display.

Inserting and removing DVDs



- ▶ Proceed as described in the "Inserting and ejecting CDs and DVDs" section ([▷ page 223](#)).



Activating video DVD mode

Option 1



- ▶ Insert a video DVD.
COMAND loads the medium inserted and starts to play it.

Option 2

- ▶ Select **Video** in the main function bar by sliding  and turning  the COMAND controller and press  to confirm. Video DVD mode is switched on. If video DVD mode was the last mode selected, it will now be active. If another video source is switched on, you can now switch to video DVD mode in the video menu.

- ▶ Select **Video** by sliding  the COMAND controller and press  to confirm. The video menu appears.
- ▶ Select **DVD-V** and press  to confirm.

Hiding/showing the navigation menu

- ▶ **To show:** turn  or slide  the COMAND controller.
 - i** This function is not available while the DVD's own menu ([▷ page 251](#)) is being displayed.
 - ▶ **To hide:** slide  the COMAND controller.
- or
- ▶ Wait for approximately eight seconds.

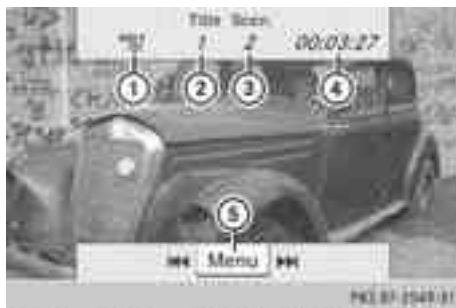



Navigation menu displayed

- ① Data medium type
- ② Current track
- ③ Current scene
- ④ Track time
- ⑤ To show the menu

Showing/hiding the menu

This function is not available while the DVD's own menu ([▷ page 251](#)) is being displayed.

- ▶ **To show:** press  the COMAND controller.
- or
- ▶ Select **Menu** while the navigation menu is shown and press  to confirm.

- ▶ **To hide:** slide \uparrow the COMAND controller and confirm **Full screen** by pressing \odot .

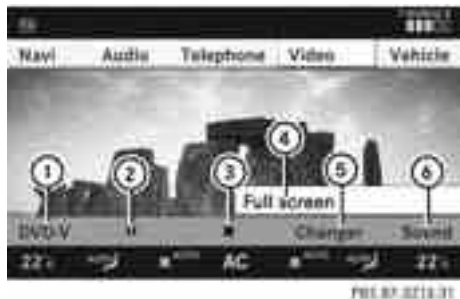

Menu shown

- ① Video DVD options
- ② Pause function
- ③ Stop function
- ④ Full-screen function
- ⑤ Media selection
- ⑥ Sound settings

Fast forward/rewind

- ▶ Slide \leftarrow and hold the COMAND controller until the desired position has been reached.
You see the navigation menu.

Selecting a video DVD

- ▶ Press \odot the COMAND controller to show the menu.
- ▶ Select **Media** by sliding \odot and turning \leftarrow the COMAND controller and press \odot to confirm.
The media list appears. The \bullet dot indicates the current medium being played. Video DVDs are indicated by the DVD-V icon.
- ▶ **Equipped with a single DVD drive:** press \odot the COMAND controller.
COMAND loads the video DVD and begins playing it.

- ▶ **Equipped with a DVD changer:** press \odot the COMAND controller to display all magazine trays.
- ▶ Select **DVD-V** by turning \leftarrow the COMAND controller and press \odot to confirm.
COMAND loads the video DVD and begins playing it.

i If you select a CD, an audio DVD or an MP3 medium, you switch to the respective audio mode. You can find further information about the media list on (\triangleright page 227).

Stop function

- ▶ Press \odot the COMAND controller to show the menu.
- ▶ **To interrupt playback:** select \blacksquare by turning \leftarrow the COMAND controller and press \odot to confirm.
The || display changes to \blacktriangleright . The video image is hidden.
- ▶ **To continue playback:** select \blacktriangleright and press \odot to confirm.
Playback continues from the point where it was interrupted.
- ▶ **To stop playback:** while playback is interrupted, select \blacksquare again and press \odot to confirm.

or

- ▶ During playback, confirm \blacksquare by pressing \odot twice in quick succession.
Selection is at \blacktriangleright .
- ▶ **To restart playback:** confirm \blacktriangleright by pressing \odot .
Playback restarts from the beginning.

Pause function

- ▶ Press the COMAND controller to show the menu.
- ▶ **To pause:** select by turning the COMAND controller and press to confirm.
The display changes to .
- ▶ **To continue playback:** select and press to confirm.
The menu is hidden.

Selecting a scene/chapter

If the film is divided into scenes or chapters, you can select them directly while the film is running, or skip forwards step-by-step. Some DVDs do not permit this at certain points (e.g. during the opening credits).

It may also be possible to select the scene/chapter from within the menu stored on the DVD.

- ▶ **To skip forwards or back:** turn or slide the COMAND controller.
The control menu (▷ page 249) appears for approximately eight seconds.
- ▶ **On the multifunction steering wheel:** switch on video DVD mode in COMAND (▷ page 249).
- ▶ Use the or button to select the **Audio** menu.
- ▶ Press or to select a scene/chapter.
If you press and hold or for an extended period, rapid scroll begins.

Selecting a film/title

This function is only available if the DVD is divided into several films/tracks. If the DVD contains several films, these can be selected directly. A film can be selected either when the DVD is being played back or when it is stopped.

The film can also be selected from the menu on the DVD itself.

- ▶ Press the COMAND controller to show the menu.
- ▶ Select **DVD-V** by turning the COMAND controller and press to confirm.
- ▶ Select **DVD functions** and press to confirm.
A menu appears.

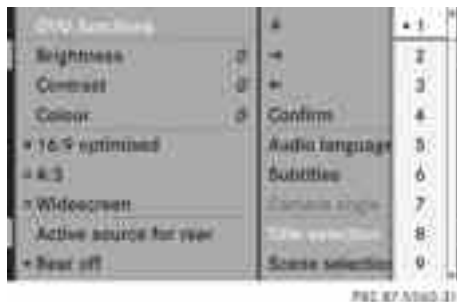

- ▶ Select **Title selection** by turning the COMAND controller and press to confirm.
- ▶ Select a film/title and press to confirm.

DVD menu

To call up the DVD menu

The DVD menu is the menu stored on the DVD itself. It is structured in various ways according to the individual DVD and permits certain actions and settings.

In the case of multi-language DVDs, for example, you can set the language in the DVD menu.

- ▶ Press the COMAND controller to show the menu.
- ▶ Select **DVD-V** in the menu by turning the COMAND controller and press to confirm.
- ▶ Select **DVD functions** and press to confirm.
- ▶ Select **Menu** and press to confirm.
The DVD menu appears.

Selecting menu items in the DVD menu

- ▶ Select a menu item by sliding \uparrow \downarrow or turning \leftarrow \rightarrow the COMAND controller and press \odot to confirm. The menu appears.

i Menu items that cannot be selected are greyed out.



- ▶ **To reconfirm your selection:** confirm **Select** by pressing \odot . COMAND executes the action. Make a selection from the further options, if necessary. COMAND then switches back to the DVD menu.

i Depending on the DVD, it is possible that the **Back (to the movie)**, **Play**, **Stop**, \lll , \ggg or **Go up** menu item may not be operative or operative only at certain points of the DVD. To indicate this, the \odot symbol is shown in the display.

Stopping a film or skipping to the beginning or end of a scene

- ▶ Select any menu item from the DVD menu. The menu appears.
- ▶ **To stop the film:** select the **Stop** menu item and press \odot to confirm.
- ▶ **To skip to the end of a scene:** select the \ggg menu item and press \odot to confirm.
- ▶ **To skip to the beginning of a scene:** select the \lll menu item and press \odot to confirm.

Moving up one level in the DVD menu

- ▶ Press the \square back button.
- or
- ▶ Select the corresponding menu item in the DVD menu and press \odot the COMAND controller to confirm.
- or
- ▶ Select any menu item in the DVD menu and press \odot the COMAND controller to confirm.
- ▶ Select **Go up** and press \odot to confirm.

Back to the film

- ▶ Press the \square back button repeatedly until you see the movie.
- or
- ▶ Select the corresponding menu item in the DVD menu.
- ▶ Select the **Back (to the movie)** menu item in the menu and press \odot to confirm.

Setting the language and audio format

This function is not available on all DVDs. If it is available, you can set the DVD menu language, the audio language or the audio format. The number of settings is determined by the DVD content. It is possible that the settings may also be accessed in the DVD menu (\triangleright page 251).

- ▶ Press \odot the COMAND controller to show the menu.
- ▶ Select **DVD-V** in the menu by turning $\left\{ \begin{smallmatrix} \odot \\ \odot \end{smallmatrix} \right\}$ the COMAND controller and press \odot to confirm.
- ▶ Select **DVD functions** and press \odot to confirm.
- ▶ Select **Audio language** and press \odot to confirm. In both cases, a menu appears after a few seconds. The \bullet dot in front of an entry indicates the currently selected language.

- ▶ Select a setting by turning **⏪** the COMAND controller and press **⏩** to confirm.
- ▶ **To exit the menu:** slide **⏪** the COMAND controller.

Subtitles and camera angle

These functions are not available on all DVDs. The number of subtitle languages and camera angles available depends on the content of the DVD. It is possible that the settings may also be accessed in the DVD menu (▷ page 251).

- ▶ Press **⏩** the COMAND controller to show the menu.
- ▶ Select **DVD-V** in the menu by turning **⏪** the COMAND controller and press **⏩** to confirm.
- ▶ Select **DVD functions** and press **⏩** to confirm.
- ▶ Select **Subtitles** or **Camera angle** and press **⏩** to confirm.
In both cases, a menu appears. The **•** dot in front of an entry indicates the current setting.
- ▶ Select a setting by turning **⏪** the COMAND controller and press **⏩** to confirm.
- ▶ **To exit the menu:** slide **⏪** the COMAND controller.

Interactive content

DVDs can contain interactive content (e.g. a video game). In a video game, for example, you may be able to influence events by selecting and triggering actions. The type and number of actions depend on the DVD.

- ▶ Select an action by sliding **⏪** or **⏩** the COMAND controller and press **⏩** to execute it.
A menu appears and the first entry, **Select**, is highlighted.
- ▶ Press **⏩** the COMAND controller.

Video AUX operation

Connecting external video sources

If your vehicle is equipped with a Media Interface, you can connect an external video source.

You require an additional audio/video cable set to connect an external video source to the Media Interface.

For more details, please contact a Mercedes-Benz Service Centre or visit <http://www.mercedes-benz.com/connect>. Then, follow the instructions in the "Media Interface" section.

You will find the connection sockets in the glove compartment.



Audio/video sockets

- ① Connection cable (yellow) for video signal (V)
- ② Connection cable (white) for audio signal (L)
- ③ Connection cable (red) for audio signal (R)

i To facilitate correct playback, it may be necessary to set a suitable video standard in the external video source.

- ▶ Connect the external device to corresponding port ①, ② or ③.
COMAND activates the device.

Switching on video AUX mode

- ▶ Select **Video** in the main function bar by sliding $\uparrow \odot$ and turning $\left[\odot \right]$ the COMAND controller and press \odot to confirm.

If video AUX mode was the last mode selected, it will now be active.

If another video source is switched on, you can now switch to video AUX mode in the video menu.

- ▶ Select **Video** and press \odot to confirm.
- ▶ Select **Aux** and press \odot to confirm.

The video AUX menu appears. You will hear and see the content of the external video source if it is connected and switched to playback.

For details on how to operate the external video source, see the respective device's operating instructions.

Showing/hiding the menu

- ▶ **To show:** press \odot the COMAND controller.
- ▶ **To hide:** slide $\uparrow \odot$ the COMAND controller and confirm **Full screen** by pressing \odot .

Volume and sound settings

You will find details on volume (\triangleright page 135) and sound (\triangleright page 135) settings in the "At a glance" section.

WARNING

External video sources may have different volumes, which can mean that system messages such as traffic announcements and navigation system announcements are much louder. If necessary, please deactivate the system messages or adjust their volume manually.

- i** In some cases, the volume of the AUX device may be quieter or louder, or the usual maximum possible volume cannot be reached. On some devices, it is possible to adjust the volume separately. In this case, start at a medium volume and increase it gradually. This enables you to determine

whether the system is able to play the music at high volume without distorting it.

Rear Seat Entertainment System

General notes

Replacing batteries

Notes

Batteries are required for the remote control and for the two sets of cordless headphones.

WARNING

Batteries contain poisonous substances. Swallowing/ingesting batteries can result in serious personal injury or death. Always keep batteries away from children. If a battery is swallowed, seek immediate medical attention.

Environmental note

Dispose of used batteries in an environmentally responsible manner.

On the remote control



- ① Battery compartment
- ② Catch tab
- ③ Battery compartment cover

- ④ Retaining lugs
- ⑤ Batteries

The remote control contains two type AAA, 1.5 V batteries.

- ▶ **To open the battery compartment:** remove battery compartment cover ③ on the back of the remote control.
- ▶ To do so, press down retaining lug ② and take off battery tray cover ③.
- ▶ Remove discharged batteries ⑤ from the tray.
- ▶ Insert the new batteries. Observe the polarity markings on the batteries and battery compartment when doing so.
Left-hand battery: the positive pole (+) must face upwards.
Right-hand battery: the positive pole (+) must face downwards.
- ▶ **To close the battery compartment:** insert battery compartment cover ③ starting with retaining lugs ④ into the battery compartment and allow catch tab ② to engage in place.

On the cordless headphones

The battery compartment cover is located on the left headphone.



The cordless headphones contain two type AAA, 1.5 V batteries.

- ▶ **To open the battery compartment:** flip battery compartment cover ① upwards. As you do so, hold the left-hand side of the

headphones as shown to prevent the batteries from falling out.

- ▶ Remove the discharged batteries from the tray.
- ▶ Insert the new batteries. Observe the polarity markings on the batteries and battery compartment when doing so.
Left-hand battery: the positive pole (+) must face upwards.
Right-hand battery: the positive pole (+) must face downwards.
- ▶ **To close the battery compartment:** press battery compartment cover ① downwards until it engages into place. If the batteries have been inserted correctly, the indicator lamp will light up green when the headphones are switched on.

Basic functions

Using headphones

You can use the cordless headphones supplied and/or up to two sets of corded headphones connected to the corresponding jack of the rear-compartment screens (> page 140).







You will find information on the following topics in the "Cordless headphones" section (> page 142).

- Switching the cordless headphones on/off
- Adjusting the volume of the headphones
- Selecting a screen for the headphones

Using the main loudspeakers

This function is available in conjunction with COMAND.







You can use the vehicle loudspeakers to listen to a disc inserted in the rear-compartment drive. To do so, at least one of the rear-compartment screens must be set to disc mode. The sound from TV programmes played on the rear-compartment screens cannot be heard on the vehicle loudspeakers.

- ▶ **To set operation via the main loudspeakers:** press the  function button on the centre console once or twice.
- ▶ Select **Audio** by sliding   the COMAND controller and press  to confirm. The Audio menu appears.
- ▶ Select **Rear** by turning   the COMAND controller and press  to confirm.

i The headphones' volume setting does not affect the main loudspeakers.

Adjusting the sound settings

You can select the sound settings in the audio CD/DVD/MP3, TV, video DVD and AUX modes.

- ▶ Switch on an audio operating mode (e.g. audio CD mode).
- ▶ Select **Treble** or **Bass** using the    buttons on the remote control and press the  button to confirm. An adjustment scale appears.
- ▶ Select a setting using the   buttons and press the  button to confirm.

Multiple users

Simultaneous use of the rear-compartment disc drive

The two rear-compartment screens can be operated almost entirely independently from one another. However, there can be a conflict in some menus if the two screens are used simultaneously.

If the rear-compartment disc drive is being used for both screens simultaneously, selecting certain menus or settings on one of the screens also affects the other screen.

The following functions affect both screens:

- changing playback options
- selecting a track (from a track list or folder)
- using the play, pause and stop functions
- fast forwarding/rewinding or scrolling

- calling up the DVD menu and navigating within it
- setting the language, subtitles and camera angle
- calling up interactive DVD content

The following functions affect only one screen:

- audio and video functions as well as picture settings
- switching between full screen and the menu

Switching between operating modes

When you exit an operating mode (e.g. audio CD mode), the current setting is saved. If you call up this operating mode again later, there are two possibilities:

- the operating mode has been changed on the other screen.
- the operating mode has not been changed.

In the first case, the operating mode appears as it is on the other screen.

In the second case, the setting appears on the screen as it was when you last exited the operating mode.

Picture settings

Overview

You can select these settings in TV, video DVD and AUX mode. Instructions for AUX mode are detailed later (▷ page 271).

Adjusting the brightness, contrast and colour

- ▶ Switch on TV mode (▷ page 243) or video DVD mode (▷ page 249).
- ▶ **To show the menu:** press the  button on the remote control.

or

- ▶ Select **Menu** while the navigation menu (▷ page 249) is shown and press the  button to confirm.

- ▶ In both cases, select **TV** or **Video DVD** using the buttons and press the button to confirm.
- ▶ Select **Brightness**, **Contrast**, **Colour** or **Auto** using the buttons and press to confirm.
An adjustment scale appears.
- ▶ Select a setting using the buttons and press the button to confirm.

Changing the picture format

- ▶ **To show the menu:** press the button on the remote control.
or
- ▶ Select **Menu** while the navigation menu ([▷ page 249](#)) is shown and press the button to confirm.
- ▶ Select **TV** or **Video DVD** using the buttons and press the button to confirm.
The symbol in front of the **Auto**, **16:9 optimised**, **4:3** or **Widescreen** menu item indicates the format currently set.
- ▶ Select a format using the buttons and press the button to confirm.

System settings

Note

You can adjust almost all system settings individually for each screen without affecting the other screen. You make these settings using the remote control.

Selecting the display language

- ▶ Select **System** using the buttons on the remote control and press the button to confirm.
You see the system menu on the selected rear screen.











- ▶ Select **System settings** using the button and press the button to confirm.
- ▶ Select **Language** using the buttons and press the button to confirm.
The list of languages appears. The indicates the current setting.
- ▶ Select a language using the buttons and press the button to confirm.
The Rear Seat Entertainment System activates the respective language.

Switching the display design





- ▶ Select **System settings** in the system menu using the button on the remote control and press the button to confirm.
- ▶ Select **Day design**, **Night design** or **Automatic** using the buttons and press the button to confirm.
The icon indicates the current setting.

Design	Explanation
Day design	The display is set permanently to day design.
Night design	The display is set permanently to night design.
Automatic	The display design changes depending on the vehicle instrument cluster illumination.

Setting the brightness

- ▶ Select **System settings** in the system menu using the  button on the remote control and press the  button to confirm.
- ▶ Select **Brightness** using the   buttons and press the  button to confirm. A scale appears.
- ▶ Adjust the brightness using the   buttons and press the  button to confirm. The brightness bar moves up or down. The picture becomes lighter or darker in accordance with the scale.

Showing/hiding the picture

- ▶ **To hide the picture:** select **Display off** in the system menu using the   buttons on the remote control and press the  button to confirm. The picture is hidden.
- ▶ **To display the picture:** press the  button.

Audio CD/DVD and MP3 mode

Safety note

WARNING

The CD/DVD drive is a class 1 laser product. You must not open the casing. There is a risk of exposure to invisible laser radiation if the casing is opened, or if the casing is faulty or damaged.

The Rear Seat Entertainment System contains no parts which you can repair yourself. For safety reasons, all maintenance work must be carried out by qualified aftersales technicians.

General notes

You will find information on the following topics in the Audio section:

- notes on CDs/DVDs (▶ page 232)
- notes on MP3 mode (▶ page 230)
- notes on copyright (▶ page 231)

Inserting a CD/DVD

The CD/DVD drive is located in the centre behind the front seats.



- ① Disc slot:
- ② Eject button:

The CD/DVD drive is a single disc drive. If there is already a disc inserted, this must be ejected before another is inserted.

- ▶ Insert a disc into the disc slot. The printed side of the disc must face upwards. If neither side of the disc is printed, the side you wish to play must face downwards. The CD/DVD drive draws in the disc.



P82.87-5596-31

The CD/DVD drive plays the disc:





- if it has been inserted correctly and is a permissible disc, and
- after you have switched on disc mode (audio CD/audio DVD/MP3 mode).

Data on an MP3 CD first needs to be loaded by the drive. Loading may take a some time, depending on the number of folders and tracks.

Removing a CD/DVD

- ▶ Press the  eject button. The drive ejects the disc.
- ▶ Take the disc out of the slot. If you do not take the disc out of the slot, the drive will draw it in again automatically after a short while.



Switches to audio CD, audio DVD or MP3 mode

- ▶ Insert a CD/DVD (▷ page 258). The Rear Seat Entertainment System loads the inserted disc.
- ▶ Select **Disc** in the menu using the    buttons on the remote control and press the  button to confirm. The corresponding mode is switched on. The Rear Seat Entertainment System plays the disc.



i Variable bit rates in MP3 tracks can result in the elapsed time shown being different to the actual elapsed time.

Selects a track

Selecting by skipping to a track

- ▶ **To skip forwards or backwards to a track:** press the  or  button on the remote control.

or

- ▶ Press the  or  button. The skip forward function skips to the next track.

Skipping backwards restarts the current track (if it has been playing for more than eight seconds) or starts the previous track (if the current track has been playing for a shorter time).









If you have selected the **Track list mix** or **Random folder** playback options, the track order is random.

Selecting by track list

In audio CD mode, the track list contains all tracks on the disc currently playing.

In audio DVD mode, the track list contains all tracks in the currently active group; see "Setting the audio format" (▷ page 230).

In MP3 mode, the track list shows all tracks in the currently active folder as well as the folder structure, allowing you to select any track on the MP3 CD.

- ▶ Select **Track list** (audio CD/DVD mode) or **Folder** (MP3 mode) using the    buttons on the remote control and press the  button to confirm.
- or
- ▶ Press the  button when the display/selection window is selected. The track list appears. The  dot indicates the current track.
- ▶ Select a track using the  or  button and press the  button to confirm.

Making a selection by entering the track number directly

- ▶ Press the  button on the remote control. The track entry display appears.

Example: track 2

- ▶ Press the  number key.

Example: track 12

- ▶ Press the corresponding number buttons in rapid succession.

i It is not possible to enter numbers that exceed the number of tracks on the CD or in the currently active folder.

- ▶ Wait for approximately three seconds after making the entry. You will hear the track which has been entered. The corresponding basic menu then reappears.

Fast forward/rewind

- ▶ With the display/selection window active, press the ◀ or ▶ button on the remote control repeatedly until you reach the desired position.

or

- ▶ Press and hold the ◀◀ or ▶▶ button until the desired position is reached.

Selecting a folder

This function is only available in MP3 mode.

- ▶ Select **Folder** in MP3 mode using the ▼ ◀ ▶ buttons on the remote control and press the OK button to confirm.

or

- ▶ Press the OK button when the display/selection window is selected. The folder content appears.



- ① Folder selection symbol
- ② Current folder name
- ③ Track symbol

- ▶ **To switch to the superordinate folder:** select icon ① using the ▲ ▼ buttons on the remote control and press the OK button to confirm. The display shows the next folder up.

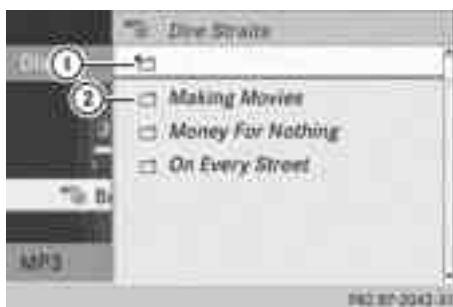

- ① Folder selection symbol

- ② Folder icon

- ▶ Select a folder using the ▲ or ▼ button and press the OK button to confirm. You will see the tracks in the folder.
- ▶ Select a track using the ▲ or ▼ button and press the OK button to confirm. The track is played and the corresponding folder is now the active folder.















Pause function

This function is only available in audio DVD mode.

- ▶ **To pause playback:** select || using the ▼ ◀ ▶ buttons on the remote control and press the OK button to confirm. The || display changes to ▶.
- ▶ **To continue playback:** select ▶ and press the OK button to confirm. The ▶ display changes to ||.













Stop function

This function is only available in audio DVD mode.

- ▶ **To interrupt playback:** select  using the    buttons on the remote control and press the  button to confirm. The  display changes to .
- ▶ **To continue playback:** select  and press the  button to confirm. Playback continues from the point where it was interrupted.
- ▶ **To stop playback:** while playback is interrupted, select  again and press the  button to confirm. Playback stops and returns to the beginning of the DVD.  is highlighted.
- ▶ **To restart playback:** select  and press the  button to confirm. Playback starts from the beginning of the DVD.





Setting the audio format





Further information on audio formats is available in the "Audio" section (▷ page 230).



- ▶ Select **DVD-A** using the    buttons on the remote control and press the  button to confirm.
- ▶ Select **Group** using the   buttons and press the  button to confirm. The list of available audio formats appears. The  dot indicates the format currently selected.
- ▶ Select an audio format using the   buttons and press the  button to confirm.
- ▶ **To exit the menu:** press the  or  button.

Playback options

Further information on playback options is available in the "Audio" section (▷ page 230).

- ▶ Select **CD**, **DVD-A** or **MP3** using the    buttons on the remote control and press the  button to confirm.

Select **CD**, **DVD-A** or **MP3** using the    buttons on the remote control and press the  button to confirm. The options list appears. The  dot indicates the option currently selected.

- ▶ Select **Normal track sequence**, **Track list mix** or **Random folder** using the   buttons and press the  button to confirm.







The option is switched on. All options except **Normal track sequence** will be indicated in the display/selection window.

-  If you change the disc, the **Normal track sequence** option is activated automatically. If an option is selected, it remains selected after the Rear Seat Entertainment System is switched on or off.

Switching track information on/off (MP3 mode only)

If the function is switched on, folder and track names are displayed.

If the function is switched off, disc and file names are displayed.

- ▶ Select **MP3** using the    buttons on the remote control and press the  button to confirm.
- ▶ Select **Show track information** using the   buttons and press the  button to confirm. The function is switched on or off , depending on the previous status.

Video DVD mode

General notes

Here you will find further information on the following topics:

- safety notes (▷ page 223)
- notes on DVDs (▷ page 248)

DVD playback conditions

There may be playback problems when playing copied discs. There are a large variety of discs, DVD authoring software, burning software and burners available. This variety means that there is no guarantee that the Rear Seat Entertainment System will be able to play video DVDs that you have copied yourself.

You will find further information in the "Video" chapter (▷ page 248). Information regarding COMAND also applies to the Rear Seat Entertainment System.





Function restrictions

Depending on the DVD, it is possible that certain functions or actions described in this section will be temporarily blocked or may not function at all. As soon as you try to activate these functions or actions, you will see the  symbol in the display.

Inserting and removing a CD/DVD

- ▶ Proceed as described in the "Audio CD/DVD and MP3 mode" section (▷ page 223).





Activating video DVD mode

- ▶ Insert a video DVD.
The Rear Seat Entertainment System loads the disc.
If disc mode was the last mode selected, it will now be active.
If it was not, switch on video DVD mode as described in the following instruction.
- ▶ Select **Disc** in the menu using the    buttons on the remote control and press the  button to confirm. If the video DVD fulfils the playback criteria, the film either starts automatically or the menu saved on the DVD appears. If the

DVD menu appears, you must start the film manually.

- ▶ Select the corresponding menu item in the DVD menu.

Hiding/showing the navigation menu





- ▶ **To show:** press the  or  button on the remote control.
- ▶ **To hide:** press the  or  button.
or
- ▶ Wait for approximately eight seconds.



Control menu

- ① Data medium type
- ② Current track
- ③ Current scene
- ④ Track time
- ⑤ To show the menu

Showing/hiding the menu

- ▶ **To show:** press the  button on the remote control.
or
- ▶ Select **Menu** while the navigation menu is shown and press the  button to confirm.
- ▶ **To hide:** press the  button and confirm **Full screen** by pressing the  button.



Menu system

- ① Video DVD options
- ② Pause function
- ③ Stop function
- ④ To set the treble
- ⑤ To set the bass

Fast forward/rewind

- ▶ Press and hold the or button on the remote control until the desired position has been reached. You see the navigation menu.

Pause function

- ▶ **To show the menu:** press the button on the remote control.
- or
- ▶ Select **Menu** while the navigation menu is shown and press the button to confirm.
- ▶ **To pause playback:** select and press the button to confirm. The display changes to .
- ▶ **To continue playback:** select and press the button to confirm. The menu is hidden.

Stop function

- ▶ **To show the menu:** press the button on the remote control.
- or
- ▶ Select **Menu** while the navigation menu is shown and press the button to confirm.
- ▶ **To interrupt playback:** select and press the button to confirm. The display changes to . The video image is hidden.
- ▶ **To continue playback:** select and press the button to confirm. Playback continues from the point where it was interrupted. The menu is hidden.
- ▶ **To stop playback:** while playback is interrupted, select again and press the button to confirm. Playback stops and returns to the beginning of the DVD. is highlighted.
- ▶ **To restart playback:** select and press the button to confirm. Playback starts from the beginning of the DVD.

Selecting a scene/chapter

Note









Further information on this function is available in the "Video" section (▷ page 251).

Skipping forwards/backwards

- ▶ Press the or button on the remote control.
- or
- ▶ Press the or button. The control menu appears for approximately eight seconds.

Selecting a scene/chapter directly

The examples illustrate how to select scene/chapter 5.



- ▶ **Option 1:** while the film is playing, press the  button on the remote control.
 - ▶ Press a corresponding number key, e.g. .
 - ▶ **Option 2:** while the film is playing, press the  button on the remote control and show the menu.
 - ▶ Select **Video DVD** and press the  button to confirm.
 - ▶ Select **DVD functions** and press the  button to confirm.
 - ▶ Select **Scene selection** and press  to confirm.
 - ▶ Press  or  to select number **5** and press the  button to confirm.
- In both cases, playback will begin from the fifth scene/chapter after a brief pause.

Selecting a film/title



Note

Further information on this function is available in the "Video" section (▷ page 251).

Option 1

- ▶ Press the  button on the remote control and show the menu.
- ▶ Select **Video DVD** and press the  button on the remote control to confirm.



- ▶ Select **DVD functions** and press the  button to confirm.
- ▶ Select **Title selection** and press  to confirm.

- ▶ **To call up the selection list:** press the  button.
- ▶ Select a film/track.

Option 2:

Example: selecting film 2





- ▶ Press the  button.
- After a brief pause, the second film is played.

DVD menu





Note

You will find further information on the DVD menu in the "Video" section (▷ page 248).

To call up the DVD menu

- ▶ Press the  button on the remote control and show the menu.
 - ▶ Select **Video DVD** and press the  button on the remote control to confirm.
 - ▶ Select **DVD functions** and press the  button to confirm.
 - ▶ Select **Menu** and press  to confirm.
- The DVD menu appears.

Selecting menu items in the DVD menu



- ▶ Select a menu item using the     buttons on the remote control and press the  button to confirm.

A menu appears.





- ▶ **i** Menu items which cannot be selected are shown in grey.





- ▶ Confirm **Select** by pressing the  button. The Rear Seat Entertainment System executes the action or shows a submenu.
- ▶ If available, additional options can now be selected. The Rear Seat Entertainment System then switches back to the DVD menu.

i Depending on the DVD, it is possible that the **Back (to the movie)**, **Play**, **Stop**, ,  or **Go up** menu item may not be operative or operative only at certain points of the DVD. To indicate this, the  icon appears in the display.

Stopping a film or skipping to the beginning or end of a scene



- ▶ Select any menu item from the DVD menu. The menu appears.
- ▶ **To stop the film:** select the **Stop** menu item and press the  button on the remote control to confirm.
- ▶ **To skip to the end of a scene:** select the  menu item and press the  button to confirm.
- ▶ **To skip to the beginning of a scene:** select the  menu item and press the  button to confirm.

Moving up one level in the DVD menu

- ▶ **Option 1:** press the  back button on the remote control or select the corresponding menu item in the DVD menu.
- ▶ **Option 2:** select any menu item in the DVD menu.
- ▶ Select the **Go up** menu item in the menu and press the  button to confirm.









Back to the film

- ▶ **Option 1:** press the  back button on the remote control repeatedly until you see the film or select the corresponding menu item in the DVD menu.

- ▶ **Option 2:** select any menu item in the DVD menu and press the  button to confirm.
- ▶ Select the **Back (to the movie)** menu item in the menu and press the  button to confirm.



Setting the audio format

This function is not available on all DVDs. If it is available, you can set the audio language or the audio format. The number of settings is determined by the DVD content. It is possible that the settings may also be accessed in the DVD menu.

- ▶ Press the  button on the remote control and show the menu.
- ▶ Select **Video DVD** and press the  button on the remote control to confirm.
- ▶ Select **DVD functions** and press the  button to confirm.
- ▶ Select **Audio language** and press the  button to confirm. A menu appears after a short while. The
 - dot in front of an entry indicates the currently selected language.
- ▶ Select a language using the  or  button and press the  button to confirm.
- ▶ **To exit the menu:** press the  or  button.

Subtitles and camera angle

These functions are not available on all DVDs. The number of subtitle languages and camera angles available depends on the content of the DVD. It is possible that the settings may also be accessed in the DVD menu.

- ▶ Press the  button on the remote control and show the menu.
- ▶ Select **Video DVD** and press the  button on the remote control to confirm.
- ▶ Select **DVD functions** and press the  button to confirm.

- ▶ Select **Subtitles** or **Camera angle** and press the **OK** button to confirm.
In both cases, a menu appears after a few seconds. The ● dot in front of an entry indicates the current setting.
- ▶ Select the setting using the **▲** or **▼** button and press the **OK** button to confirm.
- ▶ **To exit the menu:** press the **◀** or **▶** button.

Interactive content

DVDs can also contain interactive content (e.g. a video game). In a video game, you may be able to influence events by selecting and triggering actions. The type and number of actions depend on the DVD.

- ▶ Select an action using the **▲** **▶** **▼** **◀** buttons on the remote control and press the **OK** button to execute it.
A menu appears and the first entry, **Select**, is highlighted.
- ▶ Press the **OK** button.

TV mode

General information

Further information on channel reception quality can be found in the "Video" section (▶ page 242).

Switching to TV mode

- ▶ Select **TV** using the **▲** **◀** **▶** buttons on the remote control and press the **OK** button to confirm.
You see the last TV channel selected, provided it can still be received.

Hiding/showing the navigation menu

- ▶ **To show:** press the **▲** or **▼** button on the remote control.

- ▶ **To hide:** press the **▲** or **▼** button.
or
- ▶ Wait for approximately eight seconds.



Navigation menu displayed

- ① Preset position of the selected TV channel
- ② Selected TV channel
- ③ Current programme (digital TV receiver only)
- ④ Next TV channel in the channel list (channel name or number)
- ⑤ To show the menu
- ⑥ Previous TV channel in the channel list (channel name or number)

Showing/hiding the menu

- ▶ **To show:** press the **OK** button on the remote control.
or
- ▶ Select **Menu** while the navigation menu is shown and press the **OK** button to confirm.
- ▶ **To hide:** press the **▲** button and confirm **Full screen** by pressing the **OK** button.



Menu shown

- ① To call up the TV options menu
- ② To call up the channel presets
- ③ Information on the current programme (only for digital TV channels)
- ④ To set the treble
- ⑤ To set the bass

Selecting TV channels

Selecting channels from the navigation menu

- ▶ Press the or button on the remote control while the display window is active.

or

- ▶ Press the or button. The TV tuner selects the previous or next channel from the alphabetical channel list.

Selecting stations via the station presets

- ▶ **To show the menu:** press the button on the remote control.

or

- ▶ Select **Menu** while the navigation menu is shown and press the button to confirm.
- ▶ Select **Presets** using the or button and press the button to confirm. The station preset memory appears. The dot indicates where the selected channel is currently stored.



Station presets

- ▶ Select a channel using the or button and press the button to confirm.
- or
- ▶ Press a number key.

Selecting a station from the station list

Notes on the channel list can be found in the "Video" section (page 244). Information regarding COMAND also applies to the Rear Seat Entertainment System.

- ▶ **To show the menu:** press the button on the remote control.
- or
- ▶ Select **Menu** while the navigation menu is shown and press the button to confirm.
- ▶ Select **TV** using the or button and press the button to confirm.
- ▶ Select **Station list** and press the button to confirm.

The station list appears. The dot in front of a list entry indicates the currently selected channel. A number before the list entry shows the memory slot in the channel presets.

- ▶ Select a channel using the or button and press the button to confirm.

Selecting channels by entering the channel and programme number

Several programmes can be transmitted on one channel with digital TV. You can therefore enter a channel and the desired programme on this channel.

Only one programme can be sent on a channel with analogue TV. The programme entry function therefore has no effect.

► **To show the menu:** press the **OK** button on the remote control.

or

► Select **Menu** while the navigation menu is shown and press the **OK** button to confirm.

► **Option 1:** select **TV** using the **◀▶** buttons and press the **OK** button to confirm.

► Select **Channel input** and press the **OK** button to confirm.

► **Option 2:** press the ***** button while the TV is playing.

Irrespective of the option, an input bar appears at the top of the screen.

► **To set a channel:** enter the channel/programme number using the number keys and press the **OK** button to confirm.

or

► Press and hold the number key until the entry line is hidden. The channel is set.

i If you have not entered a programme number, the first programme with adequate reception will be set for a digital channel.

i You can enter channels or programmes available in your country even if the reception is currently not adequate.

If you enter channels that are either not intended for or not allowed in your country, the **Invalid channel number** message appears.

► Press the **OK** button and confirm the message.

Storing TV channels

Storing stations manually

There are ten preset positions available.

► **To show the menu:** press the **OK** button on the remote control or confirm **Menu** by pressing the **OK** button while the navigation menu is shown.

► Select **Presets** using the **◀▶** button and press the **OK** button to confirm. The station preset memory appears. The

- dot indicates under which preset the currently selected channel is stored.

► **To store a channel:** select a preset using the **▲▼** buttons and press and hold the **OK** button until you hear a tone.

or

► Press and hold the number key until an acoustic signal can be heard. Then, the TV picture reappears.

Storing channels automatically

This function automatically stores channels with adequate reception in order of their reception quality. Any channels stored manually in the preset memory will be lost.

► **To show the menu:** press the **OK** button on the remote control or confirm **Menu** by pressing the **OK** button while the navigation menu is shown.

► Select **Presets** using the **◀▶** button and press the **OK** button to confirm.

► Select **Autostore** and press the **OK** button. The Rear Seat Entertainment System searches for channels it can receive. The available channels are automatically stored in the preset positions.

Information about the current programme

This function is only available on digital TV channels. If you are watching an analogue TV channel, this menu cannot be selected.

- ▶ **To show the menu:** press the **OK** button on the remote control or confirm **Menu** by pressing the **OK** button while the navigation menu is shown.
- ▶ Select **Info** using the **◀** or **▶** button and press the **OK** button to confirm.
If the current TV channel provides the corresponding information, this will be displayed.

i It can take a few seconds for the information to be displayed.

Displaying the current programme or programme preview

This function is only available on digital TV channels. The programme preview is also referred to as the electronic programme guide (EPG).

- ▶ **To show the menu:** press the **OK** button on the remote control or confirm **Menu** by pressing the **OK** button while the navigation menu is shown.
- ▶ Select **TV** using the **◀** or **▶** button and press the **OK** button to confirm.
- ▶ Select **Station list** and press the **OK** button to confirm.
The station list appears. It shows the current programme on the digital TV channels with adequate reception. The **•** dot in front of a list entry indicates the currently selected channel.

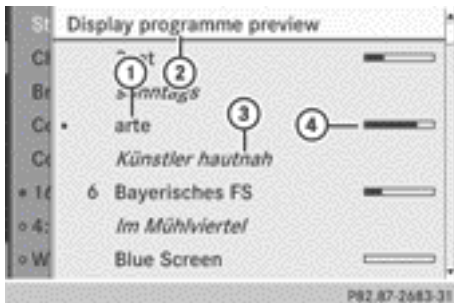

- ① Current TV channel
- ② To display the programme preview

- ③ Current programme
- ④ Visual display of the elapsed programme time

- ▶ **To show the programme preview:** select **Display programme preview** and press the **OK** button to confirm.
The channel list shows the channel's next programme.

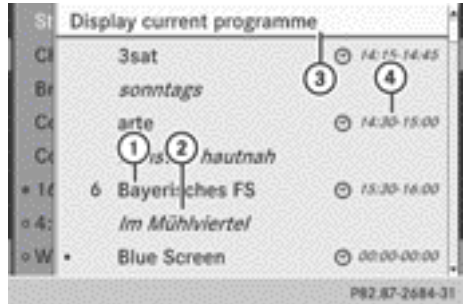

- ① TV channel
- ② Next programme
- ③ To display the current programme
- ④ The beginning and end of the programme

- ▶ **To show the current programme:** select **Display current programme** and press the **OK** button to confirm.
- ▶ **To close the display:** press the **◀** button.



Basic TV settings

Fixing the frequency

Further information on this function is available in the "Video" section (▷ page 247).



- ▶ **To show the menu:** press the **OK** button on the remote control or confirm **Menu** by pressing the **OK** button while the navigation menu is shown.
- ▶ Select **TV** using the **◀** or **▶** button and press the **OK** button to confirm.
- ▶ Select **Channel fix** and press the **OK** button to confirm.
The function is switched on or off , depending on the previous status. When

the function is switched on, **FIX** appears in the display window.

- ▶ **To exit the menu:** press the  or  button.

Setting the reception region

Further information on this function is available in the "Video" section (▷ page 247).

- ▶ **To show the menu:** press the  button on the remote control or confirm **Menu** by pressing the  button while the navigation menu is shown.

- ▶ Select **TV** using the  or  button and press the  button to confirm.

- ▶ Select **TV standard** and press the  button to confirm.

A list appears, showing the reception regions. The ● dot in front of a list entry indicates the currently selected reception area or country.

- ▶ Select the reception area and press the  button to confirm.
A message appears to inform you that if the wrong country is set, correct reception will not be possible.

- ▶ Select **Yes** or **No** and press the  button to confirm.
If you select **Yes**, the Rear Seat Entertainment System switches the country.
If you select **No**, the country list will appear again.



Teletext

Switching teletext on/off

- ▶ **To show the menu:** press the  button on the remote control.

or

- ▶ Select **Menu** while the navigation menu is shown and press the  button to confirm.

- ▶ **To activate:** select **Text:** using the  or  button and press the  button to confirm.

The first video text page is displayed.

- ▶ **To switch off:** press the  back button.

Selecting a teletext page

- ▶ **To select a page directly:** press the corresponding number keys on the remote control.

i You can only enter pages that are permissible for teletext between 100 and 899.

- ▶ **To call up the next/previous page:** press the  or  button.

Dynamic teletext page

A dynamic teletext page consists of several subpages. The display automatically changes to the next page after a certain time.

TV AUX mode



Introduction

You can connect two external video sources with audio and video transmissions to the TV tuner. Although the sockets are equipped with interference reduction, there may still be picture interference because not all devices conform to the standards.

For further details concerning the connection and activation of external video sources, please consult a Mercedes-Benz Service Centre.

Following activation, one or two further entries with corresponding names appear in the TV channel list. You can store these entries in the channel presets (▷ page 245) in the same way as TV channels.

Switching to TV-AUX mode

- ▶ Switch on TV mode (▷ page 243).
- ▶ Select **TV** using the  button on the remote control and press the  button to confirm.
- ▶ Select **TV-Aux** and press the  button to confirm.
You will see and hear the external video source if it is connected and switched to playback.

i Please see the corresponding operating instructions for information on how to operate the external video source.

AUX mode

Introduction

You can connect one external video source to each of the displays of the Rear Seat Entertainment System (AUX display) and also one external video source to the rear-seat CD/DVD drive (AUX drive) with a sound and picture signal.

Please see the corresponding operating instructions for information on how to operate the external video source.

For further details about external video sources, please consult a Mercedes-Benz Service Centre.

Connecting AUX equipment

AUX drive

The AUX drive jacks are located on the CD/DVD drive on the right next to the CD/DVD eject button (▷ page 271).

Display AUX







The AUX display jacks are on the side of the screen (▷ page 140).

Audio and video connection







- ▶ Insert the audio plugs for the left and right signals into the corresponding **L** and **R** jacks.
- ▶ Insert the video plug into the **V** jack.

Activating AUX mode







AUX drive

- ▶ Select **Aux** in the menu using the , ,  buttons on the remote control and press the  button to confirm.
The AUX menu appears.
- ▶ Select **Source** from the AUX menu and press the  button to confirm.
- ▶ Select **Disk drive Aux** and press the  button to confirm.
You will hear and see the content of the external video source if it is connected to the CD/DVD drive and switched to playback. If no video image is available from the AUX source connected, you will see an audio menu.

Display AUX









- ▶ Select the screen to which the external video source is connected using the remote control (▷ page 125).
- ▶ Select **Aux** in the menu using the , ,  buttons on the remote control and press the  button to confirm.
- ▶ Select **Source** from the AUX menu and press the  button to confirm.
- ▶ Select **Display Aux** and press the  button to confirm.
You will see and hear the content of the video source if it is switched to playback. If no video image is available from the AUX source connected, you will see an audio menu.

Selecting the active COMAND source

- ▶ Select **Aux** in the menu using the    buttons on the remote control and press the  button to confirm.
- ▶ Select **Source** from the AUX menu and press the  button to confirm.
- ▶ Select **COMAND** and press the  button to confirm.
The audio or video mode selected in COMAND is transmitted to the Rear Seat Entertainment System.







Operation with an active COMAND source

You can transfer an audio or video mode selected in COMAND to the Rear Seat Entertainment System.







- i** If you subsequently switch modes in COMAND, the new source will not be transmitted to the Rear Seat Entertainment System.
- ▶ **To switch on the function in COMAND:** switch on the desired audio mode in COMAND or show the menu in video DVD mode.
 - ▶ Select the menu item at the bottom left, e.g. **CD** in audio CD mode, by sliding  and turning  the COMAND controller and press  to confirm.
 - ▶ Select **Active source for rear** and press  to confirm.
In the status bar at the top, you will see the headphones icon and the  icon for the source that has been switched on.
- ▶ **To switch off the function in COMAND:** switch on the desired audio mode in COMAND or show the menu in video DVD mode.
 - ▶ Select the menu item at the bottom left, e.g. **CD** in audio CD mode, by sliding  and turning  the COMAND controller and press  to confirm.

- ▶ Select **Rear off**  and press  the COMAND controller to confirm.

Adjusting the brightness, contrast or colour

- ▶ Select **Source** in the rear-compartment screen and press the  button on the remote control to confirm.
- ▶ Select **Display Aux** or **Disk drive Aux** and press the  button to confirm.
- ▶ Select **Brightness, Contrast** or **Colour** and press the  button to confirm.
An adjustment scale appears.
- ▶ Select a setting using the  or  button and press the  button to confirm.

Changing the picture format

- ▶ Select **Source** in the AUX menu and press the  button on the remote control to confirm.
- ▶ Select **Display Aux** or **Disk drive Aux** and press the  button to confirm.
- ▶ Select **Auto16:9 optimised, 4:3** or **Widescreen** using the   buttons and press the  button to confirm.
The  icon in front of a menu item indicates the current setting.

Vehicle

Vehicle functions

General notes

In this menu, you can set the following vehicle functions:

- ECO
- Multicontour seat settings
- Rear window blind
- EASY-ENTRY/EXIT feature
- Exterior lighting delayed switch-off time
- Interior lighting delayed switch-off
- Ambient lighting

- Folding in the exterior mirrors automatically
- Locator lighting
- Automatic locking feature
- Interior motion sensor
- Tow-away protection
- Boot lid opening limiter

You can open the "Vehicle" menu in one of two ways.

Opening the "Vehicle" menu from the main area in the centre of the display

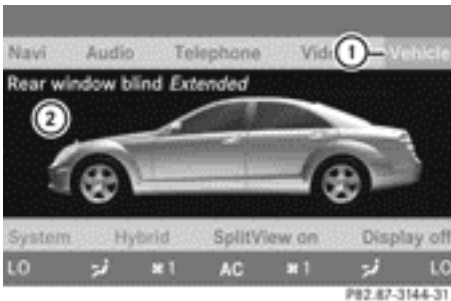

- ① "Vehicle" menu item
- ② Main area

- ▶ Select **Vehicle** in the main function bar by sliding ←○→ and turning **⌚** the COMAND controller and press **⏻** to confirm. Main area ② is active.
- ▶ Select the individual vehicle functions by sliding ←○→ or turning **⌚** the COMAND controller and press **⏻** to confirm.

Opening from the "Vehicle" menu



- ▶ Select **Vehicle** in the main function bar by sliding ←○→ and turning **⌚** the COMAND controller and press **⏻** to confirm. The "Vehicle" submenu opens.
- ▶ Select the individual vehicle functions in the menu by sliding ←○→ or turning **⌚** the COMAND controller and press **⏻** to confirm.

In the next section, it is the first procedure that is always described.

Switching the ECO function on/off

i Hybrid vehicles: the ECO start/stop function cannot be switched off.

The ECO start/stop function switches the engine off automatically if the vehicle is stopped under certain conditions. When pulling away again, the engine starts automatically (▷ page 325). You can switch the ECO start/stop function on and off using COMAND.

If you switch the ECO start/stop function off using COMAND, the function is switched on again automatically. This is the case if you switch the ignition off and on again.



- ▶ **To switch the ECO start/stop function on/off:** select **Vehicle** in the main function bar by sliding ←○→ and turning **⌚** the COMAND controller and press **⏻** to confirm. The main area is active.

- ▶ Select the **ECO function** by sliding ←○→ or turning ⏸ the COMAND controller and press ⏹ to confirm.
The ECO start/stop function is switched on and off alternately.

Extending/retracting the rear window blind

- ! Make sure that the rear window blind can move freely. Otherwise, the blind or other objects could be damaged.

- i The rear window blind is deactivated at temperatures below -20 °C.

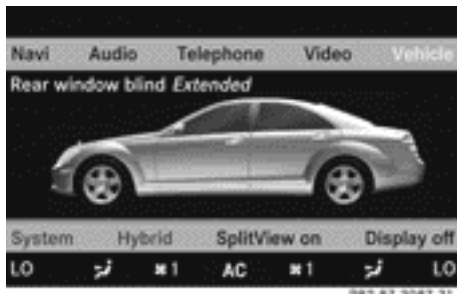

- ▶ **To extend/retract the rear window blind:** select **Vehicle** in the main function bar by sliding ←○→ and turning ⏸ the COMAND controller and press ⏹ to confirm.
The main area is active.
- ▶ Select the **Rear window blind function** by sliding ←○→ or turning ⏸ the COMAND controller and press ⏹ to confirm.

Activating/deactivating the automatic folding mirror function

In the **Automatic mirror folding** menu, you can set the exterior mirrors so that they automatically fold in when the vehicle is locked.



- ▶ **To activate/deactivate automatic mirror folding:** select **Vehicle** in the main function bar by sliding ←○→ and turning ⏸ the COMAND controller and press ⏹ to confirm.
The main area is active.
- ▶ Select the **Automatic mirror folding function** by sliding ←○→ or turning ⏸ the COMAND controller and press ⏹ to confirm.

Setting the EASY-ENTRY/EXIT feature

⚠ WARNING

Make sure that nobody can become trapped when you activate the EASY-ENTRY/EXIT feature.

If there is a risk of entrapment by the steering column, move the steering wheel adjustment lever or press the position button of the memory function.

If there is a risk of entrapment by the seat, you can also cancel the adjustment procedure by moving the switch for seat adjustment. The steering column and driver's seat stop moving immediately.

Never leave children unsupervised in the vehicle. They could open the driver's door and thereby unintentionally activate the EASY-ENTRY/EXIT feature and become trapped.

You can make a setting in COMAND so that the steering wheel swings upwards and/or the driver's seat moves backwards before you get into the vehicle. You can make the following settings:

- **Off:** the function is switched off.
- **Steering column:** the steering wheel swings upwards.
- **Steering column and seat:** the steering wheel swings upwards and the driver's seat moves backwards.

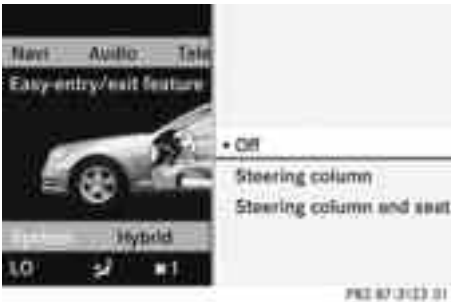

- ▶ **To set the EASY-ENTRY/EXIT feature:** select **Vehicle** in the main function bar by sliding ←→ and turning ⌚ the COMAND controller and press ⏻ to confirm. The main area is active.
- ▶ Select the **Easy-entry/exit feature menu** by sliding ←→ or turning ⌚ the COMAND controller. The EASY-ENTRY/EXIT feature menu appears. The current setting is indicated by a • dot.
- ▶ Select **Setting** by sliding ↑↓ or turning ⌚ the COMAND controller. The selected setting is indicated by a • dot.

Setting the interior/exterior lighting delayed switch-off time

Interior lighting: you can set whether and for how long you wish the interior lighting to remain on in the dark after you have removed the key from the ignition lock.

Exterior light: you can set whether and for how long you want the exterior lighting to remain on in the dark after the doors have been closed. The exterior lighting automatically switches off after the switch-off delay has elapsed.

You may select from the following settings:

- 0 seconds: delayed switch-off is deactivated.
- 15, 30, 45, 60 seconds: delayed switch-off is activated.

- ⓘ You can reactivate this function by opening a door within one minute. If none of the doors are opened after the key is removed from the ignition lock or if a door is not closed after it has been opened, the exterior lights switch off after 60 seconds.



- ▶ **To set the interior/exterior lighting delayed switch-off time:** select **Vehicle** in the main function bar by sliding ←→ and turning ⌚ the COMAND controller and press ⏻ to confirm. The main area is active.
- ▶ Select the **Interior lighting delayed switch-off/Exterior lighting delayed switch-off menu** by sliding

←⊙→ or turning **Ⓢ** the COMAND controller.

The interior/exterior lighting delayed switch-off time menu appears. The current setting is indicated by a • dot.

- ▶ Select **Setting** by sliding ↑⊙↓ or turning **Ⓢ** the COMAND controller. The selected setting is indicated by a • dot.

Setting the ambient light

You can make the following settings:

- **SOLAR** (yellow interior lighting)
- **NEUTRAL** (white interior lighting)
- **POLAR** (blue interior lighting)
- **Brightness** of the interior lighting on a scale of 0 (off) to 5 (bright)



- ▶ **To set the ambient lighting:** select **Vehicle** in the main function bar by sliding ←⊙→ and turning **Ⓢ** the COMAND controller and press **Ⓢ** to confirm. The main area is active.
- ▶ Select the **Ambient lighting** menu by sliding ←⊙→ or turning **Ⓢ** the COMAND controller. The ambient lighting menu appears. The current setting is indicated by a • dot.
- ▶ Select **Setting** by sliding ↑⊙↓ or turning **Ⓢ** the COMAND controller. The selected setting is indicated by a • dot.

Switching the locator lighting on/off

If you switch on the locator lighting, the following come on in the dark after you have unlocked the vehicle using the remote control:

- the side lamps
- the tail lamps
- the licence plate lighting
- the front foglamps
- the entry lamps in the exterior mirror

The locator lighting switches off again if you open the driver's door. If you do not open the driver's door, the locator lighting switches off automatically after 40 seconds.



- ▶ **To switch the locator lighting on/off:** select **Vehicle** in the main function bar by sliding ←⊙→ and turning **Ⓢ** the COMAND controller and press **Ⓢ** to confirm. The main area is active.
- ▶ Select the **Locator lighting** function by sliding ←⊙→ or turning **Ⓢ** the COMAND controller and press **Ⓢ** to confirm.

Switching the automatic locking feature on/off

You can use this function to activate or deactivate the automatic central locking feature. If the automatic locking feature is activated, your vehicle will lock centrally from a speed of approximately 15 km/h.

You will find further information about the automatic locking feature in the "Automatic locking feature" section (▷ page 87).

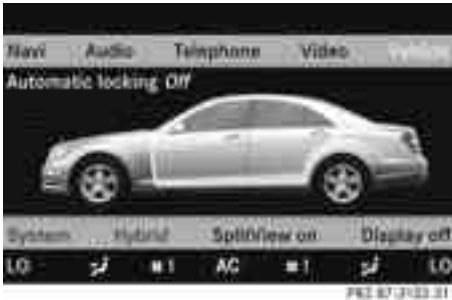

- ▶ **To switch the automatic locking feature on/off:** select **Vehicle** in the main function bar by sliding ←→ and turning **⌂** the COMAND controller and press **⏏** to confirm.
The main area is active.
- ▶ Select the **Automatic Locking function** by sliding ←→ or turning **⌂** the COMAND controller and press **⏏** to confirm.

Priming/deactivating the interior motion sensor

i You can assign this function to the programmable button (▷ page 119).

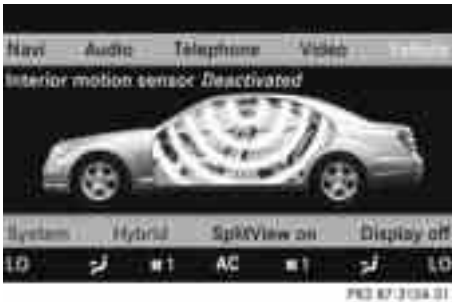

- ▶ **To prime/deactivate the interior motion sensor:** select **Vehicle** in the main function bar by sliding ←→ and turn-

ing **⌂** the COMAND controller and press **⏏** to confirm.

The main area is active.

- ▶ Select the **Interior motion sensor function** by sliding ←→ or turning **⌂** the COMAND controller and press **⏏** to confirm.

Priming/deactivating tow-away protection

i You can assign this function to the programmable button (▷ page 119).



- ▶ **To prime/deactivate tow away protection:** select **Vehicle** in the main function bar by sliding ←→ and turning **⌂** the COMAND controller and press **⏏** to confirm.
The main area is active.
- ▶ Select the **Tow-away protection function** by sliding ←→ or turning **⌂** the COMAND controller and press **⏏** to confirm.

Activating/deactivating the boot lid opening limiter



- ▶ **To activate/deactivate the boot lid opening limiter:** select **Vehicle** in the main function bar by sliding ←→ and turning the COMAND controller and press to confirm.

The main area is active.

- ▶ Select the **Boot lid opening limiter function** by sliding ←→ or turning the COMAND controller and press to confirm.

Automatic climate control

Introduction to automatic climate control

You can operate automatic climate control using COMAND or the buttons on the upper section of the centre console (▶ page 305). Several special automatic climate control functions can only be adjusted using COMAND.

You can access the automatic climate control menu via the air-conditioning function bar.

To do so, make certain that the key is in position **2** in the ignition lock.

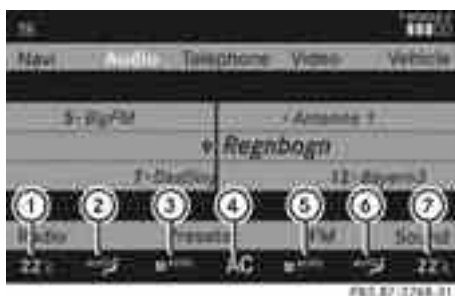

Air-conditioning function bar

- ① To set the temperature, left
- ② To set the air distribution, left
- ③ To set the airflow, left
- ④ Climate control main menu (▶ page 279)
- ⑤ To set the airflow, right
- ⑥ To set the air distribution, right
- ⑦ To set the temperature, right

Setting the temperature

You can set the temperature separately for the driver's and front-passenger side.



- ▶ Select left temperature display ① or right temperature display ⑦ in the air-conditioning function bar by turning the COMAND controller and press to confirm.











- ▶ **To adjust the temperature:** slide or turn the COMAND controller.
- ▶ **To confirm the selection:** press the COMAND controller.



Setting the air distribution

You can set the air distribution separately for the driver's and front-passenger side.

- ▶ Select left air distribution ② or right air distribution ⑥ by turning  the COMAND controller and press  to confirm.





-  Directs air through the demister vents
-  Directs air through the centre and side air vents
-  Directs air through the footwell vents
-  Directs air through the centre, side and footwell vents
-  Directs air through the demister and footwell vents
-  Directs air through the demister, centre, side and footwell vents
-  Directs air through the demister, centre and side air vents
-  Controls air distribution automatically





- ▶ **To adjust the air distribution:** turn  the COMAND controller.
- ▶ **To confirm the selection:** press  the COMAND controller.

Setting the airflow

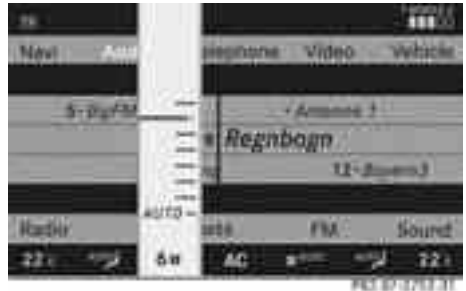
You can set the airflow separately for the driver's and front-passenger side.



- ▶ Select left airflow ③ or right airflow ⑤ by turning  the COMAND controller and press  to confirm.



- ▶ **To adjust the airflow:** slide   or turn  the COMAND controller.
- ▶ **To confirm the selection:** press  the COMAND controller.

Climate control main menu

COMAND allows you to set additional functions which cannot be selected using the control panel in the centre console. Call up these functions using the climate control main menu.

- ▶ **To open the climate control main menu:** select the **AC** climate control symbol in the air-conditioning function bar by turning  the COMAND controller and press  to confirm. The climate control menu opens.



Climate control main menu

You can:

- switch cooling with dehumidification on or off ()
- control climate control centrally (**Mono**)
- adjust the **Footwell temperature**







- set the **Airflow** for the air vents
- operate the **Rear** air conditioning from the front
- set the **Auxiliary heating, departure time**

Switching cooling with air dehumidification on/off

Cooling is operational when the engine is running, and cools according to the selected interior temperature for the vehicle. Cooling also dehumidifies the air inside the vehicle and, thereby, prevents the windows from misting up.

WARNING

If you deactivate the cooling function with air dehumidification, the vehicle will not be cooled in warm weather and the air will not be dehumidified. The windows could mist up more quickly. This may prevent you from observing the traffic conditions, thereby causing an accident.

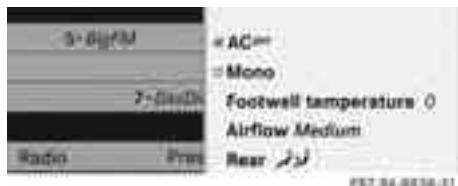

- i** Condensation may collect on the underside of the vehicle when the cooler is operating.
- ▶ Select the climate control main menu in the air-conditioning function bar by turning  the COMAND controller and press  to confirm. The climate control menu opens.
- ▶ **To switch on:** select  and press .
- ▶ **To switch off:** select  and press . A tick appears.



Controlling climate control centrally

You can use the **Mono** function to set all the air-conditioning zones in the vehicle to the same settings. If the **Mono** function is

switched on and you adjust climate control on the driver's side, these changes will also be made in all the air-conditioning zones.

- ▶ Select the climate control main menu in the air-conditioning function bar by turning  the COMAND controller and press  to confirm. The climate control menu opens.
- ▶ Select **Mono** and press . A tick appears when the function is selected.



The **Mono** function is automatically switched off if you:

- change settings for automatic climate control on the front-passenger side using COMAND
- press one of the rocker switches to operate automatic climate control on the front-passenger side
- press one of the rocker switches on the rear-compartment control panel

Adjusting the footwell temperature

You can use the **Footwell temperature** function to set the temperature difference between the footwell and the rest of the vehicle interior.

- i** This setting is quite effective in automatic mode, especially at low outside temperatures.

The greater the value you set, the higher the temperature in the footwell.

- ▶ Select the climate control main menu in the air-conditioning function bar by turning

🔍 the COMAND controller and press  to confirm.

The climate control menu opens.

- ▶ Select **Footwell temperature** and press .

A scale appears.



- ▶ **To change the temperature difference:** slide    or turn .

- ▶ **To confirm your selection:** press .

Setting the blower settings for the air vents



This function allows you to determine the way the air is blown through the air vents in automatic mode.

You can select:

- **Focused** (high blower setting)
- **Medium** (standard setting)
- **Diffuse** (low blower setting)

i This setting is quite effective in automatic mode, especially at high outside temperatures.

If the vehicle has become very warm and the automatic air conditioning is cooling the interior, the blower settings are briefly cancelled.

- ▶ Select the climate control main menu in the air-conditioning function bar by turning  the COMAND controller and press  to confirm.

The climate control menu opens.

- ▶ Select **Airflow** and press .

A menu appears.

The current setting is indicated by a • dot.





- ▶ **To change the airflow:** slide    or turn .

- ▶ **To confirm your selection:** press .

Operating the rear-compartment air-conditioning system from the front

The rear-compartment air-conditioning system is operated in the same way as climate control for the driver and front passenger.

Switching on operation of the rear-compartment air conditioning from the front

- ▶ Select the climate control main menu in the air-conditioning function bar by turning  the COMAND controller and press  to confirm.

The climate control menu opens.

- ▶ Select **Rear**  and press .

Rear appears in the main menu on the air-conditioning function bar. The rear-compartment air-conditioning system can be controlled from the front.

Main menu for the rear-compartment air-conditioning system

In the main menu for the rear-compartment air-conditioning system, you can:

- switch back to front-compartment climate control operation
- switch off the rear-compartment air conditioning
- switch automatic mode for the rear-compartment air conditioning on/off

- ▶ **To open the main menu:** select the climate control main menu in the air-conditioning function bar and press .



The current setting is indicated by a • dot. To switch back to operation of the rear-compartment air-conditioning system from the front:

- ▶ In the climate control main menu, select **Front climate control** and press . The air-conditioning function bar shows the climate control settings for the driver and front passenger.

To switch off the rear-compartment air conditioning:

- ▶ In the climate control main menu, select **Rear climate control off** and press .



To switch on automatic mode for the rear-compartment air conditioning:

- ▶ In the climate control main menu, select **Rear automatic** and press . Automatic mode for the rear-compartment air-conditioning system is switched on.

Setting the departure time for the auxiliary heating

You can use the **Auxiliary heating, departure time** function to:



- enter a departure time at which the vehicle is preheated by the auxiliary heating
- select a time from the three stored departure times

- ▶ Select the climate control main menu in the air-conditioning function bar by turning  the COMAND controller and press  to confirm. The climate control menu opens.
- ▶ Select **Auxiliary heating, departure time** and press .



The auxiliary heating timer function calculates the switch-on time according to the outside temperature so that the vehicle is preheated by the departure time. When the departure time is reached, the auxiliary heating continues to heat for a further five minutes and then switches off.

Selecting a departure time



- ▶ Select the climate control main menu in the air-conditioning function bar by turning  the COMAND controller and press  to confirm. The climate control menu opens.
- ▶ Select **Auxiliary heating, departure time** and press . The current setting is indicated by a • dot.



- ▶ Select the desired departure time and press . The yellow indicator lamp lights up on the button for the auxiliary heating on the centre console.

A selected departure time is only initiated once and is not repeated daily. Once the departure time has been reached, the system switches back to the **No pre-selection** option.





Deselecting a departure time

- ▶ Select the climate control main menu in the air-conditioning function bar by turning  the COMAND controller and press  to confirm. The climate control menu opens.
- ▶ Select **Auxiliary heating, departure time** and press . The current setting is indicated by a • dot.









- ▶ Select **No pre-selection** and press .

Entering a departure time

- ▶ Select the climate control main menu in the air-conditioning function bar by turning  the COMAND controller and press  to confirm. The climate control menu opens.
- ▶ Select **Auxiliary heating, departure time** and press .
- ▶ Select **Set time** and press .



- ▶ **To change the hours or minutes:** slide   or turn .
- ▶ **To switch between hours and minutes:** slide  .
- ▶ **To store the departure time:** press .



Seats

Lumbar supports

The lumbar support in the backrest of the driver's and front-passenger seats can be adjusted to provide optimum support for your back.

- ▶ **To select the seat:** press the  function button. The main area of the COMAND display is active. A scale appears.



- ▶ **To move to the lower menu bar:** select by sliding   the COMAND controller and press .

- i** When you press the  function button, the previously adjusted seat is active.

- ▶ **To adjust the lumbar support:** select by sliding ←○→ or turning ⏸ the COMAND controller and press ⏹ to confirm.

Multicontour seat

- i** Information about the components and operating principles of COMAND can be found on (▷ page 117).

The contour of the driver's seat and front-passenger seat backrests can be individually adjusted to provide optimum support for your back. This is achieved by controlling the pressure in the air chambers in the multicontour seat.

The adjustments are made using the COMAND display.

- i** When you adjust the multicontour seat, you may hear the air being pumped in or released.

You can adjust the following air cushions:

- seat side bolsters
- seat backrest side bolsters
- backrest curvature in the lumbar region
- backrest curvature in the upper back region
- ▶ Make sure that the key is in position **2** in the ignition lock.
- ▶ Press the  function button.

Selecting the seat

You must first select the seat for which you wish to make adjustments.

- ▶ Press the  function button. The main area is active.
- ▶ **To move to the lower menu bar:** select by sliding ↑○↓ the COMAND controller and press ⏹ to confirm.



- ▶ **To select a seat:** select by sliding ←○→ or turning ⏸ the COMAND controller and press ⏹ to confirm.

Exiting a menu

There are several ways of exiting the menu for the multicontour seat:

- ▶ Press the  function button again.
- or
- ▶ Press any function button.
- or
- ▶ Select another main function from the basic menu.

Display values

Two values are displayed on the setting scale if you adjust the multicontour seat:

- red: this is the desired value which you specify when making the setting.
- white: this is the current value. It is changed gradually until it reaches the desired value.

Adjusting the seat side bolsters

This function allows you to adjust the air cushions in the seat side bolsters.

- ▶ Select the seat (▷ page 284).
- ▶ Select **Seat sides** by sliding ←○→ or turning ⏸ the COMAND controller and press ⏹ to confirm. A scale appears.



- ▶ Select **Setting** by sliding $\uparrow\odot\downarrow$ or turning $\{\odot\}$ the COMAND controller and press \odot to confirm.

Adjusting the seat backrest side bolsters

This function allows you to adjust the air cushions in the seat backrest side bolsters.

- ▶ Select the seat (▷ page 284).
- ▶ Select **Backr. sides** by sliding $\leftarrow\rightarrow$ or turning $\{\odot\}$ the COMAND controller and press \odot to confirm. A scale appears.



- ▶ Select **Setting** by sliding $\uparrow\odot\downarrow$ or turning $\{\odot\}$ the COMAND controller and press \odot to confirm.

Adjusting the backrest curvature in the lumbar region

This function allows you to adjust the air cushions in the lumbar region of the backrest.

- ▶ Select the seat (▷ page 284).
- ▶ Select **Lumbar** by sliding $\leftarrow\rightarrow$ or turning $\{\odot\}$ the COMAND controller and press \odot to confirm. A crosshair appears. You can make two settings:
 - **Vertical:** to move the point of greatest lumbar support up or down
 - **Horizontal:** to adjust the amount of support



- ▶ Select **Setting** by sliding $\uparrow\odot\downarrow$ or turning $\{\odot\}$ the COMAND controller and press \odot to confirm.

Adjusting the backrest curvature in the upper back region

This function allows you to adjust the air cushions in the upper back region of the backrest.

- ▶ Select the seat (▷ page 284).
- ▶ Select **Shoulders** by sliding $\leftarrow\rightarrow$ or turning $\{\odot\}$ the COMAND controller and press \odot to confirm. A scale appears.

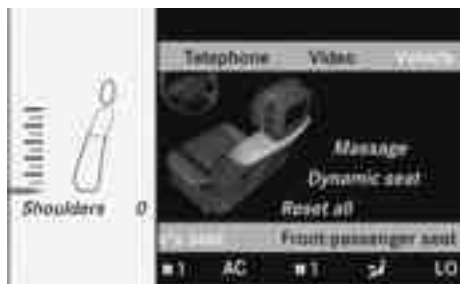

FIG. 87-3175-31

- ▶ Select **Setting** by sliding $\uparrow\odot\downarrow$ or turning $\{\odot\}$ the COMAND controller and press \odot to confirm.

Resetting adjustments

You can reset the seat settings to the factory settings.

- ▶ Select the seat (\triangleright page 284).
- ▶ Select **Reset all** by sliding $\leftarrow\odot\rightarrow$ or turning $\{\odot\}$ the COMAND controller and press \odot to confirm.

Active multicontour seat

The dynamic function of the active multicontour seat automatically adapts the side bolsters of the backrest to your current driving style.

- ▶ Select the seat (\triangleright page 284).
- ▶ Select **Dynamic seat** by sliding $\leftarrow\odot\rightarrow$ or turning $\{\odot\}$ the COMAND controller and press \odot to confirm.
- ▶ **To confirm your selection:** press \odot .

A scale appears.

You can select:

- **0:** Off
- **1:** Level 1
- **2:** Level 2



FIG. 87-3175-31

- ▶ Select **Setting** by sliding $\uparrow\odot\downarrow$ or turning $\{\odot\}$ the COMAND controller and press \odot to confirm.

Massage function (PULSE)

The massage function helps you to prevent muscle tension on long journeys.

- ▶ Select the seat (\triangleright page 284).
 - ▶ Select **Massage** by sliding $\leftarrow\odot\rightarrow$ or turning $\{\odot\}$ the COMAND controller and press \odot to confirm.
- A list appears.

You can select different types of massage function:

- **0:** Off
- **1:** Slow and gentle
- **2:** Slow and vigorous
- **3:** Fast and gentle
- **4:** Fast and vigorous

- ▶ **To confirm your selection:** press \odot .



FIG. 87-3175-31

- ▶ Select **Setting** by sliding $\uparrow \odot \downarrow$ or turning $\left[\odot \right]$ the COMAND controller and press \odot to confirm.
The massage function runs for approximately 6 to 20 minutes, depending on the setting.

Uploading/downloading data

With this function, you can transfer COMAND data from one system (vehicle) to another system (vehicle). You can use either a USB stick or an SD card as temporary storage.

You can only transfer the complete transferable data record.

The following data is included in the complete transferable data record:

- navigation destination memory and last destination
- address book entries
- audio station/video channel presets
- system settings



Copying data to a storage medium

- ▶ Insert an SD card into the SD card slot or
- ▶ Insert a USB stick into the socket on the side in the glove compartment.
- ▶ Select **Vehicle** in the main function bar by turning $\left[\odot \right]$ the COMAND controller and press \odot to confirm.
The "Vehicle" menu appears.
- ▶ Select **System** and press \odot to confirm.

- ▶ Select **Upload/download data** and press \odot to confirm.
- ▶ Select **Copy data to storage medium** and press \odot to confirm.
- ▶ Select the storage medium to which the data should be copied.
- ▶ Select **Start copying**.
COMAND checks whether the storage medium has enough storage capacity. If there is enough storage capacity, the data is copied to the storage medium.
- ▶ If there is not enough storage capacity, remove the storage medium. Make more storage space available on the storage medium. Then, try to copy the COMAND data to the storage medium again.
- ▶ Remove the storage medium.

Transferring data to another system (vehicle)

- ▶ Insert/connect the storage medium (SD card or USB stick) with the saved data into/ to the relevant interface.
- ▶ Select **Vehicle** in the main function bar by turning $\left[\odot \right]$ the COMAND controller and press \odot to confirm.
The "Vehicle" menu appears.
- ▶ Select **System** and press \odot to confirm.
- ▶ Select **Upload/download data** and press \odot to confirm.
- ▶ Select **Import data from storage medium** and press \odot to confirm.
- ▶ Select **Start data import**.
A prompt appears, asking whether the COMAND data should be overwritten.
- ▶ Press **Yes** to confirm that the data saved in COMAND should be overwritten.
COMAND imports the data and restarts the system.
- or
- ▶ Press **No** to cancel the import process.

Useful information	290
Exterior lighting	290
Interior lighting	296
Replacing bulbs	297
Windscreen wipers	299

Useful information

i This Owner's Manual describes all models and all standard and optional equipment available to your vehicle at the time of publication of the Owner's Manual. Country-specific deviations are possible. Please note that your vehicle may not be equipped with all features described. This also applies to safety-relevant systems and functions.

i Please read the information on qualified specialist workshops (▷ page 32).

Exterior lighting

Important safety notes

For reasons of safety, Mercedes-Benz recommends that you drive with the lights switched on even during the daytime. In some countries, operation of the headlamps varies due to legal requirements and self-imposed obligations.

Notes on driving abroad

To convert to symmetrical dipped beam when driving abroad: switch the headlamps to symmetrical dipped beam in countries in which traffic drives on the opposite side of the road to the country where the vehicle is registered. This prevents glare to oncoming traffic. When using symmetrical lights, the edge of the carriageway is not lit as widely and as far ahead as normal.

Convert the headlamps as close to the border as possible before driving in these countries (▷ page 406).

Convert to asymmetrical dipped beam after returning: convert the headlamps back to asymmetrical dipped beam as soon as possible after crossing the border when returning (▷ page 406).

If the headlamps are converted to symmetrical dipped beam, the "motorway mode" and "extended range foglamps" functions (Intelligent Light System) are not available.

Light switch

Operation



- 1** Left-hand parking lamps
- 2** Right-hand parking lamps
- 3** **0** Lights off/daytime driving lights
- 4** **A** Automatic headlamp mode/daytime driving lights
- 5** Side lamps, licence plate and instrument cluster lighting
- 6** Dipped-beam/main-beam headlamps
- 7** Foglamps¹⁷
- 8** Rear foglamp

The turn signals, main-beam headlamps and the headlamp flasher are operated using the combination switch (▷ page 292).

! Switch off the side lamps and parking lamp when you leave the vehicle. This prevents the battery from discharging.

The exterior lighting (except the side lamps/parking lamps) switches off automatically if you:

- remove the key from the ignition lock
- open the driver's door with the key in position **0**

¹⁷ Only vehicles with bi-xenon headlamps without Intelligent Light System are equipped with front foglamps.



If you hear a warning tone when you leave the vehicle, the lights may still be switched on.

- ▶ Turn the light switch to  or .

or



- ▶ If the rear foglamp is switched on: press the light switch in to the stop.

Dipped-beam headlamps

- ▶ **To switch on the dipped-beam headlamps:** turn the key in the ignition lock to position **2** or start the engine.
- ▶ Turn the light switch to .
The  indicator lamp on the light switch lights up.
- ▶ **To switch off the dipped-beam headlamps:** turn the light switch to .

Daytime driving lights

You can activate or deactivate the daytime driving lights function using the on-board computer (> page 406).

- ▶ **Daytime driving lights:** activate the daytime driving lights function using the on-board computer.
- ▶ Turn the light switch to  or .
When the engine is on: depending on the ambient light conditions, the daytime driving lights or the dipped-beam headlamps are switched on.

When the dipped-beam headlamps are switched on, the  indicator lamp on the light switch lights up.



Automatic headlamp mode

- ▶ **To switch on automatic headlamp mode:** turn the light switch to .
Key in position **1** in the ignition lock: the side lamps are switched on or off automatically depending on the brightness of the ambient light.
With the engine running: depending on the brightness of the ambient light, the daytime

driving lights¹⁸ or the side lamps and dipped-beam headlamps are switched on or off automatically.



When the dipped-beam headlamps are switched on, the  indicator lamp on the light switch lights up.

WARNING

If the light switch is set to , the dipped-beam headlamps will not come on automatically if it is foggy. This could endanger you and others. Therefore, turn the light switch to  in fog.

The automatic headlamp feature is only an aid. The driver is responsible for the vehicle's lighting at all times.



WARNING

When it is dark or foggy, turn the light switch from  to  in good time. Otherwise, the headlamps could switch off temporarily and you could cause an accident.



Foglamps

WARNING





If you suspect that driving conditions will be foggy, turn the light switch to  before you start your journey. Your vehicle may otherwise not be visible and you could endanger yourself and others.

- ▶ **To switch on the foglamps:** turn the key in the ignition lock to position **2** or start the engine.
- ▶ Turn the light switch to  or . If the light switch is set to , you cannot switch on the foglamps.

¹⁸ Only if daytime driving lights have been activated via the on-board computer.

- ▶ Pull the light switch out to the first detent. The green  indicator lamp on the light switch lights up.
- ▶ **To switch off the front foglamps:** press the light switch in as far as it will go. The green  indicator lamp on the light switch goes out.

Rear foglamp

- ▶ **To switch on the rear foglamp:** turn the key in the ignition lock to position **2** or start the engine.
- ▶ Turn the light switch to  or  (vehicles with foglamps), or turn the light switch to  (vehicles without foglamps). When the light switch is set to **A**, you cannot switch on the rear foglamp.
- ▶ Pull the light switch out to the second stop (vehicles with foglamps) or pull it out to the stop (vehicles without foglamps). The yellow  indicator lamp on the light switch lights up.
- ▶ **To switch off the rear foglamp:** press the light switch in as far as it will go. The yellow  indicator lamp on the light switch goes out.

Headlamp cleaning system

If the "Wipe with washer fluid" function is operated five times (▷ page 299) while the lights are on and the engine is running, the headlamps are cleaned automatically. When you switch off the ignition, the automatic headlamp cleaning system is reset and counting is resumed from 0.

Combination switch



Turn signals



- ① Main-beam headlamps
- ② Turn signal, right
- ③ Headlamp flasher
- ④ Turn signal, left

- ▶ **To indicate briefly:** press the combination switch briefly to the pressure point in the direction of arrow ② or ④. The corresponding turn signal flashes three times.
- ▶ **To indicate:** press the combination switch beyond the pressure point in the direction of arrow ② or ④.

Main-beam headlamps

- ▶ **To switch on the main-beam headlamps:** turn the key in the ignition lock to position **2** or start the engine.
- ▶ Turn the light switch to .
- ▶ Press the combination switch beyond the pressure point in the direction of arrow ①. The  indicator lamp in the instrument cluster lights up.
- ▶ **To switch off the main-beam headlamps:** move the combination switch back to its normal position. The  indicator lamp in the instrument cluster goes out.

Headlamp flasher

- ▶ **To switch on:** turn the key in the ignition lock to position **1** or **2** or start the engine.
- ▶ Pull the combination switch in the direction of arrow ③.

Hazard warning lamps



The hazard warning lamps automatically switch on if:

- an airbag is deployed.
 - the vehicle decelerates rapidly from a speed of more than 70 km/h and comes to a standstill.
- ▶ **To switch on the hazard warning lamps:** press button ①.
- All turn signals flash. If you now switch on a turn signal using the combination switch, only the turn signal lamp on the corresponding side of the vehicle will flash.
- ▶ **To switch off the hazard warning lamps:** press button ①.

The hazard warning lamps switch off automatically if the vehicle reaches a speed of over 10 km/h again after a full brake application.

- ① The hazard warning lamps still operate if the ignition is switched off.

Intelligent Light System

Important notes

The Intelligent Light System is a system that adjusts the headlamps automatically to suit the prevailing driving and weather conditions. It offers advanced functions for improved illumination of the road surface, e.g. depending on the vehicle speed or weather conditions. The system includes the active light function, cornering light function, motorway mode and extended range foglamps. The system is only active when it is dark.

You can activate or deactivate the "Intelligent Light System" using the on-board computer (▷ page 406).

Active light function



The active light function is a system that moves the headlamps according to the steering movements of the front wheels. In this way, relevant areas remain illuminated while driving. This allows you to recognise pedestrians, cyclists and animals.

Active: when the lights are switched on.

Cornering light function



The cornering light function improves the illumination of the road over a wide angle in the direction you are turning, enabling better visibility in tight bends, for example. The cornering light function can only be activated when the dipped-beam headlamps are switched on.

Active:

- if you are driving at speeds below 40 km/h and switch on the turn signal or turn the steering wheel.
- if you are driving at speeds between 40 km/h and 70 km/h and turn the steering wheel.

Not active: if you are driving at speeds above 40 km/h or switch off the turn signal or turn the steering wheel to the straight-ahead position.

The cornering light function may remain lit for a short time, but is automatically switched off after no more than three minutes.

Motorway mode



Motorway mode increases the range of the beam.

Active:

- if you are driving at speeds above 110 km/h and do not make any large steering movements for 1000 m
- if you are driving at speeds above 130 km/h

Not active: if you are driving at speeds below 80 km/h following activation.

Extended range foglamps



The extended range foglamps reduce the glare experienced by the driver and improve the illumination of the edge of the carriageway.

Active: if you are driving at speeds below 70 km/h and you switch on the rear foglamp

Not active: if you are driving at speeds above 100 km/h or if you switch off the rear foglamp following activation

Adaptive Highbeam Assist

You can use this function to set the headlamps to change between dipped beam and main beam automatically. The system recognises vehicles with their lights on, either approaching from the opposite direction or travelling in front of your vehicle, and consequently switches the headlamps from main beam to dipped beam.

The system automatically adapts the dipped-beam headlamp range depending on the dis-

tance to the other vehicle. Once the system no longer detects any other vehicles, it reactivates the main-beam headlamps.

The system's optical sensor is located behind the windscreen near the overhead control panel.



- ▶ **To activate:** activate the Adaptive Highbeam Assist function using the on-board computer (▷ page 407).
- ▶ Turn the light switch to **A**.
- ▶ Press the combination switch beyond the pressure point in the direction of arrow ① (▷ page 292).

If it is dark and the light sensor activates the dipped-beam headlamps, the  indicator lamp in the instrument cluster lights up.



If you are driving at speeds above 45 km/h:

the headlamp range is set automatically depending on the distance between the vehicle and other road users.

If you are driving at speeds above 55 km/h and no other road users are recognised:

the main-beam headlamps are switched on automatically. The  indicator lamp in the instrument cluster also lights up.

If you are driving at speeds below 45 km/h or other road users are recognised or the roads are adequately lit:

the main-beam headlamps are switched off automatically. The  indicator lamp in the instrument cluster goes out. The  indicator lamp in the instrument cluster stays on.

- ▶ **To deactivate:** move the combination switch back to its normal position. The  indicator lamp in the instrument cluster goes out.

WARNING

Adaptive Highbeam Assist is only an aid designed to assist driving. The driver is responsible for adjusting the vehicle's lighting to the prevailing light, vision and traffic conditions.

The system may be impaired or deactivated:

- if there is poor visibility, e.g. due to snow, rain, fog or spray
- if the area of the windscreen around the optical sensor is dirty, misted up or covered up, e.g. by a sticker

The system may not recognise the following road users:

- road users that have no lighting, e.g. pedestrians
- road users that have poor lighting, e.g. cyclists
- road users whose lighting is not clearly visible, e.g. road users behind a crash barrier
- on rare occasions: road users that have lights that may be recognised too late or not at all

The automatic main-beam headlamps will not be deactivated, or they may be activated despite road users travelling in front of or approaching the vehicle.

Thus, you could cause an accident and injure yourself and others. Always observe traffic

conditions and, if necessary, dip the lights manually.

Headlamps misted up on the inside

The headlamps may mist up on the inside if there is high atmospheric humidity.

- ▶ Drive with the headlamps switched on. The level of moisture diminishes, depending on the length of the journey and the weather conditions (humidity and temperature).

If the level of moisture does not diminish:

- ▶ Have the headlamps checked at a qualified specialist workshop.

Interior lighting

Overview of interior lighting

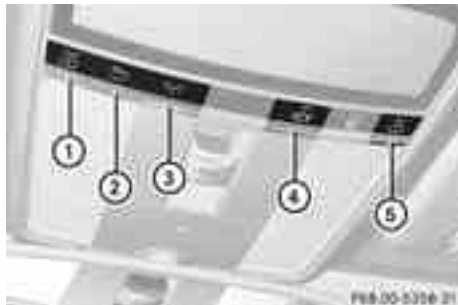

Front overhead control panel

- ① To switch the left-hand reading lamp on/off
- ② To switch the rear interior lighting on/off
- ③ To switch the front interior lighting on/off
- ④ To switch the automatic interior lighting control on/off
- ⑤ To switch the right-hand reading lamp on/off



Rear-compartment overhead control panel

- ① Reading lamp
- ② Press consecutively to:
 - switch the reading lamp and interior lighting on
 - switch only the reading lamp on
 - To switch the reading lamp off
- ③ Interior lighting

Interior lighting control

Important notes

In order to prevent the vehicle's battery from discharging, the interior lighting functions are automatically deactivated after some time except for when the key is in position **2** in the ignition lock.

Automatic interior lighting control



- ▶ **To switch on/off:** press the button. The OFF indicator lamp shows whether the automatic interior lighting control is deactivated (indicator lamp on) or activated (indicator lamp off).

The interior lighting automatically switches on if you:

- unlock the vehicle
- open a door
- remove the key from the ignition lock

The interior light is activated for a short while when the key is removed from the ignition lock. You can activate this delayed switch-off using COMAND (> page 275).

Manual interior lighting control

- ▶ **To switch the front interior lighting on/off:** press the  button.
- ▶ **To switch the rear interior lighting on/off:** press the  button.
- ▶ **To switch the reading lamps on/off:** press the  button.

Replacing bulbs

Important safety notes

Xenon bulbs

DANGER

Xenon bulbs are under high voltage. If you touch the electrical contacts of a xenon bulb, you could suffer an electric shock and be seriously or even fatally injured. For this reason, do not remove the cover of xenon bulbs.

Do not change the xenon bulbs yourself, but have them replaced at a qualified workshop.

If your vehicle is equipped with xenon bulbs, you can recognise this by the following: the cone of light from the xenon bulbs moves from the top to the bottom and back again when you start the engine. For this to be observed, the lights must be switched on before starting the engine.

Bulbs and lamps are an important aspect of vehicle safety. You must therefore make sure that these function correctly at all times. Have the headlamp setting checked regularly.

Other bulbs

There are bulbs other than the xenon bulbs that you cannot replace. Replace only the bulbs listed (▷ page 297). Have the bulbs that you cannot replace yourself changed at a qualified specialist workshop.

If you require assistance changing bulbs, consult a qualified specialist workshop.

Do not touch the glass tube of new bulbs with your bare hands. Even minor contamination

can burn into the glass surface and reduce the service life of the bulbs. Always use a lint-free cloth or only touch the base of the bulb when fitting.

Only use bulbs of the correct type.

If the new bulb still does not light up, consult a qualified specialist workshop.

Bulbs and lamps are an important aspect of vehicle safety. You must therefore make sure that these function correctly at all times.

Have the headlamp setting checked regularly.

WARNING

Bulbs and lamps can be very hot. You should therefore allow them to cool down before you change them. Otherwise, you could be burned if you touch them.

Keep bulbs out of the reach of children. Otherwise, they could damage the bulbs, for example, and injure themselves.

Never use a bulb which has been dropped. Such a bulb may break or even explode and injure you.

Halogen bulbs are pressurised and can explode when you change them, particularly if they are very hot. You should therefore wear eye protection and gloves when you are changing them.

Overview of bulb replacement – bulbs

You can replace the following bulbs. The details for the bulb type can be found in the legend.



Bi-xenon headlamps

- ① Main-beam spot lamp: H7 55 W

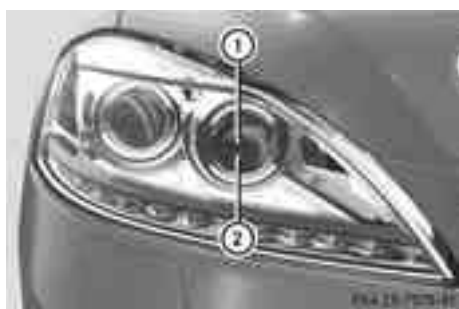

Intelligent Light System headlamps

- ① Main-beam spot lamp¹⁹: H11 55 W
 ② Infrared light¹⁹ (Night View Assist Plus): H11 55 W

Replacing the front bulbs

Main-beam spot lamp (bi-xenon headlamps)

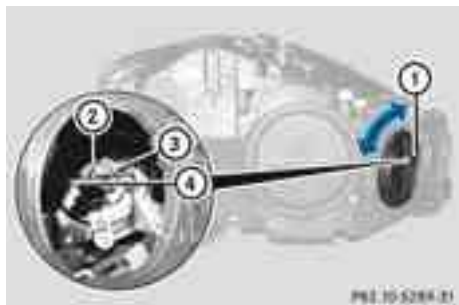

- ▶ Switch off the lights.
 - ▶ Open the bonnet.
 - ▶ Turn housing cover ① anti-clockwise and pull it out.
 - ▶ Turn bulb holder ② anti-clockwise and pull it out.
 - ▶ Take the bulb out of bulb holder ②.
 - ▶ Insert the new bulb into bulb holder ②.
 - ▶ Insert bulb holder ②.
- Left-hand headlamp: cable outlet ③ must be pointing up and to the right.
 Right-hand headlamp: cable outlet ③ must be pointing down and to the left.
- ▶ Turn bulb holder ② clockwise.
 Handle ④ of bulb holder ② is horizontal.
 - ▶ Align housing cover ① and turn it clockwise until it engages.

Main-beam spot lamp (Intelligent Light System)/Infrared light (Night View Assist Plus)



Due to their location, have the bulbs in the left-hand headlamp changed at a qualified specialist workshop.

- ▶ Switch off the lights.
- ▶ Open the bonnet.
- ▶ Turn housing cover ① anti-clockwise and pull it out.
- ▶ Turn bulb holder ② anti-clockwise and pull it out.

¹⁹ Due to their location, have the bulbs in the left-hand headlamp replaced at a qualified specialist workshop, e.g. a Mercedes-Benz Service Centre.

- ▶ Push the two detents on the right and left of bulb holder ② and pull the bulb from bulb holder ②.
- ▶ Insert the new bulb into bulb holder ② until it engages.
- ▶ Insert bulb holder ② into the guide in the headlamp. Cable outlet ③ must be pointing down and to the right.
- ▶ Turn bulb holder ② clockwise. Cable outlet ③ must be pointing down and to the left.
- ▶ Align housing cover ① and turn it clockwise until it engages.

Windscreen wipers

Switching the windscreen wipers on/off





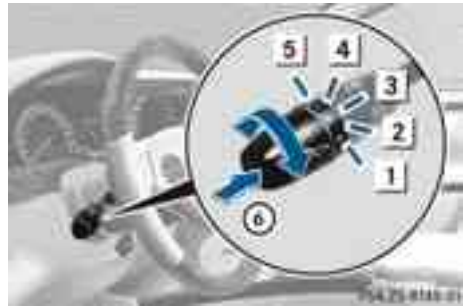

WARNING

The windscreen will not longer be wiped properly if the wiper blades are worn. This could prevent you from observing the traffic conditions, thereby causing an accident. Replace the wiper blades twice a year, ideally in spring and autumn.

- ❗ Do not operate the windscreen wipers when the windscreen is dry, as this could damage the wiper blades. Moreover, dust that has collected on the windscreen can scratch the glass if wiping takes place when the windscreen is dry.
- ❗ If the windscreen wipers leave smears on the windscreen after the vehicle has been washed in an automatic car wash, this may be due to wax or other residue. Clean the windscreen with washer fluid after an automatic car wash.







Combination switch

- 1  Windscreen wipers off
- 2  Intermittent wipe, low²⁰
- 3  Intermittent wipe, high²¹
- 4  Continuous wipe, slow
- 5  Continuous wipe, fast
- 6  Single wipe/  To wipe the windscreen using washer fluid

- ▶ Turn the key to position 1 or 2 in the ignition lock.
- ▶ Turn the combination switch to the corresponding position.

❗ Intermittent wiping with rain sensor: due to optical influences and the windscreen becoming dirty in dry weather conditions, the windscreen wipers may be activated inadvertently. This could damage the windscreen wiper blades or scratch the windscreen.

For this reason, you should always switch off the windscreen wipers in dry weather.

In the  or  position, the appropriate wiping frequency is set automatically according to the intensity of the rain. In the  position, the rain sensor is more sensitive than in the  position, causing the windscreen wiper to wipe more frequently.

²⁰ Rain sensor set to low sensitivity.

²¹ Rain sensor set to high sensitivity.

Replacing the wiper blades

Important safety notes

WARNING

The wiper arms could start moving and cause an injury if you leave the windscreen wipers switched on.

Remove the key from the ignition lock before replacing the wiper blades.

! Never open the bonnet if a windscreen wiper arm has been folded away from the windscreen.

Never fold a windscreen wiper arm without a wiper blade back onto the windscreen.

Hold the windscreen wiper arm firmly when you change the wiper blade. If you release the windscreen wiper arm without a wiper blade and it falls onto the windscreen, the windscreen may be damaged by the force of the impact.

Mercedes-Benz recommends that you have the wiper blades replaced by a qualified specialist workshop, e.g. at a Mercedes-Benz Service Centre.

! To avoid damaging the windscreen wiper blades, make sure that you touch only the wiper arm of the windscreen wiper.

Replacing the windscreen wiper blades

Moving the wiper blades to a vertical position

Vehicles without KEYLESS-GO

- ▶ Turn the key to position **1** or **2** in the ignition lock.
- ▶ Set the windscreen wipers to position .
- ▶ When the wiper arms have reached a vertical position, turn the key to position **0** and remove it from the ignition lock.

Vehicles with KEYLESS-GO

- ▶ Switch off the engine.
- ▶ Remove your foot from the brake pedal.
- ▶ Set the windscreen wipers to position .
- ▶ Press the Start/Stop button repeatedly until the windscreen wipers start.
- ▶ When the wiper arms have reached a vertical position, press the Start/Stop button.

Removing the wiper blades

- ▶ Fold the wiper arm away from the windscreen until it engages.
- ▶ Set the wiper blade at right angles to the wiper arm.



- ▶ Remove the wiper blade from the retaining pin on the wiper arm in the direction of the arrow.

Fitting the wiper blades

- ▶ Push the new wiper blade onto the retaining pin on the wiper arm in the opposite direction to the arrow.
Make sure that the wiper blade slides fully onto the retaining pin on the wiper arm.
- ▶ Turn the wiper blade parallel to the wiper arm.
- ▶ Fold the wiper arm back onto the windscreen.

Problems with the windscreen wipers

The windscreen wipers are obstructed

Leaves or snow, for example, may be obstructing the windscreen wiper movement. The wiper motor has been deactivated.

- ▶ For safety reasons, you should remove the key from the ignition lock.

or

- ▶ Switch off the engine using the Start/Stop button and open the driver's door.
- ▶ Remove the cause of the obstruction.
- ▶ Switch the windscreen wipers back on.

The windscreen wipers are inoperative

The windscreen wiper drive is malfunctioning.

- ▶ Select another wiper speed on the combination switch.
- ▶ Have the windscreen wipers checked at a qualified specialist workshop.

The spray nozzles are misaligned

The windscreen washer fluid from the spray nozzles no longer hits the centre of the windscreen. The spray nozzles are misaligned.

- ▶ Have the spray nozzles adjusted at a qualified specialist workshop.

Useful information	304
Overview of climate control systems	304
Operating the climate control system	306
Adjusting the air vents	317

Useful information

- i** This Owner's Manual describes all models and all standard and optional equipment available to your vehicle at the time of publication of the Owner's Manual. Country-specific deviations are possible. Please note that your vehicle may not be equipped with all features described. This also applies to safety-relevant systems and functions.
- i** Please read the information on qualified specialist workshops (▷ page 32).

pollen. A clogged filter reduces the amount of air supplied to the vehicle interior. For this reason, you should always observe the interval for replacing the filter, which is specified in the Service Booklet. As it depends on environmental conditions, e.g. heavy air pollution, the interval may be shorter than stated in the Service Booklet.

- i** It is possible that the blower may be activated automatically 40 minutes after the key is removed. The vehicle is then ventilated for 30 minutes to dry the air-conditioning system.

Overview of climate control systems

Important safety notes

 WARNING

Observe the settings recommended on the following pages. The windows could otherwise mist up. This may prevent you from observing the traffic conditions, thereby causing an accident.

The automatic climate control regulates the temperature and the humidity in the vehicle interior and filters undesirable substances from the air.

The automatic climate control is only operational when the engine is running²². Optimum operation is only achieved if you drive with the side windows and sliding sunroof/panorama sliding sunroof closed.

You can also set some automatic climate control functions via COMAND (▷ page 278).

- i** Ventilate the vehicle for a brief period during warm weather, e.g. using the convenience opening feature (▷ page 92). This will speed up the cooling process and the desired vehicle interior temperature will be reached more quickly.
- i** The integrated filter can filter out most particles of dust and completely filters out

²² The residual heat function can only be activated/deactivated if the ignition is switched off.

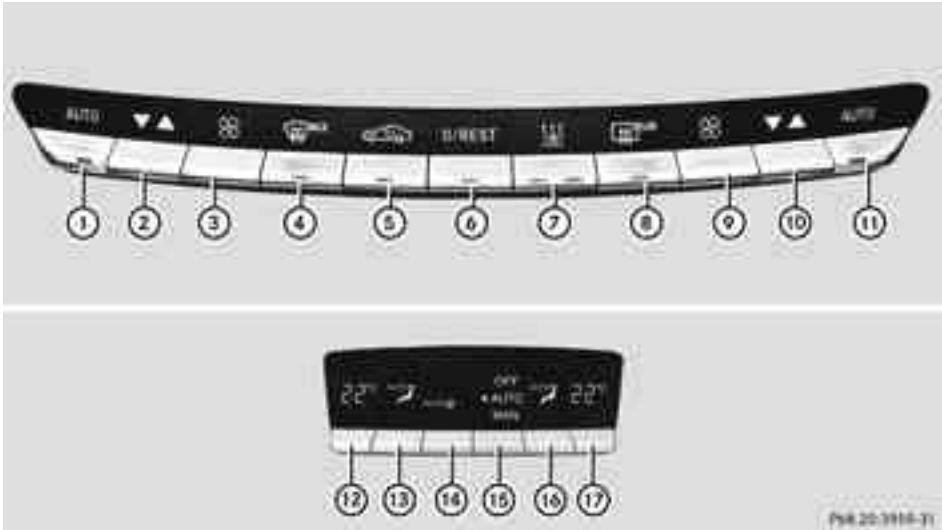
Automatic climate control panel**Front control panel**

- ① Sets climate control to automatic mode, left (▷ page 307)
- ② Sets the temperature, left (▷ page 308)
- ③ Sets the airflow, left (▷ page 309)
- ④ Demists the windscreen (▷ page 310)
- ⑤ Activates/deactivates air-recirculation mode (▷ page 311)
- ⑥ Switches the climate control on/off²³(▷ page 306)
Activates/deactivates the residual heat function²³(▷ page 312)
- ⑦ Switches the auxiliary heating on/off (▷ page 312)
- ⑧ Switches the rear window heating on/off (▷ page 310)
- ⑨ Sets the airflow, right (▷ page 309)
- ⑩ Sets the temperature, right (▷ page 308)
- ⑪ Sets climate control to automatic mode, right (▷ page 307)

Rear control panel

- ⑫ Sets the temperature, left (▷ page 308)
- ⑬ Sets the air distribution, left (▷ page 309)
- ⑭ Sets the airflow (▷ page 309)
- ⑮ **OFF** Switches rear-compartment climate control off (▷ page 306)
AUTO Sets rear-compartment climate control to automatic mode (▷ page 307)
MAN Sets rear-compartment climate control to manual mode (▷ page 307)

²³ On vehicles without auxiliary heating, these functions have separate rocker switches.

- ⑩ Sets the air distribution, right (▷ page 309)
- ⑰ Sets the temperature, right (▷ page 308)

Notes on using climate control

Below, you can find a number of notes and recommendations to help you use climate control optimally.

- Activate climate control using the **AUTO** rocker switch. The indicator lamp in the **AUTO** rocker switch lights up.
- Set the temperature to 22 °C.
- Only use the demisting function briefly, until the windscreen is clear again.
- Only use the air-recirculation mode briefly, e.g. if there are unpleasant outside odours or when in a tunnel. The windows could otherwise mist up as no fresh air is drawn into the vehicle in air-recirculation mode.
- Use the residual heat function if you want to heat or ventilate the vehicle interior when the ignition is switched off. The residual heat function can only be activated or deactivated with the ignition switched off.

Operating the climate control system

Switching climate control on/off

Important information

- i** When climate control is switched off, the air supply and air circulation are also switched off. Only select this setting briefly. Otherwise, the windows may mist up.
- i** Switch on climate control primarily using the **AUTO** rocker switch (▷ page 307).



Switching the front climate control on/off using the front control panel

- ▶ Turn the key to position **2** in the ignition lock.
- ▶ **To switch on:** press the **0/REST** rocker switch up or down.
The indicator lamp in the rocker switch goes out. The previously selected settings come into effect again.
- ▶ **To switch off:** press the **0/REST** rocker switch up or down.
The indicator lamp in the rocker switch lights up.

Switching the rear-compartment climate control on/off using the front control panel

- ▶ Turn the key to position **2** in the ignition lock.
- ▶ Activate the **تدفق** rear compartment function via COMAND (▷ page 281).
The rear-compartment climate control can be controlled via the front control panel using the **تدفق** rear compartment function.
- ▶ **To switch on:** press the **0/REST** rocker switch up or down.
The indicator lamp in the rocker switch goes out. The previously selected settings come into effect again.
- ▶ **To switch off:** press the **0/REST** rocker switch up or down.
The indicator lamp in the rocker switch lights up.

Switching the rear-compartment climate control on/off using the rear control panel

- ▶ Turn the key to position **2** in the ignition lock.
 - ▶ **To switch on:** press rocker switch  (▷ page 305) up or down and select **AUTO**.
- or
- ▶ Press rocker switch  (▷ page 305) up or down and select **MAN**.
 - ▶ **To switch off:** press rocker switch  (▷ page 305) up or down and select **OFF**.

Activating/deactivating the cooling with air dehumidification function

Important information

The cooling with air dehumidification function is only available when the engine is running. The air inside the vehicle is cooled and dehumidified according to the temperature selected.

WARNING

If the "cooling with air dehumidification" function is deactivated, the air inside the vehicle will not be cooled (during warm weather) or dehumidified. The windows could mist up more quickly. This may prevent you from observing the traffic conditions, thereby causing an accident.

Condensation may drip from the underside of the vehicle when THERMOTRONIC is in cooling mode. This is normal and not a sign that there is a malfunction.

You can activate or deactivate the cooling with air dehumidification function via COMAND (▷ page 280).

- i** The cooling with air dehumidification function uses refrigerant R134a. This coolant does not contain chlorofluorocarbons,

and therefore does not damage the ozone layer.

Problems with the cooling with air dehumidification function

If you can no longer switch on the cooling with air dehumidification function via COMAND, the cooling with air dehumidification function is switched off due to a malfunction.

- ▶ Consult a qualified specialist workshop.

Setting climate control to automatic mode

In automatic mode, the set temperature is maintained automatically at a constant level. The system automatically regulates the temperature of the dispensed air, the airflow and the air distribution.

Automatic mode will achieve optimal operation if cooling with air dehumidification is also activated. If desired, cooling with air dehumidification can be deactivated.







Controlling the front climate control using the front control panel

- ▶ Turn the key to position **2** in the ignition lock.
- ▶ Set the desired temperature.
- ▶ **To switch on:** press the **AUTO** rocker switch up or down.
The indicator lamp in the **AUTO** rocker switch lights up.
- ▶ **To deactivate:** press the  rocker switch up or down.
The indicator lamp in the **AUTO** rocker switch goes out.

or

- ▶ Set the air distribution using COMAND (▷ page 279).
The indicator lamp in the **AUTO** rocker switch goes out.



Controlling the rear-compartment climate control automatically using the front control panel

- ▶ Turn the key to position **2** in the ignition lock.
- ▶ Activate the  rear compartment function via COMAND (▷ page 281). Rear-compartment climate control can be controlled via the front control panel using the  rear compartment function.
- ▶ Set the desired temperature.
- ▶ **To switch on:** press rocker switch  up or down.
The indicator lamp in the  rocker switch lights up.
- ▶ **To deactivate:** press the  rocker switch up or down.
The indicator lamp in the  rocker switch goes out.

or

- ▶ Set the air distribution using COMAND (▷ page 279).
The indicator lamp in the  rocker switch goes out.
- i** To return to the standard display, activate the front climate control function via COMAND (▷ page 281).
- i** The rear display changes to the standard display automatically after five seconds.

Controlling the rear-compartment climate control automatically using the rear control panel

- ▶ Turn the key to position **2** in the ignition lock.
- ▶ Set the desired temperature.
- ▶ **To activate:** press rocker switch  up or down and select **AUTO** (▷ page 305).
- ▶ **To deactivate:** press rocker switch  up or down and select **MAN** or **OFF** (▷ page 305).

Setting the temperature





Automatic climate control zones

You can select different temperature settings for the driver's and front-passenger sides as well as for the left and right sides of the rear compartment and the footwells.

Setting the temperature in the front compartment using the front control panel

- ▶ Turn the key to position **2** in the ignition lock.
- ▶ **To increase/reduce:** press the  rocker switch up or down.
Only change the temperature setting in small increments. Start at 22 °C.
- i** You can also use COMAND to set the temperature (▷ page 278).

Setting the temperature in the rear compartment using the front control panel

- ▶ Turn the key to position **2** in the ignition lock.
- ▶ Activate the "rear " function via COMAND (▷ page 281).
Using the "rear " function, the rear-compartment climate control can be controlled via the front control panel.
- ▶ **To increase/reduce:** press the  rocker switch up or down.
Only change the temperature setting in small increments. Start at 22 °C.

- i** To return to the standard display, activate the front climate control function via COMAND (▷ page 281).
- i** The rear display changes to the standard display automatically after five seconds.

Setting the temperature in the rear compartment using the rear control panel

- ▶ Turn the key to position **2** in the ignition lock.
- ▶ **To increase/reduce:** press rocker switch **(12)** or **(17)** up or down (▷ page 305).
Only change the temperature setting in small increments. Start at 22 °C.







Setting the footwell temperature

The footwell temperature can be set via COMAND (▷ page 280).

Setting the air distribution

Air distribution settings

The air distribution can be set individually for the driver's and front-passenger sides.

-  Directs the airflow through the demister vents
-  Directs the airflow through the centre and side air vents
-  Directs the airflow through the footwell air vents
-  Directs the airflow through the centre and side air vents as well as the footwell air vents
-  Directs the airflow through the footwell and demister vents
-  Directs the airflow through the demister vents, the centre and side air vents as well as the footwell air vents

 Directs the airflow through the centre and side air vents as well as the demister vents

 Sets the air distribution to automatic.

Setting the air distribution in the front/rear compartment using COMAND

The air distribution can be set using COMAND (▷ page 279).

Setting the air distribution in the rear compartment using the rear control panel

- ▶ Turn the key to position **2** in the ignition lock.
- ▶ Press rocker switch **(13)** or **(16)** up or down repeatedly (▷ page 305) until the desired air distribution symbol is shown in the display.

Setting the airflow



Setting the front-compartment airflow using the front control panel

You can select different airflow settings for the driver's and front-passenger sides as well as for the rear compartment.

You can also use COMAND to set the airflow (▷ page 279).

- ▶ Turn the key to position **2** in the ignition lock.
- ▶ **To increase/reduce:** press rocker switch  up or down.

Setting the rear-compartment airflow using the front control panel

- ▶ Turn the key to position **2** in the ignition lock.
- ▶ Activate the  rear compartment function via COMAND (▶ page 281).
The rear-compartment climate control can be controlled via the front control panel using the .
- ▶ **To increase/reduce:** press rocker switch  up or down.

Setting the rear-compartment airflow using the rear control panel

- ▶ Turn the key to position **2** in the ignition lock.
- ▶ **To increase/reduce:** press rocker switch  up or down (▶ page 305).

Demisting the windscreen



You can use this function to defrost the windscreen or to demist the inside of the windscreen and the side windows.

- i** You should only select the demisting function until the windscreen is clear again.
- ▶ Turn the key to position **2** in the ignition lock.
- ▶ **To switch on:** press the  rocker switch up or down.



The indicator lamp in the  rocker switch lights up.

The climate control system switches to the following functions:

- cooling with air dehumidification on
- high airflow²⁴
- high temperature²⁴
- air distribution to the windscreen and front side windows
- air-recirculation mode off

- ▶ **To deactivate:** press the  rocker switch up or down.
The indicator lamp in the  rocker switch goes out. The previously selected settings come into effect again. The cooling with air dehumidification function remains on. Air-recirculation mode remains deactivated.

or

- ▶ Press the  rocker switch up or down.
- or
- ▶ Press the  rocker switch up or down.

Demisting the windows

Windows misted up on the inside

- ▶ Activate the "cooling with air dehumidification" function via COMAND (▶ page 280).
- ▶ Activate automatic mode .
- ▶ If the windows continue to mist up, activate the demisting function (▶ page 310).

- i** You should only select this setting until the windscreen is clear again.

Windows misted up on the outside

- ▶ Activate the windscreen wipers.
- ▶ Activate automatic climate control.
- i** You should only select this setting until the windscreen is clear again.

Rear window heating

Switching on/off

WARNING



Clear all windows of ice or snow before setting off. Otherwise, impaired visibility could endanger you and others.

The rear window heating has a high current draw. You should therefore switch it off as soon as the window is clear. It otherwise

²⁴ Depending on the outside temperature.

switches off automatically after several minutes.

If the battery voltage is too low, the rear window heating may switch off.

- ▶ Turn the key to position **2** in the ignition lock.
- ▶ Press the  rocker switch up or down. The indicator lamp in the  rocker switch lights up or goes out.

Problems with the rear window heating

The rear window heating has switched off prematurely or cannot be activated.





- ▶ Switch off any consumers that are not required, e.g. reading lamps or interior lighting.
When the battery is sufficiently charged, the rear window heating is activated again automatically.

Activating/deactivating air-recirculation mode

You can deactivate the flow of fresh air if unpleasant odours are entering the vehicle from outside. The air already inside the vehicle will then be recirculated.



WARNING

Only switch over to air-recirculation mode briefly at low outside temperatures. Otherwise, the windows could mist up, thus impairing visibility and endangering yourself and others. This may prevent you from observing the traffic conditions, thereby causing an accident.

- ▶ Turn the key to position **2** in the ignition lock.
 - ▶ **To activate:** press the  rocker switch up or down. The indicator lamp in the  rocker switch lights up.
 - ▶ **To deactivate:** press the  rocker switch up or down. The indicator lamp in the  rocker switch goes out.
- i** Air-recirculation mode is activated automatically at high outside temperatures. The

indicator lamp in the  rocker switch is not lit when automatic air-recirculation mode is activated.

Outside air is added after about 30 minutes.

- ▶ **To deactivate:** press the  rocker switch up or down. The indicator lamp in the  rocker switch goes out.
- i** Air-recirculation mode deactivates automatically:
- after approximately five minutes at outside temperatures below approx. 5 °C
 - after approximately five minutes if cooling with air dehumidification is deactivated
 - after approximately 30 minutes at outside temperatures above around 5 °C

Convenience opening/closing using the air-recirculation button

WARNING

Make sure that nobody can become trapped between the side window and the door frame as the side windows are opened and closed. Make sure that all objects and body parts are clear of the side windows when they are being opened or closed. You or the objects could be drawn in or become trapped between the side window and the door frame as the window moves. If there is a risk of entrapment, operate the  switch to move the side window in the opposite direction.

Make sure that nobody can become trapped as the sliding sunroof/panorama sliding sunroof is opened and closed. If there is a risk of entrapment, operate the  switch to move the sliding sunroof/panorama sliding sunroof in the opposite direction.

- ▶ **Convenience closing feature (vehicles with a panorama sliding sunroof):** press and hold the  rocker switch up or

down until the side windows and the panorama sliding sunroof are closed.

The indicator lamp in the  rocker switch lights up. Air-recirculation mode is activated.

- ▶ **Convenience closing feature (vehicles with/without a sliding sunroof):** press and hold the  rocker switch up or down until the side windows and the sliding sunroof close automatically.

The indicator lamp in the  rocker switch lights up. Air-recirculation mode is activated.

- ▶ **Convenience opening feature (vehicles with a panorama sliding sunroof):** press and hold the  rocker switch up or down until the side windows and the panorama sliding sunroof have reached their original position.

The indicator lamp in the  rocker switch goes out. Air-recirculation mode is deactivated.

- ▶ **Convenience opening feature (vehicles with/without a sliding sunroof):** press and hold the  rocker switch up or down until the side windows and the sliding sunroof open automatically.

The indicator lamp in the  rocker switch goes out. Air-recirculation mode is deactivated.

- ▶ **i** If you open the side windows or the sliding sunroof/panorama sliding sunroof manually after closing them with the convenience closing feature, they will remain in this position when opened using the convenience opening feature.

Activating/deactivating the residual heat function

It is possible to make use of the residual heat of the engine to continue heating the stationary vehicle for up to 30 minutes after the engine has been switched off. The heating

time depends on the temperature that has been set.

- ▶ **i** The blower will run at a low speed regardless of the airflow setting.

- ▶ **i** If you activate the residual heat function at high temperatures, only the ventilation will be activated. The blower runs at medium speed.

- ▶ Turn the key to position **0** in the ignition lock or remove it.

- ▶ **To activate:** press the  rocker switch up or down.

The indicator lamp in the  rocker switch lights up.

- ▶ **To deactivate:** press the  rocker switch up or down.

The indicator lamp in the  rocker switch goes out.

- ▶ **i** Residual heat is deactivated automatically:

- after about 30 minutes
 - when the ignition is switched on
 - if the battery voltage drops
 - if the coolant temperature is too low

Auxiliary heating

Important safety notes

WARNING

Exhaust fumes are produced when the auxiliary heating is in operation. Inhaling these exhaust fumes can be poisonous. You should therefore switch off the auxiliary heating in confined spaces without an extraction system, e.g. a garage.

WARNING

When operating the auxiliary heating parts of the vehicle can get very hot. Make sure that the exhaust system does not under any circumstances come into contact with easily ignitable material such as dry grass or fuels.

The material could otherwise ignite and set the vehicle alight. Choose your parking spot accordingly.

Operating the auxiliary heating is thus prohibited at filling stations or when your vehicle is being refuelled. You must therefore switch off the auxiliary heating at filling stations.

! Operating the auxiliary heating/ventilation draws on the vehicle battery. After you have heated or ventilated the vehicle a maximum of two times, drive for a longer distance.

i Switch on the auxiliary heating regularly, e.g. for about ten minutes every month.

The auxiliary heating heats the air in the vehicle interior to the set temperature without using the heat of the running engine. The auxiliary heating is operated directly using the vehicle's fuel. For this reason, the tank content must be at least at reserve fuel level to ensure that the auxiliary heating functions.

The auxiliary heating/ventilation automatically adjusts to changes in temperature and weather conditions. For this reason, the auxiliary heating could switch from ventilation mode to heating mode or from heating mode to ventilation mode.

You cannot use the auxiliary ventilation to cool the vehicle interior to a temperature lower than the outside temperature.

Before switching on

- ▶ Turn the key to position **2** in the ignition lock.
- ▶ Set the temperature.

The auxiliary heating/ventilation can be activated even when the climate control is being controlled manually. Optimum comfort can be attained when the system is set to automatic mode. Set the temperature to 22 °C.

The auxiliary heating/ventilation can be activated or deactivated using the remote control or the rocker switch on the centre console.

You can use COMAND (▷ page 282) or the remote control to specify up to three departure times, one of which may be preselected.

Switching the auxiliary heating/ventilation on/off using the centre console rocker switch

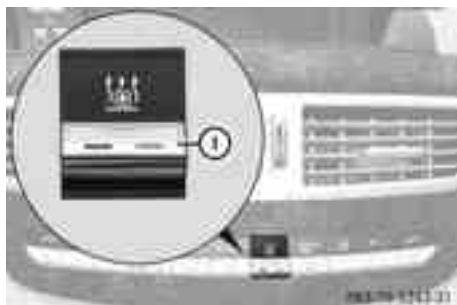

Rocker switch on the centre console

The colours of the indicator lamps on the  rocker switch have the following meanings:

- | | |
|--------|---|
| Blue | Auxiliary ventilation switched on |
| Red | Auxiliary heating switched on |
| Yellow | Departure time preselected (▷ page 282) |

Switching on auxiliary heating/ventilation

- ▶ Press rocker switch **1** up or down.
The red or the blue indicator lamp in rocker switch **1** lights up.

Switching off auxiliary heating/ventilation

- ▶ Press rocker switch **1** up or down.
The red or the blue indicator lamp in rocker switch **1** goes out.

Switching the auxiliary heating/ventilation on/off using the remote control

Your vehicle comes with one remote control. You may use two additional remote controls for your vehicle. For more information, please contact a qualified specialist workshop.

The remote control has a maximum range of approximately 300 metres. This range is reduced by:

- sources of radio interference
- solid objects between the remote control and the vehicle
- the remote control being in an unfavourable position in relation to the vehicle
- transmitting from an enclosed space

i The optimum range can be achieved if you hold the remote control vertically, pointing upwards when you press one of the buttons.

i A battery symbol appears in the display when the battery in the remote control is low. Replace the remote control battery (> page 315).



Auxiliary heating remote control

- ① Display
- ② To check the status/set the departure time
- ③ To switch off the auxiliary heating/ventilation
- ④ To switch on the auxiliary heating/ventilation
- ⑤ To check the status/set the departure time

Switching on auxiliary heating/ventilation

- Press the button.
ON is shown in the remote control display.

Switching off auxiliary heating/ventilation

- Press the button.
OFF is shown in the remote control display.







Checking the status of the auxiliary heating/ventilation



- Press the or button.



The following messages can appear in the display:

Display	Meaning
	The auxiliary heating/ventilation is switched off.
	The auxiliary ventilation is switched on. The number in the display shows the remaining time (in minutes) for the auxiliary ventilation.
	The auxiliary heating is switched on. The number in the display shows the remaining time (in minutes) for the auxiliary heating.
	A departure time has been activated. The departure time appears in the display.
	A departure time has been activated. The auxiliary ventilation is currently selected. The departure time appears in the display.
	A departure time has been activated. The auxiliary heating is currently selected. The departure time appears in the display.





Setting the departure time

- ▶ Press the  or  button repeatedly until the time to be changed appears in the display.
- ▶ Press the  and  buttons simultaneously. The  symbol in the remote control display flashes.
- ▶ Press the  or  button to set the desired departure time.





i The longer you press the  or  button, the faster the time changes.

- ▶ Press the  and  buttons simultaneously. The new departure time is stored.

Activating the set departure time

- ▶ Press the  or  button repeatedly until the desired departure time appears in the display.
- ▶ Press the  button. The  symbol and the departure time appear in the display.

Deactivating a set departure time

- ▶ Press the  or  button. The status of the auxiliary heating is shown in the display.
- ▶ Press the  button. The first departure time stored appears in the display.
- ▶ Press the  button. The display message **OFF** appears in the display.



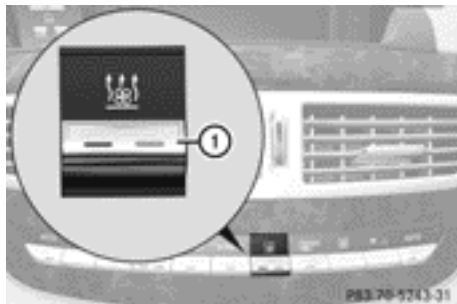

Switching the heater booster function on/off

The heater booster function helps the engine reach its operating temperature faster during its warm-up phase, as well as helping to heat the vehicle interior faster. The heater booster function switches on if the outside temperature is low and the coolant temperature is less

than 70 °C. You can also activate the heater booster manually.





Button on the centre console

- i** The fuel tank must be filled to at least reserve fuel level.
- ▶ Start the engine.
- ▶ **To switch on:** briefly press rocker switch  up or down. Red indicator lamp in rocker switch  lights up.
- ▶ **To switch off:** briefly press rocker switch  up or down. Red indicator lamp in rocker switch  goes out.

Replacing the remote control battery



One 6 V pin battery, type 2CR11108 is required.



- ▶ Prise apart the side arms of battery cover  and pull off battery cover .
- ▶ Remove old battery .

- ▶ Insert the new battery. Observe the polarity signs on the back of the remote control when doing so.
- ▶ Slide battery cover ② back onto the remote control.
- ▶ Use the remote control to check the vehicle's auxiliary heating functions.

Problems with the auxiliary heating/ventilation

Display messages	Possible causes/consequences and ► Solutions
FAIL	<p>The starter battery is not charged sufficiently or the system is faulty.</p> <ul style="list-style-type: none"> ► Charge the starter battery. ► Make another attempt to switch on the auxiliary heating using the remote control. ► Have the auxiliary heating checked at a qualified specialist workshop.
 FAIL	<p>The signal transmission between the transmitter and the vehicle is faulty.</p> <ul style="list-style-type: none"> ► Change your position in relation to the vehicle, moving closer if necessary. ► Make another attempt to switch the auxiliary heating on or off using the remote control.
 FAIL	<p>There is not enough fuel in the fuel tank, or the auxiliary heating is faulty.</p> <ul style="list-style-type: none"> ► Refuel at the nearest filling station. ► Make another attempt to switch on the auxiliary heating using the remote control. ► Have the auxiliary heating checked at a qualified specialist workshop.

Adjusting the air vents

Important safety notes

 **WARNING**

Very hot or very cold air can flow from the air vents. This could cause burns or frostbite to bare skin in the immediate vicinity of the vents. Keep bare skin away from these air outlets. If necessary, direct the airflow away to a different area of the vehicle interior.

In order to ensure the direct flow of fresh air through the air vents into the vehicle interior, please observe the following notes:

- keep the air inlet on the bonnet free of blockages such as ice, snow or leaves.
- never cover the vents or air inlets in the vehicle interior.

-  For virtually draught-free ventilation, adjust the sliders of the air vents to the centre position.

Setting the centre air vents

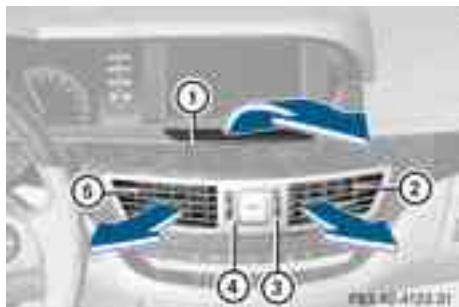

- ① Fixed centre air vent
- ② Centre air vent, right
- ③ Centre vent thumbwheel, right
- ④ Centre vent thumbwheel, left
- ⑤ Centre air vent, left

► **To open/close:** turn thumbwheels ③ and ④ up or down.

Setting the side air vents



► **To open/close:** turn thumbwheel ③ up or down.

i Side window demister vent ① is never completely shut, even if side air vent ② is shut.

Setting the glove compartment air vent

When automatic climate control is activated, the glove compartment can be ventilated, for

instance to cool its contents. The level of airflow depends on the airflow and air distribution settings.

! Close the air vent when heating the vehicle.

At high outside temperatures, open the air vent and activate the "cooling with air dehumidification" function. Otherwise, temperature-sensitive items stored in the glove compartment could be damaged.



► **To open:** turn thumbwheel ① anti-clockwise from position ③ to position ②.

► **To close:** turn thumbwheel ① clockwise from position ② to position ③.

Setting the rear-compartment air vents

Setting the centre vents in the rear compartment

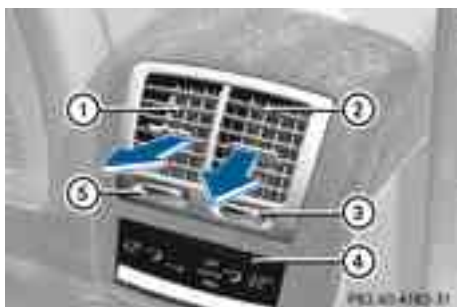

- ① Rear-compartment air vent, left
- ② Rear-compartment air vent, right

- ③ Rear-compartment air vent thumbwheel, right
- ④ Rear control panel for automatic climate control
- ⑤ Rear-compartment air vent thumbwheel, left

► **To open/close:** turn thumbwheel ③ or ⑤ to the right or left.

i In vehicles without rear-compartment air-conditioning system: close the rear-compartment air vents when heating mode is activated as no warm air flows through the rear vents in the basic heating setting.

Setting the rear-compartment side air vents

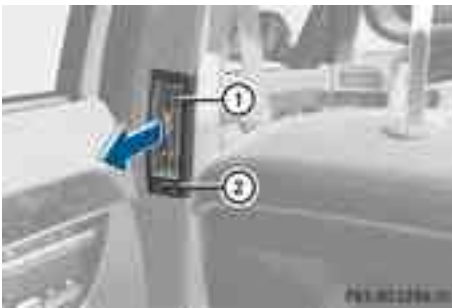

- ① Rear-compartment side air vent
- ② Thumbwheel for rear-compartment side air vent

► **To open/close:** turn thumbwheel ② to the left or right.

Useful information	322
Running-in notes	322
Driving	322
Automatic transmission	329
Refuelling	336
Parking	339
Driving tips	341
Driving systems	344
Towing a trailer	385

Useful information

- i** This Owner's Manual describes all models and all standard and optional equipment available to your vehicle at the time of publication of the Owner's Manual. Country-specific deviations are possible. Please note that your vehicle may not be equipped with all features described. This also applies to safety-relevant systems and functions.
- i** Please read the information on qualified specialist workshops (▷ page 32).

Running-in notes

Important safety notes

WARNING

New brake pads/linings only have optimal braking performance after several hundred kilometres. Until then, compensate for this by applying greater force to the brake pedal. This also applies when brake pads/linings or brake discs have been changed.

The first 1,500 km

If you treat the engine with sufficient care from the very start, you will be rewarded with excellent performance for the remainder of the engine's life.

- Drive at varying vehicle speeds and engine speeds for the first 1,500 km.
- Avoid overstraining the vehicle during this period, e.g. driving at full throttle.
- Change gear in good time, before the rev counter needle is $\frac{2}{3}$ of the way to the red area of the rev counter.
- Do not shift down a gear manually in order to brake.

- Try to avoid depressing the accelerator pedal beyond the point of resistance (kick-down).
- The shift ranges **3**, **2** or **1** should only be engaged when driving slowly, e.g. when driving in mountainous terrain.

After 1,500 km, you may gradually bring the vehicle up to full road and engine speeds.

Additional running-in notes for AMG vehicles:

- do not drive at speeds above 140 km/h for the first 1,500 km.
 - only allow the engine to reach a maximum engine speed of 4,500 rpm briefly.
- i** You should also observe these notes on running in if the engine or parts of the drivetrain on your vehicle have been replaced.

Driving

Important safety notes

WARNING

Do not place any objects in the driver's footwell. If you use a floor mat or carpet in the driver's footwell, make sure that it is correctly secured and that there is sufficient clearance for the pedals.

Do not place several floor mats on top of one another.

Loose objects or the floor mats could otherwise get caught between the pedals if you accelerate or brake suddenly. You will then not be able to brake, declutch or accelerate as intended. This could lead to accidents and injury.

WARNING

Do not change down for additional engine braking on a slippery road surface. This could cause the drive wheels to lose their grip and the vehicle could skid. This could cause you to lose control of your vehicle and cause an accident.

! Warm up the engine quickly. Do not use the engine's full performance until it has reached operating temperature.

Only set the automatic transmission to the respective drive positions when the vehicle is stationary.

Where possible, avoid spinning the drive wheels when pulling away on slippery roads. Otherwise, you could damage the drive train.

! S 63 AMG: at low engine oil temperatures (below +20 °C), the maximum engine speed is restricted to protect the engine. To protect the engine and maintain smooth engine operation, avoid driving at full throttle when the engine is cold.

Key positions

Key



- 0** To remove the key
 - 1** Power supply for some consumers, such as the windscreen wipers
 - 2** Ignition (power supply for all consumers) and drive position
 - 3** To start the engine
- i** If the key does not belong to the vehicle it can still be turned in the ignition lock. However, the ignition will not be switched on. The engine cannot be started.

KEYLESS-GO

General notes

Vehicles with KEYLESS-GO are equipped with a key featuring an integrated KEYLESS-GO function and a detachable Start/Stop button.

The Start/Stop button must be inserted into the ignition lock and the key must be in the vehicle.

Pressing the Start/Stop button several times in succession corresponds to the different key positions in the ignition lock. This is only the case if you are not depressing the brake pedal.

If you depress the brake pedal and press the Start/Stop button, the engine starts immediately.



- Position **0**: if Start/Stop button **1** has not yet been pressed, this corresponds to the key being removed from the ignition.
- Position **1**: press Start/Stop button **1**. You can now activate the windscreen wipers, for example.
- i** If you then open the driver's door when in this position, the power supply is deactivated.
- Position **2** (ignition): press Start/Stop button **1** twice.
- i** If you press Start/Stop button **1** once when in this position and the driver's door is open, the power supply is deactivated again.

Removing the Start/Stop button

You can remove the Start/Stop button from the ignition lock and start the vehicle as normal using the key.

- i** You do not have to remove the Start/Stop button from the ignition lock when you leave the vehicle.

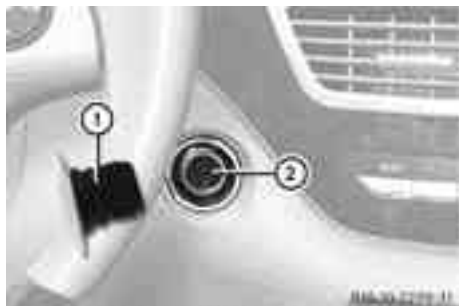

- ▶ Remove Start/Stop button ① from ignition lock ②.

- i** When you insert Start/Stop button ① into ignition lock ②, the system needs approximately two seconds recognition time before you can use Start/Stop button ①.

Starting the engine

Important safety notes

WARNING

Never leave the engine running in enclosed spaces. The exhaust gases contain carbon monoxide. Inhaling exhaust fumes constitutes a health hazard and could lead to loss of consciousness or even death.

- !** Do not depress the accelerator pedal when starting the engine.

General notes

- i** **Vehicles with a petrol engine:** the engine runs at a higher engine speed during a cold start so that the catalytic converter can reach operating temperature more

quickly. The sound of the engine may change as a result.

Automatic transmission

- ▶ Shift the transmission to position **P**. The transmission position display in the multifunction display shows **P**.

- i** You can also start the engine when the transmission is in position **N**.

Starting procedure with the key

- i** To start the engine using the key instead of KEYLESS-GO, pull the Start/Stop button out of the ignition lock.

- ▶ **To start a petrol engine:** turn the key to position **3** in the ignition lock (▷ page 323) and release it as soon as the engine is running.

- ▶ **To start a diesel engine:** turn the key to position **2** in the ignition lock (▷ page 323).

The  preglow indicator lamp in the instrument cluster lights up.

- ▶ When the  preglow indicator lamp goes out, turn the key to position **3** (▷ page 323) and release it as soon as the engine is running.

- i** You can start the engine without preglow if the engine is warm.

- i** You can also use the touch-start function. To do this, turn the key to position **3** (▷ page 323) and release it immediately. The engine then starts automatically.

Using KEYLESS-GO to start the engine

WARNING

Your vehicle can be started using a valid KEYLESS-GO key. For this reason, children should never be left unsupervised in the vehicle. Always take the key with you when leaving the vehicle, even if you are only leaving it for a short time.

i The Start/Stop button can be used to start the vehicle manually without inserting the key into the ignition lock. The key must be in the vehicle and the Start/Stop button must be inserted in the ignition lock. This mode for starting the engine operates independently of the ECO start/stop automatic engine start function.

- ▶ Depress the brake pedal and keep it depressed.
- ▶ **To start a petrol engine:** press the Start/Stop button (▷ page 323) once. The engine starts.
- ▶ **To start a diesel engine:** press the Start/Stop button (▷ page 323) once. Preglow is activated and the engine starts.

Pulling away

Automatic transmission

i It is only possible to shift the transmission from position **P** to the desired position if you depress the brake pedal. Only then is the parking lock released.

- ▶ Depress the brake pedal and keep it depressed.
- ▶ Shift the transmission to position **D** or **R**.
- ▶ Release the brake pedal.
- ▶ Carefully depress the accelerator pedal. The electric parking brake (▷ page 340) is automatically released.

i The vehicle locks centrally once you have pulled away. The locking knobs in the doors drop down.

You can open the doors from the inside at any time.

You can also deactivate the automatic locking feature (▷ page 276).

i Upshifts take place at higher engine speeds after a cold start. This helps the catalytic converter to reach its operating temperature more quickly.

Hill start assist

Hill start assist helps you when pulling away forwards or in reverse on an uphill gradient. It holds the vehicle for a short time after you have removed your foot from the brake pedal. This gives you enough time to move your foot from the brake pedal to the accelerator pedal and depress it before the vehicle begins to roll.

WARNING

Never leave the vehicle when it is held by hill start assist. After approximately one second, hill start assist will no longer brake your vehicle and it could roll away.

- ▶ Take your foot off the brake pedal.
- i** Once you have taken your foot off the brake pedal, the vehicle is held for around one second.

- ▶ Pull away.

Hill start assist will not function if:

- you are pulling away on a level road or a downhill gradient.
- the transmission is in position **N**.
- the electric parking brake is applied.
- ESP[®] is malfunctioning.

ECO start/stop function

General notes

i **Hybrid vehicles:** the ECO start/stop function cannot be deactivated.

The ECO start/stop function is only available in drive program **E** (drive program **C** on AMG vehicles).

The ECO start/stop function switches the engine off automatically if the vehicle stops moving.

When pulling away again, the engine starts automatically. The ECO start/stop function thereby helps you to reduce the fuel consumption and emissions of your vehicle.

The ECO start/stop function is activated each time the engine is switched on. If all conditions for automatic engine switch-off are fulfilled (> page 326), the **ECO** symbol is shown in green in the multifunction display.

AMG vehicles: the AMG menu in the multifunction display additionally shows the **Stop/Start active** message.

If not all conditions are fulfilled, the **ECO** symbol is shown in yellow.

AMG vehicles: the AMG menu in the multifunction display additionally shows the **Stop/Start inactive** message.

If the ECO start/stop function is deactivated (> page 327), the **ECO** symbol is not shown.

WARNING

If the engine is switched off and the ECO symbol is shown in green in the multifunction display, the engine has been switched off automatically. All of the vehicle's systems remain active. If you open the door, unfasten your seat belt or remove your foot from the brake pedal, the engine will automatically start. The vehicle may begin moving. You could suffer serious or even fatal injury or cause an accident resulting in injury or death.

Never leave the vehicle while the ECO symbol in the multifunction display is shown in green or yellow. Always secure the vehicle against rolling away before leaving it.

! Always switch the ignition off and take the key with you when leaving the vehicle.

Automatic engine switch-off

The ECO start/stop function switches the engine off automatically if the vehicle is braked to a standstill and the brake remains depressed with the transmission in position **D** or **N**.

i You can also activate the HOLD function when the vehicle is stationary if the engine has been switched off automatically. It is then not necessary to continue applying the brakes during the automatic stop

phase. When you depress the accelerator pedal, the engine starts automatically and the braking effect of the HOLD function is deactivated. Depress the accelerator pedal gently, as the engine must be started first.

The engine is only switched off if:

- the outside temperature is within the range that is suitable for the system.
- the engine is at normal operating temperature.
- the set temperature for the vehicle interior has been reached.
- the battery is sufficiently charged.
- the system detects that the windscreen is not misted up when the air-conditioning system is switched on.
- the bonnet is closed.
- there are no active engine-related diagnoses.
- the driver's door is closed and the seat belt is fastened.

Automatic engine start

The engine is started automatically if you:

- release the brake pedal when HOLD is not activated and the transmission is in position **D** or **N**
- shift the transmission to position **R**
- depress the accelerator pedal
- switch off the ECO start/stop function or switch to drive program **S** or **M**
- unfasten your seat belt or open the driver's door

The engine is also started automatically if:

- the vehicle starts to roll.
- the brake system requires this.
- the system detects moisture on the windscreen when the air-conditioning system is switched on.
- the temperature in the vehicle interior deviates from the set range.
- the battery's charge status is too low.

Deactivating/activating the ECO start/stop function

General notes

You can deactivate and activate the ECO start/stop function using COMAND APS (▷ page 273).

- i** You can also use the programmable button (▷ page 119) to activate and deactivate the ECO start/stop function if you have assigned this function to the button.

Switching off

- ▶ Deactivate the ECO start/stop function using COMAND APS (▷ page 273).

All vehicles except for AMG vehicles: the **ECO** symbol in the multifunction display goes out.

AMG vehicles: the **ECO** symbol goes out and the **Stop/Start deactivated** message is shown in the AMG menu of the multifunction display.

- i** If drive program **S** or **M** has been selected, the ECO start/stop function is always deactivated.

Activating

- ▶ Activate the ECO start/stop function using COMAND APS (▷ page 273).

All vehicles except AMG vehicles: the **ECO** symbol appears in the multifunction display.

AMG vehicles: the **ECO** symbol is shown in the multifunction display. In addition, the **Stop/Start active** message is shown in the AMG menu.

If not all conditions for automatic engine switch-off (▷ page 326) are fulfilled, the **Stop/Start inactive** message appears.

- i** If you switch on the ECO start/stop function while drive program **S** or **M** is selected, the drive program automatically switches to **E** (drive program **C** on AMG vehicles).

Problems with the engine	
Problem	Possible causes/consequences and ► Solutions
The engine does not start. The starter motor can be heard.	<ul style="list-style-type: none"> • There is a malfunction in the engine electronics. • There is a malfunction in the fuel supply. <p>► Before attempting to start the engine again, turn the key in the ignition back to position 0 or press the Start/Stop button repeatedly until all indicator lamps in the instrument cluster go out.</p> <p>► Try to start the engine again (▷ page 324). Avoid excessively long and frequent attempts to start the engine, as this will drain the battery.</p> <p>If the engine does not start after several attempts:</p> <p>► Consult a qualified specialist workshop.</p>
The engine does not start. The starter motor can be heard. The reserve fuel warning lamp is lit and the fuel gauge display shows 0 .	<p>The fuel tank is empty.</p> <p>► Refuel the vehicle.</p>
The engine does not start. You cannot hear the starter motor.	<p>The on-board voltage is too low because the battery is too weak or discharged.</p> <p>► Jump-start the vehicle (▷ page 507).</p> <p>If the engine does not start despite attempts to jump-start it:</p> <p>► Consult a qualified specialist workshop.</p> <p>The starter motor was exposed to a thermal load that was too high.</p> <p>► Allow the starter motor to cool down for approximately two minutes.</p> <p>► Try to start the engine again.</p> <p>If the engine still does not start:</p> <p>► Consult a qualified specialist workshop.</p>
Vehicles with a petrol engine: The engine is not running smoothly and is misfiring.	<p>There is a malfunction in the engine electronics or in a mechanical component of the engine management system.</p> <p>► Only depress the accelerator pedal slightly. Otherwise, non-combusted fuel may get into the catalytic converter and damage it.</p> <p>► Have the cause rectified immediately at a qualified specialist workshop.</p>

Problem	Possible causes/consequences and ► Solutions
<p>The coolant temperature display is showing more than 120 °C. A display message may also appear in the multifunction display and a warning tone may sound.</p>	<p>The coolant level is too low. The coolant is too hot and the engine is no longer being cooled sufficiently.</p> <ul style="list-style-type: none"> ► Stop as soon as possible and allow the engine and the coolant to cool down. ► Check the coolant level (► page 480). Observe the warning notes as you do so and top up the coolant if necessary. <p>If the coolant level is correct, the engine radiator fan may be faulty. The coolant is too hot and the engine is no longer being cooled sufficiently.</p> <ul style="list-style-type: none"> ► If the coolant temperature is less than 120 °C, you can continue driving to the nearest qualified specialist workshop. ► Avoid heavy loads on the engine as you do so, e.g. driving on mountain roads and stop-start traffic.

Automatic transmission

Important safety notes

WARNING

The movement of the pedals must not be impaired in any way. Do not keep any objects in the driver's footwell. Make sure that floor-mats or carpets are correctly secured and that there is sufficient clearance for the pedals.

Do not place several floor-mats on top of one another.

WARNING

Do not change down for additional engine braking on a slippery road surface. This could cause the drive wheels to lose their grip and the vehicle could skid. This could cause you to lose control of your vehicle and cause an accident.

DIRECT SELECT lever

Overview of transmission positions

The DIRECT SELECT lever is on the right of the steering column.



P Park position with parking lock

R Reverse gear

N Neutral

D Drive

 The DIRECT SELECT lever always returns to its original position. The current transmission position **P**, **R**, **N** or **D** appears in the transmission position display (► page 331) in the multifunction display.

Engaging park position P

► Push the DIRECT SELECT lever in the direction of arrow **P**.

- i** The automatic transmission shifts into park position **P** automatically:
 - if you open the driver's door while the vehicle is stationary in transmission position **D** or **R**
 - if you open the door while travelling at very low speeds in transmission position **D** or **R**
- i** Depressing the brake and pushing the DIRECT SELECT lever up or down disengages the parking lock. The transmission is in **N** neutral.

In order to shift from park position **P** directly into **R** or **D**:

- depress the brake pedal and
- push the DIRECT SELECT lever up or down past the first point of resistance

- !** If the engine speed is too high, do not shift the automatic transmission directly from **D** to **R**, from **R** to **D** or directly to **P**. Otherwise, the automatic transmission could be damaged.

Engaging park position **P** automatically

Park position **P** is automatically engaged if:

- you switch off the engine using the key and remove the key
- you switch off the engine using the Start/Stop button and open the driver's door
- HOLD (▷ page 357) or DISTRONIC PLUS (▷ page 348) brake your vehicle until it is stationary and at least one of the following conditions is fulfilled:
 - the engine is switched off.
 - the driver's door is open and the seat belt is not fastened.
 - there is a system malfunction.
 - the power supply is insufficient.

In addition to park position **P**, the electric parking brake is automatically applied.

Engaging reverse gear **R**

- !** Only shift the automatic transmission to **R** when the vehicle is stationary.
- i** The ECO start/stop function is not available when reverse gear is engaged. For further information on the ECO start/stop function, see (▷ page 325).
- ▶ Push the DIRECT SELECT lever up past the first point of resistance.

Neutral **N** with ECO start/stop function activated

The ECO start/stop function switches the engine off automatically if:

- the vehicle is braked until stationary while in neutral **N** and
- you continue to apply the brakes

For further information on the ECO start/stop function (▷ page 325).

Shifting to neutral (**N**)

- ▶ Push the DIRECT SELECT lever up or down to the first point of resistance.

Drive position **D** with ECO start/stop function activated

The ECO start/stop function switches the engine off automatically if:

- the vehicle is braked until stationary while in transmission position **D** and
- you continue to apply the brakes

For further information on the ECO start/stop function (▷ page 325).

Engaging drive position **D**

- ▶ Push the DIRECT SELECT lever down past the first point of resistance.

Transmission position display

The current transmission position is shown in the multifunction display.

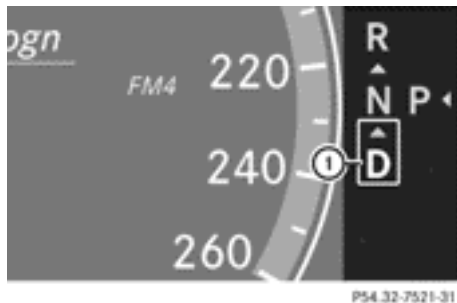

P54.32-7521-31

① Transmission position

i The arrows in the transmission position display show how and into which transmission positions you can change using the DIRECT SELECT lever.

! If the transmission position display in the multifunction display is not working, you should pull away carefully to check whether the desired transmission position is engaged. We recommend selecting transmission position **D** and drive program **E** (drive program **C** in AMG vehicles) or **S**. Do not restrict the shift range.

Transmission positions

P

Park position

This prevents the vehicle from rolling away when stopped. Do not shift the transmission into position **P** (> page 339) unless the vehicle is stationary.

The automatic transmission shifts to **P** automatically if you:

- remove the key
- switch off the engine when in **R** or **D** and open one of the front doors

R

Reverse gear

Only shift the transmission to **R** when the vehicle is stationary.

N

Neutral

Do not shift the transmission to **N** while driving. Otherwise, the automatic transmission could be damaged.

If ESP[®] is deactivated or faulty: only shift the transmission to position **N** if the vehicle is in danger of skidding, e.g. on icy roads.

If you switch off the engine using the key or the Start/Stop button, the automatic transmission shifts to neutral **N** automatically.

! Rolling in neutral **N** can lead to damage to the transmission.

D

Drive

The automatic transmission changes gear automatically. All forward gears are available.

Changing gear

The automatic transmission shifts to the individual gears automatically when it is in transmission position **D**. This automatic gearshifting behaviour is determined by:

- a shift range restriction, if selected
- the selected drive program
E/S/M (▷ page 332) or, on AMG vehicles, **C/S/M** (▷ page 332)
- the position of the accelerator pedal
- the road speed

Driving tips

Accelerator pedal position

Your style of driving influences how the automatic transmission shifts gear:

- little throttle: early upshifts
- more throttle: late upshifts

Kickdown

Use kickdown for maximum acceleration.

- ▶ Depress the accelerator pedal beyond the pressure point.
The transmission shifts to a lower gear depending on the engine speed.
- ▶ Ease off the accelerator pedal once the desired speed is reached.
The automatic transmission shifts back up.

Towing a trailer

- ▶ Drive in the middle of the engine speed range on uphill gradients.
- ▶ Shift down to shift range **3** or **2** (▷ page 333) depending on the uphill or downhill gradient, even if cruise control, DISTRONIC PLUS or SPEEDTRONIC is activated.

Program selector button

General notes

The program selector button influences:

- the drive program
- the AIRMATIC (▷ page 358) or ABC (▷ page 360) suspension settings
- the engine management



Example: program selector button with manual drive program

On AMG vehicles, drive program **E** is called drive program **C**.

E Economy	Comfortable, economical driving
C Controlled Efficiency	
S Sport	Sporty driving style
M Manual	Manual gearshifting

- i** For further information on the automatic drive program, see (▷ page 333).
- ▶ Press program selector button **Ⓢ** repeatedly until the letter for the desired gearshift program appears in the multifunction display.
- i** The automatic transmission switches to automatic drive program **E** (drive program **C** in AMG vehicles) each time the engine is started.

Steering wheel gearshift paddles



- ① Left-hand steering wheel gearshift paddle
- ② Right-hand steering wheel gearshift paddle

You can restrict or derestrict the shift range by using the steering wheel gearshift paddles. You can change gear yourself by using the steering wheel gearshift paddle in the manual drive program.

Automatic drive program

Drive program **E** (drive program **C** on AMG vehicles) is characterised by the following:

- comfort-oriented engine settings.
- optimal fuel consumption resulting from the automatic transmission shifting up sooner.
- the vehicle pulling away more gently in forward and reverse gears, unless the accelerator pedal is depressed fully.
- increased sensitivity. This improves driving stability on slippery road surfaces, for example.
- the automatic transmission shifting up sooner. This results in the vehicle being driven at lower engine speeds and the wheels being less likely to spin.

Drive program **S** is characterised by the following:

- sporty engine settings
- the vehicle pulling away in first gear

- the automatic transmission shifting up later
- as a result of the later automatic transmission shift points, the fuel consumption possibly being higher

Shift ranges

Introduction

When the automatic transmission is in position **D**, it is possible to restrict or derestrict the shift range (▷ page 333).

The shift range selected is shown in the multifunction display. The automatic transmission shifts only as far as the selected gear.

Shift range

3	To use the engine's braking effect
2	To use the braking effect of the engine on downhill gradients and for driving: <ul style="list-style-type: none"> • on steep mountain roads • in mountainous terrain • in arduous conditions
1	To use the braking effect of the engine on extremely steep downhill gradients and on long downhill stretches

Restricting the shift range

- ▶ Pull the left-hand steering wheel gearshift paddle.
The automatic transmission shifts down one gear and restricts the shift range to the relevant gear.
- i** If the engine exceeds the maximum engine speed when shifting down, the automatic transmission protects against engine damage by not shifting down.
- i** If the maximum engine speed for the shift range is reached and you continue to accelerate, the automatic transmission shifts up

in order to prevent the engine from over-revving, even if the shift range is restricted.

Derestricting the shift range

- ▶ Pull the right-hand steering wheel gearshift paddle.
The shift range is derestricted.

Clearing the shift range restriction

- ▶ Pull the right-hand steering wheel gearshift paddle until the number for the gear disappears from the multifunction display.

or

- ▶ Shift the transmission to position **D**.
The automatic transmission shifts from the current shift range directly to **D**.

Selecting the ideal shift range

- ▶ Pull the left-hand steering wheel gearshift paddle and hold it in position.
The automatic transmission shifts to the gear which allows optimum acceleration and deceleration. To do this, the automatic transmission shifts down one or more gears.

Manual drive program

Activating the manual drive program

Manual drive program **M** can be selected using the program selector button. In manual drive program **M**, you can change gear using the steering wheel gearshift paddles if the transmission is in position **D**. The gear currently selected and engaged is shown in the multifunction display.

- ▶ Press the program selector button (> page 332) repeatedly until **M** appears in the multifunction display.

Upshifting

- ▶ Pull the right-hand steering wheel gearshift paddle (> page 333).
The automatic transmission shifts up to the next gear.

AMG vehicles

- In manual gearshift program **M**, the automatic transmission does not shift up automatically even when the engine limiting speed for the current gear is reached. When the engine limiting speed is reached, the fuel supply is cut to prevent the engine from overrevving. You must make sure that the engine speed does not reach the red area of the rev counter. Otherwise, there is a risk of engine damage.

If you have selected the AMG menu in the on-board computer, **UP** appears in the instrument cluster, instructing you to shift up.

Downshifting

- ▶ Pull the left-hand steering wheel gearshift paddle (> page 333).
The automatic transmission shifts down to the next gear.

- ⓘ If you slow down or stop without shifting down, the automatic transmission automatically shifts down.

Kickdown

- ⓘ **AMG vehicles:** it is not possible to use kickdown in manual drive program **M**.

You can also use kickdown for maximum acceleration in manual drive program **M**.

- ▶ Depress the accelerator pedal beyond the pressure point.
The transmission shifts to a lower gear depending on the engine speed.
- ▶ Shift back up once the desired speed is reached.

- ⓘ **All vehicles (except AMG vehicles):** if you apply full throttle, the automatic trans-

mission shifts up to the next gear when the maximum engine speed is reached. This prevents the engine from overrevving.

Deactivating the manual drive program

- ▶ Press the program selector button (▷ page 332) repeatedly until **E** (**C** in AMG vehicles) or **S** appears in the multifunction display.

Problems with the transmission

Problem	Possible causes/consequences and ► Solutions
The transmission has problems shifting gear.	The transmission is losing oil. ► Have the transmission checked at a qualified specialist workshop immediately.
The acceleration ability is deteriorating. The transmission no longer changes gear.	The transmission is in emergency mode. It is only possible to shift into second gear and reverse gear. ► Stop. ► Shift the transmission to position P . ► Switch off the engine. ► Wait at least 10seconds before restarting the engine. ► Have the transmission checked at a qualified specialist workshop immediately.

Refuelling

Important safety notes

WARNING

Fuel is highly flammable. Fire, naked flames and smoking are therefore prohibited when handling fuels.

Switch off the engine and the auxiliary heating before refuelling.

WARNING

Avoid contact with fuels.

It is hazardous to your health if your skin comes into direct contact with fuels or you breathe in fuel vapours.

WARNING

Hybrid vehicles: ensure that you read the "HYBRID" supplement. You could otherwise fail to recognise dangers.

WARNING

Do not use petrol to refuel a diesel tank. Never mix diesel with petrol. Doing so could damage the fuel system and the engine. The vehicle could also catch fire.

 Do not use petrol to refuel vehicles with a diesel engine. Do not use diesel to refuel vehicles with a petrol engine. Even small amounts of the wrong fuel result in damage to the fuel system and the engine.

 Do not switch on the ignition if you accidentally refuel with the wrong fuel. Otherwise, the fuel will enter the fuel lines. Notify a qualified specialist workshop and have the fuel tank and fuel lines drained completely.

 Overfilling the fuel tank could damage the fuel system.

 Take care not to spill any fuel on painted surfaces. You could otherwise damage the paintwork.

 Use a filter when adding fuel from a fuel can. The fuel lines and/or the diesel injection system could otherwise be blocked by particles from the fuel can.

Further information on fuel and on fuel grades can be found in the "Fuel" section (► page 533).

Refuelling

Fuel filler flap

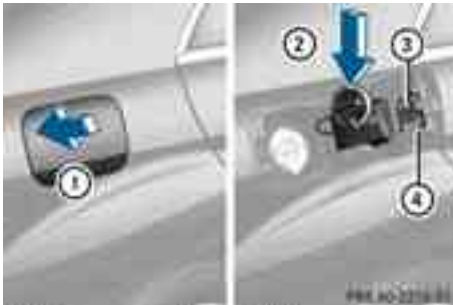

- ① To open the fuel filler flap
- ② To insert the fuel filler cap
- ③ Tyre pressure table
- ④ Fuel type

The fuel filler flap is unlocked or locked automatically when you open or close the vehicle with the key or using KEYLESS-GO.

The position of the fuel filler cap is displayed  in the instrument cluster. The arrow next to the filling pump indicates the side of the vehicle.

Opening

- ▶ Switch off the engine.
- ▶ Remove the key from the ignition lock.
- ▶ KEYLESS-GO: open the driver's door.
This corresponds to key position **0**: "key removed".
The driver's door can be closed again.
- ▶ Press the fuel filler flap in the direction of arrow ①.
The fuel filler flap opens slightly.
- ▶ Open the fuel filler flap fully.
- ▶ Turn the fuel filler flap anti-clockwise and remove it.
- ▶ Insert the fuel filler cap into the holder bracket on the inside of filler flap ②.

- ▶ Completely insert the filler neck of the fuel pump nozzle into the tank and refuel.
- ▶ Only fill the tank until the pump nozzle switches off.

i Do not add any more fuel after the pump stops filling for the first time. Otherwise, fuel may leak out.

Closing

- ▶ Replace the cap on the filler neck and turn clockwise until it engages audibly.
 - ▶ Close the fuel filler flap.
- i** Close the fuel filler flap before locking the vehicle. Otherwise, the locking pin of the central locking prevents the fuel filler flap from closing.

Problems with the fuel and fuel tank

Problem	Possible causes/consequences and ► Solutions
Fuel is leaking from the vehicle.	<p> Risk of explosion or fire</p> <p>The fuel line or the fuel tank is faulty.</p> <ul style="list-style-type: none"> ► Turn the key to position 0 in the ignition lock and remove it immediately (▷ page 323). ► Do not restart the engine under any circumstances. ► Consult a qualified specialist workshop.
The engine does not start.	<p>The fuel tank of a vehicle with a diesel engine has been run completely dry.</p> <ul style="list-style-type: none"> ► Refuel the vehicle with at least 5 litres of diesel. ► Turn the ignition on for around 10 seconds(▷ page 323). ► Start the engine continuously for up to 10 seconds until it runs smoothly. <p>or</p> <ul style="list-style-type: none"> ► Start the engine using the touch-start function. To do this, turn the key to position 3 in the ignition lock and then release it immediately (▷ page 323). <p>If the engine does not start:</p> <ul style="list-style-type: none"> ► Turn the ignition on again for approximately 10 seconds(▷ page 323). ► Start the engine again continuously for up to 10 seconds until it runs smoothly. <p>or</p> <ul style="list-style-type: none"> ► Start the engine again via the touch-start function. <p>If the engine does not start after three attempts:</p> <ul style="list-style-type: none"> ► Consult a qualified specialist workshop.

Problem	Possible causes/consequences and ► Solutions
The fuel filler flap cannot be opened.	The fuel filler flap is not unlocked. or The key battery is discharged. ► Unlock the vehicle (▷ page 80). or ► Unlock the vehicle using the emergency key element (▷ page 82).
	The fuel filler flap is unlocked, but the opening mechanism is jammed. ► Consult a qualified specialist workshop.

Parking

Important safety notes

 **WARNING**

Do not leave children unsupervised in the vehicle. They might release the electric parking brake. This could lead to a serious or fatal accident.

 **WARNING**

Under no circumstances should the exhaust system come into contact with flammable materials such as dry grass or petrol, for example. Do not park the vehicle on dry grass-land or harvested grain fields. The hot exhaust system could otherwise ignite the flammable material and set the vehicle on fire.

To ensure that the vehicle is secured against rolling away unintentionally:

- the electric parking brake must be applied.
- the transmission must be in position **P** and the key must be removed from the ignition lock.
- on uphill or downhill gradients, turn the front wheels towards the kerb.

Switching off the engine

Important safety notes

 **WARNING**

If the engine is not running, there is no power assistance for the steering and brakes. Steering and braking then requires significantly greater effort.

As a result, you might lose control of the vehicle, cause an accident and injure yourself and others.

Therefore, do not switch off the engine while you are driving.

Vehicles with automatic transmission

- Apply the electric parking brake.
- Shift the transmission to position **P**.

Using the key

- Turn the key to position **0** in the ignition lock and remove it.
The immobiliser is activated.
-  If you switch the engine off with the transmission in position **R** or **D**, the automatic transmission shifts to **N** automatically.
If you then open the driver's door or the front-passenger door or remove the key

from the ignition, the automatic transmission shifts to **P**.

If you shift the automatic transmission to **N** before switching off the engine, the automatic transmission remains in **N** even if a door is opened.

Using KEYLESS-GO

► Press the Start/Stop button (▷ page 323). The engine stops and all the indicator lamps in the instrument cluster go out.

i When the driver's door is closed, this corresponds to key position **1**. When the driver's door is open, this corresponds to key position **0**, i.e. key removed.

i If you use the Start/Stop button to switch off the engine, the automatic transmission shifts to **N** automatically. If you then open the driver's or front-passenger door, the automatic transmission shifts to **P**.

i The engine can be turned off while the vehicle is in motion by pressing and holding the Start/Stop button for three seconds. This function operates independently of the ECO start/stop automatic engine switch-off function.

Electric parking brake

General notes



Engaging/releasing manually

► **To engage:** push handle ①.

When the electric parking brake is engaged, the  red indicator lamp lights up in the instrument cluster.

i The electric parking brake can also be applied when the key is removed.

► **To release:** pull handle ①.

The red  indicator lamp in the instrument cluster goes out.

i The electric parking brake can only be released:

- when the key is in position **1** in the ignition lock or
- the ignition was switched on using the Start/Stop button.

Engaging the electric parking brake automatically

If the HOLD function or DISTRONIC PLUS brake the vehicle until it is stationary, the electric parking brake is automatically applied. Additionally, at least one of the following conditions must be fulfilled:

- the engine is switched off.
- the driver's door is open and the seat belt is not fastened.
- the bonnet is released.
- the boot lid is opened while the automatic transmission is in position **R**.
- the vehicle is stationary for a lengthy period.

The red  indicator lamp in the instrument cluster lights up.

i In addition to the electric parking brake, **P** may also be engaged automatically.

Releasing the electric parking brake automatically

The electric parking brake is released automatically when the following conditions are simultaneously fulfilled:

- the engine is running.
- the automatic transmission is in position **D** or **R**.
- the bonnet is closed.
- your seat belt is fastened.
- you accelerate.

If the automatic transmission is in position **R**, the boot lid must be closed.

If your seat belt is not fastened, the following conditions must be fulfilled to automatically release the electric parking brake:

- the driver's door is closed.
- you have shifted out of **P** or you have previously driven faster than 3 km/h.

Emergency braking

The vehicle can also be braked during an emergency using the electric parking brake.

- ▶ While driving, push handle ① of the electric parking brake (▷ page 340).
- ❗ The vehicle is braked as long as you keep the handle of the electric parking brake pressed. The longer the electric parking brake handle is depressed, the greater the braking force.

During braking:

- a warning tone sounds.
- the **Release parking brake** message appears.
- the red  indicator lamp lights up in the instrument cluster.

When the vehicle has been braked to a standstill, the electric parking brake is engaged.

Parking up the vehicle

If you leave the vehicle parked up for longer than four weeks, the battery may be damaged by exhaustive discharging.

- ▶ Disconnect the battery or connect it to a trickle charger.
- ❗ You can obtain information about trickle chargers from a qualified specialist workshop.

If you leave the vehicle parked up for longer than six weeks, the vehicle may suffer damage as a result of lack of use.

- ▶ Visit a qualified specialist workshop and seek advice.

Driving tips

General driving tips

Coasting with the engine switched off

WARNING

Never switch the engine off while the vehicle is in motion.

There is no power assistance for the steering and the service brake when the engine is not running.

You will require considerably more effort to steer and brake, and you could therefore lose control of the vehicle and cause an accident.

Short journeys

- ❗ **Vehicles with a diesel particle filter:** if the vehicle is mostly driven for short distances, it is possible that malfunctions may occur during the automatic cleaning of the diesel particle filter. This may lead to fuel collecting in the engine oil and cause engine failure. Therefore, if you frequently drive short distances, you should take a 20 minute trip on a motorway or rural road at least every 500km.

Brakes

Important safety notes

WARNING

Do not change down for additional engine braking on a slippery road surface. This could cause the drive wheels to lose their grip and the vehicle could skid.

WARNING

Make sure that other road users are not endangered by your braking.

Downhill gradients

On long and steep downhill gradients, especially if the vehicle is laden or towing a trailer, you must select shift range **1**, **2** or **3** in good time.

 This also applies if you have activated cruise control, SPEEDTRONIC or DIS-TRONIC PLUS.

This will use the braking effect of the engine, so less braking will be required to maintain the speed. This relieves the load on the brake system and prevents the brakes from overheating and wearing too quickly.

Heavy and light loads

WARNING

Never depress the brake pedal continuously while the vehicle is in motion, e.g. never cause the brakes to rub by applying constant slight pedal pressure. This causes the brake system to overheat, increases the braking distance and can lead to the brakes failing completely.

If the brakes have been subjected to a heavy load, do not stop the vehicle immediately, but drive on for a short while. This allows the airflow to cool the brakes more quickly.

If the brakes have been used only moderately, you should occasionally test their effectiveness. To do this, brake more firmly from a

higher speed. This improves the grip of the brakes.

Wet road surfaces

If driving in heavy rain for a prolonged period of time without braking, there may be a delayed reaction from the brakes when braking for the first time. This may also occur after the vehicle has been washed.

You have to depress the brake pedal more firmly. Maintain a greater distance from the vehicle in front.

After driving on a wet road or having the vehicle washed, brake firmly while paying attention to the traffic conditions. This will warm up the brake discs, thereby drying them more quickly and protecting them against corrosion.

Limited braking performance on salt-treated roads

WARNING

The layer of salt on the brake discs and the brake pads/linings may cause a delay in the braking effect, resulting in a significantly longer braking distance, which could lead to an accident.

To avoid this danger, you should:

- occasionally brake carefully, without putting other road users at risk, when you are driving on salted roads. This helps to remove any salt that may have started to build up on the brake discs and the brake pads/linings.
- maintain a greater distance to the vehicle ahead and drive with particular care.
- carefully apply the brakes at the end of a trip and immediately after commencing a new trip, so that salt residues are removed from the brake discs.

New brake pads/linings

WARNING

New brake pads/linings only reach their optimum braking effect after several hundred kilometres of driving. Before this optimum braking effect is reached, you should compensate for the reduced braking effect by applying greater pressure when braking. This also applies after the brake discs or the brake pads/linings have been replaced.

For safety reasons, Mercedes-Benz recommends that you only have brake pads/linings fitted to your vehicle which have been approved for Mercedes-Benz vehicles or which correspond to an equivalent quality standard. Brake pads/linings which have not been approved for Mercedes-Benz vehicles or which are not of an equivalent quality could affect your vehicle's operating safety.

High-performance brake system for AMG vehicles

The high-performance brake system is designed for heavy loads. This may lead to noise when braking. This will depend on:

- speed
- braking force
- environmental conditions, such as temperature and humidity

The wear of individual components of the brake system, such as the brake pads/linings or brake discs, depends on the individual driving style and operating conditions.

For this reason, it is impossible to state a mileage that will be valid under all circumstances. An aggressive driving style will lead to high wear. You can obtain further information about this from your Mercedes-Benz Service Centre.

Tyre traction

WARNING

Whereas the vehicle can be fully controlled at a certain speed on dry roads, you must reduce your speed on wet or icy roads to achieve the same road safety. You could otherwise cause an accident.

Pay particular attention to the road conditions at temperatures around freezing point.

If ice has formed on the road surface (e.g. from fog), a thin film of water rapidly forms on the ice when you brake, considerably reducing tyre traction. Drive with particular care in such weather conditions.

Driving on wet roads

Aquaplaning

If water has accumulated to a certain depth on the road surface, there is a danger of aquaplaning occurring, even if:

- you are driving at low speeds.
- the tyres have adequate tread depth.

For this reason, do not drive in tyre ruts, and brake carefully.

Driving on flooded roads

If you have to drive on stretches of road on which water has collected, please bear in mind that:

- the maximum permissible still water depth when the vehicle is raised is 25 cm.
- you should drive no faster than at walking pace.

 Bear in mind that vehicles travelling in front or in the opposite direction create waves. This may cause the maximum permissible water depth to be exceeded.

These notes must be observed under all circumstances. You could otherwise damage the engine, the electronics or the transmission.

Winter driving

Important safety notes

WARNING

If the vehicle becomes trapped in snow, ensure that snow is kept away from the exhaust pipe and from around the vehicle as long as the engine is running. Otherwise, poisonous carbon monoxide (CO) may enter the vehicle, resulting in loss of consciousness and even death.

To assure sufficient fresh air ventilation, open a window slightly on the side of the vehicle not facing the wind.

Have your vehicle winterproofed at a qualified specialist workshop at the onset of winter. Observe the notes in the "Winter operation" section (▷ page 518).

Driving with summer tyres

Observe the notes in the "Winter operation" section (▷ page 518).

Slippery road surfaces

WARNING

Do not shift down for additional engine braking on a slippery road surface. This could cause the drive wheels to lose their grip and the vehicle could skid.

You should drive particularly carefully on slippery road surfaces. Avoid sudden acceleration, steering and braking manoeuvres.

If the vehicle threatens to skid or cannot be stopped when moving at low speed:

- ▶ Move the transmission to position **N**.
- ▶ Try to bring the vehicle under control by using corrective steering.

 For more information on driving with snow chains, see (▷ page 519).

Driving systems

Cruise control

Important safety notes

Cruise control maintains a constant road speed for you. It brakes automatically in order to avoid exceeding the set speed. On long and steep downhill gradients, especially if the vehicle is laden or towing a trailer, you must select shift range **1**, **2** or **3** in good time. By doing so, you will make use of the braking effect of the engine. This relieves the load on the brake system and prevents the brakes from overheating and wearing too quickly.

WARNING

Do not change down for additional engine braking on a slippery road surface. This could cause the drive wheels to lose their grip and the vehicle could skid.

Use cruise control only if road and traffic conditions make it appropriate to maintain a steady speed for a prolonged period. You can store any road speed above 30 km/h.

WARNING

Cruise control cannot take account of road and traffic conditions.

Always pay attention to traffic conditions even when cruise control is activated.

Cruise control is only an aid designed to assist driving. You are responsible for the vehicle's speed and for braking in good time.

WARNING

Do not use cruise control

- in traffic conditions that do not allow you to drive at a constant speed (e.g. heavy traffic or winding roads). You may otherwise cause an accident.
- on slippery roads. The drive wheels may lose their grip when braking or accelerating and the vehicle may skid.
- when there is low visibility, e.g. due to fog, heavy rain or snow.

Cruise control lever

You can operate cruise control and variable SPEEDTRONIC with the cruise control lever. The LIM indicator lamp on the cruise control lever indicates which system you have selected:

- **LIM indicator lamp off:** cruise control is selected.
- **LIM indicator lamp on:** variable SPEEDTRONIC is selected.

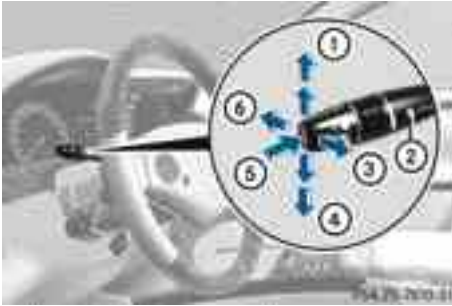

- ① To activate or increase speed
- ② LIM indicator lamp
- ③ To activate at the current speed/last stored speed
- ④ To activate or reduce speed
- ⑤ To switch between cruise control and variable SPEEDTRONIC
- ⑥ To deactivate cruise control

When you activate cruise control, the stored speed is shown in the multifunction display for five seconds. A triangle is also shown in the speedometer. The speedometer dial lights up between the set speed and the maximum speed.

Selecting cruise control

- ▶ Check whether LIM indicator lamp ② is off. If it is off, cruise control is already selected. If it is not, press the cruise control lever in the direction of arrow ⑤. LIM indicator lamp ② in the cruise control lever goes out. Cruise control is selected.

Storing and maintaining the current speed

You can store the current speed if you are driving faster than 30 km/h.

- ▶ Accelerate the vehicle to the desired speed.
- ▶ Briefly press the cruise control lever up ① or down ④.
- ▶ Remove your foot from the accelerator pedal. Cruise control is activated. The vehicle automatically maintains the speed.

i Cruise control may be unable to maintain the stored speed on uphill gradients. The stored speed is resumed when the gradient evens out. Cruise control maintains the stored speed on downhill gradients by automatically applying the brakes.

Storing the current speed and calling up the last stored speed

WARNING

Only call up a stored speed if you know what that speed is and if it is suitable for the current traffic and driving situation. You can otherwise endanger yourself or others by unintentionally triggering sudden acceleration or braking.

- ▶ Briefly pull the cruise control lever towards you ③.
- ▶ Remove your foot from the accelerator pedal. The first time cruise control is activated, it stores the current speed or regulates the speed of the vehicle to the previously stored speed.

Setting a speed

- ▶ Press the cruise control lever up ① for a higher speed or down ④ for a lower speed.
- ▶ Keep the cruise control lever pressed until the desired speed is reached.

- ▶ Release the cruise control lever. The new speed is stored.
 - ▶ **Setting in 1-km/h increments:** press the cruise control lever briefly up ① or down ④ to the pressure point. The last stored speed increases or decreases in 1 km/h increments.
 - ▶ **Setting in 10-km/h increments:** press the cruise control lever briefly up ① or down ④ beyond the pressure point. The last stored speed increases or decreases in 10 km/h increments.
- ❗ Cruise control is not deactivated if you depress the accelerator pedal. For example, if you accelerate briefly to overtake, cruise control adjusts the vehicle's speed to the last speed stored after you have finished overtaking.

Deactivating cruise control

There are several ways to deactivate cruise control:

- ▶ Briefly press the cruise control lever forwards ⑥.
- or
- ▶ Brake
- or
- ▶ Briefly press the cruise control lever in the direction of arrow ⑤.
Variable SPEEDTRONIC is selected. LIM indicator lamp ② in the cruise control lever lights up.
- Cruise control is automatically deactivated if:
- you engage the electric parking brake.
 - you are driving at less than 30 km/h.
 - ESP® intervenes or if you deactivate ESP®.
 - you shift the transmission to position **N** while driving.

If cruise control is deactivated, you will hear a warning tone. You will see the **Cruise control off** message in the multifunction display for approximately five seconds.

- ❗ The last speed stored is cleared when you switch off the engine.

SPEEDTRONIC

Important safety notes

SPEEDTRONIC brakes automatically so that you do not exceed the set speed. On long and steep downhill gradients, especially if the vehicle is laden or towing a trailer, you must select shift range **1**, **2** or **3** in good time. By doing so, you will make use of the braking effect of the engine, which relieves the load on the brake system and prevents the brakes from overheating and wearing too quickly. If you need additional braking, depress the brake pedal repeatedly rather than continuously.

WARNING

Never depress the brake pedal continuously while the vehicle is in motion, e.g. never cause the brakes to rub by applying constant slight pedal pressure. This causes the brake system to overheat, increases the braking distance and can lead to the brakes failing completely.

WARNING

Do not change down for additional engine braking on a slippery road surface. This could cause the drive wheels to lose their grip and the vehicle could skid.

You can set a variable or permanent limit speed:

- **variable** for speed limits, e.g. in built-up areas
- **permanent** for long-term speed restrictions, e.g. when driving with winter tyres fitted (▷ page 348)

WARNING

SPEEDTRONIC is only an aid designed to assist driving. You are responsible for the vehicle's speed and for braking in good time.

- i** The speed indicated in the speedometer may differ slightly from the limit speed stored.

Variable SPEEDTRONIC

General notes

With the cruise control lever, you can operate cruise control or DISTRONIC PLUS and variable SPEEDTRONIC.

The LIM indicator lamp on the cruise control lever indicates which system you have selected:

- **LIM indicator lamp off:** cruise control or DISTRONIC PLUS is selected.
- **LIM indicator lamp on:** variable SPEEDTRONIC is selected.

You can use the cruise control lever to limit the speed to any speed above 30 km/h while the engine is running.

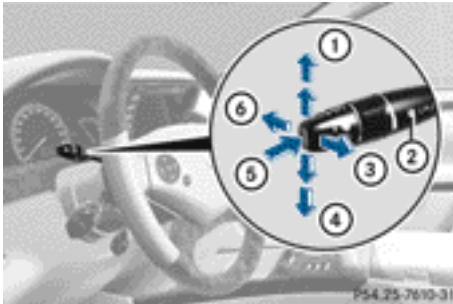

- ① To store the current speed or a higher speed
- ② LIM indicator lamp
- ③ To store the current speed or call up the last stored speed
- ④ To store the current speed or a lower speed
- ⑤ To switch between cruise control or DISTRONIC PLUS and variable SPEEDTRONIC
- ⑥ To deactivate variable SPEEDTRONIC

Selecting variable SPEEDTRONIC

- ▶ Check whether LIM indicator lamp ② is on. If it is on, variable SPEEDTRONIC is already selected.

If it is not, press the cruise control lever in the direction of arrow ⑤.

LIM indicator lamp ② in the cruise control lever lights up. Variable SPEEDTRONIC is selected.

⚠ WARNING

If there is a change of drivers, advise the new driver of the limit speed stored.

Only use variable SPEEDTRONIC if you will not have to accelerate suddenly to a speed above that stored as the limit speed. You could otherwise cause an accident.

You can only exceed the limit speed stored if you deactivate variable SPEEDTRONIC:

- using the cruise control lever
- by depressing the accelerator pedal beyond the pressure point (kickdown)

It is not possible to deactivate variable SPEEDTRONIC by braking.

⚠ WARNING

Vehicles with DISTRONIC PLUS: variable SPEEDTRONIC brakes automatically in order to avoid exceeding the set speed. As it does so, the brake pedal is depressed. The movement of the pedals must not be impaired in any way.

- Do not put any objects in the footwell.
- Ensure that floor mats and carpets are fixed securely. Do not place several floor mats on top of one another.
- Do not place your foot under the brake pedal as it could become trapped.

Storing the current speed

You can use the cruise control lever to limit the speed to any speed above 30 km/h while the engine is running.

- ▶ Briefly press the cruise control lever up ① or down ④.

The current speed is stored and shown in the multifunction display.

The speedometer dial lights up between the start of the scale and the stored speed.

Storing the current speed and calling up the last stored speed

WARNING

Only select a stored speed if you know what that speed is and whether it is suitable for the current driving and traffic situation. Otherwise, sudden braking could endanger you or others.

- ▶ Briefly pull the cruise control lever towards you ③.

Making adjustments in 1 km/h increments

- ▶ Briefly press the cruise control lever to the pressure point, up ① for a higher speed or down ④ for a lower speed.

or

- ▶ Keep the cruise control lever pressed to the pressure point until the desired speed is set. Press the cruise control lever up ① for a higher speed or down ④ for a lower speed.

Making adjustments in 10 km/h increments

- ▶ Briefly press the cruise control lever beyond the pressure point, up ① for a higher speed or down ④ for a lower speed.

or

- ▶ Keep the cruise control lever pressed beyond the pressure point until the desired speed is set. Press the cruise control lever up ① for a higher speed or down ④ for a lower speed.

Deactivating variable SPEEDTRONIC

There are several ways to deactivate variable SPEEDTRONIC:

- ▶ Briefly press the cruise control lever forwards ⑥.

or

- ▶ Briefly press the cruise control lever in the direction of arrow ⑤.

LIM indicator lamp ② in the cruise control lever goes out. Variable SPEEDTRONIC is deactivated.

Cruise control or DISTRONIC PLUS is selected.

Variable SPEEDTRONIC is deactivated automatically if you depress the accelerator pedal beyond the pressure point (kickdown), but only if your current speed does not differ by more than 20 km/h from the stored speed. You will hear a warning tone if this is the case.

WARNING

It is not possible to deactivate variable Speedtronic by braking.

-  The last speed stored is cleared when you switch off the engine.

Permanent SPEEDTRONIC

You can use the on-board computer to limit the speed permanently to a value between 160 km/h (e.g. for driving on winter tyres) and the maximum speed (▷ page 407).

Shortly before the stored speed is reached, it appears in the multifunction display.

Permanent SPEEDTRONIC remains active, even if variable SPEEDTRONIC is deactivated.

You cannot exceed the stored limit speed, even if you depress the accelerator pedal beyond the pressure point (kickdown).

DISTRONIC PLUS

Important safety notes

DISTRONIC PLUS regulates the speed and automatically helps you maintain the distance to the vehicle detected in front. DISTRONIC PLUS brakes automatically so that the set speed is not exceeded.

On long and steep downhill gradients, especially if the vehicle is laden or towing a trailer, you must select shift range **1**, **2** or **3** in good

time. By doing so, you will make use of the braking effect of the engine. This relieves the load on the brake system and prevents the brakes from overheating and wearing too quickly.

If DISTRONIC PLUS detects a slower-moving vehicle in front, your vehicle is braked in order to maintain the preset distance to the vehicle in front.

WARNING

Hybrid vehicles: ensure that you read the "HYBRID" supplement. You could otherwise fail to recognise dangers.

WARNING

The brake pedal is retracted when DISTRONIC brakes. Do not restrict the movement of the pedal in any way.

- Do not put any objects in the footwell.
- Ensure that floor mats and carpets are fixed securely. In particular, do not place several floor mats on top of one another.
- Do not place your foot under the brake pedal as it could become trapped.

You could otherwise cause an accident and injure yourself and others.

WARNING

Do not change down for additional engine braking on a slippery road surface. This could cause the drive wheels to lose their grip and the vehicle could skid.

WARNING

DISTRONIC PLUS is only an aid designed to assist driving. The driver remains fully responsible for the vehicle's distance from other vehicles, the vehicle's speed and for braking in good time.

DISTRONIC PLUS does not react in particular to:

- pedestrians
- stationary obstacles on the road, e.g. stopped or parked vehicles
- oncoming and crossing traffic

DISTRONIC PLUS may not detect narrow vehicles driving in front, e.g. motorcycles, or vehicles driving on a different line. Therefore, always pay attention to traffic conditions even when DISTRONIC PLUS is activated. Otherwise, you may fail to recognise dangers in time, cause an accident and injure yourself and others.

WARNING

DISTRONIC PLUS cannot take account of road and traffic conditions. If DISTRONIC does not recognise or no longer recognises the vehicle in front, do not activate DISTRONIC or, if it is already active, deactivate it. This is especially the case:

- before corners
- on filter lanes
- when changing to a lane with faster moving traffic
- in complex driving situations or where lanes are diverted, e.g. at roadworks on a motorway

DISTRONIC PLUS otherwise maintains the current speed set by you or accelerates up to the set speed.

DISTRONIC PLUS cannot take account of weather conditions. Deactivate, or do not activate, DISTRONIC PLUS:

- if the roads are slippery, snow-covered or icy. The wheels could lose their grip when braking or accelerating. The vehicle could start to skid.
- if the sensors are dirty or there is poor visibility, e.g. due to snow, rain or fog. Distance control may be impaired.

Always pay attention to traffic conditions even when DISTRONIC PLUS is activated.

Otherwise, you may fail to recognise dangers in time, cause an accident and injure yourself and others.

Vehicles with COMAND and navigation system: you must deactivate the radar sensor system near radio telescope facilities (▷ page 545).

If you want DISTRONIC PLUS to assist you, the radar sensor system must be activated (▷ page 408) and operational.

If there is no vehicle in front, DISTRONIC PLUS operates in the same way as cruise control in the speed range between 30 km/h and 200 km/h. If a vehicle is driving in front of you, DISTRONIC operates in the speed range between 0 km/h and 200 km/h.

Do not use DISTRONIC PLUS on roads with steep gradients.

WARNING

DISTRONIC PLUS brakes your vehicle up to a maximum of 4 m/s^2 depending on its speed. This corresponds to approximately 40% of your vehicle's maximum braking power. You must also apply the brakes yourself if this braking power is not sufficient.

If DISTRONIC PLUS detects a risk of collision with a vehicle in front, an intermittent warning tone sounds. In addition, the  distance warning lamp in the instrument cluster lights up. Brake to avoid a collision.

Cruise control lever

With the cruise control lever, you can operate DISTRONIC PLUS and variable SPEEDTRONIC.

The LIM indicator lamp on the cruise control lever indicates which system you have selected:

- **LIM indicator lamp off:** DISTRONIC PLUS is selected.
- **LIM indicator lamp on:** variable SPEEDTRONIC is selected.



- ① To store the current speed or a higher speed
- ② To set the specified minimum distance
- ③ LIM indicator lamp
- ④ To store the current speed or call up the last stored speed
- ⑤ To store the current speed or a lower speed
- ⑥ To switch between DISTRONIC PLUS and variable SPEEDTRONIC
- ⑦ To deactivate DISTRONIC PLUS

Selecting DISTRONIC PLUS

- ▶ Check whether LIM indicator lamp ③ is off. If it is off, DISTRONIC PLUS is already selected. If it is not, press the cruise control lever in the direction of arrow ⑥. LIM indicator lamp ③ in the cruise control lever goes out. DISTRONIC PLUS is selected.

Activating DISTRONIC PLUS, storing and maintaining the current speed

Important safety notes

WARNING

The vehicle can be braked when DISTRONIC PLUS is activated. For this reason, deactivate DISTRONIC PLUS if the vehicle is to be set in motion by other means (e.g. in a car wash or by towing).

To activate DISTRONIC PLUS, the following conditions must be fulfilled:

- the engine must be running. It may take up to two minutes of driving before DISTRONIC PLUS is ready for use.
- the electric parking brake must be released.
- ESP® must be switched on, but not intervening.
- the transmission must be in position **D**.
- the bonnet must be closed.
- the driver's door must be closed when you shift from **P** to **D** or your seat belt must be fastened.
- the front-passenger door and the rear doors must be closed.
- the vehicle must not be skidding.

Activating while driving

When driving at speeds below 30 km/h, you can only activate DISTRONIC PLUS if the vehicle in front has been detected and is shown in the multifunction display. If the vehicle in front is no longer detected and displayed, DISTRONIC PLUS switches off and you will hear a tone.

- ▶ Briefly pull the cruise control level towards you ④, or press it up ① or down ⑤. DISTRONIC PLUS is selected.
- ▶ Keep the cruise control lever pressed up ① or down ⑤ until the desired speed is set.
- ▶ Remove your foot from the accelerator pedal.
Your vehicle adapts its speed to that of the vehicle in front, but only up to the desired stored speed.

i If you do not fully release the accelerator pedal, the **DISTRONIC PLUS override** message appears in the multifunction display. The set distance to a slower-moving vehicle in front will then not be maintained. You will be driving at the speed you determine by the position of the accelerator pedal.

Activating when driving towards a stationary vehicle

If the vehicle in front of you is stationary, you can only activate DISTRONIC PLUS once your vehicle is stationary as well.

- ▶ Briefly pull the cruise control level towards you ④, or press it up ① or down ⑤. DISTRONIC PLUS is selected.

i DISTRONIC PLUS can only be activated at under 30 km/h if a vehicle in front has been detected. Therefore, the DISTRONIC PLUS distance display in the instrument cluster should be activated (> page 404).

- ▶ Keep the cruise control lever pressed up ① or down ⑤ until the desired speed is set.

i You can use the cruise control lever to set the stored speed and the control on the cruise control lever to set the specified minimum distance (> page 354).

Pulling away

- ▶ **If the vehicle in front pulls away:** remove your foot from the brake pedal.
- ▶ Briefly pull the cruise control lever towards you ④.
or
- ▶ Accelerate briefly.
Your vehicle pulls away and adapts its speed to that of the vehicle in front.

Driving

If there is no vehicle in front, DISTRONIC PLUS operates in the same way as cruise control.

If DISTRONIC PLUS detects that the vehicle in front has slowed down, it brakes your vehicle. In this way, the distance you have selected is maintained.

If DISTRONIC PLUS detects that the vehicle in front is driving faster, it accelerates your vehicle, but only up to the speed you have stored.

⚠ WARNING

If you depress the brake, DISTRONIC PLUS is deactivated unless your vehicle is stationary. DISTRONIC PLUS then no longer brakes your vehicle. In such cases, control the distance from vehicles travelling in front with the brake alone. You could otherwise cause an accident and thereby injure yourself and others. The driver remains fully responsible for the vehicle's distance from other vehicles, the speed being driven and for braking in good time.

Changing lanes

If you change to the overtaking lane, DISTRONIC PLUS supports you if:

- you are driving faster than 60 km/h.
- DISTRONIC PLUS is maintaining the distance to a vehicle in front.
- you switch on the respective turn signals.
- DISTRONIC PLUS does not detect a danger of collision.

If these conditions are met, your vehicle is accelerated. Acceleration will be interrupted if changing lanes takes too long or if the distance between your vehicle and the vehicle in front becomes too small.

- i** When changing lanes, DISTRONIC PLUS monitors the left lane for left-hand-drive vehicles and the right lane for right-hand-drive vehicles.

⚠ WARNING

DISTRONIC PLUS and Active Blind Spot Assist are only an aid designed to assist driving.

They do not relieve you of the responsibility of paying attention. The driver remains fully responsible for the vehicle's distance from other vehicles, the vehicle's speed and for braking in good time. Always pay attention to traffic conditions and your surroundings. Otherwise, you may fail to recognise dangers in time, cause an accident and injure yourself and others.

Vehicles with COMAND APS

- i** The following function is not operational in all countries.

DISTRONIC PLUS uses additional information from your navigation system so that it can adapt to certain traffic situations. This is the case if, while following a vehicle, DISTRONIC PLUS is active and you:

- approach or drive around a roundabout
- approach a T-junction
- turn off at a motorway exit

Even if the vehicle in front leaves the detection range, DISTRONIC PLUS temporarily maintains the current driving speed and does not accelerate. This is based on the current map data in the navigation system.



Example: roundabout

The current speed is maintained:

- approximately 10 seconds before the roundabout/T-junction and for approximately 1.5 seconds when driving on the roundabout
- approximately 12 seconds before reaching a motorway exit and approximately 4 seconds after the motorway exit

Afterwards, the vehicle accelerates back to the set speed you specified.

Stopping**⚠ WARNING**

Never get out of the vehicle when DISTRONIC PLUS is activated.

DISTRONIC PLUS must also never be operated, activated or deactivated by a passenger or from outside the vehicle.

DISTRONIC PLUS does not replace the electric parking brake and must not be used for parking.

The DISTRONIC PLUS braking effect is cancelled and the vehicle can start moving if:

- DISTRONIC PLUS is deactivated using the cruise control lever.
- you accelerate.
- there is a malfunction in the system or an interruption in the power supply, e.g. battery failure.
- the electrical system in the engine compartment, the battery or the fuses are tampered with.
- the battery is disconnected.

If you wish to leave the vehicle or park it, deactivate DISTRONIC PLUS and secure the vehicle against rolling away.

WARNING

Hybrid vehicles: ensure that you read the "HYBRID" supplement. You could otherwise fail to recognise dangers.

If DISTRONIC PLUS detects that the vehicle in front is stopping, it brakes your vehicle until it is stationary.

Once your vehicle is stationary, it remains stationary and you do not need to depress the brake.

- i** After a time, the electric parking brake secures the vehicle and relieves the service brake.
- i** Depending on the specified minimum distance, your vehicle will come to a standstill at a sufficient distance behind the vehicle in front. The specified minimum distance is set using the control on the cruise control lever.

Setting a speed

- ▶ Press the cruise control lever up **①** for a higher speed or down **⑤** for a lower speed.
- ▶ Keep the cruise control lever pressed until the desired speed is reached.
- ▶ Release the cruise control lever.
The new speed is stored. DISTRONIC PLUS is activated and adjusts the vehicle's speed to the new speed stored.
- ▶ **Setting in 1-km/h increments:** press the cruise control lever briefly up **①** or down **②** to the pressure point.
The last stored speed increases or decreases in 1 km/h increments.
- ▶ **Setting in 10-km/h increments:** press the cruise control lever briefly up **①** or down **②** beyond the pressure point.
The last stored speed increases or decreases in 10 km/h increments.

- i** DISTRONIC PLUS is not deactivated if you depress the accelerator pedal. If you accelerate to overtake, DISTRONIC PLUS adjusts the vehicle's speed to the last speed stored after you have finished overtaking.

Storing the current speed or calling up the stored speed

WARNING

Only call up a stored speed if you know what that speed is and if it is suitable for the current traffic and driving situation. You can otherwise endanger yourself or others by unintentionally triggering sudden acceleration or braking.

- ▶ Briefly pull the cruise control lever towards you **④**.
- ▶ Remove your foot from the accelerator pedal.
DISTRONIC PLUS is activated. The first time it is activated, the current speed is stored. Otherwise, it sets the vehicle cruise speed to the previously stored value.

Setting the specified minimum distance

You can set the specified minimum distance for DISTRONIC PLUS by varying the time span between one and two seconds. With this function, you can set the minimum distance that DISTRONIC PLUS keeps to the vehicle in front, dependent on vehicle speed. You can see this distance in the multifunction display (▷ page 354).



- ▶ **To increase:** turn control ② in direction ③.
DISTRONIC PLUS then maintains a greater distance between your vehicle and the vehicle in front.
 - ▶ **To decrease:** turn control ② in direction ①.
DISTRONIC PLUS then maintains a shorter distance between your vehicle and the vehicle in front.
- i** Make sure that you maintain a sufficient and safe distance from the vehicle in front. Adjust the distance to the vehicle in front if necessary.

Displaying DISTRONIC PLUS in the speedometer



When you switch on DISTRONIC PLUS, triangle ② shows the stored speed.

- i** For design reasons, the speed displayed in the speedometer may differ slightly from the speed set for DISTRONIC PLUS.

If DISTRONIC PLUS detects a vehicle in front, the speedometer dial lights up between speed of the vehicle in front ① and stored speed ②.

Displaying DISTRONIC PLUS in the multifunction display

General notes

In the Assistance menu (▷ page 404) of the on-board computer, you can select the distance display.

Display when DISTRONIC PLUS is deactivated

- ▶ Select the **Distance display** function using the on-board computer (▷ page 404).

When DISTRONIC PLUS is deactivated, you will see the following in the multifunction display:



- ① Symbol for activated PRE-SAFE® Brake
- ② Vehicle in front, if detected
- ③ Distance indicator: current distance to the vehicle in front
- ④ Specified minimum distance to the vehicle in front; adjustable
- ⑤ Own vehicle

Display when DISTRONIC PLUS is activated

- ▶ Select the **Distance display** function using the on-board computer (▷ page 404).

You will see the stored speed for about five seconds when you activate DISTRONIC PLUS. After this time, you will see the following in the multifunction display while DISTRONIC PLUS is activated:



- ① DISTRONIC PLUS activated
- ② Own vehicle
- ③ Specified minimum distance to the vehicle in front; adjustable
- ④ Vehicle in front, if detected

Deactivating DISTRONIC PLUS



There are several ways to deactivate DISTRONIC PLUS:

- ▶ Briefly press the cruise control lever forwards ①.
 - or
 - ▶ Brake, unless the vehicle is stationary.
 - or
 - ▶ Briefly press the cruise control lever in the direction of arrow ③.
- Variable SPEEDTRONIC is selected. LIM indicator lamp ② in the cruise control lever lights up.

When you deactivate DISTRONIC PLUS, the **DISTRONIC PLUS off** message is shown in the multifunction display for approximately five seconds.

- ❗ The last speed stored remains stored until you switch off the engine.

DISTRONIC PLUS is automatically deactivated if:

- you engage the electric parking brake or if the vehicle is automatically secured with the electric parking brake.
- you are driving slower than 25 km/h and there is no vehicle in front, or if the vehicle in front is no longer detected.
- ESP® intervenes or if you deactivate ESP®.
- the transmission is in the **P**, **R** or **N** position.
- the vehicle is near a radio telescope facility (only vehicles with COMAND and a navigation system (▷ page 545)).

- you switch off the radar sensor system (▷ page 408).
- you pull the cruise control lever towards you in order to pull away, and the front-passenger door or one of the rear doors is open.
- the vehicle has skidded.

If DISTRONIC PLUS is deactivated, you will hear a warning tone. The **DISTRONIC PLUS off** message is shown in the multifunction display for approximately five seconds.

Tips for driving with DISTRONIC PLUS

General notes

The following contains descriptions of certain road and traffic conditions in which you must be particularly attentive. In such situations, brake if necessary. DISTRONIC PLUS is then deactivated.

Cornering, going into and coming out of a bend

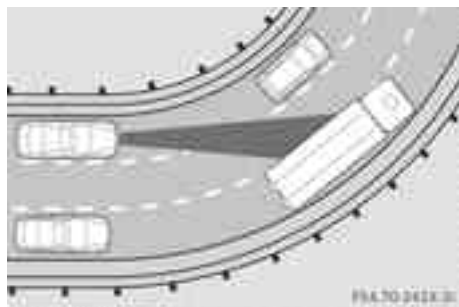

The ability of DISTRONIC PLUS to detect vehicles when cornering is limited. Your vehicle may brake unexpectedly or late.

Vehicles travelling on a different line

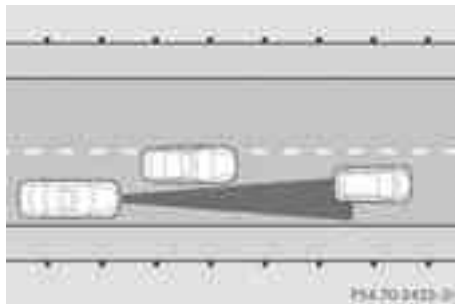

DISTRONIC PLUS may not detect vehicles travelling on a different line. The distance to the vehicle in front will be too short.

Other vehicles changing lane

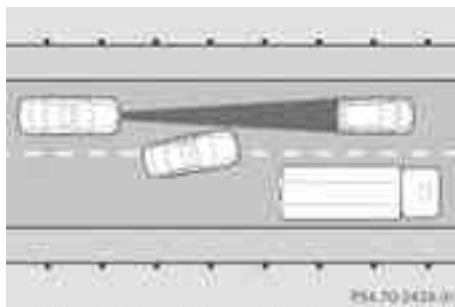

DISTRONIC PLUS has not detected the vehicle cutting in yet. The distance to this vehicle will be too short.

Narrow vehicles

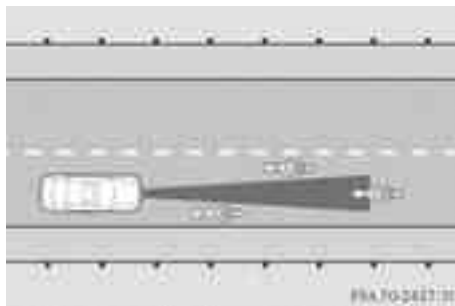

DISTRONIC PLUS has not yet detected the vehicle in front on the edge of the carriage-

way, because of its narrow width. The distance to the vehicle in front will be too short.

Obstructions and stationary vehicles

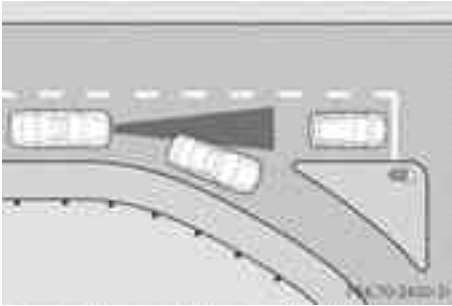

DISTRONIC PLUS does not brake for obstacles or stationary vehicles. If, for example, the detected vehicle turns a corner and reveals an obstacle or stationary vehicle, DISTRONIC PLUS will not brake for these.

Crossing vehicles

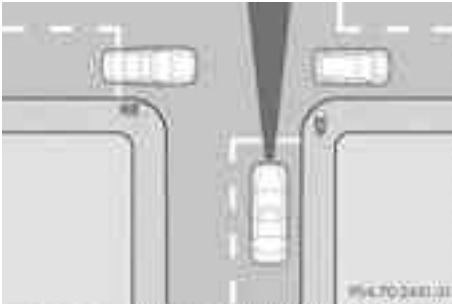

DISTRONIC PLUS may detect vehicles that are crossing your lane by mistake. Activating DISTRONIC PLUS at traffic lights with crossing traffic, for example, could cause your vehicle to pull away unintentionally.

HOLD function

General notes

The HOLD function can assist the driver in the following situations:

- when pulling away, especially on steep slopes
- when manoeuvring on steep slopes
- when waiting in traffic

The vehicle is kept stationary without the driver having to depress the brake pedal.

The braking effect is cancelled and the HOLD function is deactivated when you depress the accelerator pedal to pull away.

Activation conditions

You can activate the HOLD function if:

- the vehicle is stationary.
- the engine is running or if it has been automatically switched off by the ECO start/stop function.
- the driver's door is closed or if your seat belt is fastened.
- the electric parking brake is released.
- the bonnet is closed.
- the transmission is in position **R**, **N** or **D**. The boot lid must be closed in position **R**.
- DISTRONIC PLUS is deactivated.

Activating the HOLD function

- ▶ Make sure that the activation conditions are met.
- ▶ Depress the brake pedal.
- ▶ Quickly depress the brake pedal further until **HOLD** appears in the instrument cluster. The HOLD function is activated. You can release the brake pedal.

- i** If depressing the brake pedal the first time does not activate the HOLD function, wait briefly and then try again.

⚠ WARNING

The vehicle's brakes are applied when the HOLD function is activated. For this reason, deactivate the HOLD function if the vehicle is to be set in motion by other means (e.g. in a car wash or by towing).

Deactivating the HOLD function

The HOLD function is deactivated automatically if:

- you accelerate and the transmission is in position **D** or **R**.
- you shift the transmission to position **P**.
- you apply the brakes again with a certain amount of pressure until **HOLD** disappears from the instrument cluster.
- you secure the vehicle using the electric parking brake.
- you activate DISTRONIC PLUS.

- **i** After a time, the electric parking brake secures the vehicle and relieves the service brake.

⚠ WARNING

Never get out of the vehicle when the HOLD function is activated.

The HOLD function must never be operated or deactivated by a passenger or from outside the vehicle.

The HOLD function does not replace the electric parking brake and must not be used for parking.

The braking effect of the HOLD function is cancelled and the vehicle could roll away if:

- the HOLD function is deactivated by depressing the accelerator pedal or the brake pedal.
- there is a malfunction in the system or an interruption in the power supply, e.g. battery failure.

- the electrical system in the engine compartment, the battery or the fuses are tampered with.

- the battery is disconnected.

If you leave the vehicle or park it, deactivate the HOLD function and secure the vehicle against rolling away.

AIRMATIC**Vehicle level****Important safety notes**

Your vehicle regulates its height automatically. All-round level control ensures the best possible suspension and constant ground clearance, even with a laden vehicle. When you drive fast, the vehicle is lowered automatically to improve driving safety and to reduce fuel consumption.

The following vehicle levels are possible on vehicles without 4MATIC:

- normal
- raised: the vehicle is raised by about 30 mm when compared with the normal level.
- lowered: the vehicle is lowered by about 20 mm when compared with the normal level.

The following vehicle levels are possible on vehicles with 4MATIC:

- normal: in comfort mode, the vehicle is raised by about 10 mm when compared with sports mode.
- raised: in comfort mode, the vehicle is raised by about 30 mm and in sports mode by about 40 mm when compared with the normal vehicle level.
- lowered: in comfort mode, the vehicle is lowered by about 20 mm and in sports mode by about 10 mm when compared with the normal vehicle level.

The "Normal" and "Raised" vehicle levels can be set manually.

The "Lowered" vehicle level is set automatically:

- on vehicles without 4MATIC at speeds of over 100 km/h
- on vehicles with 4MATIC at speeds of over 80 km/h

Setting the vehicle level

Select the "Normal" setting for normal road surfaces and "Raised" for driving with snow chains or on particularly poor road surfaces. Your selection remains stored even if you remove the key from the ignition lock.

WARNING

Make sure that nobody is in the vicinity of the wheel housing or under the vehicle while lowering the vehicle when it is stationary. Otherwise, limbs could become trapped.



Setting raised level

- ▶ Start the engine.

If indicator lamp ② is not lit:

- ▶ Press button ①.
Indicator lamp ② lights up. The vehicle height is adjusted to raised level.

The **Vehicle rising** message appears in the display.

The "Raised Level" setting is cancelled if you:

- drive at a speed over approximately 120 km/h
- drive for approximately three minutes at a speed over 80 km/h.

The "Raised Level" remains saved when you are not driving within these speed ranges.

Setting the normal level

- ▶ Start the engine.

If indicator lamp ② is lit:

- ▶ Press button ①.
Indicator lamp ② goes out. The vehicle is adjusted to normal level.

Suspension tuning

General notes

The Adaptive Damping System (ADS) automatically controls the calibration of the dampers and springs.

The damping is tuned individually to each wheel and depends on:

- your driving style, e.g. sporty
- the road surface condition, e.g. bumps
- your individual selection, i.e. sports or comfort

Your selection remains stored even if you remove the key from the ignition lock.



Sports tuning

The firmer suspension tuning in Sport mode ensures even better contact with the road. Select this mode when employing a sporty driving style, e.g. on winding country roads.

- ▶ **If indicator lamp ② is not lit:** press button ①.
Indicator lamp ② lights up. You have selected "Sports tuning".

The **AIRMATIC SPORT** message appears in the multifunction display.

Comfort tuning

In comfort mode, the driving characteristics of your vehicle are more comfortable. Therefore, select this mode if you prefer a more comfortable driving style. Select comfort mode also when driving fast on straight roads, e.g. on straight stretches of motorway.

► If indicator lamp ② is lit: press button ①.

Indicator lamp ② goes out. You have selected "Comfort tuning".

The **AIRMATIC COMFORT** message appears in the multifunction display.

Active Body Control (ABC)

Vehicle level

Your vehicle automatically adjusts its ride height to improve driving safety and reduce fuel consumption.

Depending on the vehicle height that has been set, the vehicle automatically adjusts its height dependent on the current speed. The vehicle is lowered by up to 15 mm as the speed increases. As the speed is reduced, the vehicle is raised up to the set vehicle height.

WARNING

AMG vehicles:

The vehicle is lowered when the engine is switched off. Therefore, make sure that nobody is in the vicinity of the wheel housing or under the vehicle. Otherwise, limbs could become trapped.

! AMG vehicles:

The vehicle is lowered by about 10 mm when the engine is switched off. When parking, position your vehicle so that it does not make contact with the kerb as the vehicle is lowered. Your vehicle could otherwise be damaged.

Setting the vehicle level

Select the "Normal" setting for normal road surfaces and "Raised" for driving with snow chains or on particularly poor road surfaces.

WARNING

Make sure that nobody is in the vicinity of the wheel housing or under the vehicle while lowering the vehicle when it is stationary. Otherwise, limbs could become trapped.

Your selection remains stored even if you remove the key from the ignition lock.



Setting raised level

► Start the engine.

If indicator lamp ② is not lit:

► Press button ①.

Indicator lamp ② lights up. The vehicle height is adjusted to raised level.

Setting the normal level

► Start the engine.

If indicator lamp ② is lit:

► Press button ①.

Indicator lamp ② goes out. The vehicle is adjusted to normal level.

Suspension tuning

The electronically controlled ABC suspension system works continuously. This improves driving safety and comfort.

The ABC suspension system is tuned individually to each wheel and depends on:

- your driving style, e.g. sporty
- the road surface condition, e.g. bumps
- your individual selection, i.e. sports or comfort
- the vehicle load

Your selection remains stored even if you remove the key from the ignition lock.



Sports tuning

The firmer suspension tuning in Sport mode ensures even better contact with the road. Select this mode when employing a sporty driving style, e.g. on winding country roads.

► **If indicator lamp ② is not lit:** press button ①.

Indicator lamp ② lights up. You have selected the suspension for a sporty driving style.

The **ABC Active Body Control SPORT** message appears in the multifunction display.

Comfort tuning

In comfort mode, the driving characteristics of your vehicle are more comfortable. Therefore, select this mode if you prefer a more comfortable driving style.

► **If indicator lamp ② is lit:** press button ①.

Indicator lamp ② goes out. You have selected the suspension for a comfortable driving style.

The **ABC Active Body Control COMFORT** message appears in the multifunction display.

4MATIC (permanent all-wheel drive)

4MATIC ensures that all four wheels are permanently driven. Together with ESP®, it improves the traction of your vehicle whenever a drive wheel spins due to insufficient grip.

⚠ WARNING

4MATIC cannot reduce the risk of an accident if you drive too fast.

If a drive wheel spins due to insufficient grip:

- only depress the accelerator pedal as far as necessary when pulling away.
- accelerate less when driving.
- adapt your driving style to suit road and traffic conditions.

❗ Never tow the vehicle with one axle raised. This may damage the transfer case. Damage of this sort is not covered by the Mercedes-Benz implied warranty. All wheels must remain either on the ground or be fully raised. Observe the instructions for towing the vehicle with all wheels in full contact with the ground.

ℹ In wintry driving conditions, the maximum effect of 4MATIC can only be achieved if you use winter tyres (M+S tyres), with snow chains if necessary.

PARKTRONIC

Important safety notes

⚠ WARNING

PARKTRONIC is only an aid and may not detect all obstacles. It is not a substitute for attentive driving.

You are always responsible for safety and must continue to pay attention to your imme-

diate surroundings when parking and manoeuvring. You could otherwise endanger yourself and others.

⚠ WARNING

Make sure that no persons or animals are in the manoeuvring range. Otherwise, they could be injured.

PARKTRONIC is an electronic parking aid with ultrasonic sensors. It indicates visually and audibly the distance between your vehicle and an object.

PARKTRONIC is activated automatically if you:

- switch on the ignition
- shift the transmission to position **D**, **R** or **N**
- release the electric parking brake

PARKTRONIC is deactivated at speeds above 18 km/h. It is reactivated at lower speeds.

PARKTRONIC monitors the area around your vehicle using six sensors in the front and four sensors in the rear.



- ① Example: sensors in the front bumper, left-hand side

Range of the sensors

General notes

The sensors must be free of dirt, ice and slush. Otherwise, they may not function correctly. Clean the sensors regularly, taking care not to scratch or damage them (▷ page 487).

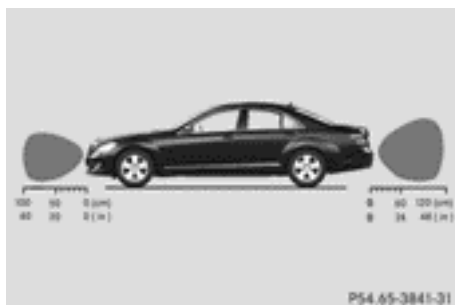

Side view



Top view

Front sensors

Centre	approximately 100 cm
Corners	approximately 60 cm

Rear sensors

Centre	approximately 120 cm
Corners	approximately 80 cm

⚠ When parking, pay particular attention to objects above or below the sensors, such as flower pots or trailer drawbars. PARKTRONIC does not detect such objects when they are in the immediate vicinity of the vehicle. You could damage the vehicle or the objects.

The sensors may not detect snow and objects which absorb ultrasonic sources. Ultrasonic sources, such as an automatic car wash, a lorry's compressed-air brakes or a pneumatic drill, could cause PARKTRONIC to malfunction.

PARKTRONIC may not function correctly on uneven terrain.

Minimum distance

Centre	approximately 20 cm
Corners	approximately 20 cm

If there is an obstacle within this range, the relevant warning displays light up and a warning tone sounds. If the distance falls below the minimum, the distance may no longer be shown.

Warning displays

The warning displays show the distance between the sensors and the obstacle. The warning display for the front area is in the instrument cluster. The warning display for the rear area is located on the roof lining in the rear compartment.



Warning display for the front area

- ① Segments on the left-hand side of the vehicle
- ② Segments on the right-hand side of the vehicle
- ③ Segments showing operational readiness

The warning display for each side of the vehicle is divided into five yellow and two red segments. PARKTRONIC is operational if yellow segments showing operational readiness ③ light up.

The selected transmission position determines which warning display is active when the engine is running.

Transmission position	Warning display
D	Front area activated
R	Rear and front areas activated
N	If the electric parking brake is engaged: no areas are activated If the electric parking brake is released: rear and front areas are activated
P	No areas activated

One or more segments light up as the vehicle approaches an obstacle, depending on the vehicle's distance from the obstacle.

When the first red segment lights up, you hear an intermittent warning for about two seconds. From the second red segment, you hear a continuous warning. This indicates that you have now reached the minimum distance.

Deactivating/activating PARKTRONIC



- ① To deactivate/activate PARKTRONIC
- ② Indicator lamp

If indicator lamp ② lights up, PARKTRONIC is deactivated.

- i** PARKTRONIC is automatically activated when you turn the key to position **2** in the ignition lock.

Towing a trailer

PARKTRONIC is deactivated for the rear area when you establish an electrical connection between your vehicle and a trailer.

! Fold in the ball coupling if the trailer tow hitch is not required. PARKTRONIC measures the minimum detection range to an obstacle from the bumper, not the ball coupling.

Problems with PARKTRONIC

Problem	Possible causes/consequences and ► Solutions
<p>Only the red segments in the PARKTRONIC warning displays are lit. You also hear a warning tone for approximately two seconds.</p> <p>PARKTRONIC is deactivated after approximately 20 seconds, and the indicator lamp in the PARKTRONIC button lights up.</p>	<p>PARKTRONIC has malfunctioned and has switched off.</p> <ul style="list-style-type: none"> ► If problems persist, have PARKTRONIC checked at a qualified specialist workshop.
<p>Only the red segments in the PARKTRONIC warning displays are lit. PARKTRONIC is deactivated after approximately 20 seconds.</p>	<p>The PARKTRONIC sensors are dirty or there is interference.</p> <ul style="list-style-type: none"> ► Clean the PARKTRONIC sensors (▷ page 487). ► Switch the ignition back on. <p>The problem may be caused by an external source of radio or ultrasound waves.</p> <ul style="list-style-type: none"> ► See if PARKTRONIC functions in a different location.

Parking Guidance

Important safety notes

Parking Guidance is an electronic parking aid with ultrasound. Ultrasound is used to measure the road on both sides of the vehicle. A suitable parking space is indicated by the parking symbol. You receive steering instructions when parking. You may also use PARKTRONIC (▷ page 361).

WARNING

Parking Guidance is merely an aid and may recommend parking spaces that are not suitable for parking. For example, these might be spaces where parking is prohibited, driveways, unsuitable surfaces, etc.

Parking Guidance measures the parking space as you drive past it. Any later changes to the parking space are not taken into account. For instance, this may be the case

when the vehicle parked in front of or behind the space changes its position or when an obstacle is moved into the parking space.

Parking Guidance does not relieve you of the responsibility for paying attention. If you rely solely on Parking Guidance, you could cause an accident and injure yourself and others.

You are always responsible for safety and must continue to pay attention to your immediate surroundings when parking and manoeuvring.

WARNING

Objects located above the height range of Parking Guidance will not be detected when the parking space is measured. These are not taken into account when the parking procedure is calculated, e.g. overhanging loads, tail sections or loading ramps of goods vehicles. In some circumstances, Parking Guidance

might therefore issue steering instructions too soon. This may lead to a collision. For this reason, you should avoid using Parking Guidance in such situations.

⚠ WARNING

Make sure that no persons or animals are in the manoeuvring range. Otherwise, they could be injured.

When PARKTRONIC is deactivated, Parking Guidance is also unavailable.

Use Parking Guidance for parking spaces:

- that are parallel to the direction of travel
- that are on straight roads, not bends
- that are on the same level as the road, i.e. not on the pavement, for example. Parking Guidance may not detect flat kerbs

Parking tips:

- on narrow roads, drive as closely as possible past the parking space.
- parking spaces that are littered, overgrown or partially occupied by trailer drawbars might be identified incorrectly or not at all.
- snowfall or heavy rain may lead to a parking space being measured inaccurately.
- pay attention to the PARKTRONIC (▷ page 363) warning messages during the parking procedure.
- when transporting a load which protrudes from your vehicle, you must not use Parking Guidance.
- never use Parking Guidance with snow chains or an emergency spare wheel fitted.
- make sure that the tyre pressures are always correct. This has a direct effect on the steering instructions.
- the way your vehicle is positioned in the parking space after parking is dependent on various factors. These include the position and shape of the vehicles parked in front and behind it and the conditions of the location. In some cases, Parking Guidance may guide you too far or not far enough into a parking space. In some cases, it may also

lead you across or onto the kerb. If necessary, cancel the parking procedure with Parking Guidance.

- ❗ If unavoidable, you should drive over obstacles such as kerbs slowly and not at a sharp angle. Otherwise, you may damage the wheels or tyres.

Detecting parking spaces



- ① Detected parking space on the left
- ② Parking symbol
- ③ Detected parking space on the right

Parking Guidance is automatically activated when you drive forwards. The system is operational at speeds of up to approximately 35 km/h. While in operation, the system independently locates and measures parking spaces on both sides of the vehicle. At speeds below 30 km/h, you see white parking symbol ② in the instrument cluster as a status indicator. Parking Guidance only shows parking spaces on the passenger side in the default setting. Parking spaces on the driver's side are displayed as soon as the turn signal on the driver's side is activated. To park on the driver's side, you must leave the driver's side turn signal switched on until you have engaged reverse gear. If a parking space is detected, parking symbol ② changes to blue. Additionally, an arrow pointing to the right ③ or left ① is shown.

Parking Guidance will only detect parking spaces:

- that are closed in at the back
- that are parallel to the direction of travel

- that are at least 1.5 m wide
- that are at least 1.3 m longer than your vehicle

A parking space is displayed while you are driving past it, and until you are approximately 15 m away from it.

Parking

The following instructions refer to parking in a space on the front-passenger side. To park in a space on the driver's side, mirror the instructions.

WARNING

PARKTRONIC and Parking Guidance are merely parking aids and may not detect all obstacles. They do not relieve you of the responsibility of paying attention.

You are always responsible for safety and must continue to pay attention to your immediate surroundings when parking and manoeuvring. You could otherwise endanger yourself and others.

- ▶ Stop the vehicle when the blue parking space symbol shows the desired parking space in the instrument cluster.
- ▶ Engage reverse gear.
The multifunction display shows the message: **Check surroundings Confirm with OK.**
- ▶ Press **OK** on the multifunction steering wheel to confirm.
The display in the instrument cluster switches to Parking Guidance.

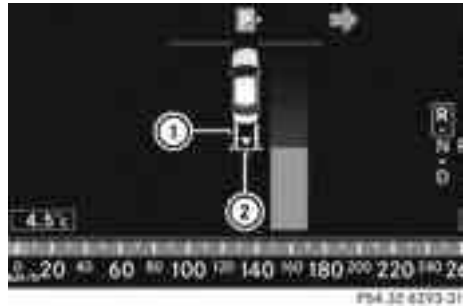

- ① Green lane
 - ② White bracket marking the target position
- ▶ Depending on the distance, you may have to reverse along the lane towards the parking space. This is indicated by green lane ①.
Continue reversing until you hear a tone. Stop; the parking position has been reached and is marked by white bracket ② with an arrow for the target position.

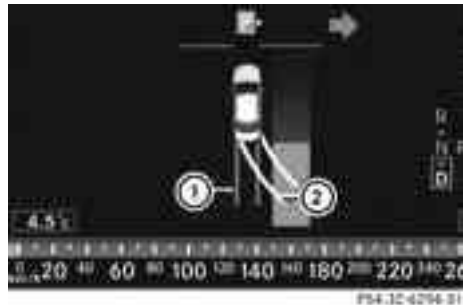

Steering tips

- ① Red lane indicating the route the vehicle will take with the steering wheel in its current position
 - ② Yellow lane indicating the route the vehicle will take when you have turned the steering wheel in the required direction
- ▶ Turn the steering wheel while the vehicle is stationary until red lane ① and yellow lane ② overlap.
Lane ② is then marked in green and you hear a tone. If the parking space is inside the area displayed, the end of the green

lane is marked with a white bracket and an arrow showing the target position.

Reversing into a parking space

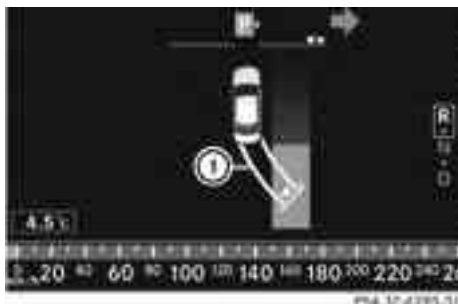

- ① Lane turns green when the steering wheel is turned in the correct direction
- ▶ Keep the steering wheel in that position and reverse carefully.
- ▶ Stop as soon as you hear a tone. The vehicle has reached the position in which you need to countersteer.

Countersteering

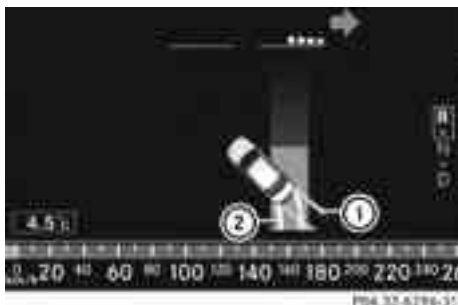

- ① Red lane indicating the route the vehicle will take with the steering wheel in its current position
- ② Yellow lane indicating the route the vehicle will take when you have turned the steering wheel in the required direction
- ▶ Turn the steering wheel while the vehicle is stationary until red lane ① and yellow lane ② overlap. Lane ② is then marked in green and you hear a tone. A white arrow and white

bracket are shown to indicate the target position.

Driving to the final position

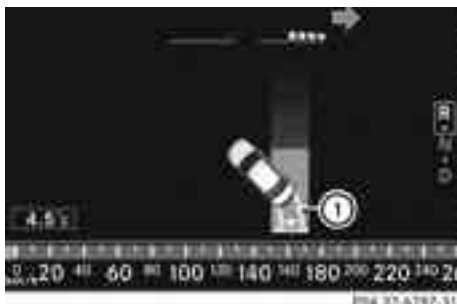

- ① Lane turns green when the steering wheel is turned in the correct direction
- ▶ Keep the steering wheel turned in that direction and reverse carefully until you have reached the final position. The **Parking Guidance finished** message appears in the multifunction display and a tone sounds.

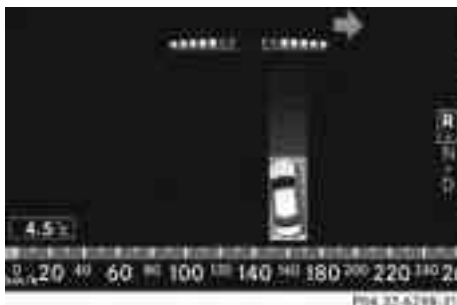

Final position

Depending on the size of the parking space, you may now be in an angled position in the parking space. If possible, Parking Guidance will guide you as far back as possible towards the rear limit of the parking space.

- ▶ Manoeuvre if necessary.
- ▶ Always observe the warning messages displayed by PARKTRONIC (▶ page 363).

Cancelling Parking Guidance

- ▶ Press the PARKTRONIC button on the dashboard (▷ page 363).

Parking Guidance is cancelled immediately and PARKTRONIC is deactivated.

Parking Guidance is cancelled automatically if it is no longer possible to guide you into the parking space, or if a malfunction occurs.

The parking space symbol goes out and a warning tone sounds. The **Parking Guidance cancelled** message appears in the multifunction display.

Towing a trailer

For vehicles with a trailer tow hitch, the minimum length for parking spaces is slightly increased.

If you have attached a trailer to your vehicle, you should not use Parking Guidance. When the electrical connection is established between your vehicle and the trailer, Parking Guidance ceases to be available. PARKTRONIC is deactivated for the rear area.

Reversing camera

Important safety notes

The reversing camera is an optical parking aid. It shows the area behind your vehicle in the COMAND display.

WARNING

Make sure that no persons or animals are in the manoeuvring range. Otherwise, they could be injured.

The reversing camera is located in the handle strip of the boot lid.



① Reversing camera

View through the camera

The area behind the vehicle is displayed as a mirror image, as in the rear-view mirror.

WARNING

The reversing camera is only an aid and may display obstacles in a distorted or incorrect manner, or may not even display them at all. The reversing camera does not relieve you of the responsibility to pay attention. The camera cannot show objects:

- very near to the rear bumper
- below the rear bumper
- in the area immediately above the boot lid handle

You are always responsible for safety and must continue to pay attention to your immediate surroundings when parking and manoeuvring. This applies to the areas behind, in front of and next to the vehicle. You could otherwise endanger yourself and others.

WARNING

Under the following circumstances, the reversing camera will not function, or will function in a limited manner:

- if the boot lid is open
- in heavy rain, snow or fog
- at night or in very dark places
- if the camera is exposed to very bright light

- if the area is lit by fluorescent light (the display may flicker)
- if there is a sudden change in temperature, e.g. when driving into a heated garage in winter
- if the camera lens is dirty or obstructed
- if the rear of your vehicle is damaged. In this event, have the camera position and setting checked at a qualified specialist workshop. Mercedes-Benz recommends that you use a Mercedes-Benz Service Centre for this purpose.

Do not use the reversing camera in these types of situation. You could otherwise injure others or damage objects and your vehicle while you are parking.

Activating the reversing camera

- ▶ Make sure that the key is in position **2** in the ignition lock.
- ▶ Engage reverse gear.
The area behind the vehicle is shown with guide lines in the COMAND display.

Guide lines in the COMAND display

WARNING

Using the reversing camera can be dangerous if you are colour blind or your ability to distinguish colours is impaired.

Only use the reversing camera if you can see and distinguish between all the coloured guide lines that are displayed by the reversing camera in the COMAND display.

WARNING

Please note that objects not at ground level may appear to be further away than they actually are. These include:

- the bumper of a vehicle that is parked behind your vehicle
- a trailer drawbar
- the ball coupling of a trailer tow hitch

- the tail-end of a lorry
- slanted posts

The lines are only guides, not accurate measurements of the distance to an obstacle.

Therefore, you should never pass the red line when approaching an obstacle. You could otherwise cause an accident and injure yourself and others.



Information in the COMAND display (example)
Guide lines **②** and **③** show the approximate distance to the rear area. Yellow guide line **②** approximately 1.0 m and red guide line **③** approximately 0.25 m. The distances only apply to objects that are at ground level. Blue guide lines **①** depict the width required for the vehicle. They are used to align the vehicle with the edge of the carriageway, e.g. the kerb.

ATTENTION ASSIST

Important safety notes

- i** ATTENTION ASSIST is only available for vehicles without HYBRID.

ATTENTION ASSIST helps you during long, monotonous journeys such as on motorways and trunk roads. It is active in the 80 km/h to 180 km/h range.

If ATTENTION ASSIST detects typical indicators of fatigue or increasing lapses in concentration on the part of the driver, it suggests taking a break.

WARNING

ATTENTION ASSIST is only an aid and may detect your tiredness or lapses in concentration too late or not at all. It is not a substitute for a well rested and attentive driver.

Fatigue may cause you to recognise hazardous situations too late, misjudge a situation or react slower. For this reason, make sure you feel rested before you begin driving and during your journey. Always take breaks in good time and regularly, especially during long journeys. Otherwise, you may fail to recognise dangers in time, cause an accident and injure yourself and others.

ATTENTION ASSIST assesses your level of fatigue or lapses in concentration by taking the following criteria into account:

- your personal driving style, e.g. steering characteristics
- journey-related parameters, e.g. time of day, length of journey

The functionality of ATTENTION ASSIST is restricted, and warnings may be delayed or not occur at all:

- if the road condition is poor, e.g. if the surface is uneven or if there are potholes
- if there is a strong side wind
- if you have adopted a sporty driving style with high cornering speeds or high rates of acceleration
- if you are predominantly driving slower than 80 km/h or faster than 180 km/h
- if you are currently using COMAND or making a telephone call with COMAND
- if the time has been set incorrectly
- in active driving situations, such as when you change lanes or change your speed

Warning and display messages in the multifunction display



- ▶ Activate ATTENTION ASSIST using the on-board computer (▷ page 405). Symbol  appears in the multifunction display.

If ATTENTION ASSIST is active, you will be warned no sooner than 20 minutes after your journey has begun. You will then hear an intermittent warning tone twice, and the **Attention Assist: Time for a break?** message appears in the multifunction display.

- ▶ If necessary, take a break.
- ▶ Press the  button to confirm the message.

On long journeys, take regular breaks in good time to allow yourself to rest properly. If you do not take a break, you will be warned again after 15 minutes at the earliest. This will only happen if ATTENTION ASSIST still detects typical indicators of fatigue or increasing lapses in concentration.

ATTENTION ASSIST is reset and starts assessing your tiredness again when you continue your journey if:

- you switch off the engine.
- you take off your seat belt and open the driver's door, e.g. for a change of drivers or to take a break.

Speed Limit Assist

Important safety notes

Speed Limit Assist shows you detected speed limits in the multifunction display. Data from the navigation system is also used for this

purpose. If a traffic sign indicating a speed limit or the end of a speed limit is detected, it is shown in the multifunction display. If Speed Limit Assist does not detect any traffic signs, the speed limit from the digital road map is taken and shown in the display.

Speed Limit Assist detects the traffic signs with a camera attached behind the top of the windscreen.



① Speed Limit Assist camera

WARNING

Speed Limit Assist is only an aid and may detect speed limit signs incorrectly or not at all.

The system may be impaired or may not function if:

- there is poor visibility, e.g. due to snow, rain, fog or spray.
- there is glare, e.g. from the sun or from oncoming traffic.
- the windscreen is dirty, misted up or covered, for instance by a sticker, in the vicinity of the camera.
- the traffic signs are covered, for instance by dirt, snow or trees.
- the traffic signs are poorly illuminated.
- there are ambiguous traffic signs, for instance near roadworks or on multi-lane roads.

Traffic signs always have priority over the Speed Limit Assist display. Speed Limit Assist cannot detect road and traffic conditions. It is not a substitute for attentive driving.

Always pay attention to traffic conditions and your surroundings. Otherwise, you may fail to recognise dangers in time, cause an accident and injure yourself and others.

Information in the multifunction display



- ① Speed Limit Assist is available and the warning function is switched on in the on-board computer
- ② Traffic sign indicating a speed limit or the end of a speed limit (example)
- ③ Units used in the traffic sign displayed

Briefly showing detected traffic signs in the multifunction display

- ▶ Activate the Speed Limit Assist warning function using the on-board computer (▷ page 404).
Symbol ① appears.

A traffic sign indicating a speed limit or the end of a speed limit ② appears in the multifunction display for around five seconds as soon as it is detected. Any other information in the multifunction display is hidden for this period.

Permanently showing detected traffic signs in the multifunction display

- ▶ Display Speed Limit Assist using the on-board computer (▷ page 404).
A traffic sign indicating a speed limit or the end of a speed limit ② appears in the multifunction display as soon as it is detected. Traffic sign indicating a speed limit ② is generally displayed until:
 - a traffic sign indicating the end of the speed limit is detected.
 - you make a turn.
 - you leave or enter a town.

- the road type changes (e.g. motorway, country road).
- you have travelled a certain minimum distance without the traffic sign being repeated or detected again.

i You can also activate Speed Limit Assist using COMAND APS. The maximum permissible speed is then shown in the COMAND display; see the COMAND APS description.

Night View Assist Plus

Important safety notes

In addition to the illumination provided by the normal headlamps, Night View Assist Plus uses infrared light to illuminate the road. The Night View Assist Plus camera picks up the infrared light and displays a black and white image in the multifunction display. The image shown in the multifunction display corresponds to a road lit up by main-beam headlamps. This enables you to see the road's course and any obstacles in good time. When pedestrian recognition is active, pedestrians recognised by the system are highlighted in the Night View Assist Plus display.

⚠ WARNING

Night View Assist Plus is only an aid designed to assist driving and does not relieve you of the responsibility to pay attention. Continue to look through the windscreen instead of relying on the Night View Assist Plus display. You are responsible for safety and must drive in accordance with traffic conditions. You could otherwise endanger yourself and others.

The system may be impaired or may not function if:

- there is poor visibility, e.g. due to snow, rain, fog or spray.
- the windscreen is dirty, misted up or covered, for instance by a sticker, in the vicinity of the camera.
- on bends, on uphill gradients or downhill gradients.

Light from the headlamps of oncoming vehicles does not affect the Night View Assist Plus display in the multifunction display. This is also the case if you cannot switch on the main-beam headlamps due to oncoming traffic.

⚠ WARNING

Night View Assist Plus does not detect objects in the immediate vicinity of the vehicle. Look through the windscreen when manoeuvring. Make sure that there are no people or animals in the area in which you are manoeuvring.

i Infrared light is not visible to the human eye and therefore does not dazzle. Night View Assist Plus can therefore remain switched on even if there is oncoming traffic.



① Night View Assist Plus camera

Activating Night View Assist Plus



You can only activate Night View Assist Plus if:

- the key is in position **2** in the ignition lock.
- it is dark.
- the light switch is in the **A** or **HD** position.
- reverse gear has not been engaged.

▶ Press button **1**.

The Night View Assist Plus display appears in the multifunction display.



- 1 Night View Assist Plus display
- 2 Pedestrian recognised
- 3 Framing
- 4 Symbol for active pedestrian recognition
- 5 Speed display

i The infrared headlamps only switch on when the vehicle is being driven at speeds of at least 10 km/h. This means that you do not have the full visual range while stationary and cannot check whether Night View Assist Plus is working.

When you activate Night View Assist Plus, speed display **5** in the multifunction display changes. Speed display **5** is shown as a bar at the bottom edge of the multifunction display. This line is no longer available for basic menus. You have to deactivate Night View Assist Plus if you want to change a setting using the buttons on the multifunction steering wheel.

Pedestrian recognition

! WARNING

Pedestrian recognition may be impaired or inoperative if:

- pedestrians are partially or entirely obscured by objects, e.g. by parked vehicles.
- the silhouette of the pedestrian in the Night View Assist Plus display is incomplete or interrupted, e.g. by powerful light reflections.
- pedestrians do not contrast with the surroundings.
- pedestrians are not in an upright position, e.g. sitting, squatting or lying.

i Animals are not recognised by pedestrian recognition.

Night View Assist Plus can recognise pedestrians using typical characteristics, e.g. when there is a silhouette in the shape of a person. Pedestrian recognition is then switched on automatically if:

- Night View Assist Plus is activated.
- you are driving faster than about 10 km/h.
- the surroundings are dark, e.g. when driving outside built-up areas without street lighting.

If pedestrian recognition is active, symbol **4** appears. If a pedestrian is now recognised, they are framed **3** and thereby highlighted. If the pedestrian recognition system has brought a pedestrian to your attention, look through the windscreen to evaluate the

situation. The actual distance to objects and pedestrians cannot be gauged accurately by looking at a screen.

It may be the case that objects are highlighted as well as pedestrians.

Setting the brightness of the multifunction display

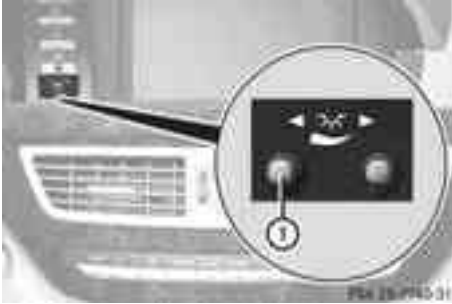

- ▶ **To make brighter or dimmer:** make sure that Night View Assist Plus is activated.
- ▶ Turn control ① anti-clockwise or clockwise.

Misted up or dirty windscreen

If the windscreen in front of the camera is misted up or dirty on the inside or outside, the Night View Assist Plus display is affected.

- ▶ **To demist:** check the automatic air conditioning settings (▷ page 310) and fold down the camera cover (▷ page 487).
- ▶ **To demist the inside of the windscreen:** fold down the camera cover (▷ page 487) and clean the windscreen (▷ page 485).

Problems with Night View Assist Plus

Problem	Possible causes/consequences and ► Solutions
The picture quality of Night View Assist Plus has deteriorated.	The windscreen wipers are smearing the windscreen. ► Replace the wiper blades (▷ page 300).
	The windscreen is smeared after the vehicle has been cleaned in a car wash. ► Clean the windscreen (▷ page 485).
	There is windscreen chip damage in the camera's field of vision. ► Replace the windscreen.
	The windscreen is misted up on the inside. ► Demist the windscreen (▷ page 310).
	The windscreen is iced up. ► De-ice the windscreen (▷ page 310).
	There is dirt on the inside of the windscreen. ► Clean the inside of the windscreen (▷ page 485).

Driving Assistance package

General notes

- i** The Driving Assistance package is only available on vehicles with HYBRID.

The Driving Assistance package consists of DISTRONIC PLUS (▷ page 348), Blind Spot Assist (▷ page 376) and Lane Keeping Assist (▷ page 378).

Blind Spot Assist

Important safety notes

Blind Spot Assist uses a radar sensor system to monitor the areas on both sides of your vehicle. It supports you from speeds of 30 km/h. A warning display in the exterior mirrors draws your attention to vehicles detected in the monitored area. If you then switch on the corresponding turn signal to change lane, you will also receive an optical and audible collision warning. For monitoring,

Active Blind Spot Assist uses sensors in the rear bumper.

WARNING

Blind Spot Assist is only an aid designed to assist driving. It may fail to detect some vehicles and is no substitute for attentive driving. Blind Spot Assist cannot detect road and traffic conditions. It may fail to detect narrow vehicles, such as motorcycles or bicycles, or only detect them too late.

Monitoring may be affected by dirty sensors, strong spray or poor visibility caused by snow, rain or mist, for example. In this case, vehicles are detected late or not at all.

Always pay attention to traffic conditions and your surroundings. Otherwise, you may fail to recognise dangers in time, cause an accident and injure yourself and others.

The radar sensor system is automatically deactivated near radio telescope facilities (▷ page 545).

For Blind Spot Assist to assist you when driving, the radar sensor system must be activated (▷ page 408) and operational.

Monitoring range of the sensors

Blind Spot Assist monitors the area up to three metres behind your vehicle and directly next to your vehicle, as shown in the diagram.

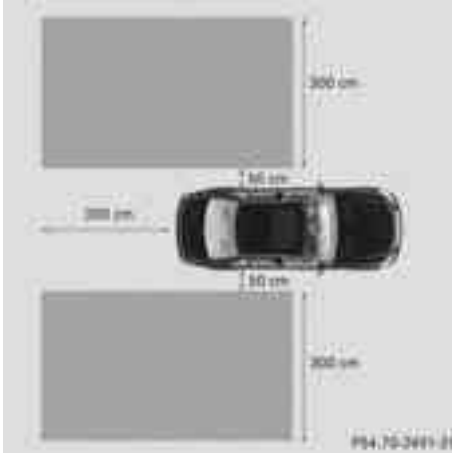

WARNING

Blind Spot Assist monitors certain areas in the immediate vicinity of your vehicle. Vehicles that approach and drive past at high speeds are not detected. There is no display and no warning.

If the lanes are very wide, it may not be possible to monitor the complete width of the neighbouring lane. For this reason, vehicles in the next lane may not be detected, especially if they are driving in a staggered formation in different lanes. This may be the case if vehicles are driving at the edge of their lane that is furthest away from your vehicle.

Always pay attention to traffic conditions and your surroundings. Otherwise, you may fail to recognise dangers in time, cause an accident and injure yourself and others.

If the lanes are narrow, vehicles driving in the lane beyond the lane next to your vehicle may be indicated, especially if the vehicles are not driving in the middle of their lane. This may

be the case if there are vehicles at the edge of their lane nearest your vehicle.

Due to the nature of the system:

- warnings may be issued in error when driving close to crash barriers or similar solid lane borders.
- warnings may be interrupted when driving alongside long vehicles, for example lorries, for a prolonged time.

The two radar sensors for Blind Spot Assist are integrated into the sides of the rear bumper. Make sure that the bumper is free of dirt, ice or slush in the vicinity of the sensors. The sensors must not be covered, for example by cycle racks or overhanging loads. Following a severe impact or in the event of damage to the bumpers, have the function of the sensors checked at a qualified specialist workshop. Blind Spot Assist may otherwise not work properly.

Indicator and warning display



① Yellow indicator lamp/red warning lamp

If Blind Spot Assist is switched on, indicator lamp ① in the exterior mirrors lights up yellow up to a speed of 30 km/h. At speeds above 30 km/h, the indicator lamp goes out and Blind Spot Assist is operational.

If a vehicle is detected within the monitoring range of Blind Spot Assist at speeds above 30 km/h, warning lamp ① on the corresponding side lights up red. This warning is always emitted when a vehicle enters the blind spot monitoring range from behind or from the side. When you overtake a vehicle,

the warning only occurs if the difference in speed is less than 12 km/h.

The yellow indicator lamp goes out if reverse gear is engaged. Blind Spot Assist is then deactivated.



The brightness of the indicator/warning lamps is adjusted automatically according to the ambient light.

WARNING

Blind Spot Assist is not active at speeds below 30 km/h. The indicator lamps in the exterior mirrors are yellow. Vehicles in the monitoring range are then not indicated.

Always pay attention to traffic conditions and your surroundings. Otherwise, you may fail to recognise dangers in time, cause an accident and injure yourself and others.

Collision warning

If a vehicle is detected in the monitoring range of Blind Spot Assist and you switch on the corresponding turn signal, a double warning tone sounds. Red warning lamp  flashes. If the turn signal remains on, detected vehicles are indicated by the flashing of red warning lamp . There are no further warning tones.

Switching on Blind Spot Assist

- ▶ Make sure that the radar sensor system (▷ page 408) and Blind Spot Assist (▷ page 405) are activated in the on-board computer.
- ▶ Turn the key to position **2** in the ignition lock.
Warning lamps  light up red in the exterior mirrors for approximately 1.5 seconds and then turn yellow.

Trailer towing

If you attach a trailer, make sure that you have correctly established the electrical connection. This can be accomplished by checking the trailer lighting. Blind Spot Assist is then deactivated. The indicator lamp in the exterior mirrors lights up yellow, and the **Blind Spot Assist currently unavailable**

See Owner's Manual message appears in the multifunction display.

 You can deactivate the indicator lamps in the exterior mirrors.

To do so, switch off Blind Spot Assist if:

- the key is in position **2** in the ignition lock.
- the engine is not running.
- the electrical connection to the trailer has been established.

Lane Keeping Assist

Important safety notes

Lane Keeping Assist monitors the area in front of your vehicle by means of a camera at the top of the windscreen. Lane Keeping Assist detects lane markings on the road and warns you before you leave your lane unintentionally.

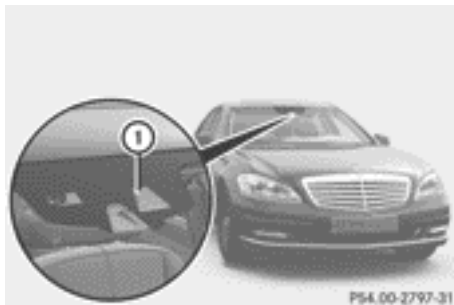

 Lane Keeping Assist camera

If you have chosen the **Display unit Speed-/odometer** (▷ page 407) function in the on-board computer and select **km** as the unit of measurement, Lane Keeping Assist is active from speeds of 60 km/h. If the **miles** display unit is selected, the assistance range begins at 40 mph.

WARNING

Lane Keeping Assist does not keep your vehicle in its lane. It is only an aid and may detect the lane markings on the road incorrectly or not at all.

The system may be impaired or may not function if:

- there is poor visibility, e.g. due to insufficient illumination of the road, or due to snow, rain, fog or spray.
- there is glare, e.g. from oncoming traffic, the sun, or reflection from other vehicles.
- the windscreen is dirty, misted up or covered, for instance by a sticker, in the vicinity of the camera
- several or no lane markings for a single lane are present.
- the lane markings are worn away, dark or covered up, e.g. by dirt or snow.
- the distance to the vehicle in front is too small and the lane markings thus cannot be detected.
- the lane markings on the road are unclear, e.g. near roadworks.
- the lane markings change quickly, e.g. lanes branch off, cross one another or merge.
- the road is narrow and winding.

Lane Keeping Assist cannot detect road and traffic conditions. It is not a substitute for attentive driving. You are responsible for the vehicle's speed, braking in good time, and steering correctly. Always adapt your driving style to suit the prevailing road and weather conditions. Always pay attention to traffic conditions and your surroundings. Otherwise, you may fail to recognise dangers in time, cause an accident and injure yourself and others.

A warning may be given if a front wheel passes over a lane marking. It will warn you by means of intermittent vibration in the steering wheel for up to 1.5 seconds.

In order that you are warned only when necessary and in good time if you cross the lane marking, the system recognises certain conditions and warns you accordingly.

The warning vibration occurs earlier if:

- you approach the outer lane marking on a bend.
- the road has very wide lanes, e.g. a motorway.
- the system recognises solid lane markings.

The warning vibration occurs later if:

- the road has narrow lanes.
- you cut the corner on a bend.

No warning vibration occurs if:

- you clearly and actively steer, brake, or accelerate.
- you cut the corner on a sharp bend.
- a driving safety system intervenes, such as ABS, BAS or ESP®.
- you have switched on the turn signals. In this event, the warnings are suppressed for a certain period of time.

Activating Lane Keeping Assist



- ▶ Activate Lane Keeping Assist using the on-board computer (▷ page 405). Symbol ① appears in the multifunction display.

If you drive at speeds above 60 km/h and lane markings are detected, symbol ① is shown in green. Lane Keeping Assist is ready for use.

Active Driving Assistance package

General notes

- ① The Active Driving Assistance package is only available on vehicles without HYBRID.

The Active Driving Assistance package consists of DISTRONIC PLUS (▷ page 348), Active

Blind Spot Assist (▷ page 380) and Active Lane Keeping Assist (▷ page 382).

Active Blind Spot Assist

Important safety notes

Active Blind Spot Assist uses a radar sensor system to monitor the side areas of your vehicle which are behind the driver. A warning display in the exterior mirrors draws your attention to vehicles detected in the monitored area. If you then switch on the corresponding turn signal to change lane, you will also receive an optical and audible collision warning. If a risk of lateral collision is detected, corrective braking may help you avoid a collision. To support the course-correcting brake application, Active Blind Spot Assist also uses the forward-facing radar sensor system. Active Blind Spot Assist supports you from a speed of approximately 30 km/h.

WARNING

Active Blind Spot Assist is only an aid and may detect vehicles/obstacles incorrectly or not at all.

The system may be impaired or may not function if:

- there is poor visibility, e.g. due to snow, rain, fog or spray.
- the rear and/or front sensors are dirty.

Active Blind Spot Assist may not detect narrow vehicles, such as motorcycles or bicycles, or only detect them too late. It cannot detect vehicles which are overtaken at a small distance and then enter the blind spot area.

Active Blind Spot Assist cannot detect road and traffic conditions. It is not a substitute for attentive driving. You are responsible for the vehicle's speed, braking in good time, and steering correctly. Always adapt your driving style to suit the prevailing road and weather conditions. Always pay attention to traffic conditions and your surroundings. Otherwise, you may fail to recognise dangers in time, cause an accident and injure yourself and others.

The radar sensor system is automatically deactivated near radio telescope facilities (▷ page 545).

For Active Blind Spot Assist to assist you when driving, the radar sensor system must be activated (▷ page 408) and operational.

Monitoring range

Active Blind Spot Assist monitors the area up to three metres behind your vehicle and directly next to your vehicle as shown in the diagram. For this purpose, Active Blind Spot Assist uses radar sensors in the rear bumper.

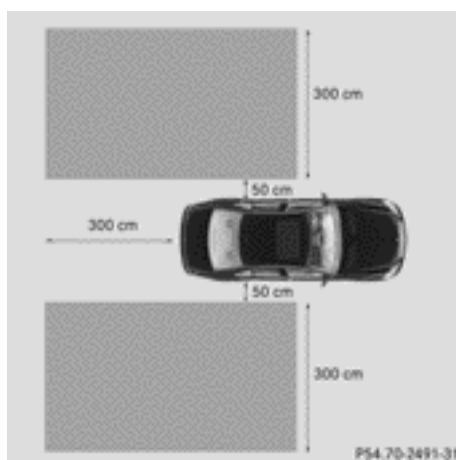

WARNING

Active Blind Spot Assist monitors certain areas in the immediate vicinity of your vehicle. Vehicles that approach and drive past at high speeds are not detected. No visual nor audible warnings are emitted and the system does not brake the vehicle to correct your course.

If the lanes are very wide, it may not be possible to monitor the complete width of the neighbouring lane. For this reason, vehicles in the next lane may not be detected, especially if they are driving in a staggered formation. This may be the case if vehicles are driving at the edge of their lane that is furthest away from your vehicle.

Always pay attention to traffic conditions and your surroundings. Otherwise, you may fail to

recognise dangers in time, cause an accident and injure yourself and others.

If the lanes are narrow, vehicles driving in the lane beyond the lane next to your vehicle may be indicated, especially if the vehicles are not driving in the middle of their lane. This may be the case if there are vehicles at the edge of their lane nearest your vehicle.

Due to the nature of the system:

- warnings may be issued in error when driving close to crash barriers or similar solid lane borders.
- warnings may be interrupted when driving alongside long vehicles, for example lorries, for a prolonged time.

Two Active Blind Spot Assist radar sensors are integrated into the front and rear bumpers respectively. An additional radar sensor is located behind the cover in the radiator grille. Make sure that the sensors and the areas around them are free of dirt, ice or slush. The rear sensors must not be covered, e.g. by bicycle racks or overhanging loads. Following a severe impact or in the event of damage to the bumpers, have the function of the sensors checked at a qualified specialist workshop. Blind Spot Assist may otherwise not work properly.

Indicator and warning display



① Yellow indicator lamp/red warning lamp

When Active Blind Spot Assist is activated, indicator lamp ① in the exterior mirrors lights up yellow at speeds of up to 30 km/h. At speeds above 30 km/h, the indicator lamp

goes out and Active Blind Spot Assist is operational.

If a vehicle is detected within the monitoring range of Blind Spot Assist at speeds above 30 km/h, warning lamp ① on the corresponding side lights up red. This warning always occurs when a vehicle enters the blind spot monitoring range from behind or from the side. When you overtake a vehicle, the warning only occurs if the difference in speed is less than 12km/h.

The yellow indicator lamp goes out if reverse gear is engaged. Active Blind Spot Assist is then no longer active.

The brightness of the indicator/warning lamps is adjusted automatically according to the ambient light.

WARNING

Active Blind Spot Assist is not active at speeds below 30 km/h. The indicator lamps in the exterior mirrors are yellow. Vehicles in the monitoring range are then not indicated.

Always pay attention to traffic conditions and your surroundings. Otherwise, you may fail to recognise dangers in time and cause an accident and injure yourself and others.

Visual and acoustic collision warning

If a vehicle is detected in the side monitoring range and you switch on the appropriate turn signals, you will receive a collision warning. You will hear a double warning tone and red warning lamp ① flashes. If the turn signal remains on, detected vehicles are indicated by the flashing of red warning lamp ①. There are no further warning tones.

Course-correcting brake application

If Active Blind Spot Assist detects a risk of a lateral collision in the monitoring range, a course-correcting brake application is carried out. This is designed to help you avoid a collision.

The course-correcting brake application is available in the range between 30 km/h and 200 km/h.

If a course-correcting brake application occurs, red warning lamp ① flashes in the exterior mirror and the following is shown in the multifunction display, for example:



⚠ WARNING

Active Blind Spot Assist is only an aid designed to assist driving. It is not a substitute for attentive driving. Automatic braking by the system may not always be sufficient to avoid a collision. In such cases, you need to steer, brake or accelerate yourself.

In very rare cases, the system may detect a risk of collision where there is none and brake in error near crash barriers or similar road boundaries. Active Blind Spot Assist cannot detect all traffic situations and road users. Ensure at all times that there is sufficient lateral distance between you and other road users or obstacles. You can, for example, countersteer gently or depress the accelerator pedal at any time to cancel inappropriate braking action.

You are responsible for the vehicle's speed, correct steering and for braking in good time. Always adapt your driving style to suit the prevailing road and weather conditions. Always pay attention to traffic conditions and your surroundings. Otherwise, you may fail to recognise dangers in time, cause an accident and injure yourself and others.

Either a very slight course-correcting brake application, or none at all, may occur if:

- there are vehicles or obstacles, e.g. crash barriers, on both sides of your vehicle.
- a vehicle approaches too closely on the side.
- you have adopted a sporty driving style with high cornering speeds.

- you brake or accelerate decisively.
- a driving safety system intervenes, such as ESP® or PRE-SAFE® Brake.
- ESP® is deactivated.
- a loss of tyre pressure or a defective tyre is detected.

Activating Active Blind Spot Assist

- ▶ Make sure that the radar sensor system (▷ page 408) and Active Blind Spot Assist (▷ page 405) are activated in the on-board computer.
- ▶ Turn the key to position **2** in the ignition lock.
Warning lamps ① in the exterior mirrors light up red for approximately 1.5 seconds and then turn yellow.

Trailer towing

If you attach a trailer, make sure that you have correctly established the electrical connection. This can be accomplished by checking the trailer lighting. Active Blind Spot Assist is then deactivated. The indicator lamp in the exterior mirrors lights up yellow, and the **Active Blind Spot Assist currently unavailable** See Owner's Manual message appears in the multifunction display.

Active Lane Keeping Assist

Important safety notes

Active Lane Keeping Assist monitors the area in front of your vehicle by means of a camera mounted at the top of the windscreen. Active Lane Keeping Assist detects lane markings on the road and warns you before you leave your lane unintentionally. If you do not react to the warning, a lane-correcting application of the brakes can bring the vehicle back into the original lane.

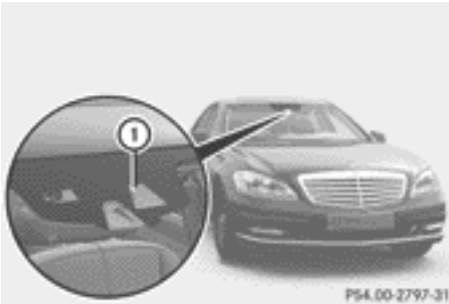

① Active Lane Keeping Assist camera

If you have selected the **Display unit Speed-/odometer** (▷ page 407) function in the on-board computer and select **km** as the unit of measurement, Active Lane Keeping Assist is active from speeds of 60 km/h. If the **mph** display unit is selected, the assistance range begins at 40 mph.

WARNING

Active Lane Keeping Assist does not keep your vehicle in its lane. It is only an aid and may detect the lane markings on the road incorrectly or not at all.

The system may be impaired or may not function if:

- several or no lane markings for a single lane are present.
- there is poor visibility, e.g. due to insufficient illumination of the road, or due to snow, rain, fog or spray.
- there is glare, e.g. from oncoming traffic, the sun, or reflection from other vehicles.
- the windscreen is dirty, misted up or covered, for instance by a sticker, in the vicinity of the camera.
- the lane markings are worn away, dark or covered up, e.g. by dirt or snow.
- the distance to the vehicle in front is too small and the lane markings thus cannot be detected.
- the lane markings on the road are unclear, e.g. near roadworks.

- the lane markings change quickly, e.g. lanes branch off, cross one another or merge.
- the road is narrow and winding.

Active Lane Keeping Assist cannot detect road and traffic conditions. It is not a substitute for attentive driving. You are responsible for the vehicle's speed, braking in good time, and steering correctly. Always adapt your driving style to suit the prevailing road and weather conditions. Always pay attention to traffic conditions and your surroundings. Otherwise, you may fail to recognise dangers in time, cause an accident and injure yourself and others.

Warning vibration in the steering wheel

A warning may be given if a front wheel passes over a lane marking. It will warn you by means of intermittent vibration in the steering wheel for up to 1.5 seconds.

In order that you are warned only when necessary and in good time if you cross the lane marking, the system recognises certain conditions and warns you accordingly.

The warning vibration occurs earlier if:

- you approach the outer lane marking on a bend.
- the road has very wide lanes, e.g. a motorway.
- the system recognises solid lane markings.

The warning vibration occurs later if:

- the road has narrow lanes.
- you cut the corner on a bend.

No warning vibration occurs if:

- you clearly and actively steer, brake, or accelerate.
- you cut the corner on a sharp bend.
- a driving safety system intervenes, such as ABS, BAS or ESP®.
- you have switched on the turn signals. In this event, the warnings are suppressed for a certain period of time.

Lane-correcting brake application

If you leave your lane under certain circumstances, the vehicle will brake briefly on one side. This is designed to help you bring the vehicle back into the original lane.

This function is available in the range between 60 km/h and 200 km/h.

A lane-correcting brake application can only be made after driving over a solid, recognisable lane marking. Before this, a warning must be emitted by means of intermittent vibration in the steering wheel. In addition, a lane with lane markings on both sides must be recognised. The brake application also slightly reduces driving speed.

If a lane-correcting brake application occurs, the following appears in the multifunction display:



i A further lane-correcting brake application can only occur after your vehicle has returned to the original lane.

⚠ WARNING

Active Lane Keeping Assist does not keep your vehicle in its lane. It is only an aid designed to assist driving. It is not a substitute for attentive driving. Corrective braking may not always be sufficient to return your vehicle to its original lane. In such cases, you must steer the vehicle yourself to ensure that it does not leave the lane.

Active Lane Keeping Assist cannot detect the current traffic situation or other road users. Ensure at all times that there is sufficient lateral distance between you and other road users or obstacles. In rare cases, broken lines or certain structures on the road surface may be detected by the system as solid lane markings. You can, for example, countersteer gen-

tly at any time to cancel inappropriate braking action, e.g. if you intentionally drive across a solid lane marking.

Active Lane Keeping Assist cannot take weather conditions into account.

You are responsible for the vehicle's speed, correct steering and for braking in good time. Always adapt your driving style to suit the prevailing road and weather conditions. Always pay attention to traffic conditions and your surroundings. Otherwise, you may fail to recognise dangers in time, cause an accident and injure yourself and others.

No lane-correcting brake application occurs if:

- you clearly and actively steer, brake, or accelerate.
- you cut the corner on a sharp bend.
- you have switched on the turn signals.
- a driving safety system intervenes, such as ESP®, PRE-SAFE® Brake or Active Blind Spot Assist.
- you have adopted a sporty driving style with high cornering speeds or high rates of acceleration.
- on vehicles with a trailer tow hitch, the electrical connection to the trailer has been correctly established.
- ESP® is deactivated.
- the transmission is not in position **D**.
- a loss of tyre pressure or a defective tyre has been detected and displayed.

Active Lane Keeping Assist does not detect road and traffic conditions. An inappropriate brake application may be interrupted at any time if:

- you steer slightly in the opposite direction.
- you use a turn signal.
- you clearly brake or accelerate.

A lane-correcting brake application is interrupted automatically if:

- a driving safety system intervenes, such as ESP®, PRE-SAFE® Brake or Active Blind Spot Assist.
- lane markings can no longer be recognised.

Activating Active Lane Keeping Assist

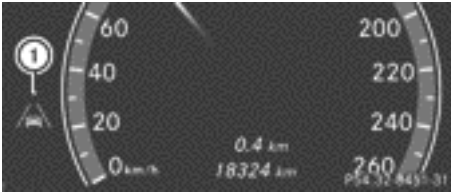

- ▶ Activate Active Lane Keeping Assist using the on-board computer (▶ page 405). Symbol ① appears in the instrument cluster.

If you drive at speeds above 60 km/h and lane markings are detected, symbol ① is shown in green. Active Lane Keeping Assist is ready for use.

Trailer towing

If you attach a trailer, make sure that you have correctly established the electrical connection. This can be accomplished by checking the trailer lighting.

Towing a trailer

Notes on towing a trailer

Important safety notes

WARNING

When reversing the vehicle towards the trailer, make sure there is nobody between the trailer and the vehicle.

Couple and uncouple the trailer carefully. If you do not couple the trailer to the towing vehicle correctly, the trailer could become detached.

Make sure that the following values are not exceeded:

- the permissible trailer drawbar noseweight
- the permissible trailer load
- the permissible rear axle load of the towing vehicle
- the maximum permissible gross vehicle weight of both the towing vehicle and the trailer

You will find the applicable permissible values, which must not be exceeded, in the vehicle documents.

You will find the values approved by the manufacturer on the vehicle identification plates and those for the towing vehicle in the "Technical data" section.

WARNING

If the [Check trailer hitch locking mechanism](#) message appears in the multi-function display while the vehicle is in motion, pull over immediately and check whether the ball coupling is correctly engaged.

WARNING

When towing a trailer, your vehicle's handling characteristics will be different in comparison to when driving without a trailer.

The vehicle/trailer combination:

- is heavier
- is restricted in its acceleration and gradient-climbing capability
- has an increased braking distance
- is affected more by strong crosswinds
- demands more sensitive steering
- has a larger turning circle

As a result, the handling characteristics may be impaired and you may lose control of the vehicle. This could lead to an accident with serious or even fatal injuries.

When towing a trailer, always adjust your speed to the current road and weather conditions. Do not exceed the maximum permis-

sible speed for your vehicle/trailer combination.

WARNING

Never depress the brake pedal continuously while the vehicle is in motion, e.g. never cause the brakes to rub by applying constant slight pedal pressure. This causes the brake system to overheat, increases the braking distance and can lead to the brakes failing completely.

WARNING

On no account should you attempt to draw the vehicle/trailer combination out by increasing speed.

WARNING

If you exceed the maximum noseweight when using a carrier system on the ball coupling:

- the carrier system may be thrown around.
- the ball coupling and the carrier system may become detached from the vehicle.

As a result, you may injure others or cause an accident.

Do not exceed the maximum noseweight. When driving with a loaded carrier system, always adjust your driving style to the prevailing road, traffic and weather conditions and drive particularly carefully.

You can use carrier systems, e.g. bicycle racks or load-bearing implements, on the ball coupling. The maximum noseweight of 75 kg applies when using carrier systems on the ball coupling.

General notes

 When towing a trailer, set the tyre pressure on the rear axle of the towing vehicle for a maximum load; see the tyre pressure table in the fuel filler flap (▷ page 520).

You will find installation dimensions and loads in the "Technical data" section (▷ page 543).

 Use a drawbar noseweight as close as possible to the maximum permissible noseweight. Do not use a noseweight of less than 50 kg, as the vehicle/trailer combination may otherwise become unstable. Note that the payload and the rear axle load are reduced by the actual noseweight.

WARNING

If you exceed the maximum permissible noseweight of the trailer drawbar on the ball coupling, the trailer, ball coupling, trailer tow hitch or vehicle could be damaged by towing the trailer. The car/trailer combination may become unstable.

If the noseweight used is lower than the minimum permissible noseweight, the vehicle/trailer combination may become unstable.

There is a risk of an accident.

To avoid hazardous situations:

- you must check the noseweight before each journey.
- use a drawbar noseweight as close as possible to the maximum noseweight.
- do not exceed the maximum permissible noseweight.
- do not use a noseweight lower than the minimum noseweight.

The maximum permissible trailer drawbar noseweight on the ball coupling is 85 kg²⁵.

The minimum noseweight of the trailer drawbar on the ball coupling must not fall below 50 kg.

However, the actual noseweight must not exceed the value given on the trailer tow hitch identification plate. In addition, a distinction should be made between towing a trailer and using a carrier system on the ball coupling of the trailer tow hitch.

Note also that the payload and the rear axle load are reduced by the actual noseweight.

 On vehicles without level control, the height of the ball coupling will alter accord-

²⁵ Missing values for the E 350 BlueEFFICIENCY model were not available at the time of going to print.

ing to the load placed on the vehicle. If necessary, use a trailer with a height-adjustable drawbar.

Driving tips

- i** Observe the notes on ESP® trailer stabilisation (▷ page 73).

The maximum permissible speed for vehicle/trailer combinations depends on the type of trailer. Before beginning the journey, check the trailer's documents to see what the maximum permitted speed is. Observe the legally prescribed maximum speed in the relevant country.

For certain Mercedes-Benz vehicles, the maximum permissible rear axle load is increased when towing a trailer. Refer to the "Technical data" section to find out whether this applies to your vehicle. If you utilise any of the added maximum rear axle load when towing a trailer, the vehicle/trailer combination may not exceed a maximum speed of 100 km/h for reasons concerning the operating permit. This also applies in countries in which the permissible maximum speed for vehicle/trailer combinations is above 100 km/h.

When towing a trailer, your vehicle's handling characteristics will be different in comparison to when driving without a trailer and it will consume more fuel.

On long and steep downhill gradients, you must select shift range **1**, **2** or **3** in good time.

- i** This also applies if you have activated cruise control, SPEEDTRONIC or DISTRONIC PLUS.

This will use the braking effect of the engine, so less braking will be required to prevent the vehicle from gaining speed. This relieves the load on the brake system and prevents the brakes from overheating and wearing too quickly. If you need additional braking, depress the brake pedal repeatedly rather than continuously.

Driving tips

- Maintain a greater distance from the vehicle in front than when driving without a trailer.
- Avoid braking abruptly. If possible, brake gently at first to allow the trailer to run on. Then, increase the braking force rapidly.
- The values given for gradient-climbing capabilities from a standstill refer to sea level. When driving in mountainous areas, note that the power output of the engine, and consequently the vehicle's gradient-climbing capability, decrease with increasing altitude.

If the trailer swings from side to side:

- ▶ Do not accelerate.
- ▶ Do not countersteer.
- ▶ Brake if necessary.

Folding out the ball coupling

WARNING

Vehicles with HYBRID: ensure that you read the "HYBRID" supplement. You may otherwise fail to recognise dangers.

Before you can tow a trailer with your vehicle, you must fit the ball coupling.

The telescopic lever is under the cover on the left-hand side of the boot.



⚠ WARNING

Make sure that the ball coupling is fully engaged both when it is folded in and when it is folded out. The indicator lamp is not lit.

Do not pull the telescopic lever if a trailer is attached. The trailer could otherwise come loose.

- ▶ Pull telescopic lever ① slightly upwards.
- ▶ Pull telescopic lever ① out forwards.
- ▶ Pull telescopic lever ① fully upwards. The ball coupling disengages and folds out from under the rear bumper. Indicator lamp ② flashes.
- ▶ Guide telescopic lever ① back again.



- ▶ Press the ball coupling in the direction of the arrow by hand until it engages in a vertical position. Indicator lamp ② goes out. The power socket folds down automatically. The multifunction display shows the **Check trailer hitch locking mechanism** message until the ball coupling is engaged.
- ▶ Remove the protective cap from the ball coupling.

Coupling up a trailer**⚠ WARNING**

Do not disconnect a trailer with an engaged overrun brake. Otherwise, your hand could

become trapped between the bumper and trailer drawbar.

- ▶ Make sure that the transmission is in position **P**.
- ▶ Apply the parking brake.
- ▶ Position the trailer level behind the vehicle.
- ▶ Couple up the trailer.
- ▶ Establish the electrical connection between the vehicle and the trailer.
- ▶ Check that the trailer lighting system is working.

Uncoupling a trailer**⚠ WARNING**

As soon as you raise the trailer drawbar, the unladen vehicle rises slightly. The vehicle then lowers to driving level.

Make sure that nobody is in the vicinity of the wheel arch or the underbody. You could otherwise trap yourself or others.

⚠ WARNING

The vehicle is lowered as soon as you disconnect the trailer cable. Make sure that nobody is in the vicinity of the wheel arch or the underbody. You could otherwise trap yourself or others.

As soon as you decouple the trailer, the unladen vehicle rises slightly. Make sure that you or others are not injured in the process.

- ▶ **!** Do not disconnect a trailer with an engaged overrun brake. Otherwise, your vehicle could be damaged by the rebounding of the overrun brake.
- ▶ Make sure that the transmission is in position **P**.
- ▶ Apply the parking brake.
- ▶ Secure the trailer against rolling away.
- ▶ Remove the trailer cable and decouple the trailer.

Folding in the ball coupling

- ① Fold the ball coupling back in if you are not using the trailer tow hitch.

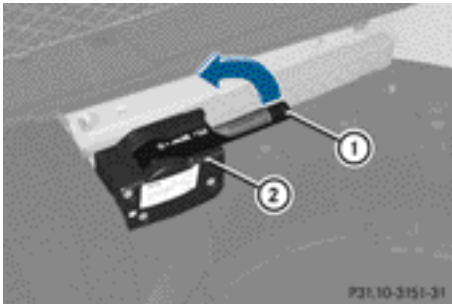

- ▶ Place the protective cap on the ball coupling.

WARNING

Make sure that no persons or animals are in the pivoting range of the ball coupling. Otherwise, they could be injured.

- ▶ Pull telescopic lever ① slightly upwards.
- ▶ Pull telescopic lever ① out forwards.
- ▶ Pull telescopic lever ① fully upwards. The ball coupling disengages and folds out from under the rear bumper. Indicator lamp ② flashes.
- ▶ Guide telescopic lever ① back again.



- ▶ Press the ball coupling in the direction of the arrow until it engages behind the bumper. Indicator lamp ② goes out and the message in the multifunction display disappears.

Trailer power supply

When it leaves the factory, your vehicle's trailer socket is equipped with a permanent power supply and a power supply that is switched on via the ignition lock.

The permanent power supply is supplied via trailer socket pin 9.

The power supply that is switched on via the ignition lock is supplied via trailer socket pin 10.

- ❗ You can connect accessories with a power rating of up to 240 W to the permanent power supply and with a power rating of up to 180 W to the power supply that is switched on via the ignition lock.

The trailer battery may not be charged from the power supply.

The trailer's permanent power supply is switched off in the event of low vehicle supply voltage and after six hours at the latest.

You can find more information about installing the trailer electrics at a qualified specialist workshop.

- ▶ **To switch the connected power supply on or off:** turn the key in the ignition lock to position **2** or **0** respectively.

Trailer with 7-pin connector

General notes

If your trailer has a 7-pin connector, you can connect it to the 13-pin socket on the ball coupling using an adapter or, if necessary, an adapter cable. Both can be obtained in a qualified specialist workshop.

Fitting the adapter

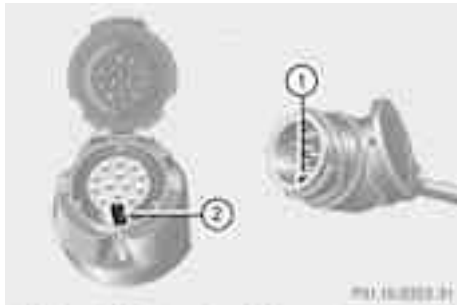

- ▶ Open the socket cover.
 - ▶ Insert the connector with lug ① into groove ② on the socket and turn the connector clockwise to the stop.
 - ▶ Let the cover engage.
 - ▶ If you are using an adapter cable, secure the cable to the trailer with cable ties.
- !** Make sure that there is sufficient cable play so that the cable cannot become detached when cornering.

Useful information	392
Important safety notes	392
Displays and operation	392
Menus and submenus	395
Display messages	409
Warning and indicator lamps in the instrument cluster	443

Useful information

- i** This Owner's Manual describes all models and all standard and optional equipment available to your vehicle at the time of publication of the Owner's Manual. Country-specific deviations are possible. Please note that your vehicle may not be equipped with all features described. This also applies to safety-relevant systems and functions.
- i** Please read the information on qualified specialist workshops (▷ page 32).

Important safety notes

You will find an illustration of the instrument cluster in the "At a glance" section (▷ page 38).

WARNING

Only use the on-board computer when road and traffic conditions permit. You would otherwise be distracted and unable to concentrate properly on driving, and could cause an accident.

WARNING

No messages will be displayed if either the instrument cluster or the multifunction display is inoperative.

As a result, you will not be able to see information about your driving conditions, such as speed, outside temperature, warning and indicator lamps, display messages or system failures. Driving characteristics may be impaired. Adjust your driving style and vehicle speed accordingly.

Contact a qualified specialist workshop immediately.

WARNING

The on-board computer only records and displays malfunctions and warnings from certain systems. For this reason, you should always

make sure that your vehicle is safe to use. You could otherwise cause an accident by driving an unsafe vehicle.

WARNING

The operating safety of your vehicle could be impaired if maintenance work is carried out incorrectly. This could cause you to lose control of your vehicle and cause an accident. Moreover, the safety systems may no longer be able to protect you or others as they are designed to do.

Always have service work carried out at a qualified specialist workshop.

WARNING

Hybrid vehicles: ensure that you read the "HYBRID" supplement. You could otherwise fail to recognise dangers.

Displays and operation

Coolant temperature gauge

The coolant temperature gauge is in the instrument cluster on the left-hand side.

The reading may rise up to 120 °C under normal driving conditions if the coolant has been filled correctly.

At high outside temperatures and when driving uphill, the coolant temperature may rise to the end of the scale.

Rev counter

The red band in the rev counter indicates the engine's overrevving range.

- !** Do not drive in the overrevving range. Doing so will damage the engine.

The fuel supply is interrupted to protect the engine when the red band is reached.

Outside temperature display

The outside temperature display is in the multifunction display (▷ page 394).

⚠ WARNING

At temperatures just above freezing point, the street may be icy, especially in wooded areas or on bridges. If you do not adapt your driving style to the conditions, the vehicle could skid. For this reason, adapt your driving style and speed to the weather conditions.













Changes in the outside temperature are displayed after a short delay.

Operating the on-board computer

The on-board computer is activated as soon as you turn the key to position **2** in the ignition lock.

You can control the multifunction display and the settings in the on-board computer using the buttons on the multifunction steering wheel.



①	Multifunction display
②	 Rejects or ends a call Exits telephone book/redial memory  Makes or accepts a call Switches to the redial memory   Adjusts the volume or operates the RACETIMER in AMG vehicles  Mute
③	 Switches on LINGUATRONIC; see the separate operating instructions
④	 Press briefly: Back Switches off LINGUATRONIC; see the separate operating instructions Hides display messages or calls up the last Trip menu function used
	 Press and hold: Calls up the standard display in the Trip menu
⑤	  Selects a menu
	  Press briefly: Selects a function or scrolls through lists In the Audio menu: selects a stored station, an audio track or a video scene In the Telephone menu: switches to the phone book and selects a name or a telephone number

▲ ▼ **Press and hold:**

In the **Audio** menu: selects a station from the alphabetical list of stations, starts station search or starts rapid scrolling through an audio/video disc

In the **Telephone** menu: starts rapid scrolling through the phone book

 OK

Confirms selections and messages

In the **Telephone** menu: switches to the phone book and starts dialling

In the **Audio** menu: stops the station search function at the desired station

Multifunction display

Values and settings as well as display messages are shown in the multifunction display.



- ① Menu bar
- ② Description field

Menus and submenus

Menu overview

The number of menus shown depends on the optional equipment in the vehicle.

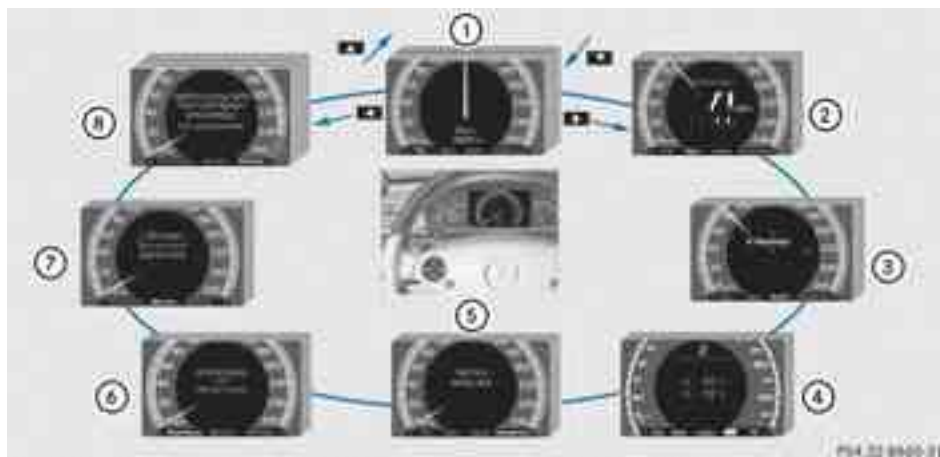

	Function
①	Trip menu (▷ page 396)
②	Navi menu (navigation instructions) (▷ page 397)
③	Audio menu (▷ page 398)
④	AMG menu in AMG vehicles (▷ page 400)
⑤	Telephone menu (▷ page 402)
⑥	Assistance menu (▷ page 404)
⑦	Serv. menu (▷ page 405) <ul style="list-style-type: none"> • Calls up display messages (▷ page 409) • Restarts the tyre pressure loss warning system (▷ page 521) or checks the tyre pressure electronically (▷ page 522) • Calls up a service due date (▷ page 482) • Oil level check (▷ page 477)
⑧	Settings menu (▷ page 406)

Trip menu

Standard display



- ▶ Press and hold the button on the steering wheel until the **Trip** menu with total distance recorder ① and trip meter ② is shown.

Trip computer "From start" or "From reset"

The values in the **After start** submenu are calculated from the start of a journey, whilst the values in the **After reset** submenu are calculated from the last time the submenu was reset (▷ page 397).

- ▶ Press the or button on the steering wheel to select the **Trip** menu.
- ▶ Press the or button to select **After start** or **After reset**.



Example: "From start" trip computer

- ① Distance
- ② Time
- ③ Average speed
- ④ Average fuel consumption

The **After start** trip computer is reset automatically when:

- the ignition has been switched off for more than four hours.
- 999 hours have been exceeded.
- 9999kilometres have been exceeded.

The **After reset** trip computer is reset if 9999 hours or 99,999 kilometres are exceeded.

Displaying the range and current fuel consumption

- ▶ Press the or button on the steering wheel to select the **Trip** menu.
- ▶ Press the or button to select **Distance**.
You can see the current fuel consumption (except for AMG vehicles) and the approximate range.



The approximate range which can be covered depends on the fuel level and your current driving style. If there is only a small amount of fuel left in the fuel tank, the display shows a vehicle being refuelled instead of the range.

Digital speedometer

- ▶ Press the or button on the steering wheel to select the **Trip** menu.
- ▶ Press the or button to select the digital speedometer.



① Digital speedometer

Resetting values

You can reset the values of the following functions:

- trip meter
- trip computer "From start"
- trip computer "From reset"
- ▶ Press the ◀ or ▶ button on the steering wheel to select the **Trip** menu.
- ▶ Press the ▲ or ▼ button to select the function that you wish to reset.
- ▶ Press **OK**.



Example: resetting the trip meter

- ▶ Press ▼ to select **Yes** and press **OK** to confirm.

Navigation menu

Displaying navigation instructions

In the **Navi** menu, the multifunction display shows navigation instructions. For further information, see (▷ page 151).

- ▶ Activate COMAND APS (▷ page 134).
- ▶ Press the ◀ or ▶ button on the steering wheel to select the **Navi** menu.

Route guidance not active



- ① Direction of travel
- ② Current street

Activated route guidance

No change of direction announced



- ① Distance to the destination
- ② Symbol "follow the road's course"
- ③ Distance to the next change of direction
- ④ Current street

Change of direction announced without a lane recommendation



- ① Road to which the change of direction leads
- ② Change-of-direction icon
- ③ Distance to change of direction and visual distance display

When a change of direction has been announced, you will see visual distance dis-

play ③ next to the symbol for change of direction ②. This shortens from the bottom to the top of the display as you approach the point of the announced change of direction.

Change of direction announced with a lane recommendation

Lane recommendations are only displayed if the relevant data is available on the digital map.



- ① Road to which the change of direction leads
- ② Change-of-direction icon
- ③ Distance to change of direction and visual distance display
- ④ Lane recommendation

On multiple-lane roads, COMAND APS can provide lane recommendation ④ for the next change of direction. During the change of direction, additional lanes may be displayed.



- ① Lane continues through change of direction
- ② New lane during a change of direction
- ③ Lane recommended for the change of direction



Other status indicators of the navigation system

- : you have reached the destination or an intermediate destination.
- **New route...**: COMAND APS is calculating the new route.
- **Direction of dest. Off map** or **Direction of dest. Off road**: the vehicle position is outside the area of the digital map (off-map position).
- **Direction of dest. No route**: no route could be calculated to the selected destination.

Audio menu





Selecting a radio station

You can only change the waveband and store new stations using COMAND APS.



- ▶ Switch on COMAND APS and select Radio (▷ page 217).
- ▶ Press the  or  button on the steering wheel to select the **Audio** menu.



- ① Memory slot (only if the station is stored)
- ② Station
- ③ Waveband

- ▶ **To select a stored station**: briefly press the  or  button.
- ▶ **To select a station from the alphabetical sender list²⁶**: press and briefly hold the  or  button.

²⁶ Only possible in the FM and DAB wavebands.

► **To select a station using station search²⁷:** press and briefly hold the  or  button.

► Press  to stop the station search function at the desired station.

i For further information on DAB radio mode (**D**igital **A**udio **B**roadcasting), see (▷ page 217).

Audio player or audio media operation

Audio data from various audio devices or media can be played, depending on the equipment fitted in the vehicle.

► Switch on COMAND APS and select audio device or audio medium (▷ page 223).

► Press the  or  button on the steering wheel to select the **Audio** menu.







Example: CD player display

① Current track

② Medium (disc number only for DVD changer)

► **To select the next/previous track:** briefly press the  or  button.

► **To select a track from the track list (rapid scrolling):** press and hold the  or  button until the desired track has been reached.

If you press and hold the  or  button, the rapid scrolling speed is increased. Not all audio devices or media support this function.

If track information is stored on the audio device or medium, the multifunction display will show the number and name of the track.

²⁷ Only if no station list is received.

The current track does not appear in audio AUX mode (**A**uxiliary audio mode: external audio source connected).

Video DVD operation

► Switch on COMAND APS and select video DVD (▷ page 248).



► Press the  or  button on the steering wheel to select the **Audio** menu.



① Current scene

② Medium (disc number only for DVD changer)

► **To select the next or previous scene:** briefly press the  or  button.

► **To select a scene from the scene list (rapid scrolling):** press and hold the  or  button until the desired scene has been reached.

TV operation

► Switch on COMAND APS and select TV (▷ page 243).

► Press the  or  button on the steering wheel to select the **Audio** menu.



- ① Memory slot (only if the channel is stored)
- ② Current channel
- ③ Function

► **To select a stored channel:** briefly press the or button.

► **To select a channel from the alphabetical channel list:** press and briefly hold the or button.

► **To select a channel using the channel search²⁸:** press and briefly hold the or button.

► Press to stop the channel search function at the desired channel.

AMG menu in AMG vehicles

AMG displays

► Press the or button on the steering wheel to select the **AMG** menu.



- ① Gear indicator
- ② Upshift indicator
- ③ Engine oil temperature
- ④ Coolant temperature

Upshift indicator **up** ② indicates that the engine has reached the overrevving range

when in the manual gearshift program. Upshift indicator **up** ② fades out other messages until you have shifted up.

When the engine oil temperature is below 80 °C, the oil temperature is shown in blue. Avoid using the full output of the engine during this time.

i S 63 AMG: additionally, the status of the ECO start/stop function (> page 325) will be displayed.

RACETIMER

Displaying and starting the RACETIMER

You can use the RACETIMER to store lap times.

With RACETIMER you cannot use the or buttons to regulate the volume on the steering wheel.

► Press or on the steering wheel to select the **AMG** menu.

► Press the button repeatedly until the RACETIMER is shown.



- ① Seconds indicator
- ② RACETIMER
- ③ Lap

²⁸ Only if COMAND APS does not receive a channel list.

You can start the RACETIMER when the engine is running or if the key is in position 2 in the ignition lock.

- ▶ **To start:** press the button to start the RACETIMER.
- ▶ **To display the intermediate time:** press the button to show the intermediate time.
The intermediate time is displayed for five seconds.
- ▶ **To stop:** press the button to stop the RACETIMER.

The RACETIMER interrupts timing when you stop the vehicle and turn the key to position 1 in the ignition lock. When you turn the key to position 2 or 3 and then press to confirm Start, timing is continued.

Storing the lap time and starting a new lap

It is possible to store a maximum of sixteen laps.

- ▶ Press the button on the steering wheel to show the intermediate time during timing.
The intermediate time is displayed for five seconds.
- ▶ Press the button again within five seconds.
The displayed intermediate time is stored as a lap time.
Timing starts for a new lap. The new lap is timed from when the intermediate time is called up.



- ① RACETIMER
- ② Fastest lap time (best lap)

Resetting the current lap

- ▶ Press the button on the steering wheel to stop the RACETIMER.
- ▶ Press to reset the lap time to "0".

Deleting all laps

You cannot delete individual stored laps.

- ▶ Press the button on the steering wheel to stop the RACETIMER.
- ▶ Press and hold the button for a minimum of three seconds.
- ▶ Press the button to start the RACETIMER.
All laps are deleted.

or

- ▶ Press the button on the steering wheel to stop the RACETIMER.
- ▶ Press the button.
Reset Race Timer appears in the multi-function display.



- ▶ Press the button to select **Yes** and press the button to confirm.
All laps are deleted.

Overall evaluation

This function is shown if you have stored at least one lap and stopped the RACETIMER.

- ▶ Press or on the steering wheel to select the **AMG** menu.
- ▶ Press the button repeatedly until the overall evaluation is shown.



- ① RACETIMER overall evaluation
- ② Total time driven
- ③ Top speed
- ④ Distance covered
- ⑤ Average speed

Lap evaluation

This function is only available if you have stored at least two laps and have stopped the RACETIMER.

- ▶ Press or on the steering wheel to select the **AMG** menu.
- ▶ Press the button repeatedly until the lap evaluation is shown. Each lap is shown in a separate submenu. The fastest lap is indicated by flashing symbol ①.



- ① Lap
 - ② Lap time
 - ③ Top speed during lap
 - ④ Lap length
 - ⑤ Average lap speed
- ▶ Press the or button to select a different lap evaluation.

Telephone menu

Introduction

Functions and displays are dependent on the optional equipment installed in your vehicle. You can place your mobile phone in the mobile phone bracket (▷ page 466) or set up a Bluetooth® connection to COMAND APS (▷ page 194).

- ❗ You can obtain further information about suitable mobile phones and connecting mobile phones via Bluetooth®:
 - in any Mercedes Benz Service Centre
 - on the Internet at <http://www.mercedes-benz.com/connect>

⚠ WARNING

Observe the legal requirements of the country in which you are currently driving regarding the use of mobile phones in the vehicle.

If it is permitted to use mobile phones while the vehicle is in motion, you should only use them when the road and traffic conditions allow. Otherwise, you may be distracted from the traffic conditions, cause an accident and injure yourself and others.

- ▶ Switch on the mobile phone and COMAND APS (▷ page 134).
- ▶ Press the or button on the steering wheel to select the **Telephone** menu.

You will see one of the following display messages in the multifunction display:

- **Please enter PIN:** the mobile phone has been placed in the mobile phone bracket and the PIN has not been entered.
- ▶ Enter the PIN using the mobile phone, LINGUATRONIC or COMAND APS. The mobile phone will search for a network.
- **Telephone ready** or the name of the network provider: the mobile phone has found a network and is ready to receive.
- **No Service:** no network is available, or the mobile phone is searching for a network.

Accepting a call

If someone calls you when you are in the **Telephone** menu, a display message appears in the multifunction display, for example:



- ▶ Press the  button on the steering wheel to accept an incoming call.

If you are not in the **Telephone** menu, you can still accept a call.

Rejecting or ending a call

- ▶ Press the  button on the steering wheel.

If you are not in the **Telephone** menu, you can still reject or end a call.

Dialling a number from the phone book







You can use the mobile phone to enter new telephone numbers into the phone book (see COMAND APS) (▷ page 207). If your mobile phone is able to receive calls, you can search for and dial a number from the phone book.



COMAND APS can download the phone book from the mobile phone. To do this, insert the mobile phone into the mobile phone cradle or establish a Bluetooth® connection to COMAND APS. This may take some time.

While the on-board computer reads in the SIM card:



- you can dial a telephone number from the redial list (**Calls dialled** list).
- you can dial a telephone number from the telephone book stored in COMAND APS.
- the multifunction display shows the **Reading data...** display message below the phone book entries.

When the multifunction display shows the **Updating data...** display message, COMAND APS has finished importing data. The multifunction display then shows all the phone book entries in COMAND APS and the mobile phone.



- ▶ Press the  or  button on the steering wheel to select the **Telephone** menu.
- ▶ Press the ,  or  button to call up the phone book.
- ▶ Press the  or  button to select the desired name.

To scroll rapidly, press and hold the  or  button for longer than one second. After skipping eight entries, the rapid scroll speeds up.

Rapid scrolling stops when you release the button or reach the end of the list.

- ▶ **If only one telephone number is stored for a name:** press the  or  button to start dialling.



or

- ▶ **If there is more than one number for a particular name:** press the  or  button to display the numbers.

- ▶ Press the  or  button to select the number you want to dial.





- ▶ Press the  or  button to start dialling.



or

- ▶ **If you do not want to make a call:** press the  or  button.

Redialling



The on-board computer saves the last names or numbers dialled in the redial memory (**Calls dialled** list).

- ▶ Press the  or  button on the steering wheel to select the **Telephone** menu.
- ▶ Press the  button to switch to the redial memory.
- ▶ Press the  or  button to select the desired name or number.

To scroll rapidly, press and hold the  or  button for longer than one second.

- ▶ Press the  or  button to start dialing.

or





- ▶ **If you do not want to make a call:** press the  or  button.

Assistance menu

Speed Limit Assist

Displaying Speed Limit Assist







In the [Speed Limit Assist](#) function, a detected speed limit is displayed under certain conditions (▷ page 371).

- ▶ Press  or  on the steering wheel to select the [Assistance](#) menu.
- ▶ Press  or  to select [Speed Limit Assist](#).
- ▶ Press .

The multifunction display shows Speed Limit Assist.

Activating/deactivating the Speed Limit Assist message function

You can set Speed Limit Assist (▷ page 371) to display a detected speed limit automatically for five seconds. Other messages in the multifunction display will be faded out for this length of time.





- ▶ Press  or  on the steering wheel to select the [Assistance](#) menu.
 - ▶ Press  or  to select [Speed Limit Assist](#).
 - ▶ Press .
- The multifunction display shows Speed Limit Assist.
- ▶ Press .
- The current selection is displayed.
- ▶ **To activate or deactivate:** press .

If Speed Limit Assist is operational and the message function is activated, the multifunc-

tion display shows the  symbol when the ignition is switched on.

Showing the distance display

This function is only available with DISTRONIC PLUS.

- ▶ Press  or  on the steering wheel to select the [Assistance](#) menu.
 - ▶ Press the  or  button to select [Distance display](#).
 - ▶ Press .
- The DISTRONIC PLUS distance display (▷ page 354) appears in the multifunction display.

Deactivating/activating ESP®

WARNING







If the  warning lamp in the instrument cluster flashes, proceed as follows:

- Under no circumstances should you deactivate ESP®.
- When pulling away, only depress the accelerator pedal as far as is necessary.
- Adapt your driving style to the prevailing road and weather conditions.

The vehicle may otherwise begin to skid.

If you drive too fast, ESP® cannot reduce the risk of an accident. ESP® cannot override the laws of physics.



For further information about ESP®, see (▷ page 72).

- ▶ Start the engine.
 - ▶ Press  or  on the steering wheel to select the [Assistance](#) menu.
 - ▶ Press the  or  button to select [ESP](#).
 - ▶ Press the .
 - ▶ **To deactivate:** press  again.
- The  warning lamp in the instrument cluster comes on.

⚠ WARNING







If the  warning lamp in the instrument cluster lights up when the engine is running, ESP® is deactivated or is unavailable due to a malfunction. The risk that your vehicle may start to skid then increases in certain situations.

Always adapt your driving style to the prevailing road and weather conditions.

- ▶ **To activate:** press  again.
The  warning lamp in the instrument cluster goes out.

Activating/deactivating the PRE-SAFE® Brake







PRE-SAFE® Brake is only available in vehicles with DISTRONIC PLUS.

- ▶ Press  or  on the steering wheel to select the **Assistance** menu.
- ▶ Press  or  to select **PRE-SAFE Brake**.
- ▶ Press the  button.
The current selection is displayed.
- ▶ **To activate/deactivate:** press  again.

When PRE-SAFE® Brake (▷ page 74) is activated, the multifunction display shows the  symbol as long as the HOLD function is not activated (▷ page 357).

Activating/deactivating ATTENTION ASSIST







This function is not available in vehicles with HYBRID.

- ▶ Press  or  on the steering wheel to select the **Assistance** menu.
- ▶ Press the  or  button to select **Attention Assist**.
- ▶ Press .
The current selection is displayed.
- ▶ **To activate/deactivate:** press  again.

When ATTENTION ASSIST (▷ page 370) is activated, the  symbol appears in the multifunction display when the ignition is on.







Activating/deactivating Blind Spot Assist

You can use the **Blind Spot Assist** function to activate or deactivate Blind Spot Assist (▷ page 376) or Active Blind Spot Assist (▷ page 380).

- ▶ Press the  or  button on the steering wheel to select the **Assistance** menu.
- ▶ Press  or  to select **Blind Spot Assist**.
- ▶ Press the  button.
The current selection is displayed.
- ▶ **To activate/deactivate:** press the  button again.

Activating/deactivating Lane Keeping Assist

You can use the **Lane Keeping Assist** function to activate/deactivate Lane Keeping Assist (▷ page 378) or Active Lane Keeping Assist (▷ page 382).

- ▶ Press the  or  button on the steering wheel to select the **Assistance** menu.
- ▶ Press  or  to select **Lane Keeping Assist**.
- ▶ Press the  button.
The current selection is displayed.
- ▶ **To activate/deactivate:** press the  button again.

When Lane Keeping Assist or Active Lane Keeping Assist is activated, the  symbol appears in the multifunction display when the ignition is on.

Service menu

In the **Service** menu, you have the following options:

- calling up display messages (▷ page 409)
- restarting the tyre pressure loss warning system (▷ page 521) or checking the tyre pressure electronically (▷ page 522)
- calling up a service due date (▷ page 482)
- checking the oil level (▷ page 477)



Settings menu



Introduction

The **Settings** menu can be used for:







- switching the daytime driving lights on/off
- switching the Intelligent Light System on/off
- setting the dipped-beam headlamps for driving on the left/right
- switching Adaptive Highbeam Assist on/off
- setting permanent SPEEDTRONIC
- showing or hiding the additional speedometer
- selecting the units for speed and distance
- switching the belt adjustment on/off
- activating/deactivating the radar sensor system

Switching the daytime driving lights on/off

If you have activated the **Daytime driving lights** and the light switch is in the  or  position, the daytime driving lights are automatically switched on when the engine is running. Depending on light conditions, the side lamps and the dipped-beam headlamps will additionally light up.







If you turn the light switch to a different position, the corresponding lights are switched on. If you switch off the daytime driving lights at night, make sure that the light switch is set to  or .

The factory setting is **On**.

- ▶ Switch off the engine.
- ▶ Press the  or  button on the steering wheel to select the **Settings** menu.
- ▶ Press the  or  button to select **Daytime driving lights**.
- ▶ Press the  button to confirm.
- ▶ **To activate/deactivate:** press  again.

Switching the Intelligent Light System on/off

If you activate the **Intell. Light System** function, you activate the following functions:

- motorway mode
- active light function
- cornering light function
- extended range foglamps
- ▶ Press the  or  button on the steering wheel to select the **Settings** menu.
- ▶ Press the  or  button to select **Intell. Light System**.
- ▶ Press the  button to confirm.
- ▶ **To activate/deactivate:** press  again.







If you set the dipped-beam headlamps for driving on the right/left (▷ page 406), the multifunction display shows the **Intelligent Light System System inoperative Inactive for left-side traffic** or **Intelligent Light System System inoperative Inactive for right-side traffic** display message instead of the **Intell. Light System:** function in the **Settings** menu.

Setting the dipped-beam headlamps for driving on the left/right

You can use this function to switch between symmetrical beam and asymmetrical dipped beam (▷ page 290).

If you set the dipped-beam headlamps for driving on the right/left, then motorway







mode and the extended range foglamps are not available.

- ▶ Press the  or  button on the steering wheel to select the **Settings** menu.
- ▶ Press  or  to select **Dipped headlamps**.
- ▶ Press the  button to confirm.
- ▶ Press the  button to save the setting. You can switch between **Right-side traffic** and **Left-side traffic**.

When you change the setting, conversion does not take place until the next time the vehicle is stationary.









You can also have the dipped-beam headlamps set for driving on the right or left at a qualified specialist workshop.

Switching Adaptive Highbeam Assist on/off

- ▶ Press the  or  button on the steering wheel to select the **Settings** menu.
- ▶ Press the  or  button to select **Adapt.Main-beam Asst.**
- ▶ Press the  button to confirm.
- ▶ **To activate/deactivate:** press the  button again.

Setting permanent SPEEDTRONIC

You can set permanent SPEEDTRONIC (▷ page 348) using the **SPEEDTRONIC** function.







- ▶ Press the  or  button on the steering wheel to select the **Settings** menu.
- ▶ Press the  or  button to select **SPEEDTRONIC**.
- ▶ Press the  button to confirm.
- ▶ Press  again.
- ▶ Press  or  to adjust permanent SPEEDTRONIC in increments of 10 km/h (240 km/h to 160 km/h). The **Off** setting switches permanent SPEEDTRONIC off.
- ▶ Press the  button to store the entry.

Switching the additional speedometer on/off

An additional digital speedometer can be shown in the multifunction display.

Vehicles with a kilometre speedometer: the digital speedometer has mph units.

Vehicles with a miles speedometer: the digital speedometer has km/h units.

- ▶ Press the  or  button on the steering wheel to select the **Settings** menu.
- ▶ Press  or  to select **Aux. speedometer**.
- ▶ Press the  button to confirm.
- ▶ Press the  button to save the setting.

Selecting the unit of measurement for distance







The **Display unit Speed-/odometer**:

function allows you to choose whether certain displays appear in kilometres or miles.

The selected unit of measurement for distance applies to:







- analogue speedometers
- digital speedometers in the **Trip** menu
- total distance recorder and the trip meter
- trip computer
- navigation instructions in the **Navi** menu
- cruise control
- SPEEDTRONIC
- DISTRONIC PLUS
- ASSYST PLUS service interval display

The digital speedometer shows alternative speed units (▷ page 407).

- ▶ Press the  or  button on the steering wheel to select the **Settings** menu.
- ▶ Press  or  to select **Units**.
- ▶ Press  to confirm.
- ▶ Press the  button to save the setting. The unit switches **km/h** and **mph**.







Switching the belt adjustment on/off

For further information on belt adjustment, see (▷ page 57).

- ▶ Press the  or  button on the steering wheel to select the **Settings** menu.
- ▶ Press the  or  button to select **Belt adjustment**.
- ▶ Press  to confirm.
- ▶ **To activate/deactivate:** press the  button again.

Activating/deactivating the acoustic locking confirmation

If you activate the **Acoustic Lock Feedb.** function, an audible signal sounds depending on the vehicle's date of manufacture:

- when locking
or
- once when unlocking and three times when locking
- ▶ Press the  or  button on the steering wheel to select the **Settings** menu.
- ▶ Press the  or  button to select **Acoustic Lock Feedb.**
- ▶ Press the  button to confirm.
- ▶ **To activate/deactivate:** press  again.







Activating/deactivating the radar sensor system

- i** You must deactivate the radar sensor system in certain countries and near radio telescope facilities. For further information, see (▷ page 545).

Vehicles with a navigation system: the radar sensor system is deactivated automatically if you are close to radio telescope facilities.

The following systems are switched off when the radar sensor system is deactivated:

- DISTRONIC PLUS (▷ page 348)
- BAS PLUS (▷ page 70)

- PRE-SAFE® Brake (▷ page 74)
- Blind Spot Assist (▷ page 376)
- Active Blind Spot Assist (▷ page 380)
- ▶ Press the  or  button on the steering wheel to select the **Settings** menu.
- ▶ Press  or  to select **Radar sensors**.
- ▶ Press  to confirm.
- ▶ **To activate/deactivate:** press the  button again.

Display messages

General notes

Display messages appear in the multifunction display.

Display messages with graphic displays may be shown in simplified form in the Owner's Manual and may differ from the messages shown in the multifunction display.



Please respond in accordance with the display messages and follow the additional notes in this Owner's Manual.

Certain display messages are accompanied by an audible warning tone or a continuous tone.

When you stop and park the vehicle, please observe the notes on the HOLD function (> page 357) and parking (> page 339).

Hiding display messages

You can hide some display messages with a low priority.

- ▶ Press the  or  button on the steering wheel to hide the display message. The display message is cleared.







Display messages with a low priority are shown in either yellow or white.

Display messages with a high priority are shown in red.

You cannot hide display messages of the highest priority. The multifunction display shows these messages continuously until the causes for the messages have been remedied.

Message memory

The on-board computer saves certain display messages. You can call up the display messages in the **message memory**.

- ▶ Press the  or  button on the steering wheel and select the **Service** menu. If there are display messages, the multifunction display shows, for example, **2 messages**.
- ▶ Press the  or  button to select the entry, e.g. **2 messages**.
- ▶ Confirm with .
- ▶ Press the  or  button to scroll through the display messages.

When the ignition is switched off, all display messages are deleted apart from some high-priority display messages. Once the causes of the high-priority display messages have been rectified, the corresponding display messages are also deleted.

Safety systems

Display messages





currently unavailable See Owner's Manual

Possible causes/consequences and ► Solutions

ABS (Anti-lock Braking System), ESP[®] (Electronic Stability Program), BAS (Brake Assist), PRE-SAFE[®], the HOLD function, hill start assist and ESP[®] trailer stabilisation are temporarily not available.

The adaptive brake lights, BAS PLUS and PRE-SAFE[®] Brake may also have failed.

In addition, the ,  and  warning lamps light up in the instrument cluster.

The self-diagnosis function may not be complete, for example. ATTENTION ASSIST²⁹ is deactivated.

 **WARNING**

The brake system continues to function normally, but without the functions listed above. The wheels could therefore lock if you brake hard, for example.

► Carefully drive on a suitable stretch of road, making slight steering movements, at a speed above 20 km/h.

If the display message disappears, the functions mentioned above are available again.



If the display message continues to be displayed:

► Drive on carefully.

► Visit a qualified specialist workshop.

ABS, ESP[®], BAS, PRE-SAFE[®], the HOLD function, hill start assist and ESP[®] trailer stabilisation are temporarily not available.

The adaptive brake lights, BAS PLUS and PRE-SAFE[®] Brake may also have failed.

In addition, the ,  and  warning lamps light up in the instrument cluster.

For example, the on-board voltage may be insufficient.

ATTENTION ASSIST²⁹ is deactivated.









 **WARNING**

The brake system continues to function normally, but without the functions listed above. The wheels could therefore lock if you brake hard, for example.











► Drive on carefully.

If the display message disappears, the functions mentioned above are available again.







²⁹ Not available on hybrid vehicles.

Display messages	Possible causes/consequences and ► Solutions
	<p>If the display message continues to be displayed:</p> <ul style="list-style-type: none"> ► Drive on carefully. ► Visit a qualified specialist workshop.
<div style="display: flex; align-items: center;">  <div style="margin-left: 10px;"> <p>inoperative See Owner's Manual</p> </div> </div>	<p>ABS, ESP[®], BAS, PRE-SAFE[®], the HOLD function, hill start assist and ESP[®] trailer stabilisation are not available due to a malfunction.</p> <p>The adaptive brake lights, BAS PLUS and PRE-SAFE[®] Brake may also have failed.</p> <p>In addition, the , ,  and  warning lamps light up in the instrument cluster.</p> <p>⚠ WARNING</p> <p>The brake system continues to function normally, but without the functions listed above. The wheels could therefore lock if you brake hard, for example.</p> <p>ATTENTION ASSIST²⁹ is deactivated.</p> <ul style="list-style-type: none"> ► Drive on carefully. ► Visit a qualified specialist workshop immediately.
<div style="display: flex; align-items: center;">  <div style="margin-left: 10px;"> <p>currently inoperative See Owner's Manual</p> </div> </div>	<p>ESP[®], BAS, PRE-SAFE[®], the HOLD function, hill start assist and ESP[®] trailer stabilisation are temporarily not available.</p> <p>The adaptive brake lights, BAS PLUS and PRE-SAFE[®] Brake may also have failed.</p> <p>In addition, the  and  warning lamps light up in the instrument cluster.</p> <p>The self-diagnosis function may not be complete, for example.</p> <p>ATTENTION ASSIST²⁹ is deactivated.</p> <p>⚠ WARNING</p> <p>The brake system continues to function normally, but without the functions listed above.</p> <ul style="list-style-type: none"> ► Carefully drive on a suitable stretch of road, making slight steering movements, at a speed above 20 km/h. <p>If the display message disappears, the functions mentioned above are available again.</p> <p>If the display message continues to be displayed:</p> <ul style="list-style-type: none"> ► Drive on carefully. ► Visit a qualified specialist workshop.





²⁹ Not available on hybrid vehicles.





Display messages	Possible causes/consequences and ► Solutions
	<p> WARNING</p> <p>If the display message is shown and the  warning lamp flashes at the same time, the electronic traction system is deactivated. The brakes of the drive wheels can overheat.</p> <p>► Let the brakes cool down until the display message disappears and the  warning lamp goes out. The electronic traction system is active again.</p>
<p> inoperative See Owner's Manual</p>	<p>ESP®, BAS, PRE-SAFE®, the HOLD function, hill start assist and ESP® trailer stabilisation are not available due to a malfunction. The adaptive brake lights, BAS PLUS and PRE-SAFE® Brake may also have failed.</p> <p>In addition, the  and  warning lamps light up in the instrument cluster.</p> <p>ATTENTION ASSIST²⁹ is deactivated.</p> <p> WARNING</p> <p>The brake system continues to function normally, but without the functions listed above.</p> <p>► Drive on carefully. ► Visit a qualified specialist workshop.</p>
<p> System inoperative</p>	<p> WARNING</p> <p>ESP®, BAS, PRE-SAFE®, the HOLD function, hill start assist and ESP® trailer stabilisation are not available due to a malfunction. The adaptive brake lights, BAS PLUS and PRE-SAFE® Brake may also have failed. In addition, the  and  warning lamps light up in the instrument cluster.</p> <p>ATTENTION ASSIST²⁹ is deactivated.</p> <p>► Drive on carefully. ► Visit a qualified specialist workshop.</p>











²⁹ Not available on hybrid vehicles.



Display messages	Possible causes/consequences and ► Solutions
<div style="display: flex; gap: 10px;"> <div style="border: 1px solid black; padding: 2px; display: inline-block;">EBD</div> <div style="border: 1px solid black; padding: 2px; display: inline-block;">(ABS)</div> </div> <div style="margin-top: 5px;">  </div> <p style="color: #0070C0;">inoperative See Owner's Manual</p>	<p>EBD (electronic brake force distribution), ABS, ESP[®], BAS, PRE-SAFE[®], the HOLD function, hill start assist and ESP[®] trailer stabilisation are not available due to a malfunction.</p> <p>The adaptive brake lights, BAS PLUS and PRE-SAFE[®] Brake may also have failed.</p> <p>In addition, the ,  and  warning lamps light up in the instrument cluster and a warning tone sounds.</p> <p>ATTENTION ASSIST²⁹ is deactivated.</p> <p>⚠ WARNING</p> <p>The brake system continues to function normally, but without the functions listed above. The wheels could therefore lock if you brake hard, for example.</p> <p>The steerability and braking characteristics may be severely affected. The braking distance in an emergency braking situation can increase.</p> <p>If ESP[®] is not operational, ESP[®] is unable to stabilise the vehicle. The danger of skidding and having an accident increases.</p> <ul style="list-style-type: none"> ► Drive on carefully. ► Visit a qualified specialist workshop immediately.
<div style="border: 1px solid black; padding: 2px; display: inline-block;">(P)</div> <p style="color: #0070C0;">Release parking brake</p>	<p>The red  indicator lamp flashes and a warning tone sounds. You are driving with the electric parking brake applied.</p> <ul style="list-style-type: none"> ► Release the electric parking brake. <p>or</p> <ul style="list-style-type: none"> ► Pull away carefully (► page 340). <p>The red  indicator lamp flashes and a warning tone sounds. You are making an emergency stop using the electric parking brake (► page 340).</p> <ul style="list-style-type: none"> ► After the emergency stop: release the electric parking brake lever.











²⁹ Not available on hybrid vehicles.









Display messages	Possible causes/consequences and ► Solutions
	<p>The red  indicator lamp flashes, the yellow  warning lamp lights up and a warning tone sounds.</p> <p>The electric parking brake is faulty and the braking effect is restricted.</p> <p>While the vehicle is in motion:</p> <ul style="list-style-type: none"> ► Release the electric parking brake handle. <p>While the vehicle is stationary:</p> <ul style="list-style-type: none"> ► Switch off the ignition and turn it back on. ► Release the electric parking brake. <p>If the display message continues to be displayed:</p> <ul style="list-style-type: none"> ► Move the transmission selector lever to P. ► Use the folding wheel chock (► page 499) from the vehicle tool kit to secure the vehicle against rolling away. ► Consult a qualified specialist workshop.
<p> Parking brake See Owner's Manual</p>	<p>The yellow  warning lamp lights up. In addition, the red  warning lamp may light up.</p> <p>The electric parking brake is malfunctioning.</p> <p>To release:</p> <ul style="list-style-type: none"> ► Pull the electric parking brake handle. <p>or</p> <ul style="list-style-type: none"> ► Pull away carefully. ► Visit a qualified specialist workshop. <p>To apply:</p> <ul style="list-style-type: none"> ► Switch the ignition off. ► Push the electric parking brake handle for at least ten seconds, until the display message disappears. <p>If the display message continues to be displayed:</p> <ul style="list-style-type: none"> ► Move the transmission selector lever to P. ► Use the folding wheel chock (► page 499) from the vehicle tool kit to secure the vehicle against rolling away. ► Consult a qualified specialist workshop.

Display messages	Possible causes/consequences and ► Solutions
	<p>The red  indicator lamp flashes.</p> <p>The power supply for the electric parking brake was interrupted.</p> <ul style="list-style-type: none"> ► Pull the electric parking brake handle. <p>or</p> <ul style="list-style-type: none"> ► Pull away carefully. <p>or</p> <ul style="list-style-type: none"> ► Pull the electric parking brake handle until the display message disappears.
	<p>The red  indicator lamp flashes and the yellow  warning lamp is lit.</p> <p>The electric parking brake is malfunctioning.</p> <ul style="list-style-type: none"> ► Switch off the ignition and turn it back on. ► Apply or release the electric parking brake. <p>or</p> <ul style="list-style-type: none"> ► Pull away carefully. ► Visit a qualified specialist workshop.
	<p>The yellow  warning lamp lights up. The red  indicator lamp flashes for about ten seconds after the electric parking brake has been applied or released. It then goes out or remains lit.</p> <p>The electric parking brake is malfunctioning, e.g. because of overvoltage or undervoltage.</p> <ul style="list-style-type: none"> ► Pull away carefully. ► Visit a qualified specialist workshop. <p>If there is overvoltage or undervoltage:</p> <ul style="list-style-type: none"> ► Remove the cause for the overvoltage or undervoltage, e.g. by charging the battery or restarting the engine. ► Switch the ignition off and on, and then apply or release the electric parking brake. <p>If this does not release the electric parking brake:</p> <ul style="list-style-type: none"> ► Do not drive on. ► Consult a qualified specialist workshop.

Display messages	Possible causes/consequences and ► Solutions
	<p>The yellow  warning lamp lights up. The red  indicator lamp flashes for about ten seconds after the electric parking brake has been applied or released. It then goes out or remains lit. The electric parking brake has overheated.</p> <ul style="list-style-type: none"> ► Allow the vehicle to cool down. Do not apply or release the electric parking brake during this time. ► Use the folding wheel chock (▷ page 499) from the vehicle tool kit to secure the vehicle against rolling away. ► Once the vehicle has cooled down: switch the ignition off and on again, then apply or release the electric parking brake.
 Parking brake inoperative	<p>The yellow  warning lamp lights up. The red  indicator lamp flashes for about ten seconds after the electric parking brake has been applied or released. It then goes out or remains lit. The electric parking brake is malfunctioning.</p> <ul style="list-style-type: none"> ► Switch the ignition off and on, and then apply the electric parking brake. <p>If it is not possible to apply the electric parking brake:</p> <ul style="list-style-type: none"> ► Move the transmission selector lever to P. ► Use the folding wheel chock (▷ page 499) from the vehicle tool kit to secure the vehicle against rolling away. ► Consult a qualified specialist workshop.
 Turn on the ignition to release the parking brake	<p>The red  indicator lamp is lit. You attempted to release the electric parking brake while the ignition was switched off.</p> <ul style="list-style-type: none"> ► Key: turn the key to position 1 in the ignition lock. ► KEYLESS-GO: switch on the ignition.
 Check brake fluid level	<p>There is insufficient brake fluid in the brake fluid reservoir. In addition, the red  warning lamp lights up in the instrument cluster and a warning tone sounds.</p> <p> WARNING</p> <p>The braking efficiency may be impaired. There is a risk of accident.</p> <ul style="list-style-type: none"> ► Pull over and stop the vehicle safely as soon as possible, paying attention to road and traffic conditions. Do not continue driving under any circumstances. ► Secure the vehicle against rolling away (▷ page 339). ► Consult a qualified specialist workshop. ► Do not top up the brake fluid. This does not correct the error.

Display messages	Possible causes/consequences and ► Solutions
 <p>Service See Owner's Manual</p>	<p>There is a malfunction in the system. The brake system continues to operate normally.</p> <ul style="list-style-type: none"> ► Drive on carefully. ► Visit a qualified specialist workshop.
 <p>Check brake wear</p>	<p>The brake pads/linings have reached their wear limit.</p> <ul style="list-style-type: none"> ► Visit a qualified specialist workshop.
<p>PRE-SAFE inoperative See Owner's Manual</p>	<p>Important functions of PRE-SAFE® have failed. All other occupant safety systems, e.g. airbags, remain available.</p> <ul style="list-style-type: none"> ► Visit a qualified specialist workshop immediately.
<p>PRE-SAFE Function currently limited See Owner's Manual</p>	<p>PRE-SAFE® Brake is temporarily inoperative. Possible causes:</p> <ul style="list-style-type: none"> • the DISTRONIC PLUS cover in the radiator grille is dirty. • the function is impaired due to heavy rain or snow. • the sensors in the bumpers are dirty. • the radar sensor system is temporarily inoperative, e.g. due to electromagnetic radiation emitted by nearby TV or radio stations or other sources of electromagnetic radiation. • the system is outside the operating temperature range. • the on-board voltage is too low. <p>If the display message does not disappear:</p> <ul style="list-style-type: none"> ► Pull over and stop the vehicle safely as soon as possible, paying attention to road and traffic conditions. ► Secure the vehicle against rolling away (▷ page 339). ► Clean the DISTRONIC PLUS cover in the radiator grille (▷ page 487). ► Clean the bumpers (▷ page 487). ► Restart the engine. <p>If the system detects that the sensors are fully operational, the display message disappears.</p> <p>PRE-SAFE® Brake is operational again.</p>
<p>PRE-SAFE Function limited See Owner's Manual</p>	<p>PRE-SAFE® Brake is faulty. BAS PLUS or the distance warning signal may also have failed.</p> <ul style="list-style-type: none"> ► Visit a qualified specialist workshop.
	<p>If the symbol appears in the multifunction display, a seat belt tongue has been inserted into a rear seat belt buckle.</p> <p>For further information on the status indicator for the rear seat belts, (▷ page 58).</p>







Display messages	Possible causes/consequences and ► Solutions
	<p>If the symbol appears in the multifunction display, a seat belt tongue has not been inserted in a rear seat belt buckle.</p> <p> WARNING</p> <p>A seat belt which is not worn correctly, or which has not been engaged in the seat belt buckle correctly, cannot provide the intended level of protection.</p> <p>This poses an increased risk of injury.</p> <p>► If necessary, ask the occupants in the rear to fasten their seat belts.</p> <p>For further information on the status indicator for the rear seat belts, (► page 58).</p>
<p>Child seat in wrong position See Owner's Manual</p>	<p> WARNING</p> <p>Vehicles with automatic child seat recognition on the front-passenger seat: the child seat is positioned incorrectly.</p> <p>► Fit the child seat in the correct position.</p> <p> WARNING</p> <p>Vehicles with automatic child seat recognition on the front-passenger seat: the automatic child seat recognition sensor is faulty.</p> <p>► Visit a qualified specialist workshop.</p>
 <p>Restraint system malfunction Consult workshop</p>	<p>There is a malfunction in the SRS (Supplemental Restraint System). The  warning lamp also lights up in the instrument cluster.</p> <p> WARNING</p> <p>The airbags or belt tensioners may either be triggered unintentionally or, in the event of an accident, may not be triggered.</p> <p>This poses an increased risk of injury.</p> <p>► Visit a qualified specialist workshop.</p>
 <p>Front left-hand side malfunction Consult workshop or Front right-hand side malfunction Consult workshop</p>	<p>SRS has malfunctioned at the front on the left or right. The  warning lamp also lights up in the instrument cluster.</p> <p> WARNING</p> <p>The airbags or belt tensioners may either be triggered unintentionally or, in the event of an accident, may not be triggered.</p> <p>This poses an increased risk of injury.</p> <p>► Visit a qualified specialist workshop.</p>

Display messages	Possible causes/consequences and ► Solutions
 <p>Rear left-hand side malfunction Consult workshop or Rear right-hand side malfunction Consult workshop</p>	<p>SRS has malfunctioned at the rear on the left or right. The  warning lamp also lights up in the instrument cluster.</p> <p> WARNING</p> <p>The airbags or belt tensioners may either be triggered unintentionally or, in the event of an accident, may not be triggered. This poses an increased risk of injury.</p> <p>► Visit a qualified specialist workshop.</p>
 <p>Rear centre malfunction Consult workshop</p>	<p>SRS has malfunctioned at the rear centre. The  warning lamp also lights up in the instrument cluster.</p> <p> WARNING</p> <p>The airbags or belt tensioners may either be triggered unintentionally or, in the event of an accident, may not be triggered. This poses an increased risk of injury.</p> <p>► Visit a qualified specialist workshop.</p>
 <p>Left windowbag malfunction Consult workshop or Right windowbag malfunction Consult workshop</p>	<p>There is a malfunction in the left-hand and/or right-hand windowbag.</p> <p>The  warning lamp also lights up in the instrument cluster.</p> <p> WARNING</p> <p>The left or right windowbag may either be triggered unintentionally or, in the event of an accident, may not be triggered. This poses an increased risk of injury.</p> <p>► Visit a qualified specialist workshop.</p>







Lights



Display messages about LEDs:

This display message will only appear if all LEDs have failed.



Display messages	Possible causes/consequences and ► Solutions
 Left-hand cornering light or Right-hand cornering light	<p>The left or right-hand cornering light is faulty.</p> <ul style="list-style-type: none"> ► Check whether you are permitted to change the bulb yourself (> page 297). or ► Visit a qualified specialist workshop.
 Left-hand dipped beam or Right-hand dipped beam	<p>The left or right-hand dipped-beam headlamp is faulty.</p> <ul style="list-style-type: none"> ► Check whether you are permitted to change the bulb yourself (> page 297). or ► Visit a qualified specialist workshop.
 Trailer Left-hand tail lamp or Trailer Right-hand tail lamp	<p>The left or right-hand trailer tail lamp is faulty.</p> <ul style="list-style-type: none"> ► Check whether you are permitted to change the bulb yourself. or ► Visit a qualified specialist workshop.
 Trailer Left-hand turn signal or Trailer Right-hand turn signal	<p>The left or right-hand trailer turn signal lamp is faulty.</p> <ul style="list-style-type: none"> ► Check whether you are permitted to change the bulb yourself. or ► Visit a qualified specialist workshop.
 Trailer Brake lamp	<p>The trailer brake lamp is faulty.</p> <ul style="list-style-type: none"> ► Check whether you are permitted to change the bulb yourself. or ► Visit a qualified specialist workshop.
 Rear left-hand turn signal or Rear right-hand turn signal	<p>The rear left-hand or rear right-hand turn signal is faulty.</p> <ul style="list-style-type: none"> ► Check whether you are permitted to change the bulb yourself (> page 297). or ► Visit a qualified specialist workshop.
 Front left-hand turn signal or Front right-hand turn signal	<p>The front left-hand or front right-hand turn signal is faulty.</p> <ul style="list-style-type: none"> ► Check whether you are permitted to change the bulb yourself (> page 297). or ► Visit a qualified specialist workshop.





Display messages	Possible causes/consequences and ► Solutions
 <p>Turn signal in left-hand exterior mirror or Turn signal in right-hand exterior mirror</p>	<p>The turn signal in the left-hand or right-hand exterior mirror is faulty.</p> <ul style="list-style-type: none"> ► Check whether you are permitted to change the bulb yourself (▷ page 297). <p>or</p> <ul style="list-style-type: none"> ► Visit a qualified specialist workshop.
 <p>Third brake lamp</p>	<p>The third brake lamp is faulty.</p> <ul style="list-style-type: none"> ► Check whether you are permitted to change the bulb yourself (▷ page 297). <p>or</p> <ul style="list-style-type: none"> ► Visit a qualified specialist workshop.
 <p>Left-hand tail lamp/brake lamp or Right-hand tail lamp/brake lamp</p>	<p>The left or right-hand tail lamp/brake lamp is faulty.</p> <ul style="list-style-type: none"> ► Check whether you are permitted to change the bulb yourself (▷ page 297). <p>or</p> <ul style="list-style-type: none"> ► Visit a qualified specialist workshop.
 <p>Left-hand main beam or Right-hand main beam</p>	<p>The left or right-hand high beam is faulty.</p> <ul style="list-style-type: none"> ► Check whether you are permitted to change the bulb yourself (▷ page 297). <p>or</p> <ul style="list-style-type: none"> ► Visit a qualified specialist workshop.
 <p>Left-hand licence plate lamp or Right-hand licence plate lamp</p>	<p>The left or right-hand licence plate lamp is faulty.</p> <ul style="list-style-type: none"> ► Check whether you are permitted to change the bulb yourself (▷ page 297). <p>or</p> <ul style="list-style-type: none"> ► Visit a qualified specialist workshop.
 <p>Left-hand fog lamp or Right-hand fog lamp</p>	<p>The left-hand or right-hand front fog lamp is faulty.</p> <ul style="list-style-type: none"> ► Check whether you are permitted to change the bulb yourself (▷ page 297). <p>or</p> <ul style="list-style-type: none"> ► Visit a qualified specialist workshop.









Display messages	Possible causes/consequences and ► Solutions
 <p>Rear left-hand foglamp or Rear right-hand foglamp</p>	<p>The left-hand or right-hand rear foglamp is faulty.</p> <ul style="list-style-type: none"> ► Check whether you are permitted to change the bulb yourself (▷ page 297). <p>or</p> <ul style="list-style-type: none"> ► Visit a qualified specialist workshop.
 <p>Front left-hand parking lamp or Front right-hand parking lamp</p>	<p>The front left or front right parking lamp is faulty.</p> <ul style="list-style-type: none"> ► Check whether you are permitted to change the bulb yourself (▷ page 297). <p>or</p> <ul style="list-style-type: none"> ► Visit a qualified specialist workshop.
 <p>Left-hand reversing lamp or Right-hand reversing lamp</p>	<p>The left or right-hand reversing lamp is faulty.</p> <ul style="list-style-type: none"> ► Check whether you are permitted to change the bulb yourself (▷ page 297). <p>or</p> <ul style="list-style-type: none"> ► Visit a qualified specialist workshop.
 <p>Left-hand daytime driving lamp or Right-hand daytime driving lamp</p>	<p>The left or right-hand daytime driving lamp is defective.</p> <ul style="list-style-type: none"> ► Check whether you are permitted to change the bulb yourself (▷ page 297). <p>or</p> <ul style="list-style-type: none"> ► Visit a qualified specialist workshop.
 <p>Intell. Light System inoperative</p>	<p>The Intelligent Light System is faulty. The lights remain available without the Intelligent Light System.</p> <ul style="list-style-type: none"> ► Visit a qualified specialist workshop.
 <p>Malfunction See Owner's Manual</p>	<p>The exterior lighting is faulty.</p> <ul style="list-style-type: none"> ► Visit a qualified specialist workshop. <p>Vehicles with trailer tow hitch: a fuse may have blown.</p> <ul style="list-style-type: none"> ► Check the fuses (▷ page 511). ► If necessary, replace the blown fuse. Observe the warning notes as you do so. <p>If the display message continues to be displayed:</p> <ul style="list-style-type: none"> ► Visit a qualified specialist workshop.





Display messages	Possible causes/consequences and ► Solutions
 <p>AUTO lights inoperative</p>	<p>The light sensor is faulty.</p> <ul style="list-style-type: none"> ► Switch off the daytime driving lights in the on-board computer (> page 406). ► Switch the lights on and off using the light switch. ► Visit a qualified specialist workshop.
 <p>Switch off lights</p>	<p>The lights are still switched on when you leave the vehicle. A warning tone also sounds.</p> <ul style="list-style-type: none"> ► Turn the light switch to <input type="checkbox"/> 0 or <input type="checkbox"/> A. <p>or</p> <ul style="list-style-type: none"> ► If the rear foglamp is switched on: press the light switch in to the stop.
<p>Adaptive Main-beam Assist inoperative</p>	<p>Adaptive Highbeam Assist is faulty.</p> <ul style="list-style-type: none"> ► Visit a qualified specialist workshop.

Engine



Display messages	Possible causes/consequences and ► Solutions
 <p>Top up coolant See Owner's Manual</p>	<p>The coolant level is too low.</p> <ul style="list-style-type: none"> ► Top up the coolant, observing the warning notes when doing so (> page 480). ► If the coolant needs topping up more often than usual, have the engine coolant system checked at a qualified specialist workshop.
	<p>The fan motor is faulty.</p> <ul style="list-style-type: none"> ► If the coolant temperature is below 120 °C, you can continue driving to the nearest qualified specialist workshop. ► Avoid heavy loads on the engine as you do so, e.g. driving in mountainous terrain and stop-start traffic.

Display messages	Possible causes/consequences and ► Solutions
 <p>Coolant Stop vehicle Turn engine off</p>	<p>The coolant is too hot.</p> <ul style="list-style-type: none"> ► Stop the vehicle immediately, paying attention to road and traffic conditions, and switch off the engine. ► Make sure that the air supply to the engine radiator is not blocked, e.g. by frozen slush. ► Wait until the display message disappears before restarting the engine. The engine may otherwise be damaged. ► Pay attention to the coolant temperature display. ► If the temperature increases again, visit a qualified specialist workshop immediately.
	<p>The battery is not being charged.</p> <p>Possible causes:</p> <ul style="list-style-type: none"> • faulty alternator • torn poly-V-belt • a malfunction in the electronics <ul style="list-style-type: none"> ► Stop the vehicle immediately, paying attention to road and traffic conditions, and switch off the engine. ► Open the bonnet. ► Check whether the poly-V-belt is torn. <p>If the poly-V-belt is torn:</p> <p>! Do not continue driving. The engine could otherwise overheat.</p> <ul style="list-style-type: none"> ► Consult a qualified specialist workshop. <p>If the poly-V-belt is OK:</p> <ul style="list-style-type: none"> ► Visit a qualified specialist workshop.
 <p>Check engine oil level when next refuelling</p>	<p>Vehicles with an oil dipstick: the oil level has dropped to the minimum level.</p> <ul style="list-style-type: none"> ► Check the oil level when next refuelling, at the latest (▷ page 477). ► If necessary, top up the engine oil (▷ page 479). ► Have the engine checked at a qualified specialist workshop if the engine oil needs topping up more often than usual.
 <p>Top up with 1 litre of engine oil when next refuelling</p>	<p>Vehicles without an oil dipstick: the engine oil level is too low.</p> <ul style="list-style-type: none"> ► Check the oil level (▷ page 477). ► If necessary, top up the engine oil (▷ page 479). ► Have the engine checked for leaks if the engine oil needs topping up more often than usual.











Display messages	Possible causes/consequences and ► Solutions
 <p>Engine oil level Stop vehicle Turn engine off</p>	<p>Vehicles without an oil dipstick: the engine oil level is too low. There is a risk of engine damage.</p> <ul style="list-style-type: none"> ► Stop the vehicle immediately, paying attention to road and traffic conditions, and switch off the engine. ► Apply the parking brake. ► Top up the engine oil (► page 479) and check the oil level (► page 477).
 <p>Engine oil level Reduce oil level</p>	<p>Vehicles without an oil dipstick: you have added too much engine oil. There is a risk of damage to the engine or to the catalytic converter.</p> <ul style="list-style-type: none"> ► Have the excess oil siphoned off at a qualified specialist workshop. Observe the legal requirements.
 <p>Engine oil level cannot be measured</p>	<p>Vehicles without an oil dipstick: the measuring system is faulty.</p> <ul style="list-style-type: none"> ► Visit a qualified specialist workshop.
 <p>Reserve fuel level</p>	<p>The fuel level has dropped into the reserve range. Operation of the auxiliary heating is deactivated when the fuel level drops into the reserve range.</p> <ul style="list-style-type: none"> ► Refuel at the nearest filling station.
	<p>There is only a very small amount of fuel in the fuel tank. The auxiliary heating cannot be operated.</p> <ul style="list-style-type: none"> ► Refuel at the nearest filling station without fail.
 <p>Replace air cleaner</p>	<p>Vehicles with a diesel engine: the engine air filter is dirty and must be replaced. Vehicles with a diesel engine: there is water in the fuel filter. The water must be drained off.</p> <ul style="list-style-type: none"> ► Visit a qualified specialist workshop.
 <p>Clean fuel filter</p>	<p>Vehicles with a diesel engine: there is water in the fuel filter. The water must be drained off.</p> <ul style="list-style-type: none"> ► Visit a qualified specialist workshop.
 <p>Refill AdBlue at workshop See Own- er's Manual</p>	<p>The AdBlue® level has fallen below the reserve range. A warning tone also sounds.</p> <ul style="list-style-type: none"> ► Have AdBlue® refilled as soon as possible at a qualified specialist workshop.



Display messages	Possible causes/consequences and ► Solutions
 <p>Refill AdBlue at workshop No start in ..km</p>	<p>The AdBlue® level is only sufficient for the indicated distance. A warning tone also sounds.</p> <p>► Have AdBlue® refilled as soon as possible at a qualified specialist workshop.</p>
 <p>Refill AdBlue at workshop Eng. start not poss.</p>	<p>The AdBlue® tank is empty. A warning tone also sounds. You can no longer start the engine.</p> <p>► Consult a qualified specialist workshop immediately.</p>
 <p>Check AdBlue See Owner's Manual</p>	<p>The AdBlue® system is malfunctioning. A warning tone also sounds.</p> <p>► Visit a qualified specialist workshop.</p>
 <p>AdBlue Eng. start not poss. in ..km</p>	<p>The AdBlue® system is malfunctioning. A warning tone also sounds.</p> <p>► Visit a qualified specialist workshop immediately.</p>
 <p>AdBlue Eng. start not poss.</p>	<p>The AdBlue® system is malfunctioning. A warning tone also sounds. You can no longer start the engine.</p> <p>► Consult a qualified specialist workshop immediately.</p>

Driving systems

Display messages	Possible causes/consequences and ► Solutions
 <p>Attention Assist: Drowsiness detected</p>	<p>Based on specific criteria, ATTENTION ASSIST³⁰ has determined that the driver is tired or paying less attention. A warning tone also sounds.</p> <p>► If necessary, take a break.</p> <p>During long journeys, take regular breaks in good time so that you get enough rest.</p>
 <p>Attention Assist inoperative</p>	<p>ATTENTION ASSIST³⁰ has failed.</p> <p>► Visit a qualified specialist workshop.</p>



³⁰ Not available on hybrid vehicles.

Display messages	Possible causes/consequences and ► Solutions
 <p>Night View Assist inoperative</p>	<p>Night View Assist Plus is faulty.</p> <ul style="list-style-type: none"> ► Visit a qualified specialist workshop.
 <p>Night View Assist currently unavailable</p>	<p>The temperature of the camera is too high.</p> <ul style="list-style-type: none"> ► Wait until you see the Night View Assist available again display message. <p>You can also:</p> <ul style="list-style-type: none"> ► Fold the camera cover down (▷ page 487). ► Adjust the air distribution of the automatic air conditioning upwards.
 <p>Night View Assist Lights must be on or set to AUTO</p>	<p>A condition for activating Night View Assist Plus has not been met.</p> <ul style="list-style-type: none"> ► Turn the light switch to A or .
 <p>Night View Assist Not in Reverse</p>	<p>A condition for activating Night View Assist Plus has not been met.</p> <ul style="list-style-type: none"> ► Shift the transmission to P, N or D.
 <p>Night View Assist Lights on or AUTO, not in reverse</p>	<p>A condition for activating Night View Assist Plus has not been met.</p> <ul style="list-style-type: none"> ► Turn the light switch to A or . ► Shift the transmission to P, N or D.
 <p>Night View Assist only when it is dark</p>	<p>You have attempted to activate Night View Assist Plus in the daytime.</p> <p>Night View Assist Plus can only be activated when it is dark.</p>
 <p>Vehicle rising</p>	<p>Your vehicle is adjusting to the level you have selected.</p>
 <p>Vehicle rising Please wait briefly</p>	<p>The vehicle level is too low when the vehicle is stationary. A warning tone also sounds.</p> <ul style="list-style-type: none"> ► Do not pull away. <p>The vehicle level is set when the display message disappears.</p>

Display messages	Possible causes/consequences and ► Solutions
 <p>STOP vehicle Vehicle too low</p>	<p>You have pulled away while the vehicle level is still too low. AIRMATIC sets the vehicle to the selected level after a short period.</p> <ul style="list-style-type: none"> ► Pull over and stop the vehicle safely as soon as possible, paying attention to road and traffic conditions. ► Secure the vehicle against rolling away (▷ page 339). ► Wait until the display message disappears before pulling away. <p>AIRMATIC is faulty. A warning tone also sounds.</p> <ul style="list-style-type: none"> ► Do not drive at speeds above 80 km/h. ► Make only slight steering movements. Otherwise, the front wings or the tyres could be damaged if the steering movement is too large. ► Listen for scraping sounds. ► Pull over and stop the vehicle safely, paying attention to road and traffic conditions, and select a higher vehicle level. Depending on the malfunction, it may be possible to raise the vehicle. ► Visit a qualified specialist workshop.
 <p>Malfunction</p>	<p>The AIRMATIC function is restricted. The vehicle's handling characteristics may be affected.</p> <ul style="list-style-type: none"> ► Do not drive at speeds above 80 km/h. ► Visit a qualified specialist workshop.
<p>ABC Malfunction Stop vehicle</p>	<p>The ABC (Active Body Control) vehicle level is too low.</p> <ul style="list-style-type: none"> ► Pull over and stop the vehicle safely as soon as possible, paying attention to road and traffic conditions. After a few seconds, the vehicle level is adjusted and the display message disappears. <p>The vehicle is leaking oil. The display message is shown continuously.</p> <ul style="list-style-type: none"> ► Pull over and stop the vehicle safely as soon as possible, paying attention to road and traffic conditions. Do not continue driving under any circumstances. ► Consult a qualified specialist workshop.

Display messages	Possible causes/consequences and ► Solutions
	<p>The display message is shown continuously. ABC is malfunctioning.</p> <ul style="list-style-type: none"> ► Do not drive at speeds above 80 km/h. ► Make only slight steering movements. Otherwise, the front wing or the tyre could be damaged if the steering movement is too large. ► Listen for scraping sounds. ► Visit a qualified specialist workshop.
<p>ABC Vehicle rising Please wait briefly</p>	<p>The ABC vehicle level is too low when the vehicle is stationary.</p> <ul style="list-style-type: none"> ► Do not pull away. The vehicle level is set when the display message disappears.
<p>ABC Malfunction</p>	<p>The ABC function is restricted. The vehicle's handling characteristics may be affected.</p> <ul style="list-style-type: none"> ► Do not drive at speeds above 80 km/h. ► Visit a qualified specialist workshop.
<p>Speed Limit Assist currently unavailable See Owner's Manual</p>	<p>Speed Limit Assist is deactivated and temporarily inoperative. Possible causes:</p> <ul style="list-style-type: none"> • the windscreen is dirty in the camera's field of vision. • visibility is impaired due to heavy rain, snow or fog. <p>If the display message does not disappear:</p> <ul style="list-style-type: none"> ► Pull over and stop the vehicle safely as soon as possible, paying attention to road and traffic conditions. ► Secure the vehicle against rolling away (► page 339). ► Clean the windscreen. <p>If the system detects that the camera is fully operational, the display message disappears. Speed Limit Assist is operational again.</p>
<p>Speed Limit Assist Unavailable in this country</p>	<p>Speed Limit Assist is only available in certain countries.</p> <ul style="list-style-type: none"> ► Drive on. Speed Limit Assist is available again when you drive in a country in which its use is approved.
<p>Speed Limit Assist inoperative</p>	<p>Speed Limit Assist is faulty.</p> <ul style="list-style-type: none"> ► Visit a qualified specialist workshop.
<p>HOLD off</p>	<p>The HOLD function is deactivated. The vehicle is skidding. A warning tone also sounds.</p> <ul style="list-style-type: none"> ► Reactivate the HOLD function later (► page 357).

Display messages	Possible causes/consequences and ► Solutions
	<p>The HOLD function is deactivated. When the brake pedal is firmly depressed, an activation condition is not fulfilled.</p> <p>A warning tone also sounds.</p> <p>► Check the activation conditions for the HOLD function (▷ page 357).</p>
<p>Radar sensor deactivated autom. See Owner's Manual</p>	<p>Vehicles with a navigation system: the vehicle is close to a radio telescope facility and is therefore prohibited from transmitting any radar signals. The radar sensor system has switched off automatically (▷ page 545).</p> <p>DISTRONIC PLUS (▷ page 348) is deactivated automatically if it is activated. A warning tone also sounds.</p> <p>Blind Spot Assist (▷ page 376) or Active Blind Spot Assist (▷ page 380) is deactivated automatically if it is activated. The yellow  indicator lamps also light up in the exterior mirrors.</p> <p>BAS PLUS (Brake Assist PLUS) (▷ page 70) and PRE-SAFE® Brake (▷ page 74) are also not available.</p> <p>► Drive on.</p> <p>Once you have moved far enough away from the radio telescope, the above functions are available again.</p>
<p>Radar sensor deactivated See Owner's Manual</p>	<p>The radar sensor system is deactivated.</p> <p>► Check whether or not the radar sensor system may be activated (▷ page 545).</p> <p>► Activate the radar sensor system (▷ page 408).</p>
<p>Lane Keeping Assist currently unavailable See Owner's Manual or Active Lane Keeping Assist currently unavailable See Owner's Manual</p>	<p>Lane Keeping Assist or Active Lane Keeping Assist is deactivated and temporarily inoperative. Possible causes:</p> <ul style="list-style-type: none"> • the windscreen is dirty in the camera's field of vision. • visibility is impaired due to heavy rain, snow or fog. • there are no lane markings for a longer period. • the lane markings are worn, dark or covered, e.g. by dirt or snow. <p>If the display message does not disappear:</p> <p>► Pull over and stop the vehicle safely as soon as possible, paying attention to road and traffic conditions.</p> <p>► Engage the electric parking brake.</p> <p>► Clean the windscreen.</p> <p>If the system detects that the camera is fully operational, the display message disappears.</p> <p>Lane Keeping Assist or Active Lane Keeping Assist is operational again.</p>



Display messages	Possible causes/consequences and ► Solutions
Lane Keeping Assist inoperative or Active Lane Keeping Assist inoperative	<p>Lane Keeping Assist or Active Lane Keeping Assist is faulty.</p> <p>► Visit a qualified specialist workshop.</p>
Blind Spot Assist currently unavailable See Owner's Manual or Active Blind Spot Assist currently unavailable See Owner's Manual	<p>Blind Spot Assist or Active Blind Spot Assist is temporarily inoperative. Possible causes:</p> <ul style="list-style-type: none"> • You have established the electrical connection between the trailer and your vehicle. • the sensors are dirty. • the function is impaired due to heavy rain or snow. • the radar sensor system is outside the operating temperature range. • the radar sensor system is temporarily inoperative, e.g. due to electromagnetic radiation emitted by nearby TV or radio stations or other sources of electromagnetic radiation. <p>The yellow  indicator lamps also light up in the exterior mirrors.</p> <p>► When towing a trailer, confirm the display message with .</p> <p>If you are driving without a trailer and the display message does not disappear:</p> <ul style="list-style-type: none"> ► Pull over and stop the vehicle safely as soon as possible, paying attention to road and traffic conditions. ► Engage the electric parking brake. ► Clean the sensors (▷ page 487). ► Restart the engine. <p>If the system detects that the sensors are fully operational, the display message disappears.</p> <p>Blind Spot Assist or Active Blind Spot Assist is operational again.</p>
Blind Spot Assist inoperative or Active Blind Spot Assist inoperative	<p>Blind Spot Assist or Active Blind Spot Assist is faulty.</p> <p>The yellow  indicator lamps also light up in the exterior mirrors.</p> <p>► Visit a qualified specialist workshop.</p>
Parking Guidance inoperative	<p>Parking Guidance is malfunctioning (▷ page 365).</p> <p>► Restart the engine.</p> <p>If the display message continues to be displayed:</p> <p>► Visit a qualified specialist workshop.</p>



Display messages	Possible causes/consequences and ► Solutions
Parking Guidance cancelled	<p>Parking Guidance is deactivated. Possible causes:</p> <ul style="list-style-type: none"> • the vehicle is skidding. • the sensors are dirty. • a malfunction has occurred. <p>► Reactivate Parking Guidance later (▷ page 365).</p> <p>If the parking space symbol does not appear in the multifunction display at speeds below 30 km/h:</p> <ul style="list-style-type: none"> ► Clean the sensors (▷ page 487). ► Restart the engine. <p>If the parking space symbol still does not appear in the multifunction display at speeds below 30 km/h:</p> <ul style="list-style-type: none"> ► Visit a qualified specialist workshop. <p>Parking Guidance has been deactivated because you are no longer following the recommended path.</p> <ul style="list-style-type: none"> ► Park again and, while doing so, observe the display messages in the multifunction display.
Parking Guidance cancelled	<p>The vehicle is parked. A warning tone also sounds.</p> <p>The display message disappears automatically.</p>
DISTRONIC PLUS off	<p>DISTRONIC PLUS has been deactivated (▷ page 348). If it was deactivated automatically, a warning tone also sounds.</p>
DISTRONIC PLUS available again	<p>DISTRONIC PLUS is operational again after having been temporarily unavailable. You can now reactivate DISTRONIC PLUS (▷ page 348).</p>



Display messages	Possible causes/consequences and ► Solutions
<p>DISTRONIC PLUS currently unavailable See Owner's Manual</p>	<p>DISTRONIC is deactivated and temporarily inoperative. Possible causes:</p> <ul style="list-style-type: none"> • the DISTRONIC PLUS cover in the radiator grille is dirty. • the function is impaired due to heavy rain or snow. • the sensors in the bumpers are dirty. • the radar sensor system is temporarily inoperative, e.g. due to electromagnetic radiation emitted by nearby TV or radio stations or other sources of electromagnetic radiation. • the system is outside the operating temperature range. • the on-board voltage is too low. <p>A warning tone also sounds.</p> <p>If the display message does not disappear:</p> <ul style="list-style-type: none"> ► Pull over and stop the vehicle safely as soon as possible, paying attention to road and traffic conditions. ► Secure the vehicle against rolling away (▷ page 339). ► Clean the DISTRONIC PLUS cover in the radiator grille (▷ page 487). ► Clean the bumpers (▷ page 487). ► Restart the engine. <p>If the system detects that the sensors are fully operational, the display message disappears.</p> <p>DISTRONIC is operational again.</p>
<p>DISTRONIC PLUS inoperative</p>	<p>DISTRONIC PLUS is faulty. BAS PLUS and PRE-SAFE® Brake may also have failed.</p> <p>A warning tone also sounds.</p> <ul style="list-style-type: none"> ► Visit a qualified specialist workshop.
<p>DISTRONIC PLUS override</p>	<p>You have depressed the accelerator pedal. DISTRONIC PLUS is no longer controlling the speed of the vehicle.</p> <ul style="list-style-type: none"> ► Remove your foot from the accelerator pedal.
<p>DISTRONIC PLUS --- km/h</p>	<p>An activation condition for DISTRONIC PLUS is not fulfilled.</p> <ul style="list-style-type: none"> ► Check the activation conditions for DISTRONIC PLUS (▷ page 348).
<p>DISTRONIC PLUS and SPEEDTRONIC inoperative</p>	<p>DISTRONIC PLUS and SPEEDTRONIC are faulty. A warning tone also sounds.</p> <ul style="list-style-type: none"> ► Visit a qualified specialist workshop.

Display messages	Possible causes/consequences and ► Solutions
Cruise control and SPEEDTRONIC inoperative	<p>SPEEDTRONIC and cruise control are malfunctioning. A warning tone also sounds.</p> <p>► Visit a qualified specialist workshop.</p>
Limit --- km/h	<p>While depressing the accelerator pedal beyond the pressure point (kickdown), SPEEDTRONIC cannot be activated.</p>
Cruise control inoperative	<p>Cruise control is faulty.</p> <p>► Visit a qualified specialist workshop.</p>
Cruise control --- km/h	<p>A condition for activating cruise control has not been met. You have tried to store a speed below 30 km/h, for example.</p> <p>► If conditions permit, drive faster than 30 km/h and store the speed.</p> <p>► Check the activation conditions for cruise control (▷ page 344).</p>
120 km/h Maximum speed exceeded	<p>Only for certain countries: the maximum speed has been exceeded.</p> <p>In addition, the multifunction display shows 120 km/h!.</p> <p>► Drive more slowly.</p>

Tyres	
Display messages	Possible causes/consequences and ► Solutions
Tyre pressure Check tyres	<p>The tyre pressure loss warning system has detected a significant loss in pressure.</p> <p>A warning tone also sounds.</p> <p> WARNING</p> <p>With tyre pressures which are too low, there is a risk of the following hazards:</p> <ul style="list-style-type: none"> • the tyres may burst, especially as the load and vehicle speed increase. • the tyres may wear excessively and/or unevenly, which may greatly impair tyre traction. • the driving characteristics, as well as steering and braking, may be greatly impaired. <p>There is a risk of accident.</p> <ul style="list-style-type: none"> ► Stop the vehicle without making any sudden steering or braking manoeuvres. Pay attention to the traffic conditions as you do so. ► Check the tyres and, if necessary, change the wheel (▷ page 524). ► Check the tyre pressures and, if necessary, set to the correct tyre pressure. ► Restart the tyre pressure loss warning system when the tyre pressure is correct (▷ page 521).
Check tyre pressures and then restart Run Flat Indicator	<p>The tyre pressure loss warning system generated a display message and has not been restarted since.</p> <ul style="list-style-type: none"> ► Set the correct tyre pressure in all four tyres. ► Restart the tyre pressure loss warning system (▷ page 521).
Run Flat Indicator inoperative	<p>The tyre pressure loss warning system is faulty.</p> <ul style="list-style-type: none"> ► Visit a qualified specialist workshop.
Tyre pressures displayed after driving a few minutes	<p>The tyre pressure monitor is measuring the tyre pressure.</p> <ul style="list-style-type: none"> ► Drive on. <p>The tyre pressures appear in the multifunction display after you have been driving for a few minutes.</p>
Tyre press. monitor inoperative	<p>The tyre pressure monitor is faulty.</p> <ul style="list-style-type: none"> ► Visit a qualified specialist workshop.

Display messages	Possible causes/consequences and ► Solutions
Tyre press. monitor inoperative No wheel sensors	<p>The wheels fitted do not have a suitable tyre pressure sensor. The tyre pressure monitor is deactivated.</p> <p>► Fit wheels with suitable tyre pressure sensors. The tyre pressure monitor is activated automatically after driving for a few minutes.</p>
Check tyre(s)	<p>The tyre pressure in one or more tyres has dropped significantly. The wheel position is displayed in the multifunction display. A warning tone also sounds.</p> <p> WARNING</p> <p>With tyre pressures which are too low, there is a risk of the following hazards:</p> <ul style="list-style-type: none"> • the tyres may burst, especially as the load and vehicle speed increase. • the tyres may wear excessively and/or unevenly, which may greatly impair tyre traction. • the driving characteristics, as well as steering and braking, may be greatly impaired. <p>There is a risk of accident.</p> <p>► Stop the vehicle without making any sudden steering or braking manoeuvres. Pay attention to the traffic conditions as you do so.</p> <p>► Correct the tyre pressure (▷ page 522).</p> <p>► If necessary, change a wheel (▷ page 524).</p>
Caution, tyre defect	<p>The tyre pressure in one or more tyres has dropped suddenly. The wheel position is displayed in the multifunction display. A warning tone also sounds.</p> <p> WARNING</p> <p>If you drive with a flat tyre, there is a risk of the following hazards:</p> <ul style="list-style-type: none"> • A flat tyre affects the ability to steer or brake the vehicle. • You could lose control of the vehicle. • Continued driving with a flat tyre will cause excessive heat build-up and possibly a fire. <p>There is a risk of accident.</p> <p>► Stop the vehicle without making any sudden steering or braking manoeuvres. Pay attention to the traffic conditions as you do so.</p> <p>► If necessary, change a wheel (▷ page 524).</p>







Display messages	Possible causes/consequences and ► Solutions
Please correct tyre pressure(s)	<p>The tyre pressure is too low in at least one of the tyres, or the tyre pressure difference between the wheels is too great.</p> <p>► Check the tyre pressures at the next opportunity. If necessary, correct the tyre pressure (▷ page 522).</p>
Wheel sensor(s) missing	<p>There is no signal from the tyre pressure sensor of one or several wheels. The pressure of the affected tyre is not displayed in the multifunction display.</p> <p>► Have the faulty tyre pressure sensor replaced at a qualified specialist workshop.</p>
Tyre press. monitor currently unavailable	<p>Due to a source of radio interference, no signals can be received from the wheel sensors. The tyre pressure monitor is temporarily malfunctioning.</p> <p>► Drive on. The tyre pressure monitor restarts automatically as soon as the cause has been rectified.</p>
 <p>Tyre pressure Caution, tyre defect</p>	<p>The tyre pressure in one or more tyres has dropped suddenly.</p> <p> WARNING</p> <p>If you drive with a flat tyre, there is a risk of the following hazards:</p> <ul style="list-style-type: none"> • A flat tyre affects the ability to steer or brake the vehicle. • You could lose control of the vehicle. • Continued driving with a flat tyre will cause excessive heat build-up and possibly a fire. <p>There is a risk of accident.</p> <p>► Stop the vehicle without making any sudden steering or braking manoeuvres. Pay attention to the traffic conditions as you do so.</p> <p>► If necessary, change a wheel (▷ page 524).</p>



Display messages	Possible causes/consequences and ► Solutions
 <p>Tyre pressure Check tyre(s)</p>	<p>The tyre pressure in one or more tyres has dropped significantly.</p> <p> WARNING</p> <p>With tyre pressures which are too low, there is a risk of the following hazards:</p> <ul style="list-style-type: none"> • the tyres may burst, especially as the load and vehicle speed increase. • the tyres may wear excessively and/or unevenly, which may greatly impair tyre traction. • the driving characteristics, as well as steering and braking, may be greatly impaired. <p>There is a risk of accident.</p> <p>► Stop the vehicle without making any sudden steering or braking manoeuvres. Pay attention to the traffic conditions as you do so.</p> <p>► If necessary, change a wheel (▷ page 524).</p> <p>► Check the tyre pressure. If necessary, correct the tyre pressure (▷ page 522).</p>
 <p>Please correct tyre pressure(s)</p>	<p>The tyre pressure is too low in at least one of the tyres, or the tyre pressure difference between the wheels is too great.</p> <p>► Check the tyre pressures at the next opportunity. If necessary, correct the tyre pressure (▷ page 522).</p>

Vehicle





Display messages	Possible causes/consequences and ► Solutions
<p>To start the engine, shift to either P or N</p>	<p>You have attempted to start the engine with the transmission in position R or D.</p> <p>► Shift the transmission to position P or N.</p>
<p>Auxiliary battery malfunction (White display message)</p>	<p>The auxiliary battery for the automatic transmission is no longer being charged.</p> <p>► Visit a qualified specialist workshop.</p>





Display messages	Possible causes/consequences and ► Solutions
Auxiliary battery malfunction (Red display message)	The auxiliary battery for the automatic transmission is discharged. If there is a malfunction in the vehicle's electrical system, you may not be able to change the transmission position. <ul style="list-style-type: none"> ► Pull over and stop the vehicle safely as soon as possible, paying attention to road and traffic conditions. Do not continue driving under any circumstances. ► Consult a qualified specialist workshop.
Apply brake to shift out of position P	You have attempted to move the transmission selector lever to position D , R or N without depressing the brake pedal. <ul style="list-style-type: none"> ► Depress the brake pedal.
Vehicle not in position P	The driver's door is open and the transmission is in position R , N or D . <ul style="list-style-type: none"> ► Shift the transmission to position P. ► Secure the vehicle against rolling away (▷ page 339).
Drive to workshop without changing gear	You cannot change the transmission position due to a malfunction. A warning tone also sounds. If transmission position D is selected: <ul style="list-style-type: none"> ► Drive to a qualified specialist workshop without shifting the transmission from position D. If transmission position R , N or P is selected: <ul style="list-style-type: none"> ► Consult a qualified specialist workshop.
Only select position P when vehicle is stationary	The vehicle is moving. <ul style="list-style-type: none"> ► Pull over and stop the vehicle safely as soon as possible, paying attention to road and traffic conditions. ► Shift the transmission to position P.
	The boot lid is open. <ul style="list-style-type: none"> ► Close the boot lid.

Display messages	Possible causes/consequences and ► Solutions
	<p>The bonnet is open.</p> <p> WARNING</p> <p>The open bonnet may then block your view when the vehicle is in motion.</p> <p>There is a risk of accident.</p> <ul style="list-style-type: none"> ► Pull over and stop the vehicle safely as soon as possible, paying attention to road and traffic conditions. ► Secure the vehicle against rolling away (▷ page 339). ► Close the bonnet.
	<p>At least one door is open.</p> <ul style="list-style-type: none"> ► Close all doors.
 <p>Power steering mal- function See Own- er's Manual</p>	<p>The power steering assistance is faulty.</p> <p> WARNING</p> <p>You will need to use more force to steer.</p> <p>There is a risk of accident.</p> <ul style="list-style-type: none"> ► Check whether you are able to apply the extra force required. ► If you are able to steer safely: carefully drive on to a qualified specialist workshop. ► If you are unable to steer safely: do not drive on. Contact the nearest qualified specialist workshop.
 <p>inoperative Bat- tery low</p>	<p>The on-board voltage is too low. The auxiliary heating has switched itself off or cannot be switched on (▷ page 312).</p> <ul style="list-style-type: none"> ► Drive for a longer distance. The battery is being charged. The auxiliary heating is operational again as soon as the on-board electrical system voltage is sufficient.
 <p>inoperative Refuel vehicle</p>	<p>There is too little fuel in the fuel tank. The auxiliary heating cannot be switched on (▷ page 312).</p> <ul style="list-style-type: none"> ► Refuel at the nearest filling station.

Display messages	Possible causes/consequences and ► Solutions
 <p>inoperative See Owner's Manual</p>	<p>The auxiliary heating has a temporary malfunction or is faulty.</p> <ul style="list-style-type: none"> ► Once the vehicle is on a level surface and the engine has cooled down, make up to four attempts to switch on the auxiliary heating, waiting several minutes between each attempt (▷ page 312). ► If the auxiliary heating does not switch on, consult a qualified specialist workshop.
 <p>Top up washer fluid</p>	<p>The washer fluid level in the washer fluid reservoir has dropped below the minimum.</p> <ul style="list-style-type: none"> ► Top up the washer fluid (▷ page 481).





Key

Display messages	Possible causes/consequences and ► Solutions
 <p>Key does not belong to vehicle</p>	<p>You have put the wrong key in the ignition lock.</p> <ul style="list-style-type: none"> ► Use the correct key.
 <p>Replace key</p>	<p>The key needs to be replaced.</p> <ul style="list-style-type: none"> ► Visit a qualified specialist workshop.
 <p>Change key batteries</p>	<p>The batteries of the KEYLESS-GO key are discharged.</p> <ul style="list-style-type: none"> ► Change the batteries (▷ page 83).
 <p>Key not detected (red display message)</p>	<p>The KEYLESS-GO key is not in the vehicle. A warning tone also sounds.</p> <p>If the engine is switched off, you can no longer lock the vehicle centrally or start the engine.</p> <ul style="list-style-type: none"> ► Pull over and stop the vehicle safely as soon as possible, paying attention to road and traffic conditions. ► Secure the vehicle against rolling away (▷ page 339). ► Locate the KEYLESS-GO key.





Display messages	Possible causes/consequences and ► Solutions
	<p>The KEYLESS-GO key is not detected while the engine is running because there is interference from a strong source of radio waves. A warning tone also sounds.</p> <ul style="list-style-type: none"> ► Pull over and stop the vehicle safely as soon as possible, paying attention to road and traffic conditions. ► Secure the vehicle against rolling away (▷ page 339). ► Operate the vehicle with the key in the ignition lock if necessary.
 <p>Key not detected (white display message)</p>	<p>The KEYLESS-GO key cannot be detected at present.</p> <ul style="list-style-type: none"> ► Change the location of the key with the KEYLESS-GO functions in the vehicle. <p>If the KEYLESS-GO key is still not detected:</p> <ul style="list-style-type: none"> ► Operate the vehicle with the key in the ignition lock if necessary.
 <p>Key still in vehicle</p>	<p>The KEYLESS-GO key has been detected inside the vehicle during locking.</p> <ul style="list-style-type: none"> ► Remove the KEYLESS-GO key from the vehicle.
 <p>Remove starting button, then insert key</p>	<p>KEYLESS-GO is temporarily malfunctioning or is defective.</p> <ul style="list-style-type: none"> ► Insert the key into the ignition lock and turn it to the desired position. ► Visit a qualified specialist workshop.
 <p>Close doors to lock vehicle</p>	<p>At least one door is open. A warning tone also sounds.</p> <ul style="list-style-type: none"> ► Close all doors and lock the vehicle again.

Warning and indicator lamps in the instrument cluster



Seat belts

Problem	Possible causes/consequences and ► Solutions
 <p>Only for certain countries: the red seat belt warning lamp lights up for six seconds after the engine starts.</p>	<p>The seat belt warning lamp reminds the driver and front passenger to fasten their seat belts.</p> <p>► Fasten your seat belt (▷ page 55).</p>
 <p>Only for certain countries: the red seat belt warning lamp lights up after the engine starts. In addition, a warning tone sounds for up to six seconds.</p>	<p>The driver's seat belt is not fastened.</p> <p>► Fasten your seat belt (▷ page 55). The warning tone ceases.</p>
 <p>The red seat belt warning lamp lights up after the engine starts, as soon as the driver's or the front-passenger door is closed.</p>	<p>The driver or front passenger has not fastened their seat belt.</p> <p>► Fasten your seat belt (▷ page 55). The warning lamp goes out.</p> <p>There are objects on the front-passenger seat.</p> <p>► Remove the objects from the front-passenger seat and stow them in a secure place. The warning lamp goes out.</p>
 <p>The red seat belt warning lamp flashes and an intermittent audible warning sounds.</p>	<p>The driver or front passenger has not fastened their seat belt. At the same time, you are driving faster than 25 km/h or have briefly driven faster than 25 km/h.</p> <p>► Fasten your seat belt (▷ page 55). The warning lamp goes out and the intermittent warning tone ceases.</p> <p>There are objects on the front-passenger seat. At the same time, you are driving faster than 25 km/h or have briefly driven faster than 25 km/h.</p> <p>► Remove the objects from the front-passenger seat and stow them in a secure place. The warning lamp goes out and the intermittent warning tone ceases.</p>







Safety systems

Problem	Possible causes/consequences and ► Solutions
 <p>The red brake system warning lamp comes on while the engine is running. A warning tone also sounds.</p>	<p>There is insufficient brake fluid in the fluid reservoir.</p> <p> WARNING</p> <p>The braking efficiency may be impaired. There is a risk of accident.</p> <ul style="list-style-type: none"> ► Pull over and stop the vehicle safely as soon as possible, paying attention to road and traffic conditions. Do not continue driving under any circumstances. ► Engage the electric parking brake. ► Consult a qualified specialist workshop immediately. ► Observe the additional display messages in the multifunction display. <p>Do not top up the brake fluid. This does not correct the error.</p>
 <p>The yellow ABS warning lamp is lit while the engine is running.</p>	<p>ABS (Anti-lock Brake System) has been deactivated due to a fault. For this reason, BAS (Brake Assist), BAS PLUS, ESP® (Electronic Stability Program), PRE-SAFE®, PRE-SAFE® Brake, the HOLD function, hill start assist, the adaptive brake lights and ESP® trailer stabilisation are also deactivated, for example.</p> <p> WARNING</p> <p>The brake system continues to function normally, but without the functions listed above. The wheels could therefore lock if you brake hard, for example.</p> <p>The steerability and braking characteristics may be severely affected. The braking distance in an emergency braking situation can increase.</p> <p>If ESP® is not operational, ESP® is unable to stabilise the vehicle. The danger of skidding and having an accident increases. ATTENTION ASSIST³¹ is deactivated.</p> <ul style="list-style-type: none"> ► Observe the additional display messages in the multifunction display. ► Drive on carefully. ► Visit a qualified specialist workshop.





³¹ Not available on hybrid vehicles.

Problem	Possible causes/consequences and ► Solutions
 <p>The yellow ABS warning lamp is lit while the engine is running.</p>	<p>ABS is temporarily unavailable. Therefore, BAS, BAS PLUS, ESP®, EBD (electronic brake force distribution), PRE-SAFE®, PRE-SAFE® Brake, the HOLD function, hill start assist, the adaptive brake lights and ESP® trailer stabilisation, for example, are also deactivated.</p> <p>Self-diagnosis is not yet complete or the on-board voltage may be insufficient, for example.</p> <p> WARNING</p> <p>The brake system continues to function normally, but without the functions listed above. The wheels could therefore lock if you brake hard, for example.</p> <p>The steerability and braking characteristics may be severely affected. The braking distance in an emergency braking situation can increase.</p> <p>If ESP® is not operational, ESP® is unable to stabilise the vehicle. The danger of skidding and having an accident increases.</p> <p>ATTENTION ASSIST³¹ is deactivated.</p> <ul style="list-style-type: none"> ► Carefully drive on a suitable stretch of road, making slight steering movements at a speed above 20 km/h. The functions mentioned above are available again when the warning lamp goes out. <p>If the warning lamp is still on:</p> <ul style="list-style-type: none"> ► Observe the additional display messages in the multifunction display. ► Drive on carefully. ► Visit a qualified specialist workshop.

³¹ Not available on hybrid vehicles.

Problem	Possible causes/consequences and ► Solutions
 <p>The yellow ABS warning lamp is lit while the engine is running. A warning tone also sounds.</p>	<p>EBD is faulty. Therefore, ABS, BAS, BAS PLUS, ESP[®], PRE-SAFE[®], PRE-SAFE[®] Brake, the HOLD function, hill start assist, the adaptive brake lights and ESP[®] trailer stabilisation, for example, are not available either.</p> <p>ATTENTION ASSIST³¹ is deactivated.</p> <p> WARNING</p> <p>The brake system continues to function normally, but without the functions listed above. The wheels could therefore lock if you brake hard, for example.</p> <p>The steerability and braking characteristics may be severely affected. The braking distance in an emergency braking situation can increase.</p> <p>If ESP[®] is not operational, ESP[®] is unable to stabilise the vehicle. The danger of skidding and having an accident increases.</p> <ul style="list-style-type: none"> ► Observe the additional display messages in the multifunction display. ► Drive on carefully. ► Visit a qualified specialist workshop.
    <p>The red brake warning lamp, the yellow ESP[®] and ESP[®] OFF warning lamps and the yellow ABS warning lamp are lit while the engine is running.</p>	<p>ABS and ESP[®] are malfunctioning. Therefore, BAS, BAS PLUS, EBD, PRE-SAFE[®], PRE-SAFE[®] Brake, the HOLD function, hill start assist, the adaptive brake lights and ESP[®] trailer stabilisation, for example, are not available either.</p> <p>ATTENTION ASSIST³¹ is deactivated.</p> <p> WARNING</p> <p>The brake system continues to function normally, but without the functions listed above. The wheels could therefore lock if you brake hard, for example.</p> <p>The steerability and braking characteristics may be severely affected. The braking distance in an emergency braking situation can increase.</p> <p>If ESP[®] is not operational, ESP[®] is unable to stabilise the vehicle. The danger of skidding and having an accident increases.</p> <ul style="list-style-type: none"> ► Observe the additional display messages in the multifunction display. ► Drive on carefully. ► Visit a qualified specialist workshop.



³¹ Not available on hybrid vehicles.

Problem	Possible causes/consequences and ► Solutions
 <p>The yellow ESP® warning lamp flashes while the vehicle is in motion.</p>	<p>ESP® or traction control has intervened because there is a risk of skidding or at least one wheel has started to spin. Cruise control or DISTRONIC PLUS is deactivated.</p> <ul style="list-style-type: none"> ► Only depress the accelerator pedal as far as necessary when pulling away. ► Accelerate more gently while the vehicle is in motion. ► Adapt your driving style to suit the road and weather conditions. ► Do not deactivate ESP®. <p>For exceptions, see: (► page 72).</p>
 <p>The yellow ESP® OFF warning lamp is lit while the engine is running.</p>	<p>ESP® and ESP® trailer stabilisation are deactivated. ESP® will not stabilise the vehicle if it starts to skid or if a wheel starts to spin.</p> <p> WARNING</p> <p>If ESP® is switched off, ESP® is unable to stabilise the vehicle. The danger of skidding and having an accident increases.</p> <ul style="list-style-type: none"> ► Reactivate ESP®. <p>For exceptions, see: (► page 72).</p> <ul style="list-style-type: none"> ► Adapt your driving style to suit the road and weather conditions. <p>If ESP® cannot be activated:</p> <ul style="list-style-type: none"> ► Have ESP® checked at a qualified specialist workshop.
 <p>The yellow ESP® and ESP® OFF warning lamps are lit while the engine is running.</p>	<p>ESP®, BAS, BAS PLUS, PRE-SAFE®, PRE-SAFE® Brake, the HOLD function, hill start assist, the adaptive brake lights and ESP® trailer stabilisation are not available due to a malfunction. ATTENTION ASSIST³¹ is deactivated.</p> <p> WARNING</p> <p>The brake system continues to function normally, but without the functions listed above. The wheels could therefore lock if you brake hard, for example. The braking distance in an emergency braking situation can increase.</p> <p>If ESP® is not operational, ESP® is unable to stabilise the vehicle. The danger of skidding and having an accident increases.</p> <ul style="list-style-type: none"> ► Observe the additional display messages in the multifunction display. ► Drive on carefully. ► Visit a qualified specialist workshop.

³¹ Not available on hybrid vehicles.



Problem	Possible causes/consequences and ► Solutions
 <p>The yellow ESP® and ESP® OFF warning lamps are lit while the engine is running.</p>	<p>ESP®, BAS, PRE-SAFE®, the HOLD function, hill start assist and ESP® trailer stabilisation are temporarily not available.</p> <p>The adaptive brake lights, BAS PLUS and PRE-SAFE® Brake may also have failed.</p> <p>Self-diagnosis is not yet complete.</p> <p>ATTENTION ASSIST³¹ is deactivated.</p> <p>⚠ WARNING</p> <p>The brake system continues to function normally, but without the functions listed above. The wheels could therefore lock if you brake hard, for example.</p> <p>The braking distance in an emergency braking situation can increase.</p> <p>If ESP® is not operational, ESP® is unable to stabilise the vehicle. The danger of skidding and having an accident increases.</p> <ul style="list-style-type: none"> ► Carefully drive on a suitable stretch of road, making slight steering movements at a speed above 20 km/h. The functions mentioned above are available again when the warning lamp goes out. <p>If the warning lamp is still on:</p> <ul style="list-style-type: none"> ► Observe the additional display messages in the multifunction display. ► Drive on carefully. ► Visit a qualified specialist workshop.



³¹ Not available on hybrid vehicles.

Problem	Possible causes/consequences and ► Solutions
 <p>The red indicator lamp for the electric parking brake flashes and/or the yellow warning lamp for the electric parking brake lights up.</p>	<p>The electric parking brake is temporarily malfunctioning or is defective.</p> <ul style="list-style-type: none"> ► Observe the additional display messages in the multifunction display.
 <p>The red SRS warning lamp is lit while the engine is running.</p>	<p>There is a malfunction in the SRS (Supplemental Restraint System).</p> <p> WARNING</p> <p>The airbags or belt tensioners may either be triggered unintentionally or, in the event of an accident, may not be triggered at all. This poses an increased risk of injury.</p> <ul style="list-style-type: none"> ► Drive on carefully. ► Visit a qualified specialist workshop immediately.

Engine	
Problem	Possible causes/consequences and ► Solutions
 <p>The yellow engine diagnostics warning lamp lights up while the engine is running.</p>	<p>There may be a fault, for example:</p> <ul style="list-style-type: none"> • in the engine management • in the fuel injection system • in the exhaust system • in the ignition system (for vehicles with petrol engines) • in the fuel system <p>The emission limit values may be exceeded and the engine may be running in emergency mode.</p> <p>► Have the vehicle checked as soon as possible at a qualified specialist workshop.</p> <p>Vehicles with a diesel engine: the fuel tank has been run dry (▷ page 338).</p> <p>► Start the engine three to four times after refuelling. If the yellow engine diagnostics warning lamp goes out, emergency running mode is cancelled. The vehicle need not be checked.</p>
<p>The yellow reserve fuel warning lamp lights up while the engine is running.</p>	<p>The fuel level has dropped into the reserve range.</p> <p>Operation of the auxiliary heating is deactivated when the fuel level drops into the reserve range.</p> <p>► Refuel at the nearest filling station.</p>

Driving systems

Problem	Possible causes/consequences and ► Solutions
 <p>The red distance warning lamp lights up while the vehicle is in motion.</p>	<p>The distance to the vehicle in front is too small for the speed selected.</p> <p>► Increase the distance.</p>
 <p>The red distance warning lamp lights up while the vehicle is in motion. A warning tone also sounds.</p>	<p>You are approaching a vehicle or a stationary obstacle in your line of travel at too high a speed.</p> <p>► Be prepared to brake immediately.</p> <p>► Pay careful attention to the traffic situation. You may have to brake or take evasive action.</p> <p>More information about DISTRONIC PLUS (▷ page 348) and PRE-SAFE® Brake (▷ page 74).</p>

Tyres	
Problem	Possible causes/consequences and ► Solutions
 <p>The yellow tyre pressure monitor warning lamp is on.</p>	<p>The tyre pressure monitor has detected a loss of pressure in at least one of the tyres.</p> <p> WARNING</p> <p>With tyre pressures which are too low, there is a risk of the following hazards:</p> <ul style="list-style-type: none"> • the tyres may burst, especially as the load and vehicle speed increase. • the tyres may wear excessively and/or unevenly, which may greatly impair tyre traction. • the driving characteristics, as well as steering and braking, may be greatly impaired. <p>There is a risk of accident.</p> <ul style="list-style-type: none"> ► Stop the vehicle without making any sudden steering or braking manoeuvres. Pay attention to the traffic conditions as you do so. ► Observe the additional display messages in the multifunction display. ► Check the tyre pressure. If necessary, correct the tyre pressure (▷ page 522). ► If necessary, change a wheel (▷ page 524).

Useful information	454
Loading guidelines	454
Stowage areas	454
Features	461

Useful information

- i** This Owner's Manual describes all models and all standard and optional equipment available to your vehicle at the time of publication of the Owner's Manual. Country-specific deviations are possible. Please note that your vehicle may not be equipped with all features described. This also applies to safety-relevant systems and functions.
- i** Please read the information on qualified specialist workshops (▷ page 32).

Loading guidelines

WARNING

Secure and position the load as described in the loading guidelines.

Otherwise, vehicle occupants could be injured by the load being thrown around in the event of sharp braking, a sudden change in direction or an accident.

You will find further information in the "Securing a load" section.

Even if you follow all the loading guidelines, the load will increase the risk of injury in the event of an accident.

WARNING

Keep the boot lid closed while the vehicle is in operation. Otherwise, you could be poisoned by exhaust fumes entering the vehicle.

The handling characteristics of a laden vehicle are dependent on the distribution of the load within the vehicle. For this reason, you should observe the following notes when transporting a load:

- when transporting a load, never exceed the maximum permissible gross vehicle weight

or the permissible axle loads for the vehicle (including occupants).

- position heavy loads as far forwards as possible and as low down in the boot as possible.
- the load must not protrude above the upper edge of the seat backrests.
- always place the load against the rear seat backrests.
- always place the load behind unoccupied seats if possible.
- secure the load with sufficiently strong and wear-resistant lashing material. Pad sharp edges for protection.

- i** Lashing material is available at any qualified specialist workshop.

Stowage areas

Stowage compartments

Important safety notes

WARNING

The stowage compartments must be closed when items are stored in them. Luggage nets are not designed to secure heavy items of luggage.

You or other vehicle occupants could be injured by objects being thrown around if you:

- brake sharply
- change direction suddenly
- have an accident

Sharp-edged and fragile objects must not be carried in the luggage net.

Do not carry hard objects in the ruffled pockets. Objects must not protrude over the top of the ruffled pockets.

Front stowage compartments

Glove compartment

- i** Depending on the vehicle's equipment, you will find the following installed in the glove compartment: an audio and video

AUX jack, a USB socket or Media Interface, a universal interface for portable audio equipment, e.g. for an iPod or USB device, and a bracket for a remote control (see the COMAND section in this Owner's Manual).

- i** The glove compartment can be ventilated (▷ page 318).

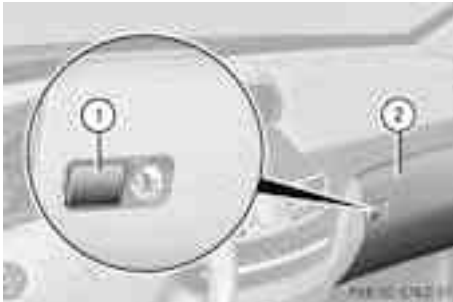

- ▶ **To open:** press button ①.
- ▶ **To close:** fold glove compartment flap ② upwards until it engages.

The glove compartment can only be locked and unlocked using the emergency key element.

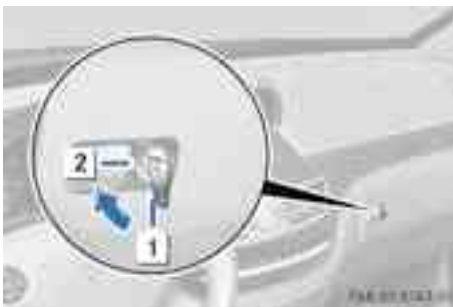

- ① Glove compartment unlocked
- ② Glove compartment locked

Spectacles compartment



- ▶ **To open:** press marking ①.

Stowage compartments in the centre console



Front stowage compartment

- ▶ **To open:** slide the cover forwards by handle ① in the direction of the arrow until it engages.
- ▶ **To close:** briefly press the front of handle ①.



Rear stowage compartment

- ▶ **To open:** press marking ① at the front.

Stowage compartment/telephone compartment under the armrest

- i** In the stowage compartment, there is a partition which can be used to divide up the stowage compartment.



- ▶ **To open the stowage compartment/telephone compartment:** press button (1) and fold the armrest to the left or right.

Stowage compartments in the doors

⚠ WARNING

Keep the stowage compartments in the doors closed. You could otherwise change the position of the seat belt.

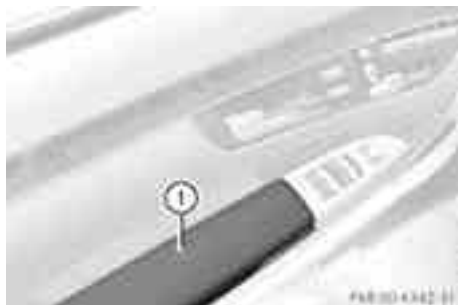

- ▶ **To open:** pull cover (1) upwards.

Coat hook

The coat hooks are located on the left and right in the roof lining in the rear compartment.

- !** Only hang light loads on the coat hooks. Do not place a load of more than 3 kg on the coat hooks.

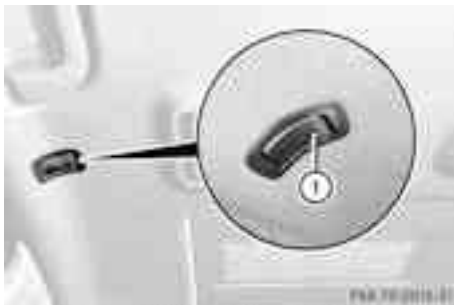

- ▶ **To open:** press coat hook (1). The coat hooks fold out.
- ▶ **To close:** press coat hook (1) until it engages.

Folding table

⚠ WARNING

Keep the folding table closed while the vehicle is in motion. Otherwise, in the event of sharp braking, a sudden change in direction or an accident, you could be injured by objects on the table or by the folding table itself.



- ▶ **To open:** press button (1). Folding table (2) is released.
- ▶ Slowly guide folding table (2) upwards in the direction of the arrow. Folding table (2) engages audibly.
- ▶ Release folding table (2) once it has reached the desired position.

- ▶ **To fold in:** lift folding table ② and guide it downwards.
- ▶ Push folding table ② against the seat back until it engages.

Rear stowage compartments

Stowage compartment in the rear seat armrest



Vehicles without a control panel in the rear seat armrest

- ▶ **To open:** fold down the seat armrest.
- ▶ Pull handle ① and fold the armrests upwards.



Vehicles with a control panel in the rear seat armrest

- ▶ **To open:** press button ① and fold up the armrest.

Stowage box between the rear seats



- ▶ **To open:** pull handle ① backwards in the direction of the arrow.

Stowage box in the rear seat backrest



- ▶ **To open:** fold down the rear seat armrest.
- ▶ Pull handle ① and fold down cover ②.

- i** It will be easier to open the cover when the rear seats are in the basic position.

Luggage nets

⚠ WARNING

Only place lightweight objects in the luggage net. Do not use it to transport heavy, sharp-edged or fragile objects. The luggage net cannot secure the objects sufficiently in the event of an accident.

Luggage nets are located in the front-passenger footwell and on the left and right-hand sides of the boot.

Skibag

Unfolding the skibag and loading skis

WARNING

The skibag is designed to carry up to four pairs of skis. Do not use the skibag to carry any other type of load.

The skibag must always be secured when laden. Otherwise, injuries could be caused by it in the event of an accident.

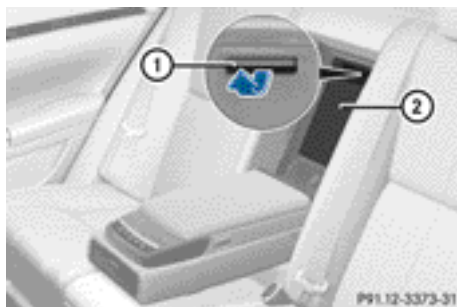

- ▶ Fold down the rear seat armrest.
- ▶ Turn handle ① and pull it upwards in the direction of the arrow.
- ▶ Fold down cover ②.

i It will be easier to open the cover when the rear seats are in the basic position.



- ▶ Pull skibag ① into the vehicle interior and unfold it.
- ▶ Open the boot lid.



- ▶ Pull handle ① on the flap.
- ▶ Fold the flap to the side until it is held in place by the magnet.
- ▶ Slide the skis into the skibag from the boot.



- ▶ Pull strap ① tight by the loose end until the skis are held firmly inside the skibag.



- ▶ Engage hook ① in securing ring ②.
- ▶ Pull the strap tight by the loose end.

Removing the skis and folding up the skibag

- ▶ Loosen the two straps.
 - ▶ Remove hook ① from securing ring ②.
 - ▶ Take the skis out of the skibag.
 - ▶ Close the flap in the boot.
 - ▶ Smooth out the skibag and fold it up.
 - ▶ Put the skibag into the backrest.
 - ▶ Fold the cover back up.
- i** You should always close the flap in the boot if you do not require the skibag. This will prevent unauthorised access to the boot from the vehicle interior.

Removing the skibag

WARNING

When the skibag has been removed, always drive with the boot lid closed. Otherwise, exhaust fumes could enter the vehicle interior.

The skibag can be removed for cleaning or drying.

- ▶ Open the boot lid.

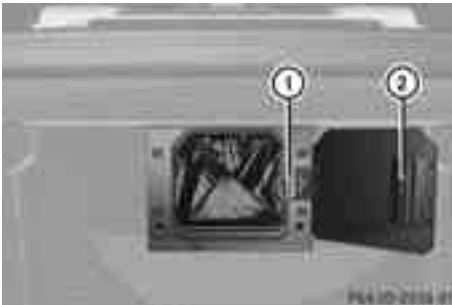

- ▶ Open flap ②.
- ▶ Press recess ① to the left and pull out the frame with the skibag.

Securing a load

Lashing eyelets

WARNING

Distribute the load on the lashing eyelets evenly.

Otherwise, vehicle occupants could be injured by objects being thrown around if you:

- brake sharply
- change direction suddenly
- are involved in an accident

Please observe the loading guidelines.

Observe the following notes on securing loads:

- secure the load using the lashing eyelets.
- do not use elastic straps or nets to secure a load, as these are only intended as an anti-slip protection for light loads.
- do not route lashing materials across sharp edges or corners.
- pad sharp edges for protection.

There are four lashing eyelets in the boot.



Bag hook

WARNING

Only hang light loads on the bag holders. Do not use them to transport heavy, sharp-edged or fragile objects. When braking sharply, changing direction quickly or in the event of an accident, the bag hooks will not secure the items sufficiently. This could result in injury to yourself or others.

! The bag hook can bear a maximum load of 3 kg. Do not use it to secure a load.



► Pull bag hook ② down by tab ①.

Stowage well under the boot floor

Stowage well

On vehicles with TIREFIT or the "Minispare" emergency spare wheel, it is possible to store a suitcase in the stowage well underneath the front part of the boot floor.

! Fold down the suitcase handle before closing the boot. You could otherwise damage the boot lid.



- ① Boot floor
- ② Stowage well for suitcases

Rear stowage compartment

In the S 600 model, you can fold the rear part of the boot floor forwards.



- ① Stowage well
- ② Stowage compartment

Roof carrier

Important safety notes

WARNING

An incorrectly secured roof carrier, ski rack or load could become detached from the vehicle. These objects might then be thrown around, and could injure you or others or cause an accident. Follow the roof carrier/ski rack manufacturer's installation instructions and special instructions for use.

The roof load raises the vehicle's centre of gravity, thereby affecting vehicle handling. You must always observe the maximum roof load of 100 kg. Always adapt your driving style to the prevailing road, traffic and weather conditions and drive with particular care if the roof is laden.

! Mercedes-Benz recommends that you only use roof carriers that have been tested and approved for Mercedes-Benz vehicles. This helps to prevent damage to the vehicle.

Position the load on the roof carrier in such a way that the vehicle will not sustain damage even when it is in motion.

Depending on the vehicle equipment, ensure that when the roof carrier is fitted you can:

- raise the sliding sunroof fully
- open the panorama sliding sunroof fully
- open the boot lid fully

Attaching the roof carrier



- ▶ Open covers ① carefully in the direction of the arrow.
- ▶ Fold covers ① upwards.
- ▶ Only secure the roof carrier to the anchorage points under covers ①.
- ▶ Observe the manufacturer's installation instructions.

Features

Cup holders

Important safety notes

WARNING

Keep the cup holder closed while the vehicle is in motion. Otherwise, vehicle occupants could be injured by objects being thrown around if you:

- brake sharply
- change direction suddenly
- are involved in an accident

Only use the cup holders for containers of a suitable size and which have lids. The drinks could otherwise spill.

Cup holders should not be used for hot drinks. You may otherwise scald yourself.

Cup holder in the front centre console

You can remove the cup holder to clean it. Clean the cup holder with clean, lukewarm water only.



- ▶ **To open:** press marking ① at the front.
- ▶ **To remove:** slide catch ② back and pull the cup holder upwards.
- ▶ **To insert:** insert the cup holder and slide catch ② forwards.

Cup holder in the rear seat armrest

 Do not sit on or support your body weight on the rear seat armrest when it is folded down, as you could otherwise damage it.

 Close the cup holder before folding the rear seat armrest up. Otherwise, the cup holder could be damaged.



Vehicles without multicontour seats in the rear compartment



Vehicles with Rear Seat Entertainment System

- ▶ Fold down the rear seat armrest.
- ▶ **To open:** press the front of cup holder ①. Cup holder ① extends automatically.
- ▶ **To close:** slide the cup holder back until it engages.

Sun visors

Sun visor overview

WARNING

Keep the vanity mirrors in the sun visors covered while driving. You could otherwise be dazzled, which may impair your view of traffic conditions and as a result could cause an accident.



- ① Mirror light
- ② Bracket
- ③ Retaining clip, e.g. for a car park ticket
- ④ Vanity mirror
- ⑤ Mirror cover

Vanity mirror in the sun visor

Mirror light ① only functions if the sun visor is clipped into retainer ② and mirror cover ⑤ has been folded up.

Glare from the side

- ▶ Fold down the sun visor.
- ▶ Pull the sun visor out of retainer ②.
- ▶ Swing the sun visor to the side.

Rear window roller sunblind

Extending/retracting from the driver's seat

- Make sure that the roller sunblind can move freely. Otherwise, the roller sunblind or other objects could be damaged.

At temperatures below - 20 °C, the roller sunblind cannot be operated.



- ▶ **To extend or retract:** briefly press button ①. The roller sunblind fully extends or fully retracts.
- ▶ **To stop:** briefly press button ① again. The roller sunblind stops briefly and moves back into the out-of-use position.

Extending/retracting from the rear

The switch is located on the rear door control panel.



- ▶ **To refit the insert:** press insert ③ into the holder until it engages.
- ▶ **To close:** press cover ① briefly at the front. The cover moves back.

Ashtray in the rear-compartment centre console

The ashtrays are located in the rear doors.



- ▶ **To open:** lift up cover ②.
- ▶ **To remove the insert:** press open cover ② past the stop. Insert ① pops out of the holder.
- ▶ Lift insert ① up and out.
- ▶ **To fit the insert:** fit insert ① from above into the holder and press down into the holder until it engages.

Extending

- ▶ Pull switch ① up and release it. The roller sunblind extends fully.
- ▶ **To stop:** press switch ① down briefly. The roller sunblind stops briefly and then retracts again.

Retracting

- ▶ Press switch ① down past the point of resistance and release it. The roller sunblind retracts fully.
- ▶ **To stop:** pull switch ① up. The roller sunblind stops briefly and then extends again.

Ashtray

Ashtray in the front centre console



- ▶ **To open:** slide cover ① forwards until it engages.
- ▶ **To remove the insert:** hold insert ③ by the ribbing at the sides and lift it up ② and out.

Cigarette lighter

⚠ WARNING

Only hold the hot cigarette lighter by its knob. Otherwise, you might burn yourself.

Make sure that children travelling in the vehicle are not able to injure themselves on the hot cigarette lighter or cause a fire with it.

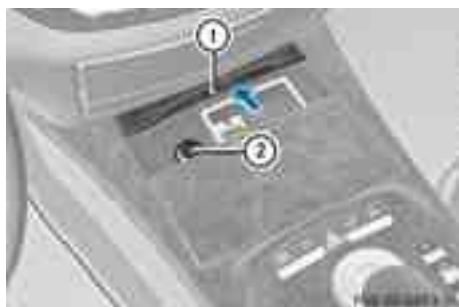

Centre console, front

- ▶ Turn the key to position **2** in the ignition lock.
- ▶ **To open:** slide cover **①** forwards until it engages.
- ▶ Press in cigarette lighter **②**. Cigarette lighter **②** will pop out automatically when the heating element is red-hot.
- ▶ **To close:** press cover **①** briefly at the front. The cover moves back.



Centre console, rear compartment

- ▶ Press in cigarette lighter **①**. Cigarette lighter **①** will pop out automatically when the heating element is red-hot.

12 V sockets

Points to observe before use

The sockets can be used for accessories with a maximum draw of 180 W (15 A). Accessories include such items as lamps or chargers for mobile phones.

If you use the sockets for long periods when the engine is switched off, the battery may discharge.

- ▶ Turn the key to position **1** in the ignition lock.

i An emergency cut-off ensures that the on-board voltage does not drop too low. If the on-board voltage is too low, the power to the sockets is automatically cut. This ensures that there is sufficient power to start the engine.

Socket in the glove compartment



- ▶ Open the glove compartment (▷ page 454).
- ▶ Lift up the cover of socket **①**.

An additional socket is fitted in the centre console on vehicles without an ashtray or a cigarette lighter.

Socket in the front centre console



- ▶ **To open:** slide cover ① forwards until it engages.
- ▶ Lift up the cover of socket ②.
- ▶ **To close:** press cover ① briefly at the front.
The cover moves back.

Socket in the rear-compartment centre console



Example: vehicles with the smoker's package

- ▶ Lift up the cover of socket ①.
- Two sockets are fitted in the rear-compartment centre console on vehicles without an ashtray or a cigarette lighter.

Socket in the boot

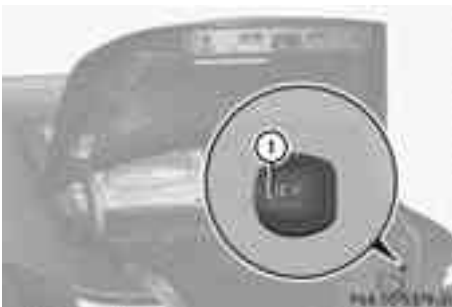

- ▶ Lift up the cover of socket ①.

Coolbox

⚠ WARNING

Do not cover the ventilation grille of the coolbox in the boot and do not transport highly flammable materials in the boot. Otherwise, there is a risk of fire.

The cooling output of the coolbox depends on the ambient temperature and the selected cooling level.

The coolbox reduces its cooling output or switches off, if:

- many electrical consumers are turned on
- the battery has not been sufficiently charged.

This is indicated by the flashing indicator lamp in the switch. The cooling function will automatically switch back on as soon as there is sufficient voltage.

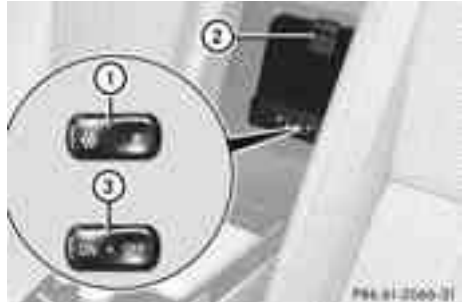

- ▶ **To open:** pull handle ② on the cover.
- ▶ Fold the cover out to the front.
- ▶ **To switch on the cooling:** press switch ③ to ON.
The indicator lamp in the switch flashes for approximately 30seconds and then lights up constantly.
- ▶ **To switch off the cooling:** press switch ③ to OFF.
The indicator lamp in the switch goes out.
- ▶ **To set the cooling level to low or high:** press the left-hand or right-hand side of switch ① respectively.

Caring for the coolbox

If you do not need to use the coolbox for an extended period you should switch it off, defrost it and clean it. After doing so, leave the lid open for a time.

Removing and fitting the coolbox

You can remove the coolbox for maintenance purposes or to fit the skibag (▷ page 458).

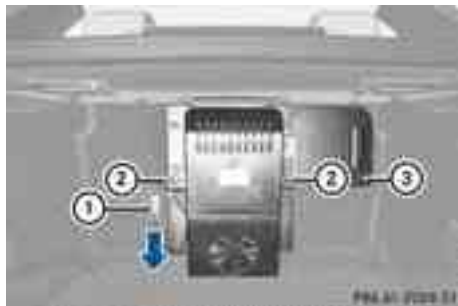

- ▶ **To remove:** switch off the coolbox.
- ▶ Pull plug ① down and out.
- ▶ Unscrew both screws ②.
- ▶ Pull out the coolbox.
- ▶ Close flap ③.
- ▶ **To install:** swing flap ③ to the side until it is locked in place by the magnets.
- ▶ Insert the coolbox.
- ▶ Tighten both screws ②.
- ▶ Connect plug ①.

Mobile phone

Important notes

WARNING

Observe the legal requirements of the country in which you are currently driving regarding operating mobile communications equipment in a vehicle.

If it is permitted by law to operate communications equipment while the vehicle is in motion, you must only do so if the traffic sit-

uation permits. Otherwise, you could be distracted from the traffic conditions, cause an accident and injure yourself and others.

Two-way radios and fax equipment used without low-reflection exterior aerials can interfere with the vehicle's electronics and thereby jeopardise the operating safety of the vehicle and your safety. Therefore, you must only use this equipment if it is correctly connected to a separate reflection-free exterior aerial.

WARNING

Excessive levels of electromagnetic radiation may cause damage to your health and the health of others. Using an exterior aerial takes into account current scientific discussions relating to the possible health risk posed by electromagnetic fields.

Mercedes-Benz recommends the use of an approved exterior aerial. This ensures:

- optimal mobile phone reception quality in the vehicle
- mutual influences between the vehicle electronics and mobile phones are minimised

An exterior aerial has the following advantages:

- it conducts the electromagnetic fields generated by a wireless device to the exterior.
- the field strength in the vehicle interior is lower than in a vehicle that does not have an exterior aerial.

i There are various mobile phone brackets that may be fitted in your vehicle; in some cases, these are country-specific.

i You can connect a Bluetooth®-capable mobile phone with Audio 20 or COMAND APS via the Bluetooth® interface. This is also the case if your vehicle is equipped with convenience telephony.

More information on suitable mobile phones, mobile phone brackets and on connecting Bluetooth®-capable mobile phones with Audio 20 or COMAND APS can be obtained:

- at your Mercedes-Benz Service Centre
- on the Internet at <http://www.mercedes-benz.com/connect>

i The functions and services available when you use the phone depend on your mobile phone model and service provider.

Inserting the mobile phone



- ▶ Open the telephone compartment (▷ page 456).
- ▶ Place the mobile phone bracket into the pre-installed fitting (see the separate installation instructions for the mobile phone fitting).
- ▶ Insert the mobile phone into the mobile phone bracket (see the separate installation instructions for the mobile phone fitting).

If the mobile phone is inserted in the mobile phone bracket, you can speak to the person you are calling using the hands-free system.

i On some mobile phone brackets, you first have to connect the mobile phone via Bluetooth® to the mobile phone bracket (see the separate operating instructions for the mobile phone bracket).

If this is the case, the mobile phone does not have to be inserted into the bracket for you to be able to use the telephone functions. However, the charging function and aerial function are not available.

Operating the mobile phone

You can operate the telephone using the  and  buttons on the multifunction steering wheel. You can operate other mobile phone functions via the on-board computer (▷ page 402).

When you remove the key from the ignition lock, the mobile phone stays switched on.

However, you can no longer use the hands-free system.

If you have an active call and would like to take the key out of the ignition lock, first remove the mobile phone from the bracket. Otherwise, the call is ended.

i When using a bracket connected to the mobile phone via Bluetooth®: if you wish to continue a call in private mode, you will need to perform the necessary steps on the mobile phone. Information can be found in the separate mobile phone operating instructions.

Garage door opener

Important safety notes

The HomeLink® garage door opener integrated in the rear-view mirror allows you to operate up to three different door and gate systems.

i The garage door opener is only available for certain countries. Observe the legal requirements for each individual country.

The HomeLink® garage door opener is compatible with most European garage and gate opener drives. More information on HomeLink® and/or compatible products is available from:

- at a qualified specialised workshop
- the HomeLink® hotline
(0) 08000 466 354 65 (free of charge) or
+49 (0) 6838 907 277 (charges apply)
- on the Internet at:
<http://www.homelink.com>

Programming the integrated garage door opener in the rear-view mirror

Programming buttons

WARNING

Only press the button on the integrated garage door opener if there are no persons or

objects present within the sweep of the garage door. Persons could otherwise be injured as the door moves.



Integrated garage door opener in the rear-view mirror

Garage door remote control ⑤ is not part of the integrated garage door opener.

► Before programming for the first time, clear the memory of the integrated garage door opener (► page 469).

► Turn the key to position **2** in the ignition lock.

► Press and hold one of buttons ② to ④ on the integrated garage door opener. After a short time, indicator lamp ① lights up yellow.

i Indicator lamp ① lights up yellow as soon as button ②, ③ or ④ is programmed for the first time. If the selected button has already been programmed, indicator lamp ① will only light up yellow after ten seconds have elapsed.

► Release button ②, ③ or ④. Indicator lamp ① flashes yellow.

► Point garage door remote control ⑤ towards buttons ② to ④ on the rear-view mirror at a distance of 5 to 20 cm.

i The required distance between remote control ⑤ and the integrated garage door opener depends on the garage door drive system. Several attempts may be required. You should test every position for at least 25 seconds before trying another position.

► Press and hold button ⑥ on remote control ⑤ until indicator lamp ① lights up green. If indicator lamp ① lights up green or flashes, then programming has been successful.

► Release button ⑥ of garage door drive remote control ⑤.

► If indicator lamp ① lights up red: repeat the programming procedure for the corresponding button on the rear-view mirror. When doing so, vary the distance between remote control ⑤ and the rear-view mirror.

i If the indicator lamp flashes green after successful programming, the garage door system is using a rolling code. After programming, you must synchronise the garage door opener integrated in the rear-view mirror with the receiver of the garage door system.

Synchronising the rolling code

Your vehicle must be within range of the garage door or exterior gate drive. Make sure that neither your vehicle nor any persons/objects are present within the sweep of the door or gate.

Observe the safety notes when performing the rolling code synchronisation (► page 467).

Observe the safety notes when performing the rolling code synchronisation.

► Turn the key to position **2** in the ignition lock.

► Press the programming button of the door or gate drive (see the door or gate drive operating instructions, e.g. under "Programming of additional remote controls").

i Usually, you now have 30 seconds to initiate the next step.

► Press previously programmed button ②, ③ or ④ of the integrated garage door opener until the door closes. The rolling code synchronisation is then complete.

Problems when programming

If you have problems when programming the integrated garage door opener, please note the following:

- Check the transmitter frequency of garage door drive remote control (5). This can usually be found on the back of the remote control.
- Replace the batteries in garage door remote control (5). This increases the likelihood that garage door remote control (5) will transmit a strong and precise signal to the integrated garage door opener in the rear-view mirror.
- When programming, hold remote control (5) at varying distances and angles from the button which you are programming. Try various angles at a distance between 5 and 30 cm or at the same angle but at varying distances.
- If there is another remote control for the same garage door drive, perform the programming steps again using this remote control. Before performing these steps, make sure that new batteries have been fitted in garage door drive remote control (5).
- Note that some remote controls transmit only for a limited period (the indicator lamp on the remote control goes out). Press button (6) on remote control (5) again before transmission ends.
- Align the aerial cable of the garage door opener unit. This can improve signal reception/transmission.

Opening or closing the garage door

Once programmed, the integrated garage door opener will assume the function of the garage door system's remote control. Please also read the operating instructions for the garage door system.

- ▶ Turn the key to position **2** in the ignition lock.
- ▶ Press button (2), (3) or (4) which you have programmed to operate the garage door.
 - Garage door system with a fixed code: indicator lamp (1) lights up green.
 - Garage door system with a rolling code: indicator lamp (1) flashes green.

i The transmitter will transmit a signal for as long as the button is pressed. The transmission is halted after a maximum of ten seconds and indicator lamp (1) lights up yellow. Press button (2), (3) or (4) again if necessary.

Clearing the memory of the integrated garage door opener in the rear-view mirror

- ▶ Turn the key to position **2** in the ignition lock.
 - ▶ Press buttons (2) and (4).
 - The indicator lamp lights up yellow.
 - ▶ Press and hold buttons (2) and (4) until the indicator lamp turns green.
- i** Make sure that you clear the memory of the integrated garage door opener before selling the vehicle.

Frequencies for the garage door opener

Europe

Country	Radio type approval number Frequency range (MHz)
AD (Andorra)	20 July MHz: 27, 30, 40, 433, 868
AT (Austria)	Article 6 of Directive 1999/5/EC R&TTE 18 May 05 MHz: 27, 40, 433, 868

Country	Radio type approval number Frequency range (MHz)
BE (Belgium)	Article 6 of Directive 1999/5/EC R&TTE 18 May 05 MHz: 27, 40, 433, 868
BG (Bulgaria)	Article 6 of Directive 1999/5/EC R&TTE 12 April 07 MHz: 27, 40, 433, 868
CH (Switzerland)	Article 6 of Directive 1999/5/EC R&TTE 14357 27 May 05 MHz: 27, 40, 433, 868
CY (Cyprus)	Article 6 of Directive 1999/5/EC R&TTE 5 May 05 MHz: 27, 40, 433, 868
CZ (Czech Republic)	General Licence GL-30/R/2000 Reg. No. 844 13 May 05 MHz: 27, 40, 433
DK (Denmark)	Article 6 of Directive 1999/5/EC R&TTE 20 April 05 MHz: 27, 40, 433, 868
DE (Germany)	Article 6 of Directive 1999/5/EC R&TTE 7519301 29 April 05 MHz: 27, 40, 433, 868
EE (Estonia)	Article 6 of Directive 1999/5/EC R&TTE 11 May 05 MHz: 27, 40, 433, 868

Country	Radio type approval number Frequency range (MHz)
ES (Spain)	000438/2005, 000439/2005, 000440/2005 000441/2005, 000445/2005, 000446/2005 000447/2005 MHz: 27, 40, 433, 868
FI (Finland)	Article 6 of Directive 1999/5/EC R&TTE 10668 13 May 05 MHz: 27, 40, 433, 868
FR (France)	Article 6 of Directive 1999/5/EC R&TTE 10668 13 May 05 27, 30, 40, 433, 868
GI (Gibraltar)	Article 6 of Directive 1999/5/EC R&TTE 13 May 05 (UK) MHz: 27, 40, 418, 433, 868
GR (Greece)	Article 6 of Directive 1999/5/EC R&TTE 11409/18/4/2005 18 May 05 MHz: 27, 40, 433, 868
HR (Croatia)	SDR 224/06 MHz: 27, 40, 433, 868
HU (Hungary)	Article 6 of Directive 1999/5/EC R&TTE 18 May 05 MHz: 27, 40, 433, 868

Country	Radio type approval number Frequency range (MHz)
IC (Canary Islands)	000438/2005, 000439/2005 000440/2005, 000441/2005 000445/2005, 000446/2005 000447/2005, 3rd June 2005 MHz: 27, 40, 433, 868
IE (Ireland)	Article 6 of Directive 1999/5/EC R&TTE 18 May 05 MHz: 27, 40, 433, 868
IS (Iceland)	Article 6 of Directive 1999/5/EC R&TTE 18 May 05 MHz: 27, 40, 433, 868
IT (Italy)	DGPGSR/II/347487/ FOR/15347 DGPGSR/II/347487/ FOR/15348 DGPGSR/II/347487/ FOR/15350 DGPGSR/II/347487/ FOR/15357 DGPGSR/II/347487/ FOR/15358 DGPGSR/II/347487/ FOR/15359 MHz: 27, 40, 433, 868
LI (Liechtenstein)	Article 6 of Directive 1999/5/EC R&TTE 14357 27 May 05 MHz: 27, 40, 433, 868

Country	Radio type approval number Frequency range (MHz)
LT (Lithuania)	Article 6 of Directive 1999/5/EC R&TTE27.4-1B-1609 6 May 05 MHz: 27, 40, 433, 868
LU (Luxembourg)	Article 6 of Directive 1999/5/EC R&TTE150405/9538 24 May 05 MHz: 27, 40, 433, 868
LV (Latvia)	Article 6 of Directive 1999/5/EC R&TTE 27.4-1B-1609 26 April 06 MHz: 27, 40, 433, 868
MC (Monaco)	Article 6 of Directive 1999/5/EC R&TTE10668 13 May 05 MHz: 27, 40, 433, 868
MT (Malta)	Article 6 of Directive 1999/5/EC R&TTE 18 May 05 MHz: 27, 40, 433, 868
NL (Netherlands)	Article 6 of Directive 1999/5/EC R&TTE 18 May 05 MHz: 27, 40, 433, 868
NO (Norway)	Article 6 of Directive 1999/5/EC R&TTE05/02424-SA644 18 May 05 MHz: 27, 40, 433, 868
PL (Poland)	Article 6 of Directive 1999/5/EC R&TTE 21 April 05 MHz: 27, 40, 433, 868
PT (Portugal)	ANCOM-S08399/05 27, 40, 433, 868

Country	Radio type approval number Frequency range (MHz)
RO (Romania)	Article 6.4 of Directive 1999/5/EC R&TTE MHz: 27, 30, 40, 433, 868
RU (Russian Federation)	POCC DE.MJ05.H00015 13 May 05 MHz: 433
SE (Sweden)	Article 6 of Directive 1999/5/EC R&TTE 18 May 05 MHz: 27, 40, 433, 868
SI (Slovenia)	Article 6 of Directive 1999/5/EC R&TTE 500-1/2005-437 9 May 05 MHz: 27, 40, 433, 868
SK (Slovakia)	Article 6 of Directive 1999/5/EC R&TTE Slovak 206/11/2005 4 May 05 MHz: 27, 40, 433, 868
UK (United Kingdom)	Article 6 of Directive 1999/5/EC R&TTE 18 May 05 MHz: 27, 40, 418, 433, 868

Africa

Country	Radio type approval number Frequency range (MHz)
EG (Egypt)	W-KLE-17/08 Mar. 06 MHz: 27, 30, 40, 418, 433, 868
RE (Réunion)	Article 6 of Directive 1999/5/EC R&TTE 11 July 05 MHz: 27, 40, 433, 868
ZA (South Africa)	11 October 2005 MHz: 27, 40, 433

America

Country	Radio type approval number Frequency range (MHz)
BB (Barbados)	Registration not required MHz: 27, 40, 433, 868
CL (Chile)	38447/F-23 No.3.3634 MHz: 40, 433
GF (French Guyana)	Article 6 of Directive 1999/5/EC R&TTE 10668 13 May 05 MHz: 27, 30, 40, 433, 868
GP (Guadeloupe)	Article 6 of Directive 1999/5/EC R&TTE 10668 13 May 05 MHz: 27, 30, 40, 433, 868
MQ (Martinique)	Article 6 of Directive 1999/5/EC R&TTE 11 July 05 MHz: 27, 30, 40, 433, 868
MX (Mexico)	MHz: 280 to 390

Asia

Country	Radio type approval number Frequency range (MHz)
AE (United Arab Emirates)	1623/5/10-2/26/76 MHz: 433
JO (Jordan)	TRC/LPD/2005/23 MHz: 27, 30, 40, 433, 868
KW (Kuwait)	5 October 2005 MHz: 27, 30, 40, 418, 433, 868
LB (Lebanon)	2920/O&M/2006 / 3 July 05 MHz: 27, 40, 433, 868
SA (Saudi Arabia)	11_02_05/5024-5-6 MHz: 418, 433
SY (Syria)	279/4/14 / 05 March 06
TR (Turkey)	National Certification 23 July 07 MHz: 433

The floormats must be correctly secured at all times using the securing knob and retainers. Before you drive off, check the floormats and secure them if necessary. A floormat which is not properly secured can slip and thereby interfere with the movement of the pedals. Do not place floormats on top of one another.

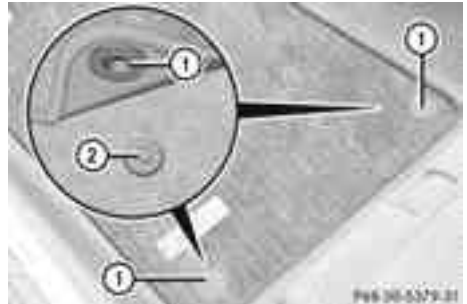

- ▶ Slide the seat backwards.
- ▶ **To fit:** lay the floormat in the footwell.
- ▶ Press studs ① onto retainers ②.
- ▶ **To remove:** pull the floormat off retainers ②.
- ▶ Remove the floormats.

Australia

Country	Radio type approval number Frequency range (MHz)
AU (Australia)	28 June MHz: 27, 30, 40, 433, 868
NZ (New Zealand)	20 March 06 MHz: 27, 30, 40, 433

Infrared reflective windscreen

The infrared reflecting glass prevents the vehicle interior from becoming too hot. It also blocks radio waves up into the gigahertz range.

Floormat on the driver's side

 **WARNING**

Make sure that there is sufficient clearance around the pedals when floormats are used, and that the floormats are properly secured.



Vehicles without Night View Assist Plus

- ① Areas permeable to radio waves (to the left and right of the rain sensor cover)
- ② Rain sensor cover



Vehicles with Night View Assist Plus

- ① Area permeable to radio waves (to the left of the rain sensor cover)
- ② Rain sensor cover

In order to operate radio-controlled equipment, e.g. toll recording systems, areas ① on the windscreen are permeable to radio waves. In these areas, you can install radio-controlled systems.

These areas can best be seen from outside the vehicle by observing the light reflected off the windscreen.

Retrofitted anti-glare film

Anti-glare film retrofitted to the inside of the windows can interfere with radio/mobile phone reception. This is particularly the case for conductive or metallic-coated films. Infor-

mation about anti-glare film can be obtained from any Mercedes-Benz Service Centre.

Useful information	476
Engine compartment	476
Service	481
Care	483

Useful information

- i** This Owner's Manual describes all models and all standard and optional equipment available to your vehicle at the time of publication of the Owner's Manual. Country-specific deviations are possible. Please note that your vehicle may not be equipped with all features described. This also applies to safety-relevant systems and functions.
- i** Please read the information on qualified specialist workshops (▷ page 32).

Engine compartment

Bonnet

Opening the bonnet

WARNING

Do not pull the release lever while the vehicle is in motion. If you do so, the bonnet may open up and block your view.

WARNING

Hybrid vehicles: ensure that you read the "HYBRID" supplement. You could otherwise fail to recognise dangers.

WARNING

There is a risk of injury if the bonnet is open, even if the engine is not running.

Some engine components can become very hot.

To avoid the risk of burns, only touch those components described in the Owner's Manual and observe the relevant safety notes.

WARNING

The radiator fan between the radiator and the engine can start automatically, even if the key has been removed from the ignition lock. For this reason, you must not reach into the fan rotation area. You could otherwise be injured.

Vehicles with a petrol engine: The electronic ignition system uses high voltage. For this reason, you must never touch ignition system components (ignition coil, ignition cables, spark plug connectors or test socket) while:

- the engine is running
- the engine is being started
- the ignition is switched on and the engine is being cranked by hand

You could otherwise suffer an electric shock and be seriously or even fatally injured.

Vehicles with a diesel engine: The electronic injection control uses high voltage. For this reason, you must never touch injection system components while:

- the engine is running
- the engine is being started
- the ignition is switched on

You could otherwise suffer an electric shock and be seriously or even fatally injured.

- ▶ Make sure that the windscreen wipers are switched off.

WARNING

The windscreen wipers and wiper linkage could be set in motion.

When the bonnet is open, you or others could be injured by the wiper linkage.

Make sure that the windscreen wipers are switched off. Remove the key or make sure that no ignition position has been selected with KEYLESS-GO. All indicator lamps must be off in the instrument panel.



- ▶ Pull release lever ① on the bonnet. The bonnet is released.

! Make sure that the windscreen wipers are not folded away from the windscreen. Otherwise, you could damage the windscreen wipers or the bonnet.



- ▶ Pull bonnet catch handle ② outwards from the radiator grille as far as it will go and lift the bonnet from underneath by the radiator grille.

If you lift the bonnet by approximately 40 cm, the bonnet is opened and held open automatically by the gas-filled strut.

! Do not lift the bonnet by bonnet catch handle ②. The handle may otherwise be damaged.

Closing the bonnet

⚠ WARNING

Make sure that nobody can become trapped as you close the bonnet.

- ▶ Lower the bonnet and let it fall from a height of approximately 20 cm.
- ▶ Check that the bonnet has engaged properly. If the bonnet can be raised slightly, it is not properly engaged. Open it again and close it with a little more force.

Radiator

i Vehicles with a diesel engine: do not cover the radiator. Do not use thermal mats, insect protection covers or anything similar. Doing so can cause the Onboard Diagnostics System to display inaccurate values. Some of these values are legally required and must be correct.

Engine oil

Notes on oil level

⚠ WARNING

Hybrid vehicles: ensure that you read the "HYBRID" supplement. You could otherwise fail to recognise dangers.

Depending on driving style, the vehicle consumes up to 0.8 l of oil per 1,000 km. The oil consumption may be higher than this when the vehicle is new or if you frequently drive at high engine speeds.

On vehicles with a 12-cylinder engine, the oil level can be checked using the on-board computer. On all other models, the dipstick must be used to check the engine oil level.

Depending on the engine, the oil dipstick may be installed at a different location.

When checking the oil level:

- park the vehicle on a level surface.
- the engine should be switched off for approximately five minutes if the engine is at normal operating temperature.
- if the engine is not at normal operating temperature, e.g. if the engine was only

started briefly: wait about 30 minutes before carrying out the measurement.

Checking the oil level using the oil dipstick

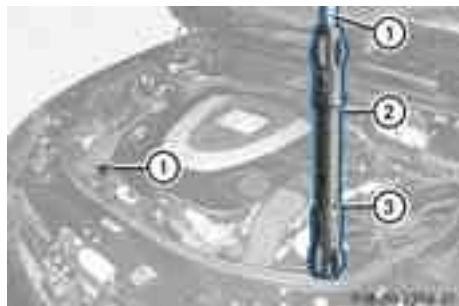

Example: vehicles with a petrol engine

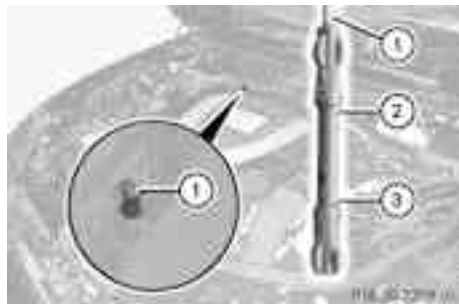

Example: vehicles with 4MATIC

- ▶ Pull oil dipstick ① out of the oil dipstick tube.
- ▶ Wipe off oil dipstick ①.
- ▶ Slowly slide oil dipstick ① into the guide tube to the stop, and take it out again. If the level is between MIN mark ③ and MAX mark ②, the oil level is correct.
- ▶ If the oil level has dropped to MIN mark ③ or below, add 1.0 litre of engine oil.

Checking the oil level using the on-board computer

Measurement

- ▶ Make sure that the key is in position 2 in the ignition lock.
- ▶ Press the or button to select the **Service** menu.
- ▶ Press the or button to select **Engine oil level**.
- ▶ Press the button.

The multifunction display shows the following message: **Engine oil level Measuring now Measurement accurate only if vehicle is level**

- i** If you wish to cancel the measurement, press the button on the multifunction steering wheel.

Display messages

The measurement takes a few seconds. You will see one of the following messages in the multifunction display:

Problem	Possible causes/consequences and ► Solutions
Engine oil level OK	The oil level is correct.
Add 1.0 l engine oil when next refuelling.	The oil level is too low. ► Top up with 1.0 l of engine oil.
Add 1.5 l engine oil when next refuelling.	The oil level is too low. ► Top up with 1.5 l of engine oil.
Add 2.0 l engine oil when next refuelling.	The oil level is too low. ► Top up with 2.0 l of engine oil.
Engine oil level Reduce oil level	The engine oil level is too high. ► Have excess engine oil siphoned off.
For engine oil level, turn on ignition	The ignition is switched off. ► Turn the key to position 2 in the ignition lock.
Waiting period for engine oil level not observed	The required waiting period was not observed. ► If the engine is at normal operating temperature: repeat the measurement after about five minutes. If the engine is not at normal operating temperature (e.g. if the engine was only started briefly): repeat the measurement after about 30 minutes.
Engine oil level Not when engine on	The engine is running; oil level measurement is not possible. ► Switch off the engine. ► If the engine is at normal operating temperature: wait about five minutes before carrying out the measurement. If the engine is not at normal operating temperature, e.g. if the engine was only started briefly: wait approximately 30 minutes before carrying out the measurement.

Adding engine oil

WARNING

If engine oil comes into contact with hot engine parts, it may ignite and you could burn

yourself. Do not spill any engine oil on hot engine parts.

Environmental note

When topping up the oil, take care not to spill any. If oil enters the soil or waterways, it is harmful to the environment.

- ❗ Only use engine oils and oil filters that have been approved for vehicles with a service system. You can obtain a list of the engine oils and oil filters tested and approved in accordance with the Mercedes-Benz Specifications for Service Products at any Mercedes-Benz Service Centre.

Damage to the engine or exhaust system is caused by the following:

- using engine oils and oil filters that have not been specifically approved for the service system
- changing the engine oil and oil filter after missing the change interval required by the service system
- using engine oil additives

- ❗ Do not add too much oil. Topping up with too much engine oil can result in damage to the engine or to the catalytic converter. Have excess engine oil siphoned off.



Example: engine oil filler cap

- ▶ Turn cap ① anti-clockwise and remove it.
- ▶ Top up the engine oil.

Vehicles with oil level measurement in the on-board computer: observe the information in the on-board computer when doing so. Vehicles with oil reservoir dipstick: if the oil level is at or below the MIN mark on

the dipstick, top up with 1.0 litres of engine oil.

- ▶ Replace cap ① on the filler neck and turn clockwise. Make sure that the cap locks securely into place.
- ▶ Check the oil level again with the oil dipstick (▷ page 478) or in the on-board computer (▷ page 478).

For further information on engine oil, see (▷ page 538).

Checking and adding other service products

Checking the coolant level

⚠ WARNING

The cooling system is pressurised. Therefore, only unscrew the cap once the engine has cooled down. The coolant temperature gauge must display less than 70 °C. Otherwise, you could be scalded if hot coolant escapes.



- ▶ Park the vehicle on a level surface. Only check the coolant level if the vehicle is on a level surface and the engine has cooled down.
- ▶ Turn the key to position 2 in the ignition lock (▷ page 323). On vehicles with KEYLESS-GO, press the Start/Stop button twice (▷ page 323).

- ▶ Check the coolant temperature display in the instrument cluster.
The coolant temperature must be below 70 °C.
- ▶ Turn the key to position 0 (▶ page 323) in the ignition lock.
- ▶ Slowly turn cap ① half a turn anti-clockwise to allow excess pressure to escape.
- ▶ Turn cap ① further anti-clockwise and remove it.

If the coolant is at the level of marker bar ③ in the filler neck when cold, there is enough coolant in coolant expansion tank ②.

If the coolant level is approximately 1.5 cm above marker bar ③ in the filler neck when warm, there is enough coolant in coolant expansion tank ②.

- ▶ If necessary, top up with coolant that has been tested and approved by Mercedes-Benz.
- ▶ Replace cap ① and turn it clockwise as far as it will go.

For further information on coolant, see (▶ page 540).

Topping up the windscreen washer system/headlamp cleaning system

⚠ WARNING

Windscreen washer fluid/antifreeze is highly flammable. Avoid spilling windscreen washer fluid/antifreeze on hot engine components as it can ignite and burn. Severe burns could be the result.



Example: washer fluid reservoir

Depending on the engine, the washer fluid reservoir may be installed in different locations.

- ▶ **To open:** pull cap ① upwards by the tab.
- ▶ Top up with the premixed washer fluid.
- ▶ **To close:** press cap ① onto the filler neck until it engages.

The washer fluid reservoir is used for both the windscreen washer system and the headlamp cleaning system.

Further information on windscreen washer fluid/antifreeze (▶ page 540).

Service

ASSYST PLUS service interval display

AdBlue® service indicator

i For BlueTEC vehicles only.

The BlueTEC exhaust gas aftertreatment must be operated with the reducing agent AdBlue® in order for it to function correctly. AdBlue® is topped up as part of the service. Under normal operating conditions, a full tank of AdBlue® should last until the next service due date.

Depending on how and where the vehicle is used, there may be an increase in the AdBlue® consumption, resulting in the next service due date being brought forward.

Certain display messages show that AdBlue® must be topped up, e.g.

Refill AdBlue at workshop See Owner's Manual

Refill AdBlue at workshop No start in .. km

A warning signal also sounds.

You can no longer start the engine when the AdBlue[®] supply has been used up (▷ page 425).





Before taking a trip with your vehicle outside Europe, have the AdBlue[®] supply checked at a qualified specialist workshop. If necessary, have the AdBlue[®] topped up. Before using your vehicle for an extended period in countries outside Europe, contact a qualified specialist workshop.

! Have the AdBlue[®] tank topped up at a qualified specialist workshop only. The vehicle may otherwise be damaged or soiled.

Observe the notes on AdBlue[®] (▷ page 537).

You can obtain further information about BlueTEC exhaust gas aftertreatment and AdBlue[®] from any Mercedes-Benz Service Centre.

Displaying service messages

- ▶ Switch the ignition on.
- ▶ Press  or  on the steering wheel to select the **Service** menu.
- ▶ Press  or  to select the **ASSYST PLUS** submenu and press  to confirm. The service due date appears in the multifunction display.

Hiding a service message

- ▶ Press the  or  button on the steering wheel.

Service messages

Information on the type of service and service intervals (see separate Service Booklet).

You can obtain further information from a Mercedes-Benz Service Centre.

The ASSYST PLUS service interval display informs you when the next service is due.

The multifunction display shows a service message for a few seconds, e.g.:

Next service A due in .. days

Service A due

Service A overdue by .. days

The letter indicates how much time the workshop will require to carry out the service work. The letters displayed range from **A** for a short service duration to **H** for a long service duration.

The ASSYST PLUS service interval display does not take into account any periods of time during which the battery is disconnected.

Maintaining the time-dependent service schedule:

- ▶ Note down the service due date displayed in the multifunction display before disconnecting the battery.

or

- ▶ Subtract the battery disconnection periods from the service date shown on the display after reconnecting the battery.

i The ASSYST PLUS service interval display does not show any information on the engine oil level. Observe the notes on the engine oil level (▷ page 477).

Information about Service

Resetting the ASSYST PLUS service interval display

A qualified specialist workshop, e.g. a Mercedes-Benz Service Centre, will reset the ASSYST PLUS service interval display after the service work has been carried out.

You can obtain further information, e.g. regarding service work, from a Mercedes-Benz Service Centre or directly from Mercedes-Benz.

! If the ASSYST PLUS service interval display has been inadvertently reset, this setting can be corrected at a Mercedes-Benz Service Centre.

Have service work carried out as described in the Service Booklet. This may otherwise lead to increased wear and damage to the major assemblies or the vehicle.

Driving abroad

An extensive Mercedes-Benz Service network is also available in other countries. The Service Hotline's current telephone numbers for use when you are abroad are to be found in the "Mercedes-Benz Service24h" section of the Service Booklet.

Care

Notes on care

Regular care of your vehicle is a condition for retaining the quality in the long term.

Use care products and cleaning agents recommended and approved by Mercedes-Benz.

! For cleaning your vehicle, do not use any of the following:

- dry, rough or hard cloths
- abrasive cleaning agents
- solvents
- cleaning agents containing solvents

Do not scrub.

Do not touch the surfaces or protective films with hard objects, e.g. a ring or ice scraper. You could otherwise scratch or damage the surfaces and protective film.

♻ Environmental note

Dispose of empty packaging and cleaning cloths in an environmentally responsible manner.

! Do not park up the vehicle for an extended period straight after cleaning it, particularly after having cleaned the wheels with wheel cleaner. Wheel cleaners could cause

increased corrosion of the brake discs and brake pads/linings. For this reason, you should drive for a few minutes after cleaning. Braking heats the brake discs and the brake pads/linings, thus drying them. The vehicle can then be parked up.

Care of the exterior

Automatic car wash

WARNING

Braking efficiency is reduced after washing the vehicle. This could cause an accident. For this reason, following a car wash, drive with particular care until the brakes are dry.

WARNING

The vehicle is braked when the HOLD function or DISTRONIC PLUS is activated. Therefore, deactivate the HOLD function and DISTRONIC PLUS before the vehicle is washed in an automatic car wash.

You can wash the vehicle in an automatic car wash from the very start.

Wash off excess dirt before cleaning the vehicle in an automatic car wash.

! In car washes with a towing mechanism, make sure that the automatic transmission is in transmission position **N**, otherwise the vehicle could be damaged.

- Vehicles with a key:
 - do not remove the key from the ignition lock. Do not open the driver's door or front-passenger door when the engine is switched off. Otherwise, the automatic transmission selects park position **P** automatically and locks the wheels. You can prevent this by shifting the automatic transmission to **N** beforehand.
- Vehicles with KEYLESS-GO:
 - do not open the driver's door or front-passenger door when the engine is switched off. Otherwise, the automatic

transmission selects park position **P** automatically and locks the wheels.

Observe the following to make sure that the automatic transmission stays in position **N**:

▶ Make sure the vehicle is stationary and the ignition is switched off.

▶ Turn the key to position **2** (▶ page 323) in the ignition lock.

Use the key instead of the Start/Stop button on vehicles with KEYLESS-GO.

▶ Depress and hold the brake pedal.

▶ Shift the automatic transmission to position **N**.

▶ Release the brake pedal.

▶ Release the electric parking brake.

▶ Switch off the ignition and leave the key in the ignition lock.

! Make sure that:

- the side windows and sliding sunroof are closed completely.
- the blower for the ventilation/heating is switched off (OFF button is depressed).
- the windscreen wiper switch is at position **0**.

The vehicle could otherwise be damaged.

After using an automatic car wash, wipe off wax from the windscreen and the wiper blades. This will prevent smears and reduce wiping noises caused by residue on the windscreen.

Washing by hand

In some countries, washing by hand is only allowed at specially equipped washing bays. Observe the legal requirements for each individual country.

▶ Do not use hot water and do not wash the vehicle in direct sunlight.

▶ Use a soft sponge to clean.

▶ Use a mild cleaning agent, such as a car shampoo approved by Mercedes-Benz.

▶ Thoroughly hose down the vehicle with a gentle jet of water.

▶ Do not point the water jet directly towards the air inlet.

▶ Use plenty of water and rinse out the sponge frequently.

▶ Rinse the vehicle with clean water and dry thoroughly with a chamois.

▶ Do not let the cleaning agent dry on the paintwork.

When using the vehicle in winter, remove all traces of road salt deposits carefully and as soon as possible.

High-pressure cleaning equipment

WARNING

Do not use high-pressure cleaners with circular-jet nozzles (dirt grinders) to clean your vehicle, in particular the tyres. You could otherwise damage the tyres and cause an accident.

! Always maintain a distance of at least 30 cm between the vehicle and the high-pressure cleaner nozzle. Information about the correct distance is available from the equipment manufacturer.

Move the high-pressure cleaner nozzle around when cleaning your vehicle.

Do not aim directly at any of the following:

- tyres
- door gaps, roof gaps, joints etc.
- electrical components
- battery
- connectors
- lights
- seals
- trim elements
- ventilation slots

Damaged seals or electrical components can lead to leaks or failures.

Cleaning the wheels

! Do not use acidic wheel cleaning products to remove brake dust. This could damage wheel bolts and brake components.

! Do not park up the vehicle for an extended period straight after cleaning it, particularly after having cleaned the wheels with wheel cleaner. Wheel cleaners could cause increased corrosion of the brake discs and brake pads/linings. For this reason, you should drive for a few minutes after cleaning. Braking heats the brake discs and the brake pads/linings, thus drying them. The vehicle can then be parked up.

Cleaning the paintwork

Scratches, corrosive deposits, areas affected by corrosion and damage caused by inadequate care cannot always be completely repaired. In such cases, visit a qualified specialist workshop.

- ▶ Remove impurities immediately, where possible, whilst avoiding rubbing too hard.
- ▶ Soak insect remains with insect remover and rinse off the treated areas afterwards.
- ▶ Soak bird droppings with water and rinse off the treated areas afterwards.
- ▶ Remove coolant, brake fluid, tree resin, oils, fuels and greases by rubbing gently with a cloth soaked in petroleum ether or lighter fluid.
- ▶ Use tar remover to remove tar stains.
- ▶ Use silicone remover to remove wax.

! Do not affix:

- stickers
- films
- magnetic plates or similar items

to painted surfaces. You could otherwise damage the paintwork.

Care and treatment of matt paintwork

If your vehicle has a clear matt finish, observe the following instructions in order to avoid damage to the paintwork due to incorrect care.

These notes also apply to light-alloy wheels with a clear matt finish.

! Never polish the vehicle or the light alloy wheels. Polishing makes the paintwork shiny.

! The following may cause the paint to become shiny and thus reduce the matt effect:

- Vigorous rubbing with unsuitable materials.
- Frequent use of car washes.
- Washing the vehicle in direct sunlight.

! Never use paint cleaner, buffing or polishing products, or gloss preserver, e.g. wax. These products are only suitable for high-gloss surfaces. Their use on vehicles with matt finish leads to considerable surface damage (shiny, spotted areas).

Always have paintwork repairs carried out at a qualified specialist workshop.

! Do not use wash programs with a hot wax treatment under any circumstances.

i The vehicle should preferably be washed by hand using a soft sponge, car shampoo and plenty of water.

i Use only insect remover and car shampoo from the range of recommended and approved Mercedes-Benz care products.

Cleaning the windows

WARNING

Switch off the windscreen wipers and remove the key from the ignition lock before cleaning the windscreen or the wiper blades. On vehicles with KEYLESS-GO, press the Start/Stop button repeatedly until all indicator lamps in the instrument cluster have gone off. The

windscreen wipers could otherwise move and injure you.

- ❗ Only fold the windscreen wipers away from the windscreen when vertical. Otherwise, you will damage the bonnet.
- ▶ Clean the inside and outside of the windows with a damp cloth and a cleaning agent that is recommended and approved by Mercedes-Benz.
- ❗ Do not use dry cloths, abrasive products, solvents or cleaning agents containing solvents to clean the inside of the windows. Do not touch the insides of the windows with hard objects, e.g. an ice scraper or ring. There is otherwise a risk of damaging the windows.
- ❗ Clean the water drainage channels of the windscreen and the rear window at regular intervals. Deposits such as leaves, petals and pollen may under certain circumstances prevent water from draining away. This can lead to corrosion damage and damage to electronic components.

Cleaning the wiper blades

WARNING

Switch off the windscreen wipers and remove the key from the ignition lock before cleaning the windscreen or the wiper blades. On vehicles with KEYLESS-GO, press the Start/Stop button repeatedly until all indicator lamps in the instrument cluster have gone off. The windscreen wipers could otherwise move and injure you.

- ❗ Only fold the windscreen wipers away from the windscreen when vertical. Otherwise, you will damage the bonnet.
- ❗ Do not pull on the wiper blade. Otherwise, the wiper blade could be damaged.
- ❗ Do not clean wiper blades too often and do not rub them too hard. Otherwise, the

graphite coating could be damaged. This could cause wiper noise.

- ▶ Fold the wiper arms away from the windscreen.
- ▶ Clean the wiper blades carefully using a damp cloth.
- ▶ Fold the windscreen wipers back again before switching on the ignition.
- ❗ Hold the wiper arm securely when folding back. The windscreen could be damaged if the wiper arm hits against it suddenly.

Cleaning the exterior lighting

- ❗ Only use cleaning agents or cleaning cloths that are suitable for plastic lenses. Unsuitable cleaning agents or cleaning cloths could scratch or damage the plastic lenses of the exterior lighting.
- ▶ Clean the plastic lenses of the exterior lighting using a wet sponge and a mild cleaning agent, e.g. Mercedes-Benz car shampoo. Or clean the exterior lighting with cleaning cloths.

Cleaning the mirror turn signal

- ❗ Only use cleaning agents or cleaning cloths that are suitable for plastic lenses. Unsuitable cleaning agents or cleaning cloths could scratch or damage the plastic lenses of the mirror turn signals.
- ▶ Clean the plastic lenses of the mirror turn signals using a wet sponge and a mild cleaning agent, e.g. Mercedes-Benz car shampoo. Cleaning cloths may be used as well.

Cleaning the sensors

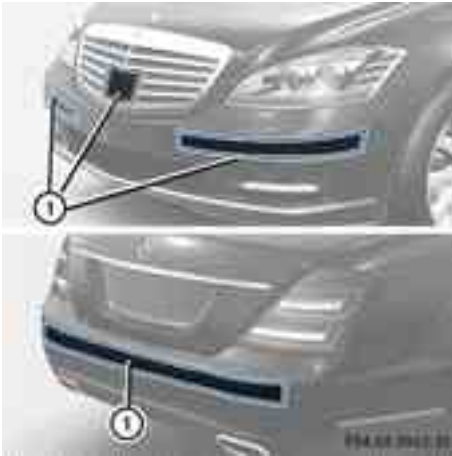

- ▶ Clean sensors ① of the driving systems with water, car shampoo and a soft cloth.
- ❗ If you clean the sensors with a high-pressure cleaner, make sure that you keep a distance of at least 30 cm between the vehicle and the high-pressure cleaner nozzle. Information about the correct distance is available from the equipment manufacturer.

Cleaning the reversing camera

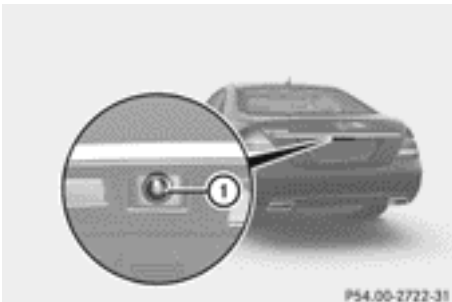

- ▶ Use clear water and a soft cloth to clean camera lens ①.
- ❗ Do not clean the camera lens and the area around the reversing camera with a high-pressure cleaner.

Cleaning the exhaust tail pipes

Impurities combined with the effects of road grit and corrosive environmental factors may cause flash rust to form on the surface. You can restore the original shine of the exhaust tail pipe by cleaning it regularly, especially in winter and after washing.

- ❗ Do not clean the exhaust tail pipes with alkaline-based cleaning agents, such as wheel cleaner.
- ▶ Clean the exhaust tail pipes with a chrome care product tested and approved by Mercedes-Benz.

Interior care

Cleaning the display

- ▶ Before cleaning the display, make sure that it is switched off and has cooled down.
 - ▶ Clean the display surface using a commercially-available microfibre cloth and TFT/LCD display cleaner.
 - ▶ Dry the display surface using a dry microfibre cloth.
 - ❗ For cleaning, do not use any of the following:
 - alcohol-based thinner or petrol
 - abrasive cleaning agents
 - commercially-available household cleaning agents
- These may damage the display surface. Do not put pressure on the display surface when cleaning. This could lead to irreparable damage to the display.

Cleaning Night View Assist Plus

- ❗ Never clean the camera lens. When cleaning the field of vision of the driving systems, make sure that you do not spray glass cleaner on the camera lens. If the camera lens is dirty, visit a qualified specialist workshop.



- ▶ Fold down the camera cover by recess ①.



- ▶ Use a soft cloth to clean the windscreen in front of camera ②.

Cleaning the plastic trim

WARNING

When cleaning the steering wheel boss and dashboard, do not use cockpit sprays or cleaning agents containing solvents. Cleaning agents containing solvents cause the surface to become porous, and as a result plastic parts may break away and be thrown around the interior when an airbag is deployed, which may result in severe injuries.

- ❗ Do not affix the following to plastic surfaces:

- stickers
- films
- scented oil bottles or similar items

You could otherwise damage the plastic.

- ❗ Do not allow cosmetics, insect repellent or sunscreen to come in contact with the

plastic trim. This maintains the high-quality look of the surfaces.

- ▶ Wipe the plastic trim with a damp, lint-free cloth, e.g. a microfibre cloth.
- ▶ **Heavy soiling:** use car care and cleaning products recommended and approved by Mercedes-Benz. The surface may change colour temporarily. Wait until the surface is dry again.

Cleaning the steering wheel and gear or selector lever

- ▶ Thoroughly wipe with a damp cloth or use leather care agents that have been recommended and approved by Mercedes-Benz.

Cleaning wooden trim and trim elements

- ▶ Wipe the wooden trim and trim pieces with a damp, lint-free cloth, e.g. a microfibre cloth.
- ▶ **Heavy soiling:** use car care and cleaning products recommended and approved by Mercedes-Benz.

- ❗ Do not use solvent-based cleaning agents such as tar remover, wheel cleaners, polishes or waxes. There is otherwise a risk of damaging the surface.

Cleaning the seat covers

- ❗ Do not use microfibre cloths to clean genuine leather, artificial leather or Alcantara® covers. If used often, these can damage the cover.
- ❗ Observe the following when cleaning:
 - clean genuine leather covers carefully with a damp cloth and then wipe the covers down with a dry cloth. Make sure that the leather does not become soaked. It may otherwise become rough and cracked. Only use leather care agents that have been tested and approved by

Mercedes-Benz. You can obtain these from a qualified specialist workshop.

- clean artificial leather covers with a cloth moistened with a solution containing 1% detergent (e.g. washing-up liquid).
- clean cloth covers with a microfibre cloth moistened with a solution containing 1% detergent (e.g. washing-up liquid). Rub carefully and always wipe entire seat sections to avoid leaving visible lines. Leave the seat to dry afterwards. Cleaning results depend on the type of dirt and how long it has been there.
- clean Alcantara® covers with a damp cloth. Make sure that you wipe entire seat sections to avoid leaving visible lines.

i Note that regular care is essential to make sure that the appearance and comfort of the covers are retained over time.

Cleaning the seat belts

- ▶ Use clean, lukewarm water and soap solution.

! Do not clean the seat belts using chemical cleaning agents. Do not dry the seat belts at temperatures above 80 °C or in direct sunlight.

Cleaning the roof lining and carpets

- ▶ **Roof lining:** use a soft brush or a cleaning agent recommended and approved by Mercedes-Benz to remove heavy soiling.
- ▶ **Carpets:** use the carpet and textile cleaning agents recommended and approved by Mercedes-Benz.

Useful information	492
Where will I find...?	492
Flat tyre	494
Battery	504
Jump-starting	507
Towing and tow-starting	509
Electrical fuses	511

Useful information

- i** This Owner's Manual describes all models and all standard and optional equipment available to your vehicle at the time of publication of the Owner's Manual. Country-specific deviations are possible. Please note that your vehicle may not be equipped with all features described. This also applies to safety-relevant systems and functions.
- i** Please read the information on qualified specialist workshops (▷ page 32).

Where will I find...?

Warning triangle

Removing the warning triangle

- ▶ Open the boot lid.



- ▶ Turn lever (2) 90° in the direction of the arrow and remove warning triangle (1).

Setting up the warning triangle



- ▶ Fold feet (3) down and out to the side.
- ▶ Pull side reflectors (2) upwards to form a triangle and lock them at the top using upper press-stud (1).

First-aid kit

- ▶ Open the boot lid.

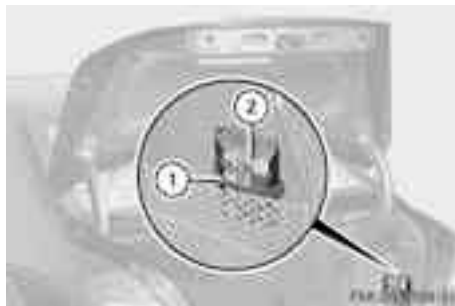

- ▶ Remove tensioning strap (1).
- ▶ Remove first-aid kit (2) from the luggage net.
- i** Check the expiry date on the first-aid kit at least once a year. Replace the contents if necessary, and replace any missing items.

Fire extinguisher

The fire extinguisher is located in the stowage compartment underneath the driver's seat.

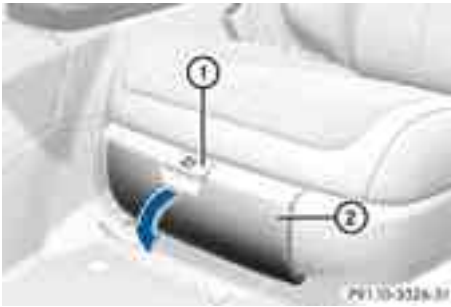

- ▶ Pull handle ① upward and fold cover ② forward.
- ▶ Remove the fire extinguisher from the stowage compartment.

! Keep the stowage compartment closed while the vehicle is in motion. It may otherwise be damaged.

i Have the fire extinguisher refilled after each use and checked every one or two years. It may otherwise fail in an emergency.

Observe the legal requirements in all countries concerned.

Vehicle tool kit

The vehicle tool kit can be found in the stowage well under the boot floor.

i Vehicles without a spare wheel are not equipped with the tools needed to change a wheel when they leave the factory, e.g. a jack or wheel wrench. Country-specific deviations are possible. Some tools for changing a wheel are specific to the vehicle. Tools approved for your vehicle are available at a qualified specialist workshop.

i On vehicles with BlueTEC, the location of the wheel-change tool kit in the boot may differ from the location described.

- ▶ **Vehicles with a TIREFIT kit:** lift up the boot floor (▷ page 460).

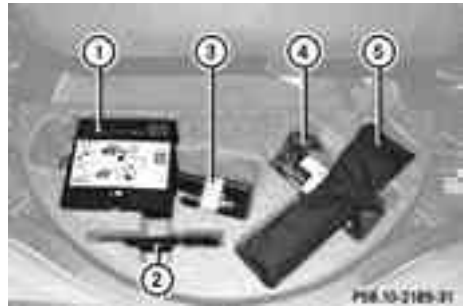

- ① Tyre inflation compressor
- ② Folding wheel chock
- ③ Jack
- ④ Tyre sealant filler bottle
- ⑤ Vehicle tool kit

- ▶ **Vehicles with a spare wheel/"Minispare" emergency spare wheel:** lift up the boot floor (▷ page 460).

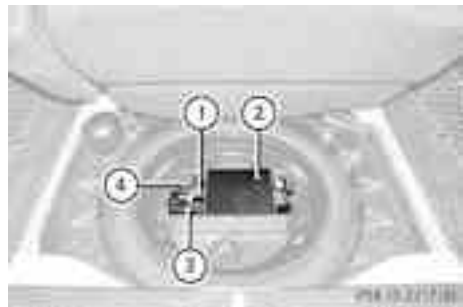

- ① Folding wheel chock
- ② Vehicle tool kit tray cover
- ③ Vehicle tool kit
- ④ Jack

"Minispare" emergency spare wheel

The "Minispare" emergency spare wheel can be found in the stowage well under the boot floor.

- ▶ Lift the boot floor upwards (▷ page 460).

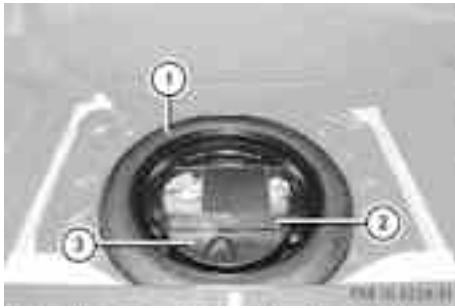

- ▶ Turn stowage tray ③ anti-clockwise and remove together with vehicle tool kit tray ②.
- ▶ Remove "Minispare" emergency spare wheel ①.

For further information on changing a wheel and fitting the spare wheel, see (▷ page 494).

Flat tyre

Preparing the vehicle

Your vehicle may be equipped with:

- a TIREFIT kit
- an emergency spare wheel
- MOExtended tyres (tyres with run-flat characteristics) (▷ page 503)

- i** Vehicle preparation is not necessary on vehicles with MOExtended tyres.
- i** Vehicles with MOExtended tyres are not equipped with a TIREFIT kit at the factory. It is therefore recommended that you additionally equip your vehicle with a TIREFIT kit if you fit tyres that do not feature run-flat characteristics, e.g. winter tyres. A TIREFIT kit can be obtained from a Mercedes-Benz Service Centre.
- ▶ Stop the vehicle as far away as possible from traffic on solid, non-slippery and level ground.
- ▶ Switch on the hazard warning lamps.

- ▶ Apply the electric parking brake manually (▷ page 340).
- ▶ Bring the front wheels into the straight-ahead position.
- ▶ Move the DIRECT SELECT lever to **P**.
- ▶ Switch off the engine.
- ▶ **Vehicles without KEYLESS-GO:** remove the key from the ignition lock.
- ▶ **Vehicles with KEYLESS-GO:** open the driver's door. The on-board electronics have status **0**, which is the same as the key having been removed.
- ▶ **Vehicles with KEYLESS-GO:** remove the Start/Stop button from the ignition lock (▷ page 323).
- ▶ All occupants must get out of the vehicle. Make sure that they are not endangered as they do so.
- ▶ Make sure that no one is near the danger area while a wheel is being changed. Anyone who is not directly assisting in the wheel change should, for example, stand behind the barrier.
- ▶ Get out of the vehicle. Pay attention to traffic conditions when doing so.
- ▶ Close the driver's door.
- ▶ Place the warning triangle (▷ page 492) a suitable distance away. Observe legal requirements.

TIREFIT kit

Using the TIREFIT kit

TIREFIT is a tyre sealant.

You can use TIREFIT to seal punctures of up to 4 mm, particularly those in the tyre tread. You can use TIREFIT at outside temperatures down to -20 °C.

⚠ WARNING

In the following situations, the tyre sealant is unable to provide sufficient breakdown assistance, as it is unable to seal the tyre properly:

- there are cuts or punctures in the tyre larger than those mentioned above.
- the wheel rim is damaged.
- you have driven at very low tyre pressures or on a flat tyre.

There is a risk of accident.

Do not drive any further. Contact a qualified specialist workshop.

- ▶ Do not remove any foreign objects which have penetrated the tyre, e.g. screws or nails.
- ▶ Remove the tyre sealant bottle, the accompanying "max. 80 km/h" sticker and the tyre inflation compressor from the stowage well underneath the boot floor (▷ page 493).

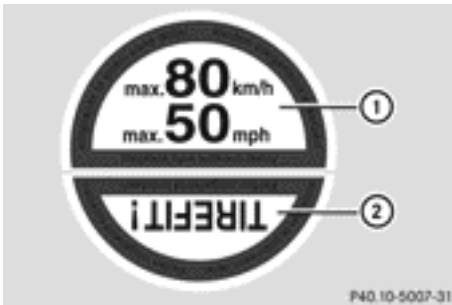

- ▶ Affix part ① of the sticker within the driver's field of vision.
- ▶ Affix part ② of the sticker near the valve on the wheel with the defective tyre.

⚠ WARNING

The tyre sealant is harmful and causes irritation. It must not come into contact with your skin, eyes or clothing or be swallowed. Do not inhale TIREFIT fumes. Keep tyre sealant away from children. There is a risk of injury.

If you come into contact with the tyre sealant, observe the following:

- Rinse off the tyre sealant from your skin immediately with water.
- If the tyre sealant comes into contact with your eyes, immediately rinse them thoroughly with clean water.
- If tyre sealant is swallowed, immediately rinse your mouth out thoroughly and drink plenty of water. Do not induce vomiting, and seek medical attention immediately.
- Immediately change out of clothing which has come into contact with tyre sealant.
- If an allergic reaction occurs, seek medical attention immediately.

- ❗ If tyre sealant leaks out, allow it to dry. It can then be removed like a layer of film. If you get tyre sealant on your clothing, have it cleaned as soon as possible with perchloroethylene.

Your vehicle is provided with one of two different tyre inflation compressors:

- **Version 1:** the hose with the pressure gauge and the cable is behind a flap.
- **Version 2:** the pressure gauge is in the tyre inflation compressor.

TIREFIT kit version 1

- ▶ Open flap ②.
- ▶ Pull connector ⑤ with the cable and hose ⑥ out of the housing.

- ▶ Screw hose ⑥ onto flange ⑦ of tyre sealant bottle ①.
- ▶ Insert tyre sealant bottle head ① downwards into recess ③ of the tyre inflation compressor.

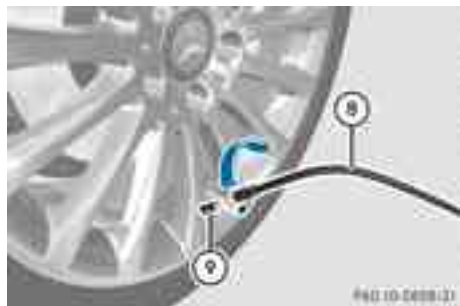

- ▶ Remove the cap from valve ⑨ on the faulty tyre.



- ▶ Make sure pressure release screw ⑩ on pressure gauge ⑪ is fully closed.
- ▶ Screw filler hose ⑧ onto valve ⑨.
- ▶ Insert plug ⑤ into the cigarette lighter socket (▷ page 463) or into a 12 V socket in your vehicle (▷ page 464).
- ▶ Turn the key to position 1 (▷ page 323) in the ignition lock.
- ▶ Press on/off switch ④ on the tyre inflation compressor to I. The tyre inflation compressor is switched on. The tyre is inflated.
- ❗ First, tyre sealant is pumped into the tyre. The pressure can briefly rise to approximately 500kPa (5bar/73psi).

Do not switch off the tyre inflation compressor during this phase.

- ▶ Allow the tyre inflation compressor to run for five minutes. Afterwards, a tyre pressure of at least 180 kPa (1.8 bar/26 psi) must be achieved.

❗ Do not operate the tyre inflation compressor for longer than eight minutes at a time without a break. It may otherwise overheat.

The tyre inflation compressor can be operated again once it has cooled down.

If a pressure of 180kPa (1.8bar/26psi) has not been achieved after five minutes, see (▷ page 497).

If a tyre pressure of 180 kPa (1.8 bar/26 psi) has not been achieved after five minutes, see (▷ page 497).

TIREFIT kit version 2



- ▶ Pull plug ④ with the cable and hose ⑤ out of the housing.
- ▶ Screw hose ⑥ onto flange ⑥ of tyre sealant bottle ①.
- ▶ Insert tyre sealant bottle ① head downwards into recess ② of the tyre inflation compressor.

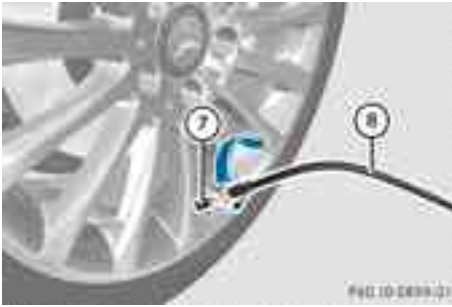

- ▶ Remove the cap from valve ⑦ on the faulty tyre.
- ▶ Screw filler hose ⑧ onto valve ⑦.
- ▶ Insert plug ④ into the cigarette lighter socket (▷ page 463) or into a 12 V socket in your vehicle (▷ page 464).
- ▶ Turn the key to position 1 (▷ page 323) in the ignition lock.
- ▶ Press on/off switch ③ on the tyre inflation compressor to I.
The tyre inflation compressor is switched on. The tyre is inflated.

i First, tyre sealant is pumped into the tyre. The pressure can briefly rise to approximately 500kPa (5bar/73psi).

Do not switch off the tyre inflation compressor during this phase.

- ▶ Allow the tyre inflation compressor to run for five minutes. Afterwards, a tyre pressure of at least 180 kPa (1.8 bar/26 psi) must be achieved.
- !** Do not operate the tyre inflation compressor for longer than eight minutes at a time without a break. It may otherwise overheat.
The tyre inflation compressor can be operated again once it has cooled down.

If a tyre pressure of 180kPa (1.8bar/26psi) has not been achieved after five minutes, see (▷ page 497).

If a tyre pressure of 180kPa (1.8bar/26psi) has not been achieved after five minutes, see (▷ page 497).

Tyre pressure not reached

If a pressure of 180 kPa (1.8 bar, 26 psi) has not been achieved after five minutes:

- ▶ Switch off the tyre inflation compressor.
- ▶ Unscrew the filler hose from the valve of the faulty tyre.
- ▶ Very slowly drive forwards or reverse approximately 10 m.
- ▶ Pump up the tyre again.
After a maximum of five minutes the tyre pressure must be at least 180 kPa (1.8 bar, 26 psi).

⚠ WARNING

If the required tyre pressure is not reached after the specified time, the tyre is too badly damaged. The tyre sealant cannot repair the tyre in this instance. Damaged tyres and a tyre pressure that is too low can significantly impair the vehicle's braking and driving characteristics. There is a risk of accident.

Do not continue driving. Contact a qualified specialist workshop.

Tyre pressure reached

- ▶ Switch off the tyre inflation compressor.
- ▶ Unscrew the filler hose from the valve of the faulty tyre.
- !** After use, excess tyre sealant may run out of the filler hose. This could cause stains.
Therefore, place the filler hose in the plastic bag that contained the TIREFIT kit.
- ▶ Stow the tyre sealant bottle, the tyre inflation compressor and the warning triangle.
- ▶ **Pull away immediately.**

⚠ WARNING

A tyre temporarily sealed with tyre sealant impairs the driving characteristics and is not suitable for higher speeds. There is a risk of accident.

You should therefore adapt your driving style accordingly and drive carefully. Do not exceed

the specified maximum speed with a tyre that has been repaired using tyre sealant.

The maximum speed for a tyre sealed with tyre sealant is 80 km/h. The "max. 80 km/h" sticker must be affixed to the instrument cluster within the driver's field of vision.

- ▶ Stop after driving for approximately ten minutes and check the tyre pressure with the tyre inflation compressor. The tyre pressure must now be at least 130 kPa (1.3 bar, 19 psi).

WARNING

If the required tyre pressure is not reached after driving for a short period, the tyre is too badly damaged. The tyre sealant cannot repair the tyre in this instance. Damaged tyres and a tyre pressure that is too low can significantly impair the vehicle's braking and driving characteristics. There is a risk of accident. Do not continue driving. Contact a qualified specialist workshop.

- i** In your vehicle, you will find a sticker with the Mercedes-Benz Service24h telephone number, e.g. on the B-pillar on the driver's side.

- ▶ Correct the tyre pressure if it is still at least 130 kPa (1.3 bar, 19 psi) (for the values, see the fuel filler flap).
- ▶ **To increase the tyre pressure:** switch on the tyre inflation compressor.



TIREFIT kit version 1

- ▶ **To reduce the tyre pressure (version 1):** open pressure release screw **(10)** on pressure gauge **(11)**.

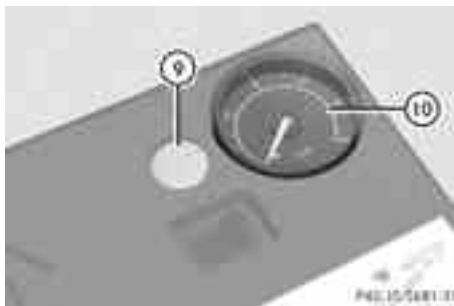

TIREFIT kit version 2

- ▶ **To reduce the tyre pressure (version 2):** depress pressure release button **(9)** next to pressure gauge **(10)**.
- ▶ Stow the tyre sealant bottle, the tyre inflation compressor and the warning triangle.
- ▶ Drive to the nearest specialist qualified workshop and have the tyre changed there.
- ▶ Have the tyre sealant bottle replaced as soon as possible at a qualified specialist workshop.

Environmental note

Have the used tyre sealant bottle disposed of professionally, e.g. at a qualified specialist workshop.

- ▶ Have the tyre sealant bottle replaced every four years at a qualified specialist workshop.

Changing a wheel and fitting the spare wheel

Preparing the vehicle

When using an emergency spare wheel or spare wheel of a different size, you must not exceed the maximum speed of 80 km/h.

⚠ WARNING

The wheel/tyre dimensions and the tyre type of the spare wheel/emergency spare wheel and the wheel to be replaced may differ. Fitting a spare wheel/emergency spare wheel may severely impair the driving characteristics. There is a risk of accident.

To prevent hazardous situations:

- Adapt your driving style accordingly and drive carefully.
- Never fit more than one spare wheel/emergency spare wheel if the dimensions are different to those of the wheel being replaced.
- Only use a spare wheel/emergency spare wheel briefly if the dimensions are different to those of the wheel being replaced.
- Do not switch off ESP®.
- Have the spare wheel/emergency spare wheel in question replaced at the nearest qualified specialist workshop. Make sure that the wheel/tyre dimensions and tyre type are correct.

i Vehicles without an emergency spare wheel/spare wheel are not equipped with wheel-changing tools at the factory. For more information on which tools are required to perform a wheel change on your vehicle, e.g. wheel chock, wheel wrench or centring pin, consult a Mercedes-Benz Service Centre.

- ▶ Prepare the vehicle as described (▷ page 494).
- ▶ If a trailer is coupled to the vehicle, uncouple it.
- ▶ Remove the following items (depending on the vehicle's equipment) from the stowage well under the boot floor:
 - the emergency spare wheel or spare wheel
 - wheel bolts for the spare wheel/emergency spare wheel
 - the vehicle tool kit

- the folding wheel chock
- the jack

- ▶ Secure the vehicle to prevent it from rolling away.

Securing the vehicle against rolling away

If your vehicle is equipped with a wheel chock, it can be found in the vehicle tool kit (▷ page 493).

The folding wheel chock is an additional securing measure to prevent the vehicle from rolling away, for example when changing a wheel.



- ▶ Fold both plates upwards ①.
- ▶ Fold out lower plate ②.
- ▶ Guide the lugs on the lower plate fully into the openings in base plate ③.



Securing the vehicle on level ground

- ▶ **On level ground:** place chocks or other suitable items under the front and rear of

the wheel that is diagonally opposite the wheel you wish to change.



Securing the vehicle on slight downhill gradients

- **On downhill gradients:** place chocks or other suitable items in front of the wheels of the front and rear axle.

Raising the vehicle

WARNING

If you do not position the jack correctly at the appropriate jacking point of the vehicle, the jack could tip over with the vehicle raised. There is a risk of injury.

Only position the jack at the appropriate jacking point of the vehicle. The base of the jack must be positioned vertically, directly under the jacking point of the vehicle.

The following must be observed when raising the vehicle:

- to raise the vehicle, only use the vehicle-specific jack that has been tested and approved by Mercedes-Benz. If used incorrectly, the jack could tip over with the vehicle raised.
- the jack is designed only to raise and hold the vehicle for a short time while a wheel is being changed. It is not suited for performing maintenance work under the vehicle.
- avoid changing the wheel on uphill and downhill slopes.
- before raising the vehicle, secure it from rolling away by applying the parking brake

and inserting wheel chocks. Never disengage the parking brake while the vehicle is raised.

- the jack must be placed on a firm, flat and non-slip surface. On a loose surface, a large, load-bearing underlay must be used. On a slippery surface, a non-slip underlay must be used, e.g. rubber mats.
- do not use wooden blocks or similar objects as a jack underlay. Otherwise, the jack will not be able to achieve its load-bearing capacity due to the restricted height.
- make sure that the distance between the underside of the tyres and the ground does not exceed 3 cm.
- never place your hands and feet under the raised vehicle.
- never lie under the raised vehicle.
- never start the engine when the vehicle is raised.
- never open or close a door or the boot lid when the vehicle is raised.
- make sure that no persons are present in the vehicle when the vehicle is raised.



- Using wheel wrench ①, loosen the bolts on the wheel you wish to change by about one full turn. Do not unscrew the bolts completely.

The jacking points are located just behind the front wheel arches and just in front of the rear wheel arches (arrows).



- ▶ Position jack (3) at jacking point (2).

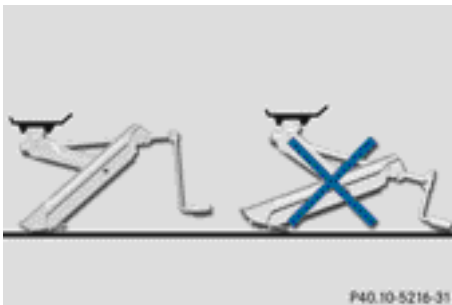

- ▶ Make sure that the base of the jack is positioned directly under the jacking point.
- ▶ Turn crank (4) clockwise until jack (3) sits completely on jacking point (2) and the base of the jack lies evenly on the ground.
- ▶ Turn ratchet (4) until the tyre is raised a maximum of 3 cm off the ground.

Removing a wheel



- ▶ Unscrew the uppermost wheel bolt completely.
- ▶ Screw centring pin (1) into the thread instead of the wheel bolt.
- ▶ Unscrew the remaining wheel bolts fully.

! Do not place wheel bolts in sand or dirt. The threads of the wheel bolts and wheel hubs could otherwise be damaged when the bolts are tightened.

- ▶ Remove the wheel.

Fitting a new wheel

⚠ WARNING

Oiled or greased wheel bolts or damaged wheel bolts/hub threads can cause the wheel bolts to come loose. As a result, you could lose a wheel while driving. There is a risk of accident.

Never oil or grease wheel bolts. In the event of damage to the threads, contact a qualified specialist workshop immediately. Have the damaged wheel bolts or hub threads replaced/renewed. Do not continue driving.

⚠ WARNING

If you tighten the wheel bolts or wheel nuts when the vehicle is raised, the jack could tip over. There is a risk of injury.

Only tighten the wheel bolts or wheel nuts when the vehicle is on the ground.

Always pay attention to the instructions and safety notices in "Changing a wheel" (▷ page 524).

Only use wheel bolts that have been designed for the wheel and the vehicle. For safety reasons, Mercedes-Benz recommends that you only use wheel bolts which have been approved for Mercedes-Benz vehicles and the respective wheel.

Be sure to use the original-length wheel bolts when refitting the original wheel after it has been repaired.

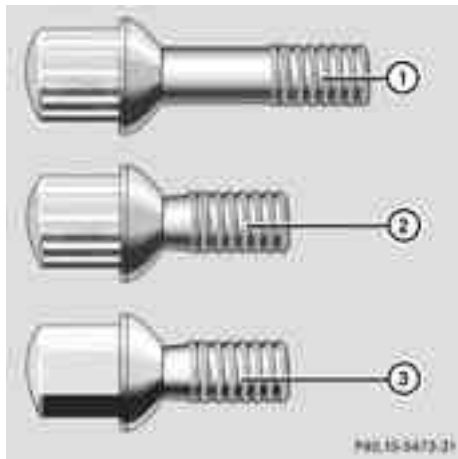

Wheel bolts for:

- ① 17" light-alloy wheel, 7-spoke design with MB Number A 221 140 17602, 18" light-alloy wheel and larger
- ② 17" light-alloy wheel, 5-spoke design, 17" light-alloy wheel, 7-spoke design with MB Number A 221 140 10202
- ③ "Minispare" emergency spare wheel

! Always use wheel bolts ② or ③ to fit 17", 5-spoke/7-spoke wheels with MB Number A 221 401 02 02 or the "Minispare" emergency spare wheel. Using other wheel bolts when fitting 17", 5-spoke/7-spoke wheels or the "Minispare" emergency spare wheel could damage the brake system.

- ▶ Clean the wheel and wheel hub contact surfaces.



- ▶ Slide the emergency spare wheel or the spare wheel onto the centring pin and push it on.
- ▶ Tighten the wheel bolts until they are finger-tight.
- ▶ Unscrew the centring pin.
- ▶ Tighten the last wheel bolt until it is finger-tight.

Lowering the vehicle

WARNING

Tyre pressure that is too high or too low can lead to a blow-out of the fitted emergency spare wheel/spare wheel, particularly when driving with a heavy load and increasing speed. There is a risk of accident.

Check the tyre pressure of the emergency spare wheel or spare wheel and adjust it. When doing so, observe the specified tyre pressure.

- ▶ Turn the crank of the jack anti-clockwise until the vehicle is once again standing firmly on the ground.
- ▶ Place the jack to one side.



WARNING

The wheels could work loose if the wheel nuts and bolts are not tightened to the specified tightening torque. There is a risk of accident. Have the tightening torque immediately checked at a qualified specialist workshop after a wheel is changed.

- ▶ Tighten the wheel bolts evenly in a cross-wise pattern in the sequence indicated (① to ⑤). The tightening torque must be **150 Nm**.
 - ▶ Turn the jack back to its initial position and store it together with the rest of the tyre-change tool kit in the stowage well under the boot floor.
 - ① When you are driving with the collapsible emergency spare wheel fitted, the tyre pressure loss warning system or the tyre pressure monitor cannot function reliably. Only restart the tyre pressure loss warning system/tyre pressure monitor when the defective wheel has been replaced with a new wheel.
- Vehicles with tire pressure control system: all fitted wheels must be equipped with functioning sensors. The defective wheel should no longer be in the vehicle.

MOExtended tyres (tyres with run-flat characteristics)

With MOExtended tyres (tyres with run-flat characteristics), you can continue to drive

your vehicle even if there is a total loss of pressure in one or more tyres.

MOExtended tyres may only be used in conjunction with an activated tyre pressure loss warning system or with an activated tyre pressure monitor.

The driving distance possible is 80 km when the vehicle is partially laden, and 30 km when the vehicle is fully laden.

In addition to the vehicle load, the driving distance possible depends upon:

- speed
- road condition
- outside temperature

The driving distance possible in run-flat mode may be reduced by extreme driving conditions/manoeuvres, or it can be increased through a moderate style of driving.

The maximum permissible distance which can be driven in run-flat mode is counted from the moment the tyre pressure loss warning appears in the multifunction display.

You must not exceed a maximum speed of 80 km/h.

WARNING

When driving in emergency mode, the driving characteristics deteriorate, e.g. when cornering, accelerating quickly and when braking. There is a risk of accident.

Do not exceed the stated maximum speed. Avoid abrupt steering and driving manoeuvres, and driving over obstacles (kerbs, potholes, off-road). This applies in particular to a laden vehicle.

Stop driving in emergency mode if:

- you hear banging noises.
- the vehicle starts to shake.
- you see smoke and smell rubber.
- ESP® is intervening constantly.
- there are tears in the sidewalls of the tyre.

After driving in emergency mode, have the wheel rims checked at a qualified specialist

workshop with regard to their further use. The faulty tyre must be replaced.

- i** When replacing one or all tyres, make sure that you only use tyres marked MOExtended. Also ensure that they are of the specified size for the vehicle.
- i** Vehicles with MOExtended tyres are not equipped with a TIREFIT kit at the factory. It is therefore recommended that you additionally equip your vehicle with a TIREFIT kit if you fit tyres that do not feature run-flat characteristics, e.g. winter tyres. A TIREFIT kit can be obtained from a qualified specialist workshop.

Battery

Important safety notes

Work on the battery, e.g. removing or installing, requires specialist knowledge and the use of special tools. Therefore, always have work on the battery carried out at a qualified specialist workshop.

WARNING

Hybrid vehicles: ensure that you read the "HYBRID" supplement. You could otherwise fail to recognise dangers.

WARNING

Work carried out incorrectly on the battery can, for example, lead to a short circuit and damage your vehicle's electronic system. This can disrupt driving safety systems such as ABS (anti-lock braking system) or ESP® (Electronic Stability Program).

- If ABS malfunctions, the wheels can lock during braking. This limits the steerability of the vehicle when braking and the braking distance may increase. There is a risk of accident.
- If ESP® malfunctions, the vehicle will not be stabilised if it starts to skid or a wheel starts to spin. There is a risk of accident.

You should therefore have all work involving the battery carried out at a qualified specialist workshop.

WARNING

Comply with safety precautions and take protective measures when handling batteries.



Risk of explosion



Fire, naked flames and smoking are prohibited when handling the battery. Avoid creating sparks.



Battery acid is caustic. Avoid contact with the skin, eyes or clothing.

Wear suitable protective clothing, in particular gloves, an apron and a face mask.

Immediately rinse acid splashes off with clean water. Consult a doctor if necessary.

Wear eye protection.



Keep children away.



Observe this Owner's Manual.

WARNING

For safety reasons, Mercedes-Benz recommends that you only use batteries which have been tested and approved for your vehicle by Mercedes-Benz. These batteries provide increased impact protection to prevent vehicle occupants from suffering acid burns

should the battery be damaged in the event of an accident.

To prevent acid burns, observe the following safety notes when handling batteries:

- do not lean over the battery.
- do not place any metal objects on a battery. Otherwise, you could cause a short circuit and the battery's gas mixture could ignite.
- make sure that you do not create an electrostatic charge, e.g. by wearing synthetic clothing or as a result of friction on fabrics. Therefore, you should not pull or slide the battery over carpets or other synthetic materials.
- never touch the battery first. To discharge a possible electrostatic charge, step out of the vehicle first and touch the bodywork.
- do not wipe the battery using a cloth. The battery may explode as a result of electrostatic charge or due to flying sparks.

Environmental note



Batteries contain pollutants. It is illegal to dispose of them with the household rubbish. They must be collected separately and disposed of in an environmentally responsible recycling system.



Dispose of batteries in an environmentally responsible manner. Take discharged batteries to a qualified specialist workshop or to a collection point for used batteries.

- !** Have the battery checked regularly at a qualified specialist workshop.

Observe the service intervals in the Service Booklet or contact a qualified specialist workshop for more information.

- !** You should have all work involving the battery carried out at a qualified specialist workshop. In the exceptional case that it is

necessary for you to disconnect the battery yourself, make sure that:

- you switch off the engine and remove the key. On vehicles with KEYLESS-GO, ensure that the ignition is switched off. Check that all the indicator lamps in the instrument cluster are off. Otherwise, electronic components, such as the alternator, may be damaged.
- you first remove the negative terminal clamp and then the positive terminal clamp. Never swap the terminal clamps. Otherwise, the vehicle's electronic system may be damaged.
- the transmission is locked in position **P** after disconnecting the battery. The vehicle is secured against rolling away. You can then no longer move the vehicle.

The battery and the cover of the positive terminal clamp must be fitted securely during operation.

In order for the battery to achieve the maximum possible service life, it must always be sufficiently charged.

Like other batteries, the vehicle battery may discharge over time if you do not use the vehicle. In such cases, have the battery disconnected at a qualified specialist workshop. You can also charge the battery with a charger recommended by Mercedes-Benz. For more information, please contact a qualified specialist workshop.

Have the battery charge checked more frequently if you use the vehicle mainly for short trips or if you leave it standing idle for a lengthy period. Consult a qualified specialist workshop if you wish to leave your vehicle parked up for a long period of time.

- i** When you park the vehicle, remove the key if you do not require any electrical consumers. The vehicle will then use very little energy, thus conserving battery power.

Charging the battery

WARNING

Only charge the battery in a well-ventilated area. As the battery is being charged, gases can escape and generate minor explosions. This could injure you and other persons or cause damage to the paintwork or acid corrosion on the vehicle.

You can obtain information on battery chargers which allow the battery to be charged while still installed from a qualified specialist workshop.

WARNING

There is a risk of acid burns during the charging process due to the gases which escape from the battery. Do not lean over the battery during the charging process.

WARNING

Battery acid is caustic. Avoid contact with the skin, eyes or clothing.

! Only charge the installed battery with a battery charger which has been tested and approved by Mercedes-Benz. These battery chargers allow the battery to be charged while still installed in the vehicle.

! Only use battery chargers with a maximum charging voltage of 14.8 V.

! Only charge the battery using the jump-start connection point.

The jump-starting connection point is in the engine compartment (▷ page 507).

- ▶ Open the bonnet (▷ page 476).
- ▶ Connect the battery charger to the positive terminal and earth point in the same order as when connecting the donor battery in the jump-starting procedure (▷ page 507).
- ▶ Read the battery charger's operating instructions before charging the battery.

Jump-starting

WARNING

There is a risk of acid burns when jump-starting a vehicle due to the gases which escape from the battery. Do not lean over the battery while the engine is being jump-started.

WARNING

Gases escaping from the battery during jump-starting may cause minor explosions. Avoid creating sparks. Keep naked flames away from the battery, and do not smoke.

Comply with safety precautions when handling batteries. You will find these under "Battery (vehicle)" in the index.

WARNING

Hybrid vehicles: ensure that you read the "HYBRID" supplement. You could otherwise fail to recognise dangers.

WARNING

Non-combusted fuel can collect in the exhaust system and ignite. There is a risk of fire. Avoid repeated and lengthy starting attempts.

! Avoid repeated and lengthy starting attempts. Otherwise, the catalytic converter could be damaged by the non-combusted fuel.

Do not use a rapid charging device to start the vehicle. If your vehicle's battery is discharged, the engine can be jump-started from another vehicle or from a second battery using jump leads. Observe the following points:

- the battery is not accessible in all vehicles. if the other vehicle's battery is not accessible, jump-start the vehicle using a second battery or a jump-starting device.
- you may only jump-start the vehicle when the engine and catalytic converter are cold.
- do not start the engine if the battery is frozen. let the battery thaw first.
- jump-starting may only be performed from batteries with a nominal voltage of 12 V.
- only use jump leads that have a sufficient cross-section and insulated terminal clamps.
- If the battery is fully discharged, leave the battery that is being used to jump-start connected for a few minutes before attempting to start. This charges the empty battery a little.
- Make sure that the two vehicles do not touch.

Make sure that:

- the jump leads are not damaged.
 - bare parts of the terminal clamp do not come into contact with other metal parts while the jump leads are connected to the battery.
 - the jump leads cannot come into contact with parts such as the V-belt pulley or the fan. These parts move when the engine is started and while it is running.
- Secure the vehicle by applying the electric parking brake.
- Shift the transmission to position **P**.

- ▶ Switch off all electrical consumers (e.g. radio, blower, etc.).
- ▶ Open the bonnet (▶ page 476).

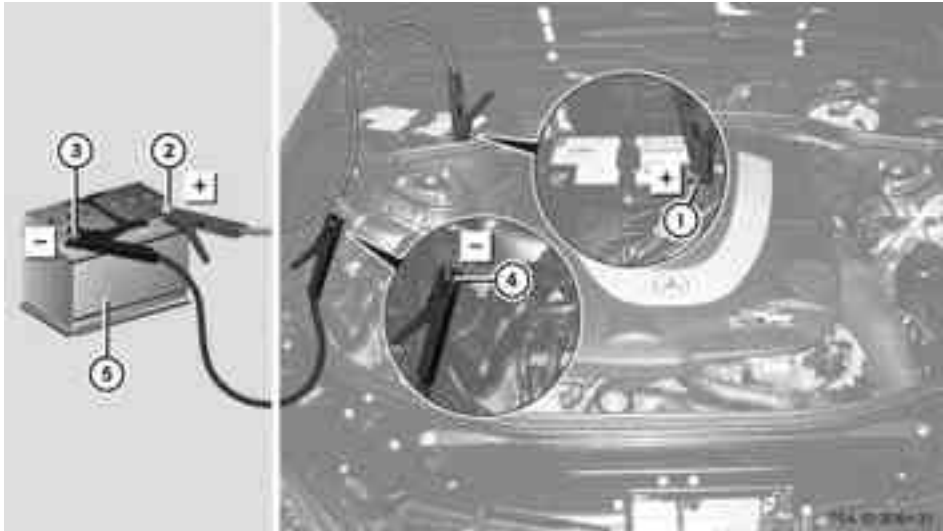

Position number ⑤ identifies the charged battery of the other vehicle or an equivalent jump-starting device.

- ▶ Remove the cover from positive terminal ①.
 - ▶ Connect positive terminal ① on your vehicle to positive terminal ② of donor battery ⑤ using the jump lead, beginning with your own battery.
 - ▶ Start the engine of the donor vehicle and run it at idling speed.
 - ▶ Connect negative terminal ③ of donor battery ⑤ to earth point ④ of your vehicle using the jump lead, connecting the jump lead to donor battery ⑤ first.
 - ▶ Start the engine.
 - ▶ Before disconnecting the jump leads, let the engine run for several minutes.
 - ▶ First remove the jump leads from earth point ④ and negative terminal ③, then from positive terminal ① and positive terminal ②, each time disconnecting from the battery on your own vehicle first.
 - ▶ Have the battery checked at a qualified specialist workshop.
- i** Jump-starting is not considered to be a normal operating condition.
- i** Jump-starting cables and further information regarding jump starting can be obtained at any qualified specialist workshop.

Towing and tow-starting

Important safety notes

Observe the legal requirements for the relevant countries when towing.

WARNING

Hybrid vehicles: ensure that you read the "HYBRID" supplement. You could otherwise fail to recognise dangers.

WARNING

If you tow the vehicle, you must use a rigid towing bar if:

- the engine is not running.
- there is a brake system malfunction.
- there is a malfunction in the power supply or the vehicle's electrical system.

The power assistance for the steering and the brake force booster do not work when the engine is not running. You will need more force to steer and brake, you may have to depress the brake pedal with maximum force.

Before towing away, make sure that the steering can be moved and is not locked.

If you tow or tow-start another vehicle, its weight must not exceed the maximum permissible gross vehicle weight of your vehicle.

WARNING

The vehicle is braked when the HOLD function or DISTRONIC PLUS is activated. Therefore, deactivate HOLD and DISTRONIC PLUS if the vehicle is to be towed.

It is better to have the vehicle transported than to have it towed.

! You may tow the vehicle for a maximum of 50km. A towing speed of 50 km/h must not be exceeded.

For towing distances over 50 km, the entire vehicle must be lifted up and transported.

! Make sure that the electric parking brake is released. If the electric parking brake is faulty, visit a qualified specialist workshop.

! Only secure the tow rope or towing bar to the towing eyes. The vehicle may otherwise be damaged.

! Do not use the towing eye for recovery, as this could damage the vehicle. If in doubt, recover the vehicle with a crane.

! When towing, pull away slowly and smoothly. If the tractive power is too high, the vehicles could be damaged.

! To tow vehicles with KEYLESS-GO, use the key instead of the Start/Stop button. The automatic transmission may otherwise switch to position **P** when you open the driver's or front-passenger door which could damage the transmission.

The automatic transmission must be in position **N** when the vehicle is being towed.

The battery must be connected and charged. Otherwise, you:

- cannot turn the key in the ignition lock to position **2**
- cannot shift the automatic transmission to position **N**

i Switch off the automatic locking feature (▷ page 276) before the vehicle is towed. You could otherwise be locked out when pushing or towing the vehicle. Deactivate tow-away protection (▷ page 76) before the vehicle is towed.

Fitting/removing the towing eye

Fitting the towing eye

Vehicles with a trailer tow hitch: if you intend to use the vehicle for towing, fold out the ball coupling and connect the towbar to it (▷ page 387).

► Remove the towing eye from the vehicle tool kit (▷ page 493).

WARNING

The exhaust tail pipe may be hot. You could burn yourself if you touch the tail pipe. Be

particularly careful when removing the rear cover.

The mountings for the removable towing eyes are located in the bumpers. They are at the front and at the rear, under the covers.



- ▶ Press the mark on cover ① inwards in the direction of the arrow.
- ▶ Take cover ① off the opening.
- ▶ Screw the towing eye in clockwise to the stop and tighten it.

Removing the towing eye

- ▶ Loosen the towing eye and unscrew it.
- ▶ Attach cover ① to the bumper and press until it engages.
- ▶ Place the towing eye in the vehicle tool kit.

Towing the vehicle with the rear axle raised

Only possible on vehicles without 4MATIC.

When towing your vehicle with the rear axle raised, it is important that you observe the safety instructions (▷ page 509).

- ❗ The ignition must be switched off if you are towing the vehicle with the rear axle

raised. Intervention by ESP® could otherwise damage the brake system.

- ▶ Switch on the hazard warning lamps (▷ page 293).
- ▶ Turn the key in the ignition lock to position **0** and remove the key from the ignition lock.
- ▶ When leaving the vehicle, take the key or the KEYLESS-GO key with you.

Towing the vehicle with both axles on the ground

It is important that you observe the safety instructions when towing away your vehicle (▷ page 509).

⚠ WARNING

The power assistance for the steering and the brake force booster do not work when the engine is not running. You will then need much more effort to brake and steer the vehicle. Adapt your style of driving accordingly.

The automatic transmission automatically shifts to position **P** when you open the driver's or front-passenger door or when you remove the key from the ignition lock. In order to ensure that the automatic transmission stays in position **N** when towing the vehicle, you must observe the following points:

- ▶ Make sure that the vehicle is stationary and that the key in the ignition lock is in position **0**.
- ▶ Turn the key to position **2** in the ignition lock.

On vehicles with KEYLESS-GO, use the key instead of the Start/Stop button (▷ page 323).

- ▶ Depress and hold the brake pedal.
- ▶ Shift the automatic transmission to position **N**.
- ▶ Release the brake pedal.
- ▶ Release the electric parking brake.

- ▶ Switch on the hazard warning lamps (▷ page 293).
- ▶ Leave the key in position **2** in the ignition lock.
- i** When towing with the hazard warning lamps switched on, use the combination switch as usual to signal a change of direction. In this case, only the turn signals for the desired direction flash. When the combination switch is reset, the hazard warning lamps start flashing again.

Transporting the vehicle

The towing eyes or trailer tow hitch can be used to pull the vehicle onto a trailer or transporter if you wish to transport it.

- ▶ Turn the key to position **2** in the ignition lock.
- ▶ Shift the automatic transmission to position **N**.

As soon as the vehicle is loaded:

- ▶ Prevent the vehicle from rolling away by applying the electric parking brake.
- ▶ Shift the automatic transmission to position **P**.
- ▶ Turn the key in the ignition lock to position **0** and remove the key from the ignition lock.
- ▶ Secure the vehicle.

! Only lash the vehicle down by the wheels or wheel rims, not by parts of the vehicle such as axle or steering components. Otherwise, the vehicle could be damaged.

Notes for 4MATIC vehicles

! Vehicles with 4MATIC must not be towed with the front or rear axle raised; otherwise, the transmission may be damaged.

If the vehicle has transmission damage or damage to the front or rear axle, have it transported on a transporter or trailer.

In the event of damage to the electrical system

If the battery is defective, the automatic transmission will be locked in position **P**. To shift the automatic transmission to position **N**, you must provide power to the vehicle's electrical system in the same way as when jump-starting (▷ page 507).

Have the vehicle transported on a transporter or trailer.

Tow-starting (emergency engine starting)

! Vehicles with automatic transmission must not be tow-started. The transmission may otherwise be damaged.

You can find information on "Jump-starting" at (▷ page 507).

Electrical fuses

Important safety notes

WARNING

Only use fuses that have been approved for Mercedes-Benz vehicles and which have the correct fuse rating for the systems concerned. Do not attempt to repair or bridge faulty fuses. Using fuses which have not been approved or attempting to repair or bridge faulty fuses could cause the fuse to be overloaded and result in a fire. Have the cause traced and rectified at a qualified specialist workshop.

The fuses in your vehicle serve to close down faulty circuits. If a fuse blows, all the components on the circuit and their functions stop operating.

Blown fuses must be replaced with fuses of the same rating, which you can recognise by the colour and fuse rating. The fuse ratings are listed in the fuse allocation chart.

If the newly inserted fuse also blows, have the cause traced and rectified at a qualified spe-

cialist workshop, e.g. a Mercedes-Benz Service Centre.

- ❗ Only use fuses that have been approved for Mercedes-Benz vehicles and which have the correct fuse rating for the system concerned. Otherwise, components or systems could be damaged.

Before replacing a fuse

- ▶ Secure the vehicle against rolling away (▷ page 339).
- ▶ Switch off all electrical consumers.
- ▶ Remove the key from the ignition lock.

The fuses are located in various fuse boxes:

- fuse box on the right and left-hand sides of the dashboard
- fuse box in the rear
- fuse box in the engine compartment on the left-hand side of the vehicle, when viewed in the direction of travel
- fuse box in the engine compartment on the right-hand side of the vehicle, when viewed in the direction of travel

The fuse allocation chart is in the vehicle document wallet.

Dashboard fuse box

There is a fuse box located on both the driver's side and the front-passenger side.

- ❗ Do not use a pointed object such as a screwdriver to open the cover in the dashboard. You could damage the dashboard or the cover.



Driver's side illustrated

- ▶ **To open:** pull cover ① outwards in the direction of the arrow and remove it.
- ▶ **To close:** clip in cover ① on the front of the dashboard.
- ▶ Fold cover ① inwards until it engages.

Fuse box in the rear

The fuse box is behind the armrest in the rear.

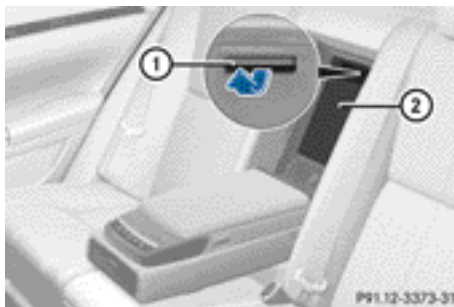

- ▶ **To open:** fold down the armrest.
- ▶ Pull handle ① on the trim behind the rear seat armrest up in the direction of the arrow.
- ▶ Fold down trim ②.



- ▶ Loosen cover ④ with a suitable object ③.
- ▶ Remove cover ④ upwards in the direction of the arrow.

! The cover must be fitted properly, otherwise moisture or dirt could impair the function of the fuses.

Fuse box in the engine compartment

Fuse box on the left in the direction of travel

- ▶ Open the bonnet (▷ page 476).

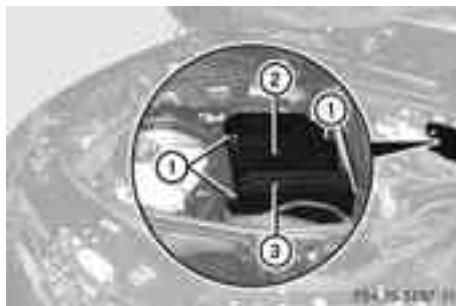

Example: vehicle with a diesel engine

- ▶ Remove any existing moisture from the fuse box using a dry cloth.
- ▶ **To open:** undo screws ① with an Allen key.
- ▶ **Vehicles with a diesel engine:** remove bracket ③ and the control unit.
- ▶ **All vehicles:** remove cover ②.

! Make sure that no moisture can enter the fuse box when the cover is open.

- ▶ **To close:** check whether the rubber seal is lying correctly in cover ②.
- ▶ Put cover ② back in position.
- ▶ **Vehicles with a diesel engine:** put bracket ③ and the control unit back in position.
- ▶ **All vehicles:** tighten screws ① with an Allen key.

! The cover must be fitted properly, otherwise moisture or dirt could impair the function of the fuses.

- ▶ Close the bonnet (▷ page 477).

Fuse box on the right in the direction of travel

- ▶ Open the bonnet (▷ page 476).

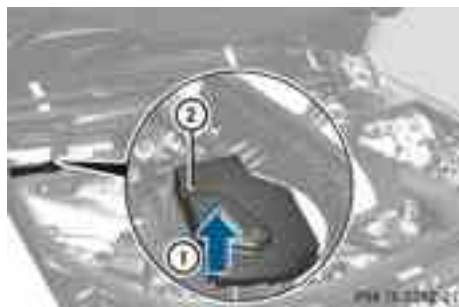

- ▶ Remove any existing moisture from the fuse box using a dry cloth.
- ▶ **To open:** lift cover ② on lower edge ①. The retaining lugs are released.
- ▶ Remove cover ② upwards.

! Make sure that no moisture can enter the fuse box when the cover is open.

- ▶ **To close:** check whether the rubber seal is lying correctly in cover ②.
- ▶ Put cover ② back in position.
- ▶ Press down cover ② until all retaining lugs engage audibly.

! The cover must be fitted properly, otherwise moisture or dirt could impair the function of the fuses.

- ▶ Close the bonnet (▷ page 477).

Useful information	516
Important safety notes	516
Operation	516
Winter operation	518
Tyre pressure	520
Changing a wheel	524
Wheel and tyre combinations	525

Useful information

- i** This Owner's Manual describes all models and all standard and optional equipment available to your vehicle at the time of publication of the Owner's Manual. Country-specific deviations are possible. Please note that your vehicle may not be equipped with all features described. This also applies to safety-relevant systems and functions.
- i** Please read the information on qualified specialist workshops (> page 32).

Important safety notes

WARNING

If wheels and tyres of the wrong size are used, the wheel brakes or suspension components may be damaged. There is a risk of accident. Always replace wheels and tyres with those that fulfil the specifications of the original part (designation, manufacturer, model).

WARNING

A flat tyre severely impairs the driving, steering and braking characteristics of the vehicle. There is a risk of accident.

Tyres without run-flat characteristics:

- do not drive with a flat tyre.
- immediately replace the flat tyre with your emergency spare wheel or spare wheel, or consult a qualified specialist workshop.

Tyres with run-flat characteristics:

- pay attention to the information and warning notices on MOExtended tyres (tyres with run-flat characteristics).

Accessories that are not approved for your vehicle by Mercedes-Benz or are not being used correctly can impair the operating safety.

Before purchasing and using non-approved accessories, visit a qualified specialist workshop and enquire about:

- suitability
- legal stipulations
- factory recommendations

Information on the dimensions and types of wheels and tyres for your vehicle can be found in the "Wheel/tyre combinations" section (> page 525).

Information on air pressure for the tyres on your vehicle can be found:

- on the tyre pressure label on the fuel filler flap
- in the "Tyre pressure" section

Modification work on the brake system and wheels is not permitted, nor is the use of spacer plates or brake dust shields. This invalidates the general operating permit for the vehicle.

Pay special attention to the country-specific requirements for tyre approval. These requirements can stipulate a specific tyre type for your vehicle. Furthermore, the use of certain tyre types in certain regions and areas of operation can be highly beneficial. You can find further information regarding tyres at specialist tyre retailers, at qualified specialist workshops or at every Mercedes-Benz Service Centre.

- i** Further information on wheels and tyres can be obtained at any qualified specialist workshop.

Operation

Notes on driving

- While driving, pay attention to vibrations, noises and unusual handling characteristics, e.g. pulling to one side. This may indicate that the wheels or tyres are damaged. If you suspect that a tyre is defective, reduce your speed immediately. Stop the vehicle as soon as possible to check the

wheels and tyres for damage. Hidden tyre damage could also be causing the unusual handling characteristics. If you find no signs of damage, have the tyres and wheels checked at a qualified specialist workshop.

- When parking your vehicle, make sure that the tyres do not get deformed by the kerb or other obstacles. If it is necessary to drive over kerbs, speed humps or similar elevations, try to do so slowly and at an obtuse angle. Otherwise, the tyres, particularly the sidewalls, can get damaged.

Notes on regularly inspecting wheels and tyres

WARNING

Damaged tyres can cause tyre inflation pressure loss. As a result, you could lose control of your vehicle. There is a risk of accident.

Check the tyres regularly for signs of damage and replace any damaged tyres immediately.

- Regularly check the wheels and tyres of your vehicle for damage (e.g. cuts, punctures, tears, bulges on tyres and deformation, cracks or severe corrosion on wheels), at least every 14 days, as well as after driving off-road or on rough roads. Damaged wheels can cause a loss of tyre pressure.
- Regularly check the tyre tread depth and the condition of the tread across the whole width of the tyre (> page 517). If necessary, turn the front wheels to full lock in order to inspect the inner side of the tyre surface.
- All wheels must have a valve cap to protect the valve against dirt and moisture. Do not fit anything onto the valve (such as tyre pressure monitoring systems) other than the standard valve cap or other valve caps approved by Mercedes-Benz for your vehicle.
- Regularly check the pressure of all the tyres including the emergency spare wheel or the spare wheel, particularly prior to long trips,

and correct the pressure as necessary (> page 520).

Tyre tread

WARNING

Insufficient tyre tread will reduce tyre traction. The tyre is no longer able to dissipate water. This means that on wet road surfaces, the risk of aquaplaning increases, in particular where speed is not adapted to suit the driving conditions. There is a risk of accident.

If the tyre pressure is too high or too low, tyres may exhibit different levels of wear at different locations on the tyre tread. Thus, you should regularly check the tread depth and the condition of the tread across the entire width of all tyres.

Minimum tyre tread depth for:

- summer tyres: 3 mm
- M+S tyres: 4 mm

For safety reasons, replace the tyres before the legally prescribed limit for the minimum tyre tread depth is reached..

Notes on selecting, fitting and replacing tyres

- Only fit tyres and wheels of the same type and make.
- Only fit tyres of the correct size onto the wheels.
- After fitting new tyres, run them in at moderate speeds for the first 100 km, as they only reach their full performance after this distance.
- Do not drive with tyres which have too little tread depth, as this significantly reduces the traction on wet roads (aquaplaning).
- Replace the tyres after six years at the latest, regardless of wear. This also applies to the emergency spare wheel/spare wheel.

The service life of tyres depends on various factors, including the following:

- driving style
- tyre pressure
- mileage

MOExtended tyres (tyres with run-flat characteristics)

MOExtended tyres (tyres with run-flat characteristics) allow you to continue driving the vehicle even if one or more tyres lose all air pressure.

MOExtended tyres may only be used in conjunction with an activated tyre pressure loss warning system or with an activated tyre pressure monitor and on wheels specifically tested by Mercedes-Benz.

i Vehicles with MOExtended tyres are not equipped with a TIREFIT kit at the factory. It is therefore recommended that you additionally equip your vehicle with the TIREFIT kit if you fit tyres that do not feature run-flat characteristics, e.g. winter tyres. A TIREFIT kit can be obtained from a qualified specialist workshop.

Notes on driving with MOExtended tyres in the event of a flat tyre can be found in the "Breakdown assistance" section (▷ page 503).

Winter operation

Points to remember

Have your vehicle winterproofed at a qualified specialist workshop at the onset of winter.

Observe the notes in the "Changing a wheel" section (▷ page 524).

Driving with summer tyres

At temperatures below +7 °C, summer tyres lose elasticity and therefore traction and braking power; change the tyres on your vehi-

cle to M+S tyres. Using summer tyres at very cold temperatures could cause tears to form, thereby damaging the tyres permanently. Mercedes-Benz cannot accept responsibility for this type of damage.

M+S tyres

At temperatures below +7 °C, use winter tyres or all-season tyres. Both types of tyre are identified by the M+S marking.

Only winter tyres bearing the  snowflake symbol in addition to the M+S marking provide the best possible grip in wintry road conditions. Only these tyres will allow driving safety systems such as ABS and ESP® to function optimally in winter. These tyres have been developed specifically for driving in snow.

Use M+S tyres of the same make and tread on all wheels to maintain safe handling characteristics.

WARNING

M+S tyres with a tyre tread depth of less than 4 mm are not suitable for use in winter as they do not provide sufficient traction. There is a risk of accident.

M+S tyres with a tread depth of less than 4 mm must be replaced.

Always observe the maximum permissible speed specified for the M+S tyres you have fitted.

If you fit M+S tyres that have a lower maximum permissible speed than that of the vehicle, affix an appropriate warning sign in the driver's field of vision. This can be obtained at a qualified specialist workshop.

Under these circumstances, you should also restrict the maximum speed of the vehicle using permanent SPEEDTRONIC so that it does not exceed the maximum permissible speed for the M+S tyres (▷ page 348).

If you have fitted M+S tyres:

- ▶ Check the tyre pressures (▷ page 520).
- ▶ Restart the tyre pressure loss warning system (▷ page 521).
- ▶ Restart the tyre pressure monitor (▷ page 524).

After fitting a spare wheel or an emergency spare wheel, do not drive faster than 80 km/h.

WARNING

The wheel/tyre dimensions and the tyre type of the spare wheel/emergency spare wheel and the wheel to be replaced may differ. Fitting a spare wheel/emergency spare wheel may severely impair the driving characteristics. There is a risk of accident.

To prevent hazardous situations:

- Adapt your driving style accordingly and drive carefully.
- Never fit more than one spare wheel/emergency spare wheel if the dimensions are different to those of the wheel being replaced.
- Only use a spare wheel/emergency spare wheel briefly if the dimensions are different to those of the wheel being replaced.
- Do not switch off ESP®.
- Have the spare wheel/emergency spare wheel in question replaced at the nearest qualified specialist workshop. Make sure that the wheel/tyre dimensions and tyre type are correct.

Snow chains

For safety reasons, Mercedes-Benz recommends that you only use snow chains that have been specially approved for your vehicle by Mercedes-Benz, or that are of a corresponding standard of quality.

If you intend to fit snow chains, please bear the following points in mind:

- snow chains cannot be fitted to all wheel-tyre combinations. Permissible wheel-tyre combinations (▷ page 525).
- only fit snow chains in pairs and to the rear wheels, even on vehicles with 4MATIC. Observe the manufacturer's fitting instructions.
- only use snow chains when the road surface is completely snow-covered. Remove the snow chains as soon as possible when you come to a road that is not snow-covered.
- local regulations may restrict the use of snow chains. Observe the appropriate regulations if you wish to fit snow chains.
- do not exceed the maximum permissible speed of 50 km/h.
- On vehicles with AIRMATIC (▷ page 358) or Active Body Control (ABC) (▷ page 360), you must drive at raised vehicle level if snow chains have been fitted.
- snow chains must not be fitted to emergency spare wheels, e.g. a "Minispare" emergency spare wheel.

! **Vehicles with steel wheels:** if you wish to fit snow chains to steel wheels, make sure that you remove the respective wheels' hubcaps first. The hubcaps may otherwise be damaged.

i You may wish to deactivate ESP® (▷ page 72) when pulling away with snow chains fitted. This way you can allow the wheels to spin in a controlled manner, achieving an increased driving force (cutting action).

Tyre pressure

Tyre pressure specifications

WARNING

Tyres with too low or too high tyre pressure contain the following hazards:

- they can burst, in particular if the vehicle is heavily laden or when driven at high speeds.
- the tyres can wear excessively and/or unevenly, which can severely impair tyre traction.
- the driving, steering and braking characteristics may be severely impaired.

There is a risk of accident.

Follow recommended tyre inflation pressures and check the pressure of all the tyres including the spare wheel:

- at least every two weeks
 - if the load changes
 - before beginning a long journey
 - for changed operating conditions, e.g. off-road driving
- If necessary, correct the tyre pressure.

You will find a table of tyre pressures for various operating conditions on the inside of your vehicle's fuel filler flap.

Operation with emergency spare wheel: the applicable value is stated on the wheel and in the "Wheel/tyre combinations" section (▷ page 525).

Operation with a trailer: the applicable value for the rear tyres is the maximum tyre pressure value stated on the table inside the fuel filler flap.

The table inside the fuel filler flap may state tyre pressures for different load conditions. These are defined in the table as different numbers of passengers and amounts of luggage. The actual number of seats may vary – for more information, please refer to the vehicle's registration documents.

The tyre pressures specified on the fuel filler flap apply for all tyres approved for this vehicle, if not stated otherwise.

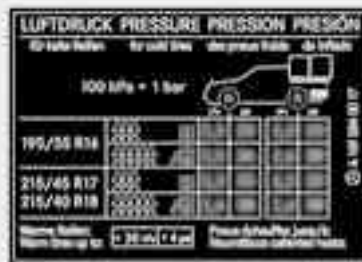

If a tyre size precedes a tyre pressure, the following tyre pressure information is only valid for that tyre size.

To test tyre pressure, use a suitable pressure gauge. The outer appearance of a tyre does not permit any reliable conclusion about the tyre pressure. On vehicles fitted with the electronic tyre pressure monitor, the tyre pressure can be checked using the on-board computer.

WARNING

If you fit unsuitable accessories onto tyre valves, the tyre valves may be overloaded and malfunction, which can cause tyre pressure loss. Due to their design, retrofitted tyre pressure monitors keep the tyre valve open. This can also result in tyre pressure loss. There is a risk of accident.

Only screw standard valve caps or valve caps specifically provided by Mercedes-Benz for your vehicle onto the tyre valve.

WARNING

If the tyre pressure drops repeatedly, the wheel, valve or tyre may be damaged. Tyre pressure that is too low may result in a tyre blow-out. There is a risk of accident.

- Check the tyre for foreign objects.
- Check whether the wheel is losing air or the valve is leaking.

If you are unable to rectify the damage, contact a qualified specialist workshop.

If possible, only correct tyre pressures when the tyres are cold.

The tyres are cold:

- if the vehicle has been parked with the tyres out of direct sunlight for at least three hours and
- if the vehicle has not been driven further than 1.6 km

Depending on the ambient temperature, the speed you are driving at and the load on the tyres, the tyre temperature and thus the tyre pressure change by approximately 10 kPa (0.1 bar/ 1.5 psi) per 10 °C. Take this into account when checking the pressure of warm tyres and only correct it if it is too low for the current operating conditions.

Driving with tyre pressure that is too high or too low can:

- shorten the service life of the tyres
- cause increased tyre damage
- have a negative effect on handling characteristics and thus the driving safety (e.g. by causing aquaplaning)

i The tyre pressure values given for low loads are minimum values which offer you good ride comfort characteristics.

However, you can also use the values given for higher loads. These are permissible and will not adversely affect the running of the vehicle.

Environmental note

Check the tyre pressure regularly, at least every 14 days.

The values on the tyre pressure information label (fuel filler flap) for the vehicle in "partially laden" and "fully laden" conditions apply when driving at maximum speed. Despite the values stated on the tyre pressure information label, for the vehicle with "**partially laden up to 210 km/h**" status, the values can be reduced as follows, without a reduction in safety:

- -30 kPa (-0.3 bar/-4 psi) for all models other than S 63 AMG and S 65 AMG

This does not apply to vehicles towing a trailer.

This improves the ride comfort of your vehicle; however, the fuel consumption may increase slightly.

Tyre pressure loss warning system

Important safety notes

While the vehicle is in motion, the tyre pressure loss warning system monitors the set tyre pressure using the rotational speed of the wheels. This enables the system to detect significant pressure loss in a tyre. If the speed of rotation of a wheel changes as a result of a loss of pressure, a corresponding warning message will appear in the multifunction display.

The tyre pressure warning system does not warn you of an incorrectly set tyre pressure. Observe the notes on the recommended tyre pressure (▷ page 520).

The tyre pressure loss warning system does not replace the need to regularly check your vehicle's tyre pressures, since an even loss of pressure on several tyres at the same time cannot be detected by the tyre pressure loss warning system.





The tyre pressure monitor is not able to warn you of a sudden loss of pressure, e.g. if the tyre is penetrated by a foreign object. In the event of a sudden loss of pressure, bring the vehicle to a halt by braking carefully. Avoid abrupt steering manoeuvres.

The function of the tyre pressure loss warning system is limited or delayed if:





- snow chains are fitted to your vehicle's tyres.
- road conditions are wintry.
- you are driving on sand or gravel.
- you adopt a very sporty driving style (cornering at high speeds or driving with high rates of acceleration).
- you are towing a very heavy or large trailer.
- you are driving with a heavy load (in the vehicle or on the roof).

Restarting the tyre pressure loss warning system





Restart the tyre pressure loss warning system if you have:

- changed the tyre pressure
 - changed the wheels or tyres
 - fitted new wheels or tyres
- ▶ Before restarting, consult the table of tyre pressures on the inside of the fuel filler flap to ensure that the tyre pressure in all four tyres is set correctly for the respective operating conditions.
- The tyre pressure loss warning system can only give reliable warnings if you have set the correct tyre pressure. If an incorrect tyre pressure is set, these incorrect values will be monitored.
- ▶ Observe the notes in the section on tyre pressures (▷ page 520).
 - ▶ Make sure that the key is in position **2** (▷ page 323) in the ignition lock.
 - ▶ Press the  or  button on the steering wheel to select the **Service** menu.
 - ▶ Press the  or  button to select **Tyre pressure**.
 - ▶ Press the  button.
- The **Run Flat Indicator active Restart possible with OK** message appears in the multifunction display.

If you wish to confirm the restart:

- ▶ Press the  button.
The **Tyre pressure now OK?** message appears in the multifunction display.
 - ▶ Press the  or  button to select **Yes**.
 - ▶ Press the  button.
The **Run Flat Indicator restarted** message appears in the multifunction display.
- After a teach-in period, the tyre pressure loss warning system will monitor the set tyre pressures of all four tyres.

If you wish to cancel the restart:

- ▶ Press the  button.
- or
- ▶ If the **Tyre pressure now OK?** message appears, press the  or  button to select **Cancel**.
 - ▶ Press the  button.
The tyre pressure values stored at the last restart will continue to be monitored.

Tyre pressure monitor

Important safety notes

It is the driver's responsibility to set the tyre inflation to the recommended cold tyre pressure suitable to the operating situation (▷ page 520). Note that the correct tyre pressure for the current operating situation must first be taught-in to the tyre pressure monitor. If there is a substantial loss of pressure, the warning threshold for the warning message is aligned to the reference values taught-in. Restart the tyre pressure monitor after adjusting to the cold tyre pressure. (▷ page 524) The current pressures are saved as new reference values. This will ensure that a warning message will only appear if the tyre pressure drops significantly. The tyre pressure monitor does not warn you of an incorrectly set tyre pressure. Observe

the notes on the recommended tyre pressure (▷ page 520).



The tyre pressure monitor is not able to warn you of a sudden loss of pressure, e.g. if the tyre is penetrated by a foreign object. In the event of a sudden loss of pressure, bring the vehicle to a halt by braking carefully. Avoid abrupt steering manoeuvres.

If a tyre pressure monitor system is fitted, the vehicle's wheels have sensors fitted that monitor the tyre pressures in all four tyres. The tyre pressure monitor warns you if the pressure drops in one or more of the tyres. The tyre pressure monitor only functions if the correct sensors are fitted to all wheels. Information on tyre pressures is displayed in the multifunction display. After a few minutes of driving, the current tyre pressure of each tyre is shown in the multifunction display.

i The tyre pressure values indicated by the on-board computer may differ from those measured at a filling station using a pressure gauge. The tyre pressures shown by the on-board computer refer to those measured at sea level. At high altitudes, the tyre pressure values indicated by a pressure gauge are higher than those shown by the on-board computer. In this case, do not reduce the tyre pressures.

i The operation of the tyre pressure monitor can be affected by interference from radio transmitting equipment (e.g. radio headphones, two-way radios) that may be being operated in or near the vehicle.

Checking tyre pressure electronically

- ▶ Make sure that the key is in position 2 (▷ page 323) in the ignition lock.
- ▶ Press the  or  button on the steering wheel to select the **Service** menu.

▶ Press the  or  button to select **Tyre pressure**.

▶ Press the  button.

The current tyre pressure for each wheel will be displayed in the multifunction display.

If the vehicle has been parked for longer than 20 minutes, the **Tyre pressures displayed after driving a few minutes** message appears.

After a teach-in period, the tyre pressure monitor automatically recognises new wheels or new sensors. As long as a clear allocation of the tyre pressure values to the individual wheels is not possible, the **Tyre pressure monitor active** display message is shown instead of the tyre pressure display. The tyre pressures are already being monitored.

i If a spare wheel/emergency spare wheel is fitted, for a few minutes the system may continue to show the tyre pressure of the wheel that has been removed. If this occurs, note that the value displayed for the position where the spare wheel/emergency spare wheel is fitted is not the same as the spare wheel/emergency spare wheel's current tyre pressure.

Warning messages of the tyre pressure monitor

If the tyre pressure monitor detects a significant pressure loss on one or more tyres, a warning message is shown in the multifunction display. A warning tone also sounds and the tyre pressure warning lamp lights up in the instrument cluster.

Each tyre that is affected by a significant loss of pressure is highlighted in the pressure display.

If the **Please correct tyre pressure(s)** message appears in the multifunction display:

- ▶ Check the tyre pressure on all four wheels and correct it if necessary.

i If the wheel positions on the vehicle are interchanged, the tyre pressures may be displayed for the wrong positions for a short time. This is rectified after a few minutes of driving, and the tyre pressures are displayed for the correct positions.

Restarting the tyre pressure monitor







When you restart the tyre pressure monitor, all existing warning messages are deleted and the warning lamps go out. The monitor uses the currently set tyre pressures as the reference values for monitoring. In most cases, the tyre pressure monitor will automatically detect the new reference values after you have changed the tyre pressure.

i For an overview of the menus, see (> page 395).

If you wish to define the new reference values manually:

- ▶ Use the table on the inside of the fuel filler flap to ensure that the tyre pressure is set correctly in all four tyres for the current operating conditions.

Also observe the notes in the section on tyre pressures (> page 520).

- ▶ Make sure that the key is in position **2** in the ignition lock.
- ▶ Press the  or  button on the steering wheel to select the **Service** menu.
- ▶ Press the  or  button to select **Tyre pressure**.
- ▶ Press the  button.
The multifunction display shows the current tyre pressure of the individual tyres or the **Tyre pressures displayed after driving a few minutes** message.
- ▶ Press the  button.
The **Use current pressure values as new reference values** message appears in the multifunction display.

If you wish to confirm the restart:

- ▶ Press the  button.
The **Tyre pressure monitor restarted** message appears in the multifunction display.

After you have driven for a few minutes, the system checks whether the current tyre pressures are within the specified range. The new tyre pressures are then accepted as reference values and monitored.

If you wish to cancel the restart:

- ▶ Press the  button.
The tyre pressure values stored at the last restart will continue to be monitored.

Radio type approval for the tyre pressure monitor

In certain countries, a radio type approval for the tyre pressure monitor may be required. The radio type approval number for the tyre pressure monitor can be found online at: <http://www.mercedes-benz.de/betriebsanleitung>.

Changing a wheel

Flat tyre

The "Breakdown assistance" section (> page 494) contains information and notes on how to deal with a flat tyre. It also provides instructions on changing a wheel or fitting the spare wheel/emergency spare wheel.

Interchanging the wheels

WARNING

Interchanging the front and rear wheels may severely impair the driving characteristics if the wheels or tyres have different dimensions. The wheel brakes or suspension components may also be damaged. There is a risk of accident.

Interchange front and rear wheels only if the wheels and tyres are of the same dimensions.

Interchanging the front and rear wheels of differing dimensions can render the general operating permit invalid.

Always pay attention to the instructions and safety notices in the section on "Wheel changing and spare wheel fitting" (▷ page 498).

The wear patterns on the front and rear tyres differ, depending on the operating conditions. Interchange the wheels before a clear wear pattern has formed on the tyres. Front tyres typically wear more on the shoulders and the rear tyres in the centre.

On vehicles that have the same size front and rear wheels, you can interchange the wheels every 5,000km to 10,000 km depending on the degree of tyre wear. Maintain the direction of tyre rotation.

Clean the contact surfaces of the wheel and the brake disc thoroughly every time a wheel is interchanged. Check the tyre pressure and, if necessary, restart the tyre pressure loss warning system or the tyre pressure monitor.

! On vehicles fitted with a tyre pressure monitor, electronic components are located in the wheel.

Tyre-fitting tools should not be applied in the area of the valve, as this could damage the electronic components.

Only have tyres changed at a qualified specialist workshop.

Direction of rotation

Tyres with a specified direction of rotation have additional benefits, e.g. if there is a risk of aquaplaning. You will only gain these benefits if the correct direction of rotation is observed.

An arrow on the sidewall of the tyre indicates its correct direction of rotation.

You may fit a spare wheel/emergency spare wheel against the direction of rotation. Observe the time restriction on use as well as the speed limitation specified on the emergency spare wheel/spare wheel.

Storing wheels

Store wheels that are not being used in a cool, dry and preferably dark place. Protect the tyres against oil, grease, petrol and diesel.

Cleaning the wheels

WARNING

Do not use high-pressure cleaners with circular-jet nozzles (dirt grinders) to clean your vehicle, in particular the tyres. You could otherwise damage the tyres and cause an accident.

Wheel and tyre combinations

Points to remember

! For safety reasons, Mercedes-Benz recommends that you only use tyres and wheels which have been approved by Mercedes-Benz specifically for your vehicle.

These are specially adapted to the control systems, such as ABS or ESP® and are marked as follows:

- MO = Mercedes-Benz Original
- MOE = Mercedes-Benz Original Extended (tyres featuring run-flat characteristics)
- MO1 = Mercedes-Benz Original (only certain AMG tyres)

Mercedes-Benz Original Extended tyres may only be used on wheels that have been specifically approved by Mercedes-Benz.

Only use tyres, wheels or accessories tested and approved by Mercedes-Benz. Certain characteristics, e.g. handling, vehicle noise emissions or fuel consumption, may

otherwise be adversely affected. In addition, when driving with a load, tyre dimension variations could cause the tyres to come into contact with the bodywork and axle components. This could result in damage to the tyres or the vehicle.

Mercedes-Benz accepts no liability for damage resulting from the use of tyres, wheels or accessories other than those tested and approved.

Further information about wheels, tyres and approved combinations can be obtained from any qualified specialist workshop.

! Large wheels: the lower the section width for a certain wheel size, the lower the ride comfort is on poor road surfaces. Roll comfort and suspension comfort are reduced and the risk of damage to the wheels and tyres as a result of driving over obstacles increases.

i You will find a table of tyre pressures on the inside of your vehicle's fuel filler flap. For further information on tyre pressure, see (▷ page 520). Check tyre pressures regularly and only when the tyres are cold.

i Notes on the vehicle equipment – always fit the vehicle:

- with tyres of the same size on a given axle (left/right)
- with the same type of tyres at a given time (summer tyres, winter tyres, MOExtended tyres)

i Vehicles with MOExtended tyres are not equipped with a TIREFIT kit at the factory. It is therefore recommended that you additionally equip your vehicle with a TIREFIT kit if you fit tyres that do not feature run-flat characteristics, e.g. winter tyres. A TIREFIT kit can be obtained from a qualified specialist workshop.

i Overview of abbreviations used in the following tyre tables:

- BA: both axles
- FA: front axle
- RA: rear axle

In the following table, the wheel/tyre combinations are allocated to the vehicle models through variants, e.g. V1, V2 etc.:

V1	S 250 CDI ³² , S 300, S 350 ³² , S 350 BlueTEC, S 350 CDI, S 500 ³²
V2	S 350 BlueTEC 4MATIC, S 350 4MATIC ³² , S 500 4MATIC ³²
V3	S 600
V4	S 63 AMG
V5	S 65 AMG

i Not all wheel/tyre combinations can be mounted at the factory in all countries.

Tyres							
	Summer tyres	Light-alloy wheels	V1	V2	V3	V4	V5
BA	235/55 R17 99 W	8.0 J x 17 H2 ET 43	● ³³	● ³⁴	—	—	—
BA	255/45 R18 99 Y	8.5 J x 18 H2 ET 43	●	●	—	—	—
BA	255/45 R18 99 Y MOExtended ³⁵	8.5 J x 18 H2 ET 43	●	●	—	—	—
FA	255/45 R18 99 Y	8.5 J x 18 H2 ET 43	●	—	●	—	—
RA	275/45 R18 103 Y	9.5 J x 18 H2 ET 43	—	—	—	—	—
FA	255/45 R18 99 Y MOExtended ³⁵	8.5 J x 18 H2 ET 43	●	—	●	—	—
RA	275/45 R18 103 Y MOExtended ^{35, 36}	9.5 J x 18 H2 ET 43	—	—	—	—	—
BA	255/40 R19 100 Y XL	8.5 J x 19 H2 ET 43	●	●	—	—	—
FA	255/40 R19 100 Y XL	8.5 J x 19 H2 ET 43	●	—	●	—	—
RA	275/40 R19 101 Y ³⁶	9.5 J x 19 H2 ET 43	—	—	—	—	—
FA	255/40 ZR19 XL	8.5 J x 19 H2 ET 43	●	—	●	●	—
RA	275/40 ZR19 XL ³⁶	9.5 J x 19 H2 ET 43	—	—	—	—	—
BA	255/35 ZR20 XL ³⁷	8.5 J x 20 H2 ET 43	—	●	—	—	—
FA	255/35 ZR20 XL ³⁷	8.5 J x 20 H2 ET 43	●	—	●	●	●
RA	275/35 ZR20 XL ^{36, 37}	9.5 J x 20 H2 ET 43	—	—	—	—	—

	Winter tyres	Light-alloy wheels	V1	V2	V3	V4	V5
BA	235/55 R17 99 V M+S 	8.0 J x 17 H2 ET 43	● ³³	● ³⁴	—	—	—
BA	255/45 R18 99 V M+S 	8.5 J x 18 H2 ET 43	●	●	●	—	—
BA	255/45 R18 99 V M+S MOExtended  ³⁵	8.5 J x 18 H2 ET 43	●	●	●	—	—



³³ Not for S 500 BlueEFFICIENCY.

³⁴ Not for S 500 4MATIC BlueEFFICIENCY.

³⁵ Tyres with run-flat characteristics only in combination with an activated tyre pressure loss warning system or tyre pressure monitor.

³⁶ Use of snow chains is not permitted. Observe the notes in the "Snow chains" section.

³⁷ Observe the notes on "Large wheels" in the "Wheel/tyre combinations" section.

	Winter tyres	Light-alloy wheels	V1	V2	V3	V4	V5
BA	255/40 R19 100 V XL M+S 	8.5 J x 19 H2 ET 43	•	•	•	•	•
FA	255/40 R19 100 V XL M+S 	8.5 J x 19 H2 ET 43	–	–	–	•	•
RA	275/40 R19 105 V XL M+S  ³⁶	9.5 J x 19 H2 ET 43					

"Minispare" emergency spare wheel³⁶

Tyres	Steel wheel	V1	V2	V3	V4	V5
T 155/70 R19 113 M Tyre pressure: 420 kPa (4.2 bar/61 psi)	4.5 B x 19 H2 ET 35	•	•	•	•	•

Depending on the country, the engine and the wheels fitted, your vehicle may be equipped with TIREFIT, a "Minispare" emergency spare wheel or a spare wheel.

! The spare wheel must be inflated to the maximum tyre pressure given in the table on the inside of the fuel filler flap.

i The specified tyre pressure is printed in yellow on the emergency spare wheel.

³⁶ Use of snow chains is not permitted. Observe the notes in the "Snow chains" section.

Useful information	530
Notes on the technical data	530
Genuine Mercedes-Benz parts	530
Vehicle electronics	531
Identification plates	532
Service products and capacities	533
Vehicle data	541
Boot lid opening dimensions	543
trailer tow hitch	543
24 GHz radar sensor system (country overview)	545

Useful information

- i** This Owner's Manual describes all models and all standard and optional equipment available to your vehicle at the time of publication of the Owner's Manual. Country-specific deviations are possible. Please note that your vehicle may not be equipped with all features described. This also applies to safety-relevant systems and functions.
- i** Please read the information on qualified specialist workshops (▷ page 32).

Notes on the technical data

WARNING

Hybrid vehicles: ensure that you read the "HYBRID" supplement. You could otherwise fail to recognise dangers.

You can find technical data on the Internet at: <http://www.mercedes-benz.com>

- i** The technical data was determined in accordance with EC Directives. All data applies to the vehicle's standard equipment. It may therefore differ for vehicles with optional equipment. You can obtain further information from a Mercedes-Benz Service Centre.

Genuine Mercedes-Benz parts

Mercedes-Benz tests genuine parts and conversion parts and accessories which have been specifically approved for your vehicle for their reliability, safety and suitability. Despite ongoing market research, Mercedes-Benz is unable to evaluate other parts. Mercedes-Benz therefore accepts no responsibility for the use of such parts in Mercedes-Benz vehicles, even if they have been independently or officially approved.

In Germany and some other countries, certain parts are only officially approved for installation or modification if they comply with legal requirements. All genuine Mercedes-Benz parts meet this requirement. The use of non-approved parts may invalidate the vehicle's general operating permit. This is the case if:

- they cause a change of the vehicle type from that for which the vehicle's general operating permit was granted.
- other road users could be endangered.
- the emission or noise levels are adversely affected.

WARNING

Driving safety may be impaired if non-approved parts, tyres and wheels or safety-relevant accessories are used.

This could lead to malfunctions in safety-relevant systems, e.g. the brake system. This could cause you to lose control of your vehicle and cause an accident.

For this reason, Mercedes-Benz recommends that you use genuine Mercedes-Benz parts or parts of equal quality. Only use tyres, wheels and accessories that have been specifically approved for your vehicle.

- !** Airbags and seat belt tensioners, as well as control units and sensors for these restraint systems may be installed in the following areas of your vehicle:

- doors
- door pillars
- door sills
- seats
- dashboard
- instrument cluster
- centre console

Do not install accessories such as audio systems in these areas. Do not carry out repairs or welding. You could impair the operating efficiency of the restraint systems.

Have aftermarket accessories installed at a qualified specialist workshop. Mercedes-Benz recommends that you use a Mercedes-Benz Service Centre for this purpose.

Environmental note

Daimler AG also supplies reconditioned assemblies and parts which are of the same quality as new parts. For these, the same warranty applies as for new parts.

Always specify the vehicle identification number (VIN) (▷ page 532) and the engine number (▷ page 533) when ordering genuine Mercedes-Benz parts.

Vehicle electronics

Tampering with the engine electronics

WARNING

Always have work on the engine electronics and related components carried out at a qualified specialist workshop. Otherwise, the vehicle's operating safety could be affected.

Only have work carried out on the engine electronics and its associated parts, such as control units, sensors and connector leads, at a qualified specialist workshop. Vehicle components may otherwise wear more quickly and the vehicle's operating permit may be invalidated.

Retrofitting two-way radios and mobile phones (RF transmitters)

Use the Technical Specification ISO/TS 21609³⁸ implementation regulation when retrofitting RF (radio frequency) transmitters.

³⁸ ISO/TS 21609 – Technical Specification for Road Vehicles (EMC) guidelines for installation of aftermarket radio frequency transmitting equipment.

³⁹ Vehicles with a sliding sunroof: observe the roof's sweep.

⁴⁰ Vehicles with a panorama sliding sunroof: this area is not permitted.

If your vehicle has fittings for two-way radio equipment, use the power supply or aerial connections intended for use with the basic wiring. Be sure to observe the manufacturer's additional instructions when installing.

Have aftermarket radio frequency transmitting equipment installed at a qualified specialist workshop.

The transmission output at the aerial base must not exceed the maximum values below.

Waveband	Maximum transmission output (PEAK)
Short wave (f < 54 MHz)	100 W
4 m waveband	30 W
2 m waveband	50 W
Trunked radio/Tetra	35 W
70 cm waveband	35 W
GSM/DCS/PCS 850/900/1800/1900	10 W
UMTS/LTE	10 W

The following aerial positions may be used if RF transmitters have been properly installed:

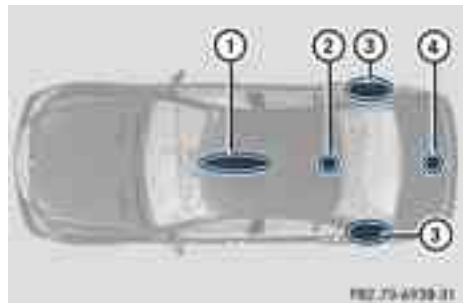

- ① Front roof area^{39, 40}
- ② Rear roof area⁴⁰

- ③ Rear wing⁴¹
- ④ Boot lid

⚠ WARNING

Incorrect retrofitting of RF transmitters can cause the vehicle electronics to malfunction. The vehicle's operating safety and thus your own safety are impaired.

Have aftermarket radio frequency transmitting equipment installed at a qualified specialist workshop.

⚠ WARNING

Incorrect retrofitting of RF transmitters can lead to increased electromagnetic radiation in the vehicle interior. Using an exterior aerial takes into account current scientific discussions relating to the possible health hazards that may result from electromagnetic fields.

Have aftermarket radio frequency transmitting equipment installed at a qualified specialist workshop.

Deviations with respect to aerial locations, output and frequencies must be approved by Mercedes-Benz.

The following can be used in the vehicle without restrictions:

- RF transmitters with a maximum transmission output of up to 100 mW
- mobile phones (GSM/DCS/PCS/UMTS/LTE)

There is no restriction for aerial positions in the outer area of the vehicle for the following wavebands:

- Trunked radio/Tetra
- 70 cm waveband
- GSM/DCS/PCS
- UMTS/LTE

! The operating permit may be invalidated if the instructions for installation and use of RF transmitters are not observed, e.g.

approved wavebands, maximum output and aerial positions on the vehicle.

Identification plates

Vehicle identification plate with vehicle identification number (VIN) and paint code number

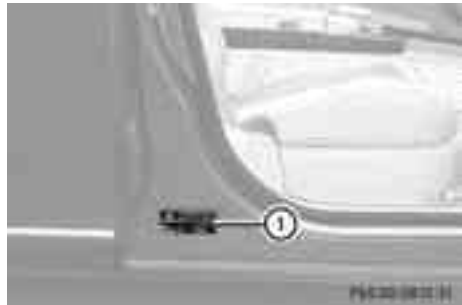

- Open the front right-hand door. You will see vehicle identification plate ①.

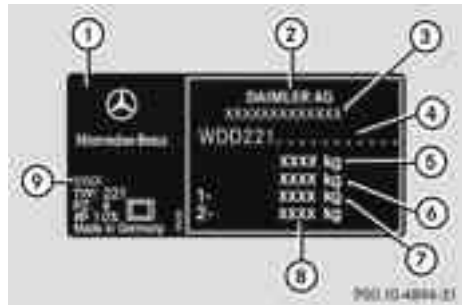

Example: vehicle identification plate

- ① Vehicle identification plate
- ② Vehicle manufacturer (Daimler AG)
- ③ EU type approval number (only for certain countries)
- ④ Vehicle identification number (VIN)
- ⑤ Maximum permissible gross vehicle weight (kg)
- ⑥ Maximum permissible mass of vehicle/trailer combination (kg)
- ⑦ Maximum permissible front axle load (kg)

⁴¹ Recommended installation position: on the side which faces the centre of the road.

- ⑧ Maximum permissible rear axle load (kg)
- ⑨ Paint code

Vehicle identification number (VIN)

In addition to being stamped on the vehicle identification plate, the vehicle identification number (VIN) is also stamped onto the vehicle body. It is under the trim behind the rear seat armrest.



- ▶ Fold down the rear seat armrest.
- ▶ Open the trim.
You will see vehicle identification number (VIN) ①.

Engine number

The engine number is stamped into the crankcase. More information can be obtained from any Mercedes-Benz Service Centre.

Service products and capacities

Important safety notes

WARNING

When handling, storing and disposing of any service products, please observe the relevant regulations, as you could otherwise endanger yourself and others.

Keep service products away from children.

To protect your health, do not allow service products to come into contact with your eyes

or open wounds. See a doctor immediately if any service product is swallowed.

Environmental note

Dispose of service products in an environmentally-responsible manner.

Service products include the following:

- fuels (e.g. petrol, diesel)
- exhaust gas aftertreatment additives, e.g. AdBlue®
- lubricants (e.g. engine oil, transmission oil)
- coolant
- brake fluid
- windscreen washer fluid
- climate control system refrigerant

Components and service products must be matched. Mercedes-Benz recommends that you use products tested and approved by Mercedes-Benz. They are listed in this Mercedes-Benz Owner's Manual in the appropriate section.

You can identify service products approved by Mercedes-Benz by the following inscriptions on the container:

- MB-Freigabe (e.g. MB-Freigabe 229.51)
- MB Approval (e.g. MB Approval 229.51)

Other designations or recommendations indicate a level of quality or a specification in accordance with an MB Sheet number (e.g. MB 229.5). They have not necessarily been approved by Mercedes-Benz.

Further information can be obtained from any Mercedes-Benz Service Centre or on the Internet at <http://bevo.mercedes-benz.com>.

Fuel

Important safety notes

WARNING

Fuel is highly flammable. Fire, naked flames and smoking are therefore prohibited when handling fuels.

Switch off the engine and the auxiliary heating before refuelling.

WARNING

Avoid contact with fuels.

It is hazardous to your health if your skin comes into direct contact with fuels or you breathe in fuel vapours.

Tank capacity

Total capacity	
S 300	90.0 l
S 600	
S 63 AMG	
S 65 AMG	
S 350 CDI ⁴²	
All other models	83.0 l

Of which reserve fuel	
All models (except for AMG vehicles)	Approx. 11.0 l
S 63 AMG	Approx. 14.0 l
S 65 AMG	

Petrol (EN 228, E DIN 51626-1)

Fuel grade

! Do not use diesel to refuel vehicles with a petrol engine. Even a small quantity of diesel will damage the fuel injection system.

! Only refuel using unleaded petrol with at least 95 RON/85 MON that conforms to European standard EN 228 or E DIN 51626-1 or an equivalent specification. Fuel with this specification may contain up to 10 % ethanol.

! Do not use the following:

- E85 (petrol with 85 % ethanol)
- E100 (100 % ethanol)
- M15 (petrol with 15 % methanol)
- M85 (petrol with 85 % methanol)
- M100 (100 % methanol)
- Petrol with metallic additives
- Diesel

Do not mix these fuels with petrol, and do not use any additives. This can otherwise lead to engine damage. This does not include cleaning additives for the removal and prevention of residue build-up. Only cleaning additives recommended by Mercedes-Benz should be added to petrol, see "Additives". You can obtain further information from any Mercedes-Benz Service Centre.

Usually you will find information about the fuel grade on the pump. If you cannot find the label on the petrol pump, ask the filling station staff.

i E10 fuel contains up to 10% bioethanol. Your vehicle is suitable for use with E10 fuel. You can refuel your vehicle using E10 fuel.

i As a temporary measure, if the recommended fuel is not available, you may also use unleaded petrol with an octane rating of 91 RON/82.5 MON. This may reduce engine performance and increase fuel consumption. Avoid driving at full throttle.

The quality of the fuel available in some countries may not be sufficient. Residue could build up as a result. In such cases, and in consultation with a Mercedes-Benz Service Centre, the petrol may be mixed with the additive recommended by Mercedes-Benz (part no. A000989254510). You must observe the notes and mixing ratios specified on the container.

Information on refuelling (▷ page 336).

⁴² Only for certain countries.

AMG vehicles and 12-cylinder engines

! Only refuel using super unleaded petrol with at least 98 RON/88 MON that conforms to European standard EN 228 or an equivalent specification.

You can otherwise impair engine output or damage the engine.

! Premium-grade unleaded petrol with an octane rating of 95 RON/85 MON may be used as a temporary measure if the recommended fuel is not available. This may reduce engine performance and increase fuel consumption. As much as possible, avoid driving at full throttle.

! Regular unleaded petrol with an octane rating of 91 RON/82.5 MON may also be used as a temporary measure if the recommended fuel is not available.

Doing so results in noticeably higher fuel consumption, and the engine power output is noticeably reduced. Avoid driving at full throttle.

If only regular unleaded petrol with an octane rating of 91 RON/82.5 MON or lower is available, you must have the vehicle adapted to this fuel at a qualified specialist workshop.

i E10 fuel contains up to 10% bioethanol. Your vehicle is E10-compatible. You can refuel your vehicle using E10 fuel.

Additives

! Do not refuel with low grade fuel and do not use fuel additives that have not been tested and approved for Mercedes-Benz vehicles. Otherwise the fuel system could malfunction or be damaged.

One of the major problems with low-grade fuel is the creation of carbon deposits during the process of burning fuel. Mercedes-Benz recommends that you use fuel brands that have additives.

If you use fuels without these additives for a longer period of time, there may be a build-up of carbon deposits. These will form especially

on the inlet valves and in the combustion chamber.

This could lead to engine running problems, e.g.:

- longer engine warm-up phase
- uneven idle
- engine noise
- misfiring
- loss of power

In areas where petrol with the required additives is not available, carbon deposits can build up. In this case, Mercedes-Benz recommends the use of additives that have been approved for Mercedes-Benz vehicles; see <http://bevo.mercedes-benz.com>.

Consult a Mercedes-Benz Service Centre to view a list of approved products. Observe the instructions for use in the product description.

Do not mix other fuel additives with fuel. This causes unnecessary costs and could damage the engine.

Diesel (EN 590)

Fuel grade

WARNING

Do not use petrol to refuel vehicles with a diesel engine. Do not mix diesel with petrol. This would result in damage to the fuel system and engine, which could lead to a vehicle fire.

! When refuelling, only use diesel fuel that conforms to the European standard EN 590 or is of equivalent quality. Fuel that does not conform to EN 590 can lead to increased wear as well as damage to the engine and exhaust system.

! Do not use the following:

- marine diesel
- heating oil
- bio-diesel
- vegetable oil
- petrol

- paraffin
- kerosene

Do not mix these fuels with diesel fuels and do not use any special additives. Otherwise, this can lead to damage to the engine. This excludes flow improver; see "Low outside temperatures".

! **Vehicles with a diesel particle filter:** in countries outside the EU, only refuel with low-sulphur Euro diesel with a sulphur content under 50 ppm; otherwise the emission control system could be damaged.

! **Vehicles without a diesel particle filter:** in countries where only diesel fuel with a high sulphur content is available, you will need to carry out your vehicle's oil change at shorter intervals. More information about the interval for oil change can be obtained from any qualified specialist workshop.

Usually you will find information about the fuel grade on the pump. If you cannot find the label on the petrol pump, ask the filling station staff.

Information on refuelling (▷ page 336).

Low outside temperatures

In winter months, diesel fuel with an improved cold flow quality is available. In Europe, the EN 590 standard defines various climate-dependent temperature categories. Malfunctions can be avoided by refuelling with diesel fuel that corresponds to the climatic specifications outlined in EN 590. At unusually low outside temperatures, it is possible that the flow characteristics of the diesel fuel could be insufficient. Accordingly, diesel fuel from warmer areas may not be suitable for operation in colder climatic conditions.

i Further information on country-specific fuel properties can be obtained from oil companies, e.g. at filling stations.

Flow improvers

To improve the low-temperature resistance of diesel fuel, a flow improver can be attached. The effectiveness of a flow improver is not guaranteed for every fuel.

Only use flow improvers tested and approved by Mercedes-Benz. During use, please observe the information on operation.

Correct dosage and sufficient mixing are decisive in improving low-temperature resistance with the flow improver. Overdosage can potentially even decrease low-temperature resistance and must therefore be avoided. Follow the manufacturer's guidelines on dosage.

Mix the additive into the diesel in good time, before the flow characteristics of the diesel become insufficient. Otherwise, malfunctions can arise through heating the fuel system, e.g. through parking in a heated garage.

More information about recommended flow improvers can be obtained from any qualified specialist workshop.

Notes on fuel consumption

🌱 Environmental note

CO₂ (carbon dioxide) is the gas which scientists believe to be principally responsible for global warming (the greenhouse effect). Your vehicle's CO₂ emissions are directly related to fuel consumption and therefore depend on:

- efficient use of the fuel by the engine
- driving style
- other non-technical factors, such as environmental influences or road conditions

You can minimise your vehicle's CO₂ emissions by driving carefully and having it serviced regularly.

The vehicle will use more fuel than usual in the following situations:

- at very low outside temperatures
- in urban traffic
- on short journeys

- in mountainous terrain
- when towing a trailer

i Only for certain countries: you can find the current consumption and emission values of your vehicle in the COC documents (EU CERTIFICATE OF CONFORMITY). These documents are delivered with your vehicle.

The consumption figures were in each case based on the currently applicable version:

- for vehicles up to and including the EURO 4 standard, in accordance with EU Directive 80/1268/ECC
- for vehicles above the EURO 5 standard, in accordance with Regulation (EC) No. 715/2007

Deviations from these values may occur under normal operating conditions.

AdBlue®

Points to remember

AdBlue® is a non-flammable, non-toxic, colourless, odourless and water-soluble fluid.

High outside temperatures

WARNING

If you open the AdBlue® tank cap, small amounts of ammonia vapour may be released. This depends in particular upon the age of the AdBlue®.

Ammonia vapours have a pungent odour and are particularly irritating to:

- skin
- mucous membranes
- eyes

You may experience a burning sensation in your eyes, nose and throat, as well as coughing and watering of the eyes.

Do not inhale any ammonia vapours that may be released. Fill the AdBlue® tank only in well-ventilated areas.

Low outside temperatures

AdBlue® freezes at a temperature of approximately -11 °C. The vehicle is equipped with an AdBlue® preheating system at the factory. Winter operation can thus be guaranteed even at temperatures below -11 °C.

Additives

! Only use AdBlue® in accordance with ISO 22241. Do not use additives with AdBlue® and do not dilute AdBlue® with water. This may destroy the BlueTEC exhaust gas aftertreatment system.

Purity

! Impurities in AdBlue® (e.g. due to other service products, cleaning agents or dust) lead to:

- increased emission values
- damage to the catalytic converter
- engine damage
- malfunctions in the BlueTEC® exhaust gas aftertreatment system

Assuring the purity of AdBlue® is particularly important with respect to avoiding malfunctions in the BlueTEC exhaust gas aftertreatment system.

If AdBlue® is pumped out of the AdBlue® tank, e.g. during repair work, do not use this fluid to refill the tank. The purity of the fluid can no longer be guaranteed.

Total capacity of the AdBlue® tank

Model	Total capacity
S 350 BlueTEC	25 l
S 350 BlueTEC 4MATIC	

Engine oil

Points to remember

The quality of the engine oil is decisive for the function and service life of an engine. After extensive tests, Mercedes-Benz approves engine oils that correspond to the current technical standard.

Therefore, only Mercedes-Benz approved engine oils may be used in Mercedes-Benz engines.

Further information on tested and approved engine oils can be obtained from any Mercedes-Benz Service Centre. Mercedes-Benz recommends that you have the oil change carried out at a qualified specialist workshop. Mercedes-Benz approval is indicated on the oil container by the inscription "MB Approval" and the corresponding designation, e.g. MB Approval 229.51.

You can call up an overview of approved engine oils on the Internet at: <http://bevo.mercedes-benz.com> by entering the designation, e.g. 229.5.

The table shows which engine oils have been approved for your vehicle.

Petrol engines	MB Approval
S 300	229.3, 229.5
S 350 ⁴³	
S 350 4MATIC ⁴³	
S 500 ⁴³	229.5
S 500 4MATIC ⁴³	
S 600 AMG ⁴⁴	
S 63 AMG ⁴⁴	
S 65 AMG ⁴⁴	

⁴³ BlueEFFICIENCY

⁴⁴ Only SAE 0W-40/SAE 5W-40 engine oils may be used.

⁴⁵ Only for certain countries.

⁴⁶ Only SAE 0W-40/SAE 5W-40 engine oils may be used for AMG vehicles.

Diesel engines	MB Approval
Vehicles without a diesel particle filter	
S 350 CDI ⁴⁵	228.3, 228.5, 228.51, 229.3, 229.31, 229.5, 229.51
Vehicles with a diesel particle filter	
S 250 CDI ⁴³	228.51,
S 350 CDI ⁴⁵	229.31, 229.51
S 350 BlueTEC	
S 350 BlueTEC 4MATIC	

i If the engine oils listed in the table are not available, you may add the following engine oils until the next oil change:

- vehicles with a petrol engine⁴⁶: MB Approval 229.1 or ACEA A3
- vehicles with a diesel engine: MB Approval 229.1 or ACEA C3

This may only be topped up once, and the quantity must not be greater than 1.0 l.

Capacities

The following values refer to an oil change including the oil filter.

Model	Replacement amount
S 350 ⁴⁷ S 350 4MATIC ⁴⁷ S 250 CDI ⁴⁷	6.5 l
S 300 S 350 CDI ⁴⁸ S 350 BlueTEC S 350 BlueTEC 4MATIC	8.0 l
S 500 ⁴⁷ S 500 4MATIC ⁴⁷	8.5 l
S 63 AMG S 600 S 65 AMG	8.5 l (9.5 l ⁴⁹) 9.0 l

Additives

! Do not use any additives with the engine oil. This could damage the engine.

Engine oil viscosity

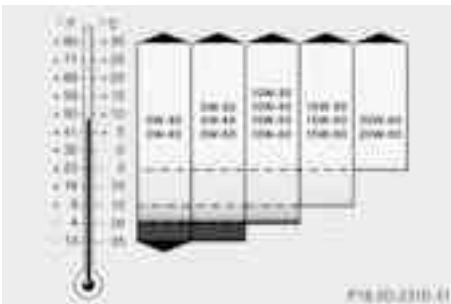

Viscosity describes the flow characteristics of a fluid. If an engine oil has a high viscosity rating, it flows slowly; the lower the viscosity, the faster it flows.

Engine oil selection is based on the respective outside temperatures and in accordance with

⁴⁷ BlueEFFICIENCY

⁴⁸ Only for certain countries.

⁴⁹ Including external oil cooler.

the SAE classification (viscosity). The table shows you which SAE classifications are to be used. The low-temperature properties of engine oils can be significantly impaired during operation due to, for example, ageing or soot and fuel accretion. It is therefore strongly recommended to observe regular oil changes using an approved engine oil with the appropriate SAE classification.

Brake fluid

⚠ WARNING

Over a period of time, the brake fluid absorbs moisture from the air; This lowers its boiling point.

If the boiling point of the brake fluid is too low, vapour pockets may form in the brake system when the brakes are applied hard (e.g. when driving downhill). This impairs braking efficiency.

You should have the brake fluid renewed at regular intervals. The brake fluid change intervals can be found in the Service Booklet.

Only use brake fluid approved by Mercedes-Benz. Information about approved brake fluid can be obtained at any qualified specialist workshop or on the Internet at <http://bevo.mercedes-benz.com>.

i Have the brake fluid regularly checked at a qualified specialist workshop.

There is usually a notice in the engine compartment to remind you when the next brake fluid change is due.

Coolant

Important safety notes

WARNING

Antifreeze is highly flammable. Fire, naked flames and smoking are prohibited when handling antifreeze.

If antifreeze comes into contact with hot engine parts, it may ignite and you could burn yourself. Do not spill any antifreeze on hot engine parts.

! Only add coolant that has been premixed with the desired antifreeze protection. You could otherwise damage the engine.

Further information on coolants can be found in the Mercedes-Benz Specifications for Service Products, MB Specifications for Service Products 310.1, e.g. on the Internet at <http://bevo.mercedes-benz.com>. Or contact a qualified specialist workshop.

! Always use a suitable coolant mixture, even in countries where high temperatures prevail.

Otherwise, the engine cooling system is not sufficiently protected from corrosion and overheating.

! The engine cooling system is filled with coolant, which must be renewed after 15 years or after 250,000 kilometres at the latest.

The coolant is a mixture of water and antifreeze/corrosion inhibitor. It performs the following tasks:

- anti-corrosion protection
- antifreeze protection
- raising the boiling point

If antifreeze/corrosion inhibitor is present in the correct concentration, the boiling point of the coolant during operation will be around 130 °C.

The antifreeze/corrosion inhibitor concentration in the engine cooling system should:

- be at least 50 %. This will protect the engine cooling system against freezing down to around -37 °C.
- not exceed 55 % (antifreeze protection down to -45 °C). Heat will otherwise not be dissipated as effectively.

If the vehicle has lost coolant, top it up with equal amounts of water and antifreeze/corrosion inhibitor. Mercedes-Benz recommends an antifreeze/corrosion inhibitor concentrate in accordance with MB Specifications for Service Products 310.1.

The coolant is checked at every maintenance interval at a qualified specialist workshop.

i When the vehicle is first delivered, it is filled with a coolant mixture that ensures adequate antifreeze and corrosion protection.

Washer fluid

WARNING

Windscreen washer fluid/antifreeze is highly flammable. Avoid spilling windscreen washer fluid/antifreeze on hot engine components as it can ignite and burn. Severe burns could be the result.

! Only use washer fluid that is suitable for plastic lamp lenses, e.g. MB SummerFit or MB WinterFit. Unsuitable washer fluid could damage the plastic lenses of the headlamps.

! Do not use distilled or de-ionised water in the washer fluid reservoir. Otherwise, the level sensor may be damaged.

! Only the washer fluids SummerFit and WinterFit can be mixed. Otherwise, the spraying nozzles could become blocked.

At temperatures above freezing:

- ▶ Fill the washer fluid reservoir with a mixture of water and washer fluid, e.g. MB SummerFit.
- ▶ Mix 1 part MB SummerFit to 100 parts water.

At temperatures below freezing:

- ▶ Fill the washer fluid reservoir with a mixture of water and washer fluid, e.g. MB WinterFit. Adapt the mixing ratio to the outside temperature.
- ▶ Down to -10 °C: mix 1 part MB WinterFit with 2 parts water.
- ▶ Down to -20 °C: mix 1 part MB WinterFit with 1 part water.
- ▶ Down to -29 °C: mix 2 parts MB WinterFit with 1 part water.

- i** Add washer fluid concentrate, e.g. MB SummerFit or MB WinterFit, to the washer fluid all year round.

Vehicle data

Please note that for the specified vehicle data:

- the heights specified may vary as a result of:
 - tyres
 - load
 - condition of the suspension
 - optional equipment
- items of optional equipment increase the unladen weight and reduce the maximum payload. The unladen weight is specified in accordance with EC directive and includes:
 - driver (68 kg)
 - luggage (7 kg)
 - all fluids (fuel tank 90% full)

- vehicle-specific weight information can be found on the vehicle identification plate (▷ page 532).
- only for certain countries: you can find vehicle-specific vehicle data in the COC documents (CERTIFICATE OF CONFORMITY). These documents are delivered with your vehicle.

Missing values were not available at the time of going to print.

All models (except AMG vehicles)	
Vehicle length, short wheelbase (ECE)	5096 mm
Vehicle length, long wheelbase (ECE)	5226 mm
Vehicle width including exterior mirrors	2120 mm
Vehicle width excluding exterior mirrors	1871 mm
Vehicle height	1479 mm
Wheelbase, short	3035 mm
Wheelbase, long	3165 mm
Maximum roof load	100 kg
Maximum boot load	100 kg

S 300	
Unladen weight	1955 kg
S 350 BlueEFFICIENCY	
Unladen weight, short wheelbase	1910 kg
Unladen weight, long wheelbase	1975 kg

S 350 4MATIC BlueEFFICIENCY	
Unladen weight, short wheelbase	1980 kg
Unladen weight, long wheelbase	

S 500 BlueEFFICIENCY	
Unladen weight, short wheelbase	2010 kg
Unladen weight, long wheelbase	2075 kg

S 500 4MATIC BlueEFFICIENCY	
Unladen weight, short wheelbase	2075 kg
Unladen weight, long wheelbase	2140 kg

S 600	
Unladen weight	2210 kg

S 250 CDI BlueEFFICIENCY	
Unladen weight, short wheelbase	1970 kg
Unladen weight, long wheelbase	2045 kg

S 350 CDI (only for certain countries)	
Unladen weight, short wheelbase	
Unladen weight, long wheelbase	

S 350 BlueTEC	
Unladen weight, short wheelbase	1995 kg
Unladen weight, long wheelbase	

S 350 BlueTEC 4MATIC	
Unladen weight, short wheelbase	2065 kg
Unladen weight, long wheelbase	2130 kg

S 63 AMG	
Vehicle length, short wheelbase (ECE)	5122 mm
Vehicle length, long wheelbase (ECE)	5252 mm
Vehicle width including exterior mirrors	2120 mm
Vehicle width excluding exterior mirrors	1871 mm
Vehicle height	1488 mm
Short wheelbase	3035 mm
Long wheelbase	3165 mm
Unladen weight, short wheelbase	2120 kg
Unladen weight, long wheelbase	2170 kg
Maximum roof load	100 kg
Maximum boot load	100 kg

S 65 AMG	
Vehicle length (ECE)	5252 mm
Vehicle width including exterior mirrors	2120 mm

S 65 AMG	
Vehicle width excluding exterior mirrors	1871 mm
Vehicle height	1488 mm
Wheelbase	3165 mm
Unladen weight	2275 kg
Maximum roof load	100 kg
Maximum boot load	100 kg

Boot lid opening dimensions

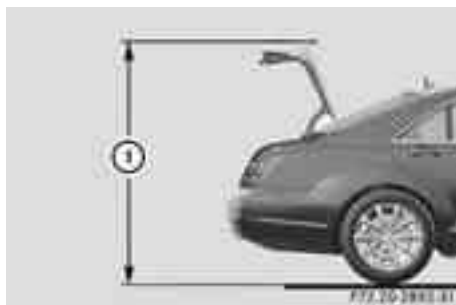

- ① Height when opened: 1,776 mm

trailer tow hitch

Mounting dimensions

WARNING

Only have a trailer tow hitch retrofitted at a qualified specialist workshop which has the necessary specialist knowledge and tools to carry out the work required. Mercedes-Benz recommends that you use a Mercedes-Benz Service Centre for this purpose. In particular, work relevant to safety or on safety-related systems must be carried out at a qualified specialist workshop.

- !** If you have a trailer tow hitch retrofitted, changes to the cooling system may be necessary, depending on the vehicle type. If you have a trailer tow hitch retrofitted, observe the anchorage points on the chassis frame.

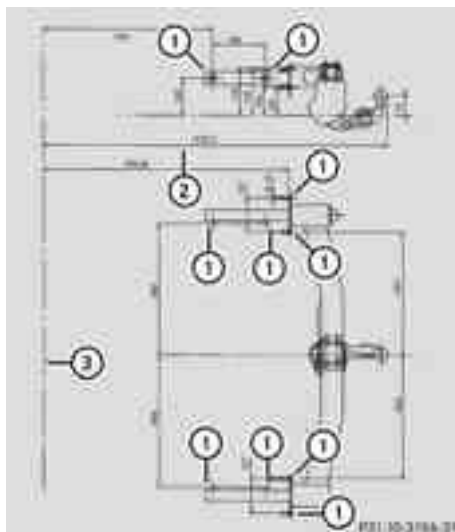

Example: anchorage points for the trailer tow hitch

- ① Anchorage points
- ② Overhang dimension
- ③ Rear axle centre line

For trailer tow hitches fitted at the factory, the overhang dimension including protective covering is 1,275 mm.

Trailer loads

Missing values for the S 350 CDI were not available at the time of going to print.

	All models ^{50, 51}
Permissible trailer load, braked	2100 kg
Permissible trailer load, unbraked ⁵²	750 kg
Maximum drawbar noseweight ⁵³	85 kg

⁵⁰ Except the S 350 CDI.

⁵¹ The S 63 AMG, S 65 AMG and S 250 CDI BlueEFFICIENCY cannot be used for towing a trailer.

⁵² At a minimum gradient-climbing capability of 12 % from a standstill.

⁵³ The drawbar noseweight is not included in the trailer load.

Permissible rear axle load when towing a trailer

	Short wheelbase	Long wheelbase
S 300	–	1460 kg
S 350⁵⁴	1445 kg	1470 kg
S 350 4MATIC⁵⁴	1460 kg	1480 kg
S 500⁵⁴	1480 kg	1480 kg
S 500 4MATIC⁵⁴	1460 kg	1490 kg
S 600	–	1495 kg
S 350 CDI	_55	_55
S 350 BlueTEC	1475 kg	1485 kg
S 350 BlueTEC 4MATIC	1480 kg	1490 kg

24 GHz radar sensor system (country overview)

The 24 GHz radar sensor system requires separate approval for each country. If you are driving in a country in which the radar sensor system is not approved, you must deactivate the system using the on-board computer (▷ page 408). The current country overview can be obtained from a Mercedes-Benz Service Centre.

Vehicles with a navigation system: the radar sensor system is deactivated automatically near radio telescope facilities.

The currently active systems are automatically deactivated:

- DISTRONIC PLUS (▷ page 348)
- Blind Spot Assist (▷ page 376)
- Active Blind Spot Assist⁵⁶ (▷ page 380)
- PRE-SAFE® Brake (▷ page 74)

A display message appears in the multifunction display to tell you that the radar sensor system is being switched off (▷ page 430).

BAS PLUS (▷ page 70) is then also unavailable.

If the deactivation does not occur automatically, you must deactivate the radar sensor system using the on-board computer (▷ page 408).

Vehicles without navigation and vehicles for Australia: you must deactivate the radar sensor system using the on-board computer when you are near a radio telescope facility (▷ page 408).

⁵⁴ BlueEFFICIENCY

⁵⁵ Missing values for the S 350 CDI were not available at the time of going to print.

⁵⁶ Not available on hybrid vehicles.

Country	Radio telescope facilities	Geographical latitude and longitude	Distance to be maintained from the facility
Egypt	-	-	-
Andorra	-	-	-
Australia	Parkes	32°59'59" S, 148°15'44" E	10 km
	Narrabri	30°18'52" S, 149°32'56" E	10 km
	Canberra	35°23'54" S, 148°58'40" E	3 km
	Western Australia	26°37'13" S, 117°30'40" E	10 km
Bahrain	-	-	-
Belgium	-	-	-
Bosnia-Herzegovina	-	-	-
Bulgaria	-	-	-
Denmark	-	-	-
Germany	Effelsberg	50°31'32" N, 06°53'00" E	6.5 km
Estonia	-	-	-
Finland	Metsähovi	60°13'04" N, 24°23'37" E	7 km
	Tuorla	60°24'56" N, 22°26'31" E	5 km
France	Plateau de Bure	44°38'01" N, 05°54'26" E	35 km
	Floirac	44°50'10" N, 00°31'37" W	35 km
Gibraltar	-	-	-
Greece	-	-	-
United Kingdom	Cambridge	52°09'59" N, 00°02'20" E	9 km
	Darnhall	53°09'22" N, 02°32'03" W	5 km
	Jodrell Bank	53°14'10" N, 02°18'26" W	9 km
	Knockin	52°47'24" N, 02°59'45" W	5 km
	Pickmere	53°17'18" N, 02°26'38" W	5 km
Ireland	-	-	-
Iceland	-	-	-
Italy	Medicina	44°31'14" N, 11°38'49" E	20 km

Country	Radio telescope facilities	Geographical latitude and longitude	Distance to be maintained from the facility
	Noto	36°52'34" N, 14°59'21" E	8 km
	Sardinia	39°29'50" N, 09°14'40" E	15 km
Yemen	-	-	-
Jordan	-	-	-
Canada	-	-	-
Qatar	-	-	-
Croatia	-	-	-
Kuwait	-	-	-
Latvia	Ventspils	57°33'12" N, 21°51'17" E	8.5 km
Lebanon	-	-	-
Lithuania	-	-	-
Luxembourg	-	-	-
Malaysia	-	-	-
Malta	-	-	-
Macedonia	-	-	-
Mexico	-	-	-
Mongolia	-	-	-
New Zealand	-	-	-
Netherlands	-	-	-
Norway	-	-	-
Oman	-	-	-
Austria	-	-	-
Pakistan	-	-	-
Poland	Kraków-Fort Skała	50°03'18" N, 19°49'36" E	1 km
	Toruń-Piwnice	52°54'48" N, 18°33'30" E	1 km
Portugal	-	-	-
Romania	-	-	-
Russia	Dimitrov	56°26'00" N, 37°27'00" E	35 km

Country	Radio telescope facilities	Geographical latitude and longitude	Distance to be maintained from the facility
	Kalyazin	57° 13' 22" N, 37° 54' 01" E	35 km
	Pushchino	54° 49' 00" N, 37° 40' 00" E	35 km
	Zelenchukskaya	43° 49' 53" N, 41° 35' 32" E	35 km
Saudi Arabia	-	-	-
Sweden	Onsala	57° 23' 45" N, 11° 55' 35" E	12 km
Switzerland	Bleien	47° 20' 26" N, 08° 06' 44" E	3 km
Singapore	-	-	-
Slovakia	-	-	-
Slovenia	-	-	-
Spain	Yebes	40° 31' 27" N, 03° 05' 22" W	15 km
	Robledo	40° 25' 38" N, 04° 14' 57" W	7 km
South Africa	-	-	-
Syria	-	-	-
Czech Republic	-	-	-
Turkey	-	-	-
Ukraine	-	-	-
Hungary	Penc	47° 47' 22" N, 19° 16' 53" E	2 km
USA	-	-	-
United Arab Emirates	-	-	-
Cyprus	-	-	-

Publication details

Internet

Further information about Mercedes-Benz vehicles and about Daimler AG can be found on the following websites:

<http://www.mercedes-benz.com>

<http://www.daimler.com>

Editorial office

You are welcome to forward any queries or suggestions you may have regarding this Owner's Manual to the technical documentation team at the following address:

Daimler AG, HPC: R822,

D-70546 Stuttgart, Germany

Not to be reprinted, translated or otherwise reproduced, in whole or in part, without written permission of Daimler AG.

As at 24.11.2011

Nur für internen Gebrauch / For internal use only



2215840196Z102

Order no. 6515 2379 02 Part no. 221 584 01 96 Z102 Edition ÄJ 2012-Va

Nur für internen Gebrauch / For internal use only