



R-Class

Owner's Manual



Mercedes-Benz

Nur für internen Gebrauch / For internal use only

Symbols

In this Owner's Manual, you will find the following symbols:

WARNING

Warning notices draw your attention to hazards that may endanger your health or life, or the health or life of others.

Environmental note

Environmental notes provide you with information on environmentally aware actions or disposal.

 Notes on material damage alert you to dangers that could lead to damage to your vehicle.

 These symbols indicate useful instructions or further information that could be helpful to you.

▶ This symbol designates an instruction you must follow.

▶ Several consecutive symbols indicate an instruction with several steps.

(▷ page) This symbol tells you where you can find further information on a topic.

▷▷ This symbol indicates a warning or an instruction that is continued on the next page.

Display This text indicates a message on the multifunction/COMAND display.



This symbol tells you that you can find further information in the Digital Owner's Manual.

Parts of the software in the vehicle are protected by copyright © 2005
The FreeType Project
<http://www.freetype.org>. All rights reserved.

Welcome to the world of Mercedes-Benz

Before you first drive off, read this Owner's Manual carefully and familiarise yourself with your vehicle. For your own safety and a longer vehicle life, follow the instructions and warning notices in this manual. Disregarding them may lead to damage to the vehicle or personal injury.

The equipment or model designation of your vehicle may vary according to:

- model
- order
- country variant
- availability

The illustrations in this manual show a left-hand-drive vehicle. On right-hand-drive vehicles, the layout of components and controls differs accordingly.

Mercedes-Benz is constantly updating its vehicles to the state of the art.

Mercedes-Benz therefore reserves the right to introduce changes in the following areas:

- design
- equipment
- technical features

Therefore, descriptions may vary from those of your own vehicle.

The following are integral components of the vehicle:

- Owner's Manual
- Service Booklet
- equipment-dependent supplements

Keep printed copies of the documents in the vehicle at all times. If you sell the vehicle, always pass the documents on to the new owner.

i You can get to know the important features of your vehicle in the interactive Owner's Manual on the Internet at:

**[http://www.mercedes-benz.de/
betriebsanleitung](http://www.mercedes-benz.de/betriebsanleitung)**

The technical documentation team at Daimler AG wishes you safe and pleasant motoring.



Index 4

Introduction 21

At a glance 27

Safety 39

Opening and closing 69

Seats, steering wheel and mirrors 91

Lights and windscreen wipers 109

Climate control 123

Driving and parking 143

On-board computer and displays 193

Stowing and features 245

Maintenance and care 277

Breakdown assistance 291

Wheels and tyres 311

Technical data 335

1, 2, 3 ...

12 V socket

see Socket

4ETSsee ETS/4ETS (Electronic Trac-
tion System)**4MATIC (permanent four-wheel****drive)** 176**A****ABS (Anti-lock Braking System)**

Display message 211

Function/notes 62

Important safety notes 62

Warning lamp 235

Activating/deactivating air-recir-**culation mode** 133**Activating/deactivating cooling****with air dehumidification** 129**Active Service System**

see ASSYST PLUS

Adaptive brake lamps 62**AdBlue®**

Display message 220

Notes 342

Service indicator 283

AdBlue® service indicator 283**Additives (engine oil)** 344**Adjusting the armrest (2nd row of****seats)** 98**Adjusting the headlamp range** 112**ADS (Adaptive Damping System)** 174**Airbags**Front airbag (driver, front
passenger) 44

Important safety guidelines 42

Sidebag 44

Triggering 41

Windowbag 45

Air-conditioning system

see Climate control

Air filter (white display message) 220**AIRMATIC (display message)** 221**AIRMATIC package** 174

ADS (Adaptive Damping System) ... 174

Level control 174

Air pressure

see Tyre pressure

Air vents

Important safety notes 139

Rear 140

Setting 139

Setting the centre air vents 140

Setting the side air vents 140

Alarm system

see ATA (Anti-Theft Alarm system)

Anti-glare film 275**Anti-lock Braking System**

see ABS (Anti-lock Braking System)

Anti-Theft Alarm system

see ATA (Anti-Theft Alarm system)

Aquaplaning 162**Ashtray** 263**ASSYST PLUS**

Displaying a service message 282

Hiding a service message 282

Notes 282

Resetting the service interval dis-
play 282

Service message 282

Special service requirements 283

ATA (Anti-Theft Alarm system)

Activating/deactivating 66

Function 66

Interior motion sensor 68

Switching off the alarm 66

Tow-away protection 67

Audio menu (on-board computer) 198**Authorised workshop**

see Qualified specialist workshop

AUTO lights

Display message 217

see Lights

Automatic headlamp mode 111**Automatic transmission**

Accelerator pedal position 152

Automatic drive program 153

Changing gear 152

DIRECT SELECT lever 150

Display message 229

Driving tips 152

Emergency running mode 155

Engaging drive position 151

- Engaging neutral 151
 - Engaging reverse gear 151
 - Engaging the park position 151
 - Kickdown 152
 - Overview 150
 - Problem (fault) 155
 - Program selector button 153
 - Pulling away 147
 - Shift ranges 154
 - Starting the engine 146
 - Steering wheel gearshift paddles ... 153
 - Trailer towing 152
 - Transmission position display 151
 - Transmission positions 152
 - Automatic transmission emergency running mode** 155
 - Auxiliary heating**
 - Activating/deactivating 135
 - Activating/deactivating (on the centre console) 136
 - Display message 231
 - Heater booster function 137
 - Important safety notes 135
 - Problem (display message) 139
 - Remote control 136
 - Setting 205
 - Auxiliary ventilation**
 - Activating/deactivating 135
 - Activating/deactivating (on the centre console) 136
 - Heater booster function 137
 - Problem (display message) 139
 - Remote control 136
 - Axle load, permissible (trailer towing)** 349
- B**
- Ball coupling**
 - Fitting 186
 - Removing 189
 - Storing 190
 - BAS (Brake Assist System)** 62
 - Battery (key)**
 - Checking 73
 - Important safety notes 72
 - Replacing 73
 - Battery (vehicle)**
 - Charging 303
 - Display message 219
 - Important safety notes 301
 - Jump starting 304
 - Overview 301
 - Belt**
 - see Seat belt
 - Belt force limiters (activation)** 41
 - Belt tensioner**
 - Activation 41
 - Function 50
 - Blind Spot Assist**
 - Activating/deactivating 207
 - Display message 222
 - Notes/function 182
 - Trailer towing 184
 - BlueTEC (AdBlue®)** 342
 - Bonnet**
 - Closing 279
 - Display message 230
 - Opening 278
 - Boot**
 - see Tailgate
 - Brake Assist System**
 - see BAS (Brake Assist System)
 - Brake fluid**
 - Display message 214
 - Notes 344
 - Brake lamps**
 - Adaptive 62
 - Display message 216
 - Brakes**
 - ABS 62
 - BAS 62
 - Brake fluid (notes) 344
 - Display message 211
 - Driving tips 160
 - Important safety notes 160
 - Parking brake 159, 161
 - Warning lamp 235
 - Breakdown**
 - see Flat tyre
 - see Towing away
 - Bulbs**
 - see Changing bulbs

C

Calling up a fault

see Display messages

Car

see Vehicle

Care

Automatic car wash	284
Carpets	289
Display	288
Exterior lighting	287
Gear or selector lever	289
High-pressure cleaner	285
Interior	288
Matt paintwork	285
Notes	283
Paint	285
Plastic trim	288
Roof lining	289
Seat belt	289
Seat cover	289
Sensors	287
Steering wheel	289
Tail pipes	287
Trim pieces	289
Washing by hand	284
Wheels	286
Windows	286
Wiper blades	286
Wooden trim	289

Car key

see Keys

Car wash (care) 284**CD player/CD changer(on-board computer)** 198**Central locking**

Automatic locking (on-board computer)	204
Locking/unlocking (key)	70

Centre console

2nd row of seats	249
Lower section	35
Upper section	34

Changing bulbs

Dipped-beam headlamps	117
Important safety notes	115
Licence plate lighting	119
Main-beam headlamps	118

Overview of bulb types	116
Parking lamps (front)	118
Removing/replacing the cover (front wheel arch)	117
Reversing lamps	119
Standing lamps	118
Turn signals (front)	118

Child-proof locks

Important safety notes	60
Rear doors	61

Children

In the vehicle	51
Restraint systems	51

Child seat

Automatic recognition	52
ISOFIX	54
On the front-passenger seat	52
Problem (malfunction)	57
Recommendations	59
Suitable positions	57
Top Tether	55

Cigarette lighter 264**Cleaning**

Mirror turn signal	287
Trailer tow hitch	287

Climate control

Auxiliary heating/ventilation	135
Controlling automatically	130
Convenience opening/closing (air-recirculation mode)	134
Cooling with air dehumidification . .	129
Demisting the windows	133
Demisting the windscreen	132
Important safety notes	124
Indicator lamp	130
Information on using THERMOTRONIC automatic climate control	128
Notes on using THERMATIC automatic climate control	125
Overview of systems	124
Problems with cooling with air dehumidification	130
Problem with the rear window heating	133
Rear control panel	126
Setting the air distribution	131
Setting the airflow	132

- Setting the air vents 139
 - Setting the temperature 131
 - Switching air-recirculation mode on/off 133
 - Switching on/off 128
 - Switching residual heat on/off 134
 - Switching the Mono function on/off 132
 - Switching the rear window heating on/off 133
 - THERMATIC automatic climate control (2-zone) 125
 - THERMOTRONIC (3-zone) automatic climate control 126
 - Clock (on-board computer)** 201
 - Cockpit**
 - Overview 28
 - see Instrument cluster
 - Collapsible emergency spare wheel**
 - see Emergency spare wheel
 - COMAND**
 - see Separate operating instructions
 - COMAND display**
 - Cleaning 288
 - Combination switch** 113
 - Compass**
 - Calibrating 273
 - Display message 229
 - Notes 272
 - Setting 273
 - Constant headlamp mode**
 - see Daytime driving lights
 - Consumption statistics (on-board computer)** 207
 - Convenience closing feature** 83
 - Convenience opening/closing (air-recirculation mode)** 134
 - Convenience opening feature** 83
 - Coolant (engine)**
 - Checking the level 281
 - Display message 218
 - Important safety notes 345
 - Temperature gauge 197
 - Cooling**
 - see Climate control
 - Crash-responsive emergency lighting** 115
 - Cruise control**
 - Activating 164
 - Activation conditions 164
 - Cruise control lever 163
 - Deactivating 165
 - Display message 223
 - Driving system 163
 - Important safety notes 163
 - LIM indicator lamp 163
 - Selecting 163
 - Storing and maintaining current speed 164
 - Cup holder**
 - Centre console 260
 - Important safety notes 260
 - second row of seats 261
 - Second row of seats (armrest) 262
 - Third row of seats 262
- D**
- Dashboard**
 - see Instrument cluster
 - Dashboard lighting**
 - see Instrument cluster lighting
 - Data**
 - see Technical data
 - Date (on-board computer)** 201
 - Daytime driving lights**
 - Display message 217
 - Switching on/off (on-board computer) 202
 - Switching on/off (switch) 111
 - Dealership**
 - see Qualified specialist workshop
 - Delayed switch-off**
 - Exterior lighting (on-board computer) 202
 - Interior lighting 203
 - Diagnostics connection** 23
 - Diesel** 341
 - Diesel particle filter** 160
 - Digital speedometer**
 - Displaying 197
 - Setting the unit (on-board computer) 201

- Dipped-beam headlamps**
 - Changing bulbs 117
 - Display message 215
 - Setting for driving abroad (symmetrical) 110
 - Switching on/off 111
- DIRECT SELECT lever**
 - see Automatic transmission
- Display message**
 - ASSYST PLUS 282
 - General information 210
 - Hiding (on-board computer) 210
 - KEYLESS-GO 232
- Display messages**
 - Calling up (on-board computer) 210
 - Driving systems 221
 - Engine 218
 - Key 232
 - Lights 214
 - Safety systems 211
 - Tyres 225
 - Vehicle 229
- Distance warning function**
 - Activating/deactivating 207
 - Function/notes 65
 - Warning lamp 242
- Distance warning signal (warning lamp)** 242
- Distronic**
 - Display message 224
 - Driving tips 172
- DISTRONIC**
 - Deactivating 172
 - Displays in the multifunction display 171
 - Important safety notes 167
 - Notes/function 167
 - Selecting 169
 - Setting the specified minimum distance 171
 - Warning lamp 242
- Door**
 - Automatic locking (on-board computer) 204
 - Automatic locking (switch) 77
 - Central locking/unlocking (key) 70
 - Control panel 37
 - Display message 230
 - Emergency locking 78
 - Emergency unlocking 77
 - Important safety notes 76
 - Opening (from the inside) 76
- Doors**
 - Overview 76
- Drive program (automatic)** 153
- Driver's door**
 - see Door
- Driving abroad**
 - Service24h 283
 - Symmetrical dipped beam 110
- Driving on flooded roads** 162
- Driving safety system**
 - Distance warning function 65
 - Electronic Brake-force Distribution 64
 - ESP® (Electronic Stability Program) 63
 - ETS/4ETS (Electronic Traction System) 63
 - Important safety guidelines 61
- Driving safety systems**
 - ABS (Anti-lock Braking System) 62
 - Adaptive brake lamps 62
 - BAS (Brake Assist System) 62
 - Overview 61
- Driving system**
 - ADS 174
 - AIRMATIC package 174
 - Level control (vehicle with AIR-MATIC package) 174
- Driving systems**
 - Blind Spot Assist 182
 - Cruise control 163
 - Display message 221
 - Distronic 167
 - PARKTRONIC 177
 - Reversing camera 180
 - SPEEDTRONIC 165
- Driving tips**
 - Aquaplaning 162
 - Automatic transmission 152
 - Brakes 160
 - DISTRONIC 172
 - Downhill gradient 160
 - Driving abroad 110

- Driving in winter 162
 - Driving on flooded roads 162
 - Driving on wet roads 162
 - Fuel 160
 - General 160
 - Icy road surfaces 162
 - Limited braking efficiency on salted roads 161
 - New brake pads/linings 161
 - Running-in tips 144
 - Snow chains 315
 - Symmetrical dipped beam 110
 - Towing a trailer 184
 - Wet road surface 161
 - DVD audio**
 - Operating (on-board computer) 198
 - DVD video**
 - Operating (on-board computer) 199
- E**
- EASY-ENTRY feature**
 - Activating/deactivating 206
 - Function/notes 104
 - EASY-EXIT feature**
 - Crash-responsive 105
 - Function/notes 104
 - Switching on/off 206
 - EBD (electronic brake force distribution)**
 - Display message 213
 - Function/notes 64
 - Electrical fuses**
 - see Fuses
 - Electronic Stability Program**
 - see ESP® (Electronic Stability Program)
 - Electronic Traction System**
 - see ETS/4ETS (Electronic Traction System)
 - Emergency key**
 - Unlocking the driver's door 77
 - Emergency key element**
 - Function/notes 72
 - Emergency release**
 - Driver's door 77
 - Fuel filler flap 156
 - Emergency spare wheel**
 - Important safety notes 328
 - Inflating the collapsible spare wheel 330
 - Points to remember 329
 - Storage location 329
 - Stowing 331
 - Technical data 333
 - Emergency unlocking**
 - Vehicle 77
 - Engine**
 - Display message 218
 - Engine number 339
 - Jump-starting 304
 - Running irregularly 149
 - Starting problems 149
 - Starting the engine with the key 146
 - Starting with KEYLESS GO 147
 - Stopping 158
 - Tow-starting (vehicle) 309
 - Warning lamp (engine diagnostics) 241
 - Engine electronics**
 - Notes 337
 - Problem (fault) 149
 - Engine oil**
 - Additives 344
 - Checking the oil level 279
 - Checking the oil level using the dipstick 280
 - Display message 219
 - Filling capacity 344
 - Notes about oil grades 343
 - Notes on oil level/consumption 279
 - Topping up 280
 - Viscosity 344
 - Environmental protection**
 - Returning an end-of-life vehicle 21
 - ESP® (Electronic Stability Program)**
 - Deactivating/activating 64
 - Display message 211
 - ETS/4ETS 63
 - Function/notes 63
 - Important safety guidelines 63
 - Trailer stabilisation 64
 - Warning lamp 237

ETS/4ETS (Electronic Traction System)	63
Exhaust tail pipe (cleaning instructions)	287
Exterior lighting see Lights	
Exterior mirrors	
Adjusting	105
Anti-dazzle mode (automatic)	107
Folding in/out (automatically)	106
Folding in/out (electrically)	106
Folding in when locking (on-board computer)	206
Out of position (troubleshooting) ...	106
Parking position	107
Resetting	106
Storing settings (memory function)	108
F	
Fault message see Display messages	
Filler cap see Fuel filler flap	
Fire extinguisher	293
First-aid kit	292
Fitting a wheel Removing a wheel	323
Fitting wheels	
Fitting a wheel	324
Lowering the vehicle	325
Raising the vehicle	322
Securing the vehicle against rolling away	321
Flat tyre	
MOExtended tyres	295
Preparing the vehicle	295
TIREFIT kit	296
Floormat	274
Foglamps Switching on/off	111
Frequencies	
Garage door opener	269
Mobile phone	337
Two-way radio	337
Front foglamps Display message	216

Fuel	
Additives	340
Calling up the range	208
Consumption information	342
Consumption statistics	207
Displaying the current consumption	208
Driving tips	160
Fuel gauge	30
Grade (petrol)	340
Important safety notes	339
Problem (malfunction)	157
Quality (diesel)	341
Refuelling	155
Tank content/reserve fuel	340
Fuel filler flap	
Emergency release	156
Opening/closing	156
Fuel filter (white display message) .	220
Fuel level	
Calling up the range (on-board computer)	208
Gauge	30
Fuel reserve see Fuel	
Fuel tank	
Capacity	340
Problem (malfunction)	157
Fuse allocation chart (vehicle tool kit)	294
Fuses	
Allocation chart	309
Before changing	309
Dashboard fuse box	309
Fuse box in the engine compartment	310
Fuse box in the luggage compartment	310
Important safety notes	309
G	
Garage door opener	
Clearing the memory	269
Frequencies	269
Important safety notes	267

Opening/closing the garage door ..	268
Programming (button in the rear-view mirror)	267
Genuine Mercedes-Benz parts	336
Glove compartment	247

H

Handbrake	
see Parking brake	
Hazard warning lamps	114
Headlamp	
Cleaning system (function)	113
Cleaning system (notes)	345
Headlamp delayed switch-off	
see Exterior lighting delayed switch-off	
Headlamps	
Misting up	114
Topping up the cleaning system	281
see Automatic headlamp mode	
Head restraints	
Adjusting	95
Adjusting (electrically)	95
Adjusting (manually)	95
Adjusting (rear)	96
Fitting/removing (rear)	96
Luxury	95
see NECK-PRO head restraints/ NECK-PRO luxury head restraints	
Heater booster function	137
Heating	
see Climate control	
High-pressure cleaners	285
Hill start assist	147

I

Ignition lock	
see Key positions	
Immobiliser	66
Indicator and warning lamps	
Engine diagnostics	241
Fuel tank	241
Indicator lamps	
Display message	215
see Warning and indicator lamps	
Insect protection on the radiator	279

Inspection

 see ASSYST PLUS

Instrument cluster

Overview	30
Selecting the language (on-board computer)	201
Settings	200
Warning and indicator lamps	32
Instrument cluster lighting	194
Interior lighting	114
Automatic control system	115
Delayed switch-off (on-board computer)	203
Emergency lighting	115
Manual control	115
Overview	114
Reading lamp	114

Interior motion sensor

Activating/deactivating (on-board computer)	207
Notes	68

ISOFIX child seat securing system

54

J

Jack

Storage location	293
Using	322

Jump start (engine)

 see Jump starting (engine)

Jump starting (engine)

304

K

Key

Changing the battery	73
Checking the battery	73
Convenience closing feature	84
Convenience opening feature	83
Display message	232
Door central locking/unlocking	70
Emergency key element	72
Important safety notes	70
Loss	75
Modifying the programming	71
Positions (ignition lock)	145

- Problem (malfunction) 75
 Starting the engine 146
- KEYLESS-GO**
 Convenience closing 84
 Display message 232
 Locking 71
 Start/Stop button 145
 Starting the engine 147
 Unlocking 71
- Key positions**
 Key 145
 KEYLESS GO 145
- Keys**
 Overview 70
- Kickdown**
 Driving tips 152
- L**
- Lamps**
 see Warning and indicator lamps
- Language (on-board computer)** 201
- Lashing eyelets** 255
- Level control (display message)** 221
- Level control (vehicle with AIR-MATIC package)**
 Basic settings 175
 Function/notes 174
 Important safety notes 174
- Licence plate lamp**
 Display message 216
- Licence plate lighting**
 Changing bulbs 119
- Lighting**
 see Lights
- Lights**
 Activating/deactivating the exterior lighting delayed switch-off 202
 Activating/deactivating the interior lighting delayed switch-off 203
 Automatic headlamp mode 111
 Dipped-beam headlamps 111
 Driving abroad 110
 Foglamps 111
 Hazard warning lamps 114
 Headlamp flasher 114
 Headlamp range 112
 Light switch 110
- Main-beam headlamps 113
 Parking lamps 111
 Rear foglamp 112
 Side lamps 111
 Switching the daytime driving lights on/off (on-board computer) . 202
 Switching the daytime driving lights on/off (switch) 111
 Switching the surround lighting on/off (on-board computer) 202
 Turn signals 113
 see Changing bulbs
 see Interior lighting
- Light sensor (display message)** 217
- LIM indicator lamp**
 Cruise control 163
 Distronic 169
 Variable SPEEDTRONIC 166
- Limiting the speed**
 see SPEEDTRONIC
- Loading guidelines** 246
- Locking**
 see Central locking
- Locking (doors)**
 Automatic 77
 Emergency locking 78
 From inside (central locking button) 77
- Locking centrally**
 see Central locking
- Locking verification signal (on-board computer)** 204
- Luggage compartment cover**
 Extending 258
 Notes/function 256
- Luggage compartment enlargement**
 Completely 251
 Important safety notes 250
 Partial 251
- Luggage compartment floor** 293
- Lumbar support**
 Adjusting (on the seat) 101
- Luxury head restraint** 95

M

M+S tyres	314
Main-beam headlamps	
Changing bulbs	118
Display message	216
Switching on/off	113
Matt finish (cleaning instructions) ..	285
Memory card (audio)	198
Memory function	108
Mercedes-Benz Service Centre	
see Qualified specialist workshop	
Messages	
see Display messages	
Mirror	
see Vanity mirror (in sun visor)	
Mirrors	
see Exterior mirrors	
see Rear-view mirror	
Mobile phone	
Frequencies	337
Installation	337
Menu (on-board computer)	208
Notes/placing in the bracket	265
Transmission output (maximum)	337
Modifying the programming (key)	71
MOExtended tyres	295
MP3	
see Separate operating instructions	
Multifunction display	196
Multifunction steering wheel	
Operating the on-board computer .	195
Overview	33

N

Navigation	
Menu (on-board computer)	199
see separate operating instructions	
NECK-PRO head restraints	
Operation	46
Resetting after being triggered	46
NECK-PRO luxury head restraints	
Operation	46
Resetting after being triggered	47
Notes on running in a new vehicle ..	144

O

Occupant safety	
Children in the vehicle	51
Important safety notes	40
Odometer	197
see Total distance recorder	
see Trip meter	
Off-road system	
4MATIC	176
Oil	
see Engine oil	
On-board computer	
Additional functions menu	207
AIRMATIC/compass menu	199
Audio menu	198
Convenience submenu	206
Displaying a service message	282
Displaying the coolant tempera- ture	197
Displaying the outside tempera- ture	197
Display messages	210
Distronic menu	171
Factory settings	200
Heating submenu	205
Important safety notes	194
Menu overview	196
Message memory menu	210
Navigation menu	199
Operating the TV	198
Operating video DVD	199
Operation	195
Selecting the language	201
Settings menu	200
Setting the display when the igni- tion is switched off	203
Standard display	197
Status bar	201
Telephone menu	208
Trip computer menu	207
Vehicle submenu	203
Opening and closing the side trim panels	119
Operating system	
see On-board computer	
Outside temperature	
Calling up (on-board computer)	197

Outside temperature display	195	Petrol	340
Overhead control panel	36	Plastic trim (cleaning instructions) .	288
Override feature		Power windows	
Rear side windows	61	see Side windows	
P			
Paint code	338	PRE-SAFE® (preventive occupant safety system)	
Paintwork (cleaning instructions) ...	285	Display message	214
Panic alarm	40	Operation	45
Panorama sliding sunroof		Product information	21
Important safety information	85	Program selector button	153
Opening/closing	87	Protection of the environment	
Opening/closing the roller sun-blind	88	General notes	21
Problem (malfunction)	89	Pulling away (automatic transmission)	147
Rain closing feature	87		
Resetting	88	Q	
Parking	158	Qualified specialist workshop	23
Important safety notes	158	R	
Parking brake	159	Radar sensor system	
Position of exterior mirror, front-passenger side	107	Activating/deactivating	204
Reversing camera	180	Country overview	349
see PARKTRONIC		Display message	222
Parking aid		Radiator cover	279
see Exterior mirrors		Radio	
see PARKTRONIC		Selecting a station	198
Parking brake		see separate operating instructions	
Display message	214	Radio-controlled devices (fitting)	274
Notes/function	159	Rain closing feature	
Warning lamp	240	Panorama sliding sunroof	87
Parking lamps		Sliding sunroof	86
Changing bulbs	118	Reading lamp	114
Display message	216	Rear bench seat	
Switching on/off	111	Folding the bench seat forwards/back	250
Parking lamps (changing bulbs)	118	Rear compartment	
PARKTRONIC		Activating/deactivating the air conditioning	128
Deactivating/activating	179	Exit/entry position (3rd row of seats)	99
Driving system	177	Setting the air vents	140
Function/notes	177	Setting the temperature	131
Important safety notes	177	Rear foglamp	
Problem (fault)	180	Display message	216
Sensor range	177	Switching on/off	112
Trailer towing	179		
Warning display	178		
PASSENGER AIRBAG OFF warning lamp	52		

- Rear lamps**
 - see Lights
 - Rear seat**
 - Adjusting 98
 - Rear-view mirror**
 - Anti-dazzle mode (automatic) 107
 - Dipping (manual) 105
 - Rear window heating**
 - Problem (fault) 133
 - Switching on/off 133
 - Rear window wiper**
 - Replacing the wiper blade 122
 - Switching on/off 121
 - Refuelling**
 - Fuel gauge 30
 - Important safety notes 155
 - Refuelling process 156
 - see Fuel
 - Remote control**
 - Auxiliary heating/ventilation 136
 - Changing the batteries (auxiliary heating) 137
 - Programming (garage door opener) 267
 - Replacing the battery (auxiliary heating remote control) 137**
 - Reserve (fuel tank)**
 - see Fuel
 - Reserve fuel**
 - Display message 219
 - Warning lamp 241
 - Reset button 30**
 - Residual heat (climate control) 134**
 - Restraint system**
 - see SRS (Supplemental Restraint System)
 - Rev counter 194**
 - Reversing camera**
 - Function/notes 180
 - Reversing lamp**
 - Changing bulbs 119
 - Reversing lamps**
 - Display message 217
 - Roller sunblind**
 - Panorama sliding sunroof 87
 - Roof carrier 259**
 - Roof lining and carpets (cleaning instructions) 289**
 - Roof load (maximum) 346**
 - Route (navigation)**
 - see Route guidance (navigation)
 - Route guidance (navigation) 199**
- S**
- Safety**
 - Children in the vehicle 51
 - Child restraint systems 51
 - Safety net**
 - Attaching 259
 - Important safety information 258
 - Safety system**
 - see Driving safety system
 - Seat**
 - Folding down the 2nd row of seats 251
 - Folding down the 3rd row of seats 253
 - Resetting the 2nd row of seats 254
 - Resetting the 3rd row of seats 254
 - Seat belt**
 - Adjusting the driver's and front-passenger seat belt 49
 - Adjusting the height 49
 - Belt force limiter 50
 - Belt tensioner 50
 - Cleaning 289
 - Fastening 48
 - Important safety guidelines 47
 - Releasing 49
 - Switching belt adjustment on/off (on-board computer) 206
 - Warning lamp 233
 - Warning lamp (function) 50
 - Seats**
 - Adjusting (electrically) 94
 - Adjusting (manually and electrically) 94
 - Adjusting the head restraint 95
 - Cleaning the cover 289
 - Correct driver's seat position 92
 - Entry position (3rd row of seats) 100
 - Exit position (3rd row of seats) 100
 - Folding the 2nd row of seats forward manually 99

- Folding the rear bench seat forwards/back 250
- Important safety notes 93
- Overview 93
- Seat heating problem 102
- Seat ventilation problem 103
- Storing settings (memory function) 108
- Switching seat heating on/off 102
- Switching the seat ventilation on/off 103
- Securing hooks** 256
- Selector lever**
 - Cleaning 289
- Sensors (cleaning instructions)** 287
- Service**
 - see ASSYST PLUS
- Service Centre**
 - see Qualified specialist workshop
- Service products**
 - AdBlue® special additives 342
 - Brake fluid 344
 - Coolant (engine) 345
 - Engine oil 343
 - Fuel 339
 - Important safety notes 339
 - Washer fluid 345
- Settings**
 - Factory (on-board computer) 200
 - On-board computer 200
- Setting the air distribution** 131
- Setting the airflow** 132
- Short journeys (diesel particle filter)** 160
- Sidebag** 44
- Side windows**
 - Convenience closing 83
 - Convenience opening 83
 - Hinged side windows 82
 - Important safety notes 81
 - Opening/closing 82
 - Overview 81
 - Problem (malfunction) 85
 - resetting 84
- Sliding sunroof**
 - Important safety information 85
 - Opening/closing 86
 - Problem (malfunction) 89
 - Rain closing feature 86
 - Resetting 86
 - see Panorama sliding sunroof
- Snow chains**
 - Information 315
- Socket**
 - 2nd row of seats 265
 - Centre console 265
 - Luggage compartment 265
- Sockets**
 - General notes 264
- Spare wheel**
 - Storage location 329
 - Storing 331
 - see Emergency spare wheel
- Specialist workshop** 23
- Speed, controlling**
 - see Cruise control
- Speedometer**
 - Digital speedometer (on-board computer) 197
 - In the Instrument cluster 30
 - Segments 195
 - Selecting the unit of measurement 200
 - see Instrument cluster
- SPEEDTRONIC**
 - Activating variable 166
 - Deactivating variable 167
 - Display message 223
 - Function/notes 165
 - Important safety notes 165
 - LIM indicator lamp 166
 - Permanent 167
 - Selecting 166
 - Storing the current speed 166
 - Variable 166
- SRS (Supplemental Restraint System)**
 - Display message 214
 - Introduction 41
 - Warning lamp 240
 - Warning lamp (function) 41
- Starting (engine)** 146
- Steering (display message)** 230

- Steering wheel**
- Adjusting (electrically) 104
 - Adjusting (manually) 103
 - Button overview 33
 - Buttons (on-board computer) 195
 - Cleaning 289
 - Gearshift paddles 153
 - Important safety notes 103
 - Steering wheel heating 104
 - Storing settings (memory function) 108
- Steering wheel gearshift paddles** 153
- Steering wheel heating**
- Problem (malfunction) 104
 - Switching on/off 104
- Storage areas** 246
- Storage compartments**
- 3rd row of seats 249
 - Armrest (under) 247
 - Centre air vents (2nd row of seats) 248
 - Centre console 248
 - Centre console (2nd row of seats) . 248
 - Cup holder 260
 - Glove compartment 247
 - Important safety information 246
- Stowage net** 249
- Stowage space**
- Stowage net 249
- Summer tyres** 314
- Sun blind**
- Rear side windows 263
- Sun visor** 262
- Supplement Restraint System**
- see SRS (Supplemental Restraint System)
- Surround lighting (on-board computer)** 202
- Switching off the alarm (ATA)** 66
- T**
- Tailgate**
- Display message 230
 - Important safety notes 78
 - Limiting the opening angle 81
 - Opening/closing (automatically from inside) 80
 - Opening/closing (automatically from outside) 79
 - Opening/closing (from outside) 79
 - Opening dimensions 346
- Tail lamps**
- Display message 217
 - see Lights
- Tank**
- see Fuel tank
- Technical data**
- Capacities 339
 - Emergency spare wheel 333
 - Information 336
 - Trailer loads 349
 - Tyres/wheels 325
 - Vehicle data 346
- Telephone**
- Accepting a call 209
 - Display message 231
 - Menu (on-board computer) 208
 - Number from the phone book 209
 - Redialling 209
 - Rejecting/ending a call 209
- Temperature**
- Coolant (on-board computer) 197
 - Displaying the outside temperature 197
 - Outside temperature 195
 - Setting (climate control) 131
- TEMPOMAT**
- Function/notes 163
- Theft-deterrent system**
- ATA (Anti-Theft Alarm system) 66
 - Immobiliser 66
- TIREFIT kit** 296
- Top Tether** 55
- Total distance recorder** 197
- Tow-away protection**
- Notes 67
 - Switching on/off (on-board computer) 207
- Towing**
- Important safety notes 306
 - With the rear axle raised 307

- Towing a trailer**
 Axle load, permissible 349
 ESP® (Electronic Stability Program) 64
- Towing away**
 Fitting the towing eye 307
 Removing the towing eye 307
 With both axles on the ground 307
- Tow-starting**
 Emergency engine starting 309
 Important safety notes 306
- Trailer coupling**
 see Towing a trailer
- Trailer towing**
 7-pin connector 190
 Blind Spot Assist 184
 Cleaning the trailer tow hitch 287
 Coupling up a trailer 188
 Decoupling a trailer 189
 Driving tips 184
 Fitting the ball coupling 186
 Important safety notes 184
 Lights display message 215
 Mounting dimensions 347
 Parktronic 179
 Power supply 190
 Problem (fault) 191
 Removing the ball coupling 189
 Shift range 152
 Storing the ball coupling 190
 Trailer loads 349
- Transmission**
 see Automatic transmission
- Transporting the vehicle** 308
- Trim pieces (cleaning instructions)** . 289
- Trip computer (on-board computer)** 207
- Trip meter**
 Calling up 197
 Resetting (on-board computer) 208
- Turn signal**
 see Turn signals
- Turn signals**
 Changing bulbs (front) 118
 Switching on/off 113
- TV**
 Operating (on-board computer) 198
 see Separate operating instructions
- Two-way radio**
 Frequencies 337
 Installation 337
 Transmission output (maximum) 337
- Type identification plate**
 see Vehicle identification plate
- Tyre pressure**
 Calling up (on-board computer) 318
 Display message 225
 Not reached (TIREFIT) 299
 Reached (TIREFIT) 300
 Recommended 315
- Tyre pressure loss warning**
 Important safety notes 317
 Restarting 317
- Tyre pressure monitor**
 Checking the tyre pressure electronically 318
 Function/notes 318
 Restarting 319
 Warning lamp 243
 Warning message 319
- Tyres**
 Changing a wheel 320
 Checking 313
 Direction of rotation 320
 Display message 225
 Important safety notes 312
 M+S tyres 314
 MOExtended tyres 314
 Replacing 320
 Service life 313
 Storing 320
 Tyre size (data) 325
 Tyre tread 313
 see Flat tyre

U

- Unladen weight** 346
- Unlocking**
 Emergency unlocking 77
 From inside the vehicle (central unlocking button) 77

V

Vanity mirror (in sun visor)	262
Variable SPEEDTRONIC see SPEEDTRONIC	
Vehicle	
Correct use	24
Data acquisition	24
Display message	229
Electronics	337
Equipment	22
Implied warranty	24
Individual settings	200
Leaving parked up	159
Locking (in an emergency)	78
Locking (key)	70
Lowering	325
Pulling away	147
Raising	322
Registration	23
Securing from rolling away	321
Towing away	306
Transporting	308
Unlocking (in an emergency)	77
Unlocking (key)	70
Vehicle data	346
Vehicle battery see Battery (vehicle)	
Vehicle data	346
Vehicle dimensions	346
Vehicle emergency locking	78
Vehicle identification number see VIN	
Vehicle identification plate	338
Vehicle level (display message)	221
Vehicle tool kit	293
Vehicle weights	346
Video Operating the DVD	199
VIN	338

W

Warning and indicator lamps

ABS	235
Brakes	235
Distance warning signal	242
DISTRONIC	242

ESP®	237
ESP® OFF	238
LIM (cruise control)	163
LIM (DISTRONIC)	169
LIM (variable SPEEDTRONIC)	166
Overview	32
PASSENGER AIRBAG OFF	52
Reserve fuel	241
Seat belt	233
SRS	240
Tyre pressure monitor	243

Warning triangle**Washer fluid**

Display message	231
-----------------------	-----

Wheel bolt tightening torque**Wheel chock****Wheels**

Changing/replacing	320
Changing a wheel	320
Checking	313
Cleaning	286
Cleaning (warning)	321
Emergency spare wheel	328
Fitting a new wheel	324
Fitting a wheel	321
Important safety notes	312
Overview	312
Removing a wheel	323
Storing	320
Tightening torque	325
Wheel size/tyre size	325

Windowbag**Windows**

Cleaning	286
see Side windows	

Windscreen

Demisting	132
Infrared reflective	274

Windscreen washer fluid
see Windscreen washer system**Windscreen washer system**

Notes	345
Topping up	281

Windscreen wipers

Problem (malfunction)	122
Rear window wiper	121

Replacing the wiper blades	121
Switching on/off	120
Winter driving	
General notes	314
Winter operation	
Overview	314
Radiator cover	279
Slippery road surfaces	162
Snow chains	315
Winter tyres	
Limiting the speed (on-board computer)	204
M+S tyres	314
Wiper blades	
Cleaning	286
Important safety notes	121
Replacing	121
Replacing (on the rear window)	122
Replacing (windscreen)	121
Wooden trim (cleaning instructions)	289
Workshop	
see Qualified specialist workshop	

Protection of the environment

General notes

Environmental note

Daimler's declared policy is one of comprehensive environmental protection.

The objectives are for the natural resources which form the basis of our existence on this planet to be used sparingly and in a manner which takes the requirements of both nature and humanity into account.

You too can help to protect the environment by operating your vehicle in an environmentally-responsible manner.

Fuel consumption and the rate of engine, transmission, brake and tyre wear depend on the following factors:

- operating conditions of your vehicle
- your personal driving style

You can influence both factors. You should bear the following in mind:

Operating conditions:

- avoid short trips as these increase fuel consumption.
- make sure that the tyre pressures are always correct.
- do not carry any unnecessary weight.
- keep an eye on the vehicle's fuel consumption.
- remove roof racks once you no longer need them.
- a regularly serviced vehicle will contribute to environmental protection. You should therefore adhere to the service intervals.
- always have service work carried out at a qualified specialist workshop.

Personal driving style:

- do not depress the accelerator pedal when starting the engine.
- do not warm up the engine with the vehicle stationary.
- drive carefully and maintain a safe distance from the vehicle in front.

- avoid frequent, sudden acceleration.
- change gear in good time and use each gear only up to $\frac{2}{3}$ of its maximum engine speed.
- switch off the engine in stationary traffic.

Returning an end-of-life vehicle

Mercedes-Benz will take back your Mercedes-Benz to dispose of it in an environmentally responsible manner, in accordance with the European Union (EU) End of Life Vehicles Directive.

The End of Life Vehicles Directive applies to vehicles with a gross vehicle weight of up to 3.5 t, in accordance with national regulations. For several years, Mercedes-Benz has been meeting all the legal requirements for a design which allows for recycling and re-use. There is a network of return points and disassembly plants which can recycle your vehicle in an environmentally-responsible manner. The methods employed in vehicle and parts recycling are constantly being developed and improved. This means that your Mercedes-Benz will also continue to meet even the increased recycling quotas in the future in good time. You can obtain further information from your national Mercedes-Benz homepage or your national hotline number.

Product information

Mercedes-Benz recommends that you use genuine Mercedes-Benz parts, conversion parts and accessories that have been approved for the type of vehicle.

Mercedes-Benz tests genuine parts and conversion parts and accessories that have been specifically approved for your vehicle for their reliability, safety and suitability. Despite ongoing market research, Mercedes-Benz is unable to assess other parts. Therefore, Mercedes-Benz accepts no responsibility for the use of such parts in Mercedes-Benz vehi-

cles. This is also the case, even if they have been independently or officially approved. The use of non-approved parts could affect your vehicle's operating safety.

Mercedes-Benz therefore recommends that you use genuine Mercedes-Benz parts, conversion parts and accessories that have been approved for the type of vehicle.

Genuine Mercedes-Benz parts, approved conversion parts and accessories are available from a Mercedes-Benz Service Centre. Here, you will receive advice about permissible technical modifications, and the parts will be professionally fitted.

Owner's Manual

General notes

Before you first drive off, read this Owner's Manual carefully and familiarise yourself with your vehicle.

For your own safety and a longer vehicle life, follow the instructions and warning notices in this manual. Disregarding them may lead to damage to the vehicle or personal injury.

Vehicle equipment

This Owner's Manual describes all models and all standard and optional equipment available for your vehicle at the time of publication of the Owner's Manual. Country-specific differences are possible. Note that your vehicle may not be fitted with all features described. This is also the case for systems and functions relevant to safety. Therefore, the equipment on your vehicle may differ from that in the descriptions and illustrations.

The original purchase contract documentation for your vehicle contains a list of all of the systems in your vehicle.

Should you have any questions concerning equipment and operation, please consult a Mercedes-Benz Service Centre.

The Owner's Manual and Service Booklet are important documents and should be kept in the vehicle.

Operating safety

Important safety notes

WARNING

All work on the vehicle and, in particular, work relevant to safety or on safety-related systems must be carried out at a qualified specialist workshop.

WARNING

Some safety systems only function when the engine is running. You should therefore never switch off the engine when driving. Otherwise, the safety systems of your vehicle may not function correctly and as a result will no longer protect you and other persons as intended. In addition, there is a risk that you may lose control of your vehicle and thus cause an accident.

WARNING

Work carried out incorrectly, or alterations made to the vehicle, e.g. re-routing of cables under coverings, could cause the safety systems of your vehicle to stop working properly. The safety systems would thus no longer protect you and other persons as intended. In addition, there is a risk that you may lose control of your vehicle and thus cause an accident.

All work and alterations to the vehicle, e.g. installations or modifications, should therefore be carried out at a qualified specialist workshop.

WARNING

If work on electronic equipment and its software is carried out incorrectly, this equipment could stop working. The electronic systems are networked via interfaces. Tampering with these electronic systems could cause mal-

functions in systems which have not been modified. Malfunctions such as these can seriously jeopardise the vehicle's operating safety and therefore your own safety.

You should therefore have all work and modifications to electronic components carried out at a qualified specialist workshop.

Declarations of conformity

Wireless vehicle components

The following information applies to all components of the vehicle and the COMAND system which receive and/or transmit radio waves:

The components of this vehicle which receive and/or transmit radio waves are compliant with the basic requirements and other relevant provisions of Directive 1999/5/EC. You can obtain further information from any Mercedes-Benz Service Centre.

Electromagnetic compatibility

The electromagnetic compatibility of the vehicle components has been checked and certified according to the currently valid version of Directive 72/245/EEC or the equivalent ECE Regulation ECE-R 10.

Diagnostics connection

WARNING

If you connect equipment to a diagnostics connection, it can affect the operation of the vehicle systems. This could compromise the operating safety of your vehicle while driving. There is a risk of an accident.

Do not connect any equipment to a diagnostics connection.

WARNING

Loose equipment or cables hanging from a device which are connected to a diagnostic connection could impede pedal clearance.

The equipment or cables could get caught between the pedals when driving and braking suddenly. This could impair the function of the pedals. There is a risk of accident.

Do not attach any equipment or cables in the driver's footwell.

! If the engine is switched off and equipment on the diagnostics connection is used, the starter battery may discharge.

The diagnostics connection is only intended for the connection of diagnostic equipment at a qualified specialist workshop.

Connecting equipment to the diagnostics connection can lead to emissions monitoring information being reset, for example. This may lead to the vehicle failing to meet the requirements of the next emissions test during the main inspection.

Qualified specialist workshop

A qualified specialist workshop has the necessary special skills, tools and qualifications to correctly carry out any necessary work on your vehicle. This particularly applies to work relevant to safety.

Observe the notes in the Service Booklet.

Always have the following work carried out at a qualified specialist workshop:

- work relevant to safety
- service and maintenance work
- repair work
- modifications, installations and conversions
- work on electronic components

Mercedes-Benz recommends that you use a Mercedes-Benz Service Centre.

Vehicle registration

Mercedes-Benz may ask its Service Centres to carry out technical inspections on certain

vehicles. The quality or safety of the vehicle is improved as a result of the inspection. Mercedes-Benz can only inform you about vehicle checks if it has your registration data. It is possible that your vehicle has not yet been registered in your name in the following cases:

- if your vehicle was not purchased at an authorised specialist dealer.
- if your vehicle has not yet been examined at a Mercedes-Benz Service Centre.

It is advisable to register your vehicle with a Mercedes-Benz Service Centre.

Inform Mercedes-Benz as soon as possible about any change in address or vehicle ownership.

Correct use

WARNING

Various warning stickers are affixed to your vehicle. Their purpose is to draw your attention, and the attention of others, to various dangers. Therefore, do not remove any warning stickers unless the sticker clearly states that you may do so.

If you remove the warning stickers, you or others could be injured by failing to recognise certain dangers.

Observe the following information when driving your vehicle:

- the safety notes in this manual
- the Technical Data section in this manual
- traffic rules and regulations
- laws and safety standards pertaining to motor vehicles

Implied warranty

! Follow the instructions in this manual about the proper operation of your vehicle as well as about possible vehicle damage. Damage to your vehicle that arises from

culpable contraventions against these instructions are not covered either by Mercedes-Benz implied warranty or by the New or Used-Vehicle Warranty.

Data stored in the vehicle

Fault data

Components which are critical for vehicle operation are equipped with fault data memories as standard. There are also data storage devices which record how vehicle components have reacted in certain driving situations (e.g. airbag deployment or ESP® intervention).

This data is used exclusively to:

- assist in the rectification of faults and defects
- help Mercedes-Benz optimise and develop vehicle functions

The data cannot be used to trace the vehicle's movements.

When your vehicle is serviced by Mercedes-Benz, this technical information can be read out from the fault memory. This is performed by authorised employees of the Mercedes-Benz service network using special diagnostic computers.

After a fault has been rectified, the information is deleted from the memory. Other memory data is constantly overwritten.

Other devices that store data

Depending on the equipment level, your vehicle may feature communications and/or entertainment systems (e.g. navigation devices, telephone systems). These allow you to save and edit data required for the operation of the respective device.

Further information on operation (e.g. on deleting data) can be found in the separate operating instructions.

Copyright information

FreeType

Portions of this software are copyright © 2005 The FreeType Project (www.freetype.org). All rights reserved. © 1996-2000 by David Turner, Robert Wilhelm, and Werner Lemberg.

Gnu compiler

Copyright © 1982, 1986 Regents of the University of California. All rights reserved.

The Berkeley software License Agreement specifies the terms and conditions for redistribution. Redistribution and use in source and binary forms, with or without modification, are permitted provided that the following conditions are met:

1. Redistribution of source code must retain the above copyright notice, this list of conditions and the following disclaimer.
2. Redistribution in binary form must reproduce the above copyright notice, this list of conditions and the following disclaimer in the documentation and/or other materials provided with the distribution.
3. All advertising materials mentioning features or use of this software must display the following acknowledgement: This product includes software developed by the University of California, Berkeley and its contributors.
4. Neither the name of the University nor the names of its contributors may be used to endorse or promote products derived from this software without specific prior written permission.

THIS SOFTWARE IS PROVIDED BY THE REGENTS AND CONTRIBUTORS "AS IS" AND ANY EXPRESS OR IMPLIED WARRANTIES, INCLUDING, BUT NOT LIMITED TO, THE IMPLIED WARRANTIES OF MERCHANTABILITY AND FITNESS FOR A PARTICULAR PURPOSE ARE DISCLAIMED. IN NO EVENT SHALL THE REGENTS OR CONTRIBUTORS BE LIABLE

FOR ANY DIRECT, INDIRECT, INCIDENTAL, SPECIAL, EXEMPLARY, OR CONSEQUENTIAL DAMAGES (INCLUDING, BUT NOT LIMITED TO, PROCUREMENT OF SUBSTITUTE GOODS OR SERVICES; LOSS OF USE, DATA, OR PROFITS; OR BUSINESS INTERRUPTION) HOWEVER CAUSED AND ON ANY THEORY OF LIABILITY, WHETHER IN CONTRACT, STRICT LIABILITY, OR TORT (INCLUDING NEGLIGENCE OR OTHERWISE) ARISING IN ANY WAY OUT OF THE USE OF THIS SOFTWARE, EVEN IF ADVISED OF THE POSSIBILITY OF SUCH DAMAGE.

Cockpit	28
Instrument cluster	30
Multifunction steering wheel	33
Centre console	34
Overhead control panel	36
Door control panel	37

Cockpit

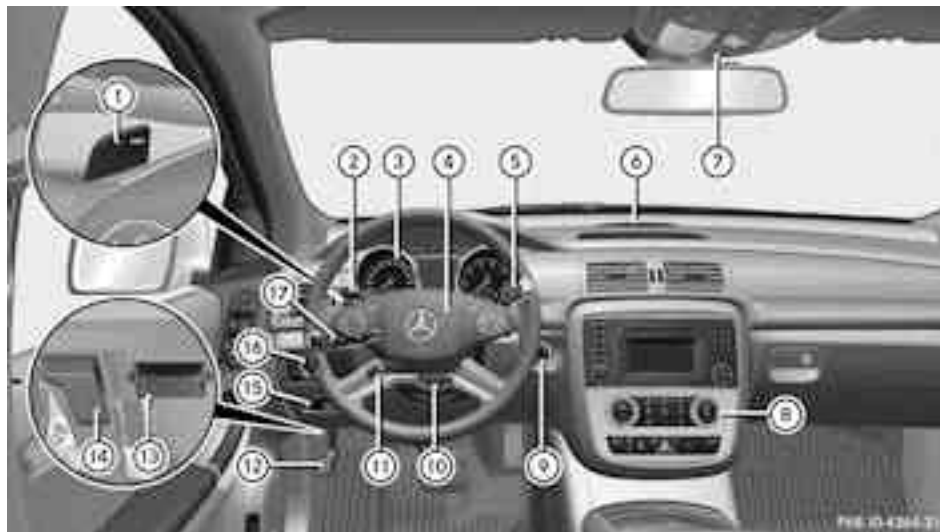

	Function	Page
①	Steering wheel gearshift paddles	153
②	Cruise control lever	163
③	Instrument cluster	30
④	Horn	
⑤	DIRECT SELECT lever	150
⑥	PARKTRONIC warning display	177
⑦	Overhead control panel	36
⑧	Climate control systems	124
⑨	Ignition lock	145
	Start/Stop button	145

	Function	Page
⑩	Adjusting the steering wheel manually	103
⑪	Adjusting the steering wheel electrically	103
	Steering wheel heating	104
⑫	Parking brake	159
⑬	Diagnostics connection	23
⑭	Opening the bonnet	278
⑮	Releasing the parking brake	159
⑯	Light switch	110
⑰	Combination switch	113

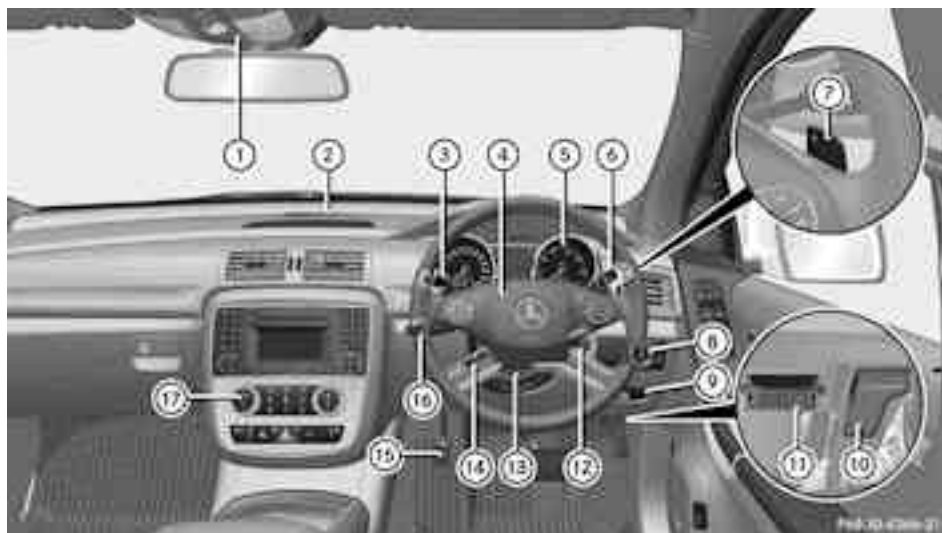

	Function	Page
①	Overhead control panel	36
②	PARKTRONIC warning display	177
③	Cruise control lever	163
④	Horn	
⑤	Instrument cluster	30
⑥	DIRECT SELECT lever	150
⑦	Steering wheel gearshift paddles	153
⑧	Light switch	110
⑨	Releasing the parking brake	159
⑩	Opening the bonnet	278

	Function	Page
⑪	Diagnostics connection	23
⑫	Ignition lock	145
	Start/Stop button	145
⑬	Adjusting the steering wheel manually	103
⑭	Adjusting the steering wheel electrically	103
	Steering wheel heating	104
⑮	Parking brake	159
⑯	Combination switch	113
⑰	Climate control systems	124

Instrument cluster

Displays and controls



i Instrument cluster: kilometres

	Function	Page
①	Speedometer with segments	195
②	Unit of measurement for the speedometer	200
③	To adjust the instrument cluster lighting: dimmer	194
④	Reset button	

	Function	Page
⑤	To adjust the instrument cluster lighting: brighter	194
⑥	Rev counter	194
⑦	Fuel gauge	
⑧	Multifunction display	196
⑨	Time	201



i Instrument cluster: miles

	Function	Page
①	Speedometer with segments	195
②	Unit of measurement for the speedometer	200
③	To adjust the instrument cluster lighting: dimmer	194
④	Reset button	

	Function	Page
⑤	To adjust the instrument cluster lighting: brighter	194
⑥	Rev counter	194
⑦	Fuel gauge	
⑧	Multifunction display	196
⑨	Time	201

Warning and indicator lamps









	Function	Page
①	ABS	235
②	LIM	165
③	ESP®	237
④	Distance warning On vehicles without DIS-TRONIC, the lamp lights up briefly but has no function.	242
⑤	Brakes	235
⑥	Tyre pressure monitor	243
⑦	Turn signals	113
⑧	ESP® OFF	237

	Function	Page
⑨	Seat belt	233
⑩	Diesel engine: pre-glow	146
⑪	SRS	240
⑫	Dipped-beam headlamps	111
⑬	Engine diagnostics	241
⑭	Main-beam headlamp	113
⑮	Reserve fuel	241

Multifunction steering wheel







At a glance





	Function	Page		Function	Page
①	Multifunction display	196			
②	Audio system/COMAND APS; see the separate operating instructions			Switches on LINGUA-TRONIC; see the separate operating instructions	
③	 Rejecting or ending a call Exits telephone book/redial memory  Makes or accepts a call Switches to the redial memory  Selects submenus in the Settings menu Changes values Adjusts the volume	208 200	④	 Selects a menu: scrolls backward and forward  Switches off LINGUA-TRONIC; see the separate operating instructions  Scrolls backward and forward within a menu	196 196

Centre console

Centre console, upper section



	Function	Page
①	Audio system/COMAND APS; see the separate operating instructions	
②	 Seat heating	102
③	 Seat ventilation	103
④	 Auxiliary heating	135
⑤	 Level control	174
⑥	Selects the drive program	153
⑦	 PASSENGER AIRBAG OFF indicator lamp	52

	Function	Page
⑧	 Hazard warning lamps	114
⑨	ATA indicator lamp	66
⑩	 PARKTRONIC	177
⑪	 ESP®	63
⑫	 Adaptive Damping System	174

Centre console, lower section









	Function	Page
⑬	Stowage compartment	246
⑭	Stowage tray	246
⑮	Stowage compartment	246
⑯	Cup holders	260

	Function	Page
⑰	Stowage compartment	246
	Ashtray	263
	Cigarette lighter	264

Overhead control panel









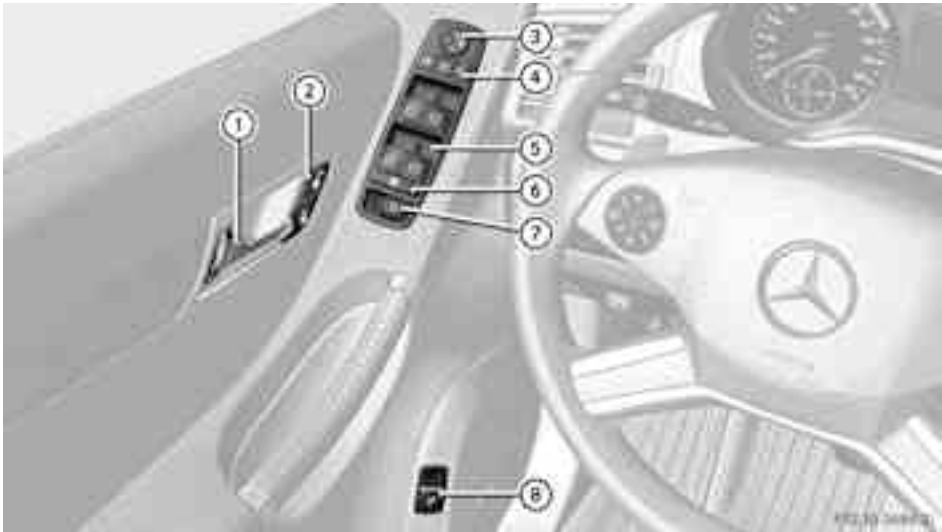



	Function	Page
①	 Switches the left-hand reading lamp on/off	114
②	 Switches the rear interior lighting on/off	115
③	 Switches the automatic interior lighting control on/off	115
④	 Switches the front interior lighting on/off	115
⑤	 Switches the right-hand reading lamp on/off	114

	Function	Page
⑥	 Opens/closes the sliding sunroof  Opens/closes the panorama sliding sunroof with roller sunblinds	86 87
⑦	Rear-view mirror	105
⑧	Buttons for the garage door opener	267

Door control panel



	Function	Page
①	Opens the door	76
②	  Unlocks/locks the vehicle	77
③	 Adjusts the exterior mirrors	105
④	   Selects the exterior mirror, electrically folds the exterior mirrors in/out	105
⑤	 Opens/closes the side windows	82

	Function	Page
⑥	 Activates/deactivates the override feature for the side windows in the rear compartment	61
⑦	 Opens/closes the hinged power side windows	82
⑧	 Opens/closes the tailgate	80

Useful information	40
Panic alarm	40
Occupant safety	40
Children in the vehicle	51
Driving safety systems	61
Anti-theft systems	66

Useful information

- i** This Owner's Manual describes all models, series and optional equipment for your vehicle that were available at the time of going to press. National variations are possible. Note that your vehicle may not be equipped with all of the functions described. This is also the case for systems and functions relevant to safety.
- i** Read the information on qualified specialist workshops: (▷ page 23).

Panic alarm



- ▶ **To activate:** press **PANIC** button ① for at least one second.
An alarm sounds and the exterior lighting flashes.
 - ▶ **To deactivate:** press **PANIC** button ① again.
- or
- ▶ Insert the key into the ignition lock.
- or
- ▶ Press the KEYLESS-GO Start/Stop button.
The KEYLESS-GO key must be in the vehicle.
- i** The panic alarm function is only available in Mexico.

Occupant safety

Important safety notes

⚠ WARNING

If service work is not carried out correctly, the operating safety of your vehicle may be affected. This could cause you to lose control of your vehicle and cause an accident. Moreover, the safety systems may no longer be able to protect you or others as they are designed to do.

Always have service work carried out at a qualified specialist workshop.

⚠ WARNING

Modifications to or work performed incorrectly on the following parts can result in the restraint systems not functioning as intended:

- the restraint system, consisting of seat belts and their anchorage points, belt tensioners, belt force limiters and airbags
- the wiring
- networked electronic systems

Airbags and belt tensioners could fail to deploy or be triggered in an accident despite the deceleration force being sufficient to trigger the systems, or could be triggered unintentionally. For this reason, never make any modifications to the restraint systems.

Therefore, you must not tamper with electronic components or their software.

The seat belts, together with SRS (Supplemental Restraint System), are complementary, co-ordinated restraint systems (▷ page 41). They reduce the risk of injury in specific, pre-defined types of accident situations and thereby increase occupant safety. However, seat belts and airbags generally do not protect against objects penetrating the vehicle from the outside.

To ensure that the restraint systems can deliver their full potential protection, make sure that:

- the seat and head restraint are adjusted properly (▷ page 92).
- the seat belt has been fastened properly (▷ page 48).
- the airbags can inflate unrestricted if deployed (▷ page 42).
- the steering wheel is adjusted properly (▷ page 92).
- the restraint systems have not been modified.

An airbag increases the protection of vehicle occupants wearing a seat belt. However, airbags are only an additional restraint system which complements, but does not replace, the seat belt. All vehicle occupants must wear their seat belt correctly at all times, even if the vehicle is equipped with airbags. The airbags are not deployed in all types of accidents. For example, if the protective capacity of correctly fastened seat belts is not increased by deploying the airbags, the airbags will not deploy.

Airbag deployment only provides increased protection if the seat belt is worn correctly. First, the seat belt helps to keep the vehicle occupant in the best position in relation to the airbag. Second, in a head-on collision, for example, the seat belt prevents the vehicle occupant from being propelled towards the point of impact.

SRS (Supplemental Restraint System)

Introduction

SRS consists of:

- the **SRS** SRS warning lamp
- airbags
- the airbag control unit with crash sensors
- belt tensioners
- belt force limiters

SRS reduces the risk of occupants coming into contact with the vehicle's interior in the event of an accident. It can also reduce the forces to which occupants are subjected during an accident.

SRS warning lamp

WARNING

If SRS is malfunctioning, individual systems may be triggered unintentionally or might not be triggered at all in the event of an accident with a high rate of vehicle deceleration.

A malfunction has occurred if:

- the **SRS** SRS warning lamp does not light up when the ignition is switched on.
- the engine is running and the **SRS** SRS warning lamp does not go out after a few seconds.
- the engine is running and the **SRS** SRS warning lamp lights up again.

In this case, have SRS checked immediately at a qualified specialist workshop.

SRS functions are checked regularly when you switch on the ignition and when the engine is running. Therefore, malfunctions can be detected in good time.

The **SRS** SRS warning lamp in the instrument cluster lights up when the ignition is switched on. It goes out no later than a few seconds after the engine is started.

Triggering of belt tensioners, belt force limiters and airbags

During the first stage of a collision, the airbag control unit evaluates important physical data relating to vehicle deceleration or acceleration, such as:

- duration
- direction
- magnitude

Based on the evaluation of this data, the airbag control unit pre-emptively triggers the belt tensioners in the first stage.

If there is an even higher rate of vehicle deceleration or acceleration in a longitudinal direction, the front airbags are also deployed.

Your vehicle has adaptive, two-stage front airbags. The airbag control unit evaluates vehicle deceleration or acceleration in the event of a collision. In the first deployment stage, the front airbag is filled with enough propellant gas to reduce the risk of injuries. The front airbag is fully deployed if a second deployment threshold is reached within a few milliseconds.

The belt tensioner and airbag triggering thresholds are variable and are adapted to the rate of deceleration or acceleration of the vehicle. This process is pre-emptive in nature. The triggering process must take place in good time at the start of the collision.

The rate of vehicle deceleration or acceleration and the direction of the force are essentially determined by:

- the distribution of forces during the collision
- the collision angle
- the deformation characteristics of the vehicle
- the characteristics of the object with which the vehicle has collided

Factors which can only be seen and measured after a collision has occurred do not play a decisive role in the deployment of an airbag, nor do they provide an indication of airbag deployment.

The vehicle may be deformed significantly, e.g. the bonnet or the wing, without an airbag being deployed. This is the case if only parts which are relatively easily deformed are affected and the rate of deceleration is not high. Conversely, airbags may be deployed even though the vehicle suffers only minor deformation. This is the case if, for example, very rigid vehicle parts such as longitudinal body members are hit, and sufficient deceleration occurs as a result.

i The front belt tensioners can only be triggered if the seat belt tongues on the front seats are correctly engaged in the seat belt buckles.

i Not all airbags are deployed in an accident. The different airbag systems work independently of each other.

How the airbag system works is determined by the severity of the accident detected, especially the vehicle deceleration or acceleration, and the apparent type of accident:

- head-on collision
- side impact
- overturn

Airbags

Important safety notes

WARNING

Airbags provide additional protection; they are not, however, a substitute for seat belts.

Observe the following notes to reduce the risk of serious or even fatal injury caused by airbag deployment:

- all vehicle occupants – in particular, pregnant women – must wear their seat belt correctly at all times and lean back against the backrest, which should be positioned as close to the vertical as possible. The head restraint must support the back of the head at about eye level.
- always secure children less than 1.50 m tall or under 12 years of age in suitable child restraint systems.
- all vehicle occupants must select a seat position that is as far away from the airbag as possible. The driver's seat position must allow the vehicle to be driven safely. The driver's chest should be as far away from the centre of the driver's airbag cover as possible.

- move the front-passenger seat as far back as possible. This is especially important if you have secured a child in a child restraint system on the front-passenger seat.
- vehicle occupants – in particular, children – must not lean their heads into the area of the window in which the sidebag/window-bag is deployed.
- rearward-facing child restraint systems must not be fitted to the front-passenger seat unless the front-passenger airbag has been disabled. On the front-passenger seat, the front-passenger airbag is disabled if a child restraint system with a transponder for automatic child seat recognition is fitted to the front-passenger seat in a vehicle equipped with automatic child seat recognition. The  PASSENGER AIRBAG OFF indicator lamp must be continuously lit.

If the front-passenger seat of your vehicle does not have automatic child seat recognition, or your rearward-facing child restraint system does not have a transponder for automatic child seat recognition, children must be secured in a child restraint system on a suitable seat in the rear. If you secure a forward-facing child restraint system to the front-passenger seat, you must move the front-passenger seat as far back as possible.

- make sure there are no heavy or sharp-edged objects in the pockets of clothing.
- do not lean forwards, e.g. over the cover of the driver's/front-passenger front airbag, particularly when the vehicle is in motion.
- do not put your feet on the dashboard.
- only hold the steering wheel on the outside. This allows the airbag to be fully deployed. You could be injured if the airbag is deployed and you are holding the inside of the steering wheel.
- do not lean on the doors from inside the vehicle.

- make sure that there are no people, animals or objects between the vehicle occupants and the area where the airbags are deployed.
- do not place any objects between the seat backrest and the door.
- do not hang any hard objects, e.g. coat hangers, on the grab handles or coat hooks.
- do not attach accessories, e.g. cup holders, to the doors.

It is not possible to rule out a risk of injury being caused by an airbag, due to the high speed at which the airbag must be deployed.

WARNING

Airbag functionality can only be assured if the following parts are not covered and no badges or stickers are attached to them:

- padded steering wheel boss
- front-passenger airbag cover
- outer side of seat bolsters

WARNING

When an airbag deploys, a small amount of powder is released. The powder may cause short-term breathing difficulties to persons suffering from asthma or other pulmonary conditions.

In order to prevent potential breathing difficulties, you should leave the vehicle as soon as it is safe to do so. You can also open the window to allow fresh air to enter the vehicle interior. The powder does not constitute a health hazard and does not indicate that there is a fire in the vehicle.

WARNING

The airbag parts are hot after the airbag has been deployed. Do not touch them as you could burn yourself.

Have the airbags replaced at a qualified specialist workshop. Otherwise, occupants are not protected by the airbags in the event of another accident.

Airbag deployment slows down and restricts the movement of the vehicle occupant.

If the airbags are deployed, you will hear a bang and a small amount of powder may also be released. Only in rare cases will the bang affect your hearing. The powder that is released generally does not constitute a health hazard. The  SRS warning lamp lights up.

The airbag installation locations are identified by the AIRBAG symbol.

Front airbags

! Do not place heavy objects on the front-passenger seat. The system may then detect that the seat is occupied and if there is an accident, the restraint systems on the front-passenger side could be deployed. Have restraint systems that have been triggered replaced.

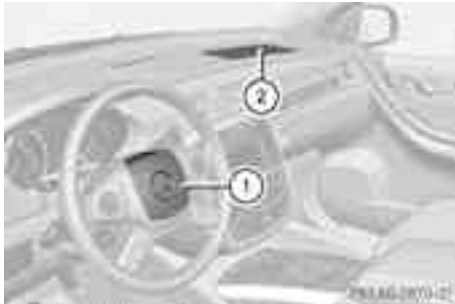

Driver's airbag ① deploys in front of the steering wheel; front-passenger front airbag ② deploys in front of and above the glove compartment.

The front airbags increase protection for the driver's and front-passenger's head and chest.

They are deployed:

- at the start of an accident with a high rate of vehicle acceleration or deceleration in a longitudinal direction
- if the system determines that airbag deployment can offer additional protection to that provided by the seat belt

- depending on whether the seat belt is being used
- independently of other airbags in the vehicle

If the vehicle overturns, the front airbags are generally not deployed. The front airbags are deployed if the system detects high vehicle deceleration in a longitudinal direction.

Front-passenger airbag ② is only activated if the system determines that the front-passenger seat is occupied. The  PASSENGER AIRBAG OFF indicator lamp is not lit (> page 52). This means that a child restraint system without automatic child seat recognition has been fitted to the front-passenger seat, or that a child restraint system with automatic child seat recognition has been fitted incorrectly.

Sidebags

WARNING

If you wish to use seat covers, Mercedes-Benz recommends that, for safety reasons, you only use seat covers that have been approved for Mercedes-Benz vehicles.

The seat covers must have a special tear seam for sidebags. Otherwise, the sidebags cannot deploy correctly and would fail to provide the intended protection in the event of an accident. Appropriate seat covers can be obtained, for example, from a Mercedes-Benz Service Centre.

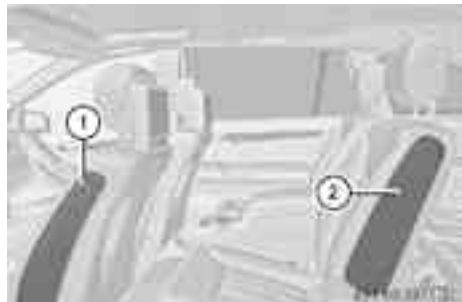

Front sidebags ① and sidebags in the 2nd row of seats ② inflate next to the outer seat cushion.

When deployed, the sidebags offer additional protection for the thorax of the vehicle occupants on the side of the vehicle on which the impact occurs. However, they do not protect the:

- head
- neck
- arms

The sidebags are deployed:

- on the side on which an impact occurs
- at the start of an accident with a high rate of lateral vehicle deceleration or acceleration, e.g. in a side impact
- independently of the use of the seat belt
- independently of the front airbags
- independently of the belt tensioners

If the vehicle overturns, the sidebags are generally not deployed. Sidebags are deployed if the system detects high vehicle deceleration or acceleration in a lateral direction, or also if the vehicle overturns, and the system determines that sidebag deployment can offer additional protection to that provided by the seat belt.

Windowbags

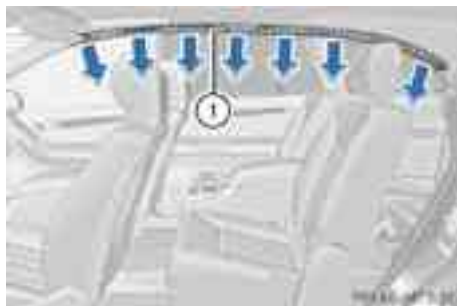

Windowbags ① enhance the level of protection for the head, but not chest or arms, of the vehicle occupants on the side of the vehicle on which the impact occurs.

The windowbags are integrated into the side of the roof frame and deploy in the area extending from the front door (A-pillar) to the rear side window (D-pillar).

Windowbags are deployed:

- at the start of an accident with a high rate of lateral vehicle deceleration or acceleration, e.g. in a side impact
- on the side on which an impact occurs
- on the driver's and the front passenger's side if the vehicle overturns and the system determines that windowbag deployment can offer additional protection to that provided by the seat belt
- independently of the use of the seat belt
- regardless of whether the front-passenger seat is occupied
- independently of the front airbags

PRE-SAFE® (preventative occupant protection)

WARNING

When adjusting the seat, make sure that nobody can become trapped.

- ! Make sure that there are no objects in the footwell or behind the seats when moving the seat back. There is a risk that the seats and/or the objects could be damaged.

PRE-SAFE® takes pre-emptive measures to protect occupants in certain hazardous situations.

PRE-SAFE® intervenes:

- when BAS activates, e.g. in emergency braking situations
- when BAS PLUS intervenes powerfully on vehicles with DISTRONIC PLUS
- if, on vehicles with DISTRONIC PLUS, the radar sensor system detects an imminent danger of collision in certain situations
- in critical driving situations, e.g. when physical limits are exceeded and the vehicle understeers or oversteers severely

If you are driving faster than approximately 30 km/h, PRE-SAFE® may take the following measures in these situations:

- the front seat belts are pre-tensioned.
- vehicles with the memory function: the front-passenger seat is adjusted if it is in an unfavourable position.
- if the vehicle skids, the sliding sunroof and the side windows are closed so that only a small gap remains.

If the hazardous situation passes without resulting in an accident, PRE-SAFE® slackens the belt pretensioning. All settings made by PRE-SAFE® can then be reversed.

If the seat belts are not released:

- ▶ Move the backrest or seat back slightly, but only when the vehicle is stationary. The belt pretensioning is reduced and the locking mechanism is released.

More information about seat-belt adjustment, a convenience function integrated into PRE-SAFE®, can be found in the "Seat-belt adjustment" section (▷ page 49).

NECK-PRO head restraints/NECK-PRO luxury head restraints

Important safety notes

WARNING

Only use head restraint covers which have been tested and approved by Mercedes-Benz for your vehicle model.

The use of non-approved head restraint covers may prevent NECK-PRO head restraints/NECK-PRO luxury head restraints from triggering properly. The NECK-PRO head restraints/NECK-PRO luxury head restraints can therefore not provide the intended protection.

Consult a Mercedes-Benz Service Centre regarding availability.

NECK-PRO head restraints/NECK-PRO luxury head restraints increase protection of the

driver's and front-passenger's head and neck. In the event of a rear collision of a certain severity, the NECK-PRO head restraints/NECK-PRO luxury head restraints on the driver's and front-passenger seats are moved forwards and upwards. This provides better head support.

If the NECK-PRO head restraints/NECK-PRO luxury head restraints have been triggered in an accident, reset the NECK-PRO head restraints/NECK-PRO luxury head restraints on the driver's and front-passenger seats (▷ page 47). Otherwise, the additional protection will not be available in the event of another rear-end collision. NECK-PRO head restraints/NECK-PRO luxury head restraints that have been triggered are moved forwards and can no longer be adjusted.

Mercedes-Benz recommends that you have the NECK-PRO head restraints/NECK-PRO luxury head restraints checked at a qualified specialist workshop after a rear-end collision.

Resetting a triggered NECK-PRO head restraint/NECK-PRO luxury head restraint

NECK-PRO head restraints

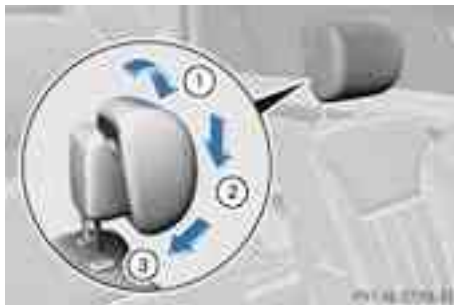

- ▶ Tilt the top of the NECK-PRO head restraint cushion forwards in the direction of arrow ①.
- ▶ Push the NECK-PRO head restraint cushion down in the direction of arrow ② as far as it will go.

- ▶ Firmly push the NECK-PRO head restraint cushion back in the direction of arrow ③ until the cushion engages.
- ▶ Repeat this procedure for the second NECK-PRO head restraint.
- ❗ Resetting the NECK-PRO head restraints requires a lot of strength. If you have difficulty resetting the NECK-PRO head restraints, have this work carried out at a qualified specialist workshop.

NECK-PRO luxury head restraints

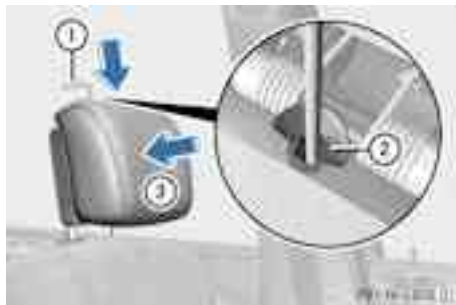

- ▶ Remove resetting tool ① from the vehicle document wallet.
- ▶ Slide resetting tool ① into guide ② between the NECK-PRO luxury head restraint and the rear cover of the head restraint.
- ▶ Push resetting tool ① downwards until you hear the head restraint deployment mechanism engage.
- ▶ Pull out resetting tool ①.
- ▶ Firmly press the NECK-PRO luxury head restraint cushion back ③ until it engages.
- ▶ Repeat this procedure for the second NECK-PRO luxury head restraint.
- ▶ Put resetting tool ① back into the vehicle document wallet.
- ❗ If you have difficulty resetting the NECK-PRO luxury head restraints, have this work carried out at a qualified specialist workshop.

Seat belts

Important safety notes

WARNING

A seat belt which is not worn correctly, or which has not been engaged in the seat belt buckle correctly, cannot provide the intended level of protection. Under certain circumstances, this could cause severe or even fatal injuries in the event of an accident.

Therefore, make sure that all occupants – in particular, pregnant women – wear their seat belts correctly at all times.

- The seat belt must fit snugly on your body and must not be twisted. Therefore, avoid wearing bulky clothing, e.g. a winter coat. The shoulder section of the belt must be routed across the centre of your shoulder – on no account across your neck or under your arm – and pulled tight against your upper body. The lap belt must always pass across your lap as low down as possible, i.e. over your hip joints – not across your abdomen. If necessary, push the seat belt slightly downwards and adjust it by pulling it in the direction the seat belt retracts.
- Do not route the seat belt strap over sharp or fragile objects. Please make sure that such objects are not on or in your clothing, e.g. spectacles, pens or keys etc. The seat belt strap could become damaged and tear during an accident and you or other vehicle occupants could be injured.
- Only one person should use each seat belt at any one time. Children must never travel sitting on the lap of another occupant. The child will not be secured in the event of an accident, heavy braking or sudden change of direction. This may result in the child or other occupants being seriously or fatally injured.
- Persons under 1.50 m tall cannot wear the seat belts correctly. For this reason secure persons less than 1.50 m tall in specially designed, suitable restraint systems.

- Children under 1.50 m tall and younger than twelve years of age cannot wear the seat belts correctly. For this reason secure them in special suitable child restraint systems installed on a suitable seat. Additional information can be found in the Operating Instructions in the chapter "Safety", "Children in the Vehicle". Observe the installation instructions of the child restraint system manufacturer.
- Do not secure an object with a seat belt if the seat belt is also being used by one of the vehicle's occupants.

WARNING

The seat belt does not offer the intended level of protection unless the backrest is almost vertical. Under certain circumstances, this could cause severe or even fatal injuries in the event of an accident.

Before starting a journey, make sure that the seat is properly adjusted and that the backrest is almost vertical.

WARNING

A dirty or damaged seat belt or one that has been modified or subjected to a load in an accident no longer offers the intended level of protection. Under certain circumstances, this could cause severe or even fatal injuries in the event of an accident.

For this reason, check regularly that the seat belts are not damaged or dirty.

Always have damaged seat belts or seat belts that have been subjected to a load in an accident replaced at a qualified specialist workshop.

For safety reasons, Mercedes-Benz recommends that you only use seat belts which have been approved by Mercedes-Benz for your vehicle.

Seat belts are the most effective means of restraining the movement of vehicle occupants in the event of an accident. This

reduces the risk of vehicle occupants coming into contact with parts of the vehicle interior.

Fastening seat belts



- ▶ Adjust the seat and move the backrest to an almost vertical position (▷ page 92).
- ▶ Pull the seat belt smoothly through belt sash guide ①.
- ▶ Without twisting it, guide the shoulder section of the seat belt across the middle of your shoulder and the hip section across your hips.
- ▶ Engage belt tongue ② in buckle ③. Seat-belt adjustment: if necessary, the driver's and front-passenger seat belts automatically adjust to the upper body (▷ page 49).
- ▶ If necessary, adjust the seat belt to the appropriate height (▷ page 49).
- ▶ If necessary, pull upwards on the shoulder section of the seat belt to tighten the belt across your body.

For more information about releasing the seat belt with release button ④, see "Releasing seat belts" (▷ page 49).

Seat belt adjustment

The seat-belt adjustment function adjusts the driver's and front-passenger seat belt to the upper body of the occupants.

The belt strap is tightened slightly when:

- you engage the belt tongue in the belt buckle and you then turn the key to position **2** in the ignition lock.
- the key is in position **2** in the ignition lock and you then engage the belt tongue in the buckle.

The seat-belt adjustment will apply a certain tightening force if any slack is detected between the occupant and the seat belt. Do not hold on to the seat belt tightly while it is adjusting. You can switch the seat-belt adjustment on and off in the on-board computer (▷ page 206).

The seat-belt adjustment is an integral part of the PRE-SAFE® convenience function. More information about PRE-SAFE® can be found under "PRE-SAFE® (preventative occupant protection)" (▷ page 45).

Belt height adjustment



You can adjust the belt height for the front seats. Adjust the belt to a height that allows the upper part of the seat belt to be routed across the centre of your shoulder.

- ▶ **To raise:** slide the belt sash guide upwards. The belt sash guide engages in various positions.
- ▶ **To lower:** press and hold belt sash guide release ①.
- ▶ Slide the belt sash guide downwards.
- ▶ Let go of belt sash guide release ① and make sure that the belt sash guide has engaged.

Releasing the seat belts

- ❗ Make sure that the seat belt is fully rolled up. Otherwise, the seat belt or belt tongue will be trapped in the door or in the seat mechanism. This could damage the door, the door trim panel and the seat belt. Damaged seat belts can no longer fulfil their protective function and must be replaced. Visit a qualified specialist workshop.

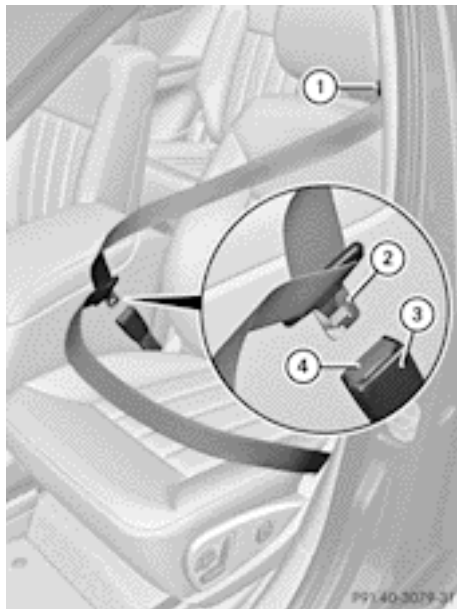



- ① Belt sash guide
- ② Belt tongue
- ③ Buckle
- ④ Release button

- ▶ Press release button ④ and guide belt tongue ② back towards belt sash guide ①.

Belt warning for the driver and front passenger

The  seat belt warning lamp in the instrument cluster is a reminder for all occupants to fasten their seat belts. It may light up continuously or flash. In addition, there may be a warning tone.

The  seat belt warning lamp goes out and the warning tone ceases when the driver and the front passenger have fastened their seat belt.

For certain countries only: regardless of whether the driver and the front passenger have fastened their seat belts, the  seat belt warning lamp lights up for six seconds after the engine is started. It then goes out if the driver and the front passenger have fastened their seat belts.

- i** For more information on the  seat belt warning lamp, see "Indicator and warning lamps in the instrument cluster, seat belt" (▷ page 233).

Belt tensioners, belt force limiters

WARNING

If the seat belt tensioners have been triggered, they provide no additional protection in the event of another accident. Therefore, have belt tensioners which have been triggered replaced at a qualified specialist workshop.

Comply with safety regulations when disposing of belt tensioners. Any Mercedes-Benz Service Centre can provide details of these regulations.

- !** If the front-passenger seat is not occupied, do not engage the seat belt tongue in the buckle on the front-passenger seat. Otherwise, the belt tensioner could be triggered in the event of an accident.

- ▶ In order to ensure that the pyrotechnic seat belt tensioners have not been triggered, always have the seat belts checked after an accident.

If the belt tensioners have been triggered, they must be replaced.

The seat belts on the following seats are fitted with belt tensioners:

- driver's and front-passenger seat
- the outer seats in the second row
- the seats in the third row

The belt tensioners tighten the seat belts in an accident, pulling them close against the body.

Belt tensioners do not correct incorrect seat positions or incorrectly fastened seat belts.

Belt tensioners do not pull vehicle occupants back towards the backrest.

If the seat belt is also fitted with a belt force limiter and this is triggered, the force exerted by the seat belt on the vehicle occupant is reduced.

The belt force limiters for the front seats are synchronised with the front airbags, which take on a part of the deceleration force. This results in the force exerted on the occupant being distributed over a greater area.

The belt tensioners can only be activated when:

- the ignition is switched on.
- the restraint systems are operational; see "SRS warning lamp" (▷ page 41).
- the belt tongue is engaged in the buckle on each of the three-point seat belts in the front.

The belt tensioners on the outside seats in the second row and on the seats in the third row are triggered independently of the lock status of the seat belts.

The belt tensioners are triggered depending on the type and severity of an accident:

- if, in the event of a head-on or rear-end collision, the vehicle decelerates or accelerates

ates rapidly in a longitudinal direction during the initial stages of the impact

- if, in the event of a side impact, the vehicle is subjected to high lateral acceleration/ deceleration
- in certain situations where the vehicle overturns and the system determines that it can provide additional protection

If the airbags are deployed, you will hear a bang, and a small amount of powder may also be released. Only in rare cases will the bang affect your hearing. The powder that is released generally does not constitute a health hazard. The  SRS warning lamp lights up.

Children in the vehicle

Child restraint systems

Important safety notes

WARNING

To reduce the risk of serious or even fatal injury to the child in the event of a sudden change in direction, braking or an accident:

- children less than 1.50 m tall and under twelve years of age must always be secured in special child restraint systems on a suitable vehicle seat. This is necessary because the seat belts are not designed for children.
- Do not drive with a child secured in a rearward-facing child restraint system on the front-passenger seat. Exception: if the vehicle is equipped with automatic child seat recognition on the front-passenger seat and the child is secured in a child restraint system with transponders for automatic child seat recognition
- if you secure a forward-facing child restraint system to the front-passenger seat, you must move the front-passenger seat as far back as possible.
- children must never travel sitting on the lap of another occupant. Due to the forces

which occur in the event of a sudden change of direction, heavy braking or an accident, it would not be possible to restrain the child. The child could be thrown against parts of the vehicle interior and be seriously or even fatally injured.

WARNING

Do not leave children unsupervised in the vehicle, even if they are secured in a child restraint system. They could injure themselves on parts of the vehicle. They could also be seriously or even fatally injured by prolonged exposure to extreme heat or cold.

Do not expose the child restraint system to direct sunlight. Parts of the child restraint system could heat up and the child could burn herself/himself on them.

If a child opens a door, the child or other persons could be injured as a result. They could get out and injure themselves or be injured by a passing vehicle.

WARNING

Unsecured or incorrectly positioned loads increase the risk of injury for children and all other occupants in the event of:

- an accident
- sudden braking
- a sudden change of direction

Do not transport heavy or hard objects in the vehicle interior unless they are secured. You will find further information under "Loading guidelines" in the index.

If a child is travelling in your vehicle, secure the child using a child restraint system that is recommended for Mercedes-Benz vehicles. The child restraint system must be appropriate to the age, weight and size of the child. You should preferably fit the child restraint system to a suitable rear seat. Make sure that the child is secured for the trip.

Mercedes-Benz recommends that you use the listed child restraint systems (> page 59). You can obtain further infor-

mation about the correct child restraint system from any Mercedes-Benz Service Centre.

- It is advisable to use Mercedes-Benz care products to clean child restraint systems. You can obtain information about this at any Mercedes-Benz Service Centre.

Child restraint system on the front-passenger seat

WARNING

If the front-passenger airbag is not disabled:

- a child secured in a child restraint system on the front-passenger seat could be seriously and even fatally injured by the front-passenger airbag deploying. This is especially a risk if the child is in the immediate vicinity of the front-passenger airbag when it deploys.
- never secure a child on the front-passenger seat in a rearward-facing child restraint system. Only secure a rearward-facing child restraint system on a suitable rear seat.
- always move the front-passenger seat to the rearmost position if you secure a child in a forward-facing child restraint system on the front-passenger seat.

The front-passenger airbag is not disabled:

- on vehicles without automatic child seat recognition on the front-passenger seat
- in vehicles with automatic child seat recognition in the front-passenger seat, if no special child restraint system with transponders for automatic child seat recognition in the front-passenger seat has been fitted
- on vehicles with automatic child seat recognition on the front-passenger seat, if the PASSENGER AIRBAG OFF indicator lamp  is not lit.

To make you aware of this danger, a corresponding warning sticker has been affixed on the dashboard and on both sides of the sun visor on the front-passenger side.

Information about recommended child restraint systems is available at any Mercedes-Benz Service Centre.



Warning notice on the front-passenger sun visor



Warning symbol for a rearward-facing child restraint system

Do not use a rearward-facing child restraint system on a seat that is protected by an airbag installed in front of it.

Automatic child seat recognition on the front-passenger seat

WARNING

If the  PASSENGER AIRBAG OFF indicator lamp does not light up when the child restraint system is fitted, the front-passenger airbag has not been disabled. If the front-passenger airbag deploys, the child could be seriously or even fatally injured.

Proceed as follows:

- do not use a rearward-facing child restraint system on the front-passenger seat.
- fit a rearward-facing child restraint system on a suitable rear seat.

or



- only use a forward-facing child restraint system on the front-passenger seat and move the front-passenger seat to the rear-most position.
- have the automatic child seat recognition checked at a qualified specialist workshop.

To ensure that the automatic child seat recognition on the front-passenger seat functions/communicates correctly, never place objects, e.g. a cushion, under the child restraint system. The entire base of the child restraint system must always rest on the seat cushion. An incorrectly fitted child restraint system cannot perform its intended protective function in the event of an accident, and could lead to injuries.

WARNING

Do not place electronic devices on the front-passenger seat, e.g.:

- laptops, when switched on
- mobile phones
- cards with transponders, e.g. ski passes or access cards

Signals from electronic equipment can cause interference in the automatic child seat recognition sensor system. This can lead to a system malfunction. This may cause the  PASSENGER AIRBAG OFF indicator lamp to light up without there being a child seat with automatic child seat recognition fitted, and the front-passenger front airbag will not deploy during an accident. It is also possible that the  SRS warning lamp lights up and/or the  PASSENGER AIRBAG OFF indicator lamp does not light up briefly when you turn the key in the ignition lock to position 2.



If the front-passenger seat of your vehicle does not have automatic child seat recognition, this is indicated by a special sticker. The sticker is affixed to the side of the dashboard on the front-passenger side. The sticker is visible when you open the front-passenger door.

Vehicles without automatic child seat recognition on the front-passenger seat: if you turn the key to position 2 in the ignition lock, the PASSENGER AIRBAG OFF  indicator lamp lights up briefly. It has no function, however, and does not indicate that the front-passenger seat is equipped with automatic child seat recognition.

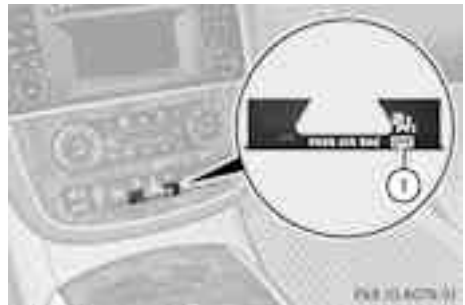

The front-passenger seat sensor system for child restraint systems detects whether a special Mercedes-Benz child seat with a transponder for automatic child seat recognition has been fitted. In this case,  PASSENGER AIRBAG OFF indicator lamp ① lights up. The front-passenger front airbag is disabled.

i If the front-passenger front airbag is disabled by the automatic child seat recognition, the following remain enabled on the front-passenger side:

- the sidebag
- the windowbag
- the belt tensioner

ISOFIX child seat securing system for the rear seats

⚠ WARNING

A child restraint system secured by the ISOFIX child seat securing system does not provide sufficient protection for children weighing more than 22 kg. For this reason, do not secure children weighing more than 22 kg in a child restraint system secured by the ISOFIX child seat securing system. If the child weighs more than 22 kg, secure the child restraint system with the vehicle seat belt as well. In addition, when fitting a child restraint system, be sure to observe the manufacturer's installation instructions and the instructions for correct use of the child restraint system.

⚠ WARNING

The child restraint system cannot perform its protective function if it is not correctly fitted to a suitable vehicle seat. The child cannot be restrained in the event of an accident, heavy braking or sudden changes of direction. The child could be seriously or even fatally injured. For this reason, when fitting a child restraint system, be sure to observe the manufacturer's installation instructions and the instructions for correct use of the child restraint system.

For safety reasons, when installing child restraint systems on the outer rear seats, only use child restraint systems with the ISOFIX child seat securing system, which are specially tested and approved for Mercedes-Benz vehicles.

An incorrectly fitted child restraint system could come loose and seriously or even fatally

injure the child or other vehicle occupants. When fitting the child restraint system, always make sure that it is engaged correctly in the securing rings on both sides.

To ensure that the child restraint system can perform its protective function as intended, the backrest of the outer seat in the second row must be in the upright position.

⚠ WARNING

Please note that if child restraint systems, or their retaining systems, are damaged or subjected to a load in an accident, they may not be able to provide their protective function. This could result in serious or even fatal injuries to the secured child in the event of an accident, heavy braking or a sudden change in direction.

For this reason, have child restraint systems and their anchorages which have been damaged or subjected to a load in an accident checked immediately at a qualified specialist workshop.

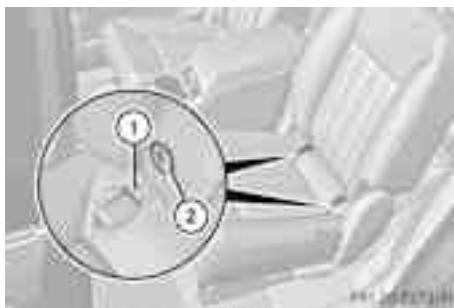

Outer seat in the second row

- ① Securing rings
- ② Installation instructions for the securing ring

Securing ring ① for two ISOFIX child restraint systems can be found on the left and right:

- on the seat cushions of the outer seats in the second row
- on the backrests of the seats in the third row of seats.

- ▶ Move the rear seat backrests in the second row to an upright position (▷ page 98).
- ▶ Slide the upholstered lining over retaining loop ① to one side.
- ▶ Install the ISOFIX child restraint system. Comply with the manufacturer's instructions when installing the ISOFIX child restraint system.



Seat in the third row

The securing rings on the seats in the third row are covered by protective caps.

- ▶ Remove protective caps ③ in the third row of seats.

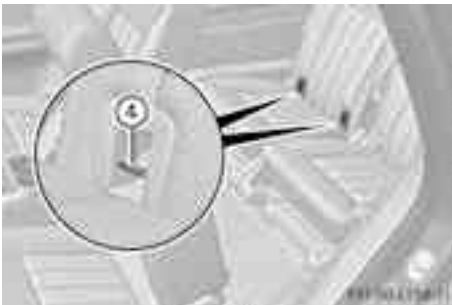

④ Securing rings for the third row of seats

- ▶ Install the ISOFIX child restraint system. Comply with the manufacturer's instructions when installing the ISOFIX child restraint system.

Top Tether

Top Tether anchorages

Top Tether provides an additional connection between the child restraint system secured with ISOFIX and the rear seat. It helps reduce the risk of injury even further.

The Top Tether anchorages are located on the rear side of the rear seat backrests for:

- the outer seats in the second row of seats
- the seats in the third row of seats

Outer seats in the second and third rows of seats

WARNING

Do not secure the Top Tether hook to the loop underneath the Top Tether anchorage if you are securing a child restraint system in the third row of seats. The child restraint system is not secured if you do so. An incorrectly fitted child restraint system cannot perform its intended protective function in the event of an accident, and could lead to injuries.

WARNING

Make sure that the seats are locked and that the backrests are locked in the vertical position after fitting the Top Tether belt.

The outer seats in the second row are only locked if the lock verification indicator is folded in and the indicator area is barely visible. If the backrests are not locked, they could fold forwards in the event of an accident, sudden braking or a sudden change of direction.

Instead of restraining an occupant, they could cause additional serious or even fatal injury.



- ▶ Remove respective covering cap ① of the Top Tether anchorage.
- ▶ Move the head restraint upwards.
- ▶ Release the rear seat backrest and fold it forwards (> page 250).

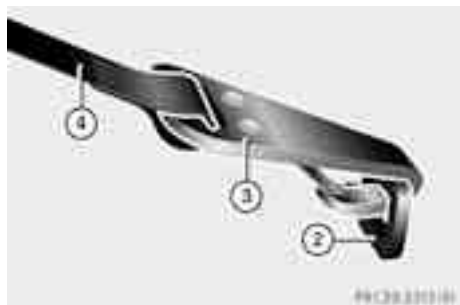







- ▶ Route Top Tether belt ④ under head restraint between the two head restraint bars.
- ▶ Hook Top Tether hook ③ into Top Tether anchorage ②.

Ensure that:

- Top Tether hook ③ is hooked into Top Tether anchorage ② as shown.
 - Top Tether belt ④ is not twisted.
 - Top Tether belt ④ is routed between the rear seat backrest and luggage compartment cover if the luggage compartment cover is fitted.
 - Top Tether belt ④ is routed between the rear seat backrest and the safety net if the safety net is fitted.
- ▶ Swing back the rear seat backrest until it engages (> page 250).
The outer seats in the second row are only locked if the lock verification indicator is folded in and the indicator area is barely visible (> page 250).
 - ▶ Move the head restraint back down again slightly if necessary (> page 96). Make sure that you do not interfere with the correct routing of Top Tether belt ④.
 - ▶ Fit the ISOFIX child restraint system with Top Tether. Comply with the manufacturer's installation instructions when doing so. Make sure that Top Tether belt ④ is tight.

Problems with child seat recognition

Problem	Possible causes/consequences and ► Solutions
The  PASSENGER AIRBAG OFF indicator lamp on the centre console is lit.	A special Mercedes-Benz child seat with a transponder for automatic child seat recognition has been fitted to the front-passenger seat. The front-passenger front airbag has therefore been disabled as desired.
The  PASSENGER AIRBAG OFF indicator lamp on the centre console is lit. or The  warning lamp lights up and/or the  PASSENGER AIRBAG OFF indicator lamp does not light up briefly when you switch the ignition on.	<p> Risk of injury</p> <p>There is no child seat fitted to the front-passenger seat. Automatic child seat recognition is malfunctioning.</p> <p>► Remove electronic equipment from the front-passenger seat, e.g.:</p> <ul style="list-style-type: none"> • laptop • mobile phone • cards with transponders, such as ski passes or access cards <p>If the  PASSENGER AIRBAG OFF indicator lamp is still lit:</p> <p>► Visit a qualified specialist workshop.</p>

Suitable positioning of the child restraint systems

- If you fit a child restraint system to the front-passenger seat, position the front-passenger seat in its rearmost position.
- If you install a child restraint system on the rear seat on the second row, move the rear seat backrests in the second row to an upright position.

Key to the letters used in the following table:

- X Seat which is unsuitable for children in this weight category.
- U Suitable for child restraint systems in the "Universal" category that are approved for use in this weight category.
- L Suitable for child restraint systems as recommended; see the following table of "Recommended child restraint systems" (► page 59).

Front-passenger seat

Weight categories	Front-passenger front air-bag is not disabled.	Front-passenger front air-bag is disabled.
Category 0: up to 10 kg	X	U
Category 0+: up to 13 kg	X	U
Category I: 9 to 18 kg	L	U
Category II: 15 to 25 kg	X	U
Category III: 22 to 36 kg	X	U

Vehicles with automatic child seat recognition in the front-passenger seat: a "Uni-

versal" category child restraint system with a transponder for automatic child seat recognition must be fitted when the front-passenger airbag is disabled. The  PASSENGER AIRBAG OFF indicator lamp must be lit.

Rear seats

Weight categories	Third row of seats, left and right	Centre
Category 0: up to 10 kg	U	L
Category 0+: up to 13 kg	U	L
Category I: 9 to 18 kg	U	L
Category II: 15 to 25 kg	U	L
Category III: 22 to 36 kg	U	L

"Universal" category child restraint systems can be recognised by their orange approval label.



Example: approval label on the child restraint system

Suitability of the rear seats for attaching ISOFIX child restraint systems

Key to the letters used in the following table:

- X ISOFIX position that is not suitable for ISOFIX child restraint systems in this weight category and/or size category.
- IUF Suitable for forward-facing ISOFIX child restraint systems that belong to the "Universal" category which are approved for use in this weight category.
- IL Suitable for ISOFIX child restraint systems as recommended; see the following table of "Recommended child restraint systems" (> page 59).

Carry-cot weight category

Size category	Equipment	Third row of seats, left and right	Third row of seats, left and right
F	ISO/L1	X	X
G	ISO/L2	X	X

Weight category 0: up to 10 kg, up to approximately 6 months

Size category	Equipment	Rear seat, left and right	Third row of seats, left and right
E	ISO/R1	IUF	X

Weight category 0+: up to 13 kg, up to approximately 15 months

Size category	Equipment	Rear seat, left and right	Third row of seats, left and right
E	ISO/R1	IUF	X
D	ISO/R2	IUF	X
C	ISO/R3	IUF	X

Weight category I: 9 to 18 kg, approximately 9 months to 4 years

Size category	Equipment	Rear seat, left and right	Third row of seats, left and right
D	ISO/R2	IUF	X
C	ISO/R3	IUF	X
B	ISO/F2	IUF	IUF
B1	ISO/F2X	IUF	IUF
A	ISO/F3	IUF	IUF

Recommended child restraint systems

When installing a child restraint system without a transponder for automatic child seat recognition on the front-passenger seat:

- Move the front-passenger seat to its highest and rearmost position.

Weight category 0: up to 10 kg, up to approximately 6 months

Manufacturer	Britax Römer
Type	BABY SAFE PLUS
Approval number (E1 ...)	03 301146 04 301146
Order number (A 000 ...)	970 10 00
Automatic child seat recognition	Yes

Weight category 0+: up to 13 kg, up to approximately 15 months

Manufacturer	Britax Römer
Type	BABY SAFE PLUS
Approval number (E1 ...)	03 301146 04 301146

Order number (A 000 ...)	970 10 00
Automatic child seat recognition	Yes

Weight category I: 9 to 18 kg, approximately 9 months to 4 years

Manufacturer	Britax Römer	Britax Römer
Type	DUO PLUS	DUO PLUS
Approval number (E1 ...)	03 301133 04 301133	03 301133 04 301133
Order number (A 000 ...)	970 11 00	970 16 00
Automatic child seat recognition	Yes	No

Weight category II/III: 15 to 36 kg, approximately 4 to 12 years

Manufacturer	Britax Römer	Britax Römer
Type	KID	KID
Approval number (E1 ...)	03 301148 04 301148	03 301148 04 301148
Order number (A 000 ...)	970 12 00	970 17 00
Automatic child seat recognition	Yes	No

Suggested "Universal" category ISOFIX child restraint systems:

Carry-cot weight category

Size categories	F, G
Manufacturer	-
Type	-
Approval number (E1 ...)	-
Order number	-
Automatic child seat recognition	-

Category 0: up to 10 kg

Size category	E
Manufacturer	-
Type	-
Approval number (E1 ...)	-
Order number	-
Automatic child seat recognition	-

Category 0+: up to 13 kg

Size categories	E	D, C
Manufacturer	Britax Römer	-
Type	BABY SAFE ISOFIX PLUS	-
Approval number (E1 ...)	04 301146	-
Order number	B6 6 86 8224	-
Automatic child seat recognition	No	-

Category I: 9 to 18 kg

Size categories	D, C, B, A
Manufacturer	-
Type	-
Approval number (E1 ...)	-
Order number	-
Automatic child seat recognition	-

Size category	B1
Manufacturer	Britax Römer
Type	DUO PLUS
Approval number (E1 ...)	03 301133 04 301133
Order number	A000 970 11 00
Automatic child seat recognition	Yes

Child-proof locks

Important safety notes

 WARNING

Activate the child-proof locks for the rear doors and the override switch for the rear windows when children are travelling in the vehicle. Otherwise, the children could open doors or side windows while the vehicle is in motion and injure themselves or others.

 WARNING

Do not leave children unsupervised in the vehicle, even if they are secured in a child restraint system. They could injure themselves on parts of the vehicle. They could also be seriously or even fatally injured by prolonged exposure to extreme heat or cold.

Do not expose the child restraint system to direct sunlight. Parts of the child restraint system could heat up and the child could burn herself/himself on them.

If a child opens a door, the child or other persons could be injured as a result. They could get out and injure themselves or be injured by a passing vehicle.

Child-proof locks for the rear doors



You secure each door individually with the child-proof locks on the rear doors. A door secured with a child-proof lock cannot be opened from inside the vehicle. When the vehicle is unlocked, the door can be opened from the outside.

- ▶ **To activate:** press the child-proof lock lever down in the direction of arrow ②.
- ▶ Make sure that the child-proof locks are working properly.
- ▶ **To deactivate:** press the child-proof lock lever up in the direction of arrow ①.

Override feature for the rear side windows

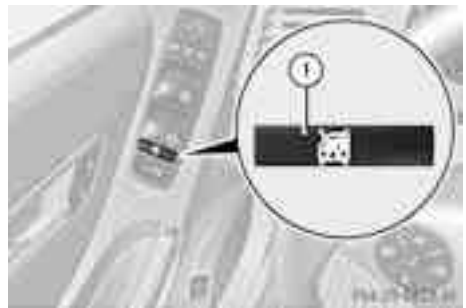

- ▶ **To activate/deactivate:** press switch ①. Switch ① is pushed in or extended. If the switch has engaged, operation of the rear side windows is disabled. Operation is then only possible using the switches in the driver's door.

Driving safety systems

Driving safety systems overview

In this section, you will find information about the following driving safety systems:

- ABS (Anti-lock Braking System) (▷ page 62)
- BAS (Brake Assist System) (▷ page 62)
- adaptive brake lamps (▷ page 62)
- ESP® (Electronic Stability Program) (▷ page 63)
- EBD (electronic brake force distribution) (▷ page 64)
- distance warning function (▷ page 65)

Important safety notes

If you fail to adapt your driving style or become distracted, the driving safety systems can neither reduce the risk of accident nor override the laws of physics. Driving safety systems are merely aids designed to assist driving. You are responsible for the distance to the vehicle in front, for vehicle speed

and for braking in good time. Always adapt your driving style to suit the prevailing road and weather conditions and maintain a safe distance from the vehicle in front. Drive carefully.

- i** The driving safety systems described only work as effectively as possible when there is adequate contact between the tyres and the road surface. Please pay special attention to the notes on tyres, recommended minimum tyre tread depths, etc. (▷ page 312).

In wintry driving conditions, always use winter tyres (M+S tyres) and if necessary, snow chains. Only in this way will the driving safety systems described in this section work as effectively as possible.

ABS (Anti-lock Braking System)

Important safety notes

- i** Observe the "Important safety notes" section (▷ page 61).

WARNING

If ABS is faulty, the wheels could lock when braking. The steerability and braking characteristics may be severely impaired. Additionally, further driving safety systems are deactivated. There is an increased danger of skidding and accidents.

Drive on carefully. Have ABS checked immediately at a qualified specialist workshop.

When ABS is malfunctioning, other systems, including driving safety systems, will also become inoperative. Observe the information on the ABS warning lamp (▷ page 235) and display messages which may be shown in the instrument cluster (▷ page 211).

ABS regulates brake pressure in such a way that the wheels do not lock when you brake. This allows you to continue steering the vehicle when braking.

ABS works from a speed of about 8 km/h upwards, regardless of road-surface condi-

tions. ABS works on slippery surfaces, even when you only brake gently.

The yellow  ABS warning lamp in the instrument cluster lights up when the ignition is switched on. It goes out when the engine is running.

Brakes

- ▶ **If ABS intervenes:** continue to depress the brake pedal with force until the braking situation is over.

- ▶ **To make a full brake application:** depress the brake pedal with full force.

If ABS intervenes when braking, you will feel a pulsing in the brake pedal.

The pulsating brake pedal can be an indication of hazardous road conditions, and functions as a reminder to take extra care while driving.

BAS (Brake Assist System)

- i** Observe the "Important safety notes" section (▷ page 61).

WARNING

If BAS is malfunctioning, the braking distance in an emergency braking situation is increased. There is a risk of accident.

In an emergency braking situation, depress the brake pedal with full force. ABS prevents the wheels from locking.

BAS operates in emergency braking situations. If you depress the brake pedal quickly, BAS automatically boosts the braking force, thus shortening the stopping distance.

The brakes will function as usual once you release the brake pedal. BAS is deactivated.

Adaptive brake lamps

If you brake sharply from a speed of more than 25 km/h or if braking is assisted by BAS, the brake lamps flash rapidly. In this way,

traffic travelling behind you is warned in an even more noticeable manner.

If you brake sharply from a speed of more than 70 km/h to a standstill, the hazard warning lamps are activated automatically. If the brakes are applied again, the brake lamps light up continuously. The hazard warning lamps switch off automatically if you travel faster than 10 km/h. You can also switch off the hazard warning lamps using the hazard warning button (▷ page 114).

ESP® (Electronic Stability Program)

Important safety notes

- ❶ Observe the "Important safety notes" section (▷ page 61).

WARNING

If ESP® is malfunctioning, ESP® is unable to stabilise the vehicle. In addition, other driving safety systems are switched off. This increases the risk of skidding and an accident.

Drive on carefully. Have ESP® checked at a qualified specialist workshop.

- ❶ Vehicles with 4MATIC: only operate the vehicle for a maximum of ten seconds on a brake dynamometer. Switch off the ignition.



Application of the brakes by ESP® may otherwise destroy the brake system.

- ❶ Vehicles with 4MATIC: function or performance tests may only be carried out on a 2-axle dynamometer. Before operating the vehicle on such a dynamometer, please consult a qualified specialist workshop. You could otherwise damage the drive train or the brake system.

- ❶ The ignition must be switched off if you are towing the vehicle with the front/rear axle raised. Intervention by ESP® could otherwise damage the brake system.

- ❶ Do not tow vehicles with 4MATIC with the front or rear axle raised.

ESP® is deactivated if the  warning lamp in the instrument cluster lights up continuously when the engine is running.

If the  warning lamp and the  warning lamp are lit continuously, ESP® is not available due to a malfunction.

Observe the information on warning lamps (▷ page 237) and display messages which may be shown in the instrument cluster (▷ page 211).

If ESP® detects that the vehicle is deviating from the direction desired by the driver, one or more wheels are braked to stabilise the vehicle. The engine output is also modified to keep the vehicle on the desired course within physical limits. ESP® assists the driver when pulling away on wet or slippery roads. ESP® can also stabilise the vehicle during braking. If ESP® intervenes, the  ESP® warning lamp flashes in the instrument cluster.

If ESP® intervenes:

- ▶ Do not deactivate ESP® under any circumstances.
- ▶ When pulling away, only depress the accelerator pedal as far as is necessary.
- ▶ Adapt your driving style to suit the prevailing road and weather conditions.

- ❶ Only use wheels with the recommended tyre sizes. Only then will ESP® function properly.

ETS/4ETS (Electronic Traction System)

Traction control is part of ESP®.

Traction control brakes the drive wheels individually if they spin. This enables you to pull away and accelerate on slippery surfaces, for example if the road surface is slippery on one side. On vehicles with 4MATIC, more drive torque is also transferred to the wheel or wheels with traction.

Traction control remains active if you deactivate ESP®.

Deactivating/activating ESP®

⚠ WARNING

If you deactivate ESP®, ESP® no longer stabilises the vehicle. There is an increased risk of skidding and an accident.

Only deactivate ESP® in the situations described in the following.



▶ **To switch off:** press button ①.

The  ESP® OFF warning lamp in the instrument cluster lights up.

▶ **To switch on:** press button ①.

The  ESP® OFF warning lamp in the instrument cluster goes out.

ESP® is activated automatically when the engine is started.

If ESP® is deactivated and one or more wheels start to spin, the  ESP® warning lamp in the instrument cluster flashes. In such situations, ESP® will not stabilise the vehicle.

It may be best to deactivate ESP® in the following situations:

- when using snow chains
- in deep snow
- on sand or gravel

If you deactivate ESP®:

- ESP® no longer improves driving stability.
- traction control is still activated.

- ESP® still provides support when you brake.
- engine torque is not limited and the drive wheels are able to spin. The spinning of the wheels results in a cutting action for better traction.

ESP® trailer stabilisation

⚠ WARNING

If road and weather conditions are poor, trailer stabilisation will not be able to prevent the vehicle/trailer combination from swerving. Trailers with a high centre of gravity can tip over before ESP® can detect this. There is a risk of an accident.

Always adapt your driving style to the prevailing road and weather conditions.

If your vehicle/trailer combination begins to lurch, you can only stabilise the vehicle/trailer combination by depressing the brake firmly.

In this situation, ESP® assists you and can detect if the vehicle/trailer combination begins to lurch. ESP® slows the vehicle down by braking and limiting the engine output until the vehicle/trailer combination has stabilised.

Trailer stabilisation is active above speeds of about 65 km/h.

Trailer stabilisation does not work if ESP® is deactivated or disabled because of a malfunction.

EBD (electronic brake force distribution)

❗ Observe the "Important safety notes" section (▷ page 61).

⚠ WARNING

If EBD has malfunctioned, the rear wheels can still lock, e.g. under full braking. This increases the risk of skidding and an accident.

You should therefore adapt your driving style to the different handling characteristics. Have the brake system checked at a qualified specialist workshop.

Observe information regarding indicator and warning lamps (▷ page 235) as well as display messages (▷ page 213).

EBD monitors and controls the brake pressure on the rear wheels to improve driving stability while braking.

Distance warning function

Important safety notes

- **i** Observe the "Important safety notes" section (▷ page 61).

WARNING

The distance warning function does not react:

- to people or animals
- to oncoming vehicles
- to crossing traffic
- when cornering

Thus, the distance warning function cannot provide a warning in all critical situations.

There is a risk of an accident.

Always pay careful attention to the traffic situation and be ready to brake.

The distance warning function is only available in vehicles with DISTRONIC.

The distance warning function cannot always clearly identify objects and complex traffic situations.

In such cases, the distance warning signal may:

- give an unnecessary warning
- not give a warning

Always pay careful attention to the traffic situation and do not rely solely on the distance warning function.



Function

- ▶ **To activate/deactivate:** activate or deactivate the distance warning function in the on-board computer (▷ page 207).

After activation, the  symbol is displayed in the lower multifunction display.

The distance warning function can help you to minimise the risk of a collision with the vehicle in front or reduce the effects of such a collision. If the distance warning function detects that there is a risk of a collision, you will be warned visually and acoustically. The distance warning function cannot prevent a collision without your intervention.

The distance warning function will issue a warning at speeds of around 30 km/h or more if:

- the distance to the vehicle in front is too short for the speed you are driving at for several seconds. The  distance warning lamp then lights up in the instrument cluster.
- you are rapidly approaching the vehicle in front. An intermittent warning tone will then sound and the  distance warning lamp will light up in the instrument cluster.

- ▶ Brake immediately in order to increase the distance from the vehicle in front.

or

- ▶ Take evasive action provided it is safe to do so.

For the distance warning function to assist you when driving, the function must be activated in the on-board computer and be operational (▷ page 207).

Due to the nature of the system, particularly complicated driving conditions may cause the system to display an unnecessary warning.

With the help of the radar sensor system, the distance warning function can detect obstacles that are in the path of your vehicle for an extended period of time.

At speeds up to approximately 70 km/h, the distance warning function may also detect

stationary obstacles, for example, stopped or parked vehicles.

If you approach an obstacle and the distance warning function detects a risk of a collision, the system will initially alert you both visually and acoustically.

In particular, the detection of obstacles can be impaired if there is:

- dirt on the sensors or anything else covering the sensors
- snow or heavy rain
- interference by other radar sources
- the possibility of strong radar reflections, for example, in multi-storey car parks
- a narrow vehicle travelling in front, e.g. a motorcycle
- a vehicle travelling in front on a different line

Following damage to the front end of the vehicle, have the configuration and operation of the radar sensor checked at a qualified specialist workshop. This also applies to collisions at slow speeds where there is no visible damage to the front of the vehicle.

Anti-theft systems

Immobiliser

- ▶ **To activate with the key:** remove the key from the ignition lock.
- ▶ **To activate with KEYLESS-GO:** switch the ignition off and open the driver's door.
- ▶ **To deactivate:** switch on the ignition.

The immobiliser prevents your vehicle from being started without the correct key.

When leaving the vehicle, always take the key with you and lock the vehicle. Anyone can start the engine if a valid key has been left inside the vehicle.

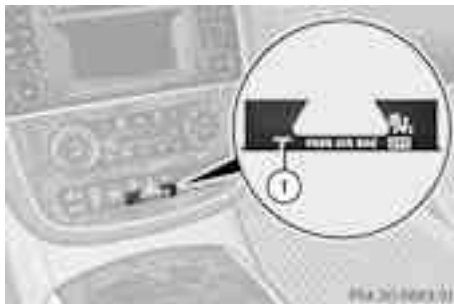

- i** The immobiliser is always deactivated when you start the engine.

ATA (Anti-Theft Alarm system)



- ▶ **To prime:** lock the vehicle with the key or KEYLESS-GO. Indicator lamp ① flashes. The alarm system is primed after approximately 10 seconds.
 - ▶ **To switch off with the key:** unlock the vehicle using the key.
- or
- ▶ Insert the key into the ignition lock.
 - ▶ **To switch off with KEYLESS-GO:** unlock the vehicle using KEYLESS-GO.
- or
- ▶ Press the Start/Stop button on the dashboard. The key must be inside the vehicle.

A visual and audible alarm is triggered if the alarm system is primed and you open:

- a door
 - the vehicle with the emergency key element
 - the tailgate
 - the bonnet
 - ▶ **To turn the alarm off with the key:** press the  or  button on the key. The alarm is switched off.
- or
- ▶ Insert the key into the ignition lock. The alarm is switched off.

- ▶ **To stop the alarm using KEYLESS-GO:** grasp the outside door handle. The key must be outside the vehicle. The alarm is switched off.

or

- ▶ Press the Start/Stop button on the dashboard. The key must be inside the vehicle. The alarm is switched off.

The alarm is not switched off, even if you close the open door that has triggered it, for example.

Tow-away protection

Function

An audible and visual alarm is triggered if your vehicle's angle of inclination is altered while tow-away protection is primed. This can occur if the vehicle is jacked up on one side, for example.

To activate

- ▶ Make sure that:
 - the doors are closed
 - the tailgate is closed
 Only then is the tow-away protection primed.
- ▶ Lock the vehicle with the key or KEYLESS-GO.

Tow-away protection is primed after approximately 30 seconds.

Deactivating

- ▶ **To switch off with the key:** unlock the vehicle using the key.
- or
- ▶ Insert the key into the ignition lock.

Tow-away protection is switched off automatically.

- ▶ **To switch off with KEYLESS-GO:** unlock the vehicle using KEYLESS-GO.



or

- ▶ Press the Start/Stop button on the dashboard. The key must be inside the vehicle. Tow-away protection is switched off automatically.

Deactivating

It is possible to switch off tow-away protection on the on-board computer for the next time the vehicle is locked (▷ page 207).

If you select **Tow-away protection** in the **Vehicle** submenu in the "Adjust display when ignition is switched off" function (▷ page 203), the **Tow-away protection on Switch off using +/-** message appears in the multifunction display.

You can then deactivate or prime tow-away protection by pressing the  or  button on the multifunction steering wheel.

- ▶ Press the  button on the multifunction steering wheel.

The **Tow-away protection off** message appears in the multifunction display.

If you press the  button, tow-away protection remains primed.
- ▶ Lock the vehicle with the key or, on vehicles with KEYLESS-GO, with the locking button on the door handle.

Tow-away protection remains deactivated until:

- the vehicle is unlocked again and
- a door is opened and closed again and
- the vehicle is locked again

To prevent a false alarm, deactivate the tow-away protection if you lock your vehicle and it:

- is being transported
- is being loaded onto a ferry or car transporter, for example
- is parked on a movable surface, e.g. in a split-level garage

Interior motion sensor

Function

When the interior motion sensor is primed, a visual and audible alarm is triggered if movement is detected in the vehicle interior. This can occur if someone reaches into the vehicle interior, for example.

Priming

- ▶ Make sure that:
 - the side windows are closed
 - the hinged side windows are closed
 - the sliding sunroof/panorama sliding sunroof is closed
 - there are no objects, e.g. mascots, hanging on the rear-view mirror or on the grab handles on the roof trim

This will prevent false alarms.

- ▶ Make sure that:
 - the sliding sunroof/panorama sliding sunroof is closed
 - the doors are closed
 - the tailgate is closed
 Only then is the interior motion sensor primed.
- ▶ Lock the vehicle with the key or KEYLESS-GO.

The interior motion sensor is primed after approximately 40 seconds.

Deactivating

- ▶ **To switch off with the key:** unlock the vehicle using the key.
- or
- ▶ Insert the key into the ignition lock.

The interior motion sensor is switched off automatically.

- ▶ **To switch off with KEYLESS-GO:** unlock the vehicle using KEYLESS-GO.

or

- ▶ Press the Start/Stop button on the dashboard. The key must be inside the vehicle. The interior motion sensor is switched off automatically.

Deactivating

It is possible to deactivate the interior motion sensor using the on-board computer for the next time the vehicle is locked (▷ page 207).

If you select **Interior motion sensor** for the "Adjust display when ignition is switched off" function (▷ page 203) in the **Vehicle** submenu, the **Interior motion sensor on Switch off using + / -** message appears in the multifunction display after the ignition is switched off.

- ▶ Press the  button on the multifunction steering wheel.

The **Interior motion sensor off** message appears in the multifunction display. If you press the  button, the interior motion sensor remains primed.
- ▶ Lock the vehicle with the key or, on vehicles with KEYLESS-GO, with the locking button on the door handle.

The interior motion sensor remains deactivated until:

- the vehicle is unlocked again and
- a door is opened and closed again and
- the vehicle is locked again

To prevent a false alarm, deactivate the interior motion sensor if you lock your vehicle and:

- people or animals remain in the vehicle
- the side windows remain open
- a hinged side window remains open
- the sliding sunroof/panorama sliding sunroof remains open

Useful information	70
Key	70
Doors	76
Luggage compartment	78
Side windows	81
Sliding sunroof	85

Useful information

- i** This Owner's Manual describes all models, series and optional equipment for your vehicle that were available at the time of going to press. National variations are possible. Note that your vehicle may not be equipped with all of the functions described. This is also the case for systems and functions relevant to safety.
- i** Read the information on qualified specialist workshops: (▷ page 23).

Key

Important safety notes

WARNING

If children are left unsupervised in the vehicle, they could:

- open a door from inside the vehicle at any time, even if it has been locked
- start the vehicle using a key which has been left in the vehicle
- release the parking brake

They could thereby endanger themselves and others. Never leave children unsupervised in the vehicle. Always take the key with you when leaving the vehicle, even if you are only leaving it for a short time.

WARNING

If a key ring is too heavy or too large, the weight acting on the key could cause it to turn in the ignition lock or catch on the steering wheel. This could cause the engine to be switched off suddenly. You may lose control of the vehicle and cause an accident. Do not



attach any heavy or large key rings to the key that is inserted in the ignition.

- Do not keep the key:
 - with electronic devices, e.g. a mobile phone or another key
 - with metallic objects, e.g. coins or metal foil
 - inside metallic objects, e.g. a metal case
 This can affect the key's functionality.

Do not keep the KEYLESS-GO key in the temperature-controlled cup holder. Otherwise, the KEYLESS-GO key will not be recognised. Keep the key away from strong magnetic fields. Otherwise, the remote control function could be affected.

Key functions



- ①  To lock the vehicle
- ②  To open/close the tailgate
- ③  To unlock the vehicle

► **To unlock centrally:** press the  button.

If you do not open the vehicle within approximately 40 seconds of unlocking:

- the vehicle is locked again.
- the anti-theft system is primed again.

► **To lock centrally:** press the  button.

The key centrally locks/unlocks:

- the doors
- the tailgate
- the fuel filler flap

When unlocking, the turn signals flash once. When locking, they flash three times.

If you activate the audible locking confirmation function you will hear the following, depending on the date of production of the vehicle:

- an audible signal when locking
or
- one audible signal when unlocking and three when locking

The audible signal can be activated and deactivated using the on-board computer (▷ page 204).

When it is dark, the surround lighting also comes on if it is activated in the on-board computer (▷ page 202).

KEYLESS-GO

General notes

Bear in mind that the engine can be started by any of the vehicle occupants if there is a KEYLESS-GO key in the vehicle.

Locking and unlocking centrally



You can start, lock or unlock the vehicle using KEYLESS-GO. To do this, you only need carry the key with you. When you touch the surface of the sensors on the vehicle's outside door handles, KEYLESS-GO establishes a radio connection between the vehicle and the key. When the engine is started and whilst you are driving, KEYLESS-GO also checks whether a valid key is in the vehicle by periodically establishing radio contact.

You can combine the KEYLESS-GO functions with the functions of a conventional key. Unlock the vehicle by using KEYLESS-GO, for

instance, and lock it using the  button on the key.

When locking or unlocking with KEYLESS-GO, the distance between the key and the corresponding door handle must not be greater than 1 m.





- ▶ **To unlock the vehicle:** touch the inner surface of the door handle.
- ▶ **To lock the vehicle:** press locking button .
- ▶ **Convenience closing feature:** press locking button  for an extended period.

If you pull on the handle of the tailgate, only the luggage compartment of the vehicle is unlocked.



If the vehicle has been parked for a long time, the sensor surfaces are deactivated automatically. In order to unlock the door, pull the door handle. In order to reactivate the sensor surface, switch the ignition on again.

Changing the settings of the locking system

You can change the settings of the locking system. This means only the driver's door and the fuel filler flap are unlocked when the vehicle is unlocked. This is useful if you frequently travel on your own.



- ▶ **To change the setting:** press and hold down the  and  buttons simultaneously for approximately six seconds until

the battery check lamp flashes twice (▷ page 73).



i If the setting of the locking system is changed within the signal range of the vehicle, pressing the  or  button:

- locks or
- unlocks the vehicle

The key now functions as follows:

- ▶ **To unlock the driver's door:** press the  button once.
- ▶ **To unlock centrally:** press the  button twice.
- ▶ **To lock centrally:** press the  button.

The KEYLESS-GO function is changed as follows:

- ▶ **To unlock the driver's door:** touch the inner surface of the door handle on the driver's door.
- ▶ **To unlock centrally:** touch the inner surface of the door handle on the front-passenger door or the rear door.
- ▶ **To lock centrally:** press the locking button on one of the door handles.
- ▶ **To restore the factory settings:** press and hold down the  and  buttons simultaneously for approximately six seconds until the battery check lamp flashes twice (▷ page 73).



Emergency key element

General notes

If the vehicle can no longer be unlocked with the key, use the emergency key element.

If you use the emergency key element to unlock and open the driver's door, the anti-theft alarm system will be triggered (▷ page 66).

There are several ways to turn off the alarm:

- ▶ **To turn the alarm off with the key:** press the  or  button on the key.
- or
- ▶ Insert the key into the ignition lock.
- or
- ▶ **To deactivate the alarm with KEYLESS-GO:** press the Start/Stop button in the ignition lock. The key must be in the vehicle.
- or
- ▶ Lock or unlock the vehicle using KEYLESS-GO. The key must be outside the vehicle.

If you unlock the vehicle using the emergency key element, the fuel filler flap will not be unlocked automatically.

- ▶ **To unlock the fuel filler flap:** insert the key into the ignition lock.

Removing the emergency key element



- ▶ Push release catch ① in the direction of the arrow and at the same time, remove emergency key element ② from the key.

Battery of the key

Important safety notes

WARNING

Batteries are toxic and contain caustic substances. For this reason, keep batteries out of the reach of children.

If a battery has been swallowed, visit a doctor immediately.

Environmental note



Batteries contain pollutants. It is illegal to dispose of them with the household rubbish. They must be collected separately and disposed of in an environmentally responsible recycling system.







Dispose of batteries in an environmentally responsible manner. Take discharged batteries to a qualified specialist workshop or to a collection point for used batteries.

Mercedes-Benz recommends that you have the batteries replaced at a qualified specialist workshop.

Checking the battery



- ▶ Press the  or  button. The battery is working properly if battery check lamp ① lights up briefly. The battery is discharged if battery check lamp ① does not light up briefly.
- ▶ Change the battery (▷ page 73).

- ❗ If the key battery is checked within the signal reception range of the vehicle, pressing the  or  button:

- locks or
- unlocks the vehicle

- ❗ You can get a battery in any qualified specialist workshop.

Replacing the battery

You require a CR 2025 3 V cell battery.







- ▶ Take the emergency key element out of the key (▷ page 72).



- ▶ Press emergency key element ② into the opening in the key in the direction of the arrow until battery compartment cover ① opens. When doing so, do not hold battery compartment cover ① shut.
- ▶ Remove battery compartment cover ①.



- ▶ Repeatedly tap the key against your palm until battery ③ falls out.
- ▶ Insert the new battery with the positive terminal facing upwards. Use a lint-free cloth to do so.
- ▶ Make sure that the surface of the battery is free from lint, grease and all other forms of contamination.
- ▶ Insert the front tabs of battery compartment cover ① into the housing and then press to close it.
- ▶ Insert emergency key element ② into the key.
- ▶ Check the function of all key buttons on the vehicle.

Problems with the key	
Problem	Possible causes/consequences and ► Solutions
You cannot lock or unlock the vehicle using the key.	<p>The key battery is discharged or nearly discharged.</p> <ul style="list-style-type: none"> ► Try again to lock/unlock the vehicle using the remote control function of the key. Point the tip of the key at the driver's door handle from close range and press the  or  button. <p>If this does not work:</p> <ul style="list-style-type: none"> ► Check the key battery (▷ page 73) and replace it if necessary (▷ page 73). ► Lock (▷ page 78) or unlock (▷ page 77) the vehicle using the emergency key element.
	<p>The key is faulty.</p> <ul style="list-style-type: none"> ► Lock (▷ page 78) or unlock (▷ page 77) the vehicle using the emergency key element. ► Have the key checked at a qualified specialist workshop.
You can no longer lock or unlock the vehicle using KEYLESS-GO.	<p>KEYLESS-GO is in standby mode because the vehicle has not been unlocked for an extended period.</p> <ul style="list-style-type: none"> ► Pull the door handle twice and then insert the key into the ignition lock.
	<p>There is interference from a powerful source of radio waves.</p> <ul style="list-style-type: none"> ► Lock/unlock the vehicle using the remote control function of the key. Point the tip of the key at the driver's door handle from close range and press the  /  button.
	<p>There is a fault with KEYLESS-GO.</p> <ul style="list-style-type: none"> ► Lock/unlock the vehicle using the remote control function of the key. Point the tip of the key at the driver's door handle from close range and press the  /  button. ► Have KEYLESS-GO checked at a qualified specialist workshop. <p>If this does not work:</p> <ul style="list-style-type: none"> ► Check the key battery (▷ page 73) and replace it if necessary (▷ page 73). ► Lock (▷ page 78) or unlock (▷ page 77) the vehicle using the emergency key element.
You have lost a key.	<ul style="list-style-type: none"> ► Have the key deactivated at a qualified specialist workshop. ► Report the loss immediately to the vehicle insurers. ► If necessary, have the locks changed as well.

Problem	Possible causes/consequences and ► Solutions
You have lost the emergency key element.	<ul style="list-style-type: none"> ► Report the loss immediately to the vehicle insurers. ► If necessary, have the locks changed as well.
The engine cannot be started using the key.	<p>The on-board voltage is too low.</p> <ul style="list-style-type: none"> ► Switch off non-essential consumers, e.g. seat heating or interior lighting, and try to start the engine again. <p>If this does not work:</p> <ul style="list-style-type: none"> ► Check the starter battery and charge it if necessary (> page 303). <p>or</p> <ul style="list-style-type: none"> ► Jump-start the vehicle (> page 304). <p>or</p> <ul style="list-style-type: none"> ► Consult a qualified specialist workshop.
The engine cannot be started using KEYLESS-GO. The key is in the vehicle.	<p>A door is open. Therefore, the key cannot be detected as easily.</p> <ul style="list-style-type: none"> ► Close the door and try to start the vehicle again.
	<p>There is interference from a powerful source of radio waves.</p> <ul style="list-style-type: none"> ► Start your vehicle with the key in the ignition lock.

Doors

Important safety notes

WARNING

If children are left unsupervised in the vehicle, they could:

- open a door from inside the vehicle at any time, even if it has been locked
- start the vehicle using a key which has been left in the vehicle
- release the parking brake

They could thereby endanger themselves and others. Never leave children unsupervised in the vehicle. Always take the key with you when leaving the vehicle, even if you are only leaving it for a short time.

Unlocking and opening the doors from the inside

You can open a door from inside the vehicle even if it has been locked. You can only open the rear doors from inside the vehicle if they are not secured by the child-proof locks (> page 61).

If the vehicle has previously been locked with the key or with KEYLESS-GO, opening a door from the inside will trigger the anti-theft alarm system. Switch off the alarm (> page 66).

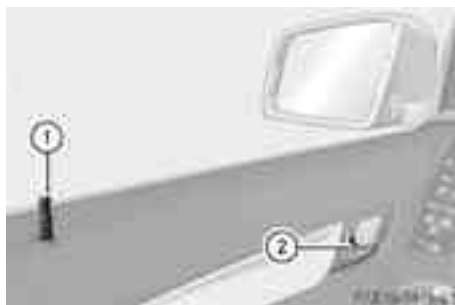

- ▶ Pull door handle ②.

If the door is locked, locking knob ① pops up. The door is unlocked and can be opened.

Centrally locking and unlocking the vehicle from the inside

You can centrally lock or unlock the vehicle from the inside. The buttons are located on both front doors.

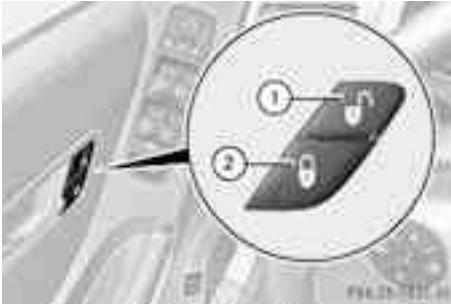

- ▶ **To unlock:** press button ①.

- ▶ **To lock:** press button ②.

If the front-passenger door is closed, the vehicle locks.

You cannot unlock the vehicle centrally from the inside if the vehicle has been locked with the key or KEYLESS-GO.

The central locking/unlocking button does not lock or unlock the fuel filler flap.

For all countries except the United Kingdom: you can open a door from inside the vehicle even if it has been locked.

Only for the United Kingdom: if the vehicle has been locked with the key or with KEYLESS-GO, the double lock function is activated as standard. It is then not possible to open the doors from inside the vehicle. Deactivate the interior motion sensor (> page 68) before you lock the vehicle. The doors can then be opened from the inside after the vehicle has been locked from the outside.

If the vehicle has been locked using the locking button for the central locking, or has been locked automatically, and a door is opened from the inside:

- the vehicle will be fully unlocked if it had previously been fully unlocked.
- only the door which has been opened from the inside is unlocked if only the driver's door had been previously unlocked.

Automatic locking feature

The vehicle is locked automatically when the ignition is switched on and the wheels are turning.

You could therefore be locked out if:

- the vehicle is being pushed.
- the vehicle is being towed.
- the vehicle is being tested on a dynamometer.

You can switch the automatic locking function on and off using the on-board computer (> page 204).

Unlocking the driver's door (emergency key element)

If the vehicle can no longer be unlocked with the key, use the emergency key element.

If you use the emergency key element to unlock and open the driver's door, the anti-theft alarm system will be triggered (> page 66).

- ▶ Take the emergency key element out of the key (> page 72).
- ▶ Insert the emergency key element into the lock of the driver's door as far as it will go.



- ▶ Turn the emergency key element anti-clockwise as far as it will go to position **1** and hold it in this position.
- i** On right-hand-drive vehicles, turn the emergency key element clockwise.
- ▶ Pull the door handle beyond the first resistance.
The locking knob pops up.
The door is unlocked.
- ▶ Turn the emergency key element back and remove it.
- ▶ Pull the door handle again.
- ▶ Insert the emergency key element into the key.

Locking the vehicle

If the vehicle can no longer be locked with the key, you can lock it by taking the following steps.

- ▶ Close the front-passenger door, the rear door on the front-passenger side and the tailgate.
- ▶ Open the driver's door and the rear door on the driver's side.
- ▶ Press the locking button on the driver's door (▷ page 77).
The locking knobs in the front-passenger door and in the rear doors drop down.
- ▶ Press down the locking knobs in the front-passenger and rear doors manually, if necessary (▷ page 76).
- ▶ Close the driver's door from the outside.

- ▶ Press down the locking knob of the driver's door by reaching in through the open rear door.
- i** Make sure that you have the key on your person and that it has not been left in the vehicle.
- ▶ Close the rear door on the driver's side.
- ▶ Make sure that the doors and the tailgate are locked.
- i** If you lock the vehicle as described above, the fuel filler flap is not locked. The anti-theft alarm system is not primed.

Luggage compartment

Important safety notes

⚠ WARNING

If the engine is running and the tailgate is open, exhaust gases can enter the vehicle interior. This could result in poisoning. Therefore, make sure that the tailgate is always closed when the engine is running.

- !** The tailgate swings upwards and to the rear when opened. Therefore, make sure that there is sufficient clearance above and behind the tailgate.

- i** Tailgate opening dimensions (▷ page 346).

Do not leave the key in the luggage compartment. You could otherwise lock yourself out.

Vehicles without the EASY-PACK tailgate: the tailgate can be:

- opened and closed manually from outside
- opened manually from inside

For vehicles with the EASY-PACK tailgate you can:

- close the tailgate manually from outside
- open and close the tailgate automatically from outside
- open and close the tailgate automatically from inside

- open the tailgate manually from inside
- limit the opening angle of the tailgate

Opening/closing from the outside

Opening



- ▶ Press the  button on the key.
- ▶ Pull handle ①.
- ▶ Raise the tailgate.

Vehicles with the EASY-PACK tailgate: if you pull handle ① and then release it, the tailgate opens automatically.

Closing

WARNING

Make sure that nobody can become trapped as you close the tailgate.



- ▶ Pull the tailgate down using recess ①.
- ▶ Allow the tailgate to drop into the lock.
- ▶ Lock the vehicle if necessary with the  button on the key or with KEYLESS-GO.

i If a KEYLESS-GO key is detected in the luggage compartment, the tailgate will not lock.

Opening/closing automatically from the outside

Important safety notes

WARNING

Monitor the tailgate opening and closing procedures to make sure that nobody can become trapped. To stop the opening or closing procedure, press the closing button on the tailgate again or pull the handle on the outside of the tailgate.

! The tailgate swings upwards and to the rear when opened. Therefore, make sure that there is sufficient clearance above and behind the tailgate.

i Tailgate opening dimensions (▷ page 346).

Opening the tailgate automatically

You can open the tailgate automatically with the key or the handle in the tailgate.

- ▶ Press and hold the  button on the key until the tailgate opens.

or

- ▶ If the tailgate is unlocked, pull the handle and let it go again immediately.

Closing the tailgate automatically



Closing button and locking button (example: vehicle with the EASY-PACK tailgate and KEYLESS-GO)

► **To close:** press closing button ① on the tailgate.

or

► Press and hold the  button on the key until the tailgate closes.

Vehicles with the EASY-PACK system tailgate and KEYLESS-GO: you can simultaneously close and lock the tailgate.

► Press locking button ② on the tailgate.
If a KEYLESS-GO key is detected outside the vehicle, the tailgate closes and locks.

i In order to open and close the tailgate, the key must be not be inserted in the ignition lock.

If the tailgate touches an object while closing, the closing procedure is interrupted and the tailgate reopens.

i If a KEYLESS-GO key is detected in the luggage compartment, the tailgate will not lock.

Opening/closing automatically from the inside

Important safety notes

WARNING

Monitor the tailgate opening and closing procedures to make sure that nobody can become trapped. To halt the opening or clos-

ing procedure, press or pull the tailgate's remote operating button from the driver's seat again.

! The tailgate swings upwards and to the rear when opened. Therefore, make sure that there is sufficient clearance above and behind the tailgate.

i Tailgate opening dimensions
(▷ page 346).

Opening and closing



You can open and close the tailgate from the driver's seat when the vehicle is stationary and unlocked.

► **To open:** pull remote operating switch ① for the tailgate until the tailgate opens.

► **To close:** turn the key to position 1 or 2 in the ignition lock.

► Press remote operating switch for tailgate ① until the tailgate closes.

i If the tailgate touches an object while closing, the closing procedure is interrupted and the tailgate reopens.

Opening the tailgate from inside the vehicle

Important safety notes

! The tailgate swings upwards and to the rear when opened. Therefore, make sure that there is sufficient clearance above and behind the tailgate.

- i** Tailgate opening dimensions (▷ page 346).

To open

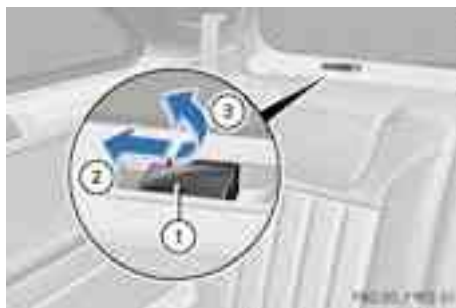

You can unlock and open the tailgate from inside the vehicle.

- ▶ Press handle ① in the direction of arrow ② as far as it will go and hold it there.
- ▶ From this position, pull handle ① in the direction of arrow ③ as far as it will go and hold it there.
- ▶ Lift the tailgate upwards.

- i** Vehicles with the EASY-PACK tailgate:
If you do not open the tailgate after unlocking, it will lock again automatically after a few seconds.

Limiting the opening angle of the tailgate

Important safety notes

- !** Make sure there is sufficient clearance to open the tailgate fully when setting the opening angle. The tailgate could otherwise be damaged. Ideally, set the opening angle outside.

Activating

You can limit the opening angle of the tailgate in the top half of its opening range.

This could be useful, for example, if there is insufficient space above the tailgate.

- ▶ **To open the tailgate:** pull the handle on the tailgate.
- ▶ **To stop the opening procedure at the desired position:** press the closing button (▷ page 79) in the tailgate or pull the handle on the outside of the tailgate again.
- ▶ **To store the position:** press and hold the closing button in the tailgate until you hear a short tone.
The opening angle limiter is activated. The tailgate then stops in the stored position when opened.

Switching off

- ▶ Press and hold the closing button (▷ page 79) in the tailgate until you hear two short tones.

Side windows

Important safety notes

⚠ WARNING

Make sure that nobody can become trapped between the side window and the door frame when a side window is opened. Do not touch or lean against the side window during the opening procedure. You could become trapped between the side window and the door frame as the side window moves down. If there is a risk of becoming trapped, release the switch or pull the switch upwards to close the side window again.

⚠ WARNING

Make sure that nobody can become trapped as you close a side window. If there is a risk of becoming trapped, release the switch or press it again to open the side window again.

⚠ WARNING

Children may injure themselves if they open or close the side windows.

Never leave children unsupervised in the vehicle. Always take the key with you when leaving

the vehicle, even if you are only leaving it for a short time.

WARNING

Do not leave children unsupervised in the vehicle, even if they are secured in a child restraint system. The children could:

- be seriously or even fatally injured on parts of the vehicle
- be seriously or even fatally injured by prolonged exposure to extremely high or extremely low temperatures

If children open a door, they could:

- seriously or even fatally injure other people
- get out of the vehicle and injure themselves, or be seriously or even fatally injured by a passing vehicle

Activate the child-proof locks/override feature if children are travelling in the vehicle. They could otherwise open doors or side windows while the vehicle is in motion and thereby injure themselves or others.

Opening and closing the side windows

The switches for all side windows are located on the driver's door. There is also a switch on each door for the corresponding side window. The switches on the driver's door take precedence.



- ① Front left
- ② Front right

- ③ Rear right
- ④ Rear left

► Turn the key to position **1** or **2** in the ignition lock.

► **To open:** press the corresponding switch.

► **To close:** pull the corresponding switch.

i If you press the switch beyond the point of resistance, an automatic opening/closing process is started in the corresponding direction. You can stop automatic operation by pressing again.

i You can continue to operate the side windows after switching off the engine or removing the key. This function remains active for five minutes or until the driver's or front-passenger door is opened.

i The side windows cannot be operated from the rear when the override feature for the side windows is activated (► page 61).

Opening and closing the hinged side windows

Important safety notes

WARNING

Make sure that nobody can become trapped as you close the hinged side windows. If there is a risk of becoming trapped, release the switch or push the switch again to reopen the side window.

Opening and closing

The hinged side windows are operated electrically from the driver's seat.



- ▶ Make sure that the key is in position **1** or **2** in the ignition lock.
 - ▶ **To open fully:** press switch **①** and release.
 - ▶ **To close fully:** pull switch **①** and release.
 - ▶ **To stop the closing procedure:** press switch **①** again.
Both hinged side windows open fully.
- i** If the hinged side windows are blocked when closing, the closing procedure is interrupted and the hinged side windows open again fully.



Convenience opening feature

General notes

You can ventilate the vehicle before you start driving. To do this, the key is used to carry out the following functions simultaneously:

- unlock the vehicle
 - open the side windows
 - open the hinged side windows
 - open the sliding sunroof or the panorama sliding sunroof and the roller sunblinds
 - switch on the seat ventilation for the driver's seat
- i** The convenience opening feature can only be operated using the key. The key must be close to the driver's door handle.

Convenience opening feature

- ▶ Point the tip of the key at the driver's door handle.
- ▶ Press and hold the  button until the side windows and the sliding sunroof or the panorama sliding sunroof are in the desired position.
If the roller sunblinds of the panorama sliding sunroof are closed, the roller sunblinds are opened first.
- ▶ Press and hold the  button again until the panorama sliding sunroof is in the desired position.
- ▶ **To interrupt convenience opening:** release the  button.



Convenience closing feature

Important safety notes

WARNING

When using the convenience closing feature, make sure that nobody can become trapped. Proceed as follows if there is a risk of entrapment:

With the key:

- release the  button.
- press and hold the  button until the side windows and the sliding sunroof or the panorama sliding sunroof open again.

With KEYLESS-GO:

- release the locking button on the door handle.
- pull the door handle immediately and hold it.

The side windows and the sliding sunroof or the panorama sliding sunroof open.

When you lock the vehicle, you can simultaneously:

- close the side windows
- close the hinged side windows
- close the sliding sunroof or the panorama sliding sunroof



On vehicles with a panorama sliding sunroof, you can then close the roller sunblinds.

Using the key

The key must be close to the driver's door handle.

- ▶ Point the tip of the key at the driver's door handle.
- ▶ Press and hold the  button until the side windows and the sliding sunroof or the panorama sliding sunroof are fully closed.
- ▶ Make sure that all the side windows and the sliding sunroof or panorama sliding sunroof are closed.

On vehicles with a panorama sliding sunroof:

- ▶ Press and hold the  button again until the roller sunblinds of the panorama sliding sunroof close.
- ▶ **To interrupt convenience closing:** release the  button.

Using KEYLESS-GO

The KEYLESS-GO key must be outside the vehicle. All the doors must be closed.

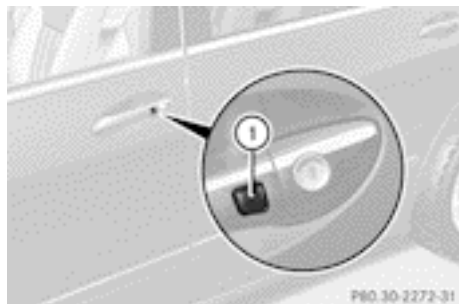

- ▶ Keep locking button ① on the door handle pressed until the side windows and the slid-

ing sunroof or panorama sliding sunroof are fully closed.

- ▶ Make sure that all the side windows and the sliding sunroof or panorama sliding sunroof are closed.

On vehicles with a panorama sliding sunroof:

- ▶ Press and hold locking button ① again until the roller sunblinds of the panorama sliding sunroof close.
- ▶ **To interrupt convenience closing:** release locking button ① on the door handle.

Resetting the side windows

- ▶ Close all doors.
- ▶ Turn the key to position **1** or **2** in the ignition lock.
- ▶ Pull the corresponding switch on the door control panel until the side window is completely closed. (▶ page 82)
- ▶ Hold the switch for an additional second.

If the side window opens again slightly:

- ▶ Immediately pull the corresponding switch on the door control panel until the side window is completely closed (▶ page 82).
- ▶ Hold the switch for an additional second.
- ▶ If the corresponding side window remains closed after the button has been released, the side window has been reset correctly. If this is not the case, repeat the steps above again.

You must reset each side window if:

- the battery has been disconnected or has become discharged.
- the side window opens again slightly after being closed fully.
- the side window can no longer be fully opened or closed.

Problems with the side windows

WARNING

Closing the side windows with increased force or without the anti-entrapment feature could lead to serious or even fatal injury. Make sure that nobody can become trapped when closing the side windows.

Problem	Possible causes/consequences and ► Solutions
A side window cannot be closed because it is blocked by objects, e.g. leaves in the window guide.	<ul style="list-style-type: none"> ► Remove the objects. ► Close the side window.
A side window cannot be closed and you cannot see the cause.	<p>If a side window is obstructed during closing and reopens again slightly:</p> <ul style="list-style-type: none"> ► Immediately after the window blocks, pull the corresponding switch again until the side window has closed. The side window is closed with increased force. <p>If a side window is obstructed again during closing and reopens again slightly:</p> <ul style="list-style-type: none"> ► Immediately after the window blocks, pull the corresponding switch again until the side window has closed. The side window is closed without the anti-entrapment feature.

Sliding sunroof

Important safety notes

WARNING

Make sure that nobody can become trapped when opening and closing the sliding sunroof.

If there is a risk of entrapment, release the switch immediately. During automatic operation, push the switch briefly in any direction to stop the sliding sunroof.

WARNING

The glass in the panorama sunroof could break in an accident. If you are not wearing a seat belt, there is a risk that you could be thrown through the opening in the event of the vehicle overturning. Therefore, always wear a seat belt to reduce the risk of injuries.

WARNING

Children could injure themselves if they operate the sliding sunroof.

Never leave children unsupervised in the vehicle. Always take the key with you when leaving the vehicle, even if you are only leaving it for a short time.

! Only open the panorama sliding sunroof if it is free of snow and ice. Otherwise, malfunctions may occur.

Do not allow anything to protrude from the sliding sunroof. Otherwise, the seals could be damaged.

i Resonance noises can occur in addition to the usual airflow noises when the sliding sunroof is open. They are caused by minor pressure fluctuations in the vehicle interior.

To reduce or eliminate these noises:

- change the position of the sliding sunroof.
- open a side window.
- open the panorama sliding sunroof to the comfort setting.

Your vehicle may be fitted with a sliding sunroof or a panorama sliding sunroof. In this section, the term "sliding sunroof" refers to both types of sliding sunroof.

Operating the sliding sunroof

Opening and closing

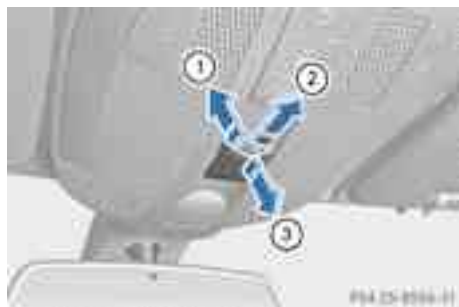

Overhead control panel

- ① To raise
 - ② To open
 - ③ To close/lower
- ▶ Turn the key to position **1** or **2** in the ignition lock.
- ▶ Press or pull the switch in the corresponding direction.
- i** If you press the switch beyond the point of resistance, an automatic opening/closing process is started in the corresponding direction. You can stop automatic operation by pressing again.

The sun protection cover automatically opens along with the sliding sunroof. You can open or close the sun protection cover manually when the sliding sunroof is raised or closed.

- i** You can continue to operate the sliding sunroof after switching off the engine or

removing the key. This function remains active for five minutes or until the driver's or front-passenger door is opened.

Rain-closing feature

The sliding sunroof closes automatically:

- if it starts to rain
- at extreme outside temperatures
- after six hours
- if there is a malfunction in the power supply

The rear of the sliding sunroof is then raised in order to ventilate the vehicle interior.

- i** If the sliding sunroof is obstructed while being closed by the rain-closing feature, it opens again slightly. The rain-closing feature is then deactivated.

The sliding sunroof does not close if:

- it is raised at the rear.
- it is blocked.
- no rain is falling on the area of the wind-screen being monitored by the rain sensor (e.g. because the vehicle is under a bridge or in a carport).

Resetting

- !** If the sliding sunroof still cannot be opened or closed fully after resetting, contact a qualified specialist workshop.

Reset the sliding sunroof if it does not move smoothly, or if the battery has been disconnected or has become discharged.

- ▶ Turn the key to position **0** in the ignition lock.
- ▶ Remove the fuse for the sliding sunroof from the fuse box. To find out where the fuse is located, refer to the fuse allocation chart in the vehicle tool kit (▷ page 293).
- ▶ Reinsert the fuse.
- ▶ Turn the key to position **2** in the ignition lock.
- ▶ Raise the sliding sunroof fully at the rear (▷ page 86).

- ▶ Keep the  switch pressed for another second.
- ▶ Make sure that the sliding sunroof can be fully opened and closed again (▷ page 86).
- ▶ If this is not the case, repeat the steps above again.

Operating the panorama sliding sunroof



Opening and closing



Overhead control panel

- ① To raise
- ② To open
- ③ To close/lower

The panorama sliding sunroof can only be operated when the roller sunblind is open (▷ page 88).

- ▶ Turn the key to position **1** or **2** in the ignition lock.
- ▶ Press or pull the  switch in the corresponding direction.
- ❗ If you press the  switch beyond the point of resistance, an automatic opening/closing process is started in the corresponding direction. You can stop automatic operation by pressing again.

The automatic opening feature is available only when the sliding sunroof is closed.

Rain-closing feature

If the key is in position **0** in the ignition lock or if it is removed, the panorama sliding sunroof closes automatically:

- if it starts to rain
- at extreme outside temperatures
- after six hours
- if there is a malfunction in the power supply

The panorama sliding sunroof remains raised at the rear in order to allow ventilation of the vehicle interior.

- ❗ If the panorama sliding sunroof is obstructed while being closed by the rain-closing feature, it opens again slightly. The rain-closing feature is then deactivated.

The panorama sliding sunroof does not close if:

- it is raised at the rear.
- it is blocked.
- no rain is falling on the area of the wind-screen being monitored by the rain sensor (e.g. because the vehicle is under a bridge or in a carport).

Operating the panorama sliding sunroof roller sunblinds

Important safety notes

WARNING

Make sure that nobody can become trapped as you open or close the roller sunblinds.

The roller sunblinds shield the vehicle interior from sunlight. The two roller sunblinds can only be opened and closed together when the panorama sliding sunroof is closed.

Opening and closing the roller sunblinds

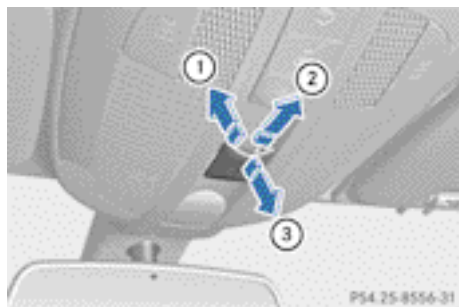

Overhead control panel

- ① To open
- ② To open
- ③ To close

- ▶ Turn the key to position **1** or **2** in the ignition lock.
- ▶ Press or pull the switch in the corresponding direction.

i When opening the roller sunblinds, you can initiate automatic operation. To do so, press the switch briefly beyond the point of resistance in the direction of arrow **②**. Operate the switch again to stop the automatic opening process.

Resetting the panorama sliding sunroof and the roller sunblinds

! If the panorama sliding sunroof and the roller sunblind cannot be fully opened or closed after resetting, contact a qualified specialist workshop.

Reset the panorama sliding sunroof and the roller sunblinds if the panorama sliding sunroof or the roller sunblinds do not move smoothly.

- ▶ Turn the key to position **1** or **2** in the ignition lock.
- ▶ Pull the switch repeatedly to the point of resistance in the direction of arrow **③** until the panorama sliding sunroof is fully closed.



- ▶ Keep the switch pulled for an additional second.
- ▶ Pull the switch repeatedly to the point of resistance in the direction of arrow **③** until the roller sunblinds are fully closed.
- ▶ Keep the switch pulled for an additional second.
- ▶ Make sure that the panorama sliding sunroof (▷ page 87) and the roller sunblinds (▷ page 88) can be fully opened again.
- ▶ If this is not the case, repeat the steps above again.

Problems with the sliding sunroof

WARNING

You could be severely or even fatally injured when closing the sliding sunroof with increased closing force or if the anti-entrapment feature is deactivated. Make sure that nobody can become trapped when closing the sliding sunroof.

Your vehicle may be fitted with a sliding sunroof or a panorama sliding sunroof. In this section, the term "sliding sunroof" refers to both types of sliding sunroof.

Problem	Possible causes/consequences and ► Solutions
<p>The sliding sunroof cannot be closed and you cannot see the cause.</p>	<p>If the sliding sunroof is obstructed during closing and reopens again slightly:</p> <ul style="list-style-type: none"> ► Immediately after the sliding sunroof blocks, pull the  switch in the overhead control panel down to the point of resistance and hold it until the sliding sunroof is closed. The sliding sunroof is closed with increased force. <p>If the sliding sunroof is obstructed again during closing and reopens again slightly:</p> <ul style="list-style-type: none"> ► Immediately after the sliding sunroof blocks, pull the  switch in the overhead control panel down to the point of resistance and hold it until the sliding sunroof is closed. The sliding sunroof is closed without the anti-entrapment feature.

Useful information	92
Correct driver's seat position	92
Seats	93
Steering wheel	103
Mirrors	105
Memory function	108

Useful information

i This Owner's Manual describes all models, series and optional equipment for your vehicle that were available at the time of going to press. National variations are possible. Note that your vehicle may not be equipped with all of the functions described. This is also the case for systems and functions relevant to safety.

i Read the information on qualified specialist workshops: (▷ page 23).

Correct driver's seat position



- ▶ Observe the safety guidelines on seat adjustment (▷ page 93).
- ▶ Make sure that seat ③ is adjusted properly.
Manual and electrical seat adjustment (▷ page 94)
Electrical seat adjustment (▷ page 94)

When adjusting the seat, make sure that:

- you are as far away from the driver's airbag as possible.
- you are sitting in a normal upright position.

- you can fasten the seat belt properly.
 - you have moved the backrest to an almost vertical position.
 - you have set the seat angle so that your thighs are gently supported.
 - you can depress the pedals properly.
- ▶ Check whether the head restraint is adjusted properly.

When doing so, make sure that you have adjusted the head restraint so that the back of your head is supported at eye level by the centre of the head restraint.

- ▶ Observe the safety guidelines on steering wheel adjustment (▷ page 103).
- ▶ Make sure that steering wheel ① is adjusted properly.
Adjusting the steering wheel manually (▷ page 103)
Adjusting the steering wheel electrically (▷ page 104)

When adjusting the steering wheel, make sure that:

- you can hold the steering wheel with your arms slightly bent.
 - you can move your legs freely.
 - you can see all the displays in the instrument cluster clearly.
- ▶ Observe the safety guidelines for seat belts (▷ page 47).
- ▶ Check whether you have fastened seat belt ② properly (▷ page 48).

The seat belt should:

- fit snugly across your body
 - be routed across the middle of your shoulder
 - be routed in your pelvic area across the hip joints
- ▶ Before starting off, adjust the rear-view mirror and the exterior mirrors in such a way that you have a good view of road and traffic conditions (▷ page 105).
- ▶ **Vehicles with a memory function:** save the seat, steering wheel and exterior mirror

settings with the memory function
(▷ page 108).

Seats

Important safety notes

WARNING

The seats can still be adjusted when there is no key in the ignition lock. For this reason, children should never be left unsupervised in the vehicle. They could adjust the seats and become trapped.

WARNING

Only adjust the driver's seat when the vehicle is stationary. You will otherwise be distracted from the road and traffic conditions and you could lose control of the vehicle as a result of the seat moving. This could cause an accident.

WARNING

If you adjust the seat height carelessly, you or others could be trapped and thereby injured. Children in particular could unintentionally press the buttons to electrically adjust the seats and become trapped.

Take care that:

- while moving the seats, your hands do not get under the lever assembly of the seat adjustment system.
- children in the vehicle do not slide their hands under the levers.

WARNING

Make sure that nobody can become trapped when adjusting the seats.

Observe the notes on airbags.

Secure children as recommended; see the "Children in the vehicle" section.

WARNING

Make sure that the back of your head is supported at eye level by the central area of the

head restraint. If your head is not supported correctly by the head restraint, you could suffer a severe neck injury in the event of an accident. Never drive if the head restraints are not engaged and set correctly.

WARNING

A seat belt can only offer its intended degree of protection when the backrest is almost vertical and the occupant is sitting upright. Avoid seat positions that do not allow the seat belt to be routed correctly. Adjust the backrest so that it is as upright as possible. Never travel with the backrest reclined too far backwards. You could otherwise be seriously or even fatally injured in the event of an accident or sudden braking.

 To avoid damage to the seats and the seat heating, observe the following information:

- do not spill any liquids on the seats. If liquid is spilled on the seats, dry them as soon as possible.
- if the seat covers are damp or wet, do not switch on the seat heating. The seat heating should also not be used to dry the seats.
- clean the seat covers as recommended; see "Interior care".
- do not transport heavy loads on the seats. Do not place sharp objects on the seat cushions, e.g. knives, nails or tools. The seats should only be occupied by passengers, if possible.
- when the seat heating is in operation, do not cover the seats with insulating materials, e.g. blankets, coats, bags, seat covers, child seats or booster seats.

 Make sure that there are no objects in the footwell or behind the seats when moving the seat back. There is a risk that the seats and/or the objects could be damaged.

 The rear-compartment head restraints can be removed (▷ page 96).

For more information, contact a qualified specialist workshop.

- i** Further related subjects:
 - Luggage compartment enlargement (folding down the 2nd and 3rd row of seats) (▷ page 250)

Adjusting the seats manually and electrically

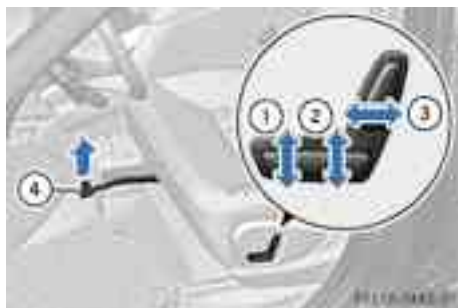

- ① Seat cushion angle
- ② Seat height
- ③ Backrest angle
- ④ Seat fore-and-aft adjustment

► **To set seat fore-and-aft adjustment:** lift lever ④ and slide the seat forwards or backwards.

► Release lever ④ again. Make sure that you hear the seat engage in position.

- i** Adjust seat cushion angle ① so that your thighs are lightly supported.

Adjusting the seats electrically



- ① Head restraint height
- ② Seat cushion angle
- ③ Seat height
- ④ Seat fore-and-aft adjustment
- ⑤ Backrest angle

i Vehicles with memory function: if PRE-SAFE® has been triggered, the front-passenger seat will be moved to a better position if it was previously in an unfavourable position.

i You can store the seat settings using the memory function (▷ page 108).

i Vehicles with memory function: when the seat is moved forwards or backwards, the headrest is moved up or down automatically.

Adjusting the head restraints

Adjusting the head restraints manually

Adjusting the head restraint height¹



- ▶ Once the head restraint is fully lowered, press release catch ①.
- ▶ **To raise:** pull the head restraint up to the desired position.
- ▶ **To lower:** press release catch ① in the direction of the arrow and push the head restraint down to the desired position.

Adjusting the angle of the head restraints

⚠ WARNING

Vehicle with a Rear Seat Entertainment System: Be careful not to trap your finger(s) between the head restraint cushion and the screen. If your fingers get trapped, this could lead to injury.



- ▶ Push or pull the lower edge of the head restraint in the direction of the arrow.

Adjusting the head restraints electrically

- ▶ **To adjust the head restraint height:** slide the switch for head restraint adjustment (> page 94) up or down in the direction of the arrow.

Adjusting the luxury head restraints

⚠ WARNING

When folding back the head restraint side bolsters, do not put your hands between the side bolster and the cushion holder. There is a danger of becoming trapped.



The 1st row of seats has luxury head restraints.

- ▶ **To adjust the side bolsters of the head restraint:** push or pull right and/or left-hand side bolster ① into the desired position.
- ▶ **To adjust the fore-and-aft position of the head restraint:** push or pull the head restraint in the direction of arrow ②.

¹ For vehicles without memory function only.

Rear seat head restraints

Adjusting the head restraint height (2nd and 3rd row of seats)



Outer seat head restraints in the 2nd row of seats



Outer seat head restraints in the 3rd row of seats

- ▶ Once the head restraint is fully lowered, press release catch ①.
- ▶ **To raise:** pull the head restraint up to the desired position.
- ▶ **To lower:** press release catch ① and push the head restraint down until it is in the desired position.

i The height of the centre seat head restraint in the 2nd row of seats and the head restraints in the 3rd row of seats is adjusted in the same way.

Adjusting the rear seat head restraint angle

The angle of the head restraints for the outer seats in the 2nd row of seats is adjusted in the same way as the front head restraints (▷ page 95).

The angle of the centre seat head restraint in the 2nd row of seats and the head restraints in the 3rd row of seats cannot be adjusted.

Removing and fitting the rear seat head restraints

⚠ WARNING

Occupants should only travel sitting on seats that have the head restraints fitted. This reduces the risk of injury to the occupant in the event of an accident.



Removing the head restraints from the outer seats in the 2nd row of seats

If you wish to remove the head restraints from the outer seats in the 2nd row of seats, you must move the respective seat as far back as possible (▷ page 98). Then, fold the seat backrest forwards.

You can remove the head restraints in the 2nd row of seats (centre seat and outer seats) and the head restraints in the 3rd row of seats in the same way.

- ▶ **To remove:** pull the head restraint up as far as it will go.
- ▶ Press release catch ① and pull the head restraint out of the guides.
- ▶ **To refit:** place the head restraint in the guides of the backrest.

i For the outer seat head restraints in the 2nd row of seats, the notches on the guide rod must be on the left-hand side when viewed in the direction of travel.

- ▶ Push the head restraint down until you hear it engage in position.

Rear seats (2nd and 3rd row)

Important safety notes

WARNING

Never travel with the backrest reclined too far back, as this can be dangerous. In the event of a collision, you could slide under the seat belt. If you slide under it, the seat belt would apply force to the abdomen or neck. This could cause serious or even fatal injuries. The seat backrest and seat belt provide the best restraint when the wearer is in a position that is as upright as possible and the seat belt is positioned correctly on the body.

Your seat must be adjusted so that you can correctly fasten your seat belt.

Never place your hands under the seat or near any moving parts while a seat is being adjusted.

After adjusting the seat, always make sure that the seat and the backrest are locked in place correctly. The seat backrests must be in the upright position.

An outer seat in the second row is only locked in place correctly if the lock verification indicator ① is folded in and the red indicator ② is barely visible.

If the seat and backrest are not locked in place correctly, the seat can move forwards and the backrest could fold down. You could slide under the seat belt in the event of an accident, sudden change of direction or abrupt braking. The child seat would no longer be supported or positioned correctly and would no longer be able to fulfil its intended function. This could cause serious or even fatal injuries.

WARNING

After adjusting the seats, make sure that the outer seats in the 2nd row are locked, and that the backrests in the 2nd and 3rd rows of seats are locked and in the upright position.

The outer seats in the 2nd row are only locked if the lock verification indicator is folded in

and the indicator area is barely visible (see the "EASY-ENTRY/EXIT feature for the 3rd row of seats" section).

If the backrests are not locked in position:

- sharp braking
- a sudden change of direction
- an accident

could cause the backrests to fold forwards and not provide the intended level of restraint, thereby resulting in additional serious or even fatal injury.

Seat lock status indicator



Seat locked

When the seat is locked, lock status indicator ① is folded in and indicator area ② is barely visible.

Adjusting the backrest angle



Outer seats, second row



Third row of seats

- ▶ Pull lever ① in the direction of the arrow to the pressure point and hold it in this position.
- ▶ Press your back lightly against the backrest to tilt it towards the rear.

or

- ▶ Relieve the pressure on the backrest to allow it to fold forwards.
- ▶ Release lever ① once the backrest is in the desired position.
- ▶ Lean back firmly against the backrest to ensure that it is engaged.

Seat fore-and-aft adjustment (2nd row of seats)



Seat fore-and-aft adjustment of the outer seats in the 2nd row is only possible for vehicles with a 3rd row of seats.

- ▶ Pull lever ① in the direction of the arrow to the pressure point and hold it in this position.
- ▶ Slide the seat forwards or backwards to the desired position.
- ▶ Release lever ①.
The seat engages audibly.

Adjusting the armrest (2nd row of seats)

5-seat and 7-seat vehicles

The backrest of the centre seat in the 2nd row can be used as an armrest.

- ▶ **To move the backrest to the armrest position:** move the head restraint of the centre seat to the lowest position (▷ page 96).

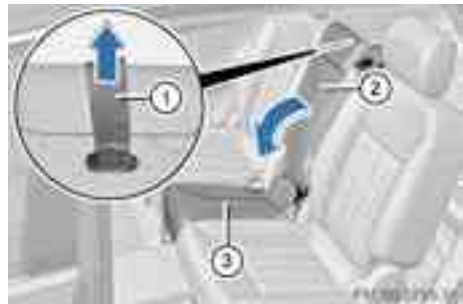

- ▶ Pull release loop ① in the direction of the arrow and hold it in this position.
- ▶ Fold backrest ② forwards until it is resting on seat cushion ③ in the armrest position.



Armrest position

- ▶ **To move the backrest to its original position:** pull release loop ① in the direction of the arrow and hold it in this position.
- ▶ Fold backrest ② backwards until you hear it engage.

6-seat vehicles

You can fold the armrests in the 2nd row of seats up, e.g. when loading the vehicle, and adjust their height.

- ▶ **To fold up:** fold the armrest up until it engages in the vertical position.
- ▶ **To adjust the height:** gently push the engaged armrest backwards to release it.
- ▶ First fold the armrest all the way down to its lowest position and then back up to the desired position until it engages.

i If you want to lower the armrest, you must first fold it up. Then, adjust the height as described above.

Folding down the seats in the 2nd row manually

Important safety notes

WARNING

Once passengers have got into or out of the vehicle, make sure that:

- the outer seats in the 2nd row are locked in position
- the outer seat backrests in the 2nd row of seats are upright and locked in position

The outer seats in the 2nd row are only locked if the lock verification indicator is folded in and the indicator area is barely visible.

If the backrests are not locked in position:

- sharp braking
- a sudden change of direction
- an accident

could cause the backrests to fold forwards and not provide the intended level of restraint, thereby resulting in additional serious or even fatal injury.

! Vehicles with a Rear Seat Entertainment System:

The screen of the Rear Seat Entertainment System may be damaged if the head restraint on the respective outer seat in the 2nd row of seats is extended significantly when using the EASY-ENTRY/EXIT feature.

Move the head restraint to the lowest position or carefully guide the seat backrest forwards to prevent damage.

The left and right seats of the 2nd row can be folded down electrically in order to enter or exit the 3rd row of seats.

i Further related subjects:

- Luggage compartment enlargement (folding the 2nd and 3rd row of seats forwards) (▷ page 251)
- Folding the seats in the 3rd row forwards (▷ page 251)

Entry position



The release handle for the EASY-ENTRY feature is located on the entry side on the back of each outer seat in the 2nd row of seats.

- ▶ Pull release handle ① in the direction of the arrow to the pressure point and hold it in this position.
The backrest folds forwards.
- ▶ Slide the seat in the 2nd row of seats forwards to the stop.



Entry position

Exit position

WARNING

In order to avoid injury when folding the seat backrest forwards, move your feet and legs back as far as possible so they are not touching the seat when folding it forwards.

In order to avoid an accident or potentially dangerous situation when opening the rear door and getting out of the vehicle, you should always observe the traffic conditions.



If you wish to exit the 3rd row of seats, fold down the outer seat on the right-hand side as follows.

The release loop for the EASY-EXIT feature is located at the bottom on the back of each outer seat in the 2nd row.

- ▶ Pull on release loop ① in the direction of the arrow and hold in this position.
The backrest folds forwards.
- ▶ Slide the seat in the 2nd row of seats forwards to the stop.



Exit position

Moving the outer seats back to the normal position (2nd row of seats)



Seat unlocked

When the seat is unlocked, lock status indicator ① is folded out and indicator area ② is clearly visible.

- ▶ **To lock the seat:** fold back the backrest until you hear it engage.

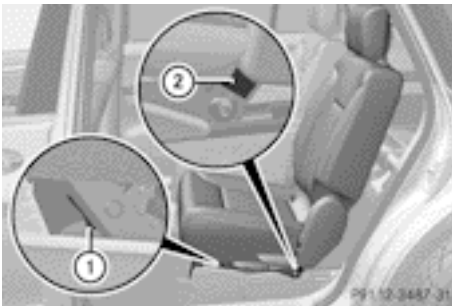

Seat locked

When the seat is locked, lock status indicator ① is folded in and indicator area ② is barely visible.

Adjusting the multicontour seat

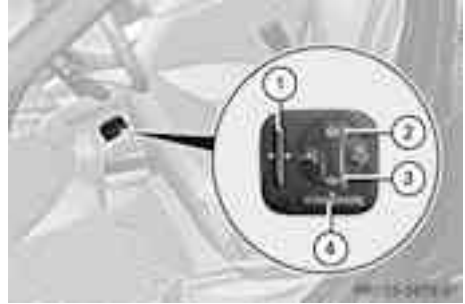

- ▶ Make sure that the key is in position 1 in the ignition lock.
- ▶ Use switch ④ to move the thigh cushion into the desired position.
- ▶ Press the $\boxed{+}$ or $\boxed{-}$ button to adjust the contour of the backrest to suit your back.
- ▶ Press button ③ to move the point of greatest backrest curvature downwards to the lumbar region and press button ② to move it upwards to the upper back region.
- ▶ Use button ① to adjust the side bolsters for optimum lateral support.

You can adjust the contour of the front seats individually so as to provide optimum support for your back and sides.

Adjusting the 4-way lumbar support

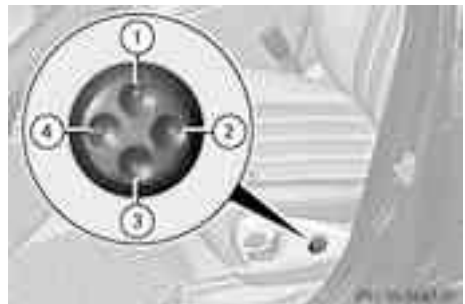

- ① To raise the backrest contour
- ② To soften the backrest contour
- ③ To lower the backrest contour
- ④ To harden the backrest contour

You can adjust the contour of the front seat backrests individually to provide optimum support for your back.

Switching the seat heating on/off

Switching on/off

WARNING

Repeatedly setting the seat heating to level **3** may result in excessive seat temperatures. The health of passengers that have limited temperature sensitivity or a limited ability to react to excessively high temperatures may be affected or they may even suffer burn-like injuries. Therefore, do not use seat heating level **3** repeatedly.



Driver's and front-passenger seat





Rear seats

The three red indicator lamps in the button indicate the heating level you have selected.

The system automatically switches down from level **3** to level **2** after approximately five minutes.

The system automatically switches down from level **2** to level **1** after approximately ten minutes.

The system automatically switches off approximately 35 minutes after it is set to level **1**.

- ▶ Make sure that the key is in position **1** or **2** in the ignition lock.
- ▶ **To switch on:** press button  repeatedly until the desired heating level is set.
- ▶ **To switch off:** press button  repeatedly until all the indicator lamps go out.

 If the battery voltage is too low, the seat heating may switch off.

One or several indicator lamps in the button for the seat heating flash.

Problems with the seat heating

If one or all of the indicator lamps in the seat heating button are flashing, the seat heating has switched off automatically. The vehicle's electrical system voltage is too low because too many electrical consumers are switched on.

- ▶ Switch off electrical consumers that you do not need, such as the rear window heating or interior lighting.
- Once the battery is sufficiently charged, the seat heating will switch back on automatically.

Switching the seat ventilation on/off

Switching on/off



The three blue indicator lamps in the buttons indicate the ventilation level you have selected.

- ▶ Make sure that the key is in position 1 or 2 in the ignition lock.
- ▶ **To switch on:** press button ① repeatedly until the desired ventilation level is set.
- ▶ **To switch off:** press button ① repeatedly until all the indicator lamps go out.

- ❗ If the battery voltage is too low, the seat ventilation may switch off.
- ❗ You can open the side windows and the sliding sunroof using the "Convenience opening" feature (> page 83). The seat ventilation of the driver's seat automatically switches to the highest level.

Problems with the seat ventilation

If one or all of the indicator lamps in the seat ventilation button are flashing, the seat ventilation has switched off automatically. The vehicle's electrical system voltage is too low because too many electrical consumers are switched on.

- ▶ Switch off electrical consumers that you do not need, such as the rear window heating or interior lighting.
Once the battery is sufficiently charged, the seat ventilation will switch back on automatically.

Steering wheel

Important safety notes

⚠ WARNING

Do not adjust the steering wheel while driving. Adjusting the steering wheel while driving, or driving without the steering wheel adjustment feature locked could cause the driver to lose control of the vehicle.

The electrical steering wheel adjustment feature can be operated at any time. Therefore, do not leave children unattended in the vehicle, or with access to an unlocked vehicle. A child's unsupervised access to a vehicle could result in an accident and/or serious personal injury.

Adjusting the steering wheel manually



- ① Release handle
- ② To adjust the steering wheel height
- ③ To adjust the steering wheel position (fore-and-aft adjustment)

- ▶ Pull release handle ① out completely. The steering column is unlocked.
- ▶ Adjust the steering wheel to the desired position.
- ▶ Push release handle ① in completely until it engages fully. The steering column is locked.
- ▶ Check if the steering column is locked. When doing so, try to push the steering

wheel up or down or try to move it in the fore-and-aft direction.

Adjusting the steering wheel electrically



- ① To adjust the steering wheel position (fore-and-aft adjustment)
- ② To adjust the steering wheel height
- ❗ Further related subjects:
 - EASY-ENTRY/EXIT feature (▷ page 104)
 - storing settings (▷ page 108)

Steering wheel heating

Switching on/off



- ▶ Make sure that the key is in position **2** in the ignition lock.
- ▶ **To switch on/off:** turn the lever in the direction of arrow ① or ②. Indicator lamp ③ lights up or goes out.

Vehicles without KEYLESS-GO: when you remove the key from the ignition lock, the steering wheel heating is switched off.

Vehicles with KEYLESS-GO: when you switch off the ignition and open the driver's door, the steering wheel heating is switched off.

Problems with the steering wheel heating

The steering wheel heating has switched itself off prematurely or cannot be switched on. The vehicle's electrical system voltage is too low because too many electrical consumers are switched on.

- ▶ Switch off electrical consumers that you do not need, such as the rear window heating or interior lighting.

EASY-ENTRY/EXIT feature

Important safety notes

⚠ WARNING

Make sure that nobody can become trapped when you activate the EASY-ENTRY/EXIT feature.

If there is a risk of someone becoming trapped, stop the adjustment procedure. To halt the procedure:

- press the steering column adjustment button.
- briefly press one of the memory function position buttons.

The steering column stops moving immediately.

Do not keep the memory function position button pressed down, otherwise the memory function will start and the steering wheel and seat will begin to move.

Never leave children unsupervised in the vehicle. They could open the driver's door and thereby unintentionally activate the EASY-ENTRY feature and become trapped.

The EASY-ENTRY/EXIT feature makes getting in and out of your vehicle easier.

You can activate and deactivate the EASY-ENTRY/EXIT feature in the on-board computer (▷ page 206).

Position of the steering wheel when the EASY-ENTRY/EXIT feature is active

The steering wheel tilts upwards if you:

- remove the key from the ignition lock
- open the driver's door and KEYLESS-GO is in position **1**
- open the driver's door and the key is in position **0** or **1** in the ignition lock

i The steering wheel only moves upwards if it has not already reached the upper end stop.

Position of the steering wheel for driving

The steering wheel is moved to the previously set position if:

- the driver's door is closed and
- you insert the key into the ignition lock or
- you press the Start/Stop button once on vehicles with KEYLESS-GO.

If you close the driver's door with the key inserted into the ignition lock, the steering wheel is automatically moved to the previously set position.

The last position of the steering wheel is stored when you switch off the ignition or when you store the setting with the memory function (▷ page 108).

Crash-responsive EASY-EXIT feature

If the crash-responsive EASY-EXIT feature is triggered in an accident, the steering column will move upwards when the driver's door is opened. This occurs irrespective of the position of the key in the ignition lock. This makes

it easier to exit the vehicle and rescue the occupants.

The crash-responsive EASY-EXIT feature is only operational if the EASY-EXIT/ENTRY feature is activated in the on-board computer (▷ page 206).

Mirrors

Rear-view mirror



► **Anti-dazzle mode:** flick anti-dazzle switch **1** forwards or back.

Exterior mirrors

Adjusting the exterior mirrors

WARNING

The exterior mirrors reduce the size of the image. Objects are actually closer than they appear. You could misjudge the distance from vehicles driving behind and cause an accident, e.g. when changing lane. For this reason, make sure of the actual distance from the vehicle driving behind by glancing over your shoulder.



- ▶ Make sure that the key is in position **1** or **2** in the ignition lock.
- ▶ Press button **①** for the left-hand exterior mirror or button **②** for the right-hand exterior mirror.
The indicator lamp in the corresponding button lights up in red.
The indicator lamp goes out again after some time. You can adjust the selected mirror using adjustment button **③** as long as the indicator lamp is lit.
- ▶ Press adjustment button **③** up, down, or to the left or right until you have adjusted the exterior mirror to the correct position. You should have a good overview of traffic conditions.

The convex exterior mirrors provide a larger field of vision.

The exterior mirrors are automatically heated if the rear window heating is switched on and the outside temperature is low.

Folding the exterior mirrors in or out electrically



- ▶ Make sure that the key is in position **1** or **2** in the ignition lock.
- ▶ Briefly press button **①**.
Both exterior mirrors fold in or out.
- i** Make sure that the exterior mirrors are always folded out fully while driving. They could otherwise vibrate.

Setting the exterior mirrors

If the battery has been disconnected or completely discharged, the exterior mirrors must be reset. The exterior mirrors will otherwise not fold in when you select the "Fold in mirrors when locking" function in the on-board computer (▷ page 206).

- ▶ Make sure that the key is in position **1** in the ignition lock.
- ▶ Briefly press button **①**.

Folding the exterior mirrors in or out automatically

If the "Fold in mirrors when locking" function is activated in the on-board computer (▷ page 206):

- the exterior mirrors fold in automatically as soon as you lock the vehicle from the outside.
- the exterior mirrors fold out again automatically as soon as you unlock the vehicle and then open the driver's or front-passenger door.

Exterior mirror pushed out of position

If an exterior mirror has been pushed out of position, proceed as follows:

- ▶ **Vehicles without electrically folding exterior mirrors:** move the exterior mirror into the correct position manually.
- ▶ **Vehicles with electrically folding exterior mirrors:** press and hold button for

folding the mirrors ① until you hear a click and then the mirror engage in position. The mirror housing is engaged again and you can adjust the exterior mirrors as usual (▷ page 105).

Automatic anti-dazzle mirrors

WARNING

If incident light from headlamps is prevented from striking the sensor in the rear-view mirror, for instance, by luggage piled too high in the vehicle, the mirror's automatic anti-dazzle function will not operate.

Incident light could then blind you. This may distract you from the traffic conditions and, as a result, you may cause an accident.

The rear-view mirror and the exterior mirror on the driver's side automatically go into anti-dazzle mode if the following conditions are met simultaneously:

- the ignition is switched on and
- incident light from headlamps strikes the sensor in the rear-view mirror.

The mirrors do not go into anti-dazzle mode if reverse gear is engaged or if the interior lighting is switched on.

Parking position of the exterior mirror on the front-passenger side

Setting and storing the parking position

Using reverse gear

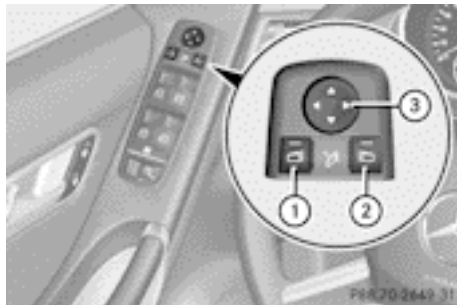

You can set the front-passenger side exterior mirror so that you can see the rear wheel on that side as soon as you engage reverse gear. You can store this position.

- ▶ Make sure that the vehicle is stationary and that the key is in position **2** in the ignition lock.
 - ▶ Press button ② for the exterior mirror on the front-passenger side.
 - ▶ Engage reverse gear. The exterior mirror on the front-passenger side moves to the preset parking position.
 - ▶ Use adjustment button ③ to adjust the exterior mirror to a position that allows you to see the rear wheel and the kerb. The parking position is stored.
- i** If you shift the transmission to another position, the exterior mirror on the front-passenger side returns to the driving position.

Calling up a stored parking position setting

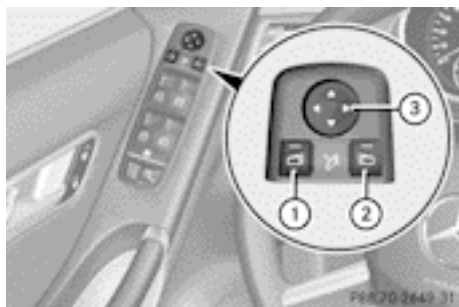

- ▶ Turn the key to position **2** in the ignition lock.
- ▶ Adjust the exterior mirror on the front-passenger side using button **②**.
- ▶ Engage reverse gear.
The exterior mirror on the front-passenger side moves to the stored parking position.

The exterior mirror on the front-passenger side moves back to its original position:

- as soon as you exceed a speed of 15 km/h
- if you press button **①** for the exterior mirror on the driver's side

Memory function

Storing settings

WARNING

Only use the memory function on the driver's side when the vehicle is stationary. You could otherwise be distracted from the traffic conditions by the steering wheel and seat moving of their own accord, and as a result, cause an accident.

WARNING

The memory function can still be used when the key has been removed. For this reason, children should never be left unsupervised in the vehicle. They could otherwise become

trapped when adjusting the seat or the steering wheel.

With the memory function, you can store up to three different settings, e.g. for three different people.

The following settings are stored as a single memory preset:

- position of the seat, backrest and head restraint
- driver's side: steering wheel position
- driver's side: position of the exterior mirrors on the driver's and front-passenger sides



- ▶ Adjust the seat (▷ page 94).
- ▶ On the driver's side, adjust the steering wheel (▷ page 104) and the exterior mirrors (▷ page 105).
- ▶ Press the **M** memory button and then press one of the storage position buttons **1**, **2** or **3** within three seconds.
The settings are stored in the selected preset position. A tone sounds when the settings have been completed.

Calling up a stored setting

- ▶ Press and hold the relevant storage position button **1**, **2** or **3** until the seat, steering wheel and exterior mirrors are in the stored position.
- i** The setting procedure is interrupted as soon as you release the storage position buttons.

Useful information	110
Exterior lighting	110
Interior lighting	114
Replacing bulbs	115
Windscreen wipers	120

Useful information

i This Owner's Manual describes all models, series and optional equipment for your vehicle that were available at the time of going to press. National variations are possible. Note that your vehicle may not be equipped with all of the functions described. This is also the case for systems and functions relevant to safety.

i Read the information on qualified specialist workshops: (▷ page 23).

Exterior lighting

Important safety notes

For reasons of safety, Mercedes-Benz recommends that you drive with the lights switched on even during the daytime. In some countries, operation of the headlamps varies due to legal requirements and self-imposed obligations.

Driving abroad

Converting to symmetrical dipped beam

If your journey takes you to countries where vehicles are driven on the opposite side of the road to the country in which the vehicle is registered, your headlamps must be switched to symmetrical dipped beam. This prevents oncoming traffic from being dazzled. Symmetrical lights do not illuminate as large an area of the edge of the carriageway.

Have the headlamps converted at a qualified specialist workshop as close to the border as possible before driving in these countries.

Converting to asymmetrical dipped beam after returning

Have the headlamps converted back to asymmetrical dipped-beam headlamps at a quali-

fied specialist workshop as soon as possible after crossing the border again.

Light switch

Operation

! Switch off the side lamps and parking lamp when you leave the vehicle. This prevents the battery from discharging.



- 1** Left-hand parking lamps
- 2** Right-hand parking lamps
- 3** **0** Lights off/daytime driving lights
- 4** **AUTO** Automatic headlamp mode/daytime driving lights
- 5** Side lamps, licence plate and instrument cluster lighting
- 6** Dipped-beam/main-beam headlamps
- 7** **0** Vehicles without front foglamps: rear foglamp
- 7** Vehicles with front foglamps: front foglamps
- 8** **0** Vehicles with front foglamps: rear foglamp

If you hear a warning tone when you leave the vehicle, the lights may still be switched on.

► Turn the light switch to **0** or **AUTO**.

or

► If the rear foglamp is switched on: press the light switch in to the stop.

The turn signals, main-beam headlamps and the headlamp flasher are operated using the combination switch (▷ page 113).

The exterior lighting (except the side lamps/parking lamps) switches off automatically if you:



- remove the key from the ignition lock
- open the driver's door with the key in position **0**

Side lamps



► **To switch on:** turn light switch to .

Parking lamps

If you switch on the parking lamps, the side lamps on one side of the vehicle are lit dimly.



- **To switch on the parking lamps:** the key is not in the ignition lock or it is in position **0**.
- Turn the light switch to  (left-hand side of the vehicle) or  (right-hand side of the vehicle).

Dipped-beam headlamps

- **To switch on the dipped-beam headlamps:** turn the key in the ignition lock to position **2** or start the engine.
- Turn the light switch to . The  indicator lamp in the instrument cluster lights up.
- **To switch off the dipped-beam headlamps:** turn the light switch to .

Daytime driving lights



You can set the "daytime driving lights" function via the on-board computer (► page 202).

- **Daytime driving lights:** activate the daytime driving lights function using the on-board computer.
- Turn the light switch to  or . When the engine is on: depending on the ambient light conditions, the daytime driving lights or the dipped-beam headlamps are switched on.

When the dipped-beam headlamps are switched on, the  indicator lamp in the instrument cluster lights up.



Automatic headlamp mode

WARNING

If the light switch is set to , the dipped-beam headlamps will not come on automatically if it is foggy. This could endanger you and others. Therefore, turn the light switch to  in fog.

The automatic headlamp feature is only an aid. The driver is responsible for the vehicle's lighting at all times.

WARNING

When it is dark or foggy, turn the light switch from  to  in good time. Otherwise, the headlamps could switch off temporarily and you could cause an accident.

- **To switch on automatic headlamp mode:** turn the light switch to .

Key in position **1** in the ignition lock: the side lamps are switched on or off automatically depending on the brightness of the ambient light.





With the engine running: if you have activated the daytime driving lights function in the on-board computer, the daytime driving lights or the dipped-beam headlamps are switched on or off automatically depending on the brightness of the ambient light.

When the dipped-beam headlamps are switched on, the  indicator lamp in the instrument cluster lights up.

Foglamps







WARNING



If you suspect that driving conditions will be foggy, turn the light switch to  before you start your journey. Your vehicle may otherwise not be visible and you could endanger yourself and others.

- ▶ **To switch on the foglamps:** turn the key in the ignition lock to position **2** or start the engine.
- ▶ Turn the light switch to  or . If the light switch is set to **AUTO**, you cannot switch on the foglamps.
- ▶ Pull the light switch out to the first detent. The green  indicator lamp on the light switch lights up.
- ▶ **To switch off the front foglamps:** press the light switch in as far as it will go. The green  indicator lamp on the light switch goes out.

Only vehicles with front foglamps have the "Foglamps" function.

Rear foglamp

- ▶ **To switch on (vehicles with foglamps):** turn the key in the ignition lock to position **2** or start the engine.
- ▶ Turn the light switch to  or . When the light switch is set to **AUTO**, you cannot switch on the rear foglamp.
- ▶ Pull the light switch out to the second stop. The yellow  indicator lamp on the light switch lights up.
- ▶ **To switch off the rear foglamp:** press the light switch in as far as it will go. The yellow  indicator lamp on the light switch goes out.
- ▶ **To switch on (vehicles without front foglamps):** turn the key in the ignition lock to position **2** or start the engine.
- ▶ Turn the light switch to . When the light switch is set to **AUTO**, you cannot switch on the rear foglamp.
- ▶ Turn the light switch to . When the light switch is set to **A**, you cannot switch on the rear foglamp.

- ▶ Pull the light switch out to the stop. The yellow  indicator lamp on the light switch lights up.
- ▶ **To switch off the rear foglamp:** press the light switch in as far as it will go. The yellow  indicator lamp on the light switch goes out.

Adjusting the headlamp range (halogen headlamps)

The headlamp range control allows you to adjust the cone of light from the headlamps to suit the vehicle load.

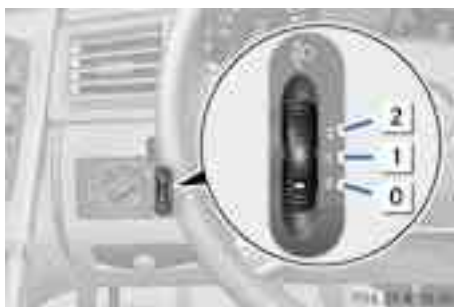

Headlamp range control (vehicles with level control)

- 0** Driver's seat occupied/driver's seat and front-passenger seat occupied/driver's seat occupied and luggage compartment laden up to the maximum permissible rear axle load
- 1** All seats occupied and luggage compartment laden up to the maximum permissible rear axle load
- 2** Not required



Headlamp range control (vehicles with steel suspension)

- 0 Driver's seat occupied/driver's seat and front-passenger seat occupied
 - 1 Driver's seat, front-passenger seat and all rearmost seats occupied/all seats occupied
 - 2 All seats occupied and luggage compartment laden up to the maximum permissible rear axle load
 - 3 Driver's seat occupied and luggage compartment laden up to the maximum permissible rear axle load
- ▶ Start the engine.
 - ▶ Turn the headlamp range control to the position which corresponds to the load in your vehicle.

Headlamp cleaning system

The headlamps are cleaned automatically if the "Wipe with washer fluid" function is operated five times (▷ page 120) while the lights are on and the engine is running. When you switch off the ignition, the automatic headlamp cleaning system is reset and counting is resumed from 0.

Combination switch

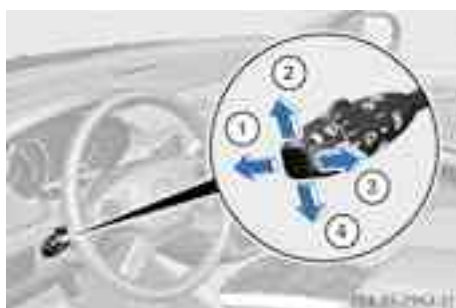

Turn signals



- 1 Main-beam headlamps
- 2 Turn signal, right
- 3 Headlamp flasher
- 4 Turn signal, left

- ▶ **To indicate briefly:** press the combination switch briefly to the pressure point in the direction of arrow 2 or 4. The corresponding turn signal flashes three times.
- ▶ **To indicate:** press the combination switch beyond the pressure point in the direction of arrow 2 or 4.

Main-beam headlamps

- ▶ **To switch on the main-beam headlamps:** turn the key in the ignition lock to position 2 or start the engine.
- ▶ Turn the light switch to .
- ▶ Press the combination switch beyond the pressure point in the direction of arrow 1. The  indicator lamp in the instrument cluster lights up.
- ▶ **To switch off the main-beam headlamps:** move the combination switch back to its normal position. The blue  indicator lamp in the instrument cluster goes out.

Headlamp flasher

- ▶ **To switch on:** turn the key in the ignition lock to position **1** or **2**, or start the engine.
- ▶ Pull the combination switch in the direction of arrow **③**.

Hazard warning lamps



- ▶ **To switch on the hazard warning lamps:** press button **①**.

All turn signals flash. If you now switch on a turn signal using the combination switch, only the turn signal lamp on the corresponding side of the vehicle will flash.

- ▶ **To switch off the hazard warning lamps:** press button **①**.

The hazard warning lamps automatically switch on if:

- an airbag is deployed.
- the vehicle decelerates rapidly from a speed of more than 70 km/h and comes to a standstill.

The hazard warning lamps switch off automatically if the vehicle reaches a speed of over 10 km/h again after a full brake application.

- i** The hazard warning lamps still operate if the ignition is switched off.

Headlamps misted up on the inside

The headlamps may mist up on the inside if there is high atmospheric humidity.

- ▶ Switch on the lights and drive off. The level of moisture diminishes, depending on the length of the journey and the weather conditions (humidity and temperature).

If the level of moisture does not diminish:



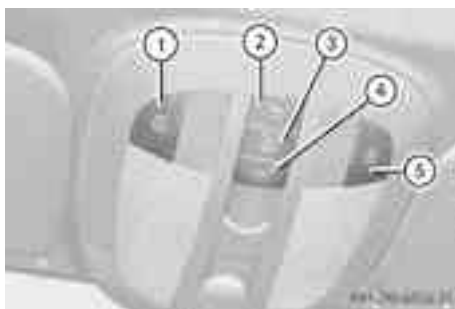

- ▶ Have the headlamps checked at a qualified specialist workshop.

Interior lighting

Overview of interior lighting



Front overhead control panel

- ①  To switch the left-hand front reading lamp on/off
- ②  To switch the rear interior lighting on/off
- ③  To switch the automatic interior lighting control on/off
- ④  To switch the front interior lighting on/off
- ⑤  To switch the right-hand front reading lamp on/off

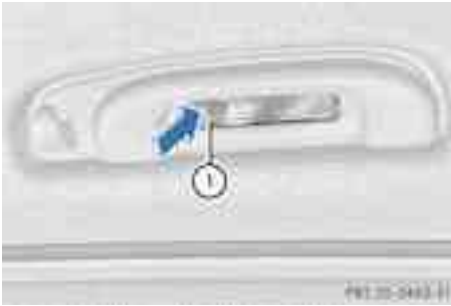

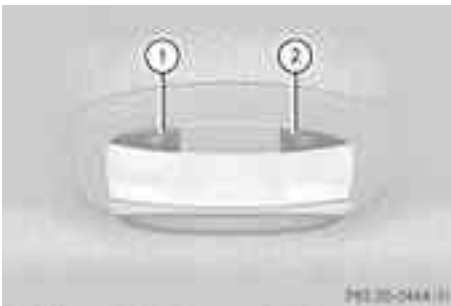

Rear overhead control panel (second row of seats)

① To switch the reading lamp on/off



Rear overhead control panel (third row of seats)

①  To switch the left-hand reading lamp on/off

②  To switch the right-hand reading lamp on/off

Interior lighting control

General notes

In order to prevent the vehicle's battery from discharging, the interior lighting functions are automatically deactivated after some time except for when the key is in position **2** in the ignition lock.

Automatic interior lighting control



► **To switch on/off:** press the  button. When the automatic interior lighting control is activated, the button is flush with the overhead control panel.

The interior lighting automatically switches on if you:

- unlock the vehicle
- open a door
- remove the key from the ignition lock

The interior lighting is activated for a short time when the key is removed from the ignition lock. You can activate this delayed switch-off using the on-board computer (> page 203).

Manual interior lighting control

- **To switch the front interior lighting on/off:** press the  button.
- **To switch the rear interior lighting on/off:** press the  button.
- **To switch the reading lamps on/off:** press the  button.

Crash-responsive emergency lighting

The interior lighting is activated automatically if the vehicle is involved in an accident.

- **To switch off the crash-responsive emergency lighting:** press the hazard warning lamp button.

or

- Lock and then unlock the vehicle using the key.

Replacing bulbs

Important safety notes

Xenon bulbs

DANGER

Xenon bulbs are under high voltage. If you touch the electrical contacts of a xenon bulb, you could suffer an electric shock and be seriously or even fatally injured. For this reason, do not remove the cover of xenon bulbs.

Do not change the xenon bulbs yourself, but have them replaced at a qualified workshop.

If your vehicle is equipped with xenon bulbs, you can recognise this by the following: the cone of light from the xenon bulbs moves from the top to the bottom and back again when you start the engine. For this to be observed, the lights must be switched on before starting the engine.

Bulbs and lamps are an important aspect of vehicle safety. You must therefore make sure that these function correctly at all times. Have the headlamp setting checked regularly.

Other bulbs

WARNING

Bulbs and lamps can be very hot. You should therefore allow them to cool down before you change them. Otherwise, you could be burned if you touch them.

Keep bulbs out of the reach of children. Otherwise, they could damage the bulbs, for example, and injure themselves.

Never use a bulb which has been dropped. Such a bulb may break or even explode and injure you.

Halogen bulbs are pressurised and can explode when you change them, particularly if they are very hot. You should therefore wear eye protection and gloves when you are changing them.

There are bulbs other than the xenon bulbs that you cannot replace. Replace only the bulbs listed (▷ page 116). Have the bulbs that you cannot replace yourself changed at a qualified specialist workshop.

If you require assistance changing bulbs, consult a qualified specialist workshop.

Do not touch the glass tube of new bulbs with your bare hands. Even minor contamination can burn into the glass surface and reduce the service life of the bulbs. Always use a lint-free cloth or only touch the base of the bulb when fitting.

Only use bulbs of the correct type.

If the new bulb still does not light up, consult a qualified specialist workshop.

Bulbs and lamps are an important aspect of vehicle safety. You must therefore make sure that these function correctly at all times. Have the headlamp setting checked regularly.

Overview of bulb replacement – bulbs

You can replace the following bulbs. The details for the bulb type can be found in the legend.

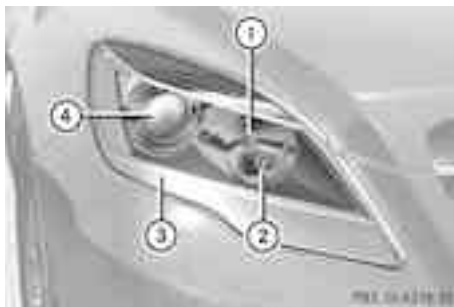

Halogen headlamps

- ① Main-beam headlamp: H7 55 W
- ② Side lamps/parking lamp: W 5 W
- ③ Turn signal lamp: WY 5 W
- ④ Dipped-beam headlamp: H7 55 W



Bi-xenon headlamps

- ① Turn signal lamp: WY 5 W
- ② Side lamps/parking lamp: W 5 W



Tail lamps

- ① Reversing lamp: W 16 W

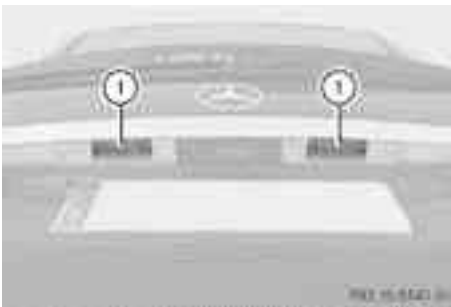

Licence plate lamp

- ① Licence plate lamp: C 5 W

Replacing the front bulbs

Fitting/removing the cover on the front wheel arch

You must remove the cover from the front wheel housing before you can change the front bulbs.



- ▶ **To remove:** switch off the lights.
- ▶ Turn the front wheels inwards.
- ▶ Turn rotary catch ① 90° anti-clockwise.
- ▶ Pull away the cover and lift it off.
- ▶ **To fit:** re-insert the cover.
- ▶ Turn rotary catch ① 90° clockwise.

Dipped-beam headlamps (halogen headlamps)

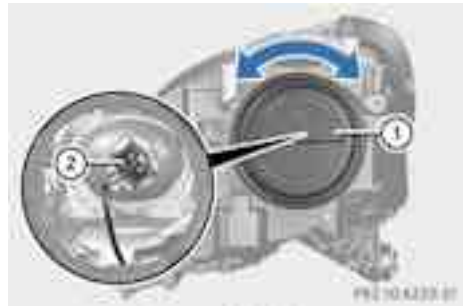

- ▶ Remove the cover in the front wheel arch (▷ page 117).
- ▶ Turn housing cover ① anti-clockwise and pull it out.
- ▶ Turn bulb holder ② anti-clockwise and pull it out.
- ▶ Take the bulb out of bulb holder ②.
- ▶ Insert the new bulb into bulb holder ②.
- ▶ Insert bulb holder ② into the lamp and turn it clockwise.
- ▶ Align housing cover ① and turn it clockwise until it engages.
- ▶ Replace the cover in the front wheel arch (▷ page 117).

Main-beam headlamps (halogen headlamps)

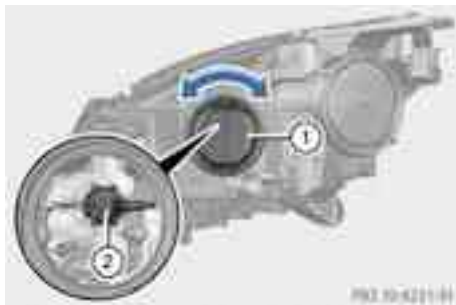

- ▶ Remove the cover in the front wheel arch (▷ page 117).
- ▶ Turn housing cover ① anti-clockwise and pull it out.
- ▶ Turn bulb holder ② anti-clockwise and pull it out.
- ▶ Take the bulb out of bulb holder ②.
- ▶ Insert the new bulb into bulb holder ②.
- ▶ Insert bulb holder ② into the lamp and turn it clockwise.
- ▶ Align housing cover ① and turn it clockwise until it engages.
- ▶ Replace the cover in the front wheel arch (▷ page 117).

- ▶ Turn housing cover ① anti-clockwise and pull it out.
- ▶ Pull out bulb holder ②.
- ▶ Take the bulb out of bulb holder ②.
- ▶ Insert the new bulb into bulb holder ②.
- ▶ Insert bulb holder ②.
- ▶ Align housing cover ① and turn it clockwise until it engages.
- ▶ Replace the cover in the front wheel arch (▷ page 117).

Turn signals

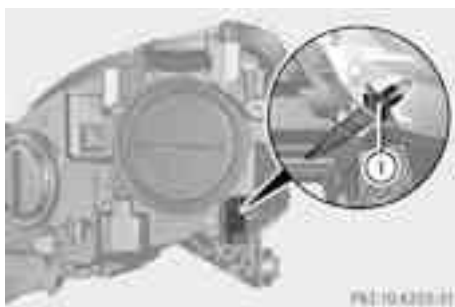

- ▶ Remove the cover in the front wheel arch (▷ page 117).
- ▶ Pull out bulb holder ①.
- ▶ Take the bulb out of bulb holder ①.
- ▶ Insert the new bulb into bulb holder ①.
- ▶ Insert bulb holder ①.
- ▶ Replace the cover in the front wheel arch (▷ page 117).

Side lamps/parking lamps

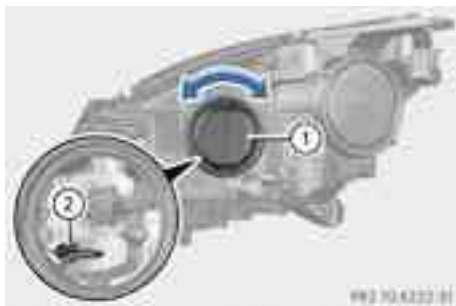

- ▶ Switch off the lights.
- ▶ Remove the cover in the front wheel arch (▷ page 117).

Replacing the rear bulbs

Opening and closing the side trim panels

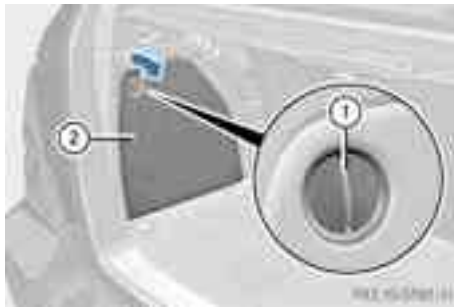

Left-hand side trim panel

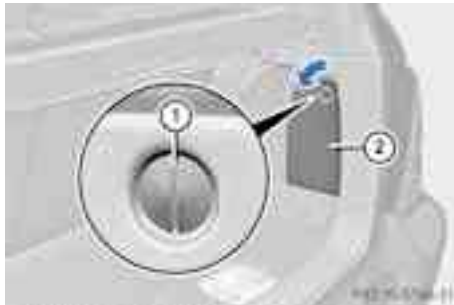

Right-hand side trim panel

You must open the side trim panel in the luggage compartment before you can replace the bulbs in the reversing lamp.

- ▶ **To open:** insert a suitable object, e.g. a coin, into the slot of release knob ① on side trim panel ②.
- ▶ Turn release knob ① 90° in the direction of the arrow and remove side trim panel ②.
- ▶ **To close:** insert side trim panel ② and turn release knob ① 90° in the opposite direction to the arrow.

Reversing lamp



- ① Reversing lamp
- ▶ Switch off the lights.
- ▶ Open the luggage compartment.
- ▶ Open the side trim panel (▷ page 119).
- ▶ Turn the bulb holder anti-clockwise and remove it.
- ▶ Remove the bulb from the bulb holder.
- ▶ Insert the new bulb into the bulb holder.
- ▶ Insert the bulb holder and turn it clockwise.
- ▶ Close the side trim panel (▷ page 119).

Licence plate lighting



- ▶ Switch off the lights.
- ▶ Open the tailgate.
- ▶ Unscrew screws ①.
- ▶ Remove the licence plate lamp.
- ▶ Replace the bulb.
- ▶ Insert the licence plate lamp.
- ▶ Replace and tighten screws ①.

Windscreen wipers

Switching the windscreen wipers on/off

WARNING

The windscreen will not longer be wiped properly if the wiper blades are worn. This could prevent you from observing the traffic conditions, thereby causing an accident. Replace the wiper blades twice a year, ideally in spring and autumn.

! Do not operate the windscreen wipers when the windscreen is dry, as this could damage the wiper blades. Moreover, dust that has collected on the windscreen can scratch the glass if wiping takes place when the windscreen is dry.

If it is necessary to switch on the windscreen wipers in dry weather conditions, always operate them using washer fluid.





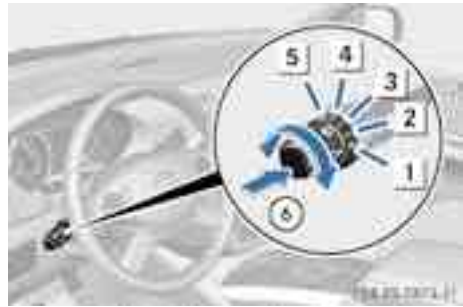

! If the windscreen wipers leave smears on the windscreen after the vehicle has been washed in an automatic car wash, this may be due to wax or other residue. Clean the windscreen with washer fluid after an automatic car wash.

! Intermittent wiping with rain sensor: due to optical influences and the windscreen becoming dirty in dry weather conditions, the windscreen wipers may be activated inadvertently. This could damage the windscreen wiper blades or scratch the windscreen.

For this reason, you should always switch off the windscreen wipers in dry weather.







Combination switch

- 1**  Windscreen wipers off
- 2**  Intermittent wipe, low (rain sensor set to low sensitivity)
- 3**  Intermittent wipe, high (rain sensor set to high sensitivity)
- 4**  Continuous wipe, slow
- 5**  Continuous wipe, fast
- 6**  Single wipe /  To wipe the windscreen using washer fluid

► Turn the key to position **1** or **2** in the ignition lock (► page 145).

► Turn the combination switch to the corresponding position.

In the  or  position, the appropriate wiping frequency is set automatically according to the intensity of the rain. In the  position, the rain sensor is more sensitive than in the  position, causing the windscreen wipers to wipe more frequently.

Switching the rear window wiper on/off

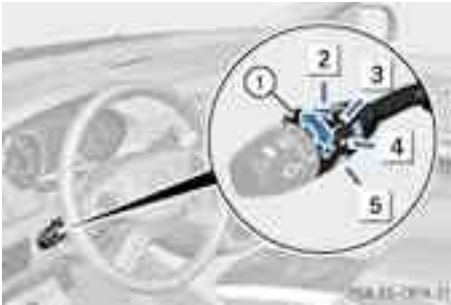

Combination switch

- ① Rear window wiper switch
- ② To wipe with washer fluid
- ③ **I** To switch on intermittent wiping
- ④ **0** To switch off intermittent wiping
- ⑤ To wipe with washer fluid

- ▶ Turn the key to position **1** or **2** in the ignition lock (▷ page 145).
- ▶ Turn switch ① on the combination switch to the corresponding position. When the rear window wiper is switched on, the icon appears in the instrument cluster.

Replacing the wiper blades

Important safety notes

WARNING

The wiper arms could start moving and cause an injury if you leave the windscreen wipers switched on.

Remove the key from the ignition lock before replacing the wiper blades.

- ❗ Never open the bonnet if a windscreen wiper arm has been folded away from the windscreen.

Never fold a windscreen wiper arm without a wiper blade back onto the windscreen/rear window.

Hold the windscreen wiper arm firmly when you change the wiper blade. If you release

the windscreen wiper arm without a wiper blade and it falls onto the windscreen, the windscreen may be damaged by the force of the impact.

Mercedes-Benz recommends that you have the wiper blades changed at a qualified specialist workshop.

- ❗ To avoid damaging the windscreen wiper blades, make sure that you touch only the wiper arm of the windscreen wiper.

Replacing the windscreen wiper blades

Removing the wiper blades

- ▶ Remove the key from the ignition lock.
- ▶ Fold the wiper arm away from the windscreen.

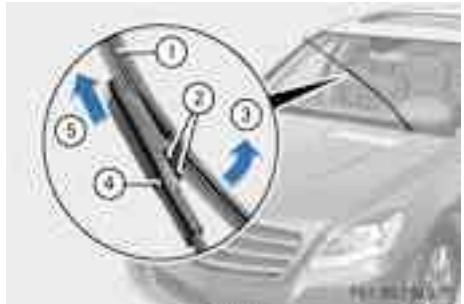

- ▶ Press both release clips ②.
- ▶ Fold wiper blade ① in the direction of arrow ③ away from wiper arm ④.
- ▶ Remove wiper blade ① in the direction of arrow ⑤.

Fitting the wiper blades



- ▶ Position new wiper blade ① with recess ⑥ on lug ⑤.
- ▶ Fold wiper blade ① in the direction of arrow ③ onto the wiper arm, until retaining clips ② engage in bracket ④.
- ▶ Make sure that wiper blade ① is seated correctly.
- ▶ Fold the wiper arm back onto the windscreen.

Replacing the rear window wiper blade

Removing the wiper blades

WARNING

The wiper arm could be set in motion and injure you if the windscreen wipers are switched on.

Remove the key from the ignition lock before replacing the wiper blade.



- ▶ Remove the key from the ignition lock.
- ▶ Fold wiper arm ① away from the rear window until it engages.
- ▶ Position wiper blade ② at a right angle to wiper arm ①.
- ▶ Hold wiper arm ① and press wiper blade ② in the direction of the arrow until it releases.
- ▶ Remove wiper blade ②.

Fitting the wiper blade

- ▶ Place new wiper blade ② onto wiper arm ①.
- ▶ Hold wiper arm ① and press wiper blade ② in the opposite direction to the arrow until it engages.
- ▶ Make sure that wiper blade ② is seated correctly.
- ▶ Position wiper blade ② parallel to wiper arm ①.
- ▶ Fold wiper arm ① back onto the rear window.

Problems with the windscreen wipers

The windscreen wipers are obstructed

- ▶ For safety reasons, you should remove the key from the ignition lock.

or

- ▶ Switch off the engine using the Start/Stop button and open the driver's door.
- ▶ Remove the cause of the obstruction.
- ▶ Switch the windscreen wipers back on.

The windscreen wipers are inoperative

The windscreen wiper drive is malfunctioning.

- ▶ Select another wiper speed on the combination switch.
- ▶ Have the windscreen wipers checked at a qualified specialist workshop.

Useful information	124
Overview of climate control systems	124
Operating the climate control system	128
Adjusting the air vents	139

Useful information

- i** This Owner's Manual describes all models, series and optional equipment for your vehicle that were available at the time of going to press. National variations are possible. Note that your vehicle may not be equipped with all of the functions described. This is also the case for systems and functions relevant to safety.
- i** Read the information on qualified specialist workshops: (▷ page 23).

interval for replacing the filter, which is specified in the Service Booklet. As it depends on environmental conditions, e.g. heavy air pollution, the interval may be shorter than stated in the Service Booklet.

Overview of climate control systems

Important safety notes

WARNING

Observe the settings recommended on the following pages. The windows could otherwise mist up. This may prevent you from observing the traffic conditions, thereby causing an accident.

Climate control regulates the temperature and the humidity in the vehicle interior and filters undesirable substances out of the air. Climate control is only operational when the engine is running. The system only works optimally if the side windows and the roof are closed.

The residual heat function can only be activated or deactivated with the ignition switched off (▷ page 134).

- i** Ventilate the vehicle for a brief period during warm weather, e.g. using the convenience opening feature (▷ page 83). This will speed up the cooling process and the desired vehicle interior temperature will be reached more quickly.
- i** The integrated filter can filter out most particles of dust and completely filters out pollen. A clogged filter reduces the amount of air supplied to the vehicle interior. For this reason, you should always observe the

Control panel for THERMATIC automatic climate control (2-zone)

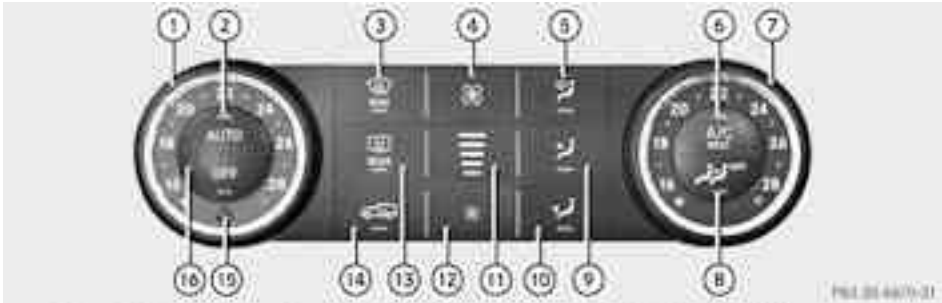

- ① Sets the temperature, left (▷ page 131)
- ② Sets climate control to automatic mode (▷ page 130)
- ③ Demists the windscreen (▷ page 132)
- ④ Increases the airflow (▷ page 132)
- ⑤ Directs the airflow through the demister vents (▷ page 131)
- ⑥ Switches cooling with air dehumidification on/off (▷ page 129)
- ⑦ Sets the temperature, right (▷ page 131)
- ⑧ Switches rear-compartment climate control on/off (▷ page 128)
- ⑨ Directs the airflow through the centre and side air vents (▷ page 131)
- ⑩ Directs the airflow to the footwells and side air vents (▷ page 131)
- ⑪ Displays the airflow level
- ⑫ Reduces the airflow (▷ page 132)
- ⑬ Switches the rear window heating on/off (▷ page 133)
- ⑭ Activates/deactivates air-recirculation mode (▷ page 133)
- ⑮ Interior temperature sensor
- ⑯ Switches climate control on/off (▷ page 128)

Information about using THERMATIC automatic climate control

The following contains notes and recommendations on optimum use of THERMATIC automatic climate control.

- Activate climate control using the **AUTO** and **A/C REST** buttons. The indicator lamps above the **AUTO** and **A/C REST** buttons light up.
- Set the temperature to 22 °C.
- Only use the demisting function briefly until the windscreen is clear again.
- Only use the air-recirculation mode briefly, e.g. if there are unpleasant outside odours

or when in a tunnel. The windows could otherwise mist up as no fresh air is drawn into the vehicle in air-recirculation mode.

- Use the MONO function to adopt the temperature settings on the driver's side for the front-passenger side as well. The indicator lamp above the **MONO** button goes out.

Control panel for THERMOTRONIC automatic climate control (3-zone)

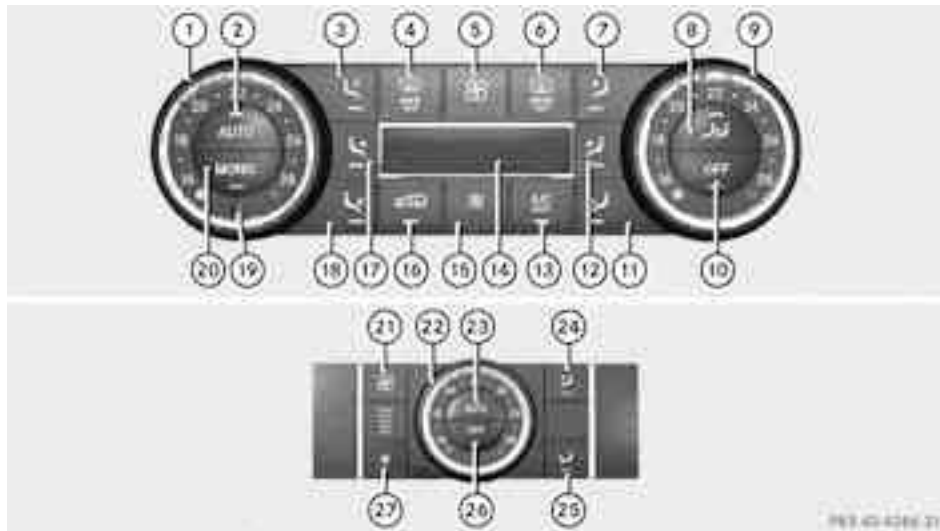

Front control panel

- ① Sets the temperature, left (▷ page 131)
- ② Sets climate control to automatic (▷ page 130)
- ③ Directs the airflow through the demister vents, left (▷ page 131)
- ④ Demists the windscreen (▷ page 132)
- ⑤ Increases the airflow (▷ page 132)
- ⑥ Switches the rear window heating on/off (▷ page 133)
- ⑦ Directs the airflow through the demister vents, right (▷ page 131)
- ⑧ Operates the rear-compartment climate control via the front control panel (▷ page 128)
- ⑨ Sets the temperature, right (▷ page 131)
- ⑩ Switches climate control on/off (▷ page 128)
- ⑪ Directs the airflow to the footwell and side air vents, right (▷ page 131)
- ⑫ Directs the airflow through the centre and side air vents, right (▷ page 131)
- ⑬ Activates/deactivates cooling with air dehumidification (▷ page 129)
Activates/deactivates the residual heat function (▷ page 134)
- ⑭ Display
- ⑮ Reduces the airflow (▷ page 132)
- ⑯ Activates/deactivates air-recirculation mode (▷ page 133)
- ⑰ Directs the airflow through the centre and side air vents, left (▷ page 131)
- ⑱ Directs the airflow to the footwell and side air vents, left (▷ page 131)
- ⑲ Interior temperature sensor
- ⑳ Switches the MONO function on/off (▷ page 132)

Rear control panel

- ⑲ Increases the airflow (▷ page 132)
- ⑳ Sets the temperature (▷ page 131)
- ㉑ Sets the rear-compartment climate control to automatic (▷ page 130)
- ㉒ Directs the airflow through the rear air vents (▷ page 131)
- ㉓ Directs the airflow through the footwell vents (▷ page 131)
- ㉔ Switches rear-compartment climate control on/off (▷ page 128)
- ㉕ Reduces the airflow (▷ page 132)

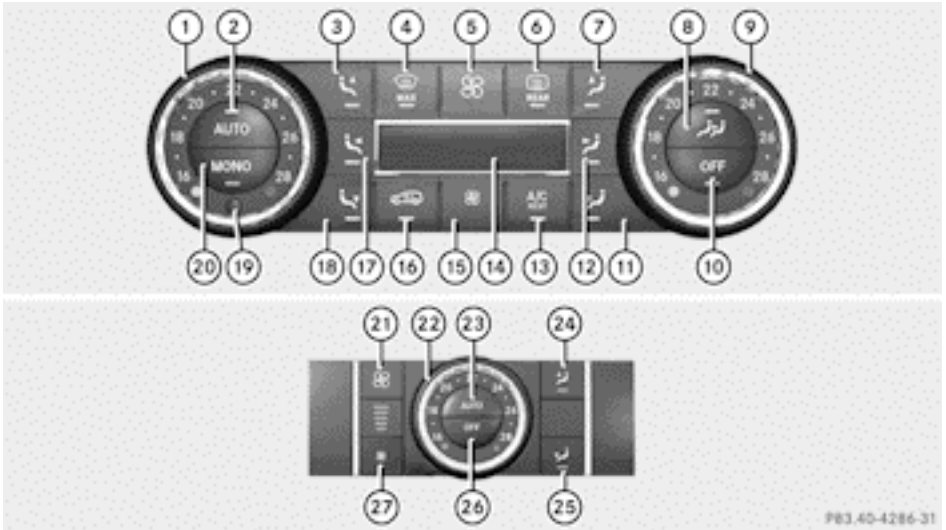

Canada only

Front control panel

- ① Sets the temperature, left (▷ page 131)
- ② Sets climate control to automatic (▷ page 130)
- ③ Directs the airflow through the demister vents, left (▷ page 131)
- ④ Demists the windscreen (▷ page 132)
- ⑤ Increases the airflow (▷ page 132)
- ⑥ Switches the rear window heating on/off (▷ page 133)
- ⑦ Directs the airflow through the demister vents, right (▷ page 131)
- ⑧ Operates the rear-compartment climate control via the front control panel (▷ page 128)
- ⑨ Sets the temperature, right (▷ page 131)
- ⑩ Switches climate control on/off (▷ page 128)
- ⑪ Directs the airflow to the footwell and side air vents, right (▷ page 131)
- ⑫ Directs the airflow through the centre and side air vents, right (▷ page 131)
- ⑬ Activates/deactivates cooling with air dehumidification (▷ page 129)
Activates/deactivates the residual heat function (▷ page 134)



- 14 Display
- 15 Reduces the airflow (▷ page 132)
- 16 Activates/deactivates air-recirculation mode (▷ page 133)
- 17 Directs the airflow through the centre and side air vents, left (▷ page 131)
- 18 Directs the airflow to the footwell and side air vents, left (▷ page 131)
- 19 Interior temperature sensor
- 20 Switches the MONO function on/off (▷ page 132)

Rear control panel

- 21 Increases the airflow (▷ page 132)
- 22 Sets the temperature (▷ page 131)
- 23 Sets the rear-compartment climate control to automatic (▷ page 130)
- 24 Directs the airflow through the rear air vents (▷ page 131)
- 25 Directs the airflow through the footwell vents (▷ page 131)
- 26 Switches rear-compartment climate control on/off (▷ page 128)
- 27 Reduces the airflow (▷ page 132)

Information about using THERMOTRONIC automatic climate control

The following contains instructions and recommendations to enable you to get the most out of your THERMOTRONIC automatic climate control.

- Activate climate control using the **AUTO** and  buttons. The indicator lamps above the **AUTO** and  buttons light up.
- Set the temperature to 22 °C.
- Only use the demisting function briefly until the windscreen is clear again.
- Only use the air-recirculation mode briefly, e.g. if there are unpleasant outside odours or when in a tunnel. The windows could otherwise mist up as no fresh air is drawn into the vehicle in air-recirculation mode.
- Use the MONO function if you want to adopt the temperature and air distribution settings from the driver's side for all climate control zones. The indicator lamp in the **MONO** button lights up.
- Use the residual heat function if you want to heat or ventilate the vehicle interior

when the ignition is switched off. The residual heat function can only be activated or deactivated with the ignition switched off.

Operating the climate control system

Switching climate control on/off

Points to observe before use

- i** If climate control is switched off, the air supply and air circulation are also switched off. Only select this setting briefly. Otherwise, the windows may mist up.
- i** Switch on climate control primarily using the **AUTO** button (▷ page 130).

Switching the front climate control on/off using the front control panel



- ▶ Turn the key to position **2** in the ignition lock.
- ▶ **To switch on:** press the **AUTO** button. The indicator lamp in the **AUTO** button lights up. Airflow and air distribution are set to automatic mode.

or



- ▶ Press button **OFF**. The indicator lamp in the **OFF** button goes out. The previous settings are reactivated.
- ▶ **To switch off:** press the **OFF** button. The indicator lamp in the **OFF** button lights up.



Switching the rear-compartment climate control on/off using the front control panel

THERMATIC automatic climate control

- ▶ Turn the key to position **2** in the ignition lock.
- ▶ **To switch on/off:** press the  button. The indicator lamp in the  button lights up or goes out.
- ▶ **To activate/deactivate:** press the **REAR OFF** button. The indicator lamp in the **REAR OFF** button lights up or goes out.

THERMOTRONIC automatic climate control

- ▶ Turn the key to position **2** in the ignition lock.
- ▶ **To switch on:** press the  button. **ON** and **MODE** appear in the THERMOTRONIC automatic climate control display behind the  symbol. The **MODE** display goes out after three seconds. The display switches back to the standard display.

- ▶ **To switch off:** press the  button. **MODE** appears in the display behind the  symbol.
- ▶ Press button **OFF**. **OFF** appears in the display behind the  symbol.

Switching the rear-compartment climate control on/off using the rear control panel

THERMOTRONIC automatic climate control

- ▶ Turn the key to position **2** in the ignition lock.
- ▶ Switch on THERMOTRONIC automatic climate control using the front control panel.
- ▶ **To switch on:** press the **AUTO** button. The indicator lamp in the **AUTO** button lights up.
- ▶ **To switch off:** press the **OFF** button. The indicator lamp in the **OFF** button lights up.

Activating/deactivating the cooling with air dehumidification function

Points to observe before use

WARNING

If the "cooling with air dehumidification" function is deactivated, the air inside the vehicle will not be cooled (during warm weather) or dehumidified. The windows could mist up more quickly. This may prevent you from observing the traffic conditions, thereby causing an accident.





The cooling with air dehumidification function is only available when the engine is running. The air inside the vehicle is cooled and dehumidified according to the temperature selected.

Condensation may drip from the underside of the vehicle when cooling mode is active. This

is normal and not a sign that there is a malfunction.

- i** The cooling with air dehumidification function uses refrigerant R134a. This refrigerant does not contain chlorofluorocarbons, and therefore does not damage the ozone layer.

Switching on/off

- ▶ **To activate:** press the  button. The indicator lamp in the  button lights up.
- ▶ **To deactivate:** press the  button. The indicator lamp in the  button goes out. The cooling with air dehumidification function has a delayed switch-off feature.

Problems with the cooling with air dehumidification function

If the indicator lamp in the  button does not go out when the function is activated, the cooling with air dehumidification function is deactivated due to a malfunction. You can no longer switch on the cooling with air dehumidification function.

- ▶ Visit a qualified specialist workshop.





Setting climate control to automatic mode

Points to observe before use









In automatic mode, the set temperature is maintained automatically at a constant level. The system automatically regulates the temperature of the dispensed air, the airflow and the air distribution.

Automatic mode will achieve optimal operation if cooling with air dehumidification is also activated. If desired, cooling with air dehumidification can be deactivated.





Controlling the front climate control using the front control panel

- ▶ Turn the key to position **2** in the ignition lock.
- ▶ Set the desired temperature.
- ▶ **To activate:** press the  button. The indicator lamp in the  button lights up. Automatic air distribution and airflow are activated.
- ▶ **To deactivate:** press the  or  button. The indicator lamp in the  button goes out. Automatic airflow is deactivated and the airflow is controlled according to the level set. Automatic air distribution remains activated.

or

- ▶ Press the , , , , ,  or  button. The indicator lamp in the  button goes out. Automatic air distribution is deactivated. Air distribution is controlled according to the position set. Automatic airflow remains activated.

Controlling the rear-compartment climate control automatically using the rear control panel

- ▶ Turn the key to position **2** in the ignition lock.
- ▶ Switch on THERMOTRONIC automatic climate control using the front control panel.
- ▶ Set the desired temperature.
- ▶ **To activate:** press the  button. The indicator lamp in the  button lights up. Automatic air distribution and airflow are activated.
- ▶ **To deactivate:** press the  or  button. Automatic airflow is deactivated and the airflow is controlled according to the level

set. Automatic air distribution remains activated.

or

- ▶ Press either  or .

Automatic air distribution is deactivated. Air distribution is controlled according to the position set. Automatic airflow remains activated.

Setting the temperature

THERMATIC automatic climate control

Different temperatures can be set for the driver's and front-passenger sides.

- ▶ Turn the key to position **2** in the ignition lock.
- ▶ **To increase/reduce:** turn control ① or ⑦ clockwise or anti-clockwise (▷ page 125).

Only change the temperature setting in small increments. Start at 22 °C.

THERMOTRONIC automatic climate control

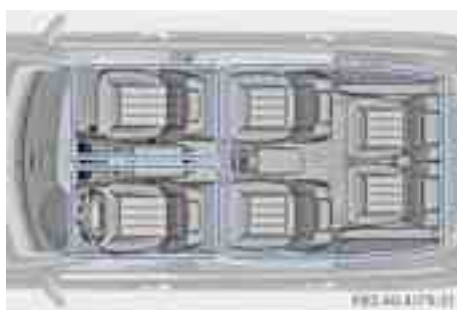

THERMOTRONIC automatic climate control zones

You can select different temperature settings for the driver's and front-passenger sides as well as for the rear compartment.

- ▶ Turn the key to position **2** in the ignition lock.
- ▶ **To increase/reduce the temperature in the front compartment:** turn controls ①

and ⑨ clockwise or anti-clockwise (▷ page 126).

Only change the temperature setting in small increments. Start at 22 °C.

- ▶ **To increase/reduce the temperature in the rear compartment via the front control panel:** turn the key in the ignition lock to position **2**.

- ▶ Press the  button.

The display changes to rear-compartment climate control.

- ▶ Turn control ⑨ clockwise or anti-clockwise (▷ page 126).

Only change the temperature setting in small increments. Start at 22 °C.

- ❗ To return to the standard display, press the  button.

- ❗ The rear display changes to the standard display automatically after three seconds.

- ▶ **To increase/reduce the temperature in the rear compartment via the rear control panel:** turn the key in the ignition lock to position **2**.

- ▶ Turn control ② clockwise or anti-clockwise (▷ page 126).



Only change the temperature setting in small increments. Start at 22 °C.





Setting the air distribution

Air distribution settings



THERMOTRONIC automatic climate control: the air distribution can be set individually for the driver's and front-passenger sides.

Front control panel

-  Directs the airflow through the demister vents
-  Directs the airflow through the demister vents
-  Directs the airflow through the demister vents







-  Directs the airflow through the footwell and side air vents
-  Directs the airflow through the footwell and side air vents
-  Directs the airflow through the centre and side air vents
-  Directs the airflow through the centre and side air vents

Rear control panel



-  Directs the airflow through the rear-compartment air vents
-  Directs the airflow through the footwell air vents

i Using the rear control panel, you can also activate both air distribution positions simultaneously. In order to do this, press both air distribution buttons. The air is then routed through all rear air vents.

Adjusting

- ▶ Turn the key to position **2** in the ignition lock.
- ▶ Press the , , , , ,  or  button.

Setting the airflow



- ▶ Turn the key to position **2** in the ignition lock.
- ▶ **To increase:** press the  button.
- ▶ **To reduce:** press the  button.

Vehicles with LINGUATRONIC: when LINGUATRONIC is switched on, the airflow is restricted to 50%. When command input is complete, the airflow is adjusted back to the previous setting.

i You can use THERMOTRONIC automatic climate control to set the airflow in the rear compartment separately.

Switching the MONO function on/off



The MONO function is only available with THERMOTRONIC automatic climate control². You can use the MONO function to adopt the settings configured for temperature, air distribution and airflow on the driver's side for the front-passenger side and the rear compartment.

- ▶ Press the  button.
The indicator lamp in the  button lights up or goes out.



Demisting the windscreen

You can use this function to demist the windscreen or to demist the inside of the windscreen and the side windows.

Switch off the "demisting" function as soon as the windscreen is clear again.

- ▶ Turn the key to position **2** in the ignition lock.
- ▶ **To activate:** press the  button.
The indicator lamp in the  button lights up.

The climate control system switches to the following functions:

- cooling with air dehumidification on
 - high airflow (depending on the outside temperature)
 - high temperature (depending on the outside temperature)
 - air distribution to the windscreen and front side windows
 - air-recirculation mode off
- ▶ **To deactivate:** press the  button.
The indicator lamp in the  button goes out. The previous settings are reactivated. The cooling with air dehumidification function remains on. Air-recirculation mode remains deactivated.

or

² Canada only.

- ▶ Press the **AUTO** button.
The indicator lamp in the  button goes out. Airflow and air distribution are set to automatic mode.

or

- ▶ Turn control ① or ⑥ clockwise or anti-clockwise (▷ page 125) (THERMATIC automatic climate control), (▷ page 126) (THERMOTRONIC automatic climate control).

or

- ▶ Press the  or  button.

Demisting the windows

Windows misted up on the inside

- ▶ Activate the  cooling with air dehumidification function.
- ▶ Activate automatic mode **AUTO**.
- ▶ If the windows continue to mist up, activate the demisting function (▷ page 132).

i You should only select this setting until the windscreen is clear again.

Windows misted up on the outside

- ▶ Press the  /  or  /  air distribution button.

i You should only select this setting until the windscreen is clear again.

Rear window heating

Switching on/off



WARNING

Clear all windows of ice or snow before setting off. Otherwise, impaired visibility could endanger you and others.

The rear window heating has a high current draw. You should therefore switch it off as soon as the window is clear. It otherwise

switches off automatically after several minutes.

If the battery voltage is too low, the rear window heating may switch off.

- ▶ Turn the key to position **2** in the ignition lock.
- ▶ Press the  button.
The indicator lamp in the  button lights up or goes out.

Problems with the rear window heating

If the indicator lamp in the  rear window heating button flashes, the on-board voltage is too low or the roof is open. The rear window heating has switched off prematurely or cannot be activated.

- ▶ Switch off any consumers that are not required, e.g. reading lamps or interior lighting.
When the battery is sufficiently charged, the rear window heating is activated again automatically.



Activating/deactivating air-recirculation mode

WARNING

Only switch over to air-recirculation mode briefly at low outside temperatures. Otherwise, the windows could mist up, thus impairing visibility and endangering yourself and others. This may prevent you from observing the traffic conditions, thereby causing an accident.



You can deactivate the flow of fresh air if unpleasant odours are entering the vehicle from outside. The air already inside the vehicle will then be recirculated.

The operation of air-recirculation mode is the same for all control panels.

- ▶ Turn the key to position **2** in the ignition lock.
- ▶ **To activate:** press the  button. The indicator lamp in the  button lights up.

i Air-recirculation mode is automatically activated at high levels of pollution or at high outside temperatures. When air-recirculation mode is activated automatically, the indicator lamp in the  button is not lit.

Outside air is added after about 30 minutes.

- ▶ **To deactivate:** press the  button. The indicator lamp in the  button goes out.

i Air-recirculation mode is not deactivated automatically at outside temperatures above 26 °C. Outside air is added after about 30 minutes³.

Air-recirculation mode is not deactivated automatically at outside temperatures above 79 °F (26 °C). Outside air is added after about 30 minutes⁴.



Convenience opening/closing using the air-recirculation button



WARNING

Make sure that nobody can become trapped between the side window and the door frame as the side windows are opened and closed. Make sure that all objects and body parts are clear of the side windows when they are being opened or closed. You or the objects could be drawn in or become trapped between the side window and the door frame as the window moves. If there is a risk of entrapment, operate the  switch to move the side window in the opposite direction.

Make sure that nobody can become trapped as the panorama sliding sunroof is opened

and closed. If there is a risk of entrapment, operate the  switch to move the panorama sliding sunroof in the opposite direction.



- ▶ **Convenience closing feature:** press and hold the  button until the side windows and the sliding sunroof/panorama sliding sunroof are closed. The indicator lamp in the  button lights up. Air-recirculation mode is activated.

- ▶ **Convenience opening feature:** press and hold the  button until the side windows and the sliding sunroof/panorama sliding sunroof are opened. The side windows and the sliding sunroof/panorama sliding sunroof move back to their original position. The indicator lamp in the  button goes out. Air-recirculation mode is deactivated.

i If you open the side windows or the sliding sunroof/panorama sliding sunroof manually after closing them with the convenience closing feature, they will remain in this position when opened using the convenience opening feature.

Activating/deactivating the residual heat function



It is possible to make use of the residual heat of the engine to continue heating the stationary vehicle for up to 30 minutes after the engine has been switched off. The heating time depends on the temperature that has been set for the vehicle interior.

- ▶ **To activate:** press the  button. The indicator lamp in the  button lights up.
- i** The blower will run at a low speed regardless of the airflow setting.
- i** If you activate the residual heat function at high temperatures, only the ventilation

³ Vehicles with THERMOTRONIC automatic climate control.

⁴ Vehicles with THERMOTRONIC automatic climate control.

will be activated. The blower runs at medium speed.

- ▶ **To deactivate:** press the  button. The indicator lamp in the  button goes out.

Residual heat is deactivated automatically:

- after approximately 30 minutes
- when the ignition is switched on
- if the battery voltage drops
- if the coolant temperature is too low

Auxiliary heating

Important safety notes

WARNING

Exhaust fumes are produced when the auxiliary heating is in operation. Inhaling these exhaust fumes can be poisonous. You should therefore switch off the auxiliary heating in confined spaces without an extraction system, e.g. a garage.

WARNING

When operating the auxiliary heating parts of the vehicle can get very hot. Make sure that the exhaust system does not under any circumstances come into contact with easily ignitable material such as dry grass or fuels. The material could otherwise ignite and set the vehicle alight. Choose your parking spot accordingly.

Operating the auxiliary heating is thus prohibited at filling stations or when your vehicle is being refuelled. You must therefore switch off the auxiliary heating at filling stations.

- ❗ Operating the auxiliary heating/ventilation draws on the vehicle battery. After you have heated or ventilated the vehicle a maximum of two times, drive for a longer distance.

- i Switch the auxiliary heating on regularly once a month for about ten minutes.

The auxiliary heating heats the air in the vehicle interior to the set temperature without using the heat of the running engine. The auxiliary heating is operated directly using the vehicle's fuel. For this reason, the tank content must be at least at reserve fuel level to ensure that the auxiliary heating functions. The auxiliary heating/ventilation automatically adjusts to changes in temperature and weather conditions. For this reason, the auxiliary heating could switch from ventilation mode to heating mode or from heating mode to ventilation mode.

The auxiliary heating switches off automatically after 30 minutes. This time limit can be altered. To do this, visit a qualified specialist workshop. Exception: when switching on using the on-board computer, it will continue to run for a maximum of 50 minutes.

You cannot use the auxiliary ventilation to cool the vehicle interior to a temperature lower than the outside temperature.

Before switching on

- ▶ Turn the key to position **2** in the ignition lock.
- ▶ Set the temperature.

The auxiliary heating/ventilation can be activated even when climate control is set to manual. Optimum comfort can be attained when the system is set to automatic mode. Set the temperature to 22 °C.

The auxiliary heating/ventilation can be activated or deactivated using the remote control or the button on the centre console.

The on-board computer can be used to specify up to three departure times, one of which may be preselected (> page 205).

Switching the auxiliary heating/ventilation on/off using the centre console button

The colours of the indicator lamps on the button have the following meanings:

- Blue Auxiliary ventilation switched on
- Red Auxiliary heating switched on
- Yellow Departure time preselected
(▷ page 205)

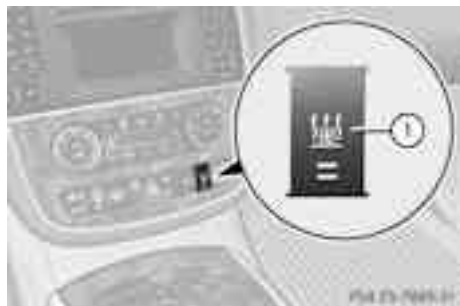

Switch in the centre console

► **To switch auxiliary heating/ventilation on:** if the key is in position **1** or **2** in the ignition lock, press and hold button ① for more than two seconds.

If the key is removed or is in position **0**, briefly press button ①.

The red or blue indicator lamp in button ① lights up.

► **To switch auxiliary heating/ventilation off:** briefly press button ①.

The red or blue indicator lamp in button ① goes out.

Switching the auxiliary heating/ventilation on/off using the remote control

Points to observe before use

Your vehicle comes with one remote control. You may use two additional remote controls for your vehicle. For more information, please contact a qualified specialist workshop.

The remote control has a maximum range of approximately 300 metres. This range is reduced by:

- sources of radio interference
- solid objects between the remote control and the vehicle
- the remote control being in an unfavourable position in relation to the vehicle
- transmitting from an enclosed space

① The optimum range can be achieved if you hold the remote control vertically, pointing upwards when you press one of the buttons.

① A battery symbol appears in the display when the battery in the remote control is low. Replace the remote control battery (▷ page 137).

Switching the auxiliary heating/ventilation on/off



Auxiliary heating remote control

- ① Display
- ② To check the status
- ③ To switch off the auxiliary heating/ventilation
- ④ To switch on the auxiliary heating/ventilation
- ⑤ To check the status

► **To switch on:** press the button. **ON** is shown in the remote control display.

► **To deactivate:** press the button. **OFF** is shown in the remote control display.

Checking the status of the auxiliary heating/ventilation



Auxiliary heating remote control

- ① Display
- ② To check the status
- ③ To switch off the auxiliary heating/ventilation
- ④ To switch on the auxiliary heating/ventilation
- ⑤ To check the status

► Press the or button.

The following messages may appear in the display:

Display	Meaning
	The auxiliary heating/ventilation is switched off.
	The auxiliary ventilation is switched on. The number in the display shows the remaining time (in minutes) for the auxiliary ventilation.
	The auxiliary heating is switched on. The number in the display shows the remaining time (in minutes) for the auxiliary heating.

Heater booster function on vehicles with a diesel engine

The heater booster function helps the engine reach its operating temperature faster during its warm-up phase as well as helps to heat the vehicle interior faster. The heater booster function switches on if outside temperatures are low and the coolant temperature is less than 70 °C.

Replacing the remote control battery

WARNING

Batteries contain poisonous substances.

Swallowing/ingesting batteries can result in serious personal injury or death.

Always keep batteries away from children. If a battery is swallowed, seek immediate medical attention.

Environmental note



Batteries contain pollutants. It is illegal to dispose of them with the household rubbish. They must be collected separately and disposed of in an environmentally responsible recycling system.





Dispose of batteries in an environmentally responsible manner. Take discharged batteries to a qualified specialist workshop or to a collection point for used batteries.



One 6 V pin battery, type 2CR11108 is required.

- ▶ Prise apart the side arms of battery cover ② and pull off battery cover ②.
- ▶ Remove old battery ①.
- ▶ Insert the new battery. Observe the polarity signs on the back of the remote control when doing so.
- ▶ Slide battery cover ② back onto the remote control.
- ▶ Use the remote control to check the vehicle's auxiliary heating functions.

Problems with the auxiliary heating/ventilation

Display messages	Possible causes/consequences and ► Solutions
 FAIL	The signal transmission between the transmitter and the vehicle is faulty. <ul style="list-style-type: none"> ► Change your position in relation to the vehicle, moving closer if necessary. ► Make another attempt to switch the auxiliary heating on or off using the remote control.
 FAIL	there is not enough fuel in the fuel tank, or the auxiliary heating is faulty. <ul style="list-style-type: none"> ► Refuel at the nearest filling station. ► Make another attempt to switch on the auxiliary heating using the remote control. ► Have the auxiliary heating checked at a qualified specialist workshop.
FAIL	The starter battery is not charged sufficiently or the system is faulty. <ul style="list-style-type: none"> ► Charge the starter battery. ► Make another attempt to switch on the auxiliary heating using the remote control. ► Have the auxiliary heating checked at a qualified specialist workshop.

Adjusting the air vents

Important safety notes

 **WARNING**

Very hot or very cold air can flow from the air vents. This could cause burns or frostbite to bare skin in the immediate vicinity of the vents. Keep bare skin away from these air outlets. If necessary, direct the airflow away to a different area of the vehicle interior.

In order to ensure the direct flow of fresh air through the air vents into the vehicle interior, please observe the following notes:

- keep the air inlet grille on the bonnet free of blockages, such as ice, snow or leaves.
- never cover the vents or ventilation grilles in the vehicle interior.

- i** For virtually draught-free ventilation, adjust the sliders of the air vents to the centre position.

Setting the centre air vents



- ① Centre air vent, left
- ② Centre air vent, right
- ③ Centre vent thumbwheel, right
- ④ Centre vent thumbwheel, left

► **To open/close:** turn thumbwheels ③ and ④ up or down.

Setting the side air vents

► **To open/close:** turn thumbwheel ③ up or down.

- i** Side window demister vent ① is never completely shut, even if side air vent ② is shut.

Setting the rear-compartment air vents

Setting the centre vents in the rear compartment

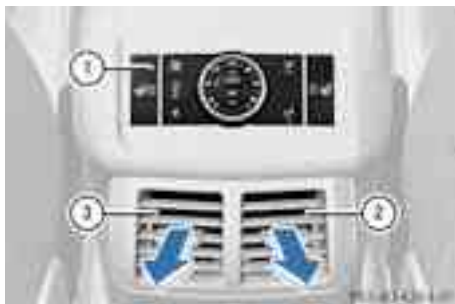

- ① Rear control panel, only with THERMOTRONIC automatic climate control
- ② Rear-compartment air vent, right
- ③ Rear-compartment air vent, left

When the climate control panel is switched on/off, the air supply through the rear-compartment air vents is also switched on/off. These rear-compartment side air vents are only available if you have THERMOTRONIC automatic climate control.

Setting the rear-compartment side air vents

2nd row of seats

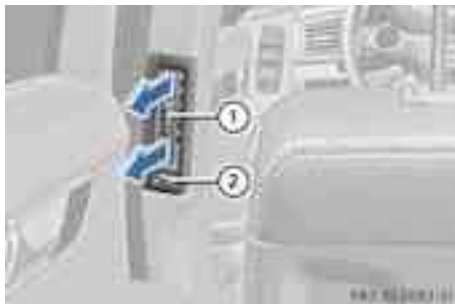

- ① Rear-compartment side air vent
- ② Thumbwheel for rear-compartment side air vent

- ▶ **To open/close:** turn thumbwheel ② to the left or right.

Third row of seats



Rear-compartment side air vent

① Rear-compartment side air vent

② Thumbwheel for rear-compartment side air vent

- ▶ **To open/close:** turn thumbwheel ② up or down.

Useful information	144
Running-in notes	144
Driving	144
Automatic transmission	150
Refuelling	155
Parking	158
Driving tips	160
Driving systems	163
Towing a trailer	184

Useful information

- i** This Owner's Manual describes all models, series and optional equipment for your vehicle that were available at the time of going to press. National variations are possible. Note that your vehicle may not be equipped with all of the functions described. This is also the case for systems and functions relevant to safety.
- i** Read the information on qualified specialist workshops: (▷ page 23).

Running-in notes

Important safety notes

New or replaced brake pads and discs only reach their optimum braking effect after several hundred kilometres of driving. Compensate for the reduced braking effect by applying greater force to the brake pedal.

The first 1,500 km

If you treat the engine with sufficient care from the very start, you will be rewarded with excellent performance for the remainder of the engine's life.

- Drive at varying vehicle speeds and engine speeds for the first 1,500 km.
- Avoid overstraining the vehicle during this period, e.g. driving at full throttle.
- Change gear in good time, before the rev counter needle is $\frac{2}{3}$ of the way to the red area of the rev counter.
- Do not shift down a gear manually in order to brake.
- Try to avoid depressing the accelerator pedal beyond the point of resistance (kick-down).
- The shift ranges **3**, **2** or **1** should only be engaged when driving slowly, e.g. when driving in mountainous terrain.

After 1,500 km, you may gradually accelerate the vehicle to full road and engine speeds.

- i** You should also observe these notes on running in if the engine or parts of the drivetrain on your vehicle have been replaced.

Driving

Important safety notes

WARNING

Objects in the driver's footwell can restrict the pedal travel or obstruct a depressed pedal. The operating and road safety of the vehicle is jeopardised. There is a risk of an accident. Make sure that all objects in the vehicle are stowed correctly, and that they cannot enter the driver's footwell. Fit the floor mats securely and as specified in order to ensure sufficient clearance for the pedals. Do not use loose floor mats.

WARNING

Unsuitable footwear can hinder correct usage of the pedals, e.g.:

- shoes with thick soles
- shoes with high heels
- slippers

There is a risk of an accident.

Wear suitable footwear to ensure correct usage of the pedals.

WARNING

If you switch off the ignition while driving, safety-relevant functions are only available with limitations, or not at all. This could affect, for example, the power steering and the brake boosting effect. You will require considerably more effort to steer and brake. There is a risk of an accident.

Do not switch off the ignition while driving.

⚠ WARNING

If the parking brake has not been fully released when driving, the parking brake can:

- overheat and cause a fire
- lose its hold function.

There is a risk of fire and an accident. Release the parking brake fully before driving off.

! Warm up the engine quickly. Do not use the engine's full performance until it has reached operating temperature.

Only set the automatic transmission to the respective drive positions when the vehicle is stationary.

Where possible, avoid spinning the drive wheels when pulling away on slippery roads. Otherwise, you could damage the drive train.

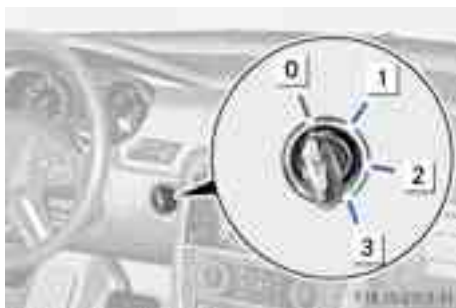
Key positions**Key**

- 0** To remove the key
- 1** Power supply for some consumers, such as the windscreen wipers
- 2** Ignition (power supply for all consumers) and drive position
- 3** To start the engine

i If the key does not belong to the vehicle, it can still be turned in the ignition lock. However, the ignition will not be switched on. The engine cannot be started.

KEYLESS-GO**General notes**

- Do not keep the KEYLESS-GO key together with:
 - with electronic devices, e.g. a mobile phone or another key
 - with metallic objects, e.g. coins or metal foil
 - inside metallic objects, e.g. a metal case
 This can impair the functionality of the KEYLESS-GO key.

Vehicles with KEYLESS-GO are equipped with a key featuring an integrated KEYLESS-GO function and a detachable Start/Stop button. The Start/Stop button must be inserted in the ignition lock and the key must be in the vehicle.

Pressing the Start/Stop button several times in succession corresponds to the different key positions in the ignition lock. This is only the case if you are not depressing the brake pedal.

If you depress the brake pedal and press the Start/Stop button, the engine starts immediately.

i The engine can be turned off while the vehicle is in motion by pressing and holding the Start/Stop button for approximately three seconds. This function operates independently of the ECO start/stop automatic engine switch-off function.

Key positions with KEYLESS-GO

Switching on the power supply

- ▶ If Start/Stop button ① has not yet been pressed, this corresponds to the key being removed from the ignition.
- ▶ Press Start/Stop button ① once. The power supply is switched on. You can now activate the windscreen wipers, for example.

- ① The power supply is switched off again if:
 - the driver's door is opened
 - you press Start/Stop button ① twice when in this position.

Switching on the ignition

- ▶ Press Start/Stop button ① twice. The ignition is switched on.
- ① The power supply is switched off again if:
 - the driver's door is opened
 - you press Start/Stop button ① once when in this position.

Removing the Start/Stop button



You can remove the Start/Stop button from the ignition lock and start the vehicle as normal using the key.

- ▶ Remove Start/Stop button ① from ignition lock ②.
- ① You do not have to remove the Start/Stop button from the ignition lock when you leave the vehicle.
- ① It is only possible to switch between KEY-LESS-GO mode and key operation when the transmission is in position **P**.

- ① When you insert Start/Stop button ① into ignition lock ②, the system needs approximately two seconds recognition time. You can then use Start/Stop button ①.

Starting the engine

Important safety notes

WARNING

Combustion engines emit poisonous exhaust gases such as carbon monoxide. Inhaling these exhaust gases leads to poisoning. There is a risk of fatal injury. Therefore never leave the engine running in enclosed spaces without sufficient ventilation.

- ⚠ Do not depress the accelerator pedal when starting the engine.

General notes

- ① **Vehicles with a petrol engine:** the catalytic converter is preheated for up to 30seconds after a cold start. The sound of the engine may change during this time.



Automatic transmission

- ▶ Shift the transmission to position **P** (▷ page 151). The transmission position display in the multifunction display shows **P**.
- ① You can also start the engine when the transmission is in position **N**.

Starting procedure with the key

- ▶ **To start a petrol engine:** turn the key to position **3** in the ignition lock

(▷ page 145) and release it as soon as the engine is running.

- ▶ **To start a diesel engine:** turn the key to position **2** in the ignition lock (▷ page 145).
The  preglow indicator lamp in the instrument cluster lights up.
- ▶ When the  preglow indicator lamp goes out, turn the key to position **3** (▷ page 145) in the ignition lock and release it as soon as the engine is running.

- i** You can start the engine without preglow if the engine is warm.
- i** To start the engine using the key instead of KEYLESS-GO, pull the Start/Stop button out of the ignition lock.

Using KEYLESS-GO to start the engine

WARNING

Your vehicle can be started using a valid KEYLESS-GO key. For this reason, children should never be left unsupervised in the vehicle. Always take the key with you when leaving the vehicle, even if you are only leaving it for a short time.

- ▶ Depress the brake pedal and keep it depressed.
- ▶ **To start a petrol engine:** press the Start/Stop button (▷ page 145) once.
The engine starts.
- ▶ **To start a diesel engine:** press the Start/Stop button (▷ page 145) once.
Preglow is activated and the engine starts.
- i** The Start/Stop button can be used to start the vehicle without inserting the key into the ignition lock. The key must be in the vehicle and the Start/Stop button must be inserted in the ignition lock.

Pulling away

Automatic transmission

WARNING

If the engine speed is above the idling speed and you engage transmission position **D** or **R**, the vehicle could pull away suddenly. There is a risk of an accident.

When engaging transmission position **D** or **R**, always firmly depress the brake pedal and do not simultaneously accelerate.

- ▶ Depress the brake pedal and keep it depressed.
- ▶ Shift the transmission to position **D** or **R**.
- ▶ Release the parking brake (▷ page 159).
- ▶ Release the brake pedal.
- ▶ Carefully depress the accelerator pedal.
- i** It is only possible to shift the transmission from position **P** to the desired position if you depress the brake pedal. Only then is the parking lock released.
- i** The vehicle locks centrally once you have pulled away. The locking knobs in the doors drop down.
You can open the doors from the inside at any time.
You can also deactivate the automatic locking feature (▷ page 204).
- i** Upshifts take place at higher engine speeds after a cold start. This helps the catalytic converter to reach its operating temperature more quickly.

Hill start assist

WARNING

After a short time, hill start assist will no longer brake your vehicle and it could roll away. There is a risk of an accident and injury.

Therefore, quickly move your foot from the brake pedal to the accelerator pedal. Never leave the vehicle when it is held by hill start assist.

- ▶ Take your foot off the brake pedal.
The vehicle is then held for about a second.
- ▶ Pull away.

Hill start assist helps you when pulling away forwards or in reverse on an uphill gradient. It holds the vehicle for a short time after you have removed your foot from the brake pedal. This gives you enough time to move your foot from the brake pedal to the accelerator pedal and depress it before the vehicle begins to roll.

Hill start assist will not function if:

- you are pulling away on a level road or a downhill gradient
- the transmission is in position **N**
- the parking brake is applied
- ESP® is malfunctioning.

Problems with the engine	
Problem	Possible causes/consequences and ► Solutions
The engine does not start. The starter motor can be heard.	<ul style="list-style-type: none"> • There is a malfunction in the engine electronics. • There is a malfunction in the fuel supply. <p>► Before attempting to start the engine again, turn the key in the ignition back to position 0 or press the Start/Stop button repeatedly until all indicator lamps in the instrument cluster go out.</p> <p>► Try to start the engine again (▷ page 146). Avoid excessively long and frequent attempts to start the engine, as this will drain the battery.</p> <p>If the engine does not start after several attempts:</p> <p>► Consult a qualified specialist workshop.</p>
The engine does not start. The starter motor can be heard. The reserve fuel warning lamp is lit and the fuel gauge display shows 0 .	<p>The fuel tank is empty.</p> <p>► Refuel the vehicle.</p>
The engine does not start. You cannot hear the starter motor.	<p>The on-board voltage is too low because the battery is too weak or discharged.</p> <p>► Jump-start the vehicle (▷ page 304).</p> <p>If the engine does not start despite attempts to jump-start it:</p> <p>► Consult a qualified specialist workshop.</p> <p>The starter motor was exposed to a thermal load that was too high.</p> <p>► Allow the starter motor to cool down for approximately two minutes.</p> <p>► Try to start the engine again.</p> <p>If the engine still does not start:</p> <p>► Consult a qualified specialist workshop.</p>
Vehicles with a petrol engine: The engine is not running smoothly and is misfiring.	<p>There is a malfunction in the engine electronics or in a mechanical component of the engine management system.</p> <p>► Only depress the accelerator pedal slightly. Otherwise, non-combusted fuel may get into the catalytic converter and damage it.</p> <p>► Have the cause rectified immediately at a qualified specialist workshop.</p>

Problem	Possible causes/consequences and ► Solutions
The coolant temperature display is showing more than 120 °C. A warning tone will also sound.	<p>The coolant level is too low. The coolant is too hot and the engine is no longer being cooled sufficiently.</p> <ul style="list-style-type: none"> ► Stop as soon as possible and allow the engine and the coolant to cool down. ► Check the coolant level (► page 281). Observe the warning notes as you do so and top up the coolant if necessary.
	<p>If the coolant level is correct, the radiator fan may be faulty. The coolant is too hot and the engine is no longer being cooled sufficiently.</p> <ul style="list-style-type: none"> ► If the coolant temperature is below 120 °C, you can continue driving to the nearest qualified specialist workshop. ► Avoid heavy loads on the engine as you do so, e.g. driving in mountainous terrain and stop-start traffic.
The engine can no longer be switched off.	<p>The ignition lock is defective.</p> <ul style="list-style-type: none"> ► Open the fuse box in the engine compartment (► page 310). ► Use the fuse extractor to remove fuse 120. The engine switches off. <p>When you want to start the engine again:</p> <ul style="list-style-type: none"> ► Replace the fuse.

Automatic transmission

Important safety notes

WARNING

If the engine speed is above the idling speed and you engage transmission position **D** or **R**, the vehicle could pull away suddenly. There is a risk of an accident.

When engaging transmission position **D** or **R**, always firmly depress the brake pedal and do not simultaneously accelerate.

DIRECT SELECT lever

Overview of transmission positions

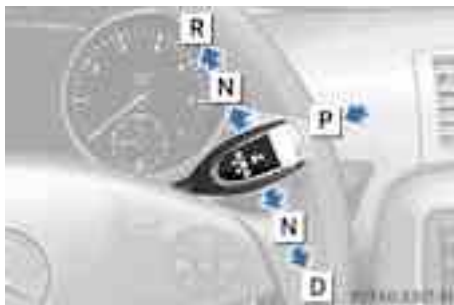

P Park position with parking lock

R Reverse gear

N Neutral

D Drive

The DIRECT SELECT lever is on the right of the steering column.

- i** The DIRECT SELECT lever always returns to its original position. The current transmission position **P**, **R**, **N** or **D** appears in the transmission position display (▷ page 151) in the multifunction display.

Engaging park position **P**

- !** If the engine speed is too high, do not shift the automatic transmission directly from **D** to **R**, from **R** to **D** or directly to **P**. Otherwise, the automatic transmission could be damaged.

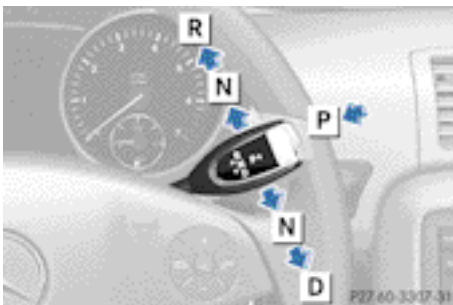

P Park position with parking lock

R Reverse gear

N Neutral

D Drive

- ▶ Push the DIRECT SELECT lever in the direction of arrow **P**.

- i** The automatic transmission shifts into park position **P** automatically:
- if you open the driver's door while the vehicle is stationary in transmission position **D** or **R**
 - if you open the door while travelling at very low speeds in transmission position **D** or **R**
- i** Depressing the brake and pushing the DIRECT SELECT lever up or down disengages the parking lock. The transmission is in **N** neutral.

In order to shift from park position **P** directly into **R** or **D**:

- depress the brake pedal and
- push the DIRECT SELECT lever up or down past the first point of resistance

Engaging reverse gear **R**

- !** Only shift the automatic transmission to **R** when the vehicle is stationary.
- ▶ Push the DIRECT SELECT lever up past the first point of resistance.

Shifting to neutral (**N**)

- ▶ Push the DIRECT SELECT lever up or down to the first point of resistance.

Engaging drive position **D**

- ▶ Push the DIRECT SELECT lever down past the first point of resistance.

Transmission position display

- !** If the transmission position display in the multifunction display is not working, you should pull away carefully to check whether the desired transmission position is engaged. Ideally, you should select transmission position **D** and drive program **E** or **S**. Do not restrict the shift range.



- ① Transmission position

The current transmission position is shown in the multifunction display.

- i** The arrows in the transmission position display show how and into which transmission positions you can change using the DIRECT SELECT lever.

Transmission positions

P

Park position

This prevents the vehicle from rolling away when stopped. Do not shift the transmission into position **P** (▷ page 158) unless the vehicle is stationary.

The automatic transmission shifts to **P** automatically if you:

- remove the key
- switch off the engine when in **R** or **D** and open one of the front doors

R

Reverse gear

Only shift the transmission to **R** when the vehicle is stationary.

N

Neutral

Do not shift the transmission to **N** while driving. Otherwise, the automatic transmission could be damaged.

No power is transmitted from the engine to the drive wheels.

Releasing the brakes will allow you to move the vehicle freely, e.g. to push it or tow it.

If ESP® is deactivated or faulty: only shift the transmission to position **N** if the vehicle is in danger of skidding, e.g. on icy roads.

If you switch off the engine using the key or the Start/Stop button, the automatic transmission shifts to neutral **N** automatically.

! Rolling in neutral **N** can lead to damage to the transmission.

D

Drive

The automatic transmission changes gear automatically. All forward gears are available.

Changing gear

The automatic transmission shifts to the individual gears automatically when it is in transmission position **D**. Gearshifting is determined by:

- a shift range restriction, if selected
- the selected drive program **E/S** (▷ page 153)
- the position of the accelerator pedal
- the road speed

Driving tips

Accelerator pedal position

Your style of driving influences how the automatic transmission shifts gear:

- little throttle: early upshifts
- more throttle: late upshifts

Kickdown

Use kickdown for maximum acceleration:

- ▶ Depress the accelerator pedal beyond the pressure point.
The transmission shifts to a lower gear depending on the engine speed.
- ▶ Ease off the accelerator pedal once the desired speed is reached.
The automatic transmission shifts back up.

Towing a trailer

- ▶ Drive in the middle of the engine speed range on uphill gradients.
- ▶ Shift down to shift range **3** or **2** (▷ page 154) depending on the uphill or downhill gradient, even if cruise control, DISTRONIC PLUS or SPEEDTRONIC is activated.

Program selector button

General notes



Program selector button

- ▶ Press program selector button ① repeatedly until the letter for the desired gearshift program appears in the multifunction display.

The program selector button allows you to choose between different driving characteristics.

- i** The automatic transmission switches to automatic drive program **E** each time the engine is started.
- i** **All models with a diesel engine:** to reduce the demand placed on the torque converter, the vehicle pulls away in first gear regardless of the gearshift program selected.

E Economy	Comfortable, economical driving
S Sport	Sporty driving style

- i** For further information on the automatic drive program, see (▷ page 153).

Steering wheel gearshift paddles



- ① Left-hand steering wheel gearshift paddle
- ② Right-hand steering wheel gearshift paddle

You can restrict or derestrict the shift range by using the steering wheel gearshift paddles.

Automatic drive program

Drive program **E** is characterised by the following:

- comfort-oriented engine settings.
- optimal fuel consumption resulting from the automatic transmission shifting up sooner
- the vehicle pulling away more gently in forward and reverse gears, unless the accelerator pedal is depressed fully
- increased sensitivity. This improves driving stability on slippery road surfaces, for example
- the automatic transmission shifting up sooner. This results in the vehicle being driven at lower engine speeds and the wheels being less likely to spin

Drive program **S** is characterised by the following:

- sporty engine settings
- the vehicle pulling away in first gear

- the automatic transmission shifting up later
- as a result of the later automatic transmission shift points, the fuel consumption possibly being higher

Shift ranges

Introduction

When the automatic transmission is in position **D**, it is possible to restrict or derestrict the shift range (▷ page 154).

The shift range selected is shown in the multifunction display. The automatic transmission shifts only as far as the selected gear.

Shift range

3	To use the engine's braking effect
2	To use the braking effect of the engine on downhill gradients and for driving: <ul style="list-style-type: none"> • on steep mountain roads • in mountainous terrain • in arduous conditions
1	To use the braking effect of the engine on extremely steep downhill gradients and on long downhill stretches

Restricting the shift range/shifting down

- ▶ Pull the left-hand steering wheel gearshift paddle.
- i** If the engine exceeds the maximum engine speed when shifting down, the automatic transmission protects against engine damage by not shifting down.

Derestricting the shift range/shifting up

- ▶ Pull the right-hand steering wheel gearshift paddle.

- i** If the maximum engine speed for the shift range is reached and you continue to accelerate, the automatic transmission shifts up, even if the shift range is restricted.

Clearing the shift range restriction

- ▶ Pull the right-hand steering wheel gearshift paddle until the number for the gear disappears from the multifunction display.

or

- ▶ Shift the transmission to position **D**. The automatic transmission shifts from the current shift range directly to **D**.

Selecting the ideal shift range

- ▶ Pull the left-hand steering wheel gearshift paddle and hold it in position. The automatic transmission shifts to the gear which allows optimum acceleration and deceleration. To do this, the automatic transmission shifts down one or more gears.

Problems with the transmission

Problem	Possible causes/consequences and ► Solutions
The transmission has problems shifting gear.	The transmission is losing oil. ► Have the transmission checked at a qualified specialist workshop immediately.
The acceleration ability is deteriorating. The transmission no longer changes gear.	The transmission is in emergency mode. It is only possible to shift into second gear and reverse gear. ► Stop. ► Shift the transmission to position P . ► Switch off the engine. ► Wait at least ten seconds before restarting the engine. ► Have the transmission checked at a qualified specialist workshop immediately.

Refuelling

Important safety notes

WARNING

Fuel is highly flammable. Fire, naked flames and smoking are therefore prohibited when handling fuels.

Switch off the engine and the auxiliary heating before refuelling.

WARNING

Avoid contact with fuels.

It is hazardous to your health if your skin comes into direct contact with fuels or you breathe in fuel vapours.

WARNING

Do not use petrol to refuel a diesel tank. Never mix diesel with petrol. Doing so could damage the fuel system and the engine. The vehicle could also catch fire.

-  Do not use petrol to refuel vehicles with a diesel engine. Do not use diesel to refuel vehicles with a petrol engine. Even small amounts of the wrong fuel result in damage to the fuel system and the engine.

-  Do not switch on the ignition if you accidentally refuel with the wrong fuel. Otherwise, the fuel will enter the fuel lines. Notify a qualified specialist workshop and have the fuel tank and fuel lines drained completely.

-  Overfilling the fuel tank could damage the fuel system.

-  Take care not to spill any fuel on painted surfaces. You could otherwise damage the paintwork.

-  Use a filter when adding fuel from a fuel can. The fuel lines and/or the diesel injection system could otherwise be blocked by particles from the fuel can.

Further information on fuel and on fuel grades can be found in the "Fuel" section (> page 339).

Refuelling

Opening/closing the fuel filler flap



- ① To open the fuel filler flap
- ② To insert the fuel filler cap
- ③ Fuel type to be refuelled
- ④ Tyre pressure table

The fuel filler flap is unlocked or locked automatically when you open or close the vehicle with the key or using KEYLESS-GO.

The position of the fuel filler cap is displayed  in the instrument cluster. The arrow next to the filling pump indicates the side of the vehicle.

Opening

- ▶ Switch off the engine.
- ▶ Remove the key from the ignition lock.
- ▶ KEYLESS-GO: open the driver's door. This corresponds to key position **0**: "key removed". The driver's door can be closed again.
- ▶ Press the fuel filler flap in the direction of arrow ①. The fuel filler flap opens slightly.
- ▶ Open the fuel filler flap fully.
- ▶ Turn the fuel filler flap anti-clockwise and remove it.
- ▶ Insert the fuel filler cap into the holder bracket on the inside of filler flap ②.

- ▶ Completely insert the filler neck of the fuel pump nozzle into the tank and refuel.
- ▶ Only fill the tank until the pump nozzle switches off.

i Do not add any more fuel after the pump stops filling for the first time. Otherwise, fuel may leak out.

Closing

- ▶ Replace the cap on the filler neck and turn clockwise until it engages audibly.
- ▶ Close the fuel filler flap.

i Close the fuel filler flap before locking the vehicle. Otherwise, the locking pin of the central locking prevents the fuel filler flap from closing.

Fuel filler flap emergency release

- ▶ Open the tailgate.



- ▶ Open the right-hand side trim panel (▷ page 119).
- ▶ Pull emergency release ① in the direction of the arrow. The fuel filler flap is released.
- ▶ Open the fuel filler flap.

Problems with the fuel and fuel tank	
Problem	Possible causes/consequences and ► Solutions
Fuel is leaking from the vehicle.	<p> Risk of explosion or fire</p> <p>The fuel line or the fuel tank is faulty.</p> <ul style="list-style-type: none"> ► Turn the key to position 0 in the ignition lock immediately and remove it (▷ page 145). ► Do not restart the engine under any circumstances. ► Consult a qualified specialist workshop.
The engine does not start.	<p>The fuel tank of a vehicle with a diesel engine has been run completely dry.</p> <ul style="list-style-type: none"> ► Refuel the vehicle with at least 5 litres of diesel. ► Turn the ignition on for approximately ten seconds (▷ page 145). ► Start the engine continuously for a maximum of ten seconds until it runs smoothly. <p>If the engine does not start:</p> <ul style="list-style-type: none"> ► Turn the ignition on again a maximum of ten seconds (▷ page 145). ► Start the engine again continuously for a maximum of ten seconds until it runs smoothly. <p>If the engine does not start after three attempts:</p> <ul style="list-style-type: none"> ► Consult a qualified specialist workshop.
The fuel filler flap cannot be opened.	<p>The fuel filler flap is not unlocked.</p> <p>or</p> <p>The key battery is discharged.</p> <ul style="list-style-type: none"> ► Unlock the vehicle using the emergency key element (▷ page 72). ► Open the tailgate. ► Manually unlock the fuel filler flap using the emergency release (▷ page 156). <p>The fuel filler flap is unlocked, but the opening mechanism is jammed.</p> <ul style="list-style-type: none"> ► Consult a qualified specialist workshop.

Parking

Important safety notes

WARNING

If flammable materials such as leaves, grass or twigs are exposed to prolonged contact to parts of the exhaust system that heat up, they could ignite. There is a risk of fire.

Park the vehicle so that no flammable materials come into contact with parts of the vehicle which are hot. Take particular care not to park on dry grassland or harvested grain fields.

WARNING

If you switch off the ignition while driving, safety-relevant functions are only available with limitations, or not at all. This could affect, for example, the power steering and the brake boosting effect. You will require considerably more effort to steer and brake. There is a risk of an accident.

Do not switch off the ignition while driving.

WARNING

If you leave children unsupervised in the vehicle, they could set it in motion by, for example:

- releasing the parking brake
- shifting the automatic transmission out of the parking position **P**
- starting the engine.

They could also operate the vehicle's equipment. There is a risk of an accident and injury.

When leaving the vehicle, always take the key with you and lock the vehicle. Never leave children unsupervised in the vehicle.

 A moving vehicle can lead to damage to the vehicle or damage to the drive train.

To ensure that the vehicle is secured against rolling away unintentionally:

- the parking brake must be applied
- the transmission must be in position **P** and the key must be removed from the ignition lock
- on steep uphill or downhill gradients, turn the front wheels towards the kerb
- on steep uphill or downhill gradients, the front axle of an empty vehicle must be secured, for example with a wheel chock
- on steep uphill or downhill gradients, the rear axle of a laden vehicle must be additionally secured, for example with a wheel chock.

Switching off the engine

Important safety notes

WARNING

The automatic transmission switches to neutral position **N** when you switch off the engine. The vehicle may roll away. There is a risk of an accident.

After switching off the engine, always switch to parking position **P**. Prevent the parked vehicle from rolling away by applying the parking brake.

Vehicles with automatic transmission

- ▶ Engage the parking brake firmly.
- ▶ Shift the transmission to position **P**.

Using the key

- ▶ Turn the key to position **0** in the ignition lock and remove it.

The immobiliser is activated.

-  If you switch the engine off with the transmission in position **R** or **D**, the automatic transmission shifts to **N** automatically.

If you then open one of the front doors or remove the key from the ignition, the automatic transmission shifts to **P**.

If you shift the automatic transmission to **N** before switching off the engine, the automatic transmission remains in **N** even if a door is opened.

Using KEYLESS-GO

- ▶ Press the Start/Stop button (▷ page 145). The engine stops and all the indicator lamps in the instrument cluster go out.
- i** When the driver's door is closed, this corresponds to key position **1**. When the driver's door is open, this corresponds to key position **0**, i.e. key removed.
- i** If you use the Start/Stop button to switch off the engine, the automatic transmission shifts to **N** automatically. If you then open one of the front doors, the automatic transmission shifts to **P**.
- i** The engine can be switched off while the vehicle is in motion by pressing and holding the Start/Stop button for three seconds.

Parking brake

WARNING

If you must brake the vehicle with the parking brake, the braking distance is considerably longer and the wheels could lock. This increases the risk of skidding and an accident.

Only use the parking brake to brake the vehicle when the service brake is faulty. Do not apply the parking brake too firmly. If the wheels lock, release the parking brake until the wheels begin turning again.

WARNING

If you leave children unsupervised in the vehicle, they could set it in motion by, for example:



- releasing the parking brake
- shifting the automatic transmission out of the parking position **P**
- starting the engine.

They could also operate the vehicle's equipment. There is a risk of an accident and injury.

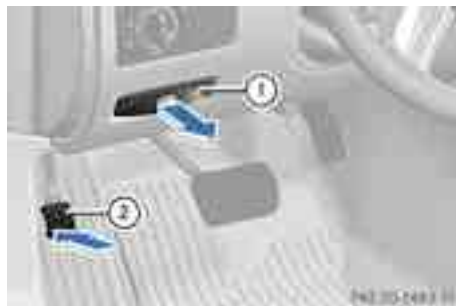
When leaving the vehicle, always take the key with you and lock the vehicle. Never leave children unsupervised in the vehicle.



If you brake the vehicle with the parking brake, the brake lamps will not light up.

- ▶ **To apply:** depress parking brake **(2)** firmly. The  indicator lamp in the instrument cluster lights up if the engine is running.
- ▶ **To release:** depress the brake pedal and keep it depressed.
- ▶ Pull release handle **(1)**. The  indicator lamp in the instrument cluster goes out.

Parking up the vehicle

If you leave the vehicle parked up for longer than four weeks, the battery may be damaged by exhaustive discharging.

- ▶ Disconnect the battery or connect it to a trickle charger.
- i** You can obtain information about trickle chargers from a qualified specialist workshop.

If you leave the vehicle parked up for longer than six weeks, the vehicle may suffer damage as a result of lack of use.

- ▶ Visit a qualified specialist workshop and seek advice.

Driving tips

General notes

Important safety notes

WARNING

If you switch off the ignition while driving, safety-relevant functions are only available with limitations, or not at all. This could affect, for example, the power steering and the brake boosting effect. You will require considerably more effort to steer and brake. There is a risk of an accident.

Do not switch off the ignition while driving.

Drive sensibly – save fuel

Observe the following tips to save fuel:

- ▶ The tyres should always be inflated to the recommended tyre pressure.
- ▶ Remove unnecessary loads.
- ▶ Remove roof carriers when they are not needed.
- ▶ Warm up the engine at low engine speeds.
- ▶ Avoid frequent acceleration or braking.
- ▶ observe the service intervals in the Service Booklet or in the service interval display. Have all the maintenance work carried in accordance with Daimler AG regulations.

Fuel consumption also increases when driving in cold weather, in stop-start traffic and in hilly terrain.

Engine oil

! **Vehicles with a diesel particle filter:** if the vehicle is mostly driven for short distances, it is possible that malfunctions may occur during the automatic cleaning of the diesel particle filter. This may lead to fuel collecting in the engine oil and cause engine failure. Therefore, if you frequently drive short distances, you should take a 20 minute trip on a motorway or rural road at least every 500km.

Brakes

Important safety notes

WARNING

If you shift down on a slippery road surface in an attempt to increase the engine's braking effect, the drive wheels could lose their grip. This increases the risk of skidding and having an accident.

Do not shift down for additional engine braking on a slippery road surface.

Downhill gradients

Do not depress the brake pedal continuously while the vehicle is in motion, e.g. never cause the brakes to rub by applying constant slight pedal pressure. This results in excessive and premature wear to the brake pads.

On long and steep downhill gradients, you must select shift range **1, 2** or **3** in good time. This especially important if the vehicle is laden or towing a trailer.

i This also applies if you have activated cruise control, SPEEDTRONIC or DIS-TRONIC PLUS.

This will use the braking effect of the engine, so less braking will be required to prevent the vehicle from gaining speed. This relieves the load on the brake system and prevents the brakes from overheating and wearing too quickly.

Heavy and light loads

WARNING

The braking system can overheat if you leave your foot on the brake pedal while driving. This increases the braking distance and could even cause the braking system to fail. There is a risk of an accident.

Never use the brake pedal as a footrest. Do not simultaneously depress both the brake pedal and the accelerator pedal while driving.

! Depressing the brake pedal constantly results in excessive and premature wear to the brake pads.

If the brakes have been subjected to a heavy load, do not stop the vehicle immediately. Drive on for a short while. This allows the airflow to cool the brakes more quickly.

If the brakes have been used only moderately, you should occasionally test their effectiveness. To do this, brake more firmly from a higher speed. This improves the grip of the brakes.

Wet road surfaces

If you have driven for a long time in heavy rain without braking, there may be a delayed reaction from the brakes when braking for the first time. This may also occur after the vehicle has been washed or driven through deep water. You have to depress the brake pedal more firmly. Maintain a greater distance from the vehicle in front.

After driving on a wet road or having the vehicle washed, brake firmly while paying attention to the traffic conditions. This will warm up the brake discs, thereby drying them more quickly and protecting them against corrosion.

Limited braking performance on salt-treated roads

If you drive on salted roads, a layer of salt residue may form on the brake discs and brake pads. This can result in a significantly longer braking distance.

- Brake occasionally to remove any possible salt residue. Make sure that you do not endanger other road users when doing so.
- Carefully depress the brake pedal at the beginning and end of a journey.
- Maintain a greater distance to the vehicle ahead.

New brake pads/linings

New and replaced brake pads and discs only reach their optimum braking effect after several hundred kilometres of driving. Compensate for this by applying greater force to the brake pedal.

For safety reasons, Mercedes-Benz recommends that you only have brake pads/linings fitted to your vehicle which have been approved for Mercedes-Benz vehicles or which correspond to an equivalent quality standard. Brake pads/linings which have not been approved for Mercedes-Benz vehicles or which are not of an equivalent quality could affect your vehicle's operating safety.

Parking brake

WARNING

If you must brake the vehicle with the parking brake, the braking distance is considerably longer and the wheels could lock. This increases the risk of skidding and an accident.

Only use the parking brake to brake the vehicle when the service brake is faulty. Do not apply the parking brake too firmly. If the wheels lock, release the parking brake until the wheels begin turning again.

If you brake the vehicle with the parking brake, the brake lamps will not light up.

If you drive on wet roads or dirt-covered surfaces, road salt and/or dirt could get into the parking brake.

In order to prevent corrosion and a reduction in the braking power of the parking brake, observe the following:

- Gently depress the parking brake from time to time before beginning the journey.
- Drive for approximately 100 m at a maximum speed of 20 km/h.

Driving on wet roads

Aquaplaning

If water has accumulated to a certain depth on the road surface, there is a danger of aquaplaning occurring, even if:

- you are driving at low speeds
- the tyres have adequate tread depth.

For this reason, do not drive in tyre ruts and brake carefully.

Driving on flooded roads

! Bear in mind that vehicles travelling in front or in the opposite direction create waves. This may cause the maximum permissible water depth to be exceeded.

These notes must be observed under all circumstances. You could otherwise damage the engine, the electronics or the transmission.

If you have to drive on stretches of road on which water has collected, please bear in mind that:

- the maximum permissible still water depth is 25 cm
- you should drive no faster than at walking pace.

Winter driving

General notes

WARNING

If you shift down on a slippery road surface in an attempt to increase the engine's braking effect, the drive wheels could lose their grip. This increases the risk of skidding and having an accident.

Do not shift down for additional engine braking on a slippery road surface.

DANGER

If the exhaust pipe is blocked or adequate ventilation is not possible, poisonous gases

such as carbon monoxide (CO) may enter the vehicle. This is the case, e.g. if the vehicle becomes trapped in snow. There is a risk of fatal injury.

If you leave the engine or the auxiliary heating running, make sure the exhaust pipe and area around the vehicle are clear of snow. To ensure an adequate supply of fresh air, open a window on the side of the vehicle that is not facing into the wind.

! Take care not to damage the sealing strip and the moulding on the side of the rear window when scraping ice off the rear window.

Have your vehicle winterproofed at a qualified specialist workshop at the onset of winter.

Driving with summer tyres

Observe the notes in the "Winter operation" section (▷ page 314).

Slippery road surfaces

WARNING

If you shift down on a slippery road surface in an attempt to increase the engine's braking effect, the drive wheels could lose their grip. This increases the risk of skidding and having an accident.

Do not shift down for additional engine braking on a slippery road surface.

If the vehicle threatens to skid or cannot be stopped when moving at low speed:

- ▶ Move the transmission to position **N**.
- ▶ Try to bring the vehicle under control by using corrective steering.

i For more information on driving with snow chains, see (▷ page 315).

You should drive particularly carefully on slippery road surfaces. Avoid sudden acceleration, steering and braking manoeuvres.

Driving systems

Cruise control

Important safety notes

WARNING

Do not change down for additional engine braking on a slippery road surface. This could cause the drive wheels to lose their grip and the vehicle could skid.

WARNING

Cruise control cannot take account of road and traffic conditions.

Always pay attention to traffic conditions even when cruise control is activated.

Cruise control is only an aid designed to assist driving. You are responsible for the vehicle's speed and for braking in good time.

WARNING

Do not use cruise control

- in traffic conditions that do not allow you to drive at a constant speed (e.g. heavy traffic or winding roads). You may otherwise cause an accident.
- on slippery roads. The drive wheels may lose their grip when braking or accelerating and the vehicle may skid.
- when there is low visibility, e.g. due to fog, heavy rain or snow.

WARNING

The brake pedal is retracted when cruise control brakes. The movement of the pedals must not be impaired in any way.

- Do not put any objects in the footwell.
- Ensure that floor mats and carpets are fixed securely. In particular, do not place several floor mats on top of one another.
- Do not place your foot under the brake pedal as it could become trapped.

General notes

Cruise control maintains a constant road speed for you. It brakes automatically in order to avoid exceeding the set speed. On long and steep downhill gradients, especially if the vehicle is laden or towing a trailer, you must select shift range **1**, **2** or **3** in good time. By doing so, you will make use of the braking effect of the engine. This relieves the load on the brake system and prevents the brakes from overheating and wearing too quickly.

Use cruise control only if road and traffic conditions make it appropriate to maintain a steady speed for a prolonged period. You can store any road speed above 30 km/h.

Cruise control lever

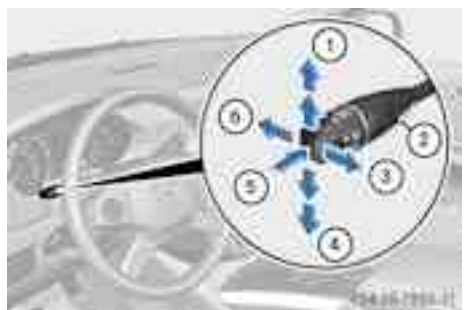

- ① To activate or increase speed
- ② LIM indicator lamp
- ③ To activate at the current speed/last stored speed
- ④ To activate or reduce speed
- ⑤ To switch between cruise control and variable SPEEDTRONIC
- ⑥ To deactivate cruise control

You can operate cruise control and variable SPEEDTRONIC with the cruise control lever.

- **To switch between variable SPEEDTRONIC and cruise control:** press the cruise control lever in the direction of arrow ⑤.

LIM indicator lamp ② on the cruise control lever indicates which function you have selected:

- **LIM indicator lamp ② off:** cruise control is selected.
- **LIM indicator lamp ② on:** variable SPEEDTRONIC is selected.

When you activate cruise control, the stored speed is shown in the multifunction display.

Activation conditions

To activate cruise control, all of the following activation conditions must be fulfilled:

- the parking brake must be released.
- you are driving faster than 30 km/h.
- ESP® must be switched on, but not intervening.
- the transmission must be in position **D**.
- the cruise control function must be selected (▷ page 163).

Storing, maintaining and calling up a speed

Storing and maintaining the speed

- ▶ Accelerate the vehicle to the desired speed.
- ▶ Briefly press the cruise control lever up ① or down ④.
- ▶ Remove your foot from the accelerator pedal.
Cruise control is activated. The vehicle automatically maintains the stored speed.

You can accept the current speed if you are driving faster than 30 km/h.

- ❗ Cruise control may be unable to maintain the stored speed on uphill gradients. The stored speed is resumed when the gradient evens out. Cruise control maintains the stored speed on downhill gradients by automatically applying the brakes.

Storing or calling up the speed

⚠ WARNING

Only call up a stored speed if you know what that speed is and if it is suitable for the current traffic and driving situation. You can otherwise endanger yourself or others by unintentionally triggering sudden acceleration or braking.

- ▶ Briefly pull the cruise control lever towards you ③.
- ▶ Remove your foot from the accelerator pedal.
The first time cruise control is activated, it stores the current speed or regulates the speed of the vehicle to the previously stored speed.

Setting a speed

- ▶ Press the cruise control lever up ① for a higher speed or down ④ for a lower speed.
- ▶ Keep the cruise control lever pressed until the desired speed is reached.
- ▶ Release the cruise control lever.
The new speed is stored.
- ▶ **Setting in 1-km/h increments:** press the cruise control lever up ① or down ④ to the pressure point.
The last speed stored is increased or reduced in 1 km/h increments.
- ▶ **To adjust the set speed in 10-km/h increments:** press the cruise control lever briefly up ① or down ④ beyond the pressure point.
The last speed stored is increased or reduced in 10 km/h increments.

- ❗ Cruise control is not deactivated if you depress the accelerator pedal. For example, if you accelerate briefly to overtake, cruise control adjusts the vehicle's speed to the last speed stored after you have finished overtaking.

Deactivating cruise control

There are several ways to deactivate cruise control:

- ▶ Briefly press the cruise control lever forwards **6**.

or

- ▶ Brake

or

- ▶ Briefly press the cruise control lever in the direction of arrow **5**.

Variable SPEEDTRONIC is selected. LIM indicator lamp **2** in the cruise control lever lights up.

Cruise control is automatically deactivated if:

- you depress the parking brake.
- you are driving at less than 30 km/h.
- ESP® intervenes or you deactivate ESP®.
- you shift the transmission to position **N** while driving.

If cruise control is deactivated, you will hear a warning tone. You will see the **Cruise control Off** message in the multifunction display for approximately five seconds.

- i** The last speed stored is cleared when you switch off the engine.

SPEEDTRONIC

Important safety notes

WARNING

Never depress the brake pedal continuously while the vehicle is in motion, e.g. never cause the brakes to rub by applying constant slight pedal pressure. This causes the brake system to overheat, increases the braking distance and can lead to the brakes failing completely.

WARNING

Do not change down for additional engine braking on a slippery road surface. This could cause the drive wheels to lose their grip and the vehicle could skid.

WARNING

SPEEDTRONIC is only an aid designed to assist driving. You are responsible for the vehicle's speed and for braking in good time.

WARNING

If there is a change of drivers, advise the new driver of the limit speed stored.

Only use variable SPEEDTRONIC if you will not have to accelerate suddenly to a speed above that stored as the limit speed. You could otherwise cause an accident.

You can only exceed the limit speed stored if you deactivate variable SPEEDTRONIC:

- using the cruise control lever
- by depressing the accelerator pedal beyond the pressure point (kickdown)

It is not possible to deactivate variable SPEEDTRONIC by braking.

WARNING

Variable SPEEDTRONIC brakes automatically in order to avoid exceeding the set speed. As it does so, the brake pedal is depressed. The movement of the pedals must not be impaired in any way.

- Do not put any objects in the footwell.
- Ensure that floor mats and carpets are fixed securely. Do not place several floor mats on top of one another.
- Do not place your foot under the brake pedal as it could become trapped.

General notes

SPEEDTRONIC brakes automatically so that you do not exceed the set speed. On long and steep downhill gradients, especially if the vehicle is laden or towing a trailer, you must select shift range **1**, **2** or **3** in good time. By doing so, you will make use of the braking effect of the engine. This relieves the load on the brake system and prevents the brakes from overheating and wearing too quickly. If you need additional braking, depress the

brake pedal repeatedly rather than continuously.

You can set a variable or permanent limit speed:

- **variable** for speed limits, e.g. in built-up areas
- **permanent** for long-term speed restrictions, e.g. when driving with winter tyres fitted (► page 167)

i The speed indicated in the speedometer may differ slightly from the limit speed stored.

Variable SPEEDTRONIC

Cruise control lever

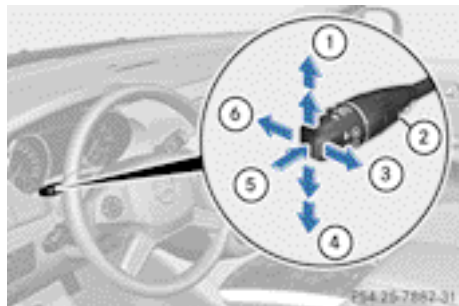

- ① To activate or increase speed
- ② LIM indicator lamp
- ③ To activate at the current speed/last stored speed
- ④ To activate or reduce speed
- ⑤ To switch between cruise control or DISTRONIC and variable SPEEDTRONIC
- ⑥ To deactivate variable SPEEDTRONIC

With the cruise control lever, you can operate cruise control or DISTRONIC and variable SPEEDTRONIC.

► **To switch between variable SPEEDTRONIC and cruise control/DISTRONIC:** press the cruise control lever in the direction of arrow ⑤.

LIM indicator lamp ② on the cruise control lever indicates which function you have selected:

- **LIM indicator lamp ② off:** cruise control or DISTRONIC is selected.
- **LIM indicator lamp ② on:** variable SPEEDTRONIC is selected.

You can use the cruise control lever to limit the speed to any speed above 30 km/h while the engine is running.

Storing the current speed

You can use the cruise control lever to limit the speed to any speed above 30 km/h while the engine is running.

- Briefly press the cruise control lever up ① or down ④ .
The current speed is stored and shown in the multifunction display.
The LIM indicator lamp in the instrument cluster lights up.

Storing the current speed and calling up the last stored speed

⚠ WARNING

Only select a stored speed if you know what that speed is and whether it is suitable for the current driving and traffic situation. Otherwise, sudden braking could endanger you or others.

- Briefly pull the cruise control lever towards you ③.

Setting a speed

- **To adjust the set speed in 10 km/h increments:** briefly press the cruise control lever up ① past the pressure point for a higher speed, or down ④ for a lower speed.

or

- Keep the cruise control lever pressed beyond the pressure point until the desired speed is set. Press the cruise control lever

up ① for a higher speed or down ④ for a lower speed.

- ▶ **To adjust the set speed in 1 km/h increments:** briefly press the cruise control lever up ① to the pressure point for a higher speed, or down ④ for a lower speed.

or

- ▶ Keep the cruise control lever pressed to the pressure point until the desired speed is set. Press the cruise control lever up ① for a higher speed or down ④ for a lower speed.

Deactivating variable SPEEDTRONIC

WARNING

It is not possible to deactivate variable Speedtronic by braking.

There are several ways to deactivate variable SPEEDTRONIC:

- ▶ Briefly press the cruise control lever forwards ⑥.

The LIM indicator lamp in the instrument cluster goes out.

or

- ▶ Briefly press the cruise control lever in the direction of arrow ⑤.

LIM indicator lamp ② in the cruise control lever goes out. Variable SPEEDTRONIC is deactivated.

Cruise control or DISTRONIC is selected.

If you depress the accelerator pedal beyond the pressure point (kickdown), variable SPEEDTRONIC is automatically deactivated, but only if your current speed does not differ by more than 20 km/h from the stored speed. You will hear a warning tone if this is the case.

- ▶ **i** The last speed stored is cleared when you switch off the engine.

Permanent SPEEDTRONIC

You can use the on-board computer to limit the speed permanently to a value between

160 km/h (e.g. for driving on winter tyres) and the maximum speed (▷ page 204).

Shortly before the stored speed is reached, it appears in the multifunction display.

Permanent SPEEDTRONIC remains active, even if variable SPEEDTRONIC is deactivated.

You cannot exceed the stored limit speed, even if you depress the accelerator pedal beyond the pressure point (kickdown).

DISTRONIC

Important safety notes

WARNING

The brake pedal is retracted when DISTRONIC brakes. Do not restrict the movement of the pedal in any way.

- Do not put any objects in the footwell.
- Ensure that floor mats and carpets are fixed securely. In particular, do not place several floor mats on top of one another.
- Do not place your foot under the brake pedal as it could become trapped.

You could otherwise cause an accident and injure yourself and others.

WARNING

Do not change down for additional engine braking on a slippery road surface. This could cause the drive wheels to lose their grip and the vehicle could skid.

WARNING

DISTRONIC is only an aid designed to assist driving. The driver remains fully responsible for the vehicle's distance from other vehicles, the vehicle's speed and for braking in good time.

DISTRONIC does not react in particular to:

- pedestrians
- stationary obstacles on the road, e.g. stopped or parked vehicles
- oncoming and crossing traffic

DISTRONIC may not detect narrow vehicles driving in front, e.g. motorcycles, or vehicles driving on a different line. Therefore, always pay attention to traffic conditions even when DISTRONIC is activated. Otherwise, you may fail to recognise dangers in time, cause an accident and injure yourself and others.

WARNING

DISTRONIC cannot take account of road and traffic conditions. If DISTRONIC does not recognise or no longer recognises the vehicle in front, do not activate it or, if it is already active, deactivate it. This is especially the case:

- before corners
- on filter lanes
- when changing to a lane with faster moving traffic
- in complex driving situations or where lanes are diverted, e.g. at roadworks on a motorway

DISTRONIC otherwise maintains the current speed set by you or accelerates up to the set speed.

DISTRONIC cannot take account of weather conditions. Deactivate, or do not activate, DISTRONIC:

- if the roads are slippery, snow-covered or icy. The wheels could lose their grip when braking or accelerating. The vehicle could start to skid.
- if a sensor is dirty or there is poor visibility, e.g. due to snow, rain or fog. Distance control may be impaired.

Always pay attention to traffic conditions even when DISTRONIC is activated. Otherwise, you may fail to recognise dangers in time, cause an accident and injure yourself and others.

WARNING

DISTRONIC brakes your vehicle up to a maximum of 4 m/s^2 depending on its speed. This corresponds to approximately 40 % of your

vehicle's maximum braking power. You must also apply the brakes yourself if this braking power is not sufficient.

If DISTRONIC detects a risk of collision with a vehicle in front, an intermittent warning tone sounds. In addition, the  distance warning lamp in the instrument cluster lights up. Brake to avoid a collision.

 DISTRONIC is not available in all countries.

DISTRONIC regulates the speed and automatically helps you maintain the distance to the vehicle detected in front. DISTRONIC brakes automatically so that the set speed is not exceeded.

On long and steep downhill gradients, especially if the vehicle is laden or towing a trailer, you must select shift range **1**, **2** or **3** in good time. By doing so, you will make use of the braking effect of the engine. This relieves the load on the brake system and prevents the brakes from overheating and wearing too quickly.

If DISTRONIC detects a slower-moving vehicle in front, your vehicle is braked in order to maintain the preset distance to the vehicle in front.

If no vehicles are driving in front of you, DISTRONIC works like cruise control in the speed range between 30 km/h and 200 km/h. If a vehicle is driving in front of you, DISTRONIC operates in the speed range between 0 km/h and 200 km/h.

Do not use DISTRONIC on roads with steep gradients.

Cruise control lever

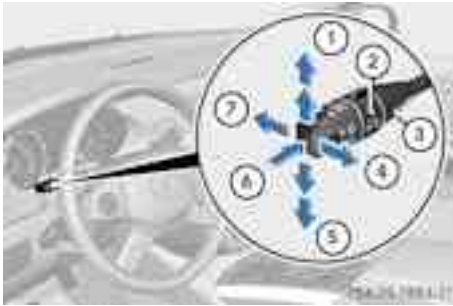

- ① To store the current speed or a higher speed
- ② To set the specified minimum distance
- ③ LIM indicator lamp
- ④ To store the current speed and calling up the last stored speed
- ⑤ To store the current speed or a lower speed
- ⑥ To switch between DISTRONIC and variable SPEEDTRONIC
- ⑦ To deactivate DISTRONIC

You can operate DISTRONIC and variable SPEEDTRONIC with the cruise control lever.

The LIM indicator lamp on the cruise control lever indicates which system you have selected:

- **LIM indicator lamp off:** DISTRONIC is selected
- **LIM indicator lamp on:** variable SPEEDTRONIC is selected

Selecting DISTRONIC

- ▶ Check whether LIM indicator lamp ③ is off. If it is off, DISTRONIC is already selected. If it is not, press the cruise control lever in the direction of arrow ④. LIM indicator lamp ③ in the cruise control lever goes out. DISTRONIC is selected.

Switching on DISTRONIC, storing and maintaining the current speed

Important safety notes

⚠ WARNING

The vehicle can be braked when DISTRONIC is activated. For this reason, deactivate DISTRONIC if the vehicle is to be set in motion by other means (e.g. in a car wash or by towing).

⚠ WARNING

If you depress the brake pedal, DISTRONIC is deactivated. DISTRONIC will then no longer brake your vehicle. In such cases, control the distance from vehicles travelling in front with the brake alone. You could otherwise cause an accident and thereby injure yourself and others. The driver remains fully responsible for the vehicle's distance from other vehicles, the speed being driven and for braking in good time.

⚠ WARNING

DISTRONIC must never be operated, activated or deactivated by a passenger or from outside the vehicle.

You can activate DISTRONIC in the following circumstances:

- if the engine has been started and you have been driving for up to two minutes
- while driving, except if you brake
- the parking brake is released
- if ESP® is activated
- if the transmission is in position **D**

Activating while driving

- ▶ Briefly pull the cruise control lever towards you ④ or press it up ① or down ⑤ to the pressure point.
DISTRONIC is activated.
- ▶ Keep the cruise control lever pressed up ① or down ⑤ until the desired speed is set.
- ▶ Remove your foot from the accelerator pedal.
Your vehicle adapts its speed to that of the vehicle in front, but only up to the desired stored speed.

When driving at speeds below 30 km/h, you can only activate DISTRONIC if the vehicle in front has been detected and is shown in the multifunction display. If the vehicle in front is no longer detected and displayed, DISTRONIC switches off and you will hear a tone.

- i** You can use the cruise control lever to set the stored speed and the control on the cruise control lever to set the specified minimum distance (▷ page 171).
- i** If you do not fully release the accelerator pedal, the **DISTRONIC Override** message appears in the multifunction display. The set distance to a slower-moving vehicle in front will then not be maintained. You will be driving at the speed you determine by the position of the accelerator pedal.

Driving

If there is no vehicle in front, DISTRONIC operates in the same way as cruise control. If DISTRONIC detects that the vehicle in front has slowed down, it brakes your vehicle. In this way, the distance you have selected is maintained.

If DISTRONIC detects that the vehicle in front is driving faster, it accelerates your vehicle, but only up to the stored speed.

Stopping

If DISTRONIC detects that the vehicle in front is stopping, it brakes your vehicle until it is stationary.

- i** Depending on the specified minimum distance, your vehicle will come to a standstill at a sufficient distance behind the vehicle in front. The specified minimum distance is set using the control on the cruise control lever.

DISTRONIC is deactivated automatically when stopping:

- on flat stretches of road or on downhill gradients when the vehicle is stationary
- while the vehicle is still moving on uphill gradients, to prevent the vehicle from unexpectedly rolling back when DISTRONIC is deactivated

If DISTRONIC is deactivated, you will hear a warning tone.

- ▶ To prevent the vehicle from rolling away, depress the brake pedal or engage the parking brake.

Setting a speed

- ▶ Press the cruise control lever up ① for a higher speed or down ⑤ for a lower speed.
- ▶ Keep the cruise control lever pressed until the desired speed is reached.
- ▶ Release the cruise control lever.
The new speed is stored. DISTRONIC is activated and adjusts the vehicle's speed to the new speed stored.
- ▶ **To adjust the set speed in 1 km/h increments:** briefly press the cruise control lever up ① or down ⑤ to the pressure point.
The last stored speed increases or decreases in 1 km/h increments.
- ▶ **To adjust the set speed in 10-km/h increments:** press the cruise control lever briefly up ① or down ⑤ beyond the pressure point.
The last stored speed increases or decreases in 10 km/h increments.

- i** DISTRONIC is not deactivated if you depress the accelerator pedal. If you accelerate to overtake, DISTRONIC adjusts the

vehicle's speed to the last speed stored after you have finished overtaking.

Storing the current speed or calling up the last stored speed

WARNING

Only call up a stored speed if you know what that speed is and if it is suitable for the current traffic and driving situation. You can otherwise endanger yourself or others by unintentionally triggering sudden acceleration or braking.

- ▶ Briefly pull the cruise control lever towards you ④.
- ▶ Remove your foot from the accelerator pedal.
DISTRONIC is activated and accepts the current speed if it is activated for the first time, or adjusts the vehicle's speed to the last speed stored.

Setting the specified minimum distance

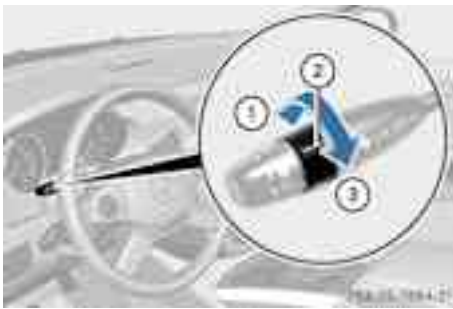

You can set the specified minimum distance for DISTRONIC by varying the time span between one and two seconds. This time span determines the distance that DISTRONIC should maintain from the vehicle in front, depending on the road speed. You can see this distance in the multifunction display (▶ page 171).

- ▶ **To increase:** turn control ② in direction ③.

DISTRONIC then maintains a greater distance between your vehicle and the vehicle in front.

- ▶ **To decrease:** turn control ② in direction ①.

DISTRONIC then maintains a shorter distance between your vehicle and the vehicle in front.

- i** Make sure that you maintain the minimum distance to the vehicle in front as required by law. Adjust the distance to the vehicle in front if necessary.

DISTRONIC displays in the speedometer





When DISTRONIC is activated, one or two segments in the set speed range light up.

- i** For design reasons, the speed displayed in the speedometer may differ slightly from the speed set for DISTRONIC.

If DISTRONIC detects a vehicle in front, segments ② between speed of the vehicle in front ① and stored speed ③ light up.

DISTRONIC displays in the multifunction display

General notes

- ▶ Press the  or  button to select the **DISTRONIC** menu (▶ page 196).

Display when DISTRONIC is deactivated

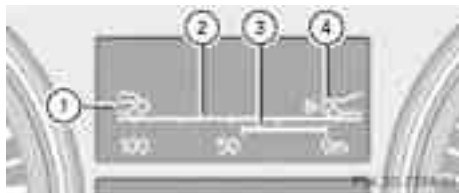

- ① Vehicle in front, if detected
- ② Distance indicator, displaying current distance to the vehicle in front
- ③ Specified minimum distance to the vehicle in front; adjustable
- ④ Own vehicle

Display when DISTRONIC is activated



- ① DISTRONIC activated
- ② Stored speed

When activating DISTRONIC and when setting the speed, stored speed ② appears for around five seconds.

Deactivating DISTRONIC

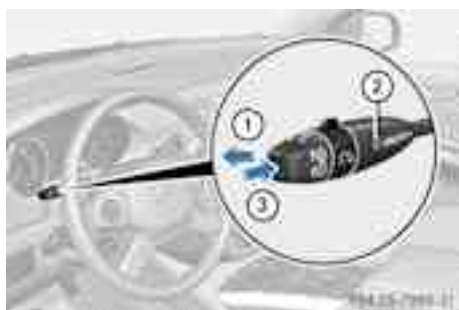

There are several ways to deactivate DISTRONIC:

► Briefly press the cruise control lever forwards ①.

or

► Brake

or

► Briefly press the cruise control lever in the direction of arrow ③.

Variable SPEEDTRONIC is selected. LIM indicator lamp ② in the cruise control lever lights up.

i The last speed stored remains stored until you switch off the engine.

DISTRONIC is automatically deactivated if:

- you engage the parking brake.
- you are driving slower than 25 km/h and there is no vehicle in front, or if the vehicle in front is no longer detected.
- ESP® intervenes or you deactivate ESP®.
- you shift the transmission to **P**, **R** or **N**.

If DISTRONIC is deactivated, you will hear a warning tone. You will see the **DISTRONIC Off** message in the multifunction display for approximately five seconds.

Tips for driving with DISTRONIC

General notes

The following contains descriptions of certain road and traffic conditions in which you must be particularly attentive. In such situations, brake if necessary. DISTRONIC is then deactivated.

Cornering, going into and coming out of a bend

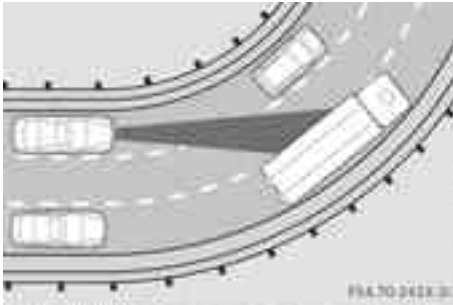

The ability of DISTRONIC to detect vehicles when cornering is limited. Your vehicle may brake unexpectedly or late.

Vehicles travelling on a different line

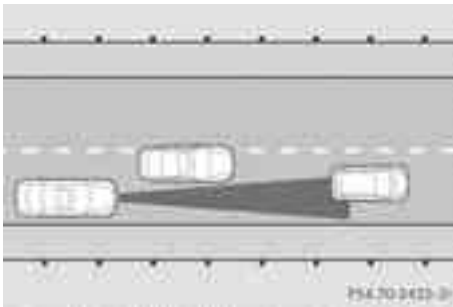

DISTRONIC may not detect vehicles travelling on a different line. The distance to the vehicle in front will be too short.

Other vehicles changing lane

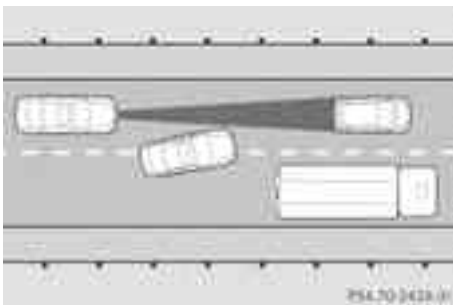

DISTRONIC has not yet detected the vehicle cutting in. The distance to this vehicle will be too short.

Narrow vehicles

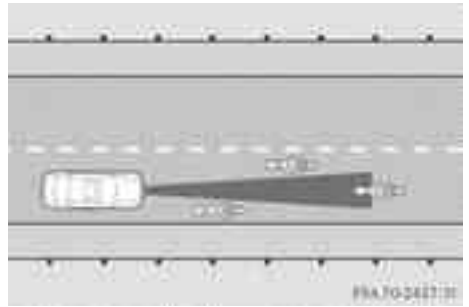

DISTRONIC has not yet detected the vehicle in front on the edge of the carriageway, because of its narrow width. The distance to the vehicle in front will be too short.

Obstructions and stationary vehicles

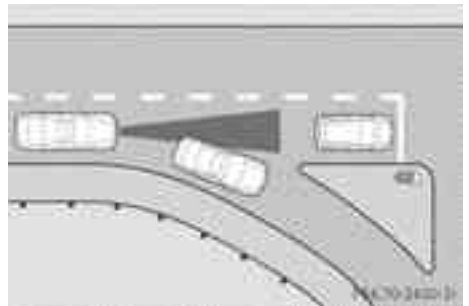

DISTRONIC does not brake for obstructions or stationary vehicles. If, for example, the detected vehicle turns a corner and reveals an obstacle or stationary vehicle, DISTRONIC will not brake for these.

Crossing vehicles

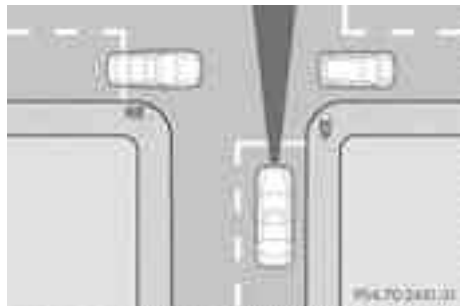

DISTRONIC may detect vehicles that are crossing your lane by mistake. Activating DISTRONIC at, for example, a traffic light with crossing traffic, could cause your vehicle to pull away at the wrong time.

Rear axle level control

Rear axle level control regulates the vehicle level at the rear axle. The benefit of this is that the vehicle level at the rear axle is kept constant regardless of the load.

Observe the notes on driving with a trailer (▷ page 184).

AIRMATIC package

General notes

AIRMATIC enables a suspension tuning setting to be selected and regulates the damping behaviour and level of your vehicle. The system comprises two components. These are ADS (▷ page 174) and the level control (▷ page 174).

Observe the notes on driving with a trailer (▷ page 184).

ADS (Adaptive Damping System)

ADS adapts the damping characteristics to the current operating and driving situation.

This depends on:

- your driving style
- the road surface conditions
- the ADS setting
- the vehicle level setting

Your selection remains stored even if you remove the key from the ignition lock.

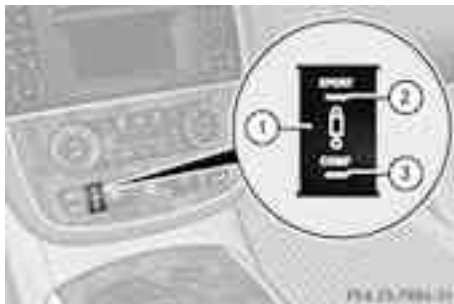

- ▶ Start the engine.
- ▶ Press button ① repeatedly until the desired setting is selected.

You can choose between the following ADS settings:

- **AUTO** for normal driving situations; indicator lamps ② and ③ are off.
- **SPORT** for sporty driving; indicator lamp ② is on.
- **COMF** for a more comfortable ride; indicator lamp ③ is on.

Level control

Important safety notes

⚠ WARNING

Make sure that nobody is near the wheel arch or vehicle underside when you make a change to the vehicle level. Otherwise, you or others may be trapped.

⚠ WARNING

Always select as low a vehicle level as possible. If the vehicle level is high, the vehicle centre of gravity shifts upwards. This increases the risk of the vehicle tipping over.

Adapt your driving style to suit the vehicle level. ESP® cannot reduce the risk of an accident if you drive too fast. ESP® cannot override the laws of physics.

- !** When driving on extremely rough terrain, select a high vehicle level in good time. Make sure there is always sufficient ground clearance. You will otherwise damage the vehicle.

General notes

Level control adapts the vehicle level automatically to the current operating and driving situation. This results in reduced fuel consumption and improved handling.

Make changes to the vehicle level while the vehicle is in motion. This enables the vehicle to adjust to the new level as quickly as possible.

The vehicle level may change visibly if you park the vehicle and the outside temperature changes. If the temperature drops, the vehicle level lowers; with an increase in temperature, the vehicle level rises.

If you unlock the vehicle or open a door, the vehicle begins to compensate for load discrepancies while still parked. However, for significant level changes, e.g. after the vehicle has been stationary for a long period, the engine must be on. For safety reasons, the vehicle is only lowered when the doors are closed. Lowering is interrupted if a door is opened; it continues once the door has been closed.

Basic settings

Select raised level for very poor road conditions or highway level for normal road conditions.

The vehicle is automatically lowered to high-speed level when you:

- drive faster than 140 km/h
- drive at a speed between 120 km/h and 140 km/h for approximately 20 seconds

The individual vehicle levels differ from highway level as follows:

- raised level: +50 mm
- highway level: +/- 0 mm
- high-speed level: -12 mm

i High-speed level is not available when a trailer is being towed. Observe the notes on driving with a trailer (▷ page 184).

i Observe the speed limits. Drive carefully and at a suitable speed.

Raised level

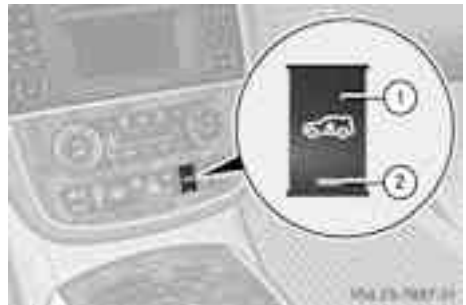

▶ Start the engine.

Indicator lamp ② is not lit:





▶ Press button ①.

Indicator lamp ② flashes. The vehicle rises to raised level.



Example: vehicles with the AIRMATIC package and compass

During the adjustment, the **Rising** message, for example, appears in the multifunction display.

If you press the , ,  or  button on the multifunction steering wheel, the message will disappear.

Once the vehicle has reached raised level, indicator lamp ② remains lit. The **Raised level** message appears for approximately five seconds in the multifunction display.

If you select raised level at a speed above 40 km/h, the **Level selection not permitted** message appears in the multifunction display.

The vehicle is automatically lowered to highway level if you drive faster than 40 km/h at raised level.

Only select raised level if this is appropriate for the road conditions. Otherwise, fuel consumption may increase and handling may be affected.

Highway level

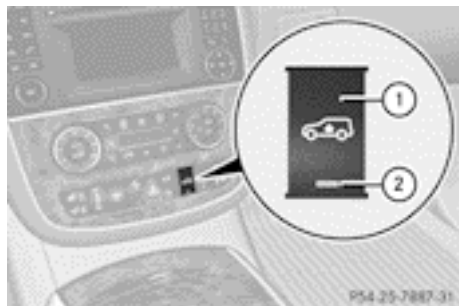

- ▶ Make sure that the doors are closed.
- ▶ Start the engine.





If indicator lamp ② is lit:

- ▶ Press button ①.
Indicator lamp ② flashes. The vehicle is lowered to highway level.



Example: vehicles with the AIRMATIC package and compass

During the adjustment, the **being lowered** message, for example, appears in the multifunction display.

If you press the , ,  or  button on the multifunction steering wheel, the message will disappear.

Once highway level has been reached, indicator lamp ② goes out. The **AIRMATIC** message appears for approximately five seconds in the multifunction display.

The vehicle is automatically lowered to highway level if you drive faster than 40 km/h at raised level. It is automatically raised to highway level if you drive slower than 60 km/h at high-speed level.

4MATIC (permanent all-wheel drive)

WARNING

4MATIC cannot reduce the risk of an accident if you drive too fast.

If a drive wheel spins due to insufficient grip:

- only depress the accelerator pedal as far as necessary when pulling away.
- accelerate less when driving.
- adapt your driving style to suit road and traffic conditions.

! Never tow the vehicle with one axle raised. This may damage the transfer case. Damage of this sort is not covered by the Mercedes-Benz implied warranty. All wheels must remain either on the ground or be fully raised. Observe the instructions for towing the vehicle with all wheels in full contact with the ground.

! When testing the parking brake, operate the vehicle only briefly (for a maximum of ten seconds) on a brake test dynamometer. When doing this, turn the key to position **0** or **1** in the ignition. Failure to do this can cause damage to the drive train or the brake system.

! A function or performance test should only be carried out on a twin-axle dyna-

momenter. Before you operate the vehicle on such a dynamometer, please consult a qualified workshop. You could otherwise damage the drive train or the brake system.

4MATIC ensures that all four wheels are permanently driven. Together with ESP® and 4ETS, it improves the traction of your vehicle whenever a drive wheel spins due to insufficient grip.

- i** In wintry driving conditions, the maximum effect of 4MATIC can only be achieved if you use winter tyres (M+S tyres), with snow chains if necessary.

PARKTRONIC

Important safety notes

⚠ WARNING

PARKTRONIC is only an aid and may not detect all obstacles. It is not a substitute for attentive driving.

You are always responsible for safety and must continue to pay attention to your immediate surroundings when parking and manoeuvring. You could otherwise endanger yourself and others.

⚠ WARNING

Make sure that no persons or animals are in the manoeuvring range. Otherwise, they could be injured.

PARKTRONIC is an electronic parking aid with ultrasonic sensors. It indicates visually and audibly the distance between your vehicle and an object.

PARKTRONIC is activated automatically if you:

- switch on the ignition
- shift the transmission to position **D**, **R** or **N**
- release the parking brake

PARKTRONIC is deactivated at speeds above 18 km/h. It is reactivated at lower speeds.

PARKTRONIC monitors the area around your vehicle using six sensors in the front bumper and four sensors in the rear bumper.



- ①** Example: sensors in the front bumper, left-hand side

Range of the sensors

General notes

- !** When parking, pay particular attention to objects above or below the sensors, such as flower pots or trailer drawbars. PARKTRONIC does not detect such objects when they are in the immediate vicinity of the vehicle. You could damage the vehicle or the objects.

The sensors may not detect snow and objects which absorb ultrasonic sources.

Ultrasonic sources, such as an automatic car wash, a lorry's compressed-air brakes or a pneumatic drill, could cause PARKTRONIC to malfunction.

PARKTRONIC may not function correctly on uneven terrain.

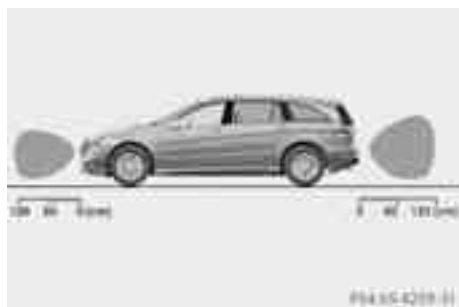

Side view



Top view

The sensors must be free of dirt, ice and slush. Otherwise, they may not function correctly. Clean the sensors regularly, taking care not to scratch or damage them (▷ page 287).

Front sensors

Centre	approximately 100 cm
Corners	approximately 60 cm

Rear sensors

Centre	approximately 120 cm
Corners	approximately 80 cm

Minimum distance

Centre	approximately 20 cm
Corners	approximately 15 cm

If there is an obstacle within this range, the relevant warning displays light up and a warning tone sounds. If the distance falls below

the minimum, the distance may no longer be shown.

Warning displays

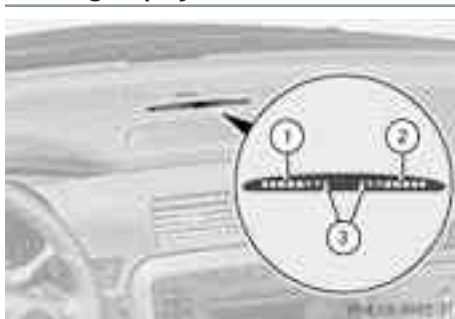

Warning display for the front area

- ① Segments on the left-hand side of the vehicle
- ② Segments on the right-hand side of the vehicle
- ③ Segments showing operational readiness

The warning displays show the distance between the sensors and the obstacle. The warning display for the front area is located on the dashboard above the centre air vents. The warning display for the rear area is in the roof lamp in the rear compartment.

The warning display for each side of the vehicle is divided into five yellow and two red segments. PARKTRONIC is operational if yellow segments showing operational readiness ③ light up.

The selected transmission position determines which warning display is active when the engine is running.

Transmission position	Warning display
D	Front area activated
R or N	Rear and front areas activated
P	No areas activated

One or more segments light up as the vehicle approaches an obstacle, depending on the vehicle's distance from the obstacle.

From the:

- sixth segment onwards, you will hear an intermittent warning tone for approximately two seconds.
- seventh segment onwards, you will hear a warning tone for approximately two seconds. This indicates that you have now reached the minimum distance.

Deactivating/activating PARKTRONIC

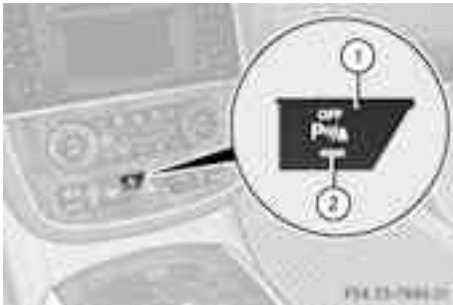

- ① To deactivate/activate PARKTRONIC
- ② Indicator lamp

If indicator lamp ② lights up, PARKTRONIC is deactivated.

- ❗ PARKTRONIC is automatically activated when you turn the key to position **2** in the ignition lock.

Towing a trailer

- ❗ Remove the detachable ball coupling if the trailer tow hitch is not required. PARKTRONIC measures the minimum detection range to an obstacle from the bumper, not the ball coupling.

PARKTRONIC is deactivated for the rear area when you establish an electrical connection between your vehicle and a trailer.

Problems with PARKTRONIC

Problem	Possible causes/consequences and ► Solutions
<p>Only the red segments in the PARKTRONIC warning displays are lit. You also hear a warning tone for approximately two seconds.</p> <p>PARKTRONIC is deactivated after approximately five seconds, and the indicator lamp in the PARKTRONIC button lights up.</p>	<p>PARKTRONIC has malfunctioned and has switched off.</p> <p>► If problems persist, have PARKTRONIC checked at a qualified specialist workshop.</p>
<p>Only the red segments in the PARKTRONIC warning displays are lit. PARKTRONIC is deactivated after approximately five seconds.</p>	<p>The PARKTRONIC sensors are dirty or there is interference.</p> <p>► Clean the PARKTRONIC sensors (► page 287).</p> <p>► Switch the ignition back on.</p> <p>The problem may be caused by an external source of radio or ultrasound waves.</p> <p>► See if PARKTRONIC functions in a different location.</p>

Reversing camera

Important safety notes

WARNING

Make sure that no persons or animals are in the manoeuvring range. Otherwise, they could be injured.

General notes



① Reversing camera

Reversing camera ① is an optical parking aid. It shows the area behind your vehicle in the COMAND display.

Reversing camera ① is located in the handle strip of the tailgate.

View through the camera

WARNING

The reversing camera is only an aid and may display obstacles in a distorted or incorrect manner, or may not even display them at all. The reversing camera does not relieve you of the responsibility to pay attention. The camera cannot show objects:

- very near to the rear bumper
- below the rear bumper
- that are located above the tailgate handle recess

You are always responsible for safety and must continue to pay attention to your immediate surroundings when parking and manoeuvring. This applies to the areas behind, in front of and next to the vehicle. You could otherwise endanger yourself and others.

WARNING

Under the following circumstances, the reversing camera will not function, or will function in a limited manner:

- if the tailgate is open
- in heavy rain, snow or fog
- at night or in very dark places
- if the camera is exposed to very bright light
- if the area is lit by fluorescent light or LED lighting (the display may flicker)
- if there is a sudden change in temperature, e.g. when driving into a heated garage in winter
- if the camera lens is dirty or obstructed
- if the rear of your vehicle is damaged. In this event, have the camera position and setting checked at a qualified specialist workshop. Mercedes-Benz recommends that you use a Mercedes-Benz Service Centre for this purpose.

Do not use the reversing camera in these types of situation. You could otherwise injure others or damage objects and your vehicle while you are parking.

The area behind the vehicle is displayed as a mirror image, as in the rear-view mirror.

Activating the reversing camera

- ▶ Make sure that the key is in position **2** in the ignition lock.
- ▶ Make sure that the "Reversing camera" function is selected in COMAND APS (see the separate operating instructions for COMAND APS).
- ▶ Engage reverse gear.
The area behind the vehicle is shown with guide lines in the COMAND display.

Guide lines in the COMAND display

WARNING

Using the reversing camera can be dangerous if you are colour blind or your ability to distinguish colours is impaired.

Only use the reversing camera if you can see and distinguish between all the coloured guide lines that are displayed by the reversing camera in the COMAND display.

WARNING

Please note that objects not at ground level may appear to be further away than they actually are. These include:

- the bumper of a vehicle that is parked behind your vehicle
- a trailer drawbar
- the ball coupling of a trailer tow hitch
- the tail-end of a lorry
- slanted posts

The lines are only guides, not accurate measurements of the distance to an obstacle.

Therefore, you should never pass the red line when approaching an obstacle. You could otherwise cause an accident and injure yourself and others.

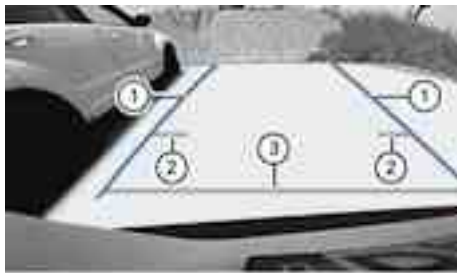

Information in the COMAND display (example)

Guide lines ② and ③ show the approximate distance to the rear area. Yellow guide line ② approximately 1.0 m and red guide line ③ approximately 0.25 m. The distances only apply to objects that are at ground level. Blue guide lines ① depict the width required for the vehicle. They are used to align the vehicle with the edge of the carriageway, e.g. the kerb.

Blind Spot Assist

Important safety notes

WARNING

Blind Spot Assist is only an aid designed to assist driving. It may fail to detect some vehicles and is no substitute for attentive driving. Blind Spot Assist cannot detect road and traffic conditions. It may fail to detect narrow vehicles, such as motorcycles or bicycles, or only detect them too late.

Monitoring may be affected by dirty sensors, strong spray or poor visibility caused by snow, rain or mist, for example. In this case, vehicles are detected late or not at all.

Always pay attention to traffic conditions and your surroundings. Otherwise, you may fail to recognise dangers in time, cause an accident and injure yourself and others.

WARNING

Blind Spot Assist is not active at speeds below 30 km/h. The indicator lamps in the exterior

mirrors are yellow. Vehicles in the monitoring range are then not indicated.

Always pay attention to traffic conditions and your surroundings. Otherwise, you may fail to recognise dangers in time, cause an accident and injure yourself and others.

General notes

Blind Spot Assist uses a radar sensor system to monitor the areas on both sides of your vehicle. It supports you from speeds of 30 km/h. A warning display in the exterior mirrors draws your attention to vehicles detected in the monitored area. If you then switch on the corresponding turn signal to change lane, you will also receive an optical and audible collision warning. For monitoring, Active Blind Spot Assist uses sensors in the rear bumper.

The radar sensor system is switched off automatically in the vicinity of radio telescope facilities (▷ page 349).

For Blind Spot Assist to assist you when driving, the radar sensor system must be activated (▷ page 204) and operational.

Monitoring range of the sensors

WARNING

Blind Spot Assist monitors certain areas in the immediate vicinity of your vehicle. Vehicles that approach and drive past at high speeds are not detected. There is no display and no warning.

If the lanes are very wide, it may not be possible to monitor the complete width of the neighbouring lane. For this reason, vehicles in the next lane may not be detected, especially if they are driving in a staggered formation in different lanes. This may be the case if vehicles are driving at the edge of their lane that is furthest away from your vehicle.

Always pay attention to traffic conditions and your surroundings. Otherwise, you may fail to recognise dangers in time, cause an accident and injure yourself and others.



Blind Spot Assist monitors the area up to 3.0 m behind your vehicle and directly next to your vehicle, as shown in the diagram.

If the lanes are narrow, vehicles driving in the lane beyond the lane next to your vehicle may be indicated, especially if the vehicles are not driving in the middle of their lane. This may be the case if there are vehicles at the edge of their lane nearest your vehicle.

Due to the nature of the system:

- warnings may be issued in error when driving close to crash barriers or similar solid lane borders.
- warnings may be interrupted when driving alongside long vehicles, for example lorries, for a prolonged time.

The two radar sensors for Blind Spot Assist are integrated into the sides of the rear bumper. Make sure that the bumper is free of dirt, ice or slush in the vicinity of the sensors. The sensors must not be covered, for example by cycle racks or overhanging loads. Following a severe impact or in the event of damage to the bumpers, have the function of the sensors checked at a qualified specialist workshop. Blind Spot Assist may otherwise not work properly.

Indicator and warning display

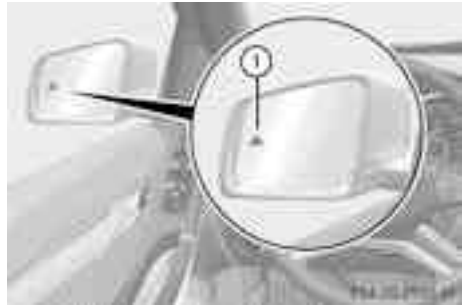

① Yellow indicator lamp/red warning lamp

If Blind Spot Assist is switched on, indicator lamp ① in the exterior mirrors lights up yellow up to a speed of 30 km/h. At speeds above 30 km/h, the indicator lamp goes out and Blind Spot Assist is operational.

If a vehicle is detected within the monitoring range of Blind Spot Assist at speeds above 30 km/h, warning lamp ① on the corresponding side lights up red. This warning always occurs when a vehicle enters the blind spot monitoring range from behind or from the side. When you overtake a vehicle, the warning only occurs if the difference in speed is less than 12 km/h.

The yellow indicator lamp goes out if reverse gear is engaged. Blind Spot Assist is then deactivated.

The brightness of the indicator/warning lamps is adjusted automatically according to the ambient light.

Collision warning

If a vehicle is detected in the monitoring range of Blind Spot Assist and you switch on the corresponding turn signal, a double warning tone sounds. Red warning lamp ① flashes. If the turn signal remains on, detected vehicles are indicated by the flashing of red warning lamp ①. There are no further warning tones.

Switching on Blind Spot Assist

- ▶ Make sure that the radar sensor system (> page 204) and Blind Spot Assist (> page 207) are activated in the on-board computer.
- ▶ Turn the key to position **2** in the ignition lock.
Warning lamps ① in the exterior mirrors light up red for approximately 1.5 seconds and then turn yellow.

Towing a trailer

If you attach a trailer, make sure that you have correctly established the electrical connection. This can be accomplished by checking the trailer lighting. Blind Spot Assist is then deactivated. The indicator lamp in the exterior mirrors lights up yellow, and the **Blind Spot Assist currently unavailable** See Owner's Manual message appears in the multifunction display.

i You can deactivate the indicator lamps in the exterior mirrors.

To do so, switch off Blind Spot Assist if:

- the key is in position **2** in the ignition lock.
- the engine is not running.
- the electrical connection to the trailer has been established.

Towing a trailer

Notes on towing a trailer

Important safety notes

WARNING

Vehicles with level control:

The vehicle level can be changed inadvertently, e.g. when changed by another person. If you are coupling up or uncoupling a trailer when this happens, you could become trapped. Body parts can also become trapped

between the vehicle body and tyres, or underneath the vehicle. This poses a risk of injury. When coupling up or uncoupling, make sure that no-one:

- opens or closes the doors or tailgate
- initiates the level control or presses the ADS switch
- locks or unlocks the vehicle.

WARNING

The braking system can overheat if you leave your foot on the brake pedal while driving. This increases the braking distance and could even cause the braking system to fail. There is a risk of an accident.

Never use the brake pedal as a footrest. Do not simultaneously depress both the brake pedal and the accelerator pedal while driving.

WARNING

You could lose control of the vehicle/trailer combination if it begins to swerve. The vehicle/trailer combination could even overturn. There is a risk of an accident.

On no account should you attempt to straighten out the vehicle/trailer combination by increasing speed. Decrease your speed and do not countersteer. Brake if necessary.

WARNING

If you exceed the permissible noseweight while carrying a load, the carrier system could detach from the vehicle and fall on the road. There is a risk of an accident and injury.

Always maintain the permissible noseweight when carrying loads.

WARNING

If the ball coupling is not correctly engaged, it could detach while driving and fall on the road. There is a risk of an accident and injury. Engage the ball coupling as described.

⚠ WARNING

If the ball coupling is not correctly engaged, the trailer can detach. There is a risk of an accident.

Always engage the ball coupling as described.

! Depressing the brake pedal constantly results in excessive and premature wear to the brake pads.

You can use carrier systems, e.g. bicycle racks or load-bearing implements, on the ball coupling. The maximum noseweight of 75 kg applies when using carrier systems on the ball coupling.

When reversing the vehicle towards the trailer, make sure there is nobody between the trailer and the vehicle.

Couple and uncouple the trailer carefully. If you do not couple the trailer to the towing vehicle correctly, the trailer could become detached.

Make sure that the following values are not exceeded:

- the permissible trailer drawbar noseweight
- the permissible trailer load
- the permissible rear axle load of the towing vehicle
- the maximum permissible gross vehicle weight of both the towing vehicle and the trailer

The applicable permissible values that must not be exceeded can be found:

- in your vehicle documents and
- on the identification plates on the trailer tow hitch, the trailer and the vehicle

Should the values differ, then the lowest applies.

You will find the values approved by the manufacturer on the vehicle identification plates and those for the towing vehicle under "Technical data" (▷ page 349).

When towing a trailer, your vehicle's handling characteristics will be different in comparison to when driving without a trailer.

The vehicle/trailer combination:

- is heavier
- is restricted in its acceleration and gradient-climbing capability
- has an increased braking distance
- is affected more by strong crosswinds
- demands more sensitive steering
- has a larger turning circle

This could impair the handling characteristics. Adapt your style of driving accordingly. Maintain a safe distance. Drive carefully.

When towing a trailer, always adjust your speed to the current road and weather conditions. Do not exceed the maximum permissible speed for your vehicle/trailer combination.

General notes

! Use a drawbar noseweight as close as possible to the maximum permissible noseweight. Do not use a noseweight of less than 50kg, otherwise the trailer may come loose.

Note that the payload and the rear axle load are reduced by the actual payload.

i When towing a trailer, set the tyre pressure on the rear axle of the towing vehicle for a maximum load; see the tyre pressure table in the fuel filler flap (▷ page 315).

You will find installation dimensions and loads in the "Technical data" section (▷ page 347).

The maximum noseweight of the trailer drawbar on the ball coupling is 85 kg. The actual noseweight may however not be higher than the value which is given on the trailer tow hitch or trailer identification plates. The lowest weight applies.

Please note that when towing a trailer, PARKTRONIC (▷ page 177) and Blind Spot Assist (▷ page 182) are only available with limitations, or not at all.

Driving tips

- i** Observe the notes on ESP® trailer stabilisation (▷ page 64).

The maximum permissible speed for vehicle/trailer combinations depends on the type of trailer. Before beginning the journey, check the trailer's documents to see what the maximum permitted speed is. Observe the legally prescribed maximum speed in the relevant country.

For certain Mercedes-Benz vehicles, the maximum permissible rear axle load is increased when towing a trailer. Refer to the "Technical data" section (▷ page 349) to find out whether this applies to your vehicle. If you utilise any of the added maximum rear axle load when towing a trailer, the vehicle/trailer combination may not exceed a maximum speed of 100 km/h for reasons concerning the operating permit. This also applies in countries in which the permissible maximum speed for vehicle/trailer combinations is above 100 km/h.

When towing a trailer, your vehicle's handling characteristics will be different in comparison to when driving without a trailer and it will consume more fuel.

On long and steep downhill gradients, you must select shift range **1**, **2** or **3** in good time.

- i** This also applies if you have activated cruise control, SPEEDTRONIC or DIS-TRONIC PLUS.

This will use the braking effect of the engine, so less braking will be required to prevent the vehicle from gaining speed. This relieves the load on the brake system and prevents the brakes from overheating and wearing too quickly. If you need additional braking, depress the brake pedal repeatedly rather than continuously.

Driving tips

If the trailer swings from side to side:

- ▶ Do not accelerate.
- ▶ Do not countersteer.
- ▶ Brake if necessary.
 - Maintain a greater distance from the vehicle in front than when driving without a trailer.
 - Avoid braking abruptly. If possible, brake gently at first to allow the trailer to run on. Then, increase the braking force rapidly.
 - The values given for gradient-climbing capabilities from a standstill refer to sea level. When driving in mountainous areas, note that the power output of the engine, and consequently the vehicle's gradient-climbing capability, decrease with increasing altitude.

Fitting the ball coupling (vehicles with an external spare wheel)

WARNING

If the ball coupling is not correctly engaged, it could detach while driving and fall on the road. There is a risk of an accident and injury. Engage the ball coupling as described.

WARNING

If the ball coupling is not correctly engaged, the trailer can detach. There is a risk of an accident. Always engage the ball coupling as described.

WARNING

If you release the ball coupling or it does not engage correctly when folding in, it will swing out. Within pivoting range of the ball coupling, there is an increased risk of an accident and injury. Only release the ball coupling if the pivoting range is unobstructed. Always make sure that the ball coupling engages when folding in.

Before you can tow a trailer with your vehicle, you must fit the ball coupling.

- ▶ Make a note of the ball coupling key number. You can use this number to obtain a replacement key from a Mercedes-Benz Service Centre.



Cover at the bottom of the bumper

- ▶ Remove cover ①.
- ▶ Take the ball coupling and the key from the stowage well under the luggage compartment floor (▷ page 293).



- ▶ Pull protective cap ① underneath the bumper vertically downwards in the direction of the arrow and out of the ball coupling recess.
- ▶ Place protective cap ① in the stowage well under the luggage compartment floor.



- ▶ Pull protective cap ② off the lock in the handwheel.
 - ▶ Insert key ① into the lock in the handwheel.
 - ▶ Turn key ① anti-clockwise.
- i** The key remains inserted when you remove the ball coupling.



- ▶ Pull handwheel ④ away from the ball coupling in the direction of the arrow and turn it clockwise until it engages. The white dot on the ball coupling is aligned with the red area on the handwheel.
- ▶ Insert the ball coupling vertically up into ball coupling recess ③ in the direction of the arrow until it engages.

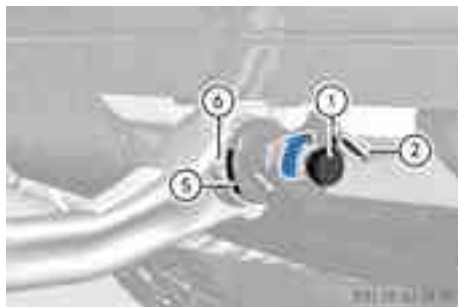

- ▶ Handwheel ④ turns automatically, aligning green area ⑤ on handwheel ④ with white dot ⑥ on the ball coupling.
- ▶ Turn key ① to the stop in the direction of the arrow (lock).
- ▶ Remove key ①.
- ▶ Press protective cap ② onto the lock.



- ① Power socket

Coupling up a trailer

Important safety notes

WARNING

Vehicles with level control:

If you disconnect the trailer cable, the vehicle is lowered. This can cause you or others to become trapped between the vehicle body and tyres, or underneath the vehicle. This poses a risk of injury.

Make sure that no-one is in the immediate vicinity of the wheel arch or underneath the vehicle when disconnecting the trailer cable.

Steel-sprung vehicles

- ▶ Make sure that the transmission is in position **P**.
- ▶ Engage the electric parking brake.
- ▶ Position the trailer level behind the vehicle.
- ▶ Couple up the trailer.
- ▶ Establish the electrical connection between the vehicle and the trailer.
- ▶ Check that the trailer lighting system is working.

Vehicles with rear axle level control

- ▶ Make sure that the transmission is in position **P**.
- ▶ Apply the parking brake.
- ▶ Close the doors and tailgate.
- ▶ Position the trailer level behind the vehicle.
- ▶ Couple up the trailer.
- ▶ Establish the electrical connection between the vehicle and the trailer.
- ▶ Start the engine.

Vehicles with the AIRMATIC package

- ▶ Make sure that the transmission is in position **P**.
- ▶ Apply the parking brake.
- ▶ Start the engine.
- ▶ Set the vehicle to highway level (▷ page 175).
- ▶ Switch off the engine.
- ▶ Close the doors and tailgate.
- ▶ Position the trailer level behind the vehicle.
- ▶ Couple up the trailer.
- ▶ Establish the electrical connection between the vehicle and the trailer.

- i** If you have coupled a trailer, the vehicle will remain at highway level.

The vehicle automatically lowers to highway level if you drive faster than 8km/h with a trailer. The vehicle is not lowered to

high-speed level even if you are travelling at higher speeds.

This also applies when using accessories that are plugged into the socket of the trailer tow hitch (e.g. a bicycle rack).

Uncoupling a trailer

Important safety notes

WARNING

If you uncouple a trailer with an engaged overrun brake, you could trap your hand between the vehicle and the trailer drawbar. This poses a risk of injury.

Do not uncouple a trailer with an engaged overrun brake.

WARNING

Vehicles with level control:

If you disconnect the trailer cable, the vehicle is lowered. This can cause you or others to become trapped between the vehicle body and tyres, or underneath the vehicle. This poses a risk of injury.

Make sure that no-one is in the immediate vicinity of the wheel arch or underneath the vehicle when disconnecting the trailer cable.

! Do not uncouple a trailer with overrun brake between the bumper and drawbar, otherwise your vehicle could be damaged by the spring action of the overrun brake.

! Remove the installed adapter cable before folding in the ball coupling. Otherwise, damage may occur to the rear bumper and the adapter cable.

Steel-sprung vehicles

- ▶ Make sure that the transmission is in position **P**.
- ▶ Engage the electric parking brake.
- ▶ Secure the trailer against rolling away.
- ▶ Remove the trailer cable and decouple the trailer.

Vehicles with rear axle level control

- ▶ Make sure that the transmission is in position **P**.
- ▶ Engage the parking brake.
- ▶ Start the engine.
- ▶ Close the doors and tailgate.
- ▶ Secure the trailer against rolling away.
- ▶ Remove the trailer cable.
- ▶ Lift up the trailer drawbar and decouple the trailer.
- ▶ Switch off the engine.

Vehicles with the AIRMATIC package

- ▶ Make sure that the transmission is in position **P**.
- ▶ Engage the electric parking brake.
- ▶ Start the engine.
- ▶ Close the doors and tailgate.
- ▶ Secure the trailer against rolling away.
- ▶ Remove the trailer cable and decouple the trailer.
- ▶ Switch off the engine.

Removing the ball coupling

- ▶ Pull the protective cap off the lock in the handwheel.
- ▶ Use the key to unlock the lock in the handwheel.
- ▶ Hold the ball coupling. Pull the handwheel away from the ball coupling and turn it clockwise until it engages. The red area on the handwheel is aligned with the white dot on the ball coupling.
- ▶ Pull the ball coupling downwards to remove.
- ▶ Clean the ball coupling if it is dirty.

Information on cleaning and care of the trailer tow hitch can be found at (▷ page 287).

Storing the ball coupling

⚠ WARNING

Never transport an unsecured ball coupling in the interior of the vehicle.

Otherwise, vehicle occupants could be injured by the ball coupling being thrown if you:

- brake sharply
 - change direction suddenly
 - have an accident
- ▶ Press the protective cap into the ball coupling recess until it engages.
 - ▶ Make sure that the protective cap is firmly in place.
 - ▶ Replace the cover.
 - ▶ Place the ball coupling with the key inserted in the ball coupling recess in the storage well under the luggage compartment floor.

Trailer power supply

- ⚠ You can connect accessories with a power rating of up to 240 W to the permanent power supply and with a power rating of up to 180 W to the power supply that is switched on via the ignition lock.

The trailer battery may not be charged from the power supply.

When it leaves the factory, your vehicle's trailer socket is equipped with a permanent power supply and a power supply that is switched on via the ignition lock.

The permanent power supply is supplied via trailer socket pin 9.

The power supply that is switched on via the ignition lock is supplied via trailer socket pin 10.

The trailer's turn signal lamps are only guaranteed to function when bulbs are used.

You can find more information about fitting the trailer electrics at a qualified specialist workshop.

- ▶ **To switch the connected power supply on or off:** turn the key in the ignition lock to position **2** or **0** respectively (▷ page 145).

Trailer with 7-pin connector

General notes

Trailers with 7-pin connector: you can make a connection to the 13-pin connector on the ball coupling using an adapter plug or, if necessary, an adapter cable. Both can be obtained in a qualified specialist workshop.

Fitting the adapter

- ⚠ Make sure that there is sufficient cable play so that the cable cannot become detached when cornering.
- ⚠ Remove the installed adapter cable before folding in the ball coupling. Otherwise, damage may occur to the rear bumper and the adapter cable.

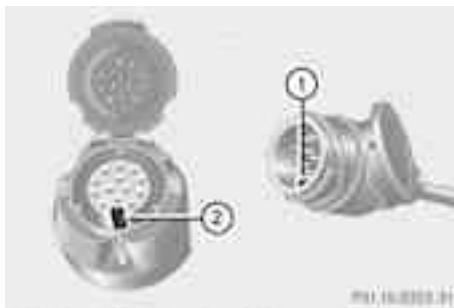

- ▶ Open the socket cover.
- ▶ Insert connector with lug ① into groove ② of the socket. Turn the connector clockwise to the stop.
- ▶ Let the cover engage.
- ▶ If you are using an adapter cable, secure the cable to the trailer with cable ties.

Problems with trailer towing	
Problem	Possible causes/consequences and ► Solutions
<p>The ball coupling cannot be locked.</p> <p>The key cannot be removed from the ball coupling.</p>	<p> Risk of accident</p> <p>The ball coupling is dirty.</p> <p>The trailer tow hitch is damaged.</p> <ul style="list-style-type: none"> ► Remove the ball coupling and clean it (► page 287). If the ball coupling still cannot be locked, remove the ball coupling. It must no longer be used to tow a trailer, as safe operation is not guaranteed. ► Have the entire trailer tow hitch checked at a qualified specialist workshop.

Useful information	194
Important safety notes	194
Displays and operation	194
Menus and submenus	196
Display messages	210
Warning and indicator lamps in the instrument cluster	233

Useful information

- i** This Owner's Manual describes all models, series and optional equipment for your vehicle that were available at the time of going to press. National variations are possible. Note that your vehicle may not be equipped with all of the functions described. This is also the case for systems and functions relevant to safety.
- i** Read the information on qualified specialist workshops: (▷ page 23).

Important safety notes

WARNING

Only use the on-board computer when road and traffic conditions permit. You would otherwise be distracted and unable to concentrate properly on driving, and could cause an accident.

WARNING

No messages will be displayed if either the instrument cluster or the multifunction display is inoperative.

As a result, you will not be able to see information about your driving conditions, such as speed, outside temperature, warning and indicator lamps, display messages or system failures. Driving characteristics may be impaired. Adjust your driving style and vehicle speed accordingly.

Contact a qualified specialist workshop immediately.

WARNING

The on-board computer only records and displays malfunctions and warnings from certain systems. For this reason, you should always make sure that your vehicle is safe to use. You could otherwise cause an accident by driving an unsafe vehicle.

WARNING

The operating safety of your vehicle could be impaired if maintenance work is carried out incorrectly. This could cause you to lose control of your vehicle and cause an accident. Moreover, the safety systems may no longer be able to protect you or others as they are designed to do.



Always have service work carried out at a qualified specialist workshop.

For an illustration of the instrument cluster, see (▷ page 30).

Displays and operation



Instrument cluster lighting

The buttons for controlling the brightness are at the top of the instrument cluster (▷ page 30).

Instrument cluster: if the light switch is set to **AUTO**,  or , brightness control takes ambient light conditions into account.

- i** The light sensor in the instrument cluster automatically controls the brightness of the multifunction display.

Displays and switches in the vehicle

interior: if the light switch is set to **AUTO**, brightness control takes ambient light conditions into account. If the light switch is set to  or , brightness control does not take ambient light conditions into account.

Rev counter

- !** Do not drive in the overrevving range. Doing so will damage the engine.

The red band in the rev counter indicates the engine's overrevving range.

The fuel supply is interrupted to protect the engine when the red band is reached.

Outside temperature display

WARNING

At temperatures just above freezing point, the street may be icy, especially in wooded areas or on bridges. If you do not adapt your driving style to the conditions, the vehicle could skid. For this reason, adapt your driving style and speed to the weather conditions.

The outside temperature display is in the multifunction display (▷ page 197).

Changes in the outside temperature are displayed after a short delay.

Speedometer with segments

The segments in the speedometer indicate which speed range is available.

- DISTRONIC activated (▷ page 167):
One or two segments in the set speed range light up.
- DISTRONIC detects a vehicle in front:
The segments between the speed of the vehicle in front and the stored speed light up.

Operating the on-board computer

Overview



- ① Multifunction display
- ② Right control panel
- ③ Left control panel

► **To activate the on-board computer:** turn the key to position **1** in the ignition lock.

You can control the multifunction display and the settings in the on-board computer using the buttons on the multifunction steering wheel.



Left control panel







- Rejects or ends a call
- Exits telephone book/redial memory



- Makes or accepts a call
- Switches to the redial memory

	<ul style="list-style-type: none"> • Selects submenus in the Settings menu • Changes values • Adjusts the volume
	<ul style="list-style-type: none"> • Switches on LINGUATRONIC; see the separate operating instructions

Right control panel

	<ul style="list-style-type: none"> • Selects a menu: scrolls backward and forward
	<p>Press briefly:</p> <ul style="list-style-type: none"> • Scrolls backward and forward within a menu • In the Audio menu: selects a stored station, an audio track or a video scene • In the Telephone menu: switches to the phone book and selects a name or a telephone number
	<p>Press and hold:</p> <ul style="list-style-type: none"> • In the Audio menu: selects the previous/next station or selects an audio track using rapid scrolling • In the Telephone menu: starts rapid scrolling through the phone book
	<ul style="list-style-type: none"> • Switches off LINGUATRONIC; see the separate operating instructions

Multifunction display





- ① Description field
- ② Transmission position (▷ page 151)
- ③ Drive program (▷ page 153)
- ④ Status bar with outside temperature or speed (▷ page 201)

Text field ① shows the selected menu or submenu as well as display messages.

Menus and submenus

Menu overview

Press the  or  button on the steering wheel to call up the menu bar and select a menu.

Operating the on-board computer (▷ page 195).

Depending on the equipment fitted in the vehicle, you can call up the following menus:

- **Standard display** menu (▷ page 197)
- **Audio** menu (▷ page 198)
- **Navigation** menu (▷ page 199)
- **AIRMATIC/compass** menu (▷ page 199)
- **DISTRONIC** menu (▷ page 171)
- **Message memory** menu (▷ page 210)
- **Settings** menu (▷ page 200)
- **Additional functions** menu (▷ page 207)
- **Trip computer** menu (▷ page 207)
- **Telephone** menu (▷ page 208)

Depending on the audio system fitted, the display messages in the **Audio, Navigation** and **Telephone** menus differ slightly. The examples given in this Owner's Manual apply to vehicles equipped with COMAND APS.

Standard display menu

Standard display



Standard display

- ① trip meter
- ② Total distance recorder

- ▶ Press the or button on the steering wheel to select the standard display.
- ▶ **To reset the trip meter:** press and hold the reset button in the instrument cluster until the trip meter is reset.

You can select the following functions in the **Standard display** menu using the or button:

- Tyre pressure loss warning (▷ page 317) or tyre pressure monitor (▷ page 318)
- Coolant temperature (▷ page 197)
- digital speedometer or outside temperature (▷ page 197)
- ASSYST PLUS service interval display (▷ page 282)
- Engine oil level (▷ page 279)

Displaying the coolant temperature

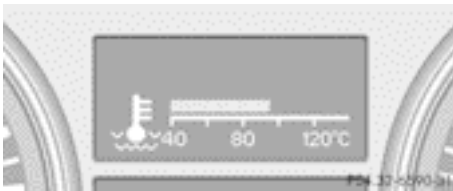

- ▶ Press the or button on the steering wheel to select the standard display.
- ▶ Press the or button to select the coolant temperature.

Under normal driving conditions, with the correct anti-corrosion and antifreeze additive concentration, the reading may rise to 120 °C.

Displaying the digital speedometer or outside temperature

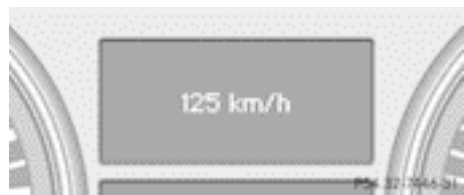

Digital speedometer



Outside temperature

If you have selected the digital speedometer for the status line (▷ page 201), the outside temperature is displayed here.

- ▶ Press the or button on the steering wheel to select the standard display.
- ▶ Press the or button to select digital speedometer or the outside temperature.

Vehicles for the United Kingdom: this function is not available.

Audio menu

Selecting a radio station



- ① Waveband
- ② Channel frequency with memory position

i Station ② is displayed with the station frequency or station name. The memory position is only displayed along with station ② if this has been stored.

- ▶ Switch on the audio system or COMAND APS and select the radio; see the separate operating instructions.
- ▶ Press the or button on the steering wheel to select the **Audio** menu.
- ▶ **To select a stored station:** briefly press the or button.
- ▶ **To select a station from the station list:** press and briefly hold the or button.

If no station list is received:

- ▶ **To select a station using the station search:** press and briefly hold the or button.

i For information on switching waveband and storing stations; see the separate operating instructions.

i DAB radio mode (**D**igital **A**udio **B**roadcasting); see the separate operating instructions.

Audio player or audio media operation



Example: CD/DVD changer display

- ① Current CD in the CD/DVD changer
- ② Current track

Audio data from various audio devices or media can be played, depending on the equipment fitted in the vehicle.

- ▶ Switch on the audio system or COMAND APS and activate audio CD/DVD mode or MP3 mode; see the separate operating instructions.
- ▶ Press the or button on the steering wheel to select the **Audio** menu.
- ▶ **To select the next/previous track:** briefly press the or button.
- ▶ **To select a track from the track list (rapid scrolling):** press and briefly hold the or button.







The current track will not be displayed in audio AUX mode (**A**uxiliary audio mode: external audio source connected).

TV operation



- ① Function
- ② Channel frequency with memory position

- ▶ Switch on COMAND APS and select TV; see the separate operating instructions.
- ▶ Press the or button on the steering wheel to select the **Audio** menu.





- ▶ **To select a stored station:** briefly press the  or  button.
- ▶ **To select a station from the station list:** press and briefly hold the  or  button.
- ▶ **To select a station using station search⁵:** press and briefly hold the  or  button.

Video DVD operation



Example: CD/DVD changer display

- ① Current DVD in the CD/DVD changer
- ② Current scene



- ▶ Switch on COMAND APS and select video DVD; see the separate operating instructions.
- ▶ Press the  or  button on the steering wheel to select the **Audio** menu.
- ▶ Press the  or  button to select a scene.

Navigation menu

Displaying navigation instructions

In the **Navigation** menu: the instructions from the navigation system appear in the multifunction display.

For more information, see the separate operating instructions.

- ▶ Switch on COMAND APS (see the separate operating instructions).
- ▶ Press the  or  button on the steering wheel to select the **Navi** menu.

Route guidance not active



The direction of travel is shown in the multi-function display.

If the name of the road is included in the navigation system data, this will also be displayed.

Activated route guidance



Example: navigation instruction

The navigation instructions appear in the multifunction display.

AIRMATIC/compass menu

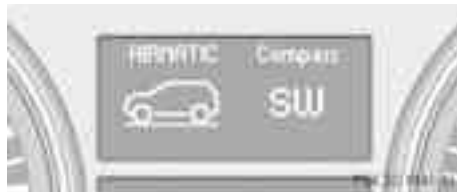

Example display for vehicles with AIRMATIC package and compass

- ▶ Press  or  on the steering wheel to select the **AIRMATIC/compass** menu.

In the **AIRMATIC/compass** menu you can view the messages for level control (> page 174) and see the compass display (> page 272). The display in the **AIRMATIC/**

⁵ Only if no station list is received.

compass menu depends on the optional equipment in your vehicle.

Settings menu

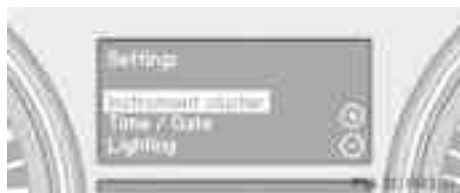

Introduction



In the **Settings** menu, you have the following options:

- restore the factory settings
- change the instrument cluster settings
- change the time/date settings⁶
- change the time/date settings⁷
- change the light settings
- change the vehicle settings
- change the auxiliary heating settings
- change the convenience settings



Resetting to factory settings

- ▶ Press the  or  button on the steering wheel to select the **Settings** menu.
- ▶ Press and hold the **(R)** reset button on the instrument cluster for approximately three seconds.

A prompt appears in the multifunction display asking you to confirm by pressing reset button **(R)** again.

- ▶ Press the **(R)** reset button again.
The settings of most functions are restored to the factory settings.

or

- ▶ If you want to retain the settings, do not press the **(R)** reset button a second time.
You will see the **Settings** menu again after approximately five seconds.
- ▶ Press the  or  button to select a different menu.











For safety reasons, not all functions will be reset: permanent SPEEDTRONIC can only be set in the **Vehicle** submenu. The **Daytime driving lamps** function in the **Lighting** submenu is only reset if the engine is switched off.

Instrument cluster

Selecting the unit of measurement for distance

This function is not available on vehicles with speedometers in mph.

The **Display unit Speedometer/odometer** function allows you to choose whether certain displays appear in kilometres or miles in the multifunction display.

- ▶ Press the  or  button on the steering wheel to select the **Settings** menu.
- ▶ Press the  button to call up the selection of submenus.
- ▶ Press the  or  button to select the **Instrument cluster** submenu.
- ▶ Press the  button to select **Display unit Speedometer/odometer**.
- ▶ Press the  or  button to select **km** or **miles** as the unit of measurement for distance.
- ▶ Press the ,  or  button to select a different display.

⁶ This function is not available on vehicles with Audio 50 APS, Audio 55 APS or COMAND APS.











⁷ This function is not available in vehicles with a navigation system.

The selected unit of measurement for distance applies to:

- analogue speedometers
- total distance recorder and the trip meter
- trip computer
- navigation instructions in the **Navigation** menu
- Cruise control
- SPEEDTRONIC
- DISTRONIC











Selecting the unit of measurement for distance for the digital speedometer

This function is not available on vehicles with speedometers in mph.

- ▶ Press the  or  button on the steering wheel to select the **Settings** menu.
- ▶ Press the  button to call up the selection of submenus.
- ▶ Press the  or  button to select the **Instrument cluster** submenu.
- ▶ Press the  button to select **Display unit Digital speedometer**.
- ▶ Press the  or  button to select **km** or **miles** as the unit of measurement for distance.
- ▶ Press the ,  or  button to select a different display.











Selecting the language

The **Language** function allows you to select the language for the instrument cluster.

- ▶ Press the  or  button on the steering wheel to select the **Settings** menu.
- ▶ Press the  button to call up the selection of submenus.
- ▶ Press the  or  button to select the **Instrument cluster** submenu.
- ▶ Press  to select **Language**.
- ▶ Press the  or  button to select the desired language.
- ▶ Press the ,  or  button to select a different display.

Selecting the status line display





Vehicles for the United Kingdom: this function is not available.

- ▶ Press the  or  button on the steering wheel to select the **Settings** menu.
- ▶ Press the  button to call up the selection of submenus.
- ▶ Press the  or  button to select the **Instrument cluster** submenu.
- ▶ Press  to select **Status bar display**.
- ▶ Press the  or  button to select the status line display: vehicle speed (**Speed**) or outside temperature (**Outside temp.**). The selected display now appears constantly in the lower multifunction display. When you scroll through the **Standard display** menu (▷ page 197), you will see the display you have not selected.
- ▶ Press the ,  or  button to select a different display.

Time/date

This submenu is only available on vehicles with Audio 20.



The **Time/Date** submenu allows you to set the time and the date.

- ▶ Refer to the separate operating instructions to find out which audio system is fitted in your vehicle.
- ▶ Press the  or  button on the steering wheel to select the **Settings** menu.
- ▶ Press the  button to call up the selection of submenus.
- ▶ Press the  or  button to select the **Time/Date** submenu.

► **To set the time:** press the  button to select **Clock, set hour** or **Clock, set minute**.

or

► **To set the date:** press  to select **Date, Set day**, **Date, Set month** or **Date, Set year**.

► Press the  or  button to set a value.

► Press the ,  or  button to select a different display.

Your vehicle may have the following audio equipment:

A: Audio 20

B: Audio 50 APS

C: COMAND APS







Depending on the audio system, the time and date are received from GPS satellites and cannot be set using the on-board computer (see the following table).

	A	B	C
Setting using the on-board computer	X		
Automatic GPS satellite reception		X	X



Lighting

Switching the daytime driving lights on/off

The **Daytime driving lights** function can only be set when the engine is switched off.

- Switch off the engine.
- Press the ,  or  button on the steering wheel to select the **Settings** menu.
- Press the  button to call up the selection of submenus.
- Press the  or  button to select the **Lighting** submenu.

► Press  to select **Daytime driving lamps**.













► Press  or  to set daytime driving lights to **On** or **Off**.

► Press the ,  or  button to select a different display.

Further information on daytime driving lights (► page 111).

Switching the surround lighting on or off

The surround lighting switches off automatically after 40 seconds or when the driver's door is opened.

- Press the ,  or  button on the steering wheel to select the **Settings** menu.
- Press the  button to call up the selection of submenus.
- Press the  or  button to select the **Lighting** submenu.
- Press the  button to select the **Surround lighting function**.
- Press the  or  button to switch the **Surround lighting** function on or off.
- Press the ,  or  button to select a different display.

If the surround lighting is switched on, the following lights will be switched on automatically in the dark after you have unlocked the vehicle using the key:

- side lamps
- licence plate lighting
- foglamps⁸
- dipped-beam headlamps⁹
- surround lighting in the exterior mirrors











Activating/deactivating the exterior lighting delayed switch-off

When you activate the **Headlamps delayed switch-off** function, the exterior lighting remains on for 15 seconds after the doors are closed when it is dark.

⁸ Only for vehicles with front foglamps.

⁹ Only for vehicles without front foglamps.

If the engine is switched off and no doors are opened, or if an open door is not closed, the exterior lighting goes out after 60seconds.

- ▶ Press the  or  button on the steering wheel to select the **Settings** menu.
- ▶ Press the  button to call up the selection of submenus.
- ▶ Press the  or  button to select the **Lighting** submenu.
- ▶ Press the  button to select **Headlamps delayed switch-off**.
- ▶ Press the  or  button to activate or deactivate the **Headlamps delayed switch-off** function.
- ▶ Press the ,  or  button to select a different display.

Deactivating the delayed switch-off temporarily:

- ▶ Before leaving the vehicle, turn the key to position **0** in the ignition lock.
- ▶ Turn the key to position **2** in the ignition lock and back to position **0**.
The delayed switch-off is deactivated.











Delayed switch-off is reactivated the next time you start the engine.

If you have activated the delayed switch-off function and switched off the engine, the following remain lit:

- Side lamps
- Licence plate lighting
- Foglamps¹⁰
- Dipped-beam headlamps¹¹

Activating/deactivating the interior lighting delayed switch-off

If the **Interior lighting delayed shut-off** function is activated and you pull the key out of the ignition lock, the interior lighting remains on for around 10 seconds.

- ▶ Press the  or  button on the steering wheel to select the **Settings** menu.
- ▶ Press the  button to call up the selection of submenus.
- ▶ Press the  or  button to select the **Lighting** submenu.
- ▶ Press the  button to select **Interior lighting delayed shut-off**.
- ▶ Press the  or  button to activate or deactivate **Interior lighting delayed shut-off**.
- ▶ Press the ,  or  button to select a different display.











Vehicle

Setting and calibrating the compass

Setting and calibrating the compass are described in the "Compass" section (> page 272).

Setting the display when the ignition is switched off











The **Display when ignition is turned off** function allows you to set which display you see in the multifunction display after removing the key from the ignition lock.

- ▶ Press the  or  button on the steering wheel to select the **Settings** menu.
- ▶ Press the  button to call up the selection of submenus.
- ▶ Press  or  to select the **Vehicle** submenu.
- ▶ Press the  button to select **Display when ignition is turned off**.
- ▶ Press the  or  button to select **Interior motion sensor, Tow-away protection** or **Miles/km**.
- ▶ Press the ,  or  button to select a different display.

¹⁰ Only for vehicles with front foglamps.

¹¹ Only for vehicles without front foglamps.

Setting permanent SPEEDTRONIC











- ▶ Press the  or  button on the steering wheel to select the **Settings** menu.
- ▶ Press the  button to call up the selection of submenus.
- ▶ Press  or  to select the **Vehicle** submenu.
- ▶ Press the  button to select **Speed limit (winter tyres)**.
- ▶ Press the  or  button to adjust permanent SPEEDTRONIC in increments of ten (240 km/h to 160 km/h). The **Off** setting switches permanent SPEEDTRONIC off.
- ▶ To select a different display, press ,  or .

For further information on permanent SPEEDTRONIC (▷ page 167).

Switching the automatic locking feature on/off

If you select the **Automatic door locking** function, the vehicle is centrally locked above a speed of around 15 km/h.











If you select the **Automatic door locking** function, the vehicle is centrally locked above a speed of around 9 mph (15km/h).

- ▶ Press the  or  button on the steering wheel to select the **Settings** menu.
- ▶ Press  or  to select the **Vehicle** submenu.
- ▶ Press the  button to select **Automatic door locking**.
- ▶ Press the  or  button to activate or deactivate the **Automatic door locking** feature.
- ▶ Press the ,  or  button to select a different display.











For further information on the automatic locking feature, see (▷ page 77).

Activating/deactivating the acoustic locking confirmation

If you switch on the **Acoustic Lock feedback**: function, an acoustic signal sounds when you lock the vehicle.

- ▶ Press the  or  button on the steering wheel to select the **Settings** menu.
- ▶ Press the  button to call up the selection of submenus.
- ▶ Press  or  to select the **Vehicle** submenu.
- ▶ Press the  button to select **Acoustic lock feedback**.
- ▶ Press the  or  button to switch the **Acoustic lock feedback** function on/off.
- ▶ Press the ,  or  button to select a different display.

Activating/deactivating the radar sensor system

- ▶ Press the  or  button on the steering wheel to select the **Settings** menu.
- ▶ Press the  button to call up the selection of submenus.
- ▶ Press  or  to select the **Vehicle** submenu.
- ▶ Press the  button to select **Radar sensor (See Owner's Manual)**.
- ▶ Press the  or  button to activate or deactivate the **Radar sensor (See Owner's Manual)**.
- ▶ Press the ,  or  button to select a different display.

i You must deactivate the radar sensor system in certain countries and near radio telescope facilities. For further information, see (▷ page 349).

Vehicles with a navigation system: the radar sensor system is deactivated automatically if you are close to radio telescope facilities.

If the radar sensor system is switched off, **Blind Spot Assist** (▷ page 182) is deactivated.

Heating

Auxiliary heating departure time

WARNING

Exhaust fumes are produced when the auxiliary heating is in operation. Inhaling these exhaust fumes can be poisonous. You should therefore switch off the auxiliary heating in confined spaces without an extraction system, e.g. a garage.

WARNING

When operating the auxiliary heating parts of the vehicle can get very hot. Make sure that the exhaust system does not under any circumstances come into contact with easily ignitable material such as dry grass or fuels. The material could otherwise ignite and set the vehicle alight. Choose your parking spot accordingly.

Operating the auxiliary heating is thus prohibited at filling stations or when your vehicle is being refuelled. You must therefore switch off the auxiliary heating at filling stations.

-  Operating the auxiliary heating/ventilation draws on the vehicle battery. After you have heated or ventilated the vehicle a maximum of two times, drive for a longer distance.

This function is only available on vehicles with auxiliary heating (▷ page 135).

You can select a stored departure time or change a departure time using the **Aux. heating departure time** function.

The auxiliary heating timer function calculates the switch-on time according to the outside temperature so that the vehicle is pre-heated by the departure time. When the departure time is reached, the auxiliary heating continues to heat for a further five minutes and then switches off. The auxiliary heating adopts the THERMATIC or THERMOTRONIC temperature setting.

You can switch off the auxiliary heating by using the remote control or the auxiliary heating button on the centre console.







-  Switch the auxiliary heating on regularly once a month for about ten minutes.

Selecting the departure time or deactivating a selected departure time



You can call up the **Aux. heating departure time** function directly.

- ▶ Turn the key to position **1** or **2** in the ignition lock.
- ▶ Press the button for the auxiliary heating on the centre console (▷ page 136).

or

- ▶ Press the  or  button on the steering wheel to select the **Settings** menu.
- ▶ Press the  button to call up the selection of submenus.
- ▶ Press the  or  button to select the **Heater** submenu.
- ▶ Press the  button to select **Aux. heating departure time**.









You will see the selected setting.







- ▶ Press the  or  button to select one of the three departure times or **Timer off** (no timer active).

If a switch-on time is selected, the yellow indicator lamp lights up on the auxiliary heating button.

- ▶ Press the ,  or  button to select a different display.

Changing the departure time

- ▶ Press the  or  button on the steering wheel to select the **Settings** menu.
- ▶ Press the  button to call up the selection of submenus.
- ▶ Press the  or  button to select the **Heater** submenu.
- ▶ Press the  button to select **Aux. heating departure time**.
- ▶ Press the  or  button to select **Time 1**, **Time 2** or **Time 3** to be changed.

- ▶ Press the  button to select **Departure time X Set hour**.
- ▶ Press the  or  button to set the hour.
- ▶ Press the  button to select **Departure time X Set minutes**.
- ▶ Press the  or  button to set the minutes.
- ▶ Press the  button to select a different display.
After changing from one menu to another, the new time setting is stored. The yellow indicator lamp lights up on the button for the auxiliary heating on the centre console.







Convenience





Activating/deactivating the EASY-ENTRY/EXIT feature

WARNING

The steering wheel moves when the EASY-ENTRY/EXIT feature is active. There is a risk of occupants becoming trapped. Before activating the EASY-ENTRY/EXIT feature, make sure that nobody can become trapped.











Do not leave children unsupervised in the vehicle, even if they are secured in a child restraint system. The children could open the driver's door and thereby unintentionally activate the EASY-ENTRY/EXIT feature and become trapped.

- ▶ Press the  or  button on the steering wheel to select the **Settings** menu.
- ▶ Press the  button to call up the selection of submenus.
- ▶ Press the  or  button to select the **Convenience** submenu.
- ▶ Press  to select the **EASY-ENTRY system**.
- ▶ Press the  button to save the setting.

- ▶ Press the  or  button to activate or deactivate the **EASY-ENTRY system**.
- ▶ Press the ,  or  button to select a different display.

Further information on the EASY-ENTRY/EXIT feature (▷ page 104).

Switching the belt adjustment on/off

- ▶ Press the  or  button on the steering wheel to select the **Settings** menu.
- ▶ Press the  button to call up the selection of submenus.
- ▶ Press the  or  button to select the **Convenience** submenu.
- ▶ Press the  button to select **Belt adjustment**.
- ▶ Press the  or  button to activate or deactivate **Belt adjustment**.
- ▶ Press the ,  or  button to select a different display.





For further information on belt adjustment, see (▷ page 49).







Switching the fold-in mirrors when locking function on/off

This function is available only in vehicles with Memory function (▷ page 108).

When you activate the **Fold in mirrors when locking** function, the exterior mirrors are folded in when the vehicle is locked. When you switch on the ignition, the exterior mirrors fold out again.

If you have switched the function on and you fold the exterior mirrors in using the button on the door (▷ page 106), they will not fold out automatically. The exterior mirrors can then only be folded out using the button on the door.







- ▶ Press the  or  button on the steering wheel to select the **Settings** menu.
- ▶ Press the  button to call up the selection of submenus.
- ▶ Press the  or  button to select the **Convenience** submenu.

- ▶ Press the  button to select **Fold in mirrors when locking**.
- ▶ Press the  or  button to activate or deactivate the **Fold in mirrors when locking** feature.
- ▶ Press the ,  or  button to select a different display.



Additional functions menu

Activating/deactivating the distance warning function









This function is only available with DIS-TRONIC.

- ▶ Press  or  on the steering wheel to select the **Additional functions** menu.
- ▶ Press the  or  button to select the **Distance warning** function.
- ▶ Press the  or  button to activate or deactivate the **Distance warning** system.

When the distance warning function (▷ page 65) is activated, the  symbol is shown in the lower multifunction display.

- ▶ To select a different display, press ,  or .









Activating/deactivating Blind Spot Assist

- ▶ Press  or  on the steering wheel to select the **Additional functions** menu.
- ▶ Press the  or  button to select the **Blind Spot Assist** function.
- ▶ Press the  or  button to switch **Blind Spot Assist** on or off.
- ▶ To select a different display, press ,  or .

For further information about Blind Spot Assist, see (▷ page 182).









Priming/deactivating tow-away protection

If you deactivate **Tow-away protection**, tow-away protection (▷ page 67) will not be primed when you next lock the vehicle.

- ▶ Press  or  on the steering wheel to select the **Additional functions** menu.
- ▶ Press the  or  button to select the **Tow-away protection** function.
- ▶ Press the  or  button to prime or deactivate **Tow-away protection**.
- ▶ To select a different display, press ,  or .

Priming/deactivating the interior motion sensor

If you deactivate **Interior motion sensor**, the interior motion sensor (▷ page 68) will not be primed when you next lock the vehicle.

- ▶ Press  or  on the steering wheel to select the **Additional functions** menu.
- ▶ Press the  or  button to select the **Interior motion sensor** function.
- ▶ Press the  or  button to prime or deactivate the **Interior motion sensor**.
- ▶ To select a different display, press ,  or .





Trip computer menu

Trip computer "From start" or "From reset"



Example: "From start" trip computer

- ① Distance
- ② Time

- ③ Average speed
- ④ Average fuel consumption
- ▶ Press the  or  button on the steering wheel to select the **trip computer** menu.
- ▶ Press the  or  button to select **From start** or **From reset**.





The values in the **From start** submenu are calculated from the start of a journey, whilst the values in the **From reset** submenu are calculated from the last time the submenu was reset (▷ page 208).

The **From start** trip computer is automatically reset when:





- the ignition has been switched off for more than four hours.
- 999 hours have been exceeded.
- 9,999 kilometres have been exceeded.

The **From reset** trip computer is automatically reset if the value exceeds 9,999 hours or 99,999 kilometres.

Resetting values

- ▶ Press the  or  button on the steering wheel to select the **trip computer** menu.
- ▶ Press the  or  button to select the function that you wish to reset.
- ▶ Press and hold the  reset button on the instrument cluster until the values have reverted to "0".

Calling up the range





- ▶ Press the  or  button on the steering wheel to select the **trip computer** menu.
- ▶ Press the  or  button to select **Range**:.

The multifunction display shows the estimated range of the vehicle, based on the current driving style and the fuel level. If there is only a small amount of fuel left in

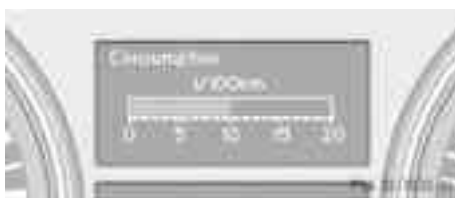
the fuel tank, the display shows a vehicle being refuelled  instead of the range.

Displaying the current fuel consumption



- ▶ Press the  or  button on the steering wheel to select the **trip computer** menu.
- ▶ Press the  or  button to select **Consumption**.

The current fuel consumption is displayed.

Telephone menu

Introduction

WARNING

Observe the legal requirements of the country in which you are currently driving regarding the use of mobile phones in the vehicle.



If it is permitted to use mobile phones while the vehicle is in motion, you should only use them when the road and traffic conditions allow. Otherwise, you may be distracted from the traffic conditions, cause an accident and injure yourself and others.

Functions and displays are dependent on the optional equipment installed in your vehicle.

- ▶ Switch on the mobile phone and audio equipment or COMAND APS; see the separate operating instructions.
- ▶ Insert the mobile phone into the mobile phone bracket (see the separate installa-

tion instructions for the mobile phone fitting).

or

- ▶ Establish a Bluetooth® connection to COMAND APS; see the separate operating instructions.
- ▶ Press the  or  button on the steering wheel to select the **Telephone** menu.

You will see one of the following display messages in the multifunction display:

- **Please enter PIN:** the mobile phone has been placed in the mobile phone bracket and the PIN has not yet been entered.
When you enter your PIN via the mobile phone, LINGUATRONIC or COMAND APS, the mobile phone searches for a network.
 - **Ready** or the name of the network provider: the mobile phone has found a network and is ready to receive.
 - **No Service:** there is no network available or the mobile phone is searching for a network.
- i** You can obtain further information about suitable mobile phones and connecting mobile phones via Bluetooth®:
- from any Mercedes Benz Service Centre
 - on the Internet at: <http://www.mercedes-benz.com/connect>

Accepting a call

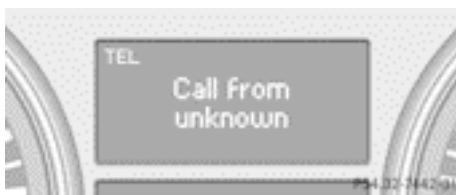

Example: incoming call

If someone calls you when you are in the **Telephone** menu, a display message appears in the multifunction display.

- ▶ Press the  button on the steering wheel to accept an incoming call.

If you are not in the **Telephone** menu, you can still accept a call.





Rejecting or ending a call



- ▶ Press the  button on the steering wheel.

If you are not in the **Telephone** menu, you can still accept a call.

Dialling a number from the phone book

You can use the mobile phone to enter new telephone numbers into the phone book (see the separate operating instructions). If your mobile phone is able to receive calls, you can search for and dial a number from the phone book.

- ▶ Press the  or  button on the steering wheel to select the **Telephone** menu.
- ▶ Press the  or  button to select the desired name.

To start scrolling rapidly, press and hold the  or  button for longer than one second.







- ▶ Press  to start dialling.

or

- ▶ **To exit the telephone book:** press .

Redialling

The on-board computer saves the last names or numbers dialled in the redial memory.

- ▶ Press the  or  button on the steering wheel to select the **Telephone** menu.
- ▶ Press the  button to switch to the redial memory.
- ▶ Press the  or  button to select the desired name or number.
- ▶ Press  to start dialling.

or

- ▶ **To exit the redial memory:** press .

Display messages

Introduction

General notes





Display messages appear in the multifunction display.

Display messages with graphic symbols are simplified in the Owner's Manual and may differ from the symbols in the multifunction display.

Please respond in accordance with the display messages and follow the additional notes in this Owner's Manual.

Certain display messages are accompanied by an audible warning tone or a continuous tone.

Hiding display messages

- ▶ Press the , ,  or  button on the steering wheel to select another display.
- or
- ▶ Press the (R) reset button on the instrument cluster (▷ page 30).

The display message is cleared.



The multifunction display shows high-priority display messages in red. Some high-priority display messages cannot be hidden.

The multifunction display shows these messages continuously until the causes for the messages have been remedied.



Message memory

The on-board computer saves certain display messages. You can call up the display messages in the **message memory** menu.

The **message memory** menu is only shown if any display messages have been stored.

- ▶ Press the  or  button repeatedly, until either the original menu or the **message memory** menu is shown.

If there are display messages, the multifunction display shows, e.g. **2 messages**.

- ▶ Press the  or  button to scroll through the display messages.

When the ignition is switched off, all display messages are deleted apart from some high-priority display messages. Once the causes of the high-priority display messages have been rectified, the corresponding display messages are also deleted.

Safety systems

Display messages





unavailable See Owner's Manual

Possible causes/consequences and ► Solutions

ABS (Anti-lock Braking System), ESP® (Electronic Stability Program), BAS (Brake Assist), PRE-SAFE®, hill start assist and ESP® trailer stabilisation are temporarily not available.

The adaptive brake lights may also have failed.

In addition, the ,  and  warning lamps light up in the instrument cluster.

Possible causes:

- Self-diagnosis is not yet complete.
- The on-board voltage may be insufficient.

⚠ WARNING

The brake system continues to function normally, but without the functions listed above. The wheels could therefore lock if you brake hard, for example.

The steerability and braking characteristics may be severely affected. The braking distance in an emergency braking situation can increase.

If ESP® is not operational, ESP® is unable to stabilise the vehicle. The danger of skidding and having an accident increases.

► Carefully drive on a suitable stretch of road, making slight steering movements, at a speed above 20 km/h.

If the display message disappears, the functions mentioned above are available again.

If the display message continues to be displayed:





- Drive on carefully.
- Visit a qualified specialist workshop.



inoperative See Owner's Manual

ABS, ESP®, BAS, PRE-SAFE®, hill start assist and ESP® trailer stabilisation are not available due to a malfunction.





The adaptive brake lights may also have failed.











In addition, the , ,  and  warning lamps light up in the instrument cluster.





⚠ WARNING

The brake system continues to function normally, but without the functions listed above. The wheels could therefore lock if you brake hard, for example.

The steerability and braking characteristics may be severely affected. The braking distance in an emergency braking situation can increase.

Display messages	Possible causes/consequences and ► Solutions
	<p>If ESP® is not operational, ESP® is unable to stabilise the vehicle. The danger of skidding and having an accident increases.</p> <ul style="list-style-type: none"> ► Drive on carefully. ► Visit a qualified specialist workshop immediately.
<div data-bbox="87 325 170 373" style="border: 1px solid black; padding: 2px; display: inline-block;">  </div> <p data-bbox="87 379 277 434">unavailable See Owner's Manual</p>	<p>ESP®, PRE-SAFE® and BAS, hill start assist and ESP® trailer stabilisation are temporarily not available. The adaptive brake lights may also have failed. In addition, the  and  warning lamps light up in the instrument cluster. The self-diagnosis function may not be complete, for example.</p> <p>⚠ WARNING</p> <p>The brake system continues to function normally, but without the functions listed above. The braking distance in an emergency braking situation can thus increase.</p> <p>If ESP® is not operational, ESP® is unable to stabilise the vehicle. The danger of skidding and having an accident increases.</p> <ul style="list-style-type: none"> ► Carefully drive on a suitable stretch of road, making slight steering movements, at a speed above 20 km/h. <p>If the display message disappears, ESP® is available again. If the display message disappears, the functions mentioned above are available again.</p> <p>If the display message continues to be displayed:</p> <ul style="list-style-type: none"> ► Drive on carefully. ► Visit a qualified specialist workshop. <p>ESP®, PRE-SAFE® and BAS, hill start assist and ESP® trailer stabilisation are temporarily not available. In addition, the  and  warning lamps light up in the instrument cluster. For example, the on-board voltage may be insufficient. The brake system continues to function normally, but without the functions listed above.</p> <ul style="list-style-type: none"> ► Drive on carefully. ► Visit a qualified specialist workshop immediately.







Display messages	Possible causes/consequences and ► Solutions
	<p>If the display message is shown while the vehicle is in motion and the  warning lamp flashes, the electronic traction system is deactivated. Otherwise, the brakes on the drive wheels could overheat.</p> <ul style="list-style-type: none"> ► Let the brakes cool down until the display message disappears and the  warning lamp goes out. The electronic traction system is active again.
 <p>inoperative See Owner's Manual</p>	<p>ESP[®], PRE-SAFE[®] and BAS, hill start assist and ESP[®] trailer stabilisation are not available due to a malfunction.</p> <p>The adaptive brake lights may also have failed.</p> <p>In addition, the  and  warning lamps light up in the instrument cluster.</p> <p>⚠ WARNING</p> <p>The brake system continues to function normally, but without the functions listed above.</p> <p>The braking distance in an emergency braking situation can thus increase.</p> <p>If ESP[®] is not operational, ESP[®] is unable to stabilise the vehicle. The danger of skidding and having an accident increases.</p> <ul style="list-style-type: none"> ► Drive on carefully. ► Visit a qualified specialist workshop.
   <p>inoperative See Owner's Manual</p>	<p>EBD (electronic brake force distribution), ABS, ESP[®], BAS, PRE-SAFE[®], hill start assist and ESP[®] trailer stabilisation are not available due to a malfunction.</p> <p>The adaptive brake lights may also have failed.</p> <p>In addition, the ,  and  warning lamps light up in the instrument cluster and a warning tone sounds.</p> <p>⚠ WARNING</p> <p>The brake system continues to function normally, but without the functions listed above. The front and rear wheels could therefore lock if you brake hard, for example.</p> <p>The steerability and braking characteristics may be severely affected. The braking distance in an emergency braking situation can increase.</p> <p>If ESP[®] is not operational, ESP[®] is unable to stabilise the vehicle. The danger of skidding and having an accident increases.</p> <ul style="list-style-type: none"> ► Drive on carefully. ► Visit a qualified specialist workshop immediately.







Display messages	Possible causes/consequences and ► Solutions
 Release parking brake	You are driving with the parking brake applied. A warning tone also sounds. ► Release the parking brake.
 Check brake fluid level	There is insufficient brake fluid in the brake fluid reservoir. In addition, the  warning lamp in the instrument cluster lights up and a warning tone sounds. ▲ WARNING The braking efficiency may be impaired. There is a risk of an accident. ► Pull over and stop the vehicle safely as soon as possible, paying attention to road and traffic conditions. Do not continue driving under any circumstances. ► Secure the vehicle against rolling away (▷ page 158). ► Consult a qualified specialist workshop. ► Do not top up the brake fluid. This does not correct the error.
 Brake wear	The brake pads/linings have reached their wear limit. ► Visit a qualified specialist workshop.
PRE-SAFE inoperative See Owner's Manual	Important functions of PRE-SAFE® have failed. All other occupant safety systems, e.g. airbags, remain available. ► Visit a qualified specialist workshop immediately.
 Restraint sys. malfunction Consult workshop	There is a malfunction in the SRS (Supplemental Restraint System). ▲ WARNING The airbags or belt tensioners may either be triggered unintentionally or, in the event of an accident, may not be triggered. This poses an increased risk of injury. ► Visit a qualified specialist workshop. Further information on occupant safety (▷ page 41).





Lights



i Display messages about LEDs:





This display message will only appear if all LEDs have failed.

Display messages	Possible causes/consequences and ► Solutions
 <p>Left-hand dipped beam or Right-hand dipped beam</p>	<p>The left or right-hand dipped-beam headlamp is faulty.</p> <ul style="list-style-type: none"> ► Check whether you are permitted to replace the bulb yourself (▷ page 116). <p>or</p> <ul style="list-style-type: none"> ► Visit a qualified specialist workshop.
 <p>Trailer Left-hand tail lamp or Trailer Right-hand tail lamp</p>	<p>The left or right-hand trailer tail lamp is faulty.</p> <ul style="list-style-type: none"> ► Check whether you are permitted to replace the bulb yourself. <p>or</p> <ul style="list-style-type: none"> ► Visit a qualified specialist workshop.
 <p>Trailer Left-hand turn signal or Trailer Right-hand turn signal</p>	<p>The left or right-hand trailer turn signal lamp is faulty.</p> <ul style="list-style-type: none"> ► Check whether you are permitted to replace the bulb yourself. <p>or</p> <ul style="list-style-type: none"> ► Visit a qualified specialist workshop.
 <p>Trailer brake lamp</p>	<p>The trailer brake lamp is faulty.</p> <ul style="list-style-type: none"> ► Check whether you are permitted to replace the bulb yourself. <p>or</p> <ul style="list-style-type: none"> ► Visit a qualified specialist workshop.
 <p>Turn signal, rear left or Turn signal, rear right</p>	<p>The rear left-hand or rear right-hand turn signal is faulty.</p> <ul style="list-style-type: none"> ► Check whether you are permitted to replace the bulb yourself (▷ page 116). <p>or</p> <ul style="list-style-type: none"> ► Visit a qualified specialist workshop.
 <p>Turn signal, front left or Turn signal, front right</p>	<p>The front left-hand or front right-hand turn signal is faulty.</p> <ul style="list-style-type: none"> ► Check whether you are permitted to replace the bulb yourself (▷ page 116). <p>or</p> <ul style="list-style-type: none"> ► Visit a qualified specialist workshop.
 <p>Turn signal in mirror, left or Turn signal in mirror, right</p>	<p>The turn signal in the left-hand or right-hand exterior mirror is faulty.</p> <ul style="list-style-type: none"> ► Check whether you are permitted to replace the bulb yourself (▷ page 116). <p>or</p> <ul style="list-style-type: none"> ► Visit a qualified specialist workshop.





Display messages	Possible causes/consequences and ► Solutions
 3rd brake lamp	<p>The third brake lamp is faulty.</p> <p>► Check whether you are permitted to replace the bulb yourself (▷ page 116).</p> <p>or</p> <p>► Visit a qualified specialist workshop.</p>
 Left-hand brake lamp or Right-hand brake lamp	<p>The left or right-hand brake lamp is faulty.</p> <p>► Check whether you are permitted to replace the bulb yourself (▷ page 116).</p> <p>or</p> <p>► Visit a qualified specialist workshop.</p>
 Main beam, left or Main beam, right	<p>The left or right-hand high beam is faulty.</p> <p>► Check whether you are permitted to replace the bulb yourself (▷ page 116).</p> <p>or</p> <p>► Visit a qualified specialist workshop.</p>
 Licence plate lamp, left or Licence plate lamp, right	<p>The left or right-hand licence plate lamp is faulty.</p> <p>► Check whether you are permitted to replace the bulb yourself (▷ page 116).</p> <p>or</p> <p>► Visit a qualified specialist workshop.</p>
 Front fog lamp, left or Front fog lamp, right	<p>The left-hand or right-hand front fog lamp is faulty.</p> <p>► Check whether you are permitted to replace the bulb yourself (▷ page 116).</p> <p>or</p> <p>► Visit a qualified specialist workshop.</p>
 Rear left-hand fog lamp or Rear right-hand fog lamp	<p>The left-hand or right-hand rear fog lamp is faulty.</p> <p>► Check whether you are permitted to replace the bulb yourself (▷ page 116).</p> <p>or</p> <p>► Visit a qualified specialist workshop.</p>
 Parking lamp, front left or Parking lamp, front right	<p>The front left or front right parking lamp is faulty.</p> <p>► Check whether you are permitted to replace the bulb yourself (▷ page 116).</p> <p>or</p> <p>► Visit a qualified specialist workshop.</p>



Display messages	Possible causes/consequences and ► Solutions
 <p>Reversing lamp, left or Reversing lamp, right</p>	<p>The left or right-hand reversing lamp is faulty.</p> <ul style="list-style-type: none"> ► Check whether you are permitted to replace the bulb yourself (▷ page 116). <p>or</p> <ul style="list-style-type: none"> ► Visit a qualified specialist workshop.
 <p>Left-hand tail lamp or Right-hand tail lamp</p>	<p>The left or right-hand tail lamp is faulty.</p> <ul style="list-style-type: none"> ► Check whether you are permitted to replace the bulb yourself (▷ page 116). <p>or</p> <ul style="list-style-type: none"> ► Visit a qualified specialist workshop.
 <p>Left-hand daytime driving lamp or Right-hand daytime driving lamp</p>	<p>The left-hand or right-hand daytime driving lamp is faulty.</p> <ul style="list-style-type: none"> ► Check whether you are permitted to replace the bulb yourself (▷ page 116). <p>or</p> <ul style="list-style-type: none"> ► Visit a qualified specialist workshop.
 <p>AUTO lights inoper- ative</p>	<p>The light sensor is faulty.</p> <ul style="list-style-type: none"> ► Switch off the daytime driving lights in the on-board computer (▷ page 202). ► Switch the lights on and off using the light switch. ► Visit a qualified specialist workshop.
 <p>Switch off lights</p>	<p>The lights are still switched on when you leave the vehicle. A warning tone also sounds.</p> <ul style="list-style-type: none"> ► Turn the light switch to 0 or AUTO. <p>or</p> <ul style="list-style-type: none"> ► If the rear foglamp is switched on: press the light switch in to the stop.



Engine	
Display messages	Possible causes/consequences and ► Solutions
 <p>Top up coolant See Owner's Manual</p>	<p>The coolant level is too low.</p> <p>! Avoid making long journeys with too little coolant in the engine cooling system. The engine will otherwise be damaged.</p> <ul style="list-style-type: none"> ► Top up the coolant, observing the warning notes before doing so (► page 281). ► If the coolant needs topping up more often than usual, have the engine coolant system checked at a qualified specialist workshop.
	<p>The fan motor is faulty.</p> <ul style="list-style-type: none"> ► If the coolant temperature is below 120 °C, you can continue driving to the nearest qualified specialist workshop. ► Avoid heavy loads on the engine as you do so, e.g. driving in mountainous terrain and stop-start traffic.
 <p>Coolant Stop car, turn engine off</p>	<p>The coolant is too hot. A warning tone also sounds.</p> <p>⚠ WARNING</p> <p>Never drive with an overheated engine. Driving when your engine is overheated can cause some fluids which may have leaked into the engine compartment to catch fire.</p> <p>Steam from an overheated engine can cause serious burns which can occur just by opening the bonnet.</p> <p>There is a risk of injury.</p> <ul style="list-style-type: none"> ► Stop the vehicle immediately, paying attention to road and traffic conditions, and switch off the engine. ► Secure the vehicle against rolling away (► page 158). ► Leave the vehicle and keep a safe distance from the vehicle until the engine has cooled down. ► Make sure that the air supply to the engine radiator is not blocked, e.g. by frozen slush. ► Do not start the engine again until the display message goes out and the coolant temperature is under 120 °C. The engine may otherwise be damaged. ► Pay attention to the coolant temperature display. ► If the temperature increases again, visit a qualified specialist workshop immediately. <p>The reading may rise up to 120 °C under normal driving conditions if the coolant has been filled correctly.</p>

Display messages	Possible causes/consequences and ► Solutions
	<p>The battery is not being charged. A warning tone also sounds.</p> <p>Possible causes:</p> <ul style="list-style-type: none"> • faulty alternator • torn poly-V-belt • a malfunction in the electronics <p>► Stop the vehicle immediately, paying attention to road and traffic conditions, and switch off the engine.</p> <p>► Open the bonnet.</p> <p>► Check whether the poly-V-belt is torn.</p> <p>If the poly-V-belt is torn:</p> <p>! Do not continue driving. The engine could otherwise overheat.</p> <p>► Consult a qualified specialist workshop.</p> <p>If the poly-V-belt is OK:</p> <p>► Visit a qualified specialist workshop.</p>
 <p>Battery/Alternator Stop vehicle</p>	<p>The battery is faulty.</p> <p>You will need to use considerably more force to brake. The brake pedal travel and braking distance will increase. If necessary, depress the brake pedal with maximum force.</p> <p>► Pull over and safely stop the vehicle safely as soon as possible, paying attention to road and traffic conditions. Do not continue driving under any circumstances.</p> <p>► Apply the parking brake.</p> <p>► Consult a qualified specialist workshop.</p>
 <p>Check engine oil level when next refuelling</p>	<p>The engine oil level has dropped to the minimum level. A warning tone also sounds.</p> <p>► Check the oil level when next refuelling, at the latest (► page 280).</p> <p>► If necessary, top up the engine oil (► page 280).</p> <p>► Have the engine checked at a qualified specialist workshop if the engine oil needs topping up more often than usual.</p>
 <p>Reserve fuel level</p>	<p>The fuel level has dropped into the reserve range. Operation of the auxiliary heating is deactivated when the fuel level drops into the reserve range.</p> <p>► Refuel at the nearest filling station.</p>

Display messages	Possible causes/consequences and ► Solutions
	There is only a very small amount of fuel in the fuel tank. The auxiliary heating cannot be operated. ► Refuel at the nearest filling station without fail.
 Replace air filter element	Vehicles with a diesel engine: the engine air filter is dirty and must be replaced. ► Visit a qualified specialist workshop.
 Clean fuel filter	Vehicles with a diesel engine: there is water in the fuel filter. The water must be drained off. ► Visit a qualified specialist workshop.
Refill AdBlue at workshop See Owner's Manual	The AdBlue® level has fallen below the reserve range. A warning tone also sounds. ► Have AdBlue® refilled as soon as possible at a qualified specialist workshop.
Refill AdBlue at workshop No start in: XXXX km	The AdBlue® level is only sufficient for the indicated distance. A warning tone also sounds. ► Have AdBlue® refilled as soon as possible at a qualified specialist workshop.
Refill AdBlue at workshop Engine start not possible	The AdBlue® tank is empty. A warning tone also sounds. You can no longer start the engine. ► Consult a qualified specialist workshop immediately.
Check AdBlue See Owner's Manual	The AdBlue® system is malfunctioning. A warning tone also sounds. ► Visit a qualified specialist workshop.
AdBlue No start in: XXXX km	The AdBlue® system is malfunctioning. A warning tone also sounds. ► Visit a qualified specialist workshop immediately.
AdBlue Engine start not possible	The AdBlue® system is malfunctioning. A warning tone also sounds. You can no longer start the engine. ► Consult a qualified specialist workshop immediately.

Driving systems	
Display messages	Possible causes/consequences and ► Solutions
 <p>Vehicle rising Wait briefly</p>	<p>The vehicle level is too low when the vehicle is stationary.</p> <ul style="list-style-type: none"> ► Do not pull away. The vehicle level is set when the display message disappears.
 <p>STOP car too low</p>	<p>You have pulled away while the vehicle level is still too low, or the rear axle level control or AIRMATIC is faulty.</p> <p>The rear axle level control or AIRMATIC sets the vehicle to the selected level after a short period. While the display message is displayed:</p> <p>AIRMATIC sets the vehicle to the selected level after a short period. While the display message is displayed:</p> <ul style="list-style-type: none"> ► Make only slight steering movements. Otherwise, the front wing or the tyre could be damaged if the steering movement is too large. ► Listen for scraping sounds. ► Do not drive at speeds above 80 km/h. <p>If the display message continues to be displayed:</p> <ul style="list-style-type: none"> ► Have the vehicle checked at a qualified specialist workshop.
 <p>Level selection not permitted</p>	<p>You cannot change the vehicle level. Possible causes:</p> <ul style="list-style-type: none"> • vehicles with AIRMATIC: you are exceeding the speed permissible for the selected vehicle level. • you are towing a trailer. • the trailer-coupling socket is being used, e.g. for a bicycle rack. <ul style="list-style-type: none"> ► Vehicles with AIRMATIC: drive more slowly and then select the desired vehicle level again (► page 174). ► Observe the notes on towing a trailer (► page 184).
 <p>Compressor cooling down</p>	<p>You have selected a higher vehicle level. The compressor first needs to cool down because of frequent level changes.</p> <ul style="list-style-type: none"> ► Drive in a manner appropriate for the current vehicle level. ► Make sure that there is sufficient ground clearance. ► Allow the compressor to cool down. <p>When the compressor has cooled down, the display message disappears. The vehicle then continues rising to the selected level.</p>

Display messages	Possible causes/consequences and ► Solutions
 <p>Malfunction</p>	<p>Rear axle level control or AIRMATIC is malfunctioning.</p> <ul style="list-style-type: none"> ► Vehicles with rear axle level control: do not exceed 80 km/h. ► Vehicles with AIRMATIC: drive as appropriate for the current vehicle level, but do not exceed 80 km/h. ► Make sure that there is sufficient ground clearance. ► Have the vehicle checked at a qualified specialist workshop.
<p>Radar sensor deactivated autom. See Owner's Manual</p>	<p>Vehicles with a navigation system: the vehicle is close to a radio telescope facility and is therefore prohibited from transmitting any radar signals. The radar sensor system has switched off automatically (▷ page 349).</p> <p>If Active Blind Spot Assist was activated, it is no longer available. The yellow  indicator lamps also light up in the exterior mirrors.</p> <ul style="list-style-type: none"> ► Drive on. Once you have moved far enough away from the radio telescope, Blind Spot Assist is available again.
<p>Blind Spot Assist currently unavailable See Owner's Manual</p>	<p>Blind Spot Assist is temporarily inoperative. You have established the electrical connection between the trailer and your vehicle.</p> <ul style="list-style-type: none"> ► Press  to confirm the display message. <p>Blind Spot Assist is deactivated while towing a trailer.</p>





Display messages	Possible causes/consequences and ► Solutions
	<p>Blind Spot Assist is temporarily inoperative. Possible causes:</p> <ul style="list-style-type: none"> • the sensors are dirty. • the function is impaired due to heavy rain or snow. • the radar sensor system is outside the operating temperature range. • the radar sensor system is temporarily inoperative, e.g. due to electromagnetic radiation emitted by nearby TV or radio stations or other sources of electromagnetic radiation. <p>The yellow  indicator lamps also light up in the exterior mirrors.</p> <p>When the causes listed above no longer apply, the display message goes out.</p> <p>Blind Spot Assist is operational again.</p> <p>If you are driving without a trailer and the display message does not disappear:</p> <p>If the display message does not disappear:</p> <ul style="list-style-type: none"> ► Pull over and stop the vehicle safely as soon as possible, paying attention to road and traffic conditions. ► Secure the vehicle against rolling away (▷ page 158). ► Clean the sensors (▷ page 287). ► Restart the engine.
Blind Spot Assist inoperative	<p>Blind Spot Assist is faulty.</p> <p>The yellow  indicator lamps also light up in the exterior mirrors.</p> <ul style="list-style-type: none"> ► Visit a qualified specialist workshop.
Cruise control and SPEEDTRONIC inoperative	<p>SPEEDTRONIC and cruise control are malfunctioning.</p> <p>A warning tone also sounds.</p> <ul style="list-style-type: none"> ► Visit a qualified specialist workshop.
Limit --- km/h	<p>While depressing the accelerator pedal beyond the pressure point (kickdown), SPEEDTRONIC cannot be activated.</p>
Cruise control - - - km/h	<p>A condition for activating cruise control has not been met.</p> <p>You have tried to store a speed below 30 km/h, for example.</p> <ul style="list-style-type: none"> ► If conditions permit, drive faster than 30 km/h and store the speed. ► Check the activation conditions for cruise control (▷ page 163).

Display messages	Possible causes/consequences and ► Solutions
120 km/h! Maximum speed exceeded	<p>Only for certain countries: the maximum speed has been exceeded.</p> <p>In addition, the multifunction display shows 120 km/h!.</p> <p>► Drive more slowly.</p>
DISTRONIC --- km/h	<p>An activation condition for DISTRONIC is not fulfilled.</p> <p>► Check the activation conditions for DISTRONIC (▷ page 167).</p>
DISTRONIC and SPEEDTRONIC Inoperative	<p>DISTRONIC and SPEEDTRONIC are faulty.</p> <p>► Visit a qualified specialist workshop.</p>
DISTRONIC Override	<p>DISTRONIC is no longer controlling the speed of the vehicle.</p> <p>► Remove your foot from the accelerator pedal.</p>
DISTRONIC Inoperative	<p>DISTRONIC is faulty or the display has failed.</p> <p>► Visit a qualified specialist workshop.</p>
DISTRONIC currently unavailable See Owner's Manual	<p>DISTRONIC is deactivated and temporarily inoperative. Possible causes:</p> <ul style="list-style-type: none"> • the DISTRONIC cover in the radiator trim is dirty. • function is impaired due to heavy rain, snow or fog. • the radar sensor system is temporarily inoperative, e.g. due to electromagnetic radiation emitted by nearby TV or radio stations or other sources of electromagnetic radiation. • the radar sensor system has not detected any vehicles or stationary objects, e.g. traffic signs, for a long time. • the system is outside the operating temperature range. <p>When the causes listed above no longer apply, the display message goes out.</p> <p>DISTRONIC is operational again.</p> <p>If the display message does not disappear:</p> <ul style="list-style-type: none"> ► Pull over and stop the vehicle safely as soon as possible, paying attention to road and traffic conditions. ► Secure the vehicle against rolling away (▷ page 158). ► Clean the DISTRONIC cover in the radiator trim (▷ page 287). ► Restart the engine.







Tyres	
Display messages	Possible causes/consequences and ► Solutions
Tyre pressure Check tyres	<p>The tyre pressure loss warning system has detected a significant loss in pressure.</p> <p>A warning tone also sounds.</p> <p> WARNING</p> <p>With tyre pressures which are too low, there is a risk of the following hazards:</p> <ul style="list-style-type: none"> • they may burst, especially as the load and vehicle speed increase. • they may wear excessively and/or unevenly, which may greatly impair tyre traction. • the driving characteristics, as well as steering and braking, may be greatly impaired. <p>There is a risk of an accident.</p> <ul style="list-style-type: none"> ► Stop the vehicle without making any sudden steering or braking manoeuvres. Pay attention to the traffic conditions as you do so. ► Secure the vehicle against rolling away (► page 158). ► If there is a flat tyre, inspect the tyres (► page 295). ► Check the tyre pressures and, if necessary, correct the tyre pressure. ► Restart the tyre pressure loss warning system when the tyre pressure is correct (► page 317).
Check tyres then restart Run Flat Indicator	<p>The tyre pressure loss warning system generated a display message and has not been restarted since.</p> <ul style="list-style-type: none"> ► Set the correct tyre pressure in all four tyres. ► Restart the tyre pressure loss warning system (► page 317).
Run Flat Indicator inoperative	<p>The tyre pressure loss warning system is faulty.</p> <ul style="list-style-type: none"> ► Visit a qualified specialist workshop.
Tyre pressure displayed only after driving for a few minutes	<p>The tyre pressure monitor is measuring the tyre pressure.</p> <ul style="list-style-type: none"> ► Drive on. <p>The tyre pressures appear in the multifunction display after you have been driving for a few minutes.</p>
Tyre pressure monitor inoperative	<p>The tyre pressure monitor is faulty.</p> <ul style="list-style-type: none"> ► Visit a qualified specialist workshop.







Display messages	Possible causes/consequences and ► Solutions
Tyre press. monitor inoperative No wheel sensors	<p>The wheels fitted do not have a suitable tyre pressure sensor. The tyre pressure monitor is deactivated.</p> <p>► Fit wheels with suitable tyre pressure sensors. The tyre pressure monitor is activated automatically after driving for a few minutes.</p>
Check tyres	<p>The tyre pressure in one or more tyres has dropped significantly. The wheel position is displayed in the multifunction display. A warning tone also sounds.</p> <p> WARNING</p> <p>With tyre pressures which are too low, there is a risk of the following hazards:</p> <ul style="list-style-type: none"> • they may burst, especially as the load and vehicle speed increase. • they may wear excessively and/or unevenly, which may greatly impair tyre traction. • the driving characteristics, as well as steering and braking, may be greatly impaired. <p>There is a risk of an accident.</p> <p>► Stop the vehicle without making any sudden steering or braking manoeuvres. Pay attention to the traffic conditions as you do so.</p> <p>► Secure the vehicle against rolling away (▷ page 158).</p> <p>► If there is a flat tyre, inspect the tyres (▷ page 295).</p> <p>► Check the tyre pressure (▷ page 318).</p> <p>► If necessary, correct the tyre pressure.</p>





Display messages	Possible causes/consequences and ► Solutions
Caution, tyre defect	<p>The tyre pressure in one or more tyres has dropped suddenly. The wheel position is displayed in the multifunction display.</p> <p> WARNING</p> <p>If you drive with a flat tyre, there is a risk of the following hazards:</p> <ul style="list-style-type: none"> • A flat tyre affects the ability to steer or brake the vehicle. • You could lose control of the vehicle. • Continued driving with a flat tyre will cause excessive heat build-up and possibly a fire. <p>There is a risk of an accident.</p> <ul style="list-style-type: none"> ► Stop the vehicle without making any sudden steering or braking manoeuvres. Pay attention to the traffic conditions as you do so. ► Secure the vehicle against rolling away (▷ page 158). ► If there is a flat tyre, inspect the tyres (▷ page 295).
Please correct tyre pressure	<p>The tyre pressure is too low in at least one of the tyres, or the tyre pressure difference between the wheels is too great.</p> <ul style="list-style-type: none"> ► Check the tyre pressures at the next opportunity (▷ page 318). ► If necessary, correct the tyre pressure. ► Restart the tyre pressure monitor (▷ page 319).
Tyre press. mon. Wheel sensor missing	<p>There is no signal from the tyre pressure sensor of one or several wheels. The pressure of the affected tyre is not displayed in the multifunction display.</p> <ul style="list-style-type: none"> ► Have the faulty tyre pressure sensor replaced at a qualified specialist workshop.
Tyre pressure monitor not currently available	<p>Due to a source of radio interference, no signals can be received from the wheel sensors. The tyre pressure monitor is temporarily malfunctioning.</p> <ul style="list-style-type: none"> ► Drive on. The tyre pressure monitor restarts automatically as soon as the cause has been rectified.



Display messages	Possible causes/consequences and ► Solutions
 <p data-bbox="87 228 314 284">Tyre pressure Caution, tyre malf.</p>	<p data-bbox="342 172 972 236">The tyre pressure in one or more tyres has dropped suddenly. A warning tone also sounds.</p> <p data-bbox="353 252 505 284"> WARNING</p> <p data-bbox="342 300 1003 323">If you drive with a flat tyre, there is a risk of the following hazards:</p> <ul data-bbox="353 339 1003 464" style="list-style-type: none"> • A flat tyre affects the ability to steer or brake the vehicle. • You could lose control of the vehicle. • Continued driving with a flat tyre will cause excessive heat build-up and possibly a fire. <p data-bbox="365 472 665 496">There is a risk of an accident.</p> <ul data-bbox="342 512 1003 663" style="list-style-type: none"> ► Stop the vehicle without making any sudden steering or braking manoeuvres. Pay attention to the traffic conditions as you do so. ► Secure the vehicle against rolling away (▷ page 158). ► If there is a flat tyre, inspect the tyres (▷ page 295).
 <p data-bbox="87 742 253 798">Tyre pressure Check tyre(s)</p>	<p data-bbox="342 686 1003 710">The tyre pressure in one or more tyres has dropped significantly.</p> <p data-bbox="353 726 505 758"> WARNING</p> <p data-bbox="342 774 983 829">With tyre pressures which are too low, there is a risk of the following hazards:</p> <ul data-bbox="353 845 1003 1029" style="list-style-type: none"> • they may burst, especially as the load and vehicle speed increase. • they may wear excessively and/or unevenly, which may greatly impair tyre traction. • the driving characteristics, as well as steering and braking, may be greatly impaired. <p data-bbox="365 1037 665 1061">There is a risk of an accident.</p> <ul data-bbox="342 1077 1003 1300" style="list-style-type: none"> ► Stop the vehicle without making any sudden steering or braking manoeuvres. Pay attention to the traffic conditions as you do so. ► Secure the vehicle against rolling away (▷ page 158). ► If there is a flat tyre, inspect the tyres (▷ page 295). ► Check the tyre pressure (▷ page 318). ► If necessary, correct the tyre pressure.
 <p data-bbox="87 1380 264 1436">Please correct tyre pressure</p>	<p data-bbox="342 1324 1003 1380">The tyre pressure is too low in at least one of the tyres, or the tyre pressure difference between the wheels is too great.</p> <ul data-bbox="342 1396 863 1484" style="list-style-type: none"> ► Check the tyre pressures at the next opportunity (▷ page 318). ► If necessary, correct the tyre pressure.

Vehicle	
Display messages	Possible causes/consequences and ► Solutions
To start the engine, shift to either P or N	You have attempted to start the engine with the transmission in position R or D . ► Shift the transmission to position P or N .
Auxiliary battery malfunction	The auxiliary battery for the automatic transmission is no longer being charged. ► Visit a qualified specialist workshop at the next opportunity. ► Until then, set the automatic transmission to position P before you switch off the engine. ► Before leaving the vehicle, apply the parking brake. ► Secure the vehicle against rolling away (▷ page 158).
Depress brake to shift out of position P	You have attempted to move the transmission selector lever to position D , R or N without depressing the brake pedal. ► Depress the brake pedal.
Vehicle not in position P	The driver's door is open and the transmission is in position R , N or D . ► Shift the transmission to position P . ► Secure the vehicle against rolling away (▷ page 158).
Drive to workshop without changing gear	You cannot change the transmission position due to a malfunction. If transmission position D is selected: ► Drive to a qualified specialist workshop without shifting the transmission from position D . If transmission position R , N or P is selected: ► Consult a qualified specialist workshop.
Select position P only when the vehicle is at a standstill	The vehicle is moving. ► Pull over and stop the vehicle safely as soon as possible, paying attention to road and traffic conditions. ► Shift the transmission to position P .
Compass unavailable	The compass is malfunctioning. ► Have the compass checked at a qualified specialist workshop.
Compass ---	The compass is not calibrated. ► Calibrate the compass (▷ page 272).

Display messages	Possible causes/consequences and ► Solutions
Compass ---	<p>The compass is malfunctioning due to external interference. As soon as the source of the interference has been removed:</p> <ul style="list-style-type: none"> ► Turn the key to position 0 in the ignition lock and remove it. ► Wait until the trip meter is no longer shown in the multifunction display. ► Calibrate the compass (▷ page 272).
	<p>The tailgate is open.</p> <p> WARNING</p> <p>When the engine is running, exhaust gases can enter the vehicle interior if the tailgate is open. There is a risk of poisoning.</p> <ul style="list-style-type: none"> ► Close the tailgate. <p>Vehicles with anti-theft alarm system: The bonnet is open.</p> <p> WARNING</p> <p>The open bonnet may then block your view when the vehicle is in motion. There is a risk of an accident.</p> <ul style="list-style-type: none"> ► Pull over and stop the vehicle safely as soon as possible, paying attention to road and traffic conditions. ► Secure the vehicle against rolling away (▷ page 158). ► Close the bonnet.
	<p>At least one door is open.</p> <ul style="list-style-type: none"> ► Close all doors.
 <p>Power steering mal- function See Own- er's Manual</p>	<p>The power steering assistance is faulty. A warning tone also sounds.</p> <p> WARNING</p> <p>You will need to use more force to steer. There is a risk of an accident.</p> <ul style="list-style-type: none"> ► Check whether you are able to apply the extra force required. ► If you are able to steer safely: carefully drive on to a qualified specialist workshop. ► If you are unable to steer safely: do not drive on. Contact the nearest qualified specialist workshop.

Display messages	Possible causes/consequences and ► Solutions
 <p>inoperative Bat- tery weak</p>	<p>The on-board voltage is too low. The auxiliary heating has switched itself off or cannot be switched on (► page 135).</p> <ul style="list-style-type: none"> ► Drive for a longer distance. The battery is being charged. The auxiliary heating is operational again as soon as the on-board electrical system voltage is sufficient.
 <p>inoperative Refuel</p>	<p>There is too little fuel in the fuel tank. The auxiliary heating cannot be switched on (► page 135).</p> <ul style="list-style-type: none"> ► Refuel at the nearest filling station.
 <p>inoperative See Owner's Manual</p>	<p>The auxiliary heating has a temporary malfunction or is faulty.</p> <ul style="list-style-type: none"> ► When the vehicle is on a level surface and the engine has cooled down, make up to four attempts to switch on the auxiliary heating, waiting several minutes between each attempt (► page 135). ► If the auxiliary heating does not switch on, consult a qualified specialist workshop.
<p>No Service</p>	<p>Your vehicle is outside the network provider's transmitter/receiver range.</p> <ul style="list-style-type: none"> ► Wait until the mobile phone operational readiness symbol appears in the multifunction display.
 <p>Please enter PIN</p>	<p>You have not yet logged on to your mobile phone.</p> <ul style="list-style-type: none"> ► Enter the PIN for the SIM card.
 <p>Bluetooth ready</p>	<p>The Bluetooth® connection between your mobile phone and the audio system or COMAND APS is not activated.</p> <ul style="list-style-type: none"> ► If desired, activate the Bluetooth® connection between the mobile phone and the audio system or COMAND APS (see the separate operating instructions).
 <p>No telephone inser- ted</p>	<p>Your mobile phone is not inserted in the bracket.</p> <ul style="list-style-type: none"> ► Insert the mobile phone into the bracket.
 <p>Top up washer fluid</p>	<p>The washer fluid level has dropped to approximately 1/3 of the total reservoir capacity.</p> <ul style="list-style-type: none"> ► Top up the washer fluid (► page 281).



Key	
Display messages	Possible causes/consequences and ► Solutions
 <p>Key does not belong to vehicle</p>	<p>You have put the wrong key in the ignition lock.</p> <ul style="list-style-type: none"> ► Use the correct key.
 <p>You need a new key</p>	<p>The key needs to be replaced.</p> <ul style="list-style-type: none"> ► Visit a qualified specialist workshop.
 <p>Change key batteries</p>	<p>The batteries of the KEYLESS-GO key are discharged.</p> <ul style="list-style-type: none"> ► Change the batteries (► page 73).
 <p>Key not detected (red display message)</p>	<p>The KEYLESS-GO key is not in the vehicle. A warning tone also sounds. If the engine is switched off, you can no longer lock the vehicle centrally or start the engine.</p> <ul style="list-style-type: none"> ► Pull over and stop the vehicle safely as soon as possible, paying attention to road and traffic conditions. ► Secure the vehicle against rolling away (► page 158). ► Locate the KEYLESS-GO key.
	<p>The KEYLESS-GO key is not detected while the engine is running because there is interference from a strong source of radio waves. A warning tone also sounds.</p> <ul style="list-style-type: none"> ► Pull over and stop the vehicle safely as soon as possible, paying attention to road and traffic conditions. ► Secure the vehicle against rolling away (► page 158). ► Operate the vehicle with the key in the ignition lock if necessary.
 <p>Key not detected (white display message)</p>	<p>The KEYLESS-GO key cannot be detected at present.</p> <ul style="list-style-type: none"> ► Change the location of the key with the KEYLESS-GO functions in the vehicle. <p>If the KEYLESS-GO key is still not detected:</p> <ul style="list-style-type: none"> ► Operate the vehicle with the key in the ignition lock if necessary.

Display messages	Possible causes/consequences and ► Solutions
 Key detected in vehicle	The KEYLESS-GO key has been detected inside the vehicle during locking. ► Remove the KEYLESS-GO key from the vehicle.
 Pull starting button out then insert key	The KEYLESS-GO key is not continually detected. ► Insert the key into the ignition lock and turn it to the desired position. ► Visit a qualified specialist workshop.

Warning and indicator lamps in the instrument cluster





Safety



Seat belts







Problem	Possible causes/consequences and ► Solutions
 Only for certain countries: the red seat belt warning lamp lights up for six seconds after the engine starts.	The seat belt warning lamp reminds the driver and front passenger to fasten their seat belts. ► Fasten your seat belt (▷ page 48).
 Only for certain countries: the red seat belt warning lamp lights up after the engine starts. In addition, a warning tone sounds for up to six seconds.	The driver's seat belt is not fastened. ► Fasten your seat belt (▷ page 48). The warning tone ceases.
 The red seat belt warning lamp lights up after the engine starts, as soon as the driver's or the front-passenger door is closed.	The driver or front passenger has not fastened their seat belt. ► Fasten your seat belt (▷ page 48). The warning lamp goes out. There are objects on the front-passenger seat. ► Remove the objects from the front-passenger seat and stow them in a secure place. The warning lamp goes out.





Problem	Possible causes/consequences and ► Solutions
 <p>The red seat belt warning lamp flashes and an intermittent audible warning sounds.</p>	<p>The driver or front passenger has not fastened their seat belt. At the same time, you are driving faster than 25 km/h or have briefly driven faster than 25 km/h.</p> <ul style="list-style-type: none"> ► Fasten your seat belt (► page 48). The warning lamp goes out and the intermittent warning tone ceases. <p>There are objects on the front-passenger seat. At the same time, you are driving faster than 25 km/h or have briefly driven faster than 25 km/h.</p> <ul style="list-style-type: none"> ► Remove the objects from the front-passenger seat and stow them in a secure place. The warning lamp goes out and the intermittent warning tone ceases.





Safety systems



Problem	Possible causes/consequences and ► Solutions
 <p>The red brake system warning lamp comes on while the engine is running. A warning tone also sounds.</p>	<p>There is insufficient brake fluid in the fluid reservoir.</p> <p> WARNING</p> <p>The braking efficiency may be impaired. There is a risk of an accident.</p> <ul style="list-style-type: none"> ► Pull over and stop the vehicle safely as soon as possible, paying attention to road and traffic conditions. Do not continue driving under any circumstances. ► Secure the vehicle against rolling away (► page 158). ► Do not top up the brake fluid. Topping up will not rectify the fault. ► Consult a qualified specialist workshop. ► Observe the additional display messages in the multifunction display.
 <p>The yellow ABS warning lamp is lit while the engine is running.</p>	<p>ABS (Anti-lock Brake System) has been deactivated due to a fault. ESP® (Electronic Stability Program), BAS (Brake Assist), PRE-SAFE®, hill start assist, the adaptive brake lights and ESP® trailer stabilisation, for example, are therefore also deactivated.</p> <p> WARNING</p> <p>The brake system continues to function normally, but without the functions listed above. The wheels could therefore lock if you brake hard, for example.</p> <p>The steerability and braking characteristics may be severely affected. The braking distance in an emergency braking situation can increase.</p> <p>If ESP® is not operational, ESP® is unable to stabilise the vehicle. The danger of skidding and having an accident increases.</p> <ul style="list-style-type: none"> ► Observe the additional display messages in the multifunction display. ► Drive on carefully. ► Visit a qualified specialist workshop. <p>If the ABS control unit is faulty, there is also a possibility that other systems, such as the navigation system or the automatic transmission, will not be available.</p>

Problem	Possible causes/consequences and ► Solutions
 <p>The yellow ABS warning lamp is lit while the engine is running.</p>	<p>ABS is temporarily unavailable. BAS, ESP[®], EBD (electronic brake force distribution), PRE-SAFE[®], the adaptive brake lights and ESP[®] trailer stabilisation, for example, are therefore also deactivated.</p> <p>Possible causes:</p> <ul style="list-style-type: none"> • self-diagnosis is not yet complete. • the on-board voltage may be insufficient. <p> WARNING</p> <p>The brake system continues to function normally, but without the functions listed above. The front and rear wheels could therefore lock if you brake hard, for example.</p> <p>The steerability and braking characteristics may be severely affected. The braking distance in an emergency braking situation can increase.</p> <p>If ESP[®] is not operational, ESP[®] is unable to stabilise the vehicle. There is a risk of an accident.</p> <p>► Carefully drive on a suitable stretch of road, making slight steering movements, at a speed above 20 km/h. The functions mentioned above are available again when the warning lamp goes out.</p> <p>If the warning lamp is still on:</p> <ul style="list-style-type: none"> ► Observe the additional display messages in the multifunction display. ► Drive on carefully. ► Visit a qualified specialist workshop.



Problem	Possible causes/consequences and ► Solutions
 <p>The yellow ABS warning lamp is lit while the engine is running. A warning tone also sounds.</p>	<p>EBD is faulty. Therefore, ABS, BAS, PRE-SAFE[®], hill start assist, the adaptive brake lights and ESP[®] trailer stabilisation, for example, are not available either.</p> <p> WARNING</p> <p>The brake system continues to function normally, but without the functions listed above. The front and rear wheels could therefore lock if you brake hard, for example.</p> <p>The steerability and braking characteristics may be severely affected. The braking distance in an emergency braking situation can increase.</p> <p>If ESP[®] is not operational, ESP[®] is unable to stabilise the vehicle. The danger of skidding and having an accident increases.</p> <ul style="list-style-type: none"> ► Observe the additional display messages in the multifunction display. ► Drive on carefully. ► Visit a qualified specialist workshop.
   <p>The red brake warning lamp, the yellow ESP[®] and ESP[®] OFF warning lamps and the yellow ABS warning lamp are lit while the engine is running.</p>	<p>ABS and ESP[®] are malfunctioning. Therefore, BAS, EBD, PRE-SAFE[®], hill start assist, the adaptive brake lights and ESP[®] trailer stabilisation, for example, are not available either.</p> <p> WARNING</p> <p>The brake system continues to function normally, but without the functions listed above. The front and rear wheels could therefore lock if you brake hard, for example.</p> <p>The steerability and braking characteristics may be severely affected. The braking distance in an emergency braking situation can increase.</p> <p>If ESP[®] is not operational, ESP[®] is unable to stabilise the vehicle. The danger of skidding and having an accident increases.</p> <ul style="list-style-type: none"> ► Observe the additional display messages in the multifunction display. ► Drive on carefully. ► Visit a qualified specialist workshop.



Problem	Possible causes/consequences and ► Solutions
 <p>The yellow ESP® warning lamp flashes while the vehicle is in motion.</p>	<p>ESP® or traction control has intervened because there is a risk of skidding or at least one wheel has started to spin. Cruise control or DISTRONIC is deactivated.</p> <ul style="list-style-type: none"> ► Only depress the accelerator pedal as far as necessary when pulling away. ► Accelerate more gently while the vehicle is in motion. ► Adapt your driving style to suit the road and weather conditions. ► Do not deactivate ESP®. <p>For exceptions, see: (▷ page 63).</p>
 <p>The yellow ESP® warning lamp flashes while the vehicle is in motion.</p>	<p>At least one wheel is spinning and the electronic traction system is deactivated. This prevents the brakes on the drive wheels from overheating.</p> <ul style="list-style-type: none"> ► Observe the additional display messages in the multifunction display. <p>The electronic traction system switches back on again as soon as the brakes have cooled down.</p> <p>The display message disappears and the  warning lamp goes out.</p>
 <p>The yellow ESP® OFF warning lamp is lit while the engine is running.</p>	<p>ESP® is deactivated.</p> <p> WARNING</p> <p>If ESP® is switched off, ESP® is unable to stabilise the vehicle. The danger of skidding and having an accident increases.</p> <ul style="list-style-type: none"> ► Reactivate ESP®. <p>For exceptions, see: (▷ page 63).</p> <ul style="list-style-type: none"> ► Adapt your driving style to suit the road and weather conditions. <p>If ESP® cannot be activated:</p> <ul style="list-style-type: none"> ► Have ESP® checked at a qualified specialist workshop.

Problem	Possible causes/consequences and ► Solutions
 <p>The yellow ESP[®] and ESP[®] OFF warning lamps are lit while the engine is running.</p>	<p>ESP[®], BAS, PRE-SAFE[®], hill start assist, the adaptive brake lights and ESP[®] trailer stabilisation are not available due to a malfunction.</p> <p> WARNING</p> <p>The brake system continues to function normally, but without the functions listed above.</p> <p>The braking distance in an emergency braking situation can thus increase.</p> <p>If ESP[®] is not operational, ESP[®] is unable to stabilise the vehicle. The danger of skidding and having an accident increases.</p> <ul style="list-style-type: none"> ► Observe the additional display messages in the multifunction display. ► Drive on carefully. ► Visit a qualified specialist workshop.
 <p>The yellow ESP[®] and ESP[®] OFF warning lamps are lit while the engine is running.</p>	<p>ESP[®], BAS, PRE-SAFE[®], hill start assist and ESP[®] trailer stabilisation are temporarily not available.</p> <p>The adaptive brake lights may also have failed.</p> <p>Self-diagnosis is not yet complete.</p> <p> WARNING</p> <p>The brake system continues to function normally, but without the functions listed above.</p> <p>The braking distance in an emergency braking situation can thus increase.</p> <p>If ESP[®] is not operational, ESP[®] is unable to stabilise the vehicle. The danger of skidding and having an accident increases.</p> <ul style="list-style-type: none"> ► Carefully drive on a suitable stretch of road, making slight steering movements, at a speed above 20 km/h. <p>The functions mentioned above are available again when the warning lamp goes out.</p> <p>If the warning lamp is still on:</p> <ul style="list-style-type: none"> ► Observe the additional display messages in the multifunction display. ► Drive on carefully. ► Visit a qualified specialist workshop.

Problem	Possible causes/consequences and ► Solutions
 <p>The red brake system warning lamp comes on while the vehicle is moving. A warning tone also sounds.</p>	<p>You are driving with the parking brake applied.</p> <ul style="list-style-type: none"> ► Release the parking brake. The warning lamp goes out and the warning tone ceases.
 <p>The red SRS warning lamp is lit while the engine is running.</p>	<p>The restraint systems are malfunctioning.</p> <p> WARNING</p> <p>The airbags or belt tensioners may either be triggered unintentionally or, in the event of an accident, may not be triggered. This poses an increased risk of injury.</p> <ul style="list-style-type: none"> ► Drive on carefully. ► Visit a qualified specialist workshop immediately. <p>Further information on occupant safety (> page 41).</p>

Engine	
Problem	Possible causes/consequences and ► Solutions
 <p>The yellow engine diagnostics warning lamp lights up while the engine is running.</p>	<p>There may be a fault, for example:</p> <ul style="list-style-type: none"> • in the engine management • in the fuel injection system • in the exhaust system • in the ignition system (for vehicles with petrol engines) • in the fuel system <p>The emission limit values may be exceeded and the engine may be running in emergency mode.</p> <p>► Have the vehicle checked as soon as possible at a qualified specialist workshop.</p> <p>Vehicles with a diesel engine: the fuel tank has been run dry (► page 157).</p> <p>► Start the engine three to four times after refuelling. If the yellow engine diagnostics warning lamp goes out, emergency running mode is cancelled. The vehicle need not be checked.</p>
<p>The yellow reserve fuel warning lamp lights up while the engine is running.</p>	<p>The fuel level has dropped into the reserve range.</p> <p>Operation of the auxiliary heating is deactivated when the fuel level drops into the reserve range.</p> <p>► Refuel at the nearest filling station.</p>

Driving systems	
Problem	Possible causes/consequences and ► Solutions
 <p>The red distance warning function warning lamp comes on while the vehicle is moving.</p>	<p>The distance to the vehicle in front is too small for the speed selected.</p> <ul style="list-style-type: none"> ► Increase the distance.
 <p>The red distance warning function warning lamp comes on while the vehicle is moving. A warning tone also sounds.</p>	<p>You are approaching a vehicle or a stationary obstacle in your line of travel at too high a speed.</p> <ul style="list-style-type: none"> ► Be prepared to brake immediately. ► Pay careful attention to the traffic situation. You may have to brake or take evasive action. <p>Further information on DISTRONIC (► page 167). Further information on the distance warning function (► page 65).</p>

Tyres	
Problem	Possible causes/consequences and ► Solutions
 <p>The yellow tyre pressure monitor warning lamp is on.</p>	<p>The tyre pressure monitor has detected a loss of pressure in at least one of the tyres.</p> <p> WARNING</p> <p>With tyre pressures which are too low, there is a risk of the following hazards:</p> <ul style="list-style-type: none"> • they may burst, especially as the load and vehicle speed increase. • they may wear excessively and/or unevenly, which may greatly impair tyre traction. • the driving characteristics, as well as steering and braking, may be greatly impaired. <p>There is a risk of an accident.</p> <ul style="list-style-type: none"> ► Stop the vehicle without making any sudden steering or braking manoeuvres. Pay attention to the traffic conditions as you do so. ► Secure the vehicle against rolling away (▷ page 158). ► Observe the additional display messages in the multifunction display. ► If there is a flat tyre, inspect the tyres (▷ page 295). ► Check the tyre pressure (▷ page 318). ► If necessary, correct the tyre pressure.

Useful information	246
Stowage areas	246
Features	260

Useful information

- i** This Owner's Manual describes all models, series and optional equipment for your vehicle that were available at the time of going to press. National variations are possible. Note that your vehicle may not be equipped with all of the functions described. This is also the case for systems and functions relevant to safety.
- i** Read the information on qualified specialist workshops: (▷ page 23).

Stowage areas

Loading guidelines

WARNING

Secure and position the load as described in the loading guidelines.

Otherwise, vehicle occupants could be injured by the load being thrown around in the event of sharp braking, a sudden change in direction or an accident.

You will find further information in the "Securing a load" section.

Even if you follow all the loading guidelines, the load will increase the risk of injury in the event of an accident.

WARNING

Keep the tailgate closed when the engine is running. Otherwise, you could be poisoned by exhaust fumes entering the vehicle.

The handling characteristics of a laden vehicle are dependent on the distribution of the load within the vehicle. For this reason, you should observe the following notes when transporting a load:

- when transporting a load, never exceed the maximum permissible gross vehicle weight

or the permissible axle loads for the vehicle (including occupants).

- position heavy loads as far forwards as possible and as low down in the load compartment as possible.
- the load must not protrude above the upper edge of the seat backrests.
- always place the load against the rear or front seat backrests. Make sure that the seat backrests are securely locked into place.
- hook in the safety net when loading.
- always place the load behind unoccupied seats if possible.
- secure the load with sufficiently strong and wear-resistant lashing material. Pad sharp edges for protection.

- i** Load restraints are available at any qualified specialist workshop, e.g. a Mercedes-Benz Service Centre.

Stowage compartments

Important safety notes

WARNING

The stowage compartments must be closed when items are stored in them. Luggage nets are not designed to secure heavy items of luggage.

You or other vehicle occupants could be injured by objects being thrown around if you:

- brake sharply
- change direction suddenly
- are involved in an accident

Sharp-edged and fragile objects must not be placed in the luggage net.

Glove compartment

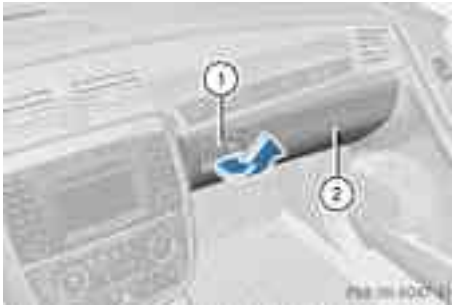

- ▶ **To open:** pull handle ① and open glove compartment flap ②.
- ▶ **To close:** fold glove compartment flap ② upwards until it engages.

i Depending on the vehicle's equipment, you will find an AUX-IN jack or a Media Interface installed in the glove compartment. A Media Interface is a universal interface for portable audio equipment, e.g. for an iPod® or USB device (see the separate Audio or COMAND APS operating instructions).



- ① Glove compartment unlocked
- ② Glove compartment locked

The glove compartment can be locked and unlocked using the emergency key element.

Stowage compartments under the armrest

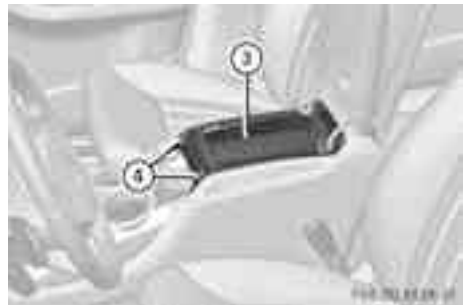

- ① Release button
- ② Release button
- ③ Storage tray/mobile phone bracket
- ④ Coin holder

The stowage compartment and the storage tray/mobile phone bracket can be opened separately.

- ▶ **To open the stowage tray/mobile phone bracket:** press release button ① and fold the armrest upwards.
- ▶ **To open the stowage compartment:** press release button ② and fold the armrest upwards.

i In vehicles with the Rear Seat Entertainment System, a DVD player is installed in the stowage compartment; see the separate operating instructions.

Stowage compartments in the centre console



Front stowage compartment

- Briefly press trim ② in the direction of the arrow.
Cover ① swings upwards.

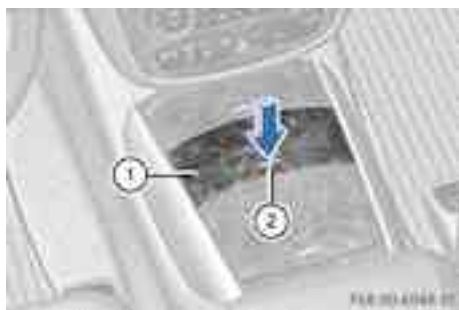

Rear stowage compartment

- Briefly press trim ② in the direction of the arrow.
Cover ① swings upwards.

i In vehicles with the smoker's package, an ashtray is installed instead of the rear stowage compartment (► page 263).

Stowage compartments above the centre air vents, 2nd row of seats



Depending on the equipment in the vehicle, a control panel may be installed instead of the upper stowage compartment, e.g. if the vehicle has rear-compartment air conditioning for the 2nd and 3rd rows of seats.

Stowage compartment in the centre console, 2nd row of seats



- **To open:** press the release button under the armrest and fold the armrest upwards.

Stowage compartments in the 3rd row of seats

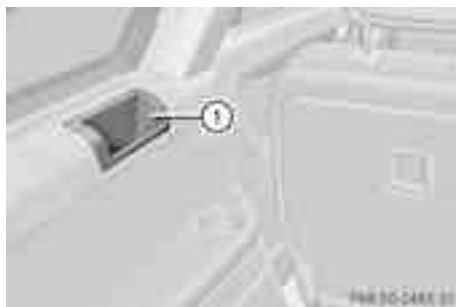

① Stowage compartment

There is a stowage compartment in the side trim on both sides. In vehicles with rear-compartment air conditioning (2nd and 3rd row of seats), a swivelling side air vent is installed instead of the stowage compartment.

Stowage net

⚠ WARNING

Only place lightweight items in the stowage net. Do not use it to transport heavy, bulky, sharp-edged or fragile objects. In the event of an accident, the stowage net will not secure the transported goods sufficiently.

Stowage nets are located in the front-passenger footwell and on the back of the driver's and the front-passenger seat.

Installing or removing the centre console in the 2nd row of seats

Fitting the centre console

⚠ WARNING

The centre console must be correctly anchored on the supporting base. The centre console could otherwise become detached from the supporting base and you and others could be injured by the centre console being thrown around if you:

- brake sharply
- change direction suddenly
- are involved in an accident

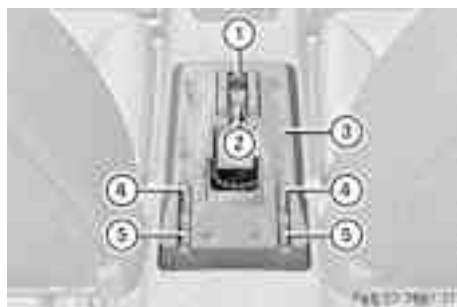

You can fit the centre console in two different positions. In the front position (position 1) on vehicles with a long wheelbase, you can enlarge the luggage compartment fully (▷ page 251) without having to remove the centre console.

- ▶ Position centre console ⑥ above supporting base ③.
- ▶ Mount the retainers of centre console ⑥ using anchoring points ④ (position 1) or ⑤ (position 0) of basic carrier ③.
- ▶ Guide the front part of centre console ⑥ downwards in the direction of the arrow to supporting base ③. Centre console ⑥ must rest on supporting base ③.
- ▶ Push the front part of centre console ⑥ downwards until you hear centre console

⑥ engage in securing rings ① (position 1) or ② (position 0).

i The stowage compartment and cup holder will only be illuminated if the centre console is fitted in the rear position (position 0).

Removing the centre console

⚠ WARNING

Before removing the centre console, take out all containers from the centre console cup holder. Liquids could otherwise spill onto the passengers and / or the vehicle interior. Hot liquids could scald passengers. Liquids spilled on the vehicle interior could damage it.

! To avoid damage to the centre console or its components, close the stowage compartment before removing the centre console.



The centre console contains a stowage compartment (▷ page 248) and a cup holder (▷ page 262).

If you are using the fully extended luggage compartment and want an even loading area (▷ page 251), you must remove the centre console.

- ▶ Pull release handle ⑤.
The front part of centre console ① detaches from supporting base ④.
- ▶ Lift centre console ① upwards in the direction of arrow ⑥ and hold centre console ① in this position.

- ▶ At the same time, reach into recess ②.
- ▶ Lift centre console ① by recess ② upwards in the direction of the arrow to release centre console ① from anchoring points ③.
- ▶ Remove centre console ① from the vehicle.

i Remove all objects from the stowage compartment (▷ page 248) to reduce the weight of the centre console.

i Supporting base ④ cannot be removed.

Enlarging the luggage compartment

Important safety notes

⚠ WARNING

Do not carry heavy or hard objects inside the vehicle or in the luggage compartment unless they are secured.

Otherwise, you and other vehicle occupants could be injured by objects being thrown around the vehicle in the event of sharp braking, a sudden change in direction or an accident.

When using the luggage compartment enlargement feature, you must always fully fold down the respective backrests and attach the safety net.

⚠ WARNING

Always drive with the tailgate closed. Exhaust fumes could otherwise enter the vehicle interior.

To enlarge the luggage compartment, the rear bench seats of the 2nd and 3rd rows of seats can be folded forwards separately. You can enlarge the luggage compartment partially (▷ page 251) or fully (▷ page 251).

Partially enlarging the luggage compartment (folding the seats in the 3rd row forward)

- ▶ Move the head restraint of the corresponding seat down fully (▷ page 96).

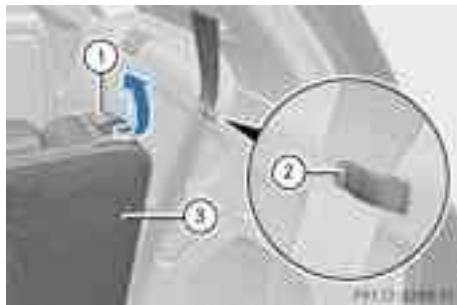

- ▶ Clamp the seat belt behind retainer (2).
- ▶ Pull release handle (1) of backrest (3) upwards in the direction of the arrow. Backrest (3) is released.

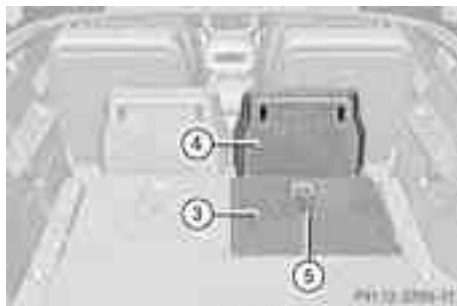

- ▶ Fold backrest (3) down slowly. Seat cushion (4) is released and moves automatically to a vertical position.
- ▶ Fold backrest (3) forwards into a horizontal position.
- ▶ **i** Loop (5) can be used to pull the backrests of the 3rd row of seats upright when the seats are moved into the original position (▷ page 254).

Fully enlarging the luggage compartment (folding the seats in the 2nd and 3rd rows forward)

Important safety notes

⚠ WARNING

Folding down the seats in the 2nd row of seats, in combination with folding the seats in the 3rd row of seats, serves the purpose of fully enlarging the luggage compartment.

Vehicle occupants in the 3rd row of seats must not use the folded-down seats of the 2nd row of seats as a footrest.

Vehicle occupants in the 3rd row of seats must not use the folded-down seats of the 2nd row of seats as a table or stowage space, e.g. for drinks or items of luggage. Otherwise:

- they could suffer serious or fatal head injuries
- they or others could be injured by objects being thrown around:

if you brake suddenly, change direction abruptly or have an accident.

! Make absolutely sure that you adhere to the specified folding order when fully enlarging the luggage compartment:

- fold down the centre seat in the 2nd row of seats (7-seat vehicles).
- fold down the outer seats in the 2nd row of seats.
- fold down the seats in the 3rd row of seats.

You could otherwise damage the seats.

Folding down the centre seat in the 2nd row of seats

! On vehicles with a short wheelbase, the head restraint must be removed before the centre seat is folded down. You could otherwise damage the head restraint or the centre console.

! Close the cup holder before folding down the 2nd row of seats. You could otherwise damage the seats or cup holder.

- ▶ Lower the head restraint on the centre seat in the 2nd row of seats fully (▷ page 96).

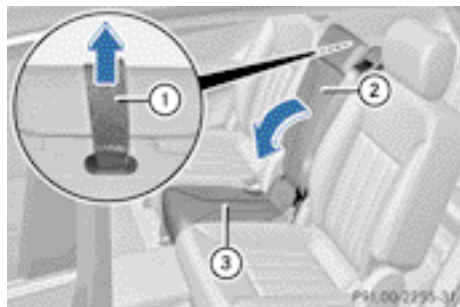

- ▶ Pull release loop ① in the direction of the arrow.
- ▶ Fold backrest ② forwards completely until it is resting on seat cushion ③ (armrest position).



Armrest position

- ▶ Pull release loop ④ in the direction of the arrow and hold it in this position. The seat is released and folds up.
- ▶ Press seat ⑤ further down until the front of the seat engages in the luggage compartment floor position.



Luggage compartment floor position

Folding down the outer seats in the 2nd row of seats

! If you want to fold the outer seats down in the 2nd row of seats, the front seats must not be in the rearmost position. Otherwise, you could damage the front seats and the 2nd row outer seats.

! Close the cup holder before folding down the 2nd row of seats. You could otherwise damage the seats or cup holder.

- ▶ Move the seat concerned in the 2nd row to its rearmost position (▷ page 98).
- ▶ Remove the centre console for the 2nd row of seats, if installed (▷ page 249).

i On vehicles with a long wheelbase, the centre console for the 2nd row of seats can remain in place if it has been installed in the forward position (position 1) (▷ page 249). However, the loading area will not be level. The stowage compartment and cup holder will only be illuminated if the centre console is fitted in the rear position (position 0) (▷ page 249).

i The centre console in the 2nd row of seats can remain installed if it is fitted in the front position (position 1) (▷ page 249). However, the loading area will not be level.

- ▶ Remove the head restraint of the seat concerned (▷ page 96).



- ▶ Place the head restraints on the seat cushion of the corresponding seat.
- ▶ Relieve the pressure on backrest ① and pull release lever ② upwards in the direction of the arrow beyond the pressure point to the stop. Backrest ① and the seat are unlocked.
- ▶ Fold backrest ① forwards until it is resting horizontally on seat cushion .



- ▶ Now push backrest ① down further towards the floor until seat cushion ② engages.

Folding down the seats in the 3rd row of seats

- ▶ Push down the respective head restraints in the 3rd row as far as they will go (▷ page 96).

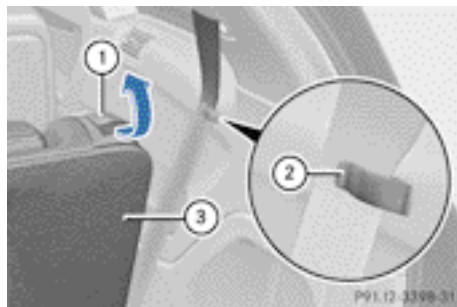

- ▶ Clamp the seat belt behind retainer ②.
- ▶ Pull release handle ① of backrest ③ upwards in the direction of the arrow. Backrest ③ is released.

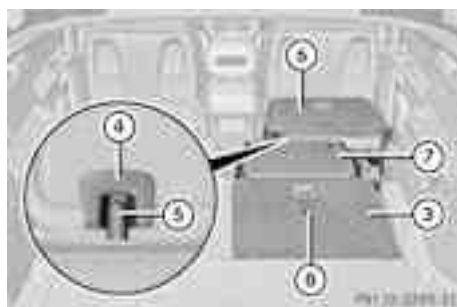

- ▶ Fold backrest ③ down slowly. Seat cushion ⑦ is released and moves automatically to a vertical position.
- ❗ Loop ⑧ can be used to pull the backrests of the 3rd row of seats upright when the seats are moved into the original position (▷ page 254).
- ▶ After it has been moved to a vertical position automatically, fold seat cushion ⑦ further forwards until it reaches a horizontal position. In doing so, make sure that guide pin ⑤ of seat cushion ⑦ catches fully in recess ④ of backrest ⑥.
- ❗ The seats in the 2nd row of seats must be in the rearmost position (▷ page 98).
- ▶ Fold backrest ③ forwards into a horizontal position.

Moving the seats back into the driving position

Important safety notes

WARNING

Ensure that the seats are locked and the backrests are in the upright position before driving.

The outer seats in the 2nd row are only locked if the lock status indicator is folded in and the indicator area is barely visible.

If the backrests are not locked, they could fold forwards during heavy braking, a sudden change of direction or an accident. This means that they cannot provide the intended level of restraint, and could cause additional serious or even fatal injury.

! Make absolutely sure that you reset the seats to the driving position in the specified order:

- reset the seats in the 3rd row of seats.
- reset the outer seats in the 2nd row of seats.
- reset the centre seat in the 2nd row of seats (7-seat vehicles).

Moving the seats in the 3rd row of seats back to the normal position

! Do not fold down the seat cushions before moving the backrests into the upright position. The seat cover could otherwise be damaged.



- ▶ Grip loop ③ and pull seat backrest ② into an upright position.
- ▶ Pull release handle ④ and move backrest ② to the desired position.
- ▶ Place seat cushion ① in a vertical position.
- ▶ Fold seat cushion ① towards backrest ② until it engages audibly.

Moving the outer seats in the 2nd row of seats back to the normal position



- ▶ Pull release lever ② upwards beyond the pressure point to the stop and fold backrest ① upwards by about 45°.
- ▶ Insert the head restraint (▷ page 96).
- ▶ Pull release lever ② to the pressure point and adjust backrest ① to the desired position.
- ▶ Check that the seat is correctly engaged.
- ▶ Set the seat head restraint to the desired position (▷ page 96).

Lock verification indicator for the outer seats in the 2nd row of seats

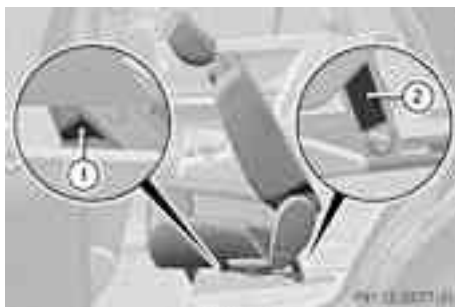

Seat unlocked

When the seat is unlocked, lock status indicator ① is folded out and indicator area ② is clearly visible.

- ▶ When the seat is unlocked, fold the backrest back until you hear the seat engage.

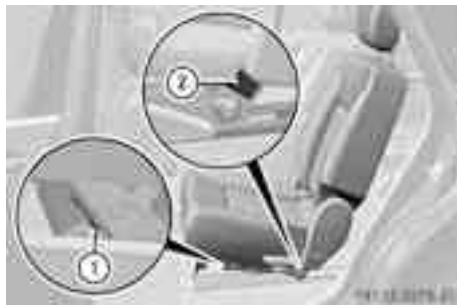

Seat locked

When the seat is locked, lock status indicator ① is folded in and indicator area ② is barely visible.

Resetting the centre seat in the 2nd row of seats



Armrest position

- ▶ Pull release loop ① of seat ② in the direction of the arrow and hold it securely. The seat is released and folds up.
- ▶ Press seat ② further down until the back of the seat engages in the armrest position.
- ▶ Pull release loop ① of the backrest in the direction of the arrow and hold it securely.
- ▶ Fold the backrest backwards until you hear it engage.

Securing a load

Lashing eyelets

General notes

⚠ WARNING

Distribute the load on the lashing eyelets evenly.

Otherwise, vehicle occupants could be injured by objects being thrown around if you:

- brake sharply
- change direction suddenly
- are involved in an accident

Please observe the loading guidelines.

Observe the following notes on securing loads:

- secure the load using the lashing eyelets.
- do not use elastic straps or nets to secure a load, as these are only intended as an anti-slip protection for light loads.
- do not route lashing materials across sharp edges or corners.
- Pad sharp edges for protection.

Footwell of the 2nd row of seats

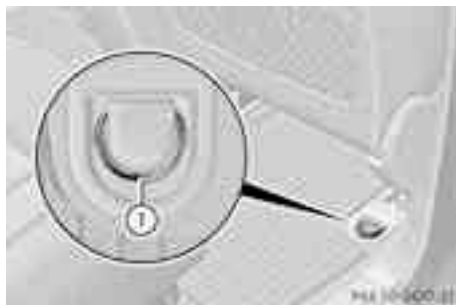

There is one lashing eyelet ① in the footwell behind the driver's seat and one in the footwell behind the front-passenger seat.

Footwell of the 3rd row of seats



Two lashing eyelets ① are located in the footwell for the 3rd row of seats.

Luggage compartment

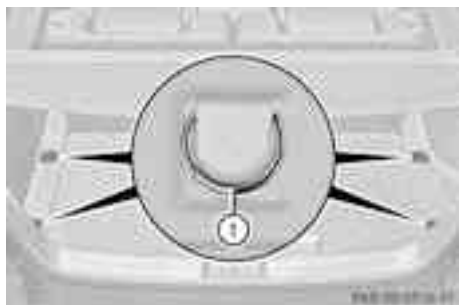

There are four lashing eyelets ① in the luggage compartment.

Securing hooks



There is a mounting hook ① on each of the side panels in the luggage compartment. Only secure lightweight luggage items on the mounting hooks (maximum 4 kg).

Luggage compartment cover

Important safety notes

WARNING

The luggage compartment cover is not a restraint system. Secure the load under the luggage compartment cover by suitable means. Make sure that the luggage compartment cover is engaged securely. If luggage is not sufficiently secured, it can be thrown over the backrest into the passenger compartment, for instance during heavy braking, sudden changes of direction or in the event of an accident. You could cause an accident or cause injury to yourself and others.

- When loading the vehicle, make sure that you do not stack the load in the luggage compartment higher than the lower edge of the side windows. Do not place heavy objects on top of the luggage compartment cover.

The luggage compartment cover may be installed behind the 2nd or 3rd row of seats.

Extending and retracting the luggage compartment cover



Luggage compartment cover fitted behind 3rd row of seats

- ▶ **To extend:** pull the luggage compartment cover back by grab handle ① and clip it into retainers ② on the left and right.
- ▶ **To retract:** unhook the luggage compartment cover from left-hand and right-hand retainers ②.
- ▶ Guide luggage compartment cover forwards by grab handle ① until it is completely rolled up.

i Short wheelbase vehicles:

If the luggage compartment cover is installed behind the 3rd row of seats, it covers the whole of the luggage compartment. It cannot be extended and hooked in.

Fitting/removing the luggage compartment cover

- !** You must not fit the extensions if you wish to fit the luggage compartment cover behind the 3rd row of seats. The luggage compartment cover and side panels in the luggage compartment could otherwise be damaged.



Luggage compartment cover fitted behind 2nd row of seats

- ▶ **To remove:** make sure that luggage compartment cover ② is rolled up.
- ▶ Press button ①.
- ▶ Move luggage compartment cover ② to the left.
- ▶ Remove luggage compartment cover ②.
- ▶ **To fit:** extend luggage compartment cover ② if you wish to install luggage com-

partment cover ② behind the 2nd row of seats (▷ page 258).

- ▶ If fitted, remove the protective caps from the side panels of the 3rd row of seats if you wish to install luggage compartment cover ② behind the 2nd row of seats.



Protective cap in right-hand side panel of 3rd row of seats

- ▶ Push in the bottom of the protective cap as indicated by the arrow. The protective cap folds out at the top.
- ▶ Pull the protective cap up from the side panel in the direction of the arrow.
- i** Stow the protective caps in a safe place.
- ▶ With the handle pointing to the rear and button ① facing upwards, insert luggage compartment cover ② into the recess of the side panel on the left-hand side.
- ▶ Guide luggage compartment cover ② in front of the recess on the right.
- ▶ Press button ① and insert the right-hand side section into the recess of the side panel.
- ▶ Ensure that the luggage compartment cover has engaged properly.

Extending the luggage compartment cover

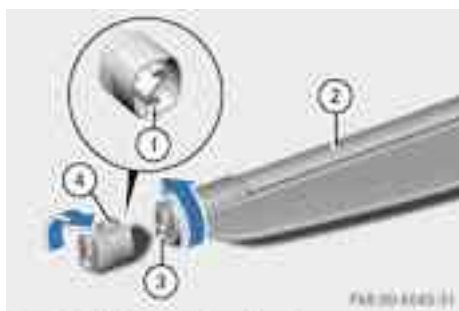

The luggage compartment cover is equipped with two extensions that are fastened securely to the luggage compartment cover with cords.

You must extend the luggage compartment cover if you wish to fit the luggage compartment cover behind the 2nd row of seats.

- ▶ Hold extension ④ in front of luggage compartment cover ② with guide pins ① pointing directly at guides ③.
- ▶ Turn extension ④ and luggage compartment cover ② towards each other in the direction of the arrow. Guide pins ① engage in guides ③.

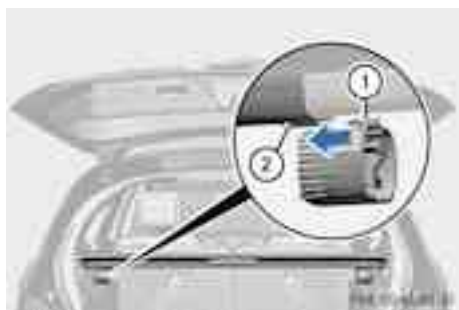

If the extensions are not required, they can be secured to the luggage compartment cover.

- ▶ Slide guide rail ① into guide ② to the stop.

Safety net

Important safety notes

WARNING

You must make sure that the safety net is correctly secured at the top and bottom.

Do not use a damaged safety net.

The safety net cannot restrain heavy loads. For this reason, you should always secure the load.

Otherwise, objects that have not been secured sufficiently might be thrown around if you brake suddenly, change direction suddenly or are involved in an accident, and could cause you an injury.

Preparing the safety net



The safety net can be used in two different positions (behind the B-pillar or the C-pillar).

- ▶ Undo the two Velcro fasteners of the safety-net stowage.
- ▶ Unroll and unfold the safety net. The upper and lower guide rods must engage audibly.
 - The brackets behind B-pillar ① are required for the complete luggage compartment enlargement (▷ page 251). The corresponding lashing eyelets to tighten the net are located in the footwell of the 2nd row of seats (▷ page 255).
 - The brackets behind C-pillar ② are required for the partial luggage compartment enlargement (▷ page 251).

The corresponding lashing eyelets to tighten the net are located in the footwell of the 3rd row of seats (▷ page 255).

Attaching the safety net

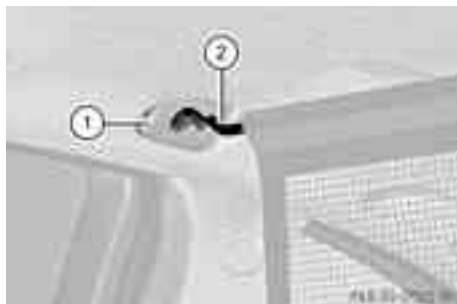

Safety net installed behind the C-pillar

- ▶ Insert guide rod (2) into retainer (1) in the direction of the arrow.
- ▶ Slide guide rod (2) forwards into retainer (1) in the direction of the arrow.

Tightening the safety net

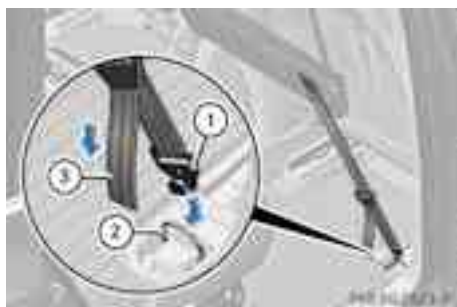

Seat belt reel holder behind the front seats

- ▶ Insert belt hook (1) into lashing eyelet (2) in the direction of the arrow.
- ▶ Pull tensioning strap (3) by the loose end in the direction of the arrow until the safety net is tight.
- ▶ After driving a short distance, check the tension of the safety net and retighten it if necessary.

Releasing the safety net



Seat belt reel holder behind the front seats

- ▶ Pull belt adjuster (1) upwards in the direction of the arrow to reduce the tension on the tensioning strap.
- ▶ Unhook belt hook (2) from lashing eyelet (3).

Detaching and storing the safety net

- ▶ Detach guide rod (2) from bracket (1) (▷ page 259).
- ▶ Press the red button on the upper and lower guide rods.
- ▶ Fold the safety net and roll it up.
- ▶ Close the two Velcro fasteners on the safety net holder.

Roof carrier

Important safety notes

WARNING

An incorrectly secured roof carrier, ski rack or load could become detached from the vehicle. These objects might then be thrown around, and could injure you or others or cause an accident. Follow the roof carrier/ski rack manufacturer's installation instructions and special instructions for use.

The roof load raises the vehicle's centre of gravity, thereby affecting vehicle handling. You must always observe the maximum roof load of 100 kg. Always adapt your driving style

to the prevailing road, traffic and weather conditions and drive with particular care if the roof is laden.

! Mercedes-Benz recommends that you only use roof carriers that have been tested and approved for Mercedes-Benz vehicles. This helps to prevent damage to the vehicle.

Position the load on the roof carrier in such a way that the vehicle will not sustain damage even when it is in motion.

Depending on the vehicle equipment, ensure that when the roof carrier is fitted you can:

- raise the sliding sunroof fully
- open the panorama sliding sunroof fully
- open the tailgate fully

Attaching the roof carrier

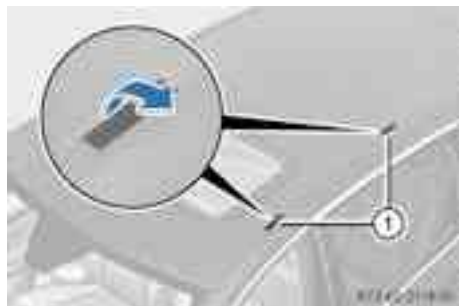

- Fold covers ① upwards.
- Only secure the roof carrier to the anchor points under covers ①. In doing so, observe the manufacturer's installation instructions.

Features

Cup holders

Important safety notes

⚠ WARNING

Keep the cup holder closed while the vehicle is in motion. Otherwise, vehicle occupants could be injured by objects being thrown around if you:

- brake sharply
- change direction suddenly
- are involved in an accident

Only use the cup holders for containers of a suitable size and which have lids. The drinks could otherwise spill.

Cup holders should not be used for hot drinks. You may otherwise scald yourself.

Cup holder in the front centre console



- **To open:** briefly press trim ② in the direction of the arrow. Cover ① swings upwards.



Drink containers placed in the cup holder on the driver's side can be secured so that they are held firmly in the cup holder.

- ▶ **To secure a drink container:** place a drink container in the cup holder on the driver's side.
- ▶ Push release button ④ in the direction of arrow ⑤.
Retainer ③ folds out in the direction of arrow ②.
- ▶ **To release a drink container:** press release button ④ in the direction of arrow ⑤.
- ▶ Slide retainer ③ back into its original position until it engages.
- ▶ **To close:** make sure that there is no drink container in the cup holder.
- ▶ Fold cover ① downwards until it engages.

Cup holder for the second row of seats below the centre air vents

❗ Close the cup holder if you are not using it and before folding down the second row of seats.

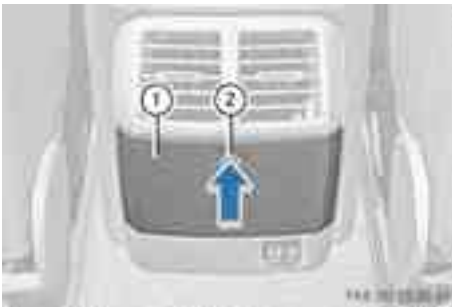

- ▶ **To open the cup holder:** press button ②.
Cover ① opens automatically.



- ▶ Pull cover ① down as far as it will go in the direction of the arrow.

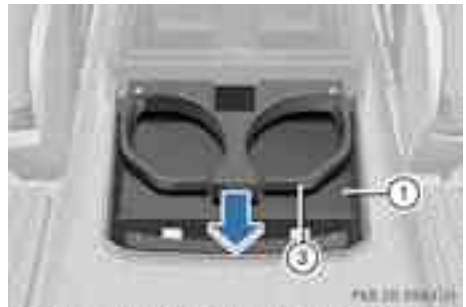

- ▶ Pull cup holder ③ out as far as it will go in the direction of the arrow.
- ▶ **To close the cup holder:** push cup holder ③ forwards into the stowage compartment until it engages.
- ▶ Fold cover ① upwards until it engages in the first position.
- ▶ Swing cover ① forwards until it engages in the second position.

Short wheelbase vehicles with a cup holder in the second row of seats do not have a cup holder below the centre air vents.

Cup holder in front of the armrest of the second row of seats



- ① Cup holders

Cup holder in the third row of seats



- ① Cup holders

The cup holders are located on the right-hand and left-hand side panels.

Sun visors

Overview

WARNING

Keep the vanity mirrors in the sun visors covered while driving. You could otherwise be dazzled, which may impair your view of traffic conditions and as a result could cause an accident.



- ① Mirror light
- ② Bracket
- ③ Vanity mirror
- ④ Retaining clip, e.g. for a car park ticket
- ⑤ Mirror cover

Vanity mirror in the sun visor

Mirror light ① only functions if the sun visor is clipped into retainer ② and mirror cover ⑤ has been folded up.

Glare from the side

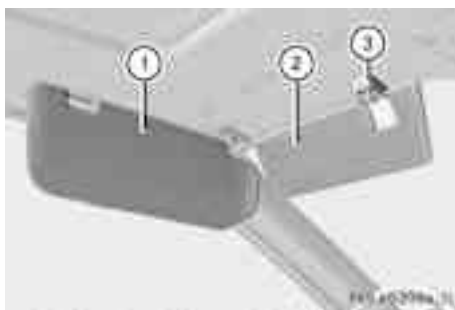

- ▶ Fold down sun visor ①.
- ▶ Pull sun visor ① out of retainer ③.
- ▶ Swing sun visor ① to the side.
- ▶ **Vehicles with a sliding sunroof:** fold down additional sun visor ② to the wind-screen.

Sunblinds on the rear side windows

! Always guide the roller sunblind by hand. Do not let it snap back suddenly as this would damage the automatic roller mechanism.

! Do not drive the vehicle with the roller sunblind hooked in and the side windows opened simultaneously. The roller sunblind can jump out of the retainers and spring back suddenly when driving at high speeds, e.g. when driving on the motorway. This could damage the inertia reel. Therefore, either close the side window or retract the roller sunblind before driving at high speeds.

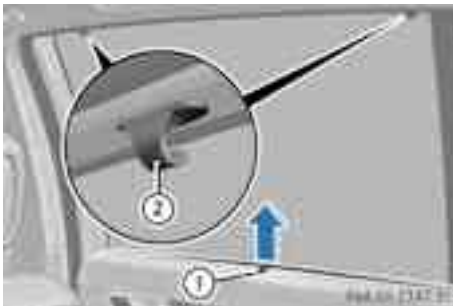

► **To extend:** pull the roller sunblind out by tab ① and hook it onto retainers ② at the top of the window.

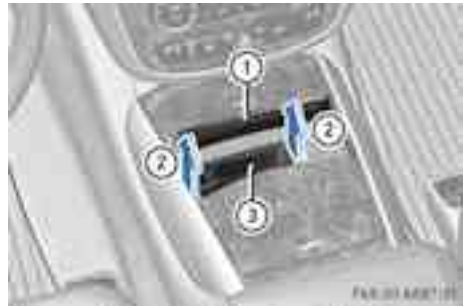

- **To open:** open cover ① (► page 248).
- **To remove the insert:** reach into the recess on the rear of insert ③.
- Lift insert ③ up ② and out.
- **To refit the insert:** press insert ③ into the opening from above and press down until it engages.

i You can remove the ashtray insert and use the resulting compartment for storage.

Ashtray in the second row of seats



- ① Cover
- ② Insert

- **To open:** open cover ① (► page 248).
- Fold cover ① down in the direction of the arrow as far as it will go.

Ashtray

Front ashtray

! The storage space under the ashtray is not heat resistant. Before placing lit cigarettes in the ashtray, make sure that the ashtray is properly engaged. Otherwise, the storage space could be damaged.



- ▶ **To remove the insert:** press insert ① in the direction of the arrow.
- ▶ Pull insert ① upwards and remove it.
- ▶ **To refit the insert:** replace insert ① into the opening from above.
- ▶ Push insert ① down until it engages.
- ▶ **To close:** pull cover ② upwards until it engages in the first position.
- ▶ Swing cover ② forwards until it engages in the second position.

Short wheelbase vehicles with a centre console in the second row of seats do not have an ashtray below the centre console.

Cigarette lighter

WARNING

Only hold the hot cigarette lighter by its knob. Otherwise, you might burn yourself.

Make sure that children travelling in the vehicle are not able to injure themselves on the hot cigarette lighter or cause a fire with it.

- ❗ The cigarette lighter in the centre console in the front compartment is not intended for operating the tyre inflation compressor.

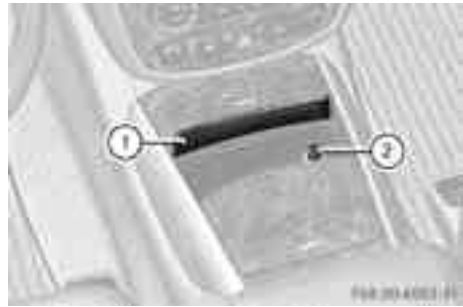

- ▶ Turn the key to position 2 in the ignition lock.
- ▶ **To open:** open cover ① (▷ page 248).
- ▶ Press in cigarette lighter ②. Cigarette lighter ② will pop out automatically when the heating element is red-hot.

12 V sockets

General notes

- ❗ The socket in the centre console and the socket in the luggage compartment are not intended for operating the tyre inflation compressor.

- ▶ Turn the key to position 2 in the ignition lock.

The sockets can be used for accessories with a maximum current draw of 240 W (20 A). Accessories include such items as lamps or chargers for mobile phones.

If you use the sockets for long periods when the engine is switched off, the battery may discharge.

- ❗ You can also use the power sockets when the key is in position 1 in the ignition lock. An emergency cut-off ensures that the on-board voltage does not drop too low. If the on-board voltage is too low, the power to the sockets is automatically cut. This ensures that there is sufficient power to start the engine.

Socket in the front centre console

- ❗ If accessories are connected, make sure that a maximum current draw of 15 A is not exceeded. Otherwise, you will overload the fuse.
- ❗ The socket is not intended for operating the tyre inflation compressor.

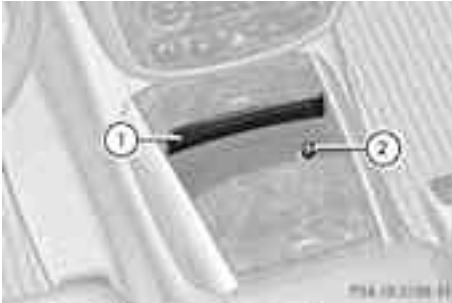

- ▶ **To open:** open cover ① (▶ page 248).
 - ▶ Remove protective cap ② from the socket.
- ❶ On vehicles with an ashtray and a cigarette lighter, a cigarette lighter (▶ page 264) is fitted instead of the socket.

Socket in the second row of seats

- ❗ If accessories are connected, make sure that a maximum current draw of 20 A is not exceeded. Otherwise, you will overload the fuse.



- ▶ Fold up the cover on socket ①.

Socket in the luggage compartment

- ❗ The socket is not intended for operating the tyre inflation compressor.



- ▶ Lift up the cover of socket ①.

Mobile phone

Important safety notes

⚠ WARNING

Observe the legal requirements of the country in which you are currently driving regarding operating mobile communications equipment in a vehicle.

If it is permitted by law to operate communications equipment while the vehicle is in motion, you must only do so if the traffic situation permits. Otherwise, you could be distracted from the traffic conditions, cause an accident and injure yourself and others.

Two-way radios and fax equipment used without low-reflection exterior aerials can interfere with the vehicle's electronics and thereby jeopardise the operating safety of the vehicle and your safety. Therefore, you must only use this equipment if it is correctly connected to a separate reflection-free exterior aerial.

⚠ WARNING

Excessive levels of electromagnetic radiation may cause damage to your health and the health of others. Using an exterior aerial takes into account current scientific discussions

relating to the possible health risk posed by electromagnetic fields.

Mercedes-Benz recommends the use of an approved exterior aerial. This ensures:

- optimal mobile phone reception quality in the vehicle
- mutual influences between the vehicle electronics and mobile phones are minimised

An exterior aerial has the following advantages:

- it conducts the electromagnetic fields generated by a wireless device to the exterior.
- the field strength in the vehicle interior is lower than in a vehicle that does not have an exterior aerial.

i There are various mobile phone brackets that may be fitted in your vehicle; in some cases, these are country-specific.

i You can connect a Bluetooth®-capable mobile phone with Audio 20 or COMAND APS via the Bluetooth® interface. This also applies if your vehicle is equipped with convenience telephony.

More information on suitable mobile phones, mobile phone brackets and on connecting Bluetooth®-capable mobile phones with Audio 20 or COMAND APS can be obtained:

- at your Mercedes-Benz Service Centre
- on the Internet at <http://www.mercedes-benz.com/connect>

i The functions and services available when you use the phone depend on your mobile phone model and service provider.

Using a mobile phone



If the mobile phone is inserted in the mobile phone bracket, you can speak to the person you are calling using the hands-free system.

- ▶ Open the telephone compartment (▷ page 247).
- ▶ Place the mobile phone bracket into the pre-installed fitting (see the separate installation instructions for the mobile phone fitting).
- ▶ Insert the mobile phone into the mobile phone bracket (see the separate installation instructions for the mobile phone fitting).

i On some mobile phone brackets, you first have to connect the mobile phone via Bluetooth® to the mobile phone bracket (see the separate operating instructions for the mobile phone bracket).

If this is the case, the mobile phone does not have to be inserted into the bracket for you to be able to use the telephone functions. However, the charging function and aerial function are not available.

Operating the mobile phone

You can operate the telephone using the  and  buttons on the multifunction steering wheel. You can operate other mobile phone functions via the on-board computer (▷ page 208).

When you remove the key from the ignition lock, the mobile phone stays switched on. However, you can no longer use the hands-free system.

If you have an active call and would like to take the key out of the ignition lock, first remove the mobile phone from the bracket. Otherwise, the call is ended.

i When using a bracket connected to the mobile phone via Bluetooth®:

If you wish to continue a call in private mode, you will need to perform the necessary steps on the mobile phone. Information can be found in the separate mobile phone operating instructions.

Garage door opener

Important safety notes

The HomeLink® garage door opener integrated in the rear-view mirror allows you to operate up to three different door and gate systems.

i The garage door opener is only available for certain countries. Observe the legal requirements for each individual country.

The HomeLink® garage door opener is compatible with most European garage and gate opener drives. More information on HomeLink® and/or compatible products is available from:

- at a qualified specialised workshop
- the HomeLink® hotline
(0) 08000 466 354 65 (free of charge) or
+49 (0) 6838 907 277 (charges apply)
- on the Internet at:
<http://www.homelink.com>

Programming

Programming buttons

WARNING

Only press the button on the integrated garage door opener if there are no persons or objects present within the sweep of the garage door. Persons could otherwise be injured as the door moves.

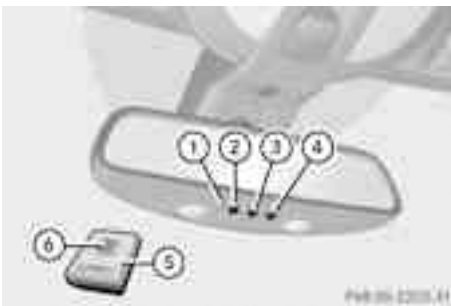

Integrated garage door opener in the rear-view mirror

Garage door remote control ⑤ is not part of the integrated garage door opener.

► Before programming for the first time, clear the memory of the integrated garage door opener (▷ page 269).

► Turn the key to position **2** in the ignition lock.

► Press and hold one of buttons ② to ④ on the integrated garage door opener. After a short time, indicator lamp ① lights up yellow.

i Indicator lamp ① lights up yellow as soon as button ②, ③ or ④ is programmed for the first time. If the selected button has already been programmed, indicator lamp ① will only light up yellow after ten seconds have elapsed.

► Release button ②, ③ or ④. Indicator lamp ① flashes yellow.

► Point garage door remote control ⑤ towards buttons ② to ④ on the rear-view mirror at a distance of 5 to 20 cm.

i The required distance between remote control ⑤ and the integrated garage door opener depends on the garage door drive system. Several attempts may be required. You should test every position for at least 25 seconds before trying another position.

► Press and hold button ⑥ on remote control ⑤ until indicator lamp ① lights up green. If indicator lamp ① lights up green or flashes, then programming has been successful.

► Release button ⑥ of garage door drive remote control ⑤.

► If indicator lamp ① lights up red: repeat the programming procedure for the corresponding button on the rear-view mirror. When doing so, vary the distance between remote control ⑤ and the rear-view mirror.

i If the indicator lamp flashes green after successful programming, the garage door system is using a rolling code. After pro-

gramming, you must synchronise the garage door opener integrated in the rear-view mirror with the receiver of the garage door system.

Synchronising the rolling code

Your vehicle must be within range of the garage door or exterior gate drive. Make sure that neither your vehicle nor any persons/objects are present within the sweep of the door or gate.

Observe the safety notes when performing the rolling code synchronisation.

- ▶ Turn the key to position **2** in the ignition lock.
- ▶ Press the programming button of the door or gate drive (see the door or gate drive operating instructions, e.g. under "Programming of additional remote controls").

i Usually, you now have 30seconds to initiate the next step.

- ▶ Press previously programmed button ②, ③ or ④ of the integrated garage door opener until the door closes. The rolling code synchronisation is then complete.

Problems when programming

If you have problems when programming the integrated garage door opener, please note the following:

- Check the transmitter frequency of garage door drive remote control ⑤. This can usually be found on the back of the remote control.
- Replace the batteries in garage door remote control ⑤. This increases the likelihood that garage door remote control ⑤ will transmit a strong and precise signal to the integrated garage door opener in the rear-view mirror.
- When programming, hold remote control ⑤ at varying distances and angles from the button which you are programming. Try various angles at a distance between 5and

30 cm or at the same angle but at varying distances.

- If there is another remote control for the same garage door drive, perform the programming steps again using this remote control. Before performing these steps, make sure that new batteries have been fitted in garage door drive remote control ⑤.
- Note that some remote controls transmit only for a limited period (the indicator lamp on the remote control goes out). Press button ⑥ on remote control ⑤ again before transmission ends.
- Align the aerial cable of the garage door opener unit. This can improve signal reception/transmission.

Opening or closing the garage door

Once programmed, the integrated garage door opener will assume the function of the garage door system's remote control. Please also read the operating instructions for the garage door system.

- ▶ Turn the key to position **2** in the ignition lock.
- ▶ Press button ②, ③ or ④ which you have programmed to operate the garage door. Garage door system with a fixed code: indicator lamp ① lights up green. Garage door system with a rolling code: indicator lamp ① flashes green.

i The transmitter will transmit a signal for as long as the button is pressed. The transmission is halted after a maximum of ten seconds and indicator lamp ① lights up yellow. Press button ②, ③ or ④ again if necessary.

Clearing the memory

- ▶ Turn the key to position **2** in the ignition lock.
 - ▶ Press buttons **②** and **④**.
The indicator lamp lights up yellow.
 - ▶ Press and hold buttons **②** and **④** until the indicator lamp turns green.
- i** Make sure that you clear the memory of the integrated garage door opener before selling the vehicle.

Frequencies

Europe

Country	Radio type approval number Frequency range (MHz)
AD (Andorra)	20 July MHz: 27, 30, 40, 433, 868
AT (Austria)	Article 6 of Directive 1999/5/EC R&TTE 18 May 05 MHz: 27, 40, 433, 868
BE (Belgium)	Article 6 of Directive 1999/5/EC R&TTE 18 May 05 MHz: 27, 40, 433, 868
BG (Bulgaria)	Article 6 of Directive 1999/5/EC R&TTE 12 April 07 MHz: 27, 40, 433, 868
CH (Switzerland)	Article 6 of Directive 1999/5/EC R&TTE14357 27 May 05 MHz: 27, 40, 433, 868
CY (Cyprus)	Article 6 of Directive 1999/5/EC R&TTE 5 May 05 MHz: 27, 40, 433, 868

Country	Radio type approval number Frequency range (MHz)
CZ (Czech Republic)	General Licence GL-30/R/2000 Reg. No. 844 13 May 05 MHz: 27, 40, 433
DK (Denmark)	Article 6 of Directive 1999/5/EC R&TTE 20 April 05 MHz: 27, 40, 433, 868
DE (Germany)	Article 6 of Directive 1999/5/EC R&TTE7519301 29 April 05 MHz: 27, 40, 433, 868
EE (Estonia)	Article 6 of Directive 1999/5/EC R&TTE 11 May 05 MHz: 27, 40, 433, 868
ES (Spain)	000438/2005, 000439/2005, 000440/2005 000441/2005, 000445/2005, 000446/2005 000447/2005 MHz: 27, 40, 433, 868
FI (Finland)	Article 6 of Directive 1999/5/EC R&TTE10668 13 May 05 MHz: 27, 40, 433, 868
FR (France)	Article 6 of Directive 1999/5/EC R&TTE10668 13 May 05 27, 30, 40, 433, 868
GI (Gibraltar)	Article 6 of Directive 1999/5/EC R&TTE13 May 05 (UK) MHz: 27, 40, 418, 433, 868

Country	Radio type approval number Frequency range (MHz)
GR (Greece)	Article 6 of Directive 1999/5/EC R&TTE11409/18/4/2005 18 May 05 MHz: 27, 40, 433, 868
HR (Croatia)	SDR 224/06 MHz: 27, 40, 433, 868
HU (Hungary)	Article 6 of Directive 1999/5/EC R&TTE 18 May 05 MHz: 27, 40, 433, 868
IC (Canary Islands)	000438/2005, 000439/2005, 000440/2005, 000441/2005, 000445/2005, 000446/2005, 000447/2005, 3rd June 2005 MHz: 27, 40, 433, 868
IE (Ireland)	Article 6 of Directive 1999/5/EC R&TTE 18 May 05 MHz: 27, 40, 433, 868
IS (Iceland)	Article 6 of Directive 1999/5/EC R&TTE 18 May 05 MHz: 27, 40, 433, 868

Country	Radio type approval number Frequency range (MHz)
IT (Italy)	DGPGSR/II/347487/ FOR/15347 DGPGSR/II/347487/ FOR/15348 DGPGSR/II/347487/ FOR/15350 DGPGSR/II/347487/ FOR/15357 DGPGSR/II/347487/ FOR/15358 DGPGSR/II/347487/ FOR/15359 MHz: 27, 40, 433, 868
LI (Liechtenstein)	Article 6 of Directive 1999/5/EC R&TTE 14357 27 May 05 MHz: 27, 40, 433, 868
LT (Lithuania)	Article 6 of Directive 1999/5/EC R&TTE27.4-1B-1609 6 May 05 MHz: 27, 40, 433, 868
LU (Luxembourg)	Article 6 of Directive 1999/5/EC R&TTE150405/9538 24 May 05 MHz: 27, 40, 433, 868
LV (Latvia)	Article 6 of Directive 1999/5/EC R&TTE 27.4-1B-1609 26 April 06 MHz: 27, 40, 433, 868
MC (Monaco)	Article 6 of Directive 1999/5/EC R&TTE10668 13 May 05 MHz: 27, 40, 433, 868

Country	Radio type approval number Frequency range (MHz)
MT (Malta)	Article 6 of Directive 1999/5/EC R&TTE 18 May 05 MHz: 27, 40, 433, 868
NL (Netherlands)	Article 6 of Directive 1999/5/EC R&TTE 18 May 05 MHz: 27, 40, 433, 868
NO (Norway)	Article 6 of Directive 1999/5/EC R&TTE05/02424-SA644 18 May 05 MHz: 27, 40, 433, 868
PL (Poland)	Article 6 of Directive 1999/5/EC R&TTE 21 April 05 MHz: 27, 40, 433, 868
PT (Portugal)	ANCOM-S08399/05 27, 40, 433, 868
RO (Romania)	Article 6.4 of Directive 1999/5/EC R&TTE MHz: 27, 30, 40, 433, 868
RU (Russian Federation)	POCC DE.MJ05.H00015 13 May 05 MHz: 433
SE (Sweden)	Article 6 of Directive 1999/5/EC R&TTE 18 May 05 MHz: 27, 40, 433, 868
SI (Slovenia)	Article 6 of Directive 1999/5/EC R&TTE 500-1/2005-437 9 May 05 MHz: 27, 40, 433, 868

Country	Radio type approval number Frequency range (MHz)
SK (Slovakia)	Article 6 of Directive 1999/5/EC R&TTE Slovak 206/11/2005 4 May 05 MHz: 27, 40, 433, 868
UK (United Kingdom)	Article 6 of Directive 1999/5/EC R&TTE 18 May 05 MHz: 27, 40, 418, 433, 868

Africa

Country	Radio type approval number Frequency range (MHz)
EG (Egypt)	W-KLE-17/08 Mar. 06 MHz: 27, 30, 40, 418, 433, 868
RE (Réunion)	Article 6 of Directive 1999/5/EC R&TTE 11 July 05 MHz: 27, 40, 433, 868
ZA (South Africa)	11 October 2005 MHz: 27, 40, 433

America

Country	Radio type approval number Frequency range (MHz)
BB (Barbados)	Registration not required MHz: 27, 40, 433, 868
CL (Chile)	38447/F-23 No.3.3634 MHz: 40, 433
GF (French Guyana)	Article 6 of Directive 1999/5/EC R&TTE10668 13 May 05 MHz: 27, 30, 40, 433, 868

Country	Radio type approval number Frequency range (MHz)
GP (Guadeloupe)	Article 6 of Directive 1999/5/EC R&TTE 10668 13 May 05 MHz: 27, 30, 40, 433, 868
MQ (Martinique)	Article 6 of Directive 1999/5/EC R&TTE 11 July 05 MHz: 27, 30, 40, 433, 868
MX (Mexico)	MHz: 280 to 390

Asia

Country	Radio type approval number Frequency range (MHz)
AE (United Arab Emirates)	1623/5/10-2/26/76 MHz: 433
JO (Jordan)	TRC/LPD/2005/23 MHz: 27, 30, 40, 433, 868
KW (Kuwait)	5 October 2005 MHz: 27, 30, 40, 418, 433, 868
LB (Lebanon)	2920/O&M/2006 / 3 July 05 MHz: 27, 40, 433, 868
SA (Saudi Arabia)	11_02_05/5024-5-6 MHz: 418, 433
SY (Syria)	279/4/14 / 05 March 06
TR (Turkey)	National Certification 23 July 07 MHz: 433

Australia

Country	Radio type approval number Frequency range (MHz)
AU (Australia)	28 June MHz: 27, 30, 40, 433, 868
NZ (New Zealand)	20 March 06 MHz: 27, 30, 40, 433

Compass

Introduction

In the **AIRMATIC/Compass** menu (▷ page 199), the compass displays the compass bearing of your direction of travel. You will see **N, NE, E, SE, S, SW, W** or **NW** in the multifunction display.

To obtain an accurate display of your compass bearing, the correct geographical zone must be set. If necessary, the compass must also be calibrated (▷ page 273).

If the compass is not calibrated or is malfunctioning due to external interference, you will see the **Compass - - -** message in the display.

i Large buildings, bridges, power lines or large transmitting masts as well as metallic objects in or on the vehicle may interfere with the compass display.

Setting the compass

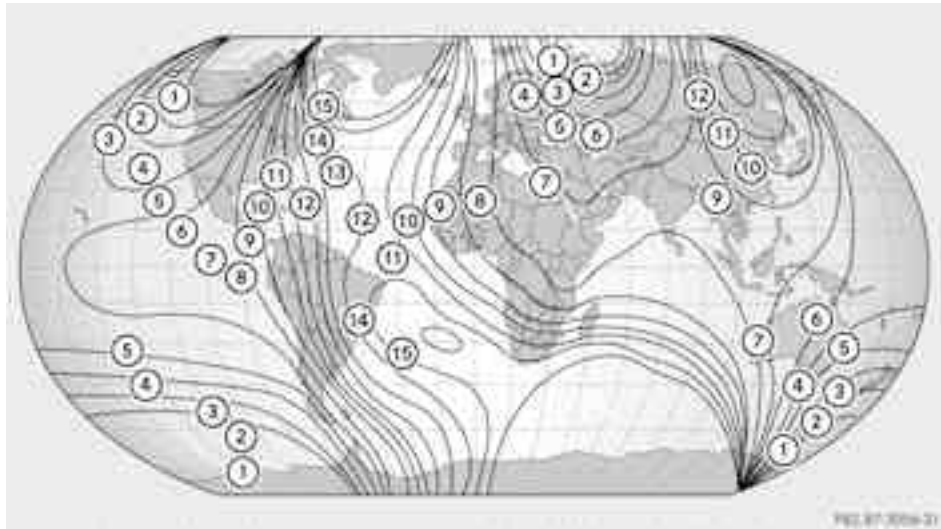

Zone map

- ▶ Use the zone map to determine your geographical location.
- ▶ Use **+** or **-** on the multifunction steering wheel to select the **Vehicle** submenu.
- ▶ Keep pressing **▲** or **▼** until the **Compass setting Zone** message appears. The selection marker highlights the current setting.

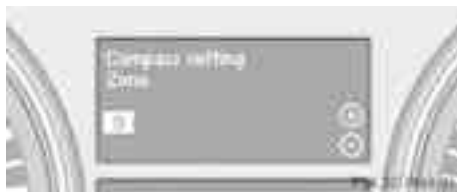

- ▶ Press **+** or **-** to set the geographical location.

Calibrating the compass

- ▶ Start the engine.
 - ▶ Press **+** or **-** on the multifunction steering wheel to select the **Vehicle** submenu.
 - ▶ Keep pressing **▲** or **▼** until the **Compass calibration** message appears. The selection marker highlights **Off**.
- 
- ▶ Use **+** or **-** to select **Start**. You will see the **Compass calibration active** message in the multifunction display.

Please drive a full circle.

- ▶ Drive the vehicle in a full circle at approximately 5 – 10 km/h.
When the calibration is completed, you will see the **Compass calibration Completed successfully** message in the multifunction display.

If you do not see the **Compass calibration Completed successfully** message in the multifunction display, drive another full circle. If the calibration is not successful within three minutes of it starting, the **Compass calibration** message will appear in the multifunction display again. This means that compass calibration is not possible because of external interference. Repeat the calibration at another location.

In order to calibrate the compass correctly, observe the following points:

- find a suitable place where you can drive the vehicle in a full circle.
- calibrate the compass in the open and not in the vicinity of steel constructions or high-voltage transmission lines.
- switch off electrical consumers, e.g. the climate control, windscreen wipers or rear window heating.
- close all doors and the tailgate.

Floormat on the driver's side

WARNING

Make sure that there is sufficient clearance around the pedals when floormats are used, and that the floormats are properly secured. The floormats must be correctly secured at all times using the securing knob and retainers. Before you drive off, check the floormats and secure them if necessary. A floormat which is not properly secured can slip and thereby interfere with the movement of the pedals. Do not place floormats on top of one another.

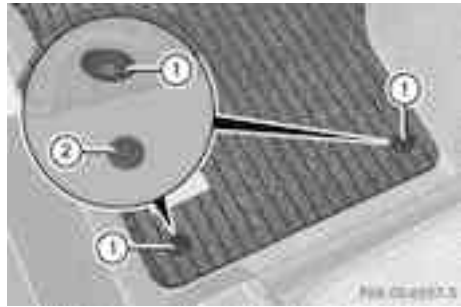

- ▶ Slide the seat backwards.
- ▶ **To fit:** lay the floormat in the footwell.
- ▶ Press studs ① onto retainers ②.
- ▶ **To remove:** pull the floormat from retainers ②.
- ▶ Remove the floormats.

Infrared reflective windscreen



The infrared reflecting glass prevents the vehicle interior from becoming too hot. It also blocks radio waves up into the gigahertz range.

To enable operation of radio-controlled equipment, e.g. toll recording systems, areas on the windscreen are permeable to radio waves ①. In these areas, you can install radio-controlled systems.

These areas can best be seen from outside the vehicle by observing the light reflected off the windscreen.

Retrofitted anti-glare film

Retrofitted anti-glare film on the inside of the windows can interfere with radio/mobile telephone reception. This is particularly the case for conductive or metallic-coated films. You can obtain information about anti-glare film from a qualified specialist workshop.

Useful information	278
Engine compartment	278
Service	282
Care	283

Useful information

- i** This Owner's Manual describes all models, series and optional equipment for your vehicle that were available at the time of going to press. National variations are possible. Note that your vehicle may not be equipped with all of the functions described. This is also the case for systems and functions relevant to safety.
- i** Read the information on qualified specialist workshops: (▷ page 23).

Engine compartment

Bonnet

Opening the bonnet

WARNING

Do not pull the release lever while the vehicle is in motion. If you do so, the bonnet may open up and block your view.

WARNING

There is a risk of injury if the bonnet is open, even if the engine is not running.

Some engine components can become very hot.

To avoid the risk of burns, only touch those components described in the Owner's Manual and observe the relevant safety notes.

WARNING

The radiator fan between the radiator and the engine can start automatically, even if the key has been removed from the ignition lock. For this reason, you must not reach into the fan rotation area. You could otherwise be injured.

Vehicles with a petrol engine: The electronic ignition system uses high voltage. For this reason, you must never touch ignition system components (ignition coil, ignition cables, spark plug connectors or test socket) while:

- the engine is running
- the engine is being started
- the ignition is switched on and the engine is being cranked by hand

You could otherwise suffer an electric shock and be seriously or even fatally injured.

Vehicles with a diesel engine: The electronic injection control uses high voltage. For this reason, you must never touch injection system components while:

- the engine is running
- the engine is being started
- the ignition is switched on

You could otherwise suffer an electric shock and be seriously or even fatally injured.

WARNING

The windscreen wipers and wiper linkage could be set in motion.

When the bonnet is open, you or others could be injured by the wiper linkage.

Make sure that the windscreen wipers are switched off. Remove the key or make sure that no ignition position has been selected with KEYLESS-GO. All indicator lamps must be off in the instrument panel.

- i** Make sure that the windscreen wipers are not folded away from the windscreen. Otherwise, you could damage the windscreen wipers or the bonnet.



- ▶ Make sure that the windscreen wipers are switched off.
- ▶ Pull release lever ① on the bonnet. The bonnet is released.



- ▶ Reach into the gap, pull bonnet catch handle ② up and lift the bonnet. If you lift the bonnet by approximately 40 cm, the bonnet is opened and held open automatically by the gas-filled strut.

Closing the bonnet

WARNING

Make sure that nobody can become trapped as you close the bonnet.

- ▶ Lower the bonnet and let it fall from a height of approximately 20 cm.
- ▶ Check that the bonnet has engaged properly. If the bonnet can be raised slightly, it is not properly engaged. Open it again and close it with a little more force.

Radiator

Vehicles with a diesel engine: do not cover the radiator. Do not use thermal mats, insect protection covers or anything similar. Doing so can cause the Onboard Diagnostics System to display inaccurate values. Some of these values are legally required and must always be correct.

Engine oil

General notes

Depending on your driving style, the vehicle consumes up to 0.8 l of oil per 1,000 km. The oil consumption may be higher than this when the vehicle is new or if you frequently drive at high engine speeds.

Depending on the engine, the oil dipstick may be installed at a different location.

When checking the oil level:

- park the vehicle on a level surface.
- the engine should be switched off for approximately five minutes if the engine is at normal operating temperature.
- if the engine is not at normal operating temperature, e.g. if the engine was only started briefly, wait about 30 minutes before carrying out the measurement.

Checking the oil level using the oil dipstick

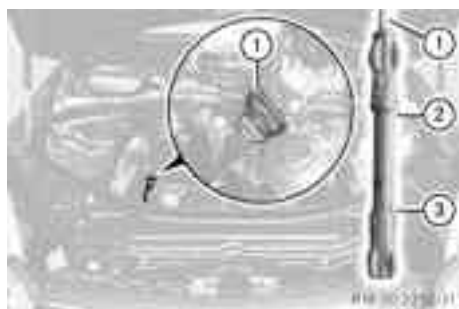

Example: vehicles with a petrol engine



Example: vehicles with a diesel engine

- ▶ Pull oil dipstick ① out of the oil dipstick tube.
- ▶ Wipe off oil dipstick ①.
- ▶ Slowly slide oil dipstick ① into the guide tube to the stop, and take it out again. If the level is between MIN mark ③ and MAX mark ②, the oil level is correct.
- ▶ If the oil level has dropped to MIN mark ③ or below, add 1.0 litre of engine oil.

Adding engine oil

WARNING

If engine oil comes into contact with hot engine parts, it may ignite and you could burn yourself. Do not spill any engine oil on hot engine parts.

Environmental note

When topping up the oil, take care not to spill any. If oil enters the soil or waterways, it is harmful to the environment.

- ❗ Only use engine oils and oil filters that have been approved for vehicles with a service system. You can obtain a list of the engine oils and oil filters tested and approved in accordance with the Mercedes-Benz Specifications for Service Products at any Mercedes-Benz Service Centre.

Damage to the engine or exhaust system is caused by the following:

- using engine oils and oil filters that have not been specifically approved for the service system
- changing the engine oil and oil filter after missing the change interval required by the service system
- using engine oil additives

- ❗ Do not add too much oil. Topping up with too much engine oil can result in damage to the engine or to the catalytic converter. Have excess engine oil siphoned off.



Example: engine oil filler cap

- ▶ Turn cap ① anti-clockwise and remove it.
- ▶ Top up the engine oil.
If the oil level is at or below the MIN mark on the oil dipstick, add 1.0 litre of engine oil.

- ▶ Replace cap ① on the filler neck and turn clockwise.
Make sure that the cap locks securely into place.
- ▶ Check the oil level again with the oil dipstick (▷ page 280).

For further information on engine oil, see (▷ page 343).

Other service products

Checking the coolant level

WARNING

The cooling system is pressurised. Therefore, only unscrew the cap once the engine has cooled down. The coolant temperature display must be less than 70 °C. Otherwise, you could be scalded if hot coolant escapes.

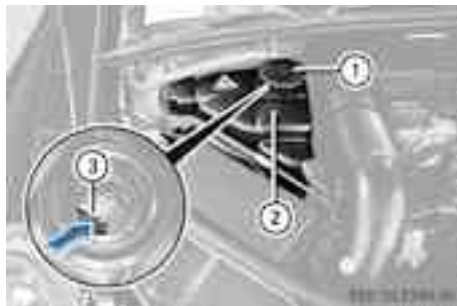

- ▶ Park the vehicle on a level surface.
Only check the coolant level if the vehicle is on a level surface and the engine has cooled down.
- ▶ Turn the key to position **2** in the ignition lock (▷ page 145).
On vehicles with KEYLESS-GO, press the Start/Stop button twice (▷ page 145).
- ▶ Check the coolant temperature gauge in the multifunction display.
The coolant temperature must be below 70 °C.
- ▶ Turn the key to position **0** (▷ page 145) in the ignition lock.

- ▶ Slowly turn cap ① half a turn anti-clockwise to allow excess pressure to escape.
- ▶ Turn cap ① further anti-clockwise and remove it.

If the coolant is at the level of marker bar ③ in the filler neck when cold, there is enough coolant in coolant expansion tank ②.

If the coolant level is approximately 1.5 cm above marker bar ③ in the filler neck when warm, there is enough coolant in coolant expansion tank ②.

- ▶ If necessary, top up with coolant that has been tested and approved by Mercedes-Benz.
- ▶ Replace cap ① and turn it clockwise as far as it will go.

For further information on coolant, see (▷ page 345).

Topping up the windscreen washer system/headlamp cleaning system

WARNING

Windscreen washer fluid/antifreeze is highly flammable. Avoid spilling windscreen washer fluid/antifreeze on hot engine components as it can ignite and burn. Severe burns could be the result.



- ▶ **To open:** pull cap ① upwards by the tab.
- ▶ Top up with the premixed washer fluid.
- ▶ **To close:** press cap ① onto the filler neck until it engages.

The washer fluid reservoir is used for both the windscreen washer system and the headlamp cleaning system.

Further information on windscreen washer fluid/antifreeze (▷ page 345).

Service

ASSYST PLUS

Service messages

The ASSYST PLUS service interval display informs you of the next service due date.

Information on the type of service and service intervals (see separate Service Booklet).

You can obtain further information from a Mercedes-Benz Service Centre.

i The ASSYST PLUS service interval display does not show any information on the engine oil level. Observe the notes on the engine oil level (▷ page 279).

The multifunction display shows a service message for a few seconds, e.g.:

Service A in .. days

Service A due now

Service A exceeded by .. days

The letter indicates how much time the workshop will require to carry out the service work. The letters displayed range from **A** for a short service duration to **H** for a long service duration.

The ASSYST PLUS service interval display does not take into account any periods of time during which the battery is disconnected.

Maintaining the time-dependent service schedule:

▶ Note down the service due date displayed in the multifunction display before disconnecting the battery.

or



▶ After reconnecting the battery, subtract the battery disconnection periods from the service date shown on the display.



Hiding a service message

▶ Press the **R** reset button on the instrument cluster (▷ page 30).

Displaying service messages

▶ Switch the ignition on.

▶ Press  or  to select the **standard display** menu on the steering wheel (▷ page 197).

▶ Press  or  to select the ASSYST PLUS service interval display. The service due date appears in the multifunction display.

Information about Service

Resetting the ASSYST PLUS service interval display

! If the ASSYST PLUS service interval display has been inadvertently reset, this setting can be corrected at a qualified specialist workshop.

Have service work carried out as described in the Service Booklet. This may otherwise lead to increased wear and damage to the major assemblies or the vehicle.

A qualified specialist workshop, e.g. a Mercedes-Benz Service Centre, will reset the ASSYST PLUS service interval display after the service work has been carried out. You can also obtain further information on maintenance work, for example.

Special service requirements

Arduous operating conditions or increased loads on the vehicle will require some service work to be performed more often than for a vehicle in normal use. Such arduous conditions include regular city driving with frequent intermediate stops and use in mountainous terrain or on poor road surfaces.

For example, if the vehicle is used under arduous operating conditions, have air filters, engine oil and oil filters changed frequently and check the wheels often. Further information can be obtained at a qualified specialist workshop, e.g. a Mercedes-Benz Service Centre.

Driving abroad

An extensive Mercedes-Benz Service network is also available in other countries. The Service Hotline's current telephone numbers for use when you are abroad are to be found in the "Mercedes-Benz Service24h" section of the Service Booklet.

AdBlue® service display

i For BlueTEC vehicles only.

To function properly, BlueTEC exhaust gas aftertreatment must be operated with the reducing agent AdBlue®. AdBlue® is topped up as part of the service. Under normal operating conditions, a full tank of AdBlue® should last until the next service due date.

Depending on how and where the vehicle is used, there may be an increase in the AdBlue® consumption. If the AdBlue® supply does not last until the next service, it will be necessary to top it up sooner.

Certain display messages show that AdBlue® must be topped up, e.g.

Refill AdBlue at workshop see Owner's Manual

Refill AdBlue at workshop No start in: .. km

A warning tone also sounds.

You can no longer start the engine when the AdBlue® supply has been used up (▷ page 220).

! Have the AdBlue® tank topped up at a qualified specialist workshop only. The vehicle may otherwise be damaged or soiled.

Before taking a trip with your vehicle outside Europe, have the AdBlue® supply checked at a qualified specialist workshop. If necessary, have AdBlue® topped up. Before a longer stay outside of Europe, consult a qualified specialist workshop.

Observe the notes on AdBlue® (▷ page 342).

You can obtain further information about BlueTEC exhaust gas aftertreatment and AdBlue® from any Mercedes-Benz Service Centre.

Care

General notes

⌚ Environmental note

Dispose of empty packaging and cleaning cloths in an environmentally responsible manner.

! For cleaning your vehicle, do not use any of the following:

- dry, rough or hard cloths
- abrasive cleaning agents
- solvents
- cleaning agents containing solvents

Do not scrub.

Do not touch the surfaces or protective films with hard objects, e.g. a ring or ice scraper. You could otherwise scratch or damage the surfaces and protective film.

! Do not park up the vehicle for an extended period straight after cleaning it, particularly after having cleaned the wheels with wheel cleaner. Wheel cleaners could cause increased corrosion of the brake discs and

brake pads/linings. For this reason, you should drive for a few minutes after cleaning. Braking heats the brake discs and the brake pads/linings, thus drying them. The vehicle can then be parked up.

Regular care of your vehicle is a condition for retaining the quality in the long term.

Use care products and cleaning agents recommended and approved by Mercedes-Benz.

Washing the vehicle and cleaning the paintwork

Automatic car wash

WARNING

Braking efficiency is reduced after washing the vehicle. This could cause an accident. For this reason, following a car wash, drive with particular care until the brakes are dry.

Make sure that:

- the side windows and sliding sunroof are closed completely.
- the blower for the ventilation/heating is switched off (OFF button is depressed).
- the windscreen wiper switch is at position **0**.

The vehicle could otherwise be damaged.

In car washes with a towing mechanism, make sure that the automatic transmission is in transmission position **N**, otherwise the vehicle could be damaged.

- Vehicles with a key:
 - do not remove the key from the ignition lock. Do not open the driver's door or front-passenger door when the engine is switched off. Otherwise, the automatic transmission selects park position **P** automatically and locks the wheels. You can prevent this by shifting the automatic transmission to **N** beforehand.
- Vehicles with KEYLESS-GO:
 - do not open the driver's door or front-passenger door when the engine is

switched off. Otherwise, the automatic transmission selects park position **P** automatically and locks the wheels.

Observe the following to make sure that the automatic transmission stays in position **N**:

- ▶ Make sure the vehicle is stationary and the ignition is switched off.
- ▶ Turn the key to position **2** (> page 145) in the ignition lock.
 - Use the key instead of the Start/Stop button on vehicles with KEYLESS-GO.
- ▶ Depress and hold the brake pedal.
- ▶ Shift the automatic transmission to position **N**.
 - ▶ Release the brake pedal.
 - ▶ Release the parking brake.
 - ▶ Switch off the ignition and leave the key in the ignition lock.

You can wash the vehicle in an automatic car wash from the very start.

Wash off excess dirt before cleaning the vehicle in an automatic car wash.

After using an automatic car wash, wipe off wax from the windscreen and the wiper blades. This will prevent smears and reduce wiping noises caused by residue on the windscreen.

Washing by hand

In some countries, washing by hand is only allowed at specially equipped washing bays. Observe the legal requirements for each individual country.

- ▶ Do not use hot water and do not wash the vehicle in direct sunlight.
- ▶ Use a soft sponge to clean.
- ▶ Use a mild cleaning agent, such as a car shampoo approved by Mercedes-Benz.
- ▶ Thoroughly hose down the vehicle with a gentle jet of water.
- ▶ Do not point the water jet directly towards the air inlets.

- ▶ Use plenty of water and rinse out the sponge frequently.
- ▶ Rinse the vehicle with clean water and dry thoroughly with a chamois.
- ▶ Do not let the cleaning agent dry on the paintwork.

When using the vehicle in winter, remove all traces of road salt deposits carefully and as soon as possible.

High-pressure cleaning equipment

WARNING

Do not use high-pressure cleaners with circular-jet nozzles (dirt grinders) to clean your vehicle, in particular the tyres. You could otherwise damage the tyres and cause an accident.

- ❗ Always maintain a distance of at least 30 cm between the vehicle and the high-pressure cleaner nozzle. Information about the correct distance is available from the equipment manufacturer.

Move the high-pressure cleaner nozzle around when cleaning your vehicle.

Do not aim directly at any of the following:

- tyres
- door gaps, roof gaps, joints etc.
- electrical components
- battery
- connectors
- lights
- seals
- trim elements
- ventilation slots

Damaged seals or electrical components can lead to leaks or failures.

Cleaning the paintwork

- ❗ Do not affix:

- stickers
- films
- magnetic plates or similar items

to painted surfaces. You could otherwise damage the paintwork.

Scratches, corrosive deposits, areas affected by corrosion and damage caused by inadequate care cannot always be completely repaired. In such cases, visit a qualified specialist workshop.

- ▶ Remove impurities immediately, where possible, whilst avoiding rubbing too hard.
- ▶ Soak insect remains with insect remover and rinse off the treated areas afterwards.
- ▶ Soak bird droppings with water and rinse off the treated areas afterwards.
- ▶ Remove coolant, brake fluid, tree resin, oils, fuels and greases by rubbing gently with a cloth soaked in petroleum ether or lighter fluid.
- ▶ Use tar remover to remove tar stains.
- ▶ Use silicone remover to remove wax.

Care and treatment of matt paintwork

- ❗ Never polish the vehicle or the light alloy wheels. Polishing makes the paintwork shiny.

- ❗ The following may cause the paint to become shiny and thus reduce the matt effect:

- Vigorous rubbing with unsuitable materials.
- Frequent use of car washes.
- Washing the vehicle in direct sunlight.

- ❗ Never use paint cleaner, buffing or polishing products, or gloss preserver, e.g. wax. These products are only suitable for high-gloss surfaces. Their use on vehicles with matt finish leads to considerable surface damage (shiny, spotted areas).

Always have paintwork repairs performed at a qualified specialist workshop, e.g. a Mercedes-Benz Service Centre.

- ❗ Do not use wash programs with a hot wax treatment under any circumstances.

Observe these notes if your vehicle has a clear matt finish. This will help you to avoid damage to the paintwork due to incorrect treatment.

These notes also apply to light-alloy wheels with a clear matt finish.

- ❗ The vehicle should preferably be washed by hand using a soft sponge, car shampoo and plenty of water.
- ❗ Use only insect remover and car shampoo from the range of recommended and approved Mercedes-Benz care products.

Cleaning vehicle parts

Cleaning the wheels

- ❗ Do not use acidic wheel cleaning products to remove brake dust. This could damage wheel bolts and brake components.
- ❗ Do not park up the vehicle for an extended period straight after cleaning it, particularly after having cleaned the wheels with wheel cleaner. Wheel cleaners could cause increased corrosion of the brake discs and brake pads/linings. For this reason, you should drive for a few minutes after cleaning. Braking heats the brake discs and the brake pads/linings, thus drying them. The vehicle can then be parked up.

Cleaning the windows

WARNING

Switch off the windscreen wipers and remove the key from the ignition lock before cleaning the windscreen or the wiper blades. On vehicles with KEYLESS-GO, press the Start/Stop button repeatedly until all indicator lamps in the instrument cluster have gone off. The

windscreen wipers could otherwise move and injure you.

- ❗ Do not use dry cloths, abrasive products, solvents or cleaning agents containing solvents to clean the inside of the windows. Do not touch the insides of the windows with hard objects, e.g. an ice scraper or ring. There is otherwise a risk of damaging the windows.
- ❗ Clean the water drainage channels of the windscreen and the rear window at regular intervals. Deposits such as leaves, petals and pollen may under certain circumstances prevent water from draining away. This can lead to corrosion damage and damage to electronic components.
- ▶ Clean the inside and outside of the windows with a damp cloth and a cleaning agent that is recommended and approved by Mercedes-Benz.

Cleaning the wiper blades

WARNING

Switch off the windscreen wipers and remove the key from the ignition lock before cleaning the windscreen or the wiper blades. On vehicles with KEYLESS-GO, press the Start/Stop button repeatedly until all indicator lamps in the instrument cluster have gone off. The windscreen wipers could otherwise move and injure you.

- ❗ Do not pull on the wiper blade. Otherwise, the wiper blade could be damaged.
- ❗ Do not clean wiper blades too often and do not rub them too hard. Otherwise, the graphite coating could be damaged. This could cause wiper noise.
- ❗ Hold the wiper arm securely when folding back. The windscreen could be damaged if the wiper arm hits against it suddenly.

- ▶ Fold the wiper arms away from the windscreen.
- ▶ Clean the wiper blades carefully using a damp cloth.
- ▶ Fold the windscreen wipers back again before switching on the ignition.

Cleaning the exterior lighting

- ❗ Only use cleaning agents or cleaning cloths that are suitable for plastic lenses. Unsuitable cleaning agents or cleaning cloths could scratch or damage the plastic lenses of the exterior lighting.
- ▶ Clean the plastic lenses of the exterior lighting using a wet sponge and a mild cleaning agent, e.g. Mercedes-Benz car shampoo or cleaning cloths.

Mirror turn signal

- ❗ Only use cleaning agents or cleaning cloths that are suitable for plastic lenses. Unsuitable cleaning agents or cleaning cloths could scratch or damage the plastic lenses of the mirror turn signals.
- ▶ Clean the plastic lenses of the mirror turn signals in the exterior mirror housing using a wet sponge and mild cleaning agent, e.g. Mercedes-Benz car shampoo or cleaning cloths.

Cleaning the sensors

- ❗ If you clean the sensors with a high-pressure cleaner, make sure that you keep a distance of at least 30 cm between the vehicle and the high-pressure cleaner nozzle. Information about the correct distance is available from the equipment manufacturer.



- ▶ Clean sensors ① of the driving systems with water, car shampoo and a soft cloth.

Cleaning the exhaust pipe

- ❗ Do not clean the exhaust pipe with alkali-based cleaning agents, such as wheel cleaner.

Impurities combined with the effects of road grit and corrosive environmental factors may cause flash rust to form on the surface. You can restore the original shine of the exhaust pipe by cleaning it regularly, especially in winter and after washing.

- ▶ Clean the exhaust pipe with a chrome care product tested and approved by Mercedes-Benz.

Cleaning the trailer tow hitch

🌿 Environmental note

Dispose of oily and greasy cloths in an environmentally-responsible manner.

- ❗ Do not clean the ball coupling with a high-pressure cleaner. Do not use solvents.
- ❗ Observe the note on care provided by the trailer manufacturer.

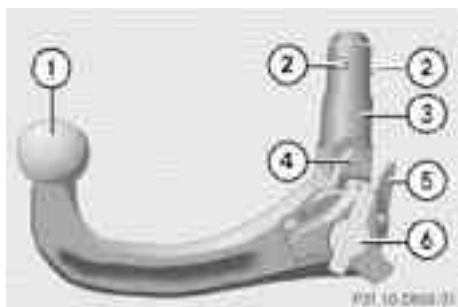

- ① Ball coupling
- ② Locking balls
- ③ Guide pin
- ④ Guide faces
- ⑤ Release lever
- ⑥ Protective cap

The ball coupling must be cleaned if it becomes dirty or corroded.

- ▶ Remove rust, e.g. with a wire brush.
- ▶ Remove dirt with a clean, lint-free cloth or a brush.
- ▶ Lightly oil or grease positions ① to ⑥ and the ball coupling recess of the vehicle after cleaning.
- ▶ Treat the lock under protective cap ⑥ with an acid-free and resin-free oil.
- ▶ Check that the vehicle's trailer tow hitch is working properly.

i You can also have the maintenance work on the ball coupling and the trailer tow hitch carried out by a qualified specialist workshop.

Interior care

Cleaning the display

! For cleaning, do not use any of the following:

- alcohol-based thinner or petrol
- abrasive cleaning agents
- commercially-available household cleaning agents

These may damage the display surface. Do not put pressure on the display surface when cleaning. This could lead to irreparable damage to the display.

- ▶ Before cleaning the display, make sure that it is switched off and has cooled down.
- ▶ Clean the display surface using a commercially available microfibre cloth and TFT/LCD display cleaner.
- ▶ Dry the display surface using a dry microfibre cloth.

Cleaning the plastic trim

! WARNING

When cleaning the steering wheel boss and dashboard, do not use cockpit sprays or cleaning agents containing solvents. Cleaning agents containing solvents cause the surface to become porous, and as a result plastic parts may break away and be thrown around the interior when an airbag is deployed, which may result in severe injuries.

! Do not affix the following to plastic surfaces:

- stickers
- films
- scented oil bottles or similar items

You could otherwise damage the plastic.

! Do not allow cosmetics, insect repellent or sunscreen to come in contact with the plastic trim. This maintains the high-quality look of the surfaces.

- ▶ Wipe the plastic trim with a damp, lint-free cloth, e.g. a microfibre cloth.
- ▶ **Heavy soiling:** use car care and cleaning products recommended and approved by Mercedes-Benz. The surface may change colour temporarily. Wait until the surface is dry again.

Cleaning the steering wheel and gear or selector lever

- ▶ Thoroughly wipe with a damp cloth or use leather care agents that have been recommended and approved by Mercedes-Benz.

Cleaning wooden trim and trim elements

- ❗ Do not use solvent-based cleaning agents such as tar remover, wheel cleaners, polishes or waxes. There is otherwise a risk of damaging the surface.
- ▶ Wipe the wooden trim and trim elements with a damp, lint-free cloth, e.g. a microfibre cloth.
- ▶ **Heavy soiling:** use car care and cleaning products recommended and approved by Mercedes-Benz.

Cleaning the seat covers

- ❗ Observe the following when cleaning:
 - clean genuine leather covers carefully with a damp cloth and then wipe the covers down with a dry cloth. Make sure that the leather does not become soaked. It may otherwise become rough and cracked. Only use leather care agents that have been tested and approved by Mercedes-Benz. You can obtain these from a qualified specialist workshop.
 - clean artificial leather covers with a cloth moistened with a solution containing 1 % detergent (e.g. washing-up liquid).
 - clean cloth covers with a microfibre cloth moistened with a solution containing 1 % detergent (e.g. washing-up liquid). Rub carefully, and always wipe entire seat sections to avoid leaving visible lines. Leave the seat to dry afterwards. Cleaning results depend on the type of dirt and how long it has been there.
 - clean DINAMICA covers with a damp cloth. Make sure that you wipe entire

seat sections to avoid leaving visible lines.

- ❗ Do not use microfibre cloths to clean genuine leather, artificial leather or DINAMICA covers. If used often, these can damage the cover.
- ❗ Note that regular care is essential to make sure that the appearance and comfort of the covers are retained over time.

Cleaning the seat belts

- ❗ Do not clean the seat belts using chemical cleaning agents. Do not dry the seatbelts at temperatures above 80 °C or by exposing them to direct sunlight.
- ▶ Use clean, lukewarm water and soap solution.

Cleaning the roof lining and carpets

- ▶ **Roof lining:** if it is very dirty, use a soft brush or dry shampoo.
- ▶ **Carpets:** use the carpet and textile cleaning agents recommended and approved by Mercedes-Benz.

Useful information	292
Where will I find...?	292
Flat tyre	295
Battery (vehicle)	301
Jump-starting	304
Towing and tow-starting	306
Electrical fuses	309

Useful information

i This Owner's Manual describes all models, series and optional equipment for your vehicle that were available at the time of going to press. National variations are possible. Note that your vehicle may not be equipped with all of the functions described. This is also the case for systems and functions relevant to safety.

i Read the information on qualified specialist workshops: (▷ page 23).

- ▶ Open the tailgate.
- ▶ Lift the luggage compartment floor up (▷ page 293).
- ▶ **Vehicles with a TIREFIT kit:** remove warning triangle¹² ①.
- ▶ **Vehicles with a collapsible emergency spare wheel:** remove warning triangle ①.

Setting up the warning triangle



- ▶ Fold feet ③ down and out to the side.
- ▶ Pull side reflectors ② upwards to form a triangle and lock them at the top using upper press-stud ①.

Where will I find...?

Warning triangle

Removing the warning triangle



Vehicles with a TIREFIT kit



Example: vehicles with a collapsible emergency spare wheel

Warning triangle ① is located in the stowage well under the luggage compartment floor.

First-aid kit



Example: vehicles with BlueTEC

The first-aid kit can be found under the luggage compartment floor in the vehicle tool kit stowage tray. Depending on the vehicle's equipment, the location of the first-aid kit

¹² In vehicles with BlueTEC, the position of the warning triangle is slightly different from that illustrated.

may differ slightly from that shown in the example illustration.

- ▶ Open the tailgate.
- ▶ Lift the luggage compartment floor up (▷ page 293).
- ▶ Remove first-aid kit ①.
- ① Check the expiry date on the first-aid kit at least once a year. Replace the contents if necessary, and replace any missing items.

Fire extinguisher



- ▶ Pull tab ① upwards.
- ▶ Remove fire extinguisher ②.
- ① Have fire extinguisher ② refilled after each use and checked every one to two years. It may otherwise fail in an emergency. Observe the legal requirements for each individual country.

Vehicle tool kit

General notes

The vehicle tool kit can be found in the storage well under the luggage compartment floor.

- ① Apart from certain country-specific variations, vehicles are not equipped with a tyre-change tool kit. Some tools for changing a wheel are specific to the vehicle. For more

information on which tools are required to perform a wheel change on your vehicle, consult a qualified specialist workshop.

Necessary wheel-changing tools can include, for example:

- Jack
- Wheel chock
- Wheel wrench
- Ratchet ring spanner
- Centring pin

Folding the luggage compartment floor up



- ▶ Press release handle ② in the direction of the arrow.
- ▶ Lift luggage compartment floor ① up by release handle ②.



- ▶ Fold out hook ③ on the underside of the luggage compartment floor.

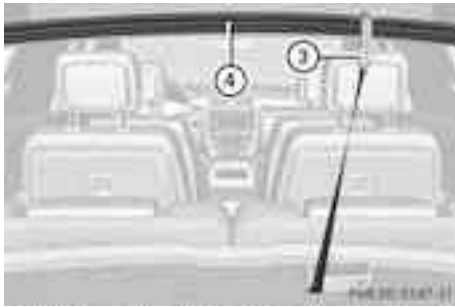

- Attach hook (3) to the luggage compartment's upper seal (4).

Vehicles with a TIREFIT kit

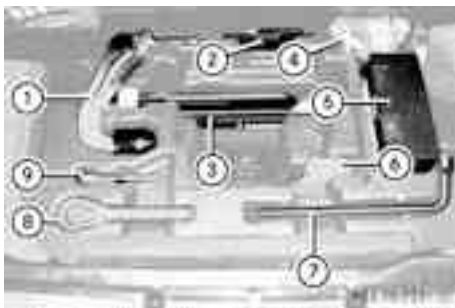

Vehicles without BlueTEC

- ① Ball coupling of the trailer tow hitch
- ② Folding wheel chock
- ③ Jack, ratchet ring spanner
- ④ Tyre sealant filler bottle¹³
- ⑤ Tyre inflation compressor¹³
- ⑥ Fuse allocation chart
- ⑦ Wheel wrench
- ⑧ Towing eye
- ⑨ Centring pin

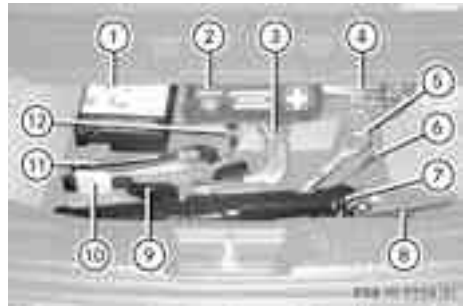

Vehicles with BlueTEC

- ① Tyre inflation compressor
- ② First-aid kit
- ③ Ball coupling of the trailer tow hitch
- ④ Tyre sealant filler bottle
- ⑤ Towing eye
- ⑥ Centring pin
- ⑦ Jack
- ⑧ Warning triangle
- ⑨ Folding wheel chock
- ⑩ Fuse allocation chart
- ⑪ Ratchet ring spanner
- ⑫ Wheel wrench

- Lift the luggage compartment floor up (▷ page 293).

Vehicles with a collapsible emergency spare wheel

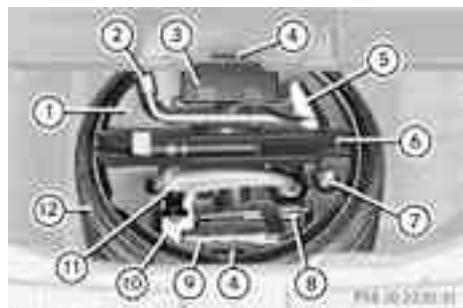

- ① Tool holder
- ② Wheel wrench
- ③ Tyre inflation compressor

¹³ Not for vehicles that have tyres with run-flat characteristics.

- ④ Instructions on the installation position of the vehicle tool kit holder
- ⑤ Fuse allocation chart
- ⑥ Jack, ratchet ring spanner
- ⑦ Centring pin
- ⑧ Folding wheel chock
- ⑨ Towing eye
- ⑩ Wheel bolts
- ⑪ Ball coupling of the trailer tow hitch
- ⑫ Collapsible emergency spare wheel
- ▶ Lift the luggage compartment floor up (▷ page 293).

Flat tyre

Preparing the vehicle

Information on changing/fitting a wheel (▷ page 320).

Vehicle preparation is not necessary on vehicles with MOExtended tyres.

Your vehicle may be equipped with:

- MOExtended tyres (tyres with run-flat characteristics) (▷ page 295)
- a TIREFIT kit (▷ page 296)
- an emergency spare wheel (only for certain countries) (▷ page 328)
- ▶ Stop the vehicle as far away as possible from traffic on solid, non-slippery and level ground.
- ▶ Switch on the hazard warning lamps.
- ▶ Firmly depress the parking brake.
- ▶ Bring the front wheels into the straight-ahead position.
- ▶ Move the DIRECT SELECT lever to **P**.
- ▶ **Vehicles with the AIRMATIC package:** make sure that highway level is selected (▷ page 174).
- ▶ Switch off the engine.
- ▶ **Vehicles without KEYLESS-GO:** remove the key from the ignition lock.

- ▶ **Vehicles with KEYLESS-GO:** open the driver's door.
The on-board electronics have status **0**, which is the same as the key having been removed.
- ▶ **Vehicles with KEYLESS-GO:** remove the Start/Stop button from the ignition lock (▷ page 145).
- ▶ All occupants must get out of the vehicle. Make sure that they are not endangered as they do so.
- ▶ Make sure that no one is near the danger area while a wheel is being changed. Anyone who is not directly assisting in the wheel change should, for example, stand behind the barrier.
- ▶ Get out of the vehicle. Pay attention to traffic conditions when doing so.
- ▶ Close the driver's door.
- ▶ Place the warning triangle a suitable distance away (▷ page 292). Observe legal requirements.

- ❗ Only operate the tyre inflation compressor using the socket in the footwell of the second row of seats (▷ page 265), even if the ignition is turned off.

An emergency cut-off ensures that the on-board voltage does not drop too low. If the on-board voltage is too low, the power to the sockets is automatically cut. This ensures that there is sufficient power to start the engine.

MOExtended tyres (tyres with run-flat characteristics)

WARNING

When driving in emergency mode, the driving characteristics deteriorate, e.g. when cornering, accelerating quickly and when braking. There is a risk of accident.

Do not exceed the stated maximum speed. Avoid abrupt steering and driving manoeuvres, and driving over obstacles (kerbs, pot-

holes, off-road). This applies in particular to a laden vehicle.

Stop driving in emergency mode if:

- you hear banging noises.
- the vehicle starts to shake.
- you see smoke and smell rubber.
- ESP® is intervening constantly.
- there are tears in the sidewalls of the tyre.

After driving in emergency mode, have the wheel rims checked at a qualified specialist workshop with regard to their further use. The faulty tyre must be replaced.

With MOExtended tyres (tyres with run-flat characteristics), you can continue to drive your vehicle even if there is a total loss of pressure in one or more tyres.

MOExtended tyres may only be used in conjunction with an active tyre pressure loss warning system or with an active tyre pressure monitor.

The maximum driving distance is approximately 80 km when the vehicle is partially laden, and approximately 30 km when the vehicle is fully laden.

In addition to the vehicle load, the driving distance possible depends upon:

- speed
- road condition
- outside temperature

The driving distance possible in run-flat mode may be reduced by extreme driving conditions/manoeuvres, or it can be increased through a moderate style of driving.

The maximum permissible distance which can be driven in run-flat mode is counted from the moment the tyre pressure loss warning appears in the multifunction display.

You must not exceed a maximum speed of 80 km/h.

- i** When replacing one or all tyres, make sure that you only use tyres marked "MOExtended". Make sure that you only use the size of tyre specified for the vehicle.

- i** Vehicles with MOExtended tyres are not equipped with a TIREFIT kit at the factory. It is therefore recommended that you additionally equip your vehicle with a TIREFIT kit if you fit tyres that do not feature run-flat characteristics, e.g. winter tyres. A TIREFIT kit can be obtained from a qualified specialist workshop.

TIREFIT kit

Using the TIREFIT kit

TIREFIT is a tyre sealant.

You can use TIREFIT to seal punctures of up to 4 mm, particularly those in the tyre tread. You can use TIREFIT at outside temperatures down to -20 °C.

WARNING

In the following situations, the tyre sealant is unable to provide sufficient breakdown assistance, as it is unable to seal the tyre properly:

- there are cuts or punctures in the tyre larger than those mentioned above.
- the wheel rim is damaged.
- you have driven at very low tyre pressures or on a flat tyre.

There is a risk of accident.

Do not drive any further. Contact a qualified specialist workshop.

WARNING

The tyre sealant is harmful and causes irritation. It must not come into contact with your skin, eyes or clothing or be swallowed. Do not inhale TIREFIT fumes. Keep tyre sealant away from children. There is a risk of injury.

If you come into contact with the tyre sealant, observe the following:

- Rinse off the tyre sealant from your skin immediately with water.
- If the tyre sealant comes into contact with your eyes, immediately rinse them thoroughly with clean water.

- If tyre sealant is swallowed, immediately rinse your mouth out thoroughly and drink plenty of water. Do not induce vomiting, and seek medical attention immediately.
- Immediately change out of clothing which has come into contact with tyre sealant.
- If an allergic reaction occurs, seek medical attention immediately.

! Do not operate the tyre inflation compressor for longer than eight minutes at a time without a break. It may otherwise overheat.

The tyre inflation compressor can be operated again once it has cooled down.

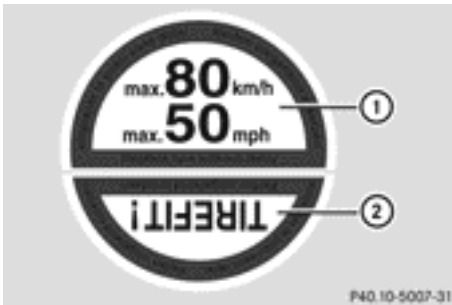

TIREFIT sticker, 2-part

- ▶ Do not remove any foreign objects which have penetrated the tyre, e.g. screws or nails.
 - ▶ Remove the tyre sealant bottle, the accompanying TIREFIT sticker and the tyre inflation compressor from the stowage well underneath the luggage compartment floor (▷ page 293).
 - ▶ Affix part ① of the TIREFIT sticker within the driver's field of vision.
 - ▶ Affix part ② of the TIREFIT sticker near the valve on the wheel with the defective tyre.
- Your vehicle is provided with one of two different tyre inflation compressors:

- **Version 1:** the hose with the pressure gauge and the cable is behind a flap.
- **Version 2:** the pressure gauge is in the tyre inflation compressor.

▶ Insert plug ④ into a 12 V socket of the cigarette lighter in your vehicle.
Observe the notes on sockets (▷ page 264).

▶ Turn the key to position **1** in the ignition lock (▷ page 145).

▶ Press on/off switch ③ on the tyre inflation compressor to **I**.
The tyre inflation compressor is switched on. The tyre is inflated.

i First, tyre sealant is pumped into the tyre. The pressure can briefly rise to approximately 500 kPa (5 bar/73 psi).

Do not switch off the tyre inflation compressor during this phase.

▶ Let the tyre inflation compressor run for five minutes. The tyre should then have attained a pressure of at least 180 kPa (1.8 bar/26 psi).

If a tyre pressure of 180 kPa (1.8 bar/26 psi) has been attained after five minutes: (▷ page 300).

If a tyre pressure of 180 kPa (1.8 bar/26 psi) has not been attained after five minutes: (▷ page 299).

i If the tyre sealant leaks out, allow it to dry. It can then be removed like a layer of film. If you get tyre sealant on your clothing, have it cleaned as soon as possible with perchloroethylene.

TIREFIT kit version 1

! Do not operate the tyre inflation compressor for longer than eight minutes at a time without a break. It may otherwise overheat.

The tyre inflation compressor can be operated again once it has cooled down.



- ▶ Open flap ②.
- ▶ Pull plug ⑤ with the cable and hose ⑥ out of the housing.
- ▶ Screw hose ⑥ onto flange ⑦ of tyre sealant bottle ①.
- ▶ Place tyre sealant bottle ① head downwards into recess ③ of the tyre inflation compressor.



- ▶ Remove the cap from valve ⑨ on the faulty tyre.



- ▶ Make sure pressure release screw ⑩ on pressure gauge ⑪ is fully closed.
- ▶ Screw filler hose ⑧ onto valve ⑨.
- ▶ Insert plug ⑤ into the socket in the footwell of the second row of seats (▷ page 265).
- ▶ Turn the key to position 1 (▷ page 145) in the ignition lock.
- ▶ Press on/off switch ④ on the tyre inflation compressor to I.
The tyre inflation compressor is switched on. The tyre is inflated.

i First, tyre sealant is pumped into the tyre. The pressure can briefly rise to approximately 500 kPa (5 bar/73 psi).

Do not switch off the tyre inflation compressor during this phase.

- ▶ Let the tyre inflation compressor run for five minutes. The tyre should then have attained a pressure of at least 180 kPa (1.8 bar/26 psi).

If a pressure of 180 kPa (1.8 bar/26 psi) has been achieved after five minutes, see (▷ page 300).

If a pressure of 180 kPa (1.8 bar/26 psi) has not been achieved after five minutes, see (▷ page 299).

TIREFIT kit version 2

! Do not operate the tyre inflation compressor for longer than eight minutes at a time without a break. It may otherwise overheat.

The tyre inflation compressor can be operated again once it has cooled down.

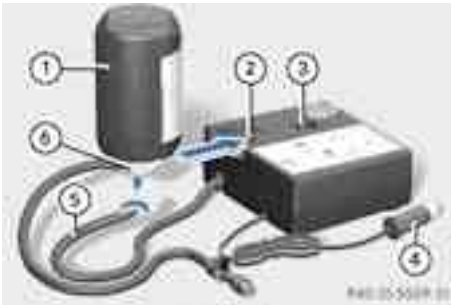

- ▶ Pull plug ④ with the cable and hose ⑤ out of the housing.
- ▶ Screw hose ⑤ onto flange ⑥ of tyre sealant bottle ①.
- ▶ Place tyre sealant bottle ① head downwards into recess ② of the tyre inflation compressor.

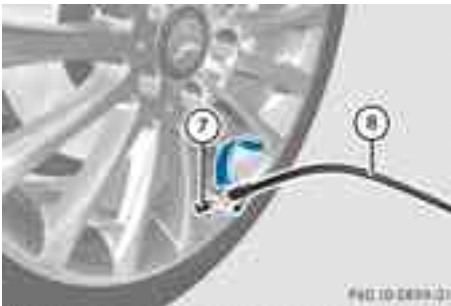

- ▶ Remove the cap from valve ⑦ on the faulty tyre.
- ▶ Screw filler hose ⑧ onto valve ⑦.
- ▶ Insert plug ④ into the socket in the footwell of the second row of seats (▷ page 265).
None of the other sockets or cigarette lighters are designed for operating the tyre inflation compressor.
- ▶ Turn the key to position 1 (▷ page 145) in the ignition lock.
- ▶ Press on/off switch ③ on the tyre inflation compressor to I.
The tyre inflation compressor is switched on. The tyre is inflated.

i First, tyre sealant is pumped into the tyre. The pressure can briefly rise to approximately 500 kPa (5 bar/73 psi).

Do not switch off the tyre inflation compressor during this phase.

- ▶ Let the tyre inflation compressor run for five minutes. The tyre should then have attained a pressure of at least 180 kPa (1.8 bar/26 psi).

If a pressure of 180 kPa (1.8 bar/26 psi) has been achieved after five minutes, see (▷ page 300).

If a pressure of 180 kPa (1.8 bar/26 psi) has not been achieved after five minutes, see (▷ page 299).

Tyre pressure not reached

If a pressure of 180 kPa (1.8 bar/26 psi) has not been achieved after five minutes:

- ▶ Switch off the tyre inflation compressor.
- ▶ Unscrew the filler hose from the valve of the faulty tyre.
- ▶ Very slowly drive forwards or reverse approximately 10 m.
- ▶ Pump up the tyre again.

After a maximum of five minutes the tyre pressure must be at least 180 kPa (1.8 bar/26 psi).

⚠ WARNING

If the required tyre pressure is not reached after the specified time, the tyre is too badly damaged. The tyre sealant cannot repair the tyre in this instance. Damaged tyres and a tyre pressure that is too low can significantly impair the vehicle's braking and driving characteristics. There is a risk of accident.

Do not continue driving. Contact a qualified specialist workshop.

Tyre pressure reached

WARNING

A tyre temporarily sealed with tyre sealant impairs the driving characteristics and is not suitable for higher speeds. There is a risk of accident.

You should therefore adapt your driving style accordingly and drive carefully. Do not exceed the specified maximum speed with a tyre that has been repaired using tyre sealant.

! After use, excess tyre sealant may run out of the filler hose. This could cause stains.

Therefore, place the filler hose in the plastic bag which contained the TIREFIT kit.

Environmental note

Have the used tyre sealant bottle disposed of professionally, e.g. at a qualified specialist workshop.

If a tyre pressure of 180 kPa (1.8 bar/26 psi) has been attained after five minutes:

- ▶ Switch off the tyre inflation compressor.
- ▶ Unscrew the filler hose from the valve of the faulty tyre.
- ▶ Stow the tyre sealant bottle, the tyre inflation compressor and the warning triangle.
- ▶ **Pull away immediately.**

The maximum speed for a tyre sealed with tyre sealant is 80 km/h. The upper part of the TIREFIT sticker must be affixed to the instrument cluster in the driver's field of vision.

- ▶ Stop after driving for approximately ten minutes and check the tyre pressure with the tyre inflation compressor. The tyre pressure must now be at least 130 kPa (1.3 bar/19 psi).

WARNING

If the required tyre pressure is not reached after driving for a short period, the tyre is too badly damaged. The tyre sealant cannot repair the tyre in this instance. Damaged tyres and a tyre pressure that is too low can signif-

icantly impair the vehicle's braking and driving characteristics. There is a risk of accident.

Do not continue driving. Contact a qualified specialist workshop.

- ▶ Correct the tyre pressure if it is still at least 130 kPa (1.3 bar/19 psi) (see the fuel filler flap for values).
- ▶ **To increase the tyre pressure:** switch on the tyre inflation compressor.



TIREFIT kit version 1

- ▶ **To reduce the tyre pressure (version 1):** open pressure release screw (10) on pressure gauge (11).

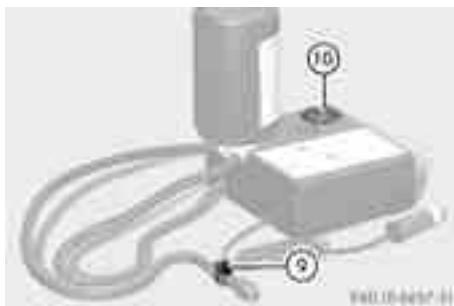

TIREFIT kit version 2

- ⑨ Pressure release button
- ⑩ Pressure gauge

- ▶ **To reduce the tyre pressure (version 2):** press pressure release button (9) on the filler hose.

- ▶ Stow the tyre sealant bottle, the tyre inflation compressor and the warning triangle.
- ▶ Drive to the nearest qualified specialist workshop and have the tyre changed there.
- ▶ Have the tyre sealant bottle replaced as soon as possible at a qualified specialist workshop.
- ▶ Have the tyre sealant bottle replaced every four years at a qualified specialist workshop.

i In your vehicle, you will find a sticker with the Mercedes-Benz Service24h telephone number, e.g. on the B-pillar on the driver's side.

Battery (vehicle)

Important safety notes

Work on the battery, e.g. removing or installing, requires specialist knowledge and the use of special tools. Therefore, always have work on the battery carried out at a qualified specialist workshop.

WARNING

Work carried out incorrectly on the battery can, for example, lead to a short circuit and damage your vehicle's electronic system. This can disrupt driving safety systems such as ABS (anti-lock braking system) or ESP® (Electronic Stability Program).

- If ABS malfunctions, the wheels can lock during braking. This limits the steerability of the vehicle when braking and the braking distance may increase. There is a risk of accident.
- If ESP® malfunctions, the vehicle will not be stabilised if it starts to skid or a wheel starts to spin. There is a risk of accident.

You should therefore have all work involving the battery carried out at a qualified specialist workshop.

WARNING

Comply with safety precautions and take protective measures when handling batteries.



Risk of explosion



Fire, naked flames and smoking are prohibited when handling the battery. Avoid creating sparks.



Battery acid is caustic. Avoid contact with the skin, eyes or clothing.

Wear suitable protective clothing, in particular gloves, an apron and a face mask.

Immediately rinse acid splashes off with clean water. Consult a doctor if necessary.

Wear eye protection.



Keep children away.



Observe this Owner's Manual.



WARNING

For safety reasons, Mercedes-Benz recommends that you only use batteries which have been tested and approved for your vehicle by Mercedes-Benz. These batteries provide increased impact protection to prevent vehicle occupants from suffering acid burns should the battery be damaged in the event of an accident.

To prevent acid burns, observe the following safety notes when handling batteries:

- do not lean over the battery.
- do not place any metal objects on a battery. Otherwise, you could cause a short circuit and the battery's gas mixture could ignite.
- make sure that you do not create an electrostatic charge, e.g. by wearing synthetic clothing or as a result of friction on fabrics. Therefore, you should not pull or slide the battery over carpets or other synthetic materials.
- never touch the battery first. To discharge a possible electrostatic charge, step out of the vehicle first and touch the bodywork.
- do not wipe the battery using a cloth. The battery may explode as a result of electrostatic charge or due to flying sparks.

Environmental note



Batteries contain pollutants. It is illegal to dispose of them with the household rubbish. They must be collected separately and disposed of in an environmentally responsible recycling system.



Dispose of batteries in an environmentally responsible manner. Take discharged batteries to a qualified specialist workshop or to a collection point for used batteries.

- !** Have the battery checked regularly at a qualified specialist workshop.
Observe the service intervals in the Service Booklet or contact a qualified specialist workshop for more information.
- !** You should have all work involving the battery carried out at a qualified specialist workshop. In the exceptional case that it is necessary for you to disconnect the battery yourself, make sure that:
 - you switch off the engine and remove the key. On vehicles with KEYLESS-GO, ensure that the ignition is switched off.

Check that all the indicator lamps in the instrument cluster are off. Otherwise, electronic components, such as the alternator, may be damaged.

- you first remove the negative terminal clamp and then the positive terminal clamp. Never swap the terminal clamps. Otherwise, the vehicle's electronic system may be damaged.
- the transmission is locked in position **P** after disconnecting the battery. The vehicle is secured against rolling away. You can then no longer move the vehicle.

The battery and the cover of the positive terminal clamp must be fitted securely during operation.

In order for the battery to achieve the maximum possible service life, it must always be sufficiently charged.

The vehicle battery, like other batteries, can discharge over time if you do not use the vehicle. In such cases, have the battery disconnected at a qualified specialist workshop. You can also charge the battery with a charger recommended by Mercedes-Benz. For more information, please contact a qualified specialist workshop.

Have the battery charge checked more frequently if you use the vehicle mainly for short trips or if you leave it standing idle for a lengthy period. Consult a qualified specialist workshop if you wish to leave your vehicle parked up for an extended period of time.

- i** When you park the vehicle, remove the key if you do not require any electrical consumers. The vehicle will then use very little energy, thus conserving battery power.
- i** After an interruption of the power supply, e.g. the battery was discharged, you have to:
 - set the clock (▷ page 201)
On vehicles with COMAND Online and a navigation system, the clock is set automatically.
 - reset the sliding sunroof (▷ page 86)

- reset the panorama sliding sunroof (▷ page 88)
 - reset the function for automatically folding the exterior mirrors in/out by folding the mirrors out once (▷ page 106)
 - reset the side windows, see (▷ page 84)
- ▶ Open the bonnet (▷ page 278).
 - ▶ Connect the battery charger to the positive terminal and earth point in the same order as when connecting the donor battery in the jump-starting procedure (▷ page 304).

Charging the battery

WARNING

Only charge the battery in a well-ventilated area. As the battery is being charged, gases can escape and generate minor explosions. This could injure you and other persons or cause damage to the paintwork or acid corrosion on the vehicle.

You can obtain information on battery chargers which allow the battery to be charged while still installed from a qualified specialist workshop.

WARNING

There is a risk of acid burns during the charging process due to the gases which escape from the battery. Do not lean over the battery during the charging process.

WARNING

Battery acid is caustic. Avoid contact with the skin, eyes or clothing.

- !** Only charge the installed battery with a battery charger which has been tested and approved by Mercedes-Benz. These battery chargers allow the battery to be charged while still installed in the vehicle.
- !** Only use battery chargers with a maximum charging voltage of 14.8 V.
- !** Only charge the battery using the jump-start connection point.

The jump-starting connection point is in the engine compartment (▷ page 304).

Read the battery charger's operating instructions before charging the battery.

Jump-starting

 **WARNING**

There is a risk of acid burns when jump-starting a vehicle due to the gases which escape from the battery. Do not lean over the battery while the engine is being jump-started.

 **WARNING**

Gases escaping from the battery during jump-starting may cause minor explosions. Avoid creating sparks. Keep naked flames away from the battery, and do not smoke.

Comply with the important safety precautions when handling batteries. You will find these under "Battery (vehicle) - important safety notes" in the index.

 **WARNING**

Non-combusted fuel can collect in the exhaust system and ignite. There is a risk of fire. Avoid repeated and lengthy starting attempts.

! **Vehicles with a petrol engine:** avoid repeated and lengthy starting attempts. Otherwise, the non-combusted fuel may damage the catalytic converter.

Do not use a rapid charging device to start the vehicle. If your vehicle's battery is discharged, the engine can be jump-started from another vehicle or from a second battery using jump leads. Observe the following points:

- the battery is not accessible in all vehicles. if the other vehicle's battery is not accessible, jump-start the vehicle using a second battery or a jump-starting device.
- **vehicles with a petrol engine:** only jump-start the vehicle when the engine and exhaust system are cold.
- do not start the engine if the battery is frozen. Let the battery thaw first.
- jump-starting may only be performed from batteries with a nominal voltage of 12 V.
- only use jump leads that have a sufficient cross-section and insulated terminal clamps.
- if the battery is fully discharged, leave the battery that is being used to jump-start connected for a few minutes before attempting to start. This charges the empty battery a little.
- make sure that the two vehicles do not touch.

Make sure that:

- the jump leads are not damaged.
- non-insulated parts of the terminal clamps do not come into contact with other metal parts while the jump leads are connected to the battery.
- the jump leads cannot come into contact with parts such as the V-belt pulley or the fan. These parts move when the engine is started and while it is running.
- ▶ Firmly depress the parking brake.
- ▶ Shift the transmission to position **P**.
- ▶ Switch off all electrical consumers (e.g. radio, blower, etc.).
- ▶ Open the bonnet (▷ page 278).

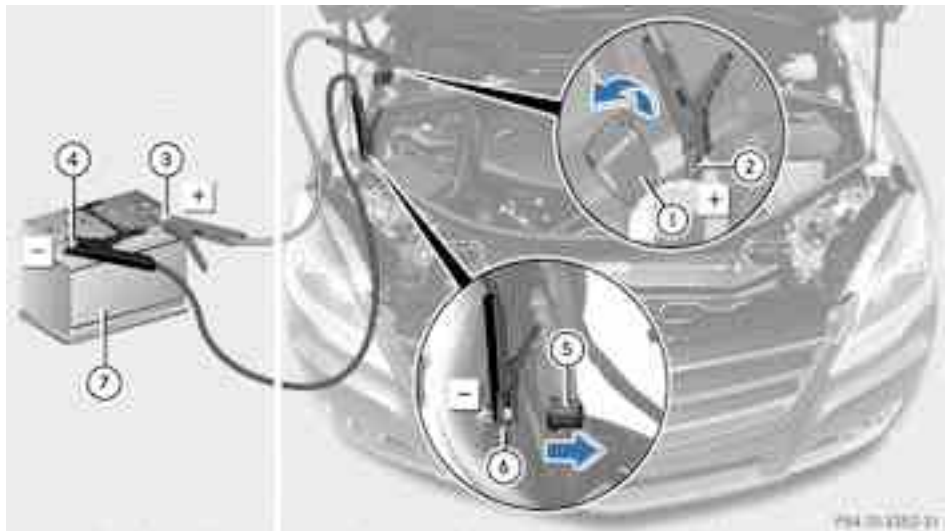

Position number ⑦ identifies the charged battery of the other vehicle or an equivalent jump-starting device.

- ▶ Lift up cover ① of positive terminal ② in the direction of the arrow.
 - ▶ Connect positive terminal ② on your vehicle to positive terminal ③ of donor battery ⑦ using the jump lead. Always begin with positive terminal ② on your own vehicle first.
 - ▶ Start the engine of the donor vehicle and run it at idling speed.
 - ▶ Remove cover ⑤ from earth point ⑥.
 - ▶ Connect negative terminal ④ of donor battery ⑦ to earth point ⑥ of your vehicle using the jump lead, connecting the jump lead to donor battery ⑦ first.
 - ▶ Start the engine.
 - ▶ Before disconnecting the jump leads, let the engines run for several minutes.
 - ▶ First, remove the jump leads from earth point ⑥ and negative terminal ④, then from positive terminal ② and positive terminal ③, each time beginning at the contacts on your own vehicle first.
 - ▶ Have the battery checked at a qualified specialist workshop.
- i** Jump-starting is not considered to be a normal operating condition.
- i** Jump-starting cables and further information regarding jump starting can be obtained at any qualified specialist workshop.

Towing and tow-starting

Important safety notes

WARNING

If you tow the vehicle, you must use a rigid towing bar if:

- the engine is not running.
- there is a brake system malfunction.
- there is a malfunction in the power supply or the vehicle's electrical system.

The power assistance for the steering and the brake force booster do not work when the engine is not running. You will need more force to steer and brake, you may have to depress the brake pedal with maximum force.

Before towing away, make sure that the steering can be moved and is not locked.

If you tow or tow-start another vehicle, its weight must not exceed the maximum permissible gross vehicle weight of your vehicle.

 Only secure the tow rope or towing bar to the towing eyes. The vehicle may otherwise be damaged.

 Observe the following points when towing with a tow rope:

- secure the tow rope on the same side on both vehicles.
- the tow rope must not be longer than is legally permitted. It should be marked in the middle, e.g. with a white cloth (30 x 30 cm) so that other road users are aware that a vehicle is being towed.
- the tow rope may only be attached to the towing eyes.
- observe the brake lamps of the towing vehicle while driving. Always maintain a distance so that the tow rope does not sag.
- do not use steel cables or chains to tow your vehicle. The vehicle could be damaged.

 Do not use the towing eye for recovery, this could damage the vehicle. If in doubt, recover the vehicle with a crane.

 When towing, pull away slowly and smoothly. If the tractive power is too high, the vehicles could be damaged.

 To tow vehicles with KEYLESS-GO, use the key instead of the Start/Stop button. The automatic transmission may otherwise switch to position **P** when you open the driver's or front-passenger door which could damage the transmission.

 You may tow the vehicle for a maximum of 50km. A towing speed of 50 km/h must not be exceeded.

For towing distances over 50 km, the entire vehicle must be lifted up and transported.

 If you tow or tow-start another vehicle, its weight must not exceed the maximum permissible gross vehicle weight of your vehicle.

Information on your vehicle's gross vehicle weight rating can be found on the vehicle identification plate (> page 338).

Observe the legal requirements for the relevant countries when towing.

It is better to have the vehicle transported than to have it towed.

If the vehicle has suffered transmission damage, have it transported on a transporter or trailer.

The automatic transmission must be in position **N** when the vehicle is being towed.

The battery must be connected and charged. Otherwise, you:

- cannot turn the key in the ignition lock to position **2**
- cannot shift the automatic transmission to position **N**

 Deactivate the automatic locking feature (> page 204). You could otherwise be locked out when pushing or towing the vehicle.

Deactivate tow-away protection
(▷ page 67) before the vehicle is towed.

Fitting/removing the towing eye

Fitting the towing eye

WARNING

The exhaust tail pipe may be hot. You could burn yourself if you touch the tail pipe. Be particularly careful when removing the rear cover.

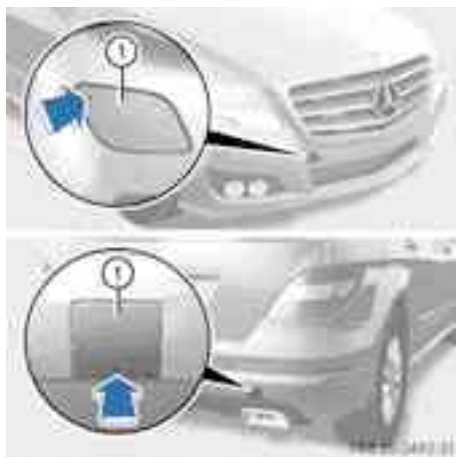

Example: covers for towing eye mountings

Vehicles with a trailer tow hitch: if you intend to use the vehicle for towing, fit the ball coupling (▷ page 186) and connect the towbar to it.

The mountings for the screw-in towing eyes are located in the bumpers. They are at the front and at the rear, under the covers.

- ▶ Remove the towing eye from the vehicle tool kit (▷ page 293).
- ▶ Press the mark on cover ① inwards in the direction of the arrow.
- ▶ Take cover ① off the opening.
- ▶ Screw the towing eye in clockwise to the stop and tighten it.

Removing the towing eye

- ▶ Loosen the towing eye and unscrew it.
- ▶ Position cover ① on the bumper and press it until it engages.
- ▶ Place the towing eye in the vehicle tool kit.

Towing the vehicle with the rear axle raised

 The ignition must be switched off if you are towing the vehicle with the rear axle raised. Intervention by ESP® could otherwise damage the brake system.

Only possible on vehicles without 4MATIC.

- ▶ Switch on the hazard warning lamps (▷ page 114).
- ▶ Turn the key in the ignition lock to position **0** and remove the key from the ignition lock.
- ▶ When leaving the vehicle, take the key or the KEYLESS-GO key with you.

When towing your vehicle with the rear axle raised, it is important that you observe the safety instructions (▷ page 306).

Towing the vehicle with both axles on the ground

WARNING

The power assistance for the steering and the brake force booster do not work when the engine is not running. You will then need much more effort to brake and steer the vehicle. Adapt your style of driving accordingly.

It is important that you observe the safety instructions when towing away your vehicle (▷ page 306).

The automatic transmission automatically shifts to position **P** when you open the driver's or front-passenger door or when you remove the key from the ignition lock.

In order to ensure that the automatic transmission stays in position **N** when towing the vehicle, you must observe the following points:

- ▶ Make sure that the vehicle is stationary and that the key is in position **0** in the ignition lock.
- ▶ Turn the key to position **2** in the ignition lock.

On vehicles with KEYLESS-GO, use the key instead of the Start/Stop button (> page 145).

- ▶ Depress and hold the brake pedal.
- ▶ Shift the automatic transmission to position **N**.
- ▶ Release the brake pedal.
- ▶ Release the parking brake.
- ▶ Leave the key in position **2** in the ignition lock.
- ▶ Switch on the hazard warning lamps (> page 114).

i In order to signal a change of direction when towing the vehicle with the hazard warning lamps switched on, use the combination switch as usual. In this case, only the turn signals for the desired direction flash. When you reset the combination switch, the hazard warning lamps start flashing again.

Transporting the vehicle

! Only lash the vehicle down by the wheels or wheel rims, not by parts of the vehicle such as axle or steering components. Otherwise, the vehicle could be damaged.

The towing eyes or trailer tow hitch can be used to pull the vehicle onto a trailer or transporter if you wish to transport it.

- ▶ Turn the key to position **2** in the ignition lock.
- ▶ Shift the automatic transmission to position **N**.

As soon as the vehicle is loaded:

- ▶ Prevent the vehicle from rolling away by applying the parking brake.
- ▶ Shift the automatic transmission to position **P**.
- ▶ Turn the key to position **0** in the ignition lock and remove it.
- ▶ Secure the vehicle.

Information for 4MATIC vehicles

! Vehicles with 4MATIC must not be towed with the front or rear axle raised; otherwise, the transmission may be damaged.

If the vehicle has transmission damage or damage to the front or rear axle, have it transported on a transporter or trailer.

In the event of damage to the electrical system

If the battery is defective, the automatic transmission will be locked in position **P**. To shift the automatic transmission to position **N**, you must provide power to the vehicle's electrical system in the same way as when jump-starting (> page 304).

Have the vehicle transported on a transporter or trailer.

Recovering a vehicle that has become stuck

! When recovering a trapped vehicle, do not jerk the vehicle or pull it at an angle. If the tractive power is too high, the vehicles could be damaged.

If the drive wheels get trapped on loose or muddy ground, recover the vehicle with the utmost care, especially so if the vehicle is laden.

Never attempt to recover a vehicle with a trailer attached.

Pull out the vehicle backwards, if possible, using the tracks it made when it became stuck.

Tow-starting (emergency engine starting)

! Vehicles with automatic transmission must not be tow-started. Otherwise, you could damage the automatic transmission.

You can find information on "Jump-starting" at (▷ page 304).

Electrical fuses

Important safety notes

WARNING

Only use fuses that have been approved for Mercedes-Benz vehicles and which have the correct fuse rating for the systems concerned. Do not attempt to repair or bridge faulty fuses. Using fuses which have not been approved or attempting to repair or bridge faulty fuses could cause the fuse to be overloaded and result in a fire. Have the cause traced and rectified at a qualified specialist workshop.

! Only use fuses that have been approved for Mercedes-Benz vehicles and which have the correct fuse rating for the system concerned. Otherwise, components or systems could be damaged.

The fuses in your vehicle serve to close down faulty circuits. If a fuse blows, all the components on the circuit and their functions stop operating.

Blown fuses must be replaced with fuses of the same rating, which you can recognise by the colour and fuse rating. The fuse ratings are listed in the fuse allocation chart.

If the newly inserted fuse also blows, have the cause traced and rectified at a qualified specialist workshop, e.g. a Mercedes-Benz Service Centre.

Before replacing a fuse

- ▶ Secure the vehicle against rolling away (▷ page 158).
- ▶ Switch off all electrical consumers.
- ▶ Turn the key to position **0** in the ignition lock and remove it (▷ page 145). On vehicles with KEYLESS-GO, make sure the ignition is switched off (▷ page 145). All indicator lamps in the instrument cluster must be off.

The fuses are located in various fuse boxes:

- fuse box on the front-passenger side of the dashboard
- fuse box in the engine compartment on the right-hand side of the vehicle, when viewed in the direction of travel

The fuse allocation chart is in the vehicle tool kit which is located in the stowage compartment under the luggage compartment floor (▷ page 293).

Dashboard fuse box

! Do not use a pointed object such as a screwdriver to open the cover in the dashboard. You could damage the dashboard or the cover.

! Make sure that no moisture can enter the fuse box when the cover is open.

! When closing the cover, make sure that it is lying correctly on the fuse box. Moisture seeping in or dirt could otherwise impair the operation of the fuses.



- ▶ **To open:** pull cover ① upwards in the direction of the arrow and remove it.
- ▶ **To close:** clip in cover ① on top of the dashboard.
- ▶ Fold cover ① inwards until it engages.

Fuse box in the engine compartment

- ❗ Make sure that no moisture can enter the fuse box when the cover is open.
- ❗ When closing the cover, make sure that it is lying correctly on the fuse box. Moisture seeping in or dirt could otherwise impair the operation of the fuses.



- ▶ Open the bonnet.
- ▶ Remove any existing moisture from the fuse box using a dry cloth.
- ▶ **To open:** open clamp ①.
- ▶ Fold up cover ② and remove it.
- ▶ **To close:** check whether the seal is seated correctly in cover ②.
- ▶ Insert cover ② at the front of the fuse box into the retainer.
- ▶ Fold down cover ② and close clamps ①.
- ▶ Close the bonnet.

Fuse box in the luggage compartment

- ❗ Make sure that no moisture can enter the fuse box when the cover is open.

- ❗ When closing the cover, make sure that it is lying correctly on the fuse box. Moisture seeping in or dirt could otherwise impair the operation of the fuses.

- ▶ Open the tailgate.



- ▶ **To open:** open the luggage compartment floor and secure it (▷ page 293).
- ▶ Fold cover ① to the left in the direction of the arrow.

Useful information	312
Important safety notes	312
Operation	312
Winter operation	314
Tyre pressure	315
Changing a wheel	320
Wheel and tyre combinations	325
Emergency spare wheel	328

Useful information

- i** This Owner's Manual describes all models, series and optional equipment for your vehicle that were available at the time of going to press. National variations are possible. Note that your vehicle may not be equipped with all of the functions described. This is also the case for systems and functions relevant to safety.
- i** Read the information on qualified specialist workshops: (▷ page 23).

Important safety notes

WARNING

If wheels and tyres of the wrong size are used, the wheel brakes or suspension components may be damaged. There is a risk of accident. Always replace wheels and tyres with those that fulfil the specifications of the original part (designation, manufacturer, model).

WARNING

A flat tyre severely impairs the driving, steering and braking characteristics of the vehicle. There is a risk of accident.

Tyres without run-flat characteristics:

- do not drive with a flat tyre.
- immediately replace the flat tyre with your emergency spare wheel or spare wheel, or consult a qualified specialist workshop.

Tyres with run-flat characteristics:

- pay attention to the information and warning notices on MOExtended tyres (tyres with run-flat characteristics).

Accessories that are not approved for your vehicle by Mercedes-Benz or are not being used correctly can impair the operating safety.

Before purchasing and using non-approved accessories, visit a qualified specialist workshop and enquire about:

- suitability
- legal stipulations
- factory recommendations

Information on the dimensions and types of wheels and tyres for your vehicle can be found in the "Wheel/tyre combinations" section (▷ page 325).

Information on air pressure for the tyres on your vehicle can be found:

- on the tyre pressure label on the fuel filler flap (▷ page 156)
- in the "Tyre pressure" section
- under "Tyre pressure" (▷ page 315)

Modification work on the brake system and wheels is not permitted. The use of wheel spacers or brake dust shields is not permitted. This invalidates the general operating permit for the vehicle.

- i** Further information on wheels and tyres can be obtained at any qualified specialist workshop.

Operation

Information on driving

Check the tyre pressures when the vehicle is heavily laden and, if necessary, adjust.

While driving, pay attention to vibrations, noises and unusual handling characteristics, e.g. pulling to one side. This may indicate that the wheels or tyres are damaged. If you suspect that a tyre is defective, reduce your speed immediately. Stop the vehicle as soon as possible to check the wheels and tyres for damage. Hidden tyre damage could also be causing the unusual handling characteristics. If you find no signs of damage, have the tyres and wheels checked at a qualified specialist workshop.

When parking your vehicle, make sure that the tyres do not get deformed by the kerb or

other obstacles. If it is necessary to drive over kerbs, speed humps or similar elevations, try to do so slowly and at an obtuse angle. Otherwise, the tyres, particularly the sidewalls, may be damaged.

Regular checking of wheels and tyres

WARNING

Damaged tyres can cause tyre inflation pressure loss. As a result, you could lose control of your vehicle. There is a risk of accident.

Check the tyres regularly for signs of damage and replace any damaged tyres immediately.

Regularly check the wheels and tyres of your vehicle for damage at least once a month, as well as after driving off-road or on rough roads. Damaged wheels can cause a loss of tyre pressure. Pay particular attention to damage such as:

- cuts in the tyres
- punctures
- tears in the tyres
- bulges on tyres
- deformation or severe corrosion on wheels

Regularly check the tyre tread depth and the condition of the tread across the whole width of the tyre (> page 313). If necessary, turn the front wheels to full lock in order to inspect the inner side of the tyre surface.

All wheels must have a valve cap to protect the valve against dirt and moisture. Do not fit anything onto the valve other than the standard valve cap or other valve caps approved by Mercedes-Benz for your vehicle. Do not fit any other valve caps or systems, e.g. tyre pressure monitoring systems.

Regularly check the pressure of all the tyres, particularly prior to long trips. Adjust the tyre pressure as necessary (> page 315).

Observe the notes on the emergency spare wheel (> page 328).

The service life of tyres depends on various factors, including the following:

- driving style
- tyre pressure
- tyre mileage

Tyre tread

WARNING

Insufficient tyre tread will reduce tyre traction. The tyre is no longer able to dissipate water. This means that on wet road surfaces, the risk of aquaplaning increases, in particular where speed is not adapted to suit the driving conditions. There is a risk of accident.

If the tyre pressure is too high or too low, tyres may exhibit different levels of wear at different locations on the tyre tread. Thus, you should regularly check the tread depth and the condition of the tread across the entire width of all tyres.

Minimum tyre tread depth for:

- summer tyres: 3 mm
- M+S tyres: 4 mm

For safety reasons, replace the tyres before the legally prescribed limit for the minimum tyre tread depth is reached..

Selecting, fitting and replacing tyres

- Only fit tyres and wheels of the same type and make.
- Only fit tyres of the correct size onto the wheels.
- Run in new tyres at moderate speeds for the first 100 km. They only reach their full performance after this distance.
- Do not drive with tyres which have too little tread depth. This otherwise significantly reduces the traction on wet roads (aquaplaning).
- Replace the tyres after six years at the latest, regardless of wear.

Observe the notes on the emergency spare wheel (▷ page 328).

MOExtended tyres (tyres with run-flat characteristics)

With MOExtended tyres (tyres with run-flat characteristics), you can continue to drive your vehicle even if there is a total loss of pressure in one or more tyres.

MOExtended tyres may only be used in conjunction with an active tyre pressure loss warning system or with an active tyre pressure monitor and on wheels specifically tested by Mercedes-Benz.

Notes on driving with MOExtended tyres with a flat tyre (▷ page 295).

- i** Vehicles with MOExtended tyres are not equipped with a TIREFIT kit at the factory. It is therefore recommended that you additionally equip your vehicle with a TIREFIT kit if you fit tyres that do not feature run-flat characteristics, e.g. winter tyres. A TIREFIT kit can be obtained from a qualified specialist workshop.

Winter operation

General notes

Have your vehicle winterproofed at a qualified specialist workshop at the onset of winter.

Observe the notes in the "Changing a wheel" section (▷ page 320).

Driving with summer tyres

At temperatures below +7 °C, summer tyres lose elasticity and therefore traction and braking power. Change the tyres on your vehicle to M+S tyres. Using summer tyres at very cold temperatures could cause tears to form, thereby damaging the tyres permanently. Mercedes-Benz cannot accept responsibility for this type of damage.

M+S tyres

WARNING

M+S tyres with a tyre tread depth of less than 4 mm are not suitable for use in winter as they do not provide sufficient traction. There is a risk of accident.

M+S tyres with a tread depth of less than 4 mm must be replaced.

At temperatures below +7 °C, use winter tyres or all-season tyres. Both types of tyre are identified by the M+S marking.

Only winter tyres bearing the  snowflake symbol in addition to the M+S marking provide the best possible grip in wintry road conditions.

Only these tyres will allow driving safety systems such as ABS and ESP® to function optimally in winter. These tyres have been developed specifically for driving in snow.

Use M+S tyres of the same make and tread on all wheels to maintain safe handling characteristics.

Always observe the maximum permissible speed specified for the M+S tyres you have fitted.

If you fit M+S tyres that have a lower maximum permissible speed than that of the vehicle, affix a corresponding warning label in the driver's field of vision. This can be obtained at a qualified specialist workshop.

Under these circumstances, you should also restrict the maximum speed of the vehicle using permanent SPEEDTRONIC so that it does not exceed the maximum permissible speed for the M+S tyres (▷ page 167).

When you have fitted the M+S tyres:

- ▶ Check the tyre pressures (▷ page 315).
- ▶ Restart the tyre pressure monitor (▷ page 319).
- ▶ Restart the tyre pressure loss warning system (▷ page 317).

For more information on driving with the emergency spare wheel, see (▷ page 328).

Snow chains

WARNING

If you have fitted snow chains to the front wheels, they may scrape against the vehicle body or chassis components. This could cause damage to the vehicle or the tyres. There is a risk of an accident.

To avoid hazardous situations:

- never fit snow chains on the front wheels
- fit snow chains to the rear wheels in pairs.

! You must drive at raised vehicle level if snow chains have been fitted. The vehicle could otherwise be damaged. Observe the information in the "AIRMATIC package" section.

! On some tyre sizes there is not enough space for snow chains. In order to prevent damage to the vehicle or the tyres, observe the "Tyre and wheel combinations" section under "Tyres and wheels".

! **Vehicles with the AIRMATIC package:** do not drive in ADS **SPORT** mode when driving with snow chains fitted.

For safety reasons, Mercedes-Benz recommends that you only use snow chains that have been specially approved for your vehicle by Mercedes-Benz, or that are of a corresponding standard of quality.

If you intend to fit snow chains, please bear the following points in mind:

- only use snow chains when the road surface is completely snow-covered. Remove the snow chains as soon as possible when you come to a road that is not snow-covered.
- do not exceed the maximum permissible speed of 50 km/h.
- local regulations may restrict the use of snow chains. Observe the appropriate regulations if you wish to fit snow chains.
- snow chains cannot be fitted to all wheel-tyre combinations. Permissible wheel-tyre combinations (▷ page 325).

i You may wish to deactivate ESP® when pulling away with snow chains fitted (▷ page 64). This way you can allow the wheels to spin in a controlled manner, achieving an increased driving force (cutting action).

For more information on driving with an emergency spare wheel, see (▷ page 328).

Tyre pressure

Tyre pressure specifications

WARNING

Tyres with too low or too high tyre pressure contain the following hazards:

- they can burst, in particular if the vehicle is heavily laden or when driven at high speeds.
- the tyres can wear excessively and/or unevenly, which can severely impair tyre traction.
- the driving, steering and braking characteristics may be severely impaired.

There is a risk of accident.

Follow recommended tyre inflation pressures and check the pressure of all the tyres including the spare wheel:

- at least every two weeks
- if the load changes
- before beginning a long journey
- for changed operating conditions, e.g. off-road driving

If necessary, correct the tyre pressure.

WARNING

If you fit unsuitable accessories onto tyre valves, the tyre valves may be overloaded and malfunction, which can cause tyre pressure loss. Due to their design, retrofitted tyre pressure monitors keep the tyre valve open. This can also result in tyre pressure loss. There is a risk of accident.

Only screw standard valve caps or valve caps specifically provided by Mercedes-Benz for your vehicle onto the tyre valve.

WARNING

If the tyre pressure drops repeatedly, the wheel, valve or tyre may be damaged. Tyre pressure that is too low may result in a tyre blow-out. There is a risk of accident.

- Check the tyre for foreign objects.
- Check whether the wheel is losing air or the valve is leaking.

If you are unable to rectify the damage, contact a qualified specialist workshop.

Environmental note

Check the tyre pressure regularly, at least every 14 days.

You will find a table of tyre pressures for various operating conditions on the inside of your vehicle's fuel filler flap.

Operation with the emergency spare wheel (▷ page 328).

Operation with a trailer: the applicable value for the rear tyres is the maximum tyre pressure value stated in the table inside the fuel filler flap.

The table inside the fuel filler flap may state tyre pressures for different load conditions. These are defined in the table as different numbers of passengers and amounts of luggage. The actual number of seats may vary – for more information, please refer to the vehicle's registration documents.

If tyre sizes are not specified, the tyre pressures stated on the tyre pressure information label apply for all tyres approved for this vehicle.

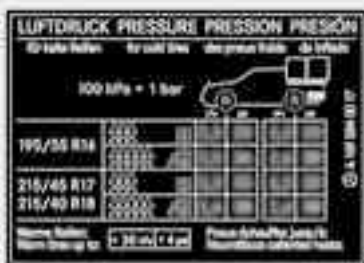

100 kPa = 1 bar

195/55 R16	215/45 R17	215/40 R18
4.5	5.0	5.5
5.5	6.0	6.5
6.5	7.0	7.5
7.5	8.0	8.5
8.5	9.0	9.5
9.5	10.0	10.5
10.5	11.0	11.5
11.5	12.0	12.5
12.5	13.0	13.5
13.5	14.0	14.5
14.5	15.0	15.5
15.5	16.0	16.5
16.5	17.0	17.5
17.5	18.0	18.5
18.5	19.0	19.5
19.5	20.0	20.5
20.5	21.0	21.5
21.5	22.0	22.5
22.5	23.0	23.5
23.5	24.0	24.5
24.5	25.0	25.5
25.5	26.0	26.5
26.5	27.0	27.5
27.5	28.0	28.5
28.5	29.0	29.5
29.5	30.0	30.5
30.5	31.0	31.5
31.5	32.0	32.5
32.5	33.0	33.5
33.5	34.0	34.5
34.5	35.0	35.5
35.5	36.0	36.5
36.5	37.0	37.5
37.5	38.0	38.5
38.5	39.0	39.5
39.5	40.0	40.5
40.5	41.0	41.5
41.5	42.0	42.5
42.5	43.0	43.5
43.5	44.0	44.5
44.5	45.0	45.5
45.5	46.0	46.5
46.5	47.0	47.5
47.5	48.0	48.5
48.5	49.0	49.5
49.5	50.0	50.5
50.5	51.0	51.5
51.5	52.0	52.5
52.5	53.0	53.5
53.5	54.0	54.5
54.5	55.0	55.5
55.5	56.0	56.5
56.5	57.0	57.5
57.5	58.0	58.5
58.5	59.0	59.5
59.5	60.0	60.5
60.5	61.0	61.5
61.5	62.0	62.5
62.5	63.0	63.5
63.5	64.0	64.5
64.5	65.0	65.5
65.5	66.0	66.5
66.5	67.0	67.5
67.5	68.0	68.5
68.5	69.0	69.5
69.5	70.0	70.5
70.5	71.0	71.5
71.5	72.0	72.5
72.5	73.0	73.5
73.5	74.0	74.5
74.5	75.0	75.5
75.5	76.0	76.5
76.5	77.0	77.5
77.5	78.0	78.5
78.5	79.0	79.5
79.5	80.0	80.5
80.5	81.0	81.5
81.5	82.0	82.5
82.5	83.0	83.5
83.5	84.0	84.5
84.5	85.0	85.5
85.5	86.0	86.5
86.5	87.0	87.5
87.5	88.0	88.5
88.5	89.0	89.5
89.5	90.0	90.5
90.5	91.0	91.5
91.5	92.0	92.5
92.5	93.0	93.5
93.5	94.0	94.5
94.5	95.0	95.5
95.5	96.0	96.5
96.5	97.0	97.5
97.5	98.0	98.5
98.5	99.0	99.5
99.5	100.0	100.5

If a tyre size precedes a tyre pressure, the following tyre pressure information is only valid for that tyre size.

Use a suitable pressure gauge to check the tyre pressure. The outer appearance of a tyre does not permit any reliable conclusion about the tyre pressure. On vehicles fitted with the electronic tyre pressure monitor, the tyre pressure can be checked using the on-board computer.

If possible, only correct tyre pressures when the tyres are cold.

The tyres are cold:

- if the vehicle has been parked with the tyres out of direct sunlight for at least three hours and
- if the vehicle has not been driven further than 1.6 km

Depending on the ambient temperature, the speed at which you are driving and the load on the tyres, the tyre temperature and thus the tyre pressure change by approximately 10 kPa per 10 °C (0.1 bar/1.5 psi). Take this into account when checking the pressure of warm tyres. Only correct the tyre pressure if it is too low for the current operating conditions.

Driving with tyre pressure that is too high or too low can:

- shorten the service life of the tyres
- cause increased tyre damage
- have a negative effect on handling characteristics and thus the driving safety (e.g. aquaplaning)

i The tyre pressure values given for low loads are minimum values which offer you good ride comfort characteristics.

However, you can also use the values given for higher loads. These are permissible and will not adversely affect the running of the vehicle.

Tyre pressure loss warning system

Important safety notes

While the vehicle is in motion, the tyre pressure loss warning system monitors the set tyre pressure using the rotational speed of the wheels. This enables the system to detect significant pressure loss in a tyre. If the speed of rotation of a wheel changes as a result of a loss of pressure, a corresponding warning message will appear in the multifunction display.

The tyre pressure warning system does not warn you of an incorrectly set tyre pressure. Observe the notes on the recommended tyre pressure (▷ page 315).

The tyre pressure loss warning system does not replace the need to regularly check your vehicle's tyre pressures, since an even loss of pressure on several tyres at the same time cannot be detected by the tyre pressure loss warning system.

The tyre pressure monitor is not able to warn you of a sudden loss of pressure, e.g. if the tyre is penetrated by a foreign object. In the event of a sudden loss of pressure, bring the vehicle to a halt by braking carefully. Avoid abrupt steering manoeuvres.





The function of the tyre pressure loss warning system is limited or delayed if:

- snow chains are fitted to your vehicle's tyres.
- road conditions are wintry.
- you are driving on sand or gravel.
- you adopt a very sporty driving style (cornering at high speeds or driving with high rates of acceleration).

- you are towing a very heavy or large trailer.
- you are driving with a heavy load (in the vehicle or on the roof).

Restarting the tyre pressure loss warning system

Restart the tyre pressure loss warning system if you have:

- changed the tyre pressure
 - changed the wheels or tyres
 - fitted new wheels or tyres
- ▶ Before restarting, make sure that the tyre pressures are set properly on all four tyres for the respective operating conditions. The recommended tyre pressures can be found in the table on the fuel filler flap. The tyre pressure loss warning system can only give reliable warnings if you have set the correct tyre pressure. If an incorrect tyre pressure is set, these incorrect values will be monitored.
- ▶ Also observe the notes in the section on tyre pressures (▷ page 315).
- ▶ Make sure that the key is in position **2** (▷ page 145) in the ignition lock.
- ▶ Press and hold the  or  button on the multifunction steering wheel until the standard display appears in the multifunction display (▷ page 197).
- ▶ Press the  or  button until the **Run Flat Indicator active Menu: R-Button** message appears in the multifunction display.
- ▶ Press the reset button on the instrument cluster (▷ page 30). The **Restart Run Flat Indicator?** message appears in the multifunction display.

If you wish to confirm the restart:

- ▶ Press the  button. The **Run Flat Indicator restarted** message appears in the multifunction display.

After a teach-in period, the tyre pressure loss warning system will monitor the set tyre pressures of all four tyres.

If you wish to cancel the restart:

- ▶ Press the  button.

or

- ▶ Wait until the **Restart Run Flat Indicator?** message goes out.
The tyre pressure values stored at the last restart will continue to be monitored.

Tyre pressure monitor

Important safety notes

It is the driver's responsibility to set the tyre pressure to the recommended cold tyre pressure suitable for the operating situation (▷ page 315). Note that the correct tyre pressure for the current operating situation must first be taught-in to the tyre pressure monitor. If there is a substantial loss of pressure, the warning threshold for the warning message is aligned to the reference values taught-in. Restart the tyre pressure monitor after adjusting to the cold tyre pressure (▷ page 319). The current pressures are saved as new reference values. This will ensure that a warning message will only appear if the tyre pressure drops significantly. The tyre pressure monitor does not warn you of an incorrectly set tyre pressure. Observe the notes on the recommended tyre pressure (▷ page 315).

The tyre pressure monitor is not able to warn you of a sudden loss of pressure, e.g. if the tyre is penetrated by a foreign object. In the event of a sudden loss of pressure, bring the vehicle to a halt by braking carefully. Avoid abrupt steering manoeuvres.

If a tyre pressure monitor system is fitted, the vehicle's wheels have sensors fitted that monitor the tyre pressures in all four tyres. The tyre pressure monitor warns you if the pressure drops in one or more of the tyres. The tyre pressure monitor only functions if





the corresponding sensors are fitted to all wheels.

Information on tyre pressures is displayed in the multifunction display. After a few minutes of driving, the current tyre pressure of each tyre is shown in the multifunction display.

The tyre pressure values indicated by the on-board computer may differ from those measured at a filling station using a pressure gauge. The tyre pressures shown by the on-board computer refer to those measured at sea level. At high altitudes, the tyre pressure values indicated by a pressure gauge are higher than those shown by the on-board computer. In this case, do not reduce the tyre pressures.

The operation of the tyre pressure monitor can be affected by interference from radio transmitting equipment (e.g. radio head-phones, two-way radios) that may be being operated in or near the vehicle.

Checking tyre pressure electronically

- ▶ Make sure that the key is in position **2** (▷ page 145) in the ignition lock.
- ▶ Press and hold the  or  button on the multifunction steering wheel until the standard display appears in the multifunction display (▷ page 197).
- ▶ Press and hold the  or  button until the current tyre pressure of each tyre is shown in the multifunction display.

If the vehicle has been parked for longer than 20 minutes, the **Tyre pressure displayed after driving for several minutes** message appears.

After a teach-in period, the tyre pressure monitor automatically recognises new wheels or new sensors. As long as a clear allocation of the tyre pressure values to the individual wheels is not possible, the **Tyre pressure monitor active** display message is shown instead of the tyre pressure display. The tyre pressures are already being monitored.

Warning messages of the tyre pressure monitor



If the tyre pressure monitor detects a significant pressure loss on one or more tyres, a warning message is shown in the multifunction display. A warning tone also sounds and the tyre pressure warning lamp lights up in the instrument cluster.

Each tyre that is affected by a significant loss of pressure is highlighted in the pressure display.



- ▶ If the **Please correct tyre pressure(s)** message appears in the multifunction display, check the tyre pressure on all four wheels and correct it if necessary.
- i** If the wheel positions on the vehicle are interchanged, the tyre pressures may be displayed for the wrong positions for a short time. This is rectified after a few minutes of driving, and the tyre pressures are displayed for the correct positions.

Restarting the tyre pressure monitor

When you restart the tyre pressure monitor, all existing warning messages are deleted and the warning lamps go out. The monitor uses the currently set tyre pressures as the reference values for monitoring. The tyre pressure monitor must be restarted when you set the tyre pressure to a new value (as a result of changed drive or load characteristics, for example). The tyre pressure monitor then monitors the new tyre pressure values.

- ▶ Use the table on the inside of the fuel filler flap to ensure that the tyre pressure is set correctly in all four tyres for the current operating conditions.
Also observe the notes in the section on tyre pressures (▷ page 315).
- ▶ Make sure that the key is in position **2** in the ignition lock.
- ▶ Press and hold the  or  button on the multifunction steering wheel until the

standard display appears in the multifunction display (▷ page 197).

- ▶ Press and hold the  or  button until the tyre pressure of each wheel or the **Tyre pressure displayed after driving for several minutes** message appears.
- ▶ Press the reset button on the instrument cluster (▷ page 30).
The **Restart tyre press. monitor?** message appears in the multifunction display.

If you wish to confirm the restart:

- ▶ Press the  button.
The **Tyre pressure monitor restarted** message appears in the multifunction display.
After you have driven for a few minutes, the system checks whether the current tyre pressures are within the specified range. The new tyre pressures are then accepted as reference values and monitored.

If you wish to cancel the restart:

- ▶ Press the  button.
The tyre pressure values stored at the last restart will continue to be monitored.

Radio type approval for the tyre pressure monitor

In certain countries, a radio type approval for the tyre pressure monitor may be required. The radio type approval number for the tyre pressure monitor can be found online at: <http://www.mercedes-benz.de/betriebsanleitung>.

Country	Radio type approval number
Brazil	1489-10-44 15
Dubai	TRA, Registered NO 00 16 161/08 TRA, Registered NO 00 16 162/08

Country	Radio type approval number
Morocco	MR5527 ANRT 2010/ 27. April 2010 MR5526 ANRT 2010/ 27. April 2010
Philippines	ESD-1105558C
Singapore	Compliance with IDA Standard N0140-09
South Africa	TA-2008/1068 TA-2008/1069

Changing a wheel

Flat tyre

You can find information on what to do in the event of a flat tyre in the "Breakdown assistance" section (▷ page 295). Instructions for driving with MOExtended tyres in the event of a flat tyre are also provided there.

Vehicles with an emergency spare

wheel: in the event of a flat tyre, the emergency spare wheel is fitted according to the description under "Fitting a wheel" (▷ page 321).

Interchanging the wheels

WARNING

Interchanging the front and rear wheels may severely impair the driving characteristics if the wheels or tyres have different dimensions. The wheel brakes or suspension components may also be damaged. There is a risk of accident.

Interchange front and rear wheels only if the wheels and tyres are of the same dimensions.

! On vehicles fitted with a tyre pressure monitor, electronic components are located in the wheel.

Tyre-fitting tools should not be applied in the area of the valve, as this could damage the electronic components.

Only have tyres changed at a qualified specialist workshop.

Interchanging the front and rear wheels of differing dimensions can render the general operating permit invalid.

Observe the instructions and safety notes in the "Fitting a wheel" section (▷ page 321).

The wear patterns on the front and rear tyres differ, depending on the operating conditions. Interchange the wheels before a clear wear pattern has formed on the tyres. Front tyres typically wear more on the shoulders and the rear tyres in the centre.

On vehicles that have the same size front and rear wheels, you can interchange the wheels every 5000km to 10,000 km depending on the degree of tyre wear. Maintain the direction of tyre rotation.

Clean the contact surfaces of the wheel and the brake disc thoroughly every time a wheel is interchanged. Check the tyre pressure and, if necessary, restart the tyre pressure loss warning system or the tyre pressure monitor.

Direction of rotation

Tyres with a specified direction of rotation have additional benefits, e.g. if there is a risk of aquaplaning. You will only gain these benefits if the correct direction of rotation is observed.

An arrow on the sidewall of the tyre indicates its correct direction of rotation.

Storing wheels

Store wheels that are not being used in a cool, dry and preferably dark place. Protect the tyres against oil, grease, petrol and diesel.

Cleaning the wheels

⚠ WARNING

The water jet of circular-jet nozzles (dirt grinders) can cause damage not visible from the outside to tyres or chassis components. Components damaged in this way can unexpectedly fail. There is a risk of an accident.

Do not use high-pressure cleaners with circular-jet nozzles to clean the vehicle. Have damaged tyres or chassis components replaced immediately.

Fitting a wheel

Preparing the vehicle

- ▶ **Vehicles with an emergency spare wheel:** when fitting the emergency spare wheel in the event of a flat tyre, observe the additional notes on vehicle preparation under "Flat tyre" (▷ page 295).
- ▶ Park the vehicle on firm, non-slippery and level ground.
- ▶ Apply the parking brake.
- ▶ Bring the front wheels into the straight-ahead position.
- ▶ Shift the transmission to position **P**.
- ▶ **Vehicles with the AIRMATIC package:** make sure that highway level is selected (▷ page 174).
- ▶ Switch off the engine.
- ▶ **Vehicles without KEYLESS-GO:** remove the key from the ignition lock.
- ▶ **Vehicles with KEYLESS-GO:** open the driver's door. The on-board electronics have status **0**, which is the same as the key having been removed.
- ▶ **Vehicles with KEYLESS-GO:** remove the Start/Stop button from the ignition lock (▷ page 145).

- ▶ If included in the vehicle equipment, take the tyre-change tool kit out of the vehicle.
- ▶ Secure the vehicle to prevent it from rolling away.

i Apart from some country-specific variants, vehicles are not equipped with tyre-changing tools. For more information on which tools are required to perform a wheel change on your vehicle, consult a Mercedes-Benz Service Centre.

Required tyre-changing tools could be, for example:

- jack
- wheel chock
- wheel wrench

Securing the vehicle against rolling away



If your vehicle is equipped with a wheel chock, it can be found in the tyre-change tool kit (▷ page 293).

The folding wheel chock is an additional securing measure to prevent the vehicle from rolling away, for example when changing a wheel.

- ▶ Fold both plates upwards ①.
- ▶ Fold out lower plate ②.
- ▶ Guide the lugs on the lower plate fully into the openings in base plate ③.



Securing the vehicle on level ground

- **On level ground:** place chocks or other suitable items under the front and rear of the wheel that is diagonally opposite the wheel you wish to change.



Securing the vehicle on slight downhill gradients

- **On light downhill gradients:** place chocks or other suitable items in front of the wheels of the front and rear axle.

Raising the vehicle

WARNING

If you do not position the jack correctly at the appropriate jacking point of the vehicle, the jack could tip over with the vehicle raised. There is a risk of injury.

Only position the jack at the appropriate jacking point of the vehicle. The base of the jack must be positioned vertically, directly under the jacking point of the vehicle.

The following must be observed when raising the vehicle:

- to raise the vehicle, only use the vehicle-specific jack that has been tested and approved by Mercedes-Benz. If the jack is used incorrectly, it could tip over while the vehicle is raised.
- the jack is designed only to raise and hold the vehicle for a short time while a wheel is being changed. It is not suited for performing maintenance work under the vehicle.
- avoid changing the wheel on uphill and downhill slopes.
- before raising the vehicle, secure it from rolling away by applying the parking brake and inserting wheel chocks. Never disengage the parking brake while the vehicle is raised.
- the jack must be placed on a firm, flat and non-slip surface. On a loose surface, a large, load-bearing underlay must be used. On a slippery surface, a non-slip underlay must be used, e.g. rubber mats.
- do not use wooden blocks or similar objects as a jack underlay. Otherwise, the jack will not be able to achieve its load-bearing capacity due to the restricted height.
- make sure that the distance between the underside of the tyres and the ground does not exceed 3 cm.
- never place your hands or feet under the raised vehicle.
- never lie under the raised vehicle.
- never start the engine when the vehicle is raised.
- never open or close a door or the tailgate when the vehicle is raised.
- make sure that no persons are present in the vehicle when the vehicle is raised.



- ▶ Using wheel wrench ①, loosen the bolts on the wheel you wish to change by about one full turn. Do not unscrew the bolts completely.



- ② Jacking points

- ③ jack

- ④ Crank

- ▶ Position jack ③ at jacking point ②.



The jacking points are located just behind the front wheel arches and just in front of the rear wheel arches (arrows).

- ▶ Take the ratchet ring spanner out of the vehicle tool kit and place it on the hexagon nut of the jack so that the letters **AUF** are visible.

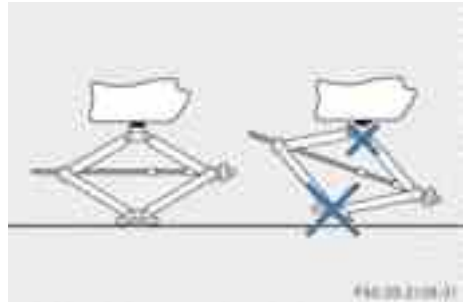

Example

- ▶ Make sure that the base of the jack is positioned vertically under the jacking point.
- ▶ Turn ratchet ring spanner ④ until jack ③ sits completely on jacking point ② and the base of the jack lies evenly on the ground.
- ▶ Turn ratchet ring spanner ④ until the tyre is raised a maximum of three centimetres from the ground.

Removing a wheel

- ❗ Do not place wheel bolts in sand or dirt. The threads of the wheel bolts and wheel hubs could otherwise be damaged when the bolts are tightened.



- ▶ Unscrew the uppermost wheel bolt completely.
- ▶ Screw centring pin ① into the thread instead of the wheel bolt.
- ▶ Unscrew the remaining wheel bolts fully.
- ▶ Remove the wheel.

Fitting a new wheel

WARNING

Oiled or greased wheel bolts or damaged wheel bolts/hub threads can cause the wheel bolts to come loose. As a result, you could lose a wheel while driving. There is a risk of accident.

Never oil or grease wheel bolts. In the event of damage to the threads, contact a qualified specialist workshop immediately. Have the damaged wheel bolts or hub threads replaced/renewed. Do not continue driving.

WARNING

If you tighten the wheel bolts or wheel nuts when the vehicle is raised, the jack could tip over. There is a risk of injury.

Only tighten the wheel bolts or wheel nuts when the vehicle is on the ground.

Always pay attention to the instructions and safety notices in "Changing a wheel" (▷ page 320).

Only use wheel bolts that have been designed for the wheel and the vehicle. For safety reasons, Mercedes-Benz recommends that you only use wheel bolts which have been

approved for Mercedes-Benz vehicles and the respective wheel.

- ❗ Always use wheel bolts ② to fit 17" wheels or the 18" collapsible emergency spare wheel. Using other wheel bolts when fitting 17" wheels or the 18" collapsible emergency spare wheel could damage the brake system.

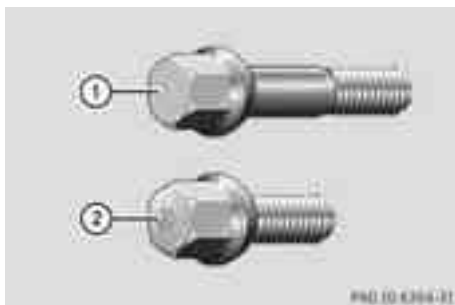

- ① Wheel bolts for 18", 19", 20" and 21" wheels and for the 19" collapsible emergency spare wheel
- ② Wheel bolts for 17" wheels and for the 18" collapsible emergency spare wheel



- ▶ Clean the wheel and wheel hub contact surfaces.
- ▶ Slide the wheel to be mounted onto the centring pin and push it on.
- ▶ Tighten the wheel bolts until they are finger-tight.
- ▶ Unscrew the centring pin.

- ▶ Tighten the last wheel bolt until it is finger-tight.
- ▶ Inflate the collapsible emergency spare wheel (▷ page 330).

Lowering the vehicle

WARNING

The wheels could work loose if the wheel nuts and bolts are not tightened to the specified tightening torque. There is a risk of accident. Have the tightening torque immediately checked at a qualified specialist workshop after a wheel is changed.

- ! Inflate the collapsible emergency spare wheel using the tyre inflation compressor before lowering the vehicle. The wheel rim could otherwise be damaged.



- ▶ Place the ratchet ring spanner onto the hexagon nut of the jack so that the letters **AB** are visible.
- ▶ Turn the ratchet ring spanner until the vehicle is once again standing firmly on the ground.
- ▶ Place the jack to one side.
- ▶ Tighten the wheel bolts evenly in a cross-wise pattern in the sequence indicated (① to ⑤). The tightening torque must be **150 Nm**.
- ▶ Turn the jack back to its initial position.

- ▶ Stow the jack and the rest of the tyre-changing tools in the stowage well under the luggage compartment floor.
- ▶ Check the tyre pressure of the newly fitted wheel and adjust it if necessary. Observe the recommended tyre pressure (▷ page 315).

- i Vehicles with tire pressure control system: all fitted wheels must be equipped with functioning sensors.

Wheel and tyre combinations

General notes

- ! For safety reasons, Mercedes-Benz recommends that you only use tyres and wheels which have been approved by Mercedes-Benz specifically for your vehicle.

These are specially adapted to the control systems, such as ABS or ESP® and are marked as follows:

- MO = Mercedes-Benz Original
- MOE = Mercedes-Benz Original Extended (tyres featuring run-flat characteristics)
- MO1 = Mercedes-Benz Original (only certain AMG tyres)

Mercedes-Benz Original Extended tyres may only be used on wheels that have been specifically approved by Mercedes-Benz.

Only use tyres, wheels or accessories tested and approved by Mercedes-Benz. Certain characteristics, e.g. handling, vehicle noise emissions or fuel consumption, may otherwise be adversely affected. In addition, when driving with a load, tyre dimension variations could cause the tyres to come into contact with the bodywork and axle components. This could result in damage to the tyres or the vehicle.

Mercedes-Benz accepts no liability for damage resulting from the use of tyres, wheels or accessories other than those tested and approved.

Further information about wheels, tyres and approved combinations can be obtained from any qualified specialist workshop.

! Retreaded tyres are neither tested nor recommended by Mercedes-Benz, since previous damage cannot always be detected on retreaded tyres. As a result, Mercedes-Benz cannot guarantee vehicle safety if retreaded tyres are fitted. Do not fit used tyres if you have no information about their previous usage.

! Large wheels: the lower the section width for a certain wheel size, the lower the ride comfort is on poor road surfaces. Roll comfort and suspension comfort are reduced and the risk of damage to the wheels and tyres as a result of driving over obstacles increases.

Overview of abbreviations used in the following tyre tables:

- BA: both axles
- FA: front axle
- RA: rear axle

You will find a table with recommended tyre pressures for various operating conditions on the inside of your vehicle's fuel filler flap. For further information on tyre pressure, see (▷ page 315). Check tyre pressures regularly and only when the tyres are cold.

Notes on the vehicle equipment – always fit the vehicle:

- with tyres of the same size on a given axle (left/right)
- with the same type of tyres at a given time (summer tyres, winter tyres, MOExtended tyres)

Vehicles with MOExtended tyres are not equipped with a TIREFIT kit at the factory. It is therefore recommended that you additionally equip your vehicle with a TIREFIT kit if you fit tyres that do not feature run-flat characteristics, e.g. winter tyres. A TIREFIT kit can

be obtained from a qualified specialist workshop.

In the following table, the wheel/tyre combinations are allocated to the vehicle models through variants, e.g. V1, V2 etc.:

V1	R 300, R 350, R 350 4MATIC, R 350 4MATIC ¹⁴ , R 350 CDI 4MATIC
V2	R 300 CDI ¹⁴
V3	R 350 BlueTEC 4MATIC
V4	R 500 4MATIC

i Not all wheel/tyre combinations can be mounted at the factory in all countries.

¹⁴ BlueEFFICIENCY

Tyres

Summer tyres

R18

Tyres	Light-alloy wheels	V1	V2	V3	V4
BA: 255/55 R18 105 W	BA: 8.0 J x 18 H2 ET 67	•	•	•	–

R19

Tyres	Light-alloy wheels	V1	V2	V3	V4
BA: 255/50 R19 103 W	BA: 8.0 J x 19 H2 ET 67	•	•	•	•
BA: 255/50 R19 103 W MOExtended ¹⁵	BA: 8.0 J x 19 H2 ET 67	•	•	•	•
BA: 255/50 R19 103 W	BA: 8.5 J x 19 H2 ET 64	•	•	•	•
BA: 255/50 R19 103 W MOExtended ¹⁵	BA: 8.5 J x 19 H2 ET 64	•	•	•	•

R20

Tyres	Light-alloy wheels	V1	V2	V3	V4
BA: 265/45 ZR20 104 Y ¹⁶	BA: 8.5 J x 20 H2 ET 60	•	•	•	•
BA: 265/45 ZR20 104 Y ^{17, 16}	BA: 9.0 J x 20 H2 ET 60	•	•	•	•

R21

Tyres	Light-alloy wheels	V1	V2	V3	V4
FA: 265/40 ZR21 105 Y XL ¹⁸ RA: 265/40 ZR21 105 Y XL ^{17, 18}	FA: 9.0 J x 21 H2 ET 60 RA: 9.0 J x 21 H2 ET 48	•	•	•	•

¹⁵ MOExtended tyres (tyres with run-flat capability) should only be used in conjunction with an activated tyre pressure loss warning system or tyre pressure monitoring system.

¹⁶ Only in conjunction with an air spring on the rear axle.

¹⁷ Use of snow chains is not permitted. Observe the notes under "Snow chains".

¹⁸ Observe the notes on "Large wheels" in the "Wheel/tyre combinations" section.

All-weather tyres

R17

Tyres	Light-alloy wheels	V1	V2	V3	V4
BA: 235/65 R17 104 H M+S ¹⁹	BA: 7.5 J x 17 H2 ET 56	–	•	•	–

Winter tyres





R17

Tyres	Light-alloy wheels	V1	V2	V3	V4
BA: 235/65 R17 104 H M+S  ¹⁹	BA: 7.5 J x 17 H2 ET 56	–	•	•	–

R18

Tyres	Light-alloy wheels	V1	V2	V3	V4
BA: 255/55 R18 105 H M+S 	BA: 8.0 J x 18 H2 ET 67	•	•	•	–

R19

Tyres	Light-alloy wheels	V1	V2	V3	V4
BA: 255/50 R19 107 H XL M+S 	BA: 8.0 J x 19 H2 ET 67	•	•	•	•
BA: 255/50 R19 107 H XL M+S  MOExtended ¹⁵	BA: 8.0 J x 19 H2 ET 67	•	•	•	•
BA: 255/50 R19 107 H XL M+S 	BA: 8.5 J x 19 H2 ET 64	•	•	•	•
BA: 255/50 R19 107 H XL M+S  MOExtended ¹⁵	BA: 8.5 J x 19 H2 ET 64	•	•	•	•

Emergency spare wheel

Important safety notes

 **WARNING**

The wheel/tyre dimensions and the tyre type of the spare wheel/emergency spare wheel

and the wheel to be replaced may differ. Fitting a spare wheel/emergency spare wheel may severely impair the driving characteristics. There is a risk of accident.

¹⁹ R 350 BlueTEC 4MATIC: not in combination with Code 226 (5 + 2-seater).

¹⁵ MOExtended tyres (tyres with run-flat capability) should only be used in conjunction with an activated tyre pressure loss warning system or tyre pressure monitoring system.

To prevent hazardous situations:

- Adapt your driving style accordingly and drive carefully.
- Never fit more than one spare wheel/emergency spare wheel if the dimensions are different to those of the wheel being replaced.
- Only use a spare wheel/emergency spare wheel briefly if the dimensions are different to those of the wheel being replaced.
- Do not switch off ESP®.
- Have the spare wheel/emergency spare wheel in question replaced at the nearest qualified specialist workshop. Make sure that the wheel/tyre dimensions and tyre type are correct.

When using an emergency spare wheel or spare wheel of a different size, you must not exceed the maximum speed of 80 km/h. Snow chains must not be fitted to emergency spare wheels.

General notes

Fitting the emergency spare wheel is described in "Fitting a Wheel" (▷ page 321).

An emergency spare wheel may also be fitted against the direction of rotation. Observe the time restriction on use as well as the speed limitation specified on the emergency spare wheel.

Replace the tyres after six years at the latest, regardless of wear. This also applies to the emergency spare wheel.

- ❗ When you are driving with the collapsible emergency spare wheel fitted, the tyre pressure loss warning system or the tyre pressure monitor cannot function reliably. Only restart the tyre pressure loss warning system/tyre pressure monitor when the defective wheel has been replaced with a new wheel.

Vehicles with tyre pressure monitor:

after mounting an emergency spare wheel, the system may still display the tyre pres-

sure of the removed wheel for a few minutes. The value displayed for the mounted emergency spare wheel is not the same as the current tyre pressure of the emergency spare wheel.

Removing the emergency spare wheel

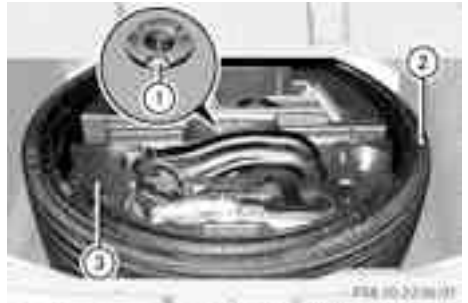

The collapsible emergency spare wheel can be found in the stowage well under the luggage compartment floor.

- ▶ Lift the luggage compartment floor up (▷ page 293).
- ▶ Remove the jack from the tool holder.
- ▶ Turn retaining screw ① anti-clockwise and out of tool holder ③ and remove it.
- ❗ If retaining screw ① does not come out immediately, turn tool holder ③ slightly anti-clockwise. Retaining screw ① can then be unscrewed with ease.
- ▶ Turn tool holder ③ approximately 180°, so that the tyre inflation compressor points backwards.
- ▶ Remove tool holder ③ from collapsible emergency spare wheel ②.
- ▶ Remove collapsible emergency spare wheel ② from the emergency spare wheel well.

For further information on changing a wheel and fitting the spare wheel, see (▷ page 295).

Inflating the collapsible emergency spare wheel

! Inflate the collapsible emergency spare wheel using the tyre inflation compressor before lowering the vehicle. The wheel rim could otherwise be damaged.

! Do not operate the tyre inflation compressor for longer than eight minutes at a time without a break. It may otherwise overheat.

The tyre inflation compressor can be operated again once it has cooled down.

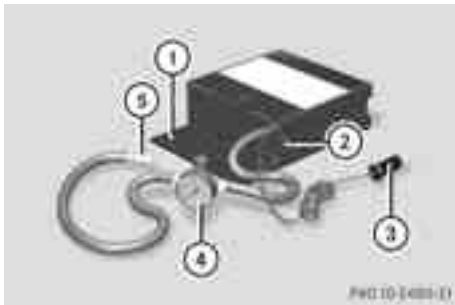

Version 1

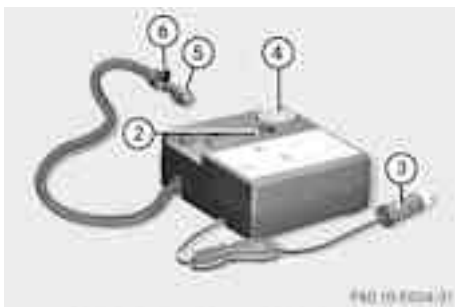

Version 2

Your vehicle is equipped with one of two tyre inflation compressors. The following description applies to both versions. Differences in the way they are used will be explained in detail.

The tyre inflation compressors differ as follows:

- **Version 1:** tyre inflation compressor with a pressure gauge on the air hose
 - **Version 2:** tyre inflation compressor with an integrated pressure gauge
- ▶ Fit the collapsible emergency spare wheel as described in the "Collapsible spare tyre" chapter (▷ page 321).
The collapsible emergency spare wheel must be fitted before it is inflated.
 - ▶ **Version 1:** open flap ①.
 - ▶ **Version 1:** pull plug ③ and the air hose with pressure gauge ④ out of the housing.
 - ▶ **Version 2:** pull plug ③ and the air hose out of the housing.
 - ▶ **Version 1:** make sure that the pressure release screw on pressure gauge ④ is closed.
 - ▶ Remove the cap from the valve on the collapsible emergency spare wheel.
 - ▶ Screw union nut ① on the air hose onto the valve.
 - ▶ Make sure on/off switch ⑤ of the tyre inflation compressor is set to **0**.
 - ▶ Insert plug ③ into the socket in the footwell of the second row of seats (▷ page 265).

Only operate the tyre inflation compressor using the socket in the footwell of the second row of seats (▷ page 265), even if the ignition is turned off.

An emergency cut-off ensures that the on-board voltage does not drop too low. If the on-board voltage is too low, the power to the sockets is automatically cut. This ensures that there is sufficient power to start the engine.

- ▶ Turn the key to position **1** in the ignition lock (▷ page 145).

- ▶ Press on/off switch ② on the tyre inflation compressor to **I**.
The tyre inflation compressor is switched on. The tyre is inflated. The tyre pressure is shown on pressure gauge ④.
- ▶ Pump the tyre to the specified tyre pressure.
The specified tyre pressure is printed on the yellow label of the emergency spare wheel.
- ▶ When the specified tyre pressure has been reached, press on/off switch ② on the electric air pump to **0**.
The tyre inflation compressor is switched off.
- ▶ Turn the key to position **0** in the ignition lock.
- ▶ **Version 1:** if the tyre pressure is higher than specified, open the pressure release screw on pressure gauge ④ until the correct tyre pressure is set.
- ▶ **Version 2:** if the tyre pressure is higher than specified, press pressure release button ⑥ until the correct tyre pressure is set.
- ▶ Unscrew union nut ⑤ on the air hose from the valve.
- ▶ Screw the valve cap onto the collapsible emergency spare wheel valve again.
- ▶ **Version 1:** stow plug ③ and the air hose behind flap ①.
- ▶ **Version 2:** stow plug ③ and the air hose in the lower section of the compressor housing.
- ▶ Stow the tyre inflation compressor in the vehicle.

Stowing the emergency spare wheel

- ❗ Only place the collapsible emergency spare wheel in the vehicle when it is dry. Otherwise, moisture may get into the vehicle.

Take the following steps to stow a used collapsible emergency spare wheel. It will not

otherwise fit into the spare wheel well. Mercedes-Benz recommends that you have this work performed at a qualified specialist workshop, e.g. at a Mercedes-Benz Service Centre.

- ▶ Unscrew the valve cap from the valve.
- ▶ If possible, unscrew the valve insert from the valve and release the air.
- ▶ Fully deflating the tyre may take a few minutes.
- ▶ Screw the valve insert back into the valve.
- ▶ Screw the valve cap back on.
- ▶ Remove the warning triangle from the emergency spare wheel well (▷ page 292).

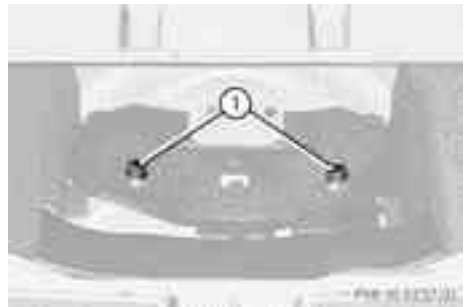

① Guides

② Collapsible emergency spare wheel

In the spare wheel well, there are two guides ① to keep the collapsible emergency spare wheel in place.

- ▶ Lay collapsible emergency spare wheel ② in the emergency spare wheel well.
- ▶ **i** Make sure that collapsible emergency spare wheel ② is positioned on guides ① precisely.
- ▶ Lay the warning triangle in the emergency spare wheel well.
- ▶ Lay the tool holder in collapsible emergency spare wheel ② so that the tyre inflation compressor is pointing towards the tailgate (▷ page 293).
- ▶ Turn tool holder approximately 180° so that the tyre inflation compressor points forwards.
The tool holder should now be positioned in accordance with the instructions on the installation position.
- ▶ Turn the retainer screw on the collapsible emergency spare wheel clockwise into the tool holder as far as it will go.
- ▶ Stow the jack in the vehicle tool kit.

Technical data**All vehicles (except R 350 BlueTEC 4MATIC and R 500 4MATIC)****Collapsible emergency spare wheel**

Tyres	Light-alloy wheels
195/75 – 18 106 P Tyre pressure: 300 kPa (3.0 bar/44 psi)	6.5 B x 18 H2 ET 40
185/65 – 19 104 P Tyre pressure: 350 kPa (3.5 bar/51 psi)	5.5 B x 18 H2 ET 13

- i** The R 350 BlueTEC 4MATIC model is not equipped with a collapsible emergency spare wheel.

R 500 4MATIC**Collapsible emergency spare wheel**

Tyres	Light-alloy wheels
185/65 – 19 104 P Tyre pressure: 350 kPa (3.5 bar/51 psi)	5.5 B x 18 H2 ET 13

- i** The R 350 BlueTEC 4MATIC model is not equipped with a collapsible emergency spare wheel.

Useful information	336
Information on technical data	336
Genuine Mercedes-Benz parts	336
Vehicle electronics	337
Identification plates	338
Service products and capacities	339
Vehicle data	346
Trailer tow hitch	347
24 GHz radar sensor system	349

Useful information

- i** This Owner's Manual describes all models, series and optional equipment for your vehicle that were available at the time of going to press. National variations are possible. Note that your vehicle may not be equipped with all of the functions described. This is also the case for systems and functions relevant to safety.
- i** Read the information on qualified specialist workshops: (▷ page 23).

Information on technical data

You can find current technical data on the Internet at:
<http://www.mercedes-benz.com>

- i** The technical data was determined in accordance with EC Directives. All data applies to the vehicle's standard equipment. The data may therefore differ for vehicles with optional equipment. You can obtain further information from a Mercedes-Benz Service Centre.

Genuine Mercedes-Benz parts

WARNING

Driving safety may be impaired if non-approved parts, tyres and wheels or safety-relevant accessories are used.

This could lead to malfunctions in safety-relevant systems, e.g. the brake system. This could cause you to lose control of your vehicle and cause an accident.

For this reason, Mercedes-Benz recommends that you use genuine Mercedes-Benz parts or parts of equal quality. Only use tyres, wheels and accessories that have been specifically approved for your vehicle.

Environmental note

Daimler AG also supplies reconditioned assemblies and parts which are of the same quality as new parts. For these, the same warranty applies as for new parts.

- !** Airbags and seat belt tensioners, as well as control units and sensors for these restraint systems, may be installed in the following areas of your vehicle:

- doors
- door pillars
- door sills
- seats
- dashboard
- instrument cluster
- centre console

Do not install accessories such as audio systems in these areas. Do not carry out repairs or welding. You could impair the operating efficiency of the restraint systems.

Have accessories retrofitted at a qualified specialist workshop.

Mercedes-Benz tests genuine parts and conversion parts and accessories that have been specifically approved for your vehicle for their reliability, safety and suitability. Despite ongoing market research, Mercedes-Benz is unable to assess other parts. Mercedes-Benz accepts no responsibility for the use of parts that have been independently or officially approved.

In Germany, certain parts are only officially approved for installation or modification if they comply with legal requirements. This also applies to some other countries. All genuine Mercedes-Benz parts meet the approval requirements. The use of non-approved parts may invalidate the vehicle's general operating permit.

This is the case:

- if they cause a change of the vehicle type from that for which the vehicle's general operating permit was granted
- if other road users could be endangered
- if the emission or noise levels are adversely affected.

Always specify the vehicle identification number (VIN) (> page 338) and the engine number (> page 339) when ordering genuine Mercedes-Benz parts.

Vehicle electronics

Tampering with the engine electronics

WARNING

Always have work on the engine electronics and related components carried out at a qualified specialist workshop. Otherwise, the vehicle's operating safety could be affected.

- ❗ Only have work carried out on the engine electronics and its associated parts, such as control units, sensors and connector leads, at a qualified specialist workshop. Vehicle components may otherwise wear more quickly and the vehicle's operating permit may be invalidated.

Retrofitting two-way radios and mobile phones (RF transmitters)

WARNING

Incorrect retrofitting of RF transmitters can cause the vehicle electronics to malfunction. The vehicle's operating safety and thus your own safety are impaired.

Have aftermarket radio frequency transmitting equipment installed at a qualified specialist workshop.

WARNING

Incorrect retrofitting of RF transmitters can lead to increased electromagnetic radiation in the vehicle interior. Using an exterior aerial takes into account current scientific discussions relating to the possible health hazards that may result from electromagnetic fields. Have aftermarket radio frequency transmitting equipment installed at a qualified specialist workshop.

- ❗ The operating permit may be invalidated if the instructions for installation and use of RF transmitters are not observed.

In particular, the following conditions must be complied with:

- only approved wavebands may be used.
- the maximum permissible output in these wavebands must be complied with.
- the approved aerial positions must be complied with.

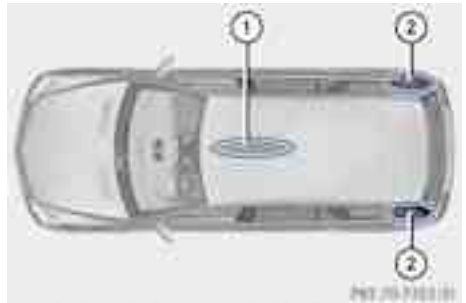

Approved aerial positions

- ① Front roof area
- ② Rear wing

- ❗ When fitting an aerial on the front roof area of vehicles with a sliding sunroof, observe the sweeping range of the roof. On vehicles with a panorama sliding sunroof, fitting an aerial on the front roof area is not permitted. On the rear wing, it is recommended to position the aerial on the side of the vehicle closest to the centre of the road.

Use the Technical Specification ISO/TS 21609 – Technical Specification for Road Vehicles – "EMC guidelines for installation of aftermarket radio frequency transmitting equipment" when retrofitting RF (radio frequency) transmitters. Comply with the legal requirements for add-on parts.

If your vehicle has fittings for two-way radio equipment, use the power supply or aerial connections intended for use with the basic wiring. Be sure to observe the manufacturer's additional instructions when installing.

Deviations with respect to wavebands, maximum transmission outputs or aerial positions must be approved by Mercedes-Benz.

The maximum transmission output (PEAK) at the base of the aerial must not exceed the following values:

Waveband	Maximum transmission output (PEAK)
Short wave (f < 54 MHz)	100 W
4 m waveband	30 W
2 m waveband	50 W
Trunked radio/Tetra	35 W
70 cm waveband	35 W
GSM/DCS/PCS 850/900/1800/1900	10 W
UMTS/LTE	10 W

The following can be used in the vehicle without restrictions:

- RF transmitters with a maximum transmission output of up to 100 mW
- mobile phones (GSM/DCS/PCS/UMTS/LTE)

There is no restriction for aerial positions in the outer area of the vehicle for the following wavebands:

- trunked radio/Tetra
- 70 cm waveband

- GSM/DCS/PCS
- UMTS/LTE

Identification plates

Vehicle identification plate with vehicle identification number (VIN)

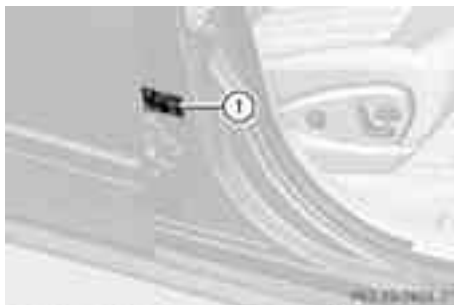

- Open the front right-hand door. You will see vehicle identification plate ①.



Example: vehicle identification plate

- ① Vehicle identification plate
- ② Vehicle manufacturer (Daimler AG)
- ③ EU type approval number (only for certain countries)
- ④ VIN
- ⑤ Maximum permissible gross vehicle weight (kg)
- ⑥ Maximum permissible mass of vehicle/trailer combination (kg)
- ⑦ Maximum permissible front axle load (kg)
- ⑧ Maximum permissible rear axle load (kg)
- ⑨ Paint code

- i** The data shown on the vehicle identification plate is example data. This data is different for every vehicle, and can deviate from the data shown here. You can find the data applicable to your vehicle on the vehicle's identification plate.

VIN

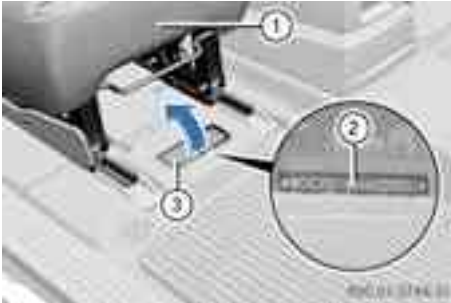

- ▶ Slide right-hand seat ① of the second row to its rearmost position.
- ▶ Fold floor covering ③ upwards. You will see VIN ②.

The VIN can also be found on the vehicle identification plate (▶ page 338).

Engine number

The engine number is stamped onto the crankcase. You can obtain further information from any qualified specialist workshop.

Service products and capacities

Important safety notes

⚠ WARNING

When handling, storing and disposing of any service products, please observe the relevant regulations, as you could otherwise endanger yourself and others.

Keep service products away from children.

To protect your health, do not allow service products to come into contact with your eyes

or open wounds. See a doctor immediately if any service product is swallowed.

♻ Environmental note

Dispose of service products in an environmentally-responsible manner.

Service products include the following:

- fuels (e.g. petrol, diesel)
- exhaust gas aftertreatment additives, e.g. AdBlue®
- lubricants (e.g. engine oil, transmission oil)
- coolant
- brake fluid
- windscreen washer fluid
- climate control system refrigerant

Components and service products must be matched. Mercedes-Benz recommends that you use products tested and approved by Mercedes-Benz. They are listed in this Mercedes-Benz Owner's Manual in the appropriate section.

You can identify service products approved by Mercedes-Benz by the following inscriptions on the container:

- MB Freigabe (e.g. MB Freigabe 229.51)
- MB Approval (e.g. MB Approval 229.51)

Other designations or recommendations indicate a level of quality or a specification in accordance with an MB Sheet Number (e.g. MB 229.5). They have not necessarily been approved by Mercedes-Benz.

Further information can be obtained from any Mercedes-Benz Service Centre or on the Internet at <http://bevo.mercedes-benz.com>.

Fuel

Important safety notes

⚠ WARNING

Fuel is highly flammable. Fire, naked flames and smoking are therefore prohibited when handling fuels.

Switch off the engine and the auxiliary heating before refuelling.

WARNING

Avoid contact with fuels.

It is hazardous to your health if your skin comes into direct contact with fuels or you breathe in fuel vapours.

Tank capacity

Total capacity	
All models	80.0 l
Of which reserve fuel	
All models	Approximately 13.0 l

Petrol (EN 228, E DIN 51626-1)

Fuel grade

! Do not use diesel to refuel vehicles with a petrol engine. Even a small quantity of diesel will damage the fuel injection system.

! Only refuel using unleaded petrol with at least 95 RON/85 MON that conforms to European standard EN 228 or E DIN 51626-1 or an equivalent specification.

Fuel with this specification may contain up to 10 % ethanol.

! Do not use the following:

- E85 (petrol with 85 % ethanol)
- E100 (100 % ethanol)
- M15 (petrol with 15 % methanol)
- M85 (petrol with 85 % methanol)
- M100 (100 % methanol)
- Petrol with metallic additives
- Diesel

Do not mix these fuels with petrol, and do not use any additives. This can otherwise lead to engine damage. This does not

include cleaning additives for the removal and prevention of residue build-up. Only cleaning additives recommended by Mercedes-Benz should be added to petrol, see "Additives". You can obtain further information from any Mercedes-Benz Service Centre.

Usually you will find information about the fuel grade on the pump. If you cannot find the label on the petrol pump, ask the filling station staff.

i E10 fuel contains up to 10 % bioethanol. Your vehicle is suitable for use with E10 fuel. You can refuel your vehicle using E10 fuel.

i If the recommended fuel is not available, but only as a temporary measure, you may also use unleaded petrol with an octane rating of 91 RON/82.5 MON. This may reduce engine performance and increase fuel consumption. Avoid driving at full throttle.

Information on refuelling (▷ page 156).

Additives

! Do not refuel with low grade fuel and do not use fuel additives that have not been tested and approved for Mercedes-Benz vehicles. Otherwise the fuel system could malfunction or be damaged.

One of the major problems with low-grade fuel is the creation of carbon deposits during the process of burning fuel. Mercedes-Benz recommends that you use fuel brands that have additives.

If you use fuels without these additives for a longer period of time, there may be a build-up of carbon deposits. These will form especially on the inlet valves and in the combustion chamber.

This could lead to engine running problems, e.g.:

- longer engine warm-up phase
- uneven idle
- engine noise

- misfiring
- loss of power

In areas where petrol with the required additives is not available, carbon deposits can build up. In this case, Mercedes-Benz recommends the use of additives that have been approved for Mercedes-Benz vehicles; see <http://bevo.mercedes-benz.com>.

The quality of the fuel available in some countries may not be sufficient. Residue could build up as a result. In such cases, and in consultation with a Mercedes-Benz Service Centre, the petrol may be mixed with the additive recommended by Mercedes-Benz (part no. A000989254510). You must observe the notes and mixing ratios specified on the container.

Consult a Mercedes-Benz Service Centre to view a list of approved products. Observe the instructions for use in the product description.

Do not mix other fuel additives with fuel. This causes unnecessary costs and could damage the engine.

Diesel (EN 590)

Fuel grade

WARNING

Do not use petrol to refuel vehicles with a diesel engine. Do not mix diesel with petrol. This would result in damage to the fuel system and engine, which could lead to a vehicle fire.

! When refuelling, only use diesel fuel that conforms to the European standard EN 590 or is of equivalent quality. Fuel that does not conform to EN 590 can lead to increased wear as well as damage to the engine and exhaust system.

! Do not use the following:

- marine diesel
- heating oil
- bio-diesel
- vegetable oil

- petrol
- paraffin
- kerosene

Do not mix such fuels with diesel fuel and do not use any special additives. This can otherwise lead to engine damage. This does not include flow improver additives. For further information, see "Flow improvers".

! **Vehicles with a diesel particle filter:** in countries outside the EU, only refuel with low-sulphur Euro diesel with a sulphur content under 50 ppm; otherwise the emission control system could be damaged.

! **Vehicles without a diesel particle filter:** in countries where only diesel fuel with a high sulphur content is available, you will need to carry out your vehicle's oil change at shorter intervals. More information about the interval for oil change can be obtained from any qualified specialist workshop.

Usually you will find information about the fuel grade on the pump. If you cannot find the label on the petrol pump, ask the filling station staff.

Information on refuelling (▷ page 156).

Low outside temperatures

In winter months, diesel fuel with an improved cold flow quality is available. In Europe, the EN 590 standard defines various climate-dependent temperature categories. Malfunctions can be avoided by refuelling with diesel fuel that corresponds to the climatic specifications outlined in EN 590. At unusually low outside temperatures, it is possible that the flow characteristics of the diesel fuel could be insufficient. Accordingly, diesel fuel from warmer areas may not be suitable for operation in colder climatic conditions.

i Further information on country-specific fuel properties can be obtained from oil companies, e.g. at filling stations.

Flow improvers

To improve the low-temperature resistance of diesel fuel, a flow improver can be attached. The effectiveness of a flow improver is not guaranteed for every fuel.

Only use flow improvers tested and approved by Mercedes-Benz. During use, please observe the information on operation.

Correct dosage and sufficient mixing are decisive in improving low-temperature resistance with the flow improver. Overdosage can potentially even decrease low-temperature resistance and must therefore be avoided. Follow the manufacturer's guidelines on dosage.

Mix the additive into the diesel in good time, before the flow characteristics of the diesel become insufficient. Otherwise, malfunctions can only be rectified by heating the entire fuel system, e.g. by parking in a heated garage.

More information about recommended flow improvers can be obtained from any qualified specialist workshop.

Fuel consumption information

Environmental note

CO₂ (carbon dioxide) is the gas which scientists believe to be principally responsible for global warming (the greenhouse effect). Your vehicle's CO₂ emissions are directly related to fuel consumption and therefore depend on:

- efficient use of the fuel by the engine
- driving style
- other non-technical factors, such as environmental influences or road conditions

You can minimise your vehicle's CO₂ emissions by driving carefully and having it serviced regularly.

The vehicle will use more fuel than usual in the following situations:

- at very low outside temperatures
- in urban traffic
- on short journeys

- in mountainous terrain
- when towing a trailer

i Only for certain countries: you can find the current consumption and emission values of your vehicle in the COC documents (EU CERTIFICATE OF CONFORMITY). These documents are delivered with your vehicle.

The consumption figures were in each case based on the currently applicable version:

- for vehicles that comply with standards up to and including the EURO 4 standard, in accordance with EU Directive 80/1268/EEC
- for vehicles that comply with or exceed the EURO 5 standard, in accordance with Regulation (EC) No. 715/2007

Deviations from these values may occur under normal operating conditions.

AdBlue®

General notes

AdBlue® is a non-flammable, non-toxic, colourless, odourless and water-soluble fluid.

High outside temperatures

WARNING

If you open the AdBlue® tank cap, small amounts of ammonia vapour may be released. This depends in particular upon the age of the AdBlue®.

Ammonia vapours have a pungent odour and are particularly irritating to:

- skin
- mucous membranes
- eyes

You may experience a burning sensation in your eyes, nose and throat, as well as coughing and watering of the eyes.

Do not inhale any ammonia vapours that may be released. Fill the AdBlue® tank only in well-ventilated areas.

Low outside temperatures

AdBlue® freezes at a temperature of approximately -11 °C. The vehicle is equipped with an AdBlue® preheating system at the factory. Winter operation can therefore be guaranteed even at temperatures below -11 °C.

Additives

! Only use AdBlue® in accordance with ISO 22241. Do not use additives with AdBlue® and do not dilute AdBlue® with water. This may destroy the BlueTEC exhaust gas after-treatment system.

Purity

! Impurities in AdBlue® (e.g. due to other service products, cleaning agents or dust) lead to:

- increased emission values
- damage to the catalytic converter
- engine damage
- malfunctions in the BlueTEC® exhaust gas aftertreatment system

Assuring the purity of AdBlue® is particularly important with respect to avoiding malfunctions in the BlueTEC exhaust gas aftertreatment system.

If AdBlue® is pumped out of the AdBlue® tank, e.g. during repair work, do not use this fluid to refill the tank. The purity of the fluid can no longer be guaranteed.

Total capacity of the AdBlue® tank

Model	Total capacity
R 350 BlueTEC 4MATIC	28.2 l

Engine oil

General notes

The quality of the engine oil is decisive for the function and service life of an engine. After extensive tests, Mercedes-Benz approves engine oils that correspond to the current technical standard.

Therefore, only Mercedes-Benz approved engine oils may be used in Mercedes-Benz engines.

Further information on tested and approved engine oils can be obtained from any Mercedes-Benz Service Centre. Mercedes-Benz recommends that you have the oil change carried out at a qualified specialist workshop. Mercedes-Benz approval is indicated on the oil container by the inscription "MB Approval" and the corresponding designation, e.g. MB Approval 229.51.

You can call up an overview of approved engine oils on the Internet at: <http://bevo.mercedes-benz.com> by entering the designation, e.g. 229.5.

The table shows which engine oils have been approved for your vehicle.

Petrol engines	MB Approval
R 350 4MATIC	229.3, 229.5
R 350 4MATIC BlueEFFICIENCY	
R 500 4MATIC	

Diesel engines with diesel particle filter	MB Approval
R 300 CDI BlueEFFICIENCY	228.51, 229.31, 229.51
C 300 CDI 4MATIC BlueEFFICIENCY	
R 350 CDI 4MATIC	
R 350 BlueTEC 4MATIC	

Diesel engines without diesel particle filter	MB Approval
R 300 CDI BlueEFFICIENCY	228.3, 228.5, 228.51, 229.3, 229.31, 229.5, 229.51
C 300 CDI 4MATIC BlueEFFICIENCY	229.31, 229.5, 229.51
R 350 CDI 4MATIC	229.51

i If the engine oils listed in the table are not available, you may add the following engine oils until the next oil change:

- vehicles with a petrol engine: MB Approval 229.1 229.3 or ACEA A3
- diesel engines: MB Approval 229.1, 229.3, 229.5 or ACEA C3

This may only be topped up once, and the quantity must not be greater than 1.0 l.

Capacities

The following values refer to an oil change including the oil filter.

Model	Replacement amount
R 350 4MATIC	8.0 l
R 350 4MATIC BlueEFFICIENCY	7.5 l
R 500 4MATIC	9.0 l
R 300 CDI BlueEFFICIENCY	8.5 l
C 300 CDI 4MATIC BlueEFFICIENCY	
R 350 CDI 4MATIC	
R 350 BlueTEC 4MATIC	

Additives

! Do not use any additives with the engine oil. This could damage the engine.

Engine oil viscosity

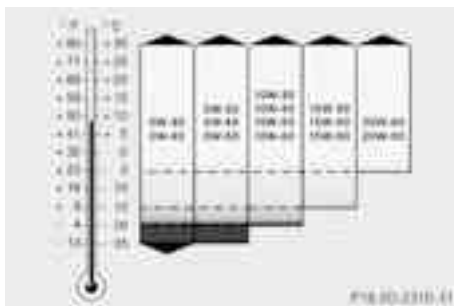

Viscosity describes the flow characteristics of a fluid. If an engine oil has a high viscosity rating, it flows slowly; the lower the viscosity, the faster it flows.

Engine oil selection is based on the respective outside temperatures and in accordance with the SAE classification (viscosity). The table shows you which SAE classifications are to be used. The low-temperature properties of engine oils can be significantly impaired during operation due to, for example, ageing or soot and fuel accretion. It is therefore strongly recommended to observe regular oil changes using an approved engine oil with the appropriate SAE classification.

Brake fluid

⚠ WARNING

Over a period of time, the brake fluid absorbs moisture from the air; This lowers its boiling point.

If the boiling point of the brake fluid is too low, vapour pockets may form in the brake system when the brakes are applied hard (e.g. when driving downhill). This impairs braking efficiency.

You should have the brake fluid renewed at regular intervals. The brake fluid change intervals can be found in the Service Booklet.

Only use brake fluid approved by Mercedes-Benz according to MB Approval 331.0.

Information about approved brake fluid can be obtained at any qualified specialist workshop or on the Internet at <http://bevo.mercedes-benz.com>.

- i** Have the brake fluid renewed regularly at a qualified specialist workshop.

Coolant

Important safety notes

WARNING

Antifreeze is highly flammable. Fire, naked flames and smoking are prohibited when handling antifreeze.

If antifreeze comes into contact with hot engine parts, it may ignite and you could burn yourself. Do not spill any antifreeze on hot engine parts.

- !** Only add coolant that has been premixed with the desired antifreeze protection. You could otherwise damage the engine. Further information on coolants can be found in the Mercedes-Benz Specifications for Service Products, MB Specifications for Service Products 310.1, e.g. on the Internet at <http://bevo.mercedes-benz.com>. Or contact a qualified specialist workshop.

- !** Always use a suitable coolant mixture, even in countries where high temperatures prevail.

Otherwise, the engine cooling system is not sufficiently protected from corrosion and overheating.

- !** The engine cooling system is filled with coolant, which must be renewed after 15 years or after 250,000 kilometres at the latest.

The coolant is a mixture of water and anti-freeze/corrosion inhibitor. It performs the following tasks:

- anti-corrosion protection
- antifreeze protection
- raising the boiling point

If antifreeze/corrosion inhibitor is present in the correct concentration, the boiling point of the coolant during operation will be around 130 °C.

The antifreeze/corrosion inhibitor concentration in the engine cooling system should:

- be at least 50%. This will protect the engine cooling system against freezing down to approximately -37 °C.
- not exceed 55% (antifreeze protection down to -45 °C). Heat will otherwise not be dissipated as effectively.

If the vehicle has lost coolant, top it up with equal amounts of water and antifreeze/corrosion inhibitor. Mercedes-Benz recommends an antifreeze/corrosion inhibitor concentrate in accordance with MB Specifications for Service Products 310.1.

The coolant is checked at every maintenance interval at a qualified specialist workshop.

- i** When the vehicle is first delivered, it is filled with a coolant mixture that ensures adequate antifreeze and corrosion protection.

Windscreen and headlamp cleaning system

Important safety notes

WARNING

Windscreen washer fluid/antifreeze is highly flammable. Avoid spilling windscreen washer fluid/antifreeze on hot engine components as it can ignite and burn. Severe burns could be the result.

- !** Only use washer fluid that is suitable for plastic lamp lenses, e.g. MB SummerFit or

MB WinterFit. Unsuitable washer fluid could damage the plastic lenses of the headlamps.

! Do not use distilled or de-ionised water in the washer fluid reservoir. Otherwise, the level sensor may be damaged.

! Only the washer fluids SummerFit and WinterFit can be mixed. Otherwise, the spraying nozzles could become blocked.

At temperatures above freezing:

► Fill the washer fluid reservoir with a mixture of water and washer fluid, e.g. MB SummerFit.

Mix 1 part MB SummerFit to 100 parts water.

At temperatures below freezing:

► Fill the washer fluid reservoir with a mixture of water and washer fluid, e.g. MB WinterFit.

Adapt the mixing ratio to the outside temperature.

- Down to -10 °C: mix 1 part MB WinterFit with 2 parts water.
- Down to -20 °C: mix 1 part MB WinterFit with 1 part water.
- Down to -29 °C: mix 2 parts MB WinterFit with 1 part water.

i Add washer fluid concentrate, e.g. MB SummerFit or MB WinterFit, to the washer fluid all year round.

Vehicle data

General notes

Please note that for the specified vehicle data:

- the heights specified may vary as a result of:
 - Tyres
 - Load
 - Condition of the suspension
 - Optional equipment
- items of optional equipment increase the unladen weight and reduce the maximum payload. The unladen weight is specified in accordance with EC directive and includes:
 - driver (68 kg)
 - luggage (7 kg)
 - all fluids (fuel tank 90% full)
- vehicle-specific weight information can be found on the vehicle identification plate (► page 338).
- only for certain countries: you can find vehicle-specific vehicle data in the COC documents (CERTIFICATE OF CONFORMITY). These documents are delivered with your vehicle.

Dimensions and weights



Model	① Opening height	② Maximum headroom
All models	2047 mm – 2074 mm	1901 mm – 1927 mm

All models	
Vehicle length, short wheelbase	4922 mm
Vehicle length, long wheelbase	5157 mm
Vehicle width including exterior mirrors	2183 mm
Vehicle width excluding exterior mirrors	1922 mm
Wheelbase, short	2980 mm
Wheelbase, long	3215 mm
Maximum roof load	100 kg

R 350 4MATIC	
Vehicle height	1677 mm
Unladen weight	2230 kg

R 350 4MATIC BlueEFFICIENCY	
Vehicle height, short wheelbase	1676 mm
Vehicle height, long wheelbase	1677 mm
Unladen weight, short wheelbase	2180 kg
Unladen weight, long wheelbase	2235 kg

R 500 4MATIC	
Vehicle height	1666 mm
Unladen weight	2265 kg

R 300 CDI BlueEFFICIENCY R 300 CDI 4MATIC BlueEFFICIENCY	
Vehicle height	1674 mm
Unladen weight	2185 kg

R 350 CDI 4MATIC	
Vehicle height, short wheelbase	1676 mm
Vehicle height, long wheelbase	1677 mm
Unladen weight, short wheelbase	2250 kg
Unladen weight, long wheelbase	2295 kg

R 350 BlueTEC 4MATIC	
Vehicle height	1675 mm
Unladen weight	2340 kg

Trailer tow hitch

Mounting dimensions

- ❗ If you have a trailer tow hitch retrofitted, changes to the cooling system may be necessary, depending on the vehicle type. If you have a trailer tow hitch retrofitted, observe the anchorage points on the chassis frame.

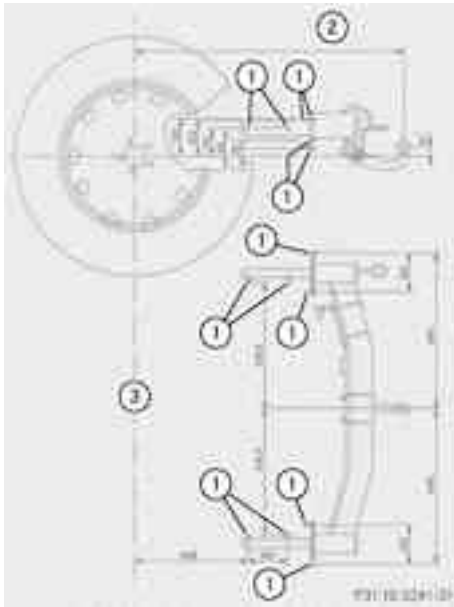

Example: anchorage points for the trailer tow hitch

- ① Anchorage points
- ② Overhang dimension
- ③ Rear axle centre line

For trailer tow hitches fitted at the factory, the overhang dimension including protective covering is 1,134 mm.

Trailer loads

	All models
Permissible trailer load, unbraked	750 kg
Permissible trailer load, braked ²⁰	2100 kg
Maximum drawbar noseweight ²¹	85 kg
Permissible rear axle load when towing a trailer	1800 kg ²²

24 GHz radar sensor system

The 24 GHz radar sensor system requires separate approval for each country. If you are driving in a country in which the radar sensor system is not approved, you must deactivate the system using the on-board computer (▷ page 204).

The current country overview can be obtained from a Mercedes-Benz Service Centre or on the Internet at: <http://www.mercedes-benz.de/betriebsanleitung>.

Vehicles with a navigation system: the radar sensor system is deactivated automatically near radio telescope facilities. A display message appears in the multifunction display to tell you that the radar sensor system is being switched off (▷ page 222).

If Blind Spot Assist is active, it will be deactivated automatically (▷ page 182).

If the deactivation does not occur automatically, you must deactivate the radar sensor system using the on-board computer (▷ page 204).

Vehicles without navigation and vehicles for Australia: you must deactivate the radar sensor system using the on-board computer when you are near a radio telescope facility (▷ page 204).

²⁰ At a minimum gradient-climbing capability of 12 % from a standstill.

²¹ The drawbar noseweight is not included in the trailer load.

²² For the R 350 4MATIC BlueEFFICIENCY model: 1660 kg.

Publication details

Internet

Further information about Mercedes-Benz vehicles and about Daimler AG can be found on the following websites:

<http://www.mercedes-benz.com>

<http://www.daimler.com>

Editorial office

You are welcome to forward any queries or suggestions you may have regarding this Owner's Manual to the technical documentation team at the following address:

Daimler AG, HPC: R822,

D-70546 Stuttgart, Germany

Not to be reprinted, translated or otherwise reproduced, in whole or in part, without written permission of Daimler AG.

As at 07.11.2011

Nur für internen Gebrauch / For internal use only



2515845982Z102

Order no. 6515 1850 02 Part no. 251 584 59 82 Z102 Edition ÄJ 2012-1a

Nur für internen Gebrauch / For internal use only