



Mercedes-Benz

GLK

Operator's Manual

Symbols

Registered trademarks:

- BabySmart™ is a registered trademark of the Siemens Automotive Corp.
- Bluetooth® is a registered trademark of the Bluetooth SIG Inc.
- ESP® is a registered trademark of Daimler AG.
- HomeLink® is a registered trademark of Prince, a Johnson Controls Company.
- Logic 7® is a registered trademark of Harman International Industries, Incorporated.
- Microsoft® a registered trademark of the Microsoft Corporation in the USA and in other countries.
- SIRIUS and related brands are registered trademarks of SIRIUS XM Radio Inc.
- Windows Media® is a registered trademark of the Microsoft Corporation in the USA and in other countries.

In this Operator's Manual you will find the following symbols:

Warning

Warning notices draw your attention to hazards that endanger your health or life, or the health or life of others.

 Warning notices draw your attention to hazards that could cause damage to your vehicle.

 Practical tips or other information that could be helpful to you.

▶ This symbol indicates instructions that you must follow.

▶ A number of these symbols appearing in succession indicates instructions with several steps.

▷ page This symbol tells you where to look for further information on a topic.

▷▷ This symbol marks a warning or procedure which is continued on the next page.

Display Text in the multifunction display/COMAND display.

Welcome to the world of Mercedes-Benz

Before you drive off, please familiarize yourself with your vehicle and read this manual, especially the safety and warning notices. This will help you to obtain the maximum pleasure from your vehicle and to avoid endangering yourself and others.

The equipment or product designation of your vehicle may vary depending on:

- model
- order
- country specification
- availability

Mercedes-Benz is constantly updating its vehicles to the state of the art.

Mercedes-Benz therefore reserves the right to introduce changes in the following areas:

- design
- equipment
- technical features

You cannot therefore base any claims on the data, illustrations or descriptions contained in this manual.

The following are integral parts of the vehicle:

- Operator's Manual
- Brief Instructions¹
- Service Booklet
- Supplements relating to vehicle equipment

Keep these documents in the vehicle at all times. When you sell the vehicle, always pass the documents on to the new owner.

The technical documentation team at Daimler AG wishes you safe and pleasant motoring.

Mercedes-Benz USA, LLC

Mercedes-Benz Canada, Inc.

A Daimler Company

¹ Canada only.

Index	4	At a glance	23
Introduction	17	Safety	33
		Opening and closing	67
		Seats, steering wheel and mirrors	89
		Lights and windshield wipers	101
		Climate control	117
		Driving and parking	127
		On-board computer and displays	161
		Loading, stowing and features	205
		Maintenance and care	231
		Roadside Assistance	243
		Tires and wheels	263
		Technical data	291

- 1, 2, 3 ...**
- 115 V socket** 218
- 12 V socket** 217
- 4ETS**
see ETS/4ETS
- 4MATIC (permanent four-wheel drive)** 156
- A**
- ABS (Anti-lock Braking System)**
Display message 181
Function/notes 62
Warning lamp 197
- Accident (notes)** 245
- Active light function (display message)** 186
- Active service system**
see Service interval display
- Air bags**
Display message 179
Front air bag (driver, front passenger) 37
Important safety notes 36
Knee bag 38
PASSENGER AIRBAG OFF indicator lamp (only Canada) 46
PASSENGER AIRBAG OFF indicator lamp (only USA) 41
Pelvis air bag 40
Safety guidelines 35
Side impact air bag 39
Window curtain air bag 41
- Air-conditioning system**
see Climate control
- Air dehumidification**
Activating/deactivating with cooling 120
- Air distribution**
Setting 121
- Airflow**
Setting 122
- Air nozzles**
see Air vents 124
- Air pressure**
see Tire pressure
- Air-recirculation mode**
Activating/deactivating 123
- Air vents** 124
Glove box 125
Important safety information 124
Rear 125
Setting the center air vents 124
Setting the side air vents 124
- Alarm system**
see ATA
- Anti-lock Braking System**
see ABS
- Anti-Theft Alarm system**
see ATA
- Anti-theft system**
ATA (Anti-Theft Alarm system) 65
- Ashtray** 215
- ATA (Anti-Theft Alarm system)**
Activating/deactivating 65
Function 65
Switching off the alarm 65
- Audio menu (on-board computer)** 168
- AUTO lights**
see Light sensor
- Automatic car wash** 237
- Automatic transmission**
Display message 192
Driving tips 136
Emergency running mode 139
Kickdown 136
Malfunction 139
Program selector button 137
Pulling away 131
Releasing the parking lock manually 139
Selector lever 134
Starting 131
Trailer towing 136
- B**
- Backrest (display message)** 193
- Bag hook** 210
- BAS (Brake Assist System)** 62
- Battery**
Charging 254
Checking (SmartKey) 72
Display message 188

- Important safety guidelines (SmartKey) 72
 - Jump-starting 256
 - Replacing (SmartKey) 72
 - Safety notes 253
 - Belt**
 - see Seat belts
 - Brake fluid**
 - Notes 298
 - Brake fluid level** 236
 - Brake lamp (display message)** 184
 - Brakes**
 - ABS 62
 - BAS 62
 - Brake fluid (notes) 298
 - Display message 182
 - Important safety notes 145
 - Maintenance 146
 - Parking brake 143, 147
 - Warning lamp 195
 - Breakdown**
 - see Accident (notes)
 - see Flat tire
 - Bulbs**
 - Backup lamp 112
 - Brake lamp 112
 - High-beam headlamps 110
 - License plate lamp 113
 - Low-beam headlamps 110
 - Overview 108
 - Parking lamps 111
 - Rear fog lamp 112
 - Replacing 112
 - Standing lamps (front) 111
 - Tail lamp 112
 - Turn signal lamp 112
 - Turn signals (front) 111
- C**
- CAC**
 - (Customer Assistance Center) 20
 - California**
 - Important notice for retail customers and lessees 18
 - Calling up a malfunction**
 - see Display messages
 - Capacities**
 - see Technical data
 - Care**
 - Carpets 242
 - Car wash 237
 - Display 241
 - Gear or selector lever 241
 - Headlamps 240
 - Notes 237
 - Paint 239
 - Plastic trim 241
 - Power washer 238
 - Rear view camera 240
 - Roof lining 242
 - Seat belt 242
 - Seat covers 242
 - Sensors 240
 - Steering wheel 241
 - Tail pipes 241
 - Trim strips 241
 - Washing by hand 238
 - Wheels 238
 - Windows 239
 - Wiper blades 239
 - Wooden trim 241
 - Cargo compartment cover** 210
 - Cargo compartment enlargement** ... 208
 - Cargo compartment floor**
 - Opening/closing 212
 - Stowage well (under) 212
 - Cargo net**
 - Attaching 211
 - Important safety information 211
 - Cargo tie down rings** 209
 - CD player/CD changer (on-board computer)** 169
 - Center console** 29
 - Central locking**
 - Automatic locking (on-board computer) 173
 - SmartKey 68
 - Changing bulbs**
 - Headlamps 107
 - Changing gears** 136
 - Changing the programming**
 - SmartKey 71
 - Child-proof locks**
 - Rear doors 60

- Children**
 - In the vehicle 55
 - Restraint systems 56
 - Child seat**
 - Automatic recognition 46
 - Automatic recognition/air bag deactivation, self-test 48
 - Display message 177
 - LATCH-type (ISOFIX) child seat anchors 58
 - Special seat belt retractor 58
 - Top Tether 59
 - Troubleshooting 49
 - Cigarette lighter** 216
 - Classification system for occupants (OCS)**
 - Faults 45
 - Operation 41
 - System self-test 44
 - Climate control**
 - Activating/deactivating 120
 - Activating/deactivating air-recirculation mode 123
 - Controlling automatically 121
 - Cooling with air dehumidification . . 120
 - Defrosting the windshield 122
 - Demisting the windows 123
 - Dual-zone automatic climate control 119
 - Important safety information 118
 - Indicator lamp 121
 - Maximum cooling 122
 - Problems with "cooling with air dehumidification" 121
 - Problems with the rear window heating 123
 - Refrigerant 298
 - Setting the air distribution 121
 - Setting the airflow 122
 - Setting the air vents 124
 - Setting the temperature 121
 - Switching the MONO function on/off 122
 - Switching the rear window heating on/off 123
 - Clock (on-board computer)** 171
 - Coat hooks** 212
 - Cockpit** 25
 - Collapsible spare wheel**
 - Inflating 251
 - see Emergency spare wheel
 - Combination switch** 104
 - Compass** 227
 - Consumption statistics (on-board computer)** 166
 - Convenience closing feature** 83
 - Convenience opening feature** 83
 - Coolant (engine)**
 - Checking the level 234
 - Display message 186
 - Notes 298
 - Temperature gauge 162
 - Warning lamp 201
 - Cooling**
 - see Climate control
 - Cornering light (display message) ...** 183
 - Crash-responsive emergency lighting** 107
 - Cruise control**
 - Cruise control lever 150
 - Display message 189
 - Function/notes 149
 - Cup holder** 214
 - Center console 214
 - Rear compartment 214
 - Current fuel consumption (on-board computer)** 166
 - Customer Assistance Center (CAC)** 20
 - Customer Relations Department** 21
- D**
- Dashboard**
 - see Cockpit
 - Date (on-board computer)** 171
 - Daytime running lamps**
 - Display message 186
 - Switching on/off (on-board computer) 172
 - Delayed switch-off**
 - Exterior lighting (on-board computer) 172
 - Interior lighting (on-board computer) 173
 - Digital speedometer** 166

- Display (cleaning instructions)** 241
 - Display messages**
 - Brakes 181
 - Calling up (on-board computer) 175
 - Clearing (on-board computer) 175
 - Driving systems 189
 - Engine 186
 - KEYLESS-GO 194
 - Lamps 186
 - Safety systems 176
 - Service interval display 236
 - SmartKey 193
 - Tires 189
 - Vehicle 192
 - Distance recorder** 166
 - Door**
 - Automatic locking 76
 - Automatic locking (on-board computer) 173
 - Display message 192
 - Emergency locking 77
 - Emergency unlocking 77
 - Opening (from inside) 76
 - Door control panel**
 - Overview 31
 - Doors**
 - Important safety notes 75
 - Drinking and driving** 144
 - Drinks holder**
 - see Cup holder
 - Drive program**
 - Automatic 137
 - Drive program display** 135
 - Driving abroad** 149
 - Driving on flooded roads** 147
 - Driving safety system**
 - EBD (Electronic Brake force Distribution) 65
 - ESP[®] (Electronic Stability Program) 63
 - ETS/4ETS (Electronic Traction System) 63
 - Important safety information 61
 - Driving safety systems**
 - ABS (Anti-lock Braking System) 62
 - BAS (Brake Assist System) 62
 - Overview 61
 - Driving systems**
 - Cruise control 149
 - PARKTRONIC 151
 - Rear view camera 154
 - Driving tips** 136
 - Downhill gradients 145
 - Driving on flooded roads 147
 - Towing a trailer 156
 - Wet road surface 146
 - Winter 149
 - DVD audio (on-board computer)** 169
- E**
- EASY-ENTRY feature** 96
 - Activating/deactivating (on-board computer) 173
 - EASY-EXIT feature** 96
 - Activating/deactivating (on-board computer) 173
 - Crash-responsive 97
 - EBD (Electronic Brake force Distribution)**
 - Display message 182
 - Function/notes 65
 - Electrical fuses**
 - see Fuses
 - Electronic Brake force**
 - see EBD
 - Electronic Stability Program**
 - see ESP[®]
 - Electronic Traction System**
 - see ETS/4ETS
 - Emergency call**
 - see mbrace
 - Emergency release**
 - Fuel filler flap 141
 - Vehicle 77
 - Emergency running mode**
 - Automatic transmission 139
 - Emergency spare wheel**
 - Storage location 246
 - Stowing 246
 - Emergency tensioning device**
 - Function 54
 - Safety guidelines 35
 - Emergency unlocking**
 - Tailgate 81

- Emissions purification**
 - Service and warranty information 17
 - Engine**
 - Irregular running 133
 - Starting problems 133
 - Starting the engine with the key 131
 - Starting with KEYLESS-GO 131
 - Switching off 142
 - Warning lamp Check Engine 200
 - Engine electronics**
 - Malfunction 133
 - Engine number** 294
 - Engine oil**
 - Adding 234
 - Checking the oil level 233
 - Display message 188
 - Lubricant additives 297
 - Notes about oil grades 297
 - Viscosity 297
 - ESC (Electronic Stability Control)**
 - see ESP®
 - ESP® (Electronic Stability Program)**
 - Activating/deactivating 63
 - Display message 176
 - ETS/4ETS 63
 - Important safety information 63
 - Trailer stabilization 64
 - Warning lamp 198
 - ETS/4ETS (Electronic Traction System)** 63
 - Exhaust check** 145
 - Exhaust tail pipe (cleaning instructions)** 241
 - Exterior lighting**
 - see Lights
 - Exterior mirrors**
 - Adjusting 97
 - Dipping (automatic) 98
 - Folding in/out (automatically) 98
 - Folding in/out (electrically) 98
 - Folding in when locking (on-board computer) 174
 - Out of position 98
 - Setting 98
 - Storing settings (memory function) 100
 - Storing the parking position 99
 - Exterior view** 24
- F**
- First-aid kit** 245
 - Flat tire**
 - Changing a wheel/mounting the spare wheel 247
 - Preparing the vehicle 247
 - Raising the vehicle 248
 - Floormat** 228
 - Front fog lamp (display message)** ... 185
 - Fuel**
 - Additives 296
 - Notes 296
 - Premium-grade unleaded gasoline . 296
 - Refueling 140
 - Specifications 296
 - Troubleshooting 142
 - Fuel consumption**
 - Current (on-board computer) 166
 - Notes 144
 - Fuel filler cap (display message)** 189
 - Fuel filler flap**
 - Emergency release 141
 - Opening/closing 140
 - Fuel level**
 - Calling up the range (on-board computer) 166
 - Fuses**
 - Dashboard fuse box 261
 - Fuse allocation chart 261
 - Fuse box in the cargo compartment 262
 - Fuse box in the engine compartment 261
 - Notes 260
- G**
- Garage door opener**
 - Clearing the memory 227
 - Notes 224

Opening/closing the garage door ..	227
Programming the remote control ...	225
Gear or selector lever (cleaning guidelines)	241
Genuine Mercedes-Benz parts	292
Genuine wood trim and trim strips (cleaning instructions)	241
Glove box	207
GTW (Gross Trailer Weight) (definition)	285

H

Headlamp cleaning system	105
Adding washer fluid	235
Notes	299
Headlamp mode (daytime driving) see Daytime running lamps	
Headlamps	
Cleaning	240
Misting up	106
Removing/installing the cover	109
Head restraints	
Adjusting (electrically)	93
Adjusting (manually)	93
Adjusting (rear)	93
Installing/removing (rear)	94
see NECK-PRO head restraints	
Heating see Climate control	
High beam flasher	105
Hill start assist	132
Hood	
Closing	233
Display message	192
Opening	232
Hydroplaning	147

I

Immobilizer	65
Instrument cluster	
Overview	26
Submenu (on-board computer)	171
Warning and indicator lamps	27
Instrument cluster lighting	26
Instrument lighting see Instrument cluster lighting	

Interior lighting

Automatic control	107
Delayed switch-off (on-board computer)	173
Emergency lighting	107
Manual control	107
Reading lamp	106

J

Jack

Storage location	245
Using	248

Jump-starting

256

K

KEYLESS-GO

Button	129
Convenience closing feature	84
Display message	194
Locking	69
Starting the engine	131
Unlocking	69

Key positions

KEYLESS-GO	129
SmartKey	129

Kickdown

136

Knee bag

38

L

LATCH-type (ISOFIX) child seat

anchors

58

License plate lamp (display

message)

185

Lights

Activating/deactivating the interior lighting delayed switch-off (on-board computer)	173
Active light function	105
Automatic headlamp mode	103
Cornering light function	106
Daytime running lamps	103
Driving abroad	102
Fog lamps	104
Hazard warning lamps	105
High-beam headlamps	104
Light switch	102

Low-beam headlamps	103
Rear fog lamp	104
Switching the daytime driving lights on/off (on-board computer) .	172
Switching the exterior lighting delayed switch-off on/off (on-board computer)	172
Switching the surround lighting on/off (on-board computer)	172
Light sensor (display message)	186
Loading guidelines	206
Locking	
Automatic	76
Emergency locking	77
From inside the vehicle (central locking button)	76
Locking verification signal (on-board computer)	173
Low-beam headlamp (display message)	183
Luggage net	208
Lumbar support	94
4-way lumbar support	94

M

M+S tires	148
Main-beam headlamps (display message)	184
Malfunction message	
see Display messages	
Malfunctions relevant to safety	
Reporting	21
mbrace	
Call priority	223
Display message	177
Downloading destinations (COMAND)	223
Emergency call	220
Important safety notes	219
Locating a stolen vehicle	224
MB info call button	222
Remote vehicle locking	224
Roadside Assistance button	221
Self-test	219
System	219
Vehicle remote unlocking	223

Mechanical key

Function/notes	71
Memory card (on-board computer) .	169
Memory function	100
Menu (on-board computer)	
Audio	168
DVD	169
Navigation	167
Overview of menus	165
Service	170
Settings	171
Telephone	169
Trip	166
Message memory	175

Messages

 see Display messages

Mirrors

Sun visor	215
see Exterior mirrors or Rear-view mirror	

MP3

Operating (on-board computer)	169
see separate operating instructions	

Multifunction display

Multifunction steering wheel

Operating the on-board computer .	163
Overview	28

N

Navigation

On-board computer	167
see separate operating instructions	

NECK-PRO head restraints

Operation	49
Resetting after being triggered	50

Notes on breaking-in a new vehicle

.....	128
-------	-----

O

Occupant Classification System (OCS)

Faults	45
Operation	41
System self-test	44

Occupant safety

Children in the vehicle	55
System overview	34

- Octane number (fuel)** 296
- Odometer** 166
- Off-road**
- 4MATIC 156
- Oil**
- see Engine oil
- On-board computer**
- Audio menu 168
 - Convenience submenu 173
 - Display messages 175
 - Factory settings 174
 - Important safety notes 162
 - Instrument cluster submenu 171
 - Lighting submenu 172
 - Message memory 175
 - Navigation menu 167
 - Operating video DVD 169
 - Operation 163
 - Overview of menus 165
 - Service menu 170
 - Settings menu 171
 - Standard display submenu 166
 - Telephone menu 169
 - Time/Date submenu 171
 - Trip menu 166
 - Vehicle submenu 173
- Opening and closing the side trim panels** 112
- Operating system**
- see On-board computer
- Outside temperature**
- Display 163
- Overhead control panel**
- Overview 30
- Override feature**
- Rear side windows 60
- P**
- Paint code number** 293
- Paintwork (cleaning instructions)** ... 239
- Panic alarm** 61
- Panorama roof with power tilt/sliding panel**
- Opening/closing 86
 - Resetting 87
- Parking** 142
- Parking aid**
- PARKTRONIC 151
 - Rear view camera 154
- Parking brake** 143
- Parking lamp (display message)** 185
- Parking lock**
- Releasing manually (automatic transmission) 139
- Parking position**
- Exterior mirror on the front-passenger side 99
- PARKTRONIC**
- Activating/deactivating 153
 - Function/notes 151
 - Malfunction 154
 - Problem 154
 - Range of the sensors 152
 - Trailer towing 153
 - Warning display 152
- PASSENGER AIRBAG OFF indicator lamp (only Canada)** 46
- PASSENGER AIRBAG OFF indicator lamp (only USA)** 41
- Pedals** 144
- Permanent display (on-board computer)** 171
- Permanent four-wheel drive**
- see 4MATIC
- Plastic trim (cleaning instructions)** . 241
- Power supply (trailer)** 159
- Power washers** 238
- Power windows**
- see Side windows
- Product information** 17
- Program selector button** 137
- Pulling away**
- Automatic transmission 131
- R**
- Radio**
- Changing stations (on-board computer) 168
 - see separate operating instructions
- Range (on-board computer)** 166
- Rear compartment**
- Setting the airflow 122
 - Setting the air vents 125

Rear fog lamp (display message)	185
Rear seat backrest	
Display message	193
Rear seat backrest (display message)	193
Rear view camera	
Function/notes	154
Rear view camera (cleaning instructions)	240
Rear-view mirror	
Anti-glare (manual)	97
Dipping (automatic)	98
Rear window heating	
Malfunction	123
Switching on/off	123
Rear window wiper	114
Replacing the wiper blade	115
Refueling	140
Remote control	
Programming (garage door opener)	225
Reporting	
Malfunctions relevant to safety	21
Reserve fuel	
Display message	189
Warning lamp	200
Restraint systems	
see SRS	
Reversing lamp (display message) ..	185
Roadside Assistance (breakdown)	18
Roller blind	
see Roller sunblind	
Roller sunblind	
Opening/closing	87
Panorama roof with power tilt/ sliding panel	86
Roof carrier	213, 214
Roof lining and carpets (cleaning guidelines)	242
Route	
see Route guidance (on-board computer)	
Route guidance (on-board computer)	167

S

Safety

Children in the vehicle	55
Child restraint systems	56
Occupant Classification System (OCS)	41
Overview of occupant safety systems	34

Safety systems

 see Driving safety systems

Seat backrest (rear)

Folding forwards/back	208
-----------------------------	-----

Seat belts

Adjusting the height	53
Belt force limiters	54
center rear-compartment seat	53
Cleaning	242
Correct usage	51
Emergency Tensioning Devices	54
Fastening	52
Important safety guidelines	50
Releasing	54
Safety guidelines	35
Special seat belt retractor	58
Warning lamp	196
Warning lamp (function)	54

Seat heating

Indicator lamp (Malfunction)	95
------------------------------------	----

Seats

Adjusting (electrically)	92
Adjusting the 4-way lumbar support	94
Adjusting the head restraint	93
Adjusting the lumbar support	94
Cleaning the cover	242
Correct driver's seat position	90
Important safety notes	91
Storing settings (memory function)	100
Switching seat heating on/off	95

Sensors (cleaning instructions)**Service indicator**

 see Service interval display

Service interval display

Displaying a service message (on-board computer)	237
--	-----

Service menu (on-board computer) .

170

- Service products**
- Brake fluid 298
 - Capacities 295
 - Coolant (engine) 298
 - Engine oil 297
 - Fuel 296
 - Important safety notes 294
 - Notes 294
 - Refrigerant (air-conditioning system) 298
 - Washer fluid 299
- Settings**
- Factory (on-board computer) 174
 - On-board computer 171
- Shift ranges** 137
- Side impact air bag** 39
- Side marker lamp (display message)** 185
- Side windows**
- Convenience closing feature 83
 - Convenience opening feature 83
 - Important safety information 81
 - Opening/closing 82
 - Resetting 84
 - Troubleshooting 84
- Sliding sunroof**
- Important safety information 85
 - Troubleshooting 88
 - see Panorama roof with power tilt/sliding panel
- SmartKey**
- Changing the battery 72
 - Changing the programming 71
 - Checking the battery 68, 72
 - Convenience closing feature 83
 - Convenience opening feature 83
 - Display message 193
 - Important safety notes 68
 - Malfunction 74
 - Starting the engine 131
- Snow chains** 148
- Socket** 217
- Dashboard 217
 - Luggage compartment 217
 - Rear compartment 217
- SOS**
- see mbrace
- Spare wheel**
- Notes/data 289
 - Storage location 246
 - Stowing 246
 - see Emergency spare wheel
- Speedometer**
- Additional speedometer (on-board computer) 166
 - Segments 163
 - Setting the unit (on-board computer) 171
- SRS (Supplemental Restraint System)**
- Display message 177
 - Introduction 34
 - Warning lamp 199
 - Warning lamp (function) 34
- Standard display (on-board computer)** 166
- Starting the engine**
- Important safety notes 130
- Station**
- see Radio
- Steering (display message)** 193
- Steering wheel**
- Adjusting (electrically) 96
 - Adjusting (manually) 96
 - Buttons (on-board computer) 163
 - Cleaning 241
 - Important safety notes 95
 - Memory function (storing settings) 96
 - Storing settings (memory function) 100
- Stowage compartments**
- Armrest (under) 207
 - Glove box 207
- Stowage space**
- Cup holders 214
 - Important safety information 206
- Submenu (on-board computer)**
- Convenience 173
 - Factory setting 174
 - Instrument cluster 171
 - Lights 172
 - Standard display 166
 - Time/Date 171
 - Vehicle 173

- Summer opening**
 - see Convenience opening feature
 - Sun visor** 215
 - Supplemental Restraint System**
 - see SRS
 - Surround lighting (on-board computer)** 172
 - SUV**
 - (Sport Utility Vehicle) 19
 - Switching off the alarm (ATA)** 65
- T**
- Tachometer** 163
 - Tailgate**
 - Display message 192
 - Emergency unlocking 81
 - Limiting the opening angle 80
 - Tail lamp (display message)** 184
 - Taillight**
 - see Tail lamps
 - Tank content**
 - Fuel gauge 26
 - Technical data** 292
 - GLK 350 299
 - GLK 350 4MATIC 300
 - Tires/wheels 287
 - TELEAID**
 - Call priority 223
 - Display message 177
 - Downloading destinations (COMAND) 223
 - Emergency call 220
 - Important safety notes 219
 - Locating a stolen vehicle 224
 - MB info call button 222
 - Remote vehicle locking 224
 - Roadside Assistance button 221
 - Self-test 219
 - System 219
 - Vehicle remote unlocking 223
 - Telephone**
 - Accepting a call 170
 - Display message 193
 - Menu (on-board computer) 169
 - Number from the phone book 170
 - Redialing 170
 - Rejecting/ending a call 170
 - Telephone compartment** 207
 - Temperature**
 - Coolant 162
 - Outside temperature 163
 - Setting 121
 - Theft deterrent locking system**
 - Immobilizer 65
 - Time (on-board computer)** 171
 - Tire pressure**
 - Calling up (on-board computer) 271
 - Checking manually 269
 - Display message 189
 - Maximum 274
 - Notes 267
 - Pressure loss warning 269
 - Recommended 266
 - Tire pressure monitoring system**
 - Function/notes 271
 - Restarting 273
 - Warning lamp 202
 - Tires**
 - Aspect ratio (definition) 286
 - Average weight of the vehicle occupants (definition) 284
 - Bar (definition) 284
 - Characteristics 284
 - Checking 265
 - Cleaning 266
 - Definition of terms 284
 - Direction of rotation 278
 - Distribution of the vehicle occupants (definition) 287
 - DOT, Tire Identification Number (TIN) 283
 - DOT (Department of Transportation) (definition) 284
 - Flat tire 247
 - GAWR (Gross Axle Weight Rating) (definition) 285
 - GTW (Gross Trailer Weight) (definition) 285
 - Guidelines to be observed 265
 - GVW (Gross Vehicle Weight) (definition) 285
 - GVWR (Gross Vehicle Weight Rating) (definition) 285
 - Increased vehicle weight due to optional equipment (definition) 284

- Kilopascal (kPa) (definition) 285
- Labeling (overview) 280
- Load bearing index (definition) 286
- Load index 283
- Load index (definition) 285
- Maximum loaded vehicle weight (definition) 285
- Maximum load on a tire (definition) 286
- Maximum permissible tire pressure (definition) 285
- Maximum tire load 278
- Maximum tire load (definition) 285
- Optional equipment weight (definition) 286
- PSI (pounds per square inch) (definition) 286
- Replacing 280
- Service life 265
- Sidewall (definition) 286
- Speed index (definition) 285
- Storing 266
- Structure and characteristics (definition) 284
- Temperature 279
- TIN (Tire Identification Number) (definition) 286
- Tire bead (definition) 286
- Tire pressure (definition) 286
- Tire pressures (recommended) 284
- Tire size (data) 287
- Tire size designation, load-bearing capacity, speed index 281
- Tire tread 265
- Tire tread (definition) 286
- Total load limit (definition) 287
- Traction 279
- Traction (definition) 286
- Tread wear 279
- TWR (permissible trailer drawbar noseweight) (definition) 286
- Uniform Tire Quality Grading Standards 278
- Uniform Tire Quality Grading Standards (definition) 284
- Unladen weight (definition) 285
- Wear indicator (definition) 286
- Wheel rim (definition) 285
- Tires and wheels (important safety information)** 264
- Top Tether** 59
- Towing**
 - Important safety guidelines 258
 - Installing the towing eye 258
 - Removing the towing eye 259
- Towing a trailer**
 - Driving tips 156
- Trailer**
 - Coupling up 157
 - Decoupling 158
 - Display message 183
 - Power supply 159
 - Towing 157
- Trailer loads and drawbar noseweights** 158
- Trailer towing** 136
 - ESP® 64
 - PARKTRONIC 153
- Transfer case** 139
- Transmission position display** 135
- Transmission positions** 135
- Trip computer (on-board computer)** 166
- Trip odometer**
 - Calling up 166
 - Resetting (on-board computer) 167
- Trunk**
 - Automatic opening 78, 79
- Trunk lid**
 - Opening/closing 78
- Turn signal (display message)** 184
- Turn signals** 104
- TWR (permissible trailer drawbar noseweight) (definition)** 286
- Type plate**
 - see Vehicle identification plate

U

- Unlocking**
 - Emergency unlocking 77
 - From inside the vehicle (central unlocking button) 76

V

Vanity mirror	
Sun visor	215
Vehicle	
Data acquisition	21
Emergency unlocking	77
Equipment	17
Exterior view	24
Individual settings (on-board computer)	171
Loading	274
Lowering	252
Maintenance	18
Parking up	144
Raising	248
Reporting problems	20
Towing away	258
Tow-starting	258
Transporting	260
Vehicle data	
see Technical data	
Vehicle identification number	
see VIN	
Vehicle identification plate	293
Vehicle tool kit	245
Video (DVD)	169
Video DVD (on-board computer)	169
VIN	293

W

Warning and indicator lamps	
ABS	197
Brakes	195
Check Engine	200
Coolant	201
ESP®	198
ESP® OFF	199
Fuel tank	200
Overview	27
PASSENGER AIRBAG OFF indicator lamp (only Canada)	46
PASSENGER AIRBAG OFF indicator lamp (only USA)	41
Reserve fuel	200
Seat belt	196
SRS	199
Tire pressure monitor	202
Warranty	292
Washer fluid reservoir	
Removing/attaching	110
Wheel bolt tightening torque	252
Wheel chock	248
Wheels	
Changing/replacing	280
Changing a wheel	247
Checking	265
Cleaning	238
Guidelines to be observed	265
Mounting a wheel	250
Removing a wheel	250
Tightening torque	252
Wheel size/tire size	287
Window curtain air bag	
Display message	178
Operation	41
Windows	
see Side windows	
Windows (cleaning instructions)	239
Windshield	
Defrosting	122
Windshield washer fluid (display message)	193
Windshield washer system	
Adding washer fluid	235
Notes	299
Windshield wipers	
Important safety notes	113
Replacing the wiper blades	114, 115
Switching on/off	113
Troubleshooting	116
Winter operation	149
Winter tires	
M+S tires	148
Wiper blades	
Cleaning	239

Product information

We recommend using genuine Mercedes-Benz parts as well as conversion parts and accessories explicitly approved by us for your vehicle model.

We have tested these parts to determine their reliability, safety and special suitability for Mercedes-Benz vehicles. Despite ongoing market research, Mercedes-Benz is unable to assess other parts. We cannot therefore be held responsible for them, even if in individual cases an official approval or authorization by governmental or other agencies should exist. The use of non-approved parts could affect your vehicle's operating safety. Mercedes-Benz therefore recommends that you use genuine Mercedes-Benz parts, conversion parts and accessories that have been approved for the type of vehicle. Genuine Mercedes-Benz parts, approved conversion parts and accessories are available from any authorized Mercedes-Benz Center. In addition, you will receive advice about permissible technical modifications, and the parts will be professionally installed.

Operator's Manual

Notes on the Operator's Manual

This Operator's Manual contains a great deal of helpful information. We urge you to read it carefully and familiarize yourself with the vehicle before driving.

For your own safety and longer service life of the vehicle, we urge you to follow the instructions and warnings contained in this Operator's Manual. Ignoring them could result in damage to the vehicle or personal injury to you or others. Vehicle damage caused by failure to follow instructions is not covered by the Mercedes-Benz Limited Warranty.

Vehicle equipment

This manual describes all the standard and optional equipment of your vehicle available at the time of publication of the Operator's Manual. Country-specific differences are possible. Note that your vehicle may not be equipped with all functions described. This also refers to safety-related systems and functions. The equipment in your vehicle may therefore differ from that shown in the descriptions and illustrations. All the systems found in your vehicle are listed in the original purchase agreement of your vehicle. Should you have any questions concerning equipment and operation, please consult an authorized Mercedes-Benz Center.

The Operating Instructions and the Maintenance Booklet are important documents and should be kept in the vehicle.

Service and vehicle operation

Service and literature

The Service and Warranty Information booklet contains detailed information about the warranties covering your vehicle. Your authorized Mercedes-Benz Center will replace and repair any factory-fitted parts based on the terms and conditions of the following warranties:

- New Vehicle Limited Warranty
- Emission System Warranty
- Emission Performance Warranty
- California, Connecticut, Maine, Massachusetts, New York, Pennsylvania, Rhode Island and Vermont
- State Warranty Enforcement Laws (Lemon Laws)

Information for customers in California

Under California law you may be entitled to a replacement of your vehicle or a refund of the purchase price or lease price, if after a reasonable number of repair attempts Mercedes-Benz USA, LLC and/or its authorized repair or service facilities fail to fix one or more substantial defects or malfunctions in the vehicle that are covered by its express warranty. During the period of 18 months from original delivery of the vehicle or the accumulation of 18 000 miles (approximately 29 000 km) on the odometer of the vehicle, whichever occurs first, a reasonable number of repair attempts is presumed for a retail buyer or lessee if one or more of the following occurs:

- (1) the same substantial defect or malfunction results in a condition that is likely to cause death or serious bodily injury if the vehicle is driven, that defect or malfunction has been subject to repair two or more times, and you have directly notified Mercedes-Benz USA, LLC in writing of the need for its repair.
- (2) the same substantial defect or malfunction of a less serious nature than category (1) has been subject to repair four or more times and you have directly notified Mercedes-Benz in writing of the need for its repair.
- (3) the vehicle is out of service by reason of repair of the same or different substantial defects or malfunctions for a cumulative total of more than 30 calendar days.

Please send your written notice to:

Mercedes-Benz USA, LLC
Customer Assistance Center
One Mercedes Drive
Montvale, NJ 07645-0350

Maintenance

The Service and Warranty Information Booklet describes all necessary maintenance work that should be performed at regular intervals.

Always have the Service and Warranty Information Booklet with you when you bring the vehicle to an authorized Mercedes-Benz Center. The service advisor will record each service in the Service and Warranty Information Booklet for you.

Roadside Assistance

The Mercedes-Benz Roadside Assistance Program provides factory-trained technical help in the event of a breakdown. Calls to the toll-free Roadside Assistance number will be answered by Mercedes-Benz Customer Assistance Representatives 24 hours a day, 365 days a year.

**1-800-FOR-MERCEdes(1-800-367-6372)
(USA)**

1-800-387-0100 (Canada)

For additional information refer to the Mercedes-Benz Roadside Assistance Program brochure (in the USA) or the Roadside Assistance section of the Service and Warranty Information Booklet (in Canada) You will find both in your vehicle literature portfolio.

In accordance with standard program guidelines, Roadside Assistance is prepared to provide vehicle service up until a reasonable distance from the next paved roadway. We will make every effort to assist in a breakdown situation. However, the accessibility of your vehicle will be determined by our authorized Mercedes-Benz Service technician or the tow service provider on a case-by-case basis.

Additional charges may be applicable for a breakdown location determined not to be a reasonably accessible roadside location as determined by our authorized technician and tow service provider.

Change of address or ownership

In the event of a change of address, be sure to send in the "Change of Address Notice" found in the Service and Warranty Information Booklet, or simply call the Mercedes-Benz Customer Assistance Center (in the USA) at 1-800-FOR-MERCEdes (1-800-367-6372) or Customer Service (in Canada) at 1-800-387-0100. This will assist us in contacting you in a timely manner should the need arise.

If you sell your Mercedes, please leave all literature with the vehicle to make it available to the next operator.

If you bought this vehicle used, be sure to send in the "Notice of Purchase of Used Truck" found in the Service and Warranty Information Booklet, or call the Mercedes-Benz Customer Assistance Center (in the USA) at 1-800-FOR-MERCEdes (1-800-367-6372) or Customer Service (in Canada) at 1-800-387-0100.

Vehicle operation outside the USA and Canada

If you plan to operate your vehicle in foreign countries, please be aware that:

- Service facilities or replacement parts may not be readily available.
- Unleaded gasoline for vehicles with catalytic converters may not be available. The use of leaded fuels can damage the catalytic converter.
- Gasoline may have a considerably lower octane rating. Improper fuel can cause engine damage.

Certain Mercedes-Benz models are available for delivery in Europe under our European Delivery Program. For details, consult an authorized Mercedes-Benz Center or write to one of the following addresses:

In the USA

Mercedes-Benz USA, LLC
European Delivery Department
One Mercedes Drive
Montvale, NJ 07645-0350

In Canada

Mercedes-Benz Canada, Inc.
European Delivery Department
98 Vanderhoof Avenue
Toronto, Ontario M4G 4C9

Sport Utility Vehicle

Warning!

This Sport Utility Vehicle is designed for both on-road and off-road use. It can go places and perform tasks for which conventional 2-wheel drive passenger cars are not intended. This vehicle will handle and maneuver differently from conventional passenger cars in driving conditions which may occur on streets, highways and off-road use.

This vehicle has a higher ground clearance and a higher center of gravity than many passenger cars. As with other vehicles of this type, if you make sharp turns at excessive speeds or abrupt maneuvers, the vehicle may roll over or may go out of control and crash. Utility vehicles have a significantly higher rollover rate than other types of vehicles. Failure to operate this vehicle safely may result in an accident, rollover of the vehicle, and severe or fatal injury.

Before you start to drive this vehicle, read the Operator's Manual. Take time to become familiar with the driving characteristics of this vehicle. Be sure you are familiar with all vehicle controls. Learn how your vehicle handles on different road surfaces. Do not attempt sharp turns at excessive speeds or abrupt maneuvers or other unsafe driving actions that can cause loss of vehicle control. When driving off-road or working the vehicle

hard, do not overload it. And, always wear your seat belts at all times. In a rollover crash, an unbelted person is significantly more likely to die than a person wearing a seat belt.

Operating safety

Safety notes

Warning

Work improperly carried out on electronic components and associated software could cause them to cease functioning. Because the vehicle's electronic components are interconnected, any modifications made may produce an undesired effect on other systems. Electronic malfunctions could seriously impair the operating safety of your vehicle.

Contact an authorized Mercedes-Benz Center for repairs or modifications to electronic components.

Other improper work or modifications on the vehicle could also have a negative impact on the operating safety of the vehicle.

Some safety systems only function when the engine is running. You should therefore never turn off the engine while driving.

Warning

Heavy blows against the vehicle underbody or tires/wheels may cause serious damage and impair the operating safety of your vehicle. Such blows can be caused, for example, by running over an obstacle, road debris or a pothole. If you feel a sudden significant vibration or ride disturbance, or you suspect that damage to your vehicle has occurred:

- turn on your hazard warning flashers.
- slow down carefully.
- drive with caution to an area which is a safe distance from the road.

Inspect the vehicle underbody and tires/wheels for possible damage. If the vehicle appears unsafe, have it towed to the nearest

authorized Mercedes-Benz Center or other qualified maintenance or repair facility for further inspection or repairs.

Proper use of the vehicle

To ensure proper use of the vehicle, you must familiarize yourself with the following information and rules:

- safety notes in this Operator's Manual
- technical data in this Operator's Manual
- traffic rules and regulations
- laws and safety standards pertaining to motor vehicles

Warning!

Various warning labels are attached to your vehicle. These warning labels are intended to make you and others aware of various risks. Do not remove any of these warning labels unless explicitly instructed to do so by information on the label itself.

Removing warning labels may cause you and others to be unaware of certain risks which may result in an accident and/or personal injury.

Problems with your vehicle

If you should experience a problem with your vehicle, particularly one that you believe may affect its safe operation, we urge you to contact an authorized Mercedes-Benz Center immediately to have the problem diagnosed and rectified. If the problem is not resolved to your satisfaction, please discuss the problem with the Mercedes-Benz Center again or, if necessary, contact us at one of the following addresses.

In the USA

Customer Assistance Center
Mercedes-Benz USA, LLC
One Mercedes Drive
Montvale, NJ 07645-0350

In Canada

Customer Relations Department
Mercedes-Benz Canada, Inc.
98 Vanderhoof Avenue
Toronto, Ontario M4G 4C9

Reporting malfunctions relevant to safety

For the USA only:

The following text is reproduced as required of all manufacturers according to Title 49, Code of U.S. Federal Regulations, Part 575 pursuant to the National Traffic and Motor Vehicle Safety Act of 1966.

Reporting safety defects

If you believe that your vehicle has a defect which could cause a crash or could cause injury or death, you should immediately inform the National Highway Traffic Safety Administration (NHTSA) in addition to notifying Mercedes-Benz USA, LLC.

If NHTSA receives similar complaints, it may open an investigation, and if it finds that a safety defect exists in a group of vehicles, it may order a recall and remedy campaign. However, NHTSA cannot become involved in individual problems between you, your dealer, or Mercedes-Benz USA, LLC.

To contact NHTSA, you may call the Vehicle Safety Hotline toll-free at 1-888-327-4236 (TTY: 1-800-424-9153); go to: <http://www.safercar.gov>; or write to: Administrator, NHTSA Headquarters, 1200 New Jersey Avenue, SE, West Building, Washington, DC 20590.

You can also obtain additional information about vehicle safety from:

<http://www.safercar.gov>.

Limited Warranty

! Follow the instructions in this manual about the proper operation of your vehicle as well as about possible vehicle damage. Damage to your vehicle that arises from culpable contraventions against these instructions are not covered either by Mercedes-Benz Limited Warranty or by the New or Used-Vehicle Warranty of Daimler AG.

Data stored in the vehicle

Information regarding electronic recording devices

(Including California Code Supplement § 9951)

Please note that your vehicle is equipped with devices that can record vehicle systems data. If your vehicle is equipped with mbrace² data is transmitted in the event of an accident.

This information serves, for example, to test vehicle systems after an accident and to continually improve vehicle safety.

Daimler AG can access this data and submit it:

- for safety research or vehicle diagnosis purposes
- with the consent of the vehicle owner or lessee
- in response to an official request by law enforcement or other government agency
- for use in arbitration of disputes that involve Daimler AG, its subsidiaries or its sales and service organizations
- as otherwise required or permitted by law

Please observe the mbrace² order agreement regarding further details on data that this system records and transmits.

² The system is called TELEAID in Canada.

Exterior view	24
Cockpit	25
Instrument cluster	26
Multifunction steering wheel	28
Center console	29
Overhead control panel	30
Door control panel	31

Exterior view

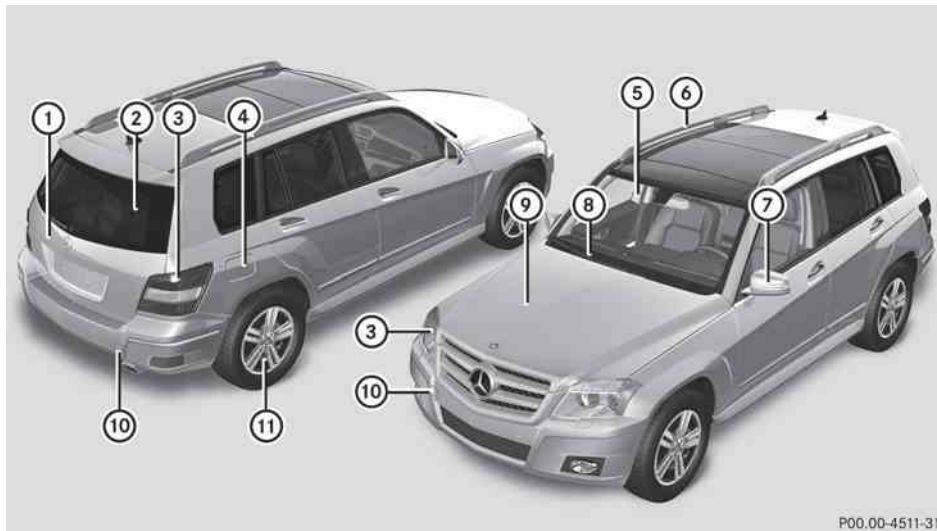

P00.00-4511-31

	Function	Page
①	Tailgate Vehicle tool kit	245
②	Rear window heating	123
③	Lights	107
④	Fuel filler flap	140
⑤	Defrosting the windshield Cleaning the windows	122 239
⑥	Roof carrier Sliding sunroof	213 85

	Function	Page
⑦	Exterior mirrors	97
⑧	Windshield wipers	113
⑨	Opening the hood Engine oil Coolant	232 233 234
⑩	Towing away	258
⑪	Tires and wheels Flat tire	264 247

Cockpit

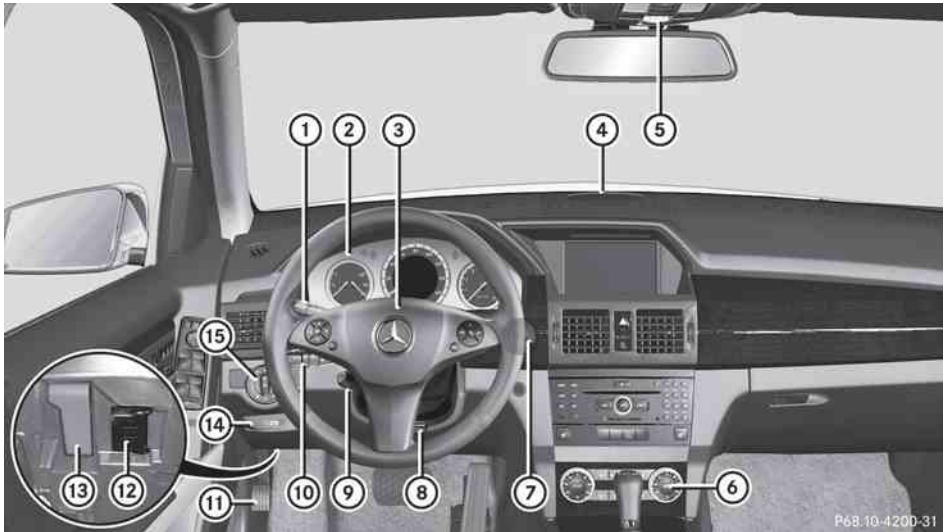

	Function	Page		Function	Page
①	Cruise control lever	150	⑨	Adjusts the steering wheel electrically	95
②	Instrument cluster	26	⑩	Combination switch	104
③	Horn		⑪	Parking brake	142
④	PARKTRONIC warning display	151	⑫	On-board diagnostic socket	
⑤	Overhead control panel	30	⑬	Opens the hood	232
⑥	Operates the automatic climate control system	118	⑭	Releases the parking brake	142
⑦	Ignition lock Start/Stop button	129 129	⑮	Light switch	102
⑧	Adjusts the steering wheel manually	95			

Instrument cluster

Overview

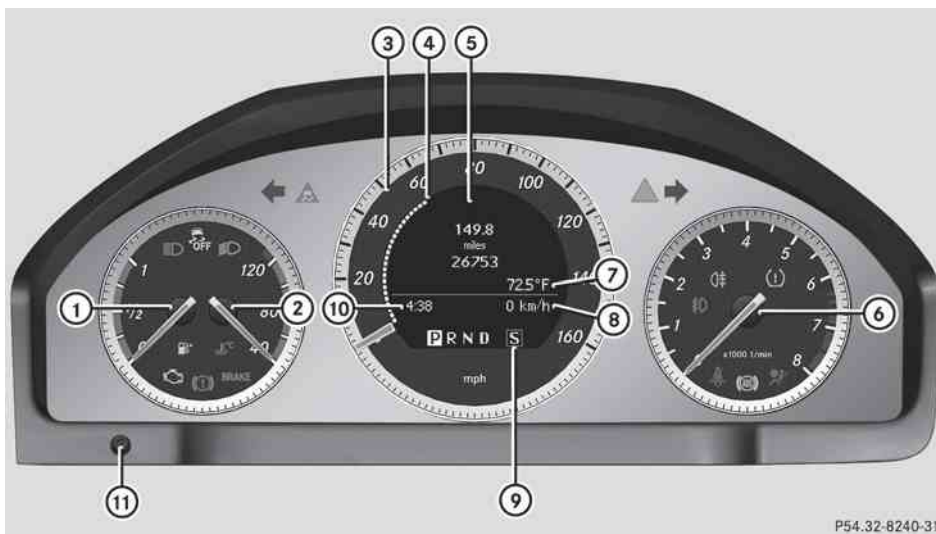

P54.32-8240-31

	Function	Page
①	Fuel gauge	
②	Coolant temperature gauge	162
③	Speedometer	163
④	Segments	163
⑤	Multifunction display	164
⑥	Tachometer	163
⑦	Outside temperature	163
⑧	Outside temperature Additional speedometer	163 171

	Function	Page
⑨	Gear indicator and drive program display	135
⑩	Clock	171
⑪	Brightness control knob for the instrument cluster lighting: turn clockwise or anti-clockwise	

Warning and indicator lamps

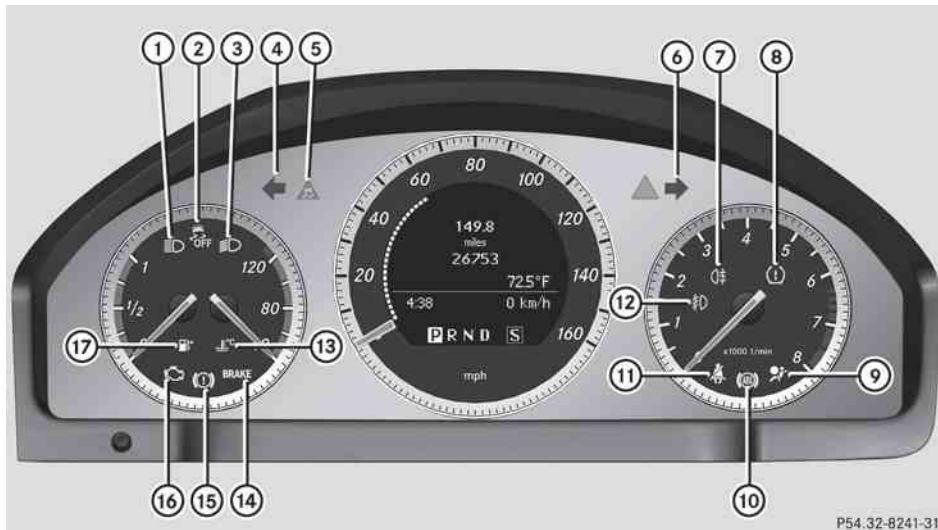







P54.32-8241-31







	Function	Page
①	High beam	104
②	ESP® OFF	198
③	Low beam	103
④	Turn signal	104
⑤	ESP®	198
⑥	Turn signal	104
⑦	Rear fog lamp	104
⑧	Tire pressure monitor	202
⑨	SRS	199

	Function	Page
⑩	ABS	197
⑪	Seat belt	196
⑫	Fog lamp	104
⑬	Coolant	201
⑭	Brakes (USA only)	195
⑮	Brakes (Canada only)	195
⑯	Engine diagnostics	200
⑰	Reserve fuel	200

Multifunction steering wheel





	Function	Page
①	Multifunction display	164
②	COMAND/audio system; see the separate operating instructions	
③	  Makes/accepts or rejects/ends a call   Adjusts the volume  Mute	169
④	 Activates voice control; see the separate operating instructions	

	Function	Page
⑤	 Back or deactivates voice control	
⑥	  Selects a menu   Selects the submenu or scrolls through lists  Confirms selections and hides display messages	165 165

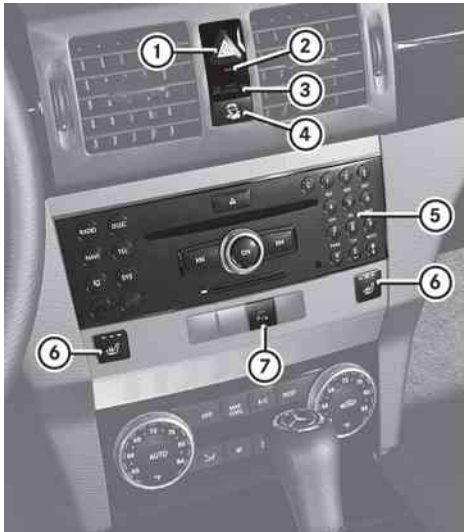
Center console



P68.20-4231-31

	Function	Page
①	Hazard warning lamps	105
②	ATA indicator lamp	65
③	Indicator lamp  PASSENGER AIR BAG OFF (USA only)	41
	Indicator lamp  PASSENGER AIR BAG OFF (Canada only)	46
④	ESP®	63
⑤	COMAND/audio system; see the separate operating instructions	
⑥	Seat heating	95

	Function	Page
⑦	PARKTRONIC	151
⑧	Stowage compartment Ashtray Cigarette lighter	206 215 216
⑨	Selector lever	134
⑩	Cup holder	214
⑪	Stowage compartment	206
⑫	Audio/COMAND controller	
⑬	Selects the drive program	137

Overhead control panel



PB2.00-2760-31

	Function	Page
①	To switch the rear interior lighting on/off	107
②	To switch the automatic interior lighting control on/off	107
③	To switch the right-hand reading lamp on/off	106
④	To open/close the panorama roof with power tilt/sliding panel with roller sunblinds	86
⑤	Button for MB info call (mbrace system)	222
⑥	SOS button (mbrace system)	220
⑦	Rear-view mirror	97







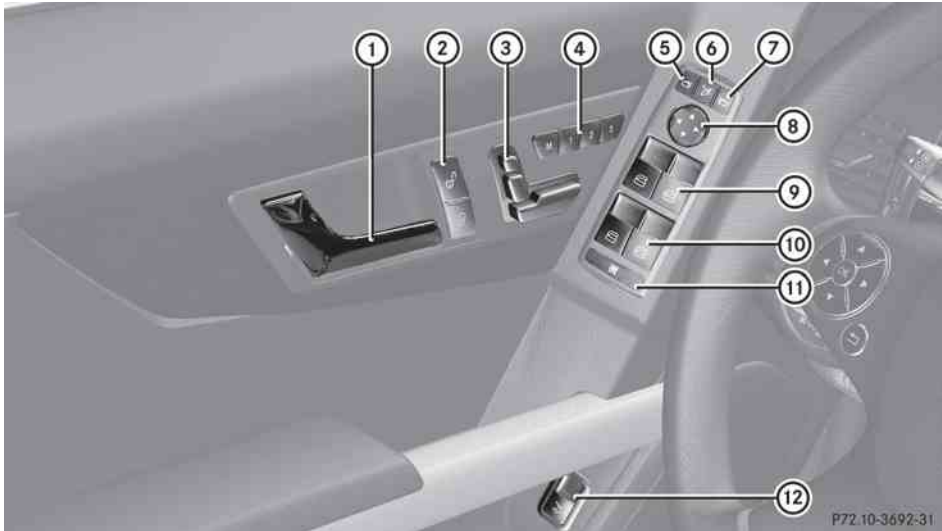





	Function	Page
⑧	Integrated electronic compass	227
⑨	Buttons for the garage door opener	225
⑩	Microphone for mbrace (emergency call system) telephone and Voice Control System ³	
⑪	Roadside Assistance button (mbrace system)	221
⑫	To switch the left-hand reading lamp on/off	106
⑬	To switch the front interior lighting on/off	107



³ Voice Control System only available in connection with COMAND. Observe the additional operating instructions.

Door control panel



P72.10-3692-31

	Function	Page
①	Opens the door	76
②	  Locks/unlocks the vehicle	76
③	Adjusts the seat electrically	92
④	    Stores settings for the seat, exterior mirrors and steering wheel	100
⑤	 Selects the left exterior mirror	97
⑥	 Folds the exterior mirrors in/out	97
⑦	 Selects the right exterior mirror	97
⑧	 Adjusts the exterior mirrors	97
⑨	 Opens/closes the front side windows	82
⑩	 Opens/closes the rear side windows	82

	Function	Page
⑪	 Activates/deactivates the override feature for the side windows in the rear compartment	60
⑫	 Opens/closes the tailgate	78

Vehicle equipment	34
Occupant safety	34
Children in the vehicle	55
Panic alarm	61
Driving safety systems	61
Anti-theft systems	65

Vehicle equipment

i This manual describes all the standard and optional equipment of your vehicle which was available at the time of purchase. Country-specific differences are possible. Bear in mind that your vehicle may not feature all functions described here. This also refers to safety-related systems and functions.

Occupant safety

Overview of occupant safety

In this section you will learn the most important facts about the restraint system components of the vehicle.

The restraint systems are:

- Seat belts
- Child restraint systems
- LATCH-type (ISOFIX) child seat anchors

Additional protection is provided by:

- SRS (Supplemental Restraint System)
- NECK-PRO head restraints
- Air bag system components with:
 - PASSENGER air bag OFF indicator lamp
 - USA only: front passenger seat with Occupant Classification System (OCS)
 - Canada only: front passenger seat with BabySmart™ air bag deactivation system

The different air bag systems work independently of each other. The protective functions of the systems work in conjunction with each other. Not all air bags are deployed in an accident.

Warning

Modifications to or work improperly conducted on restraint system components or their wiring, as well as tampering with interconnected electronic systems, can lead to the restraint systems no longer functioning as intended.

Air bags or Emergency Tensioning Devices (ETDs), for example, could deploy inadvertently or fail to deploy in accidents although the deceleration threshold for air bag deployment is exceeded. Therefore, never modify the restraint systems. Do not tamper with electronic components or their software.

i See "Children in the vehicle" (> page 55) for more information on infants and children traveling with you in the vehicle and restraints for infants and children.

SRS (Supplemental Restraint System)

Introduction

SRS reduces the risk of occupants coming into contact with the vehicle's interior in the event of an accident. It can also reduce the effect of the forces to which occupants are subjected during an accident.

SRS consists of:

- the  SRS warning lamp
- air bags
- air bag control unit (with crash sensors)
- belt tensioners
- belt force limiters

SRS warning lamps

SRS functions are checked regularly when you switch on the ignition and when the engine is running. Therefore, malfunctions can be detected in good time.

The  SRS warning lamp in the instrument cluster lights up when the ignition is switched on. It goes out no later than a few seconds after the engine is started.

The SRS components are in operational readiness when the  SRS warning lamp is not lit while the engine is running.

 **Warning**

The SRS self-check has detected a malfunction if the  SRS warning lamp:

- does not come on at all
- fails to go out approximately 4 seconds after the engine was started
- comes on after the engine was started or while driving

For your safety, Mercedes-Benz strongly recommends that you have the system checked as soon as possible at an authorized Mercedes-Benz Center. Otherwise the SRS may not be activated when it is needed in an accident, which could result in serious or fatal injury. The SRS might also deploy unexpectedly and unnecessarily which could also result in injury.

In addition, improper work on the SRS creates a risk of rendering the SRS inoperative or causing unintended air bag deployment. Work on the SRS must therefore only be performed by qualified technicians. Contact an authorized Mercedes-Benz Center.

If it is necessary to modify an air bag system to accommodate a person with disabilities, contact an authorized Mercedes-Benz Center for details. USA only: Call our Customer Assistance Center at 1-800-FOR-MERCEdes (1-800-367-6372) for details.

Safety guidelines for seat belts, Emergency Tensioning Devices (ETDs) and air bags

 **Warning**

- Damaged seat belts or seat belts that have been subjected to stress in an accident must be replaced. Their anchoring points must also be checked. Only use seat belts installed or supplied by an authorized Mercedes-Benz Center.
- Air bags and pyrotechnic Emergency Tensioning Devices (ETDs) contain perchlorate material, which may require special handling and regard for the

environment. Check your national disposal guidelines. California residents, see www.dtsc.ca.gov/HazardousWaste/Perchlorate/index.cfm.

- Air bags and ETDs are designed to function on a one-time-only basis. An air bag or ETD that has deployed must be replaced.
- Do not pass seat belts over sharp edges. They could tear.
- Do not make any modification that could change the effectiveness of the seat belts.
- Do not bleach or dye seat belts as this may severely weaken them. In a crash they may not be able to provide adequate protection.
- No modifications of any kind may be made to any components or wiring of the SRS.
- Do not change or remove any component or part of the SRS.
- Do not install additional trim material, seat covers, badges, etc. over the steering wheel hub, front-passenger front air bag cover, outer sides of the seat backrests, door trim panels, or door frame trims.
- Do not install additional electrical/ electronic equipment on or near SRS components and wiring.
- Keep area between air bags and occupants free of objects (e.g. packages, purses, umbrellas, etc.).
- Do not hang items such as coat hangers from the coat hooks or handles over the door. These items may be thrown around in the vehicle and cause head and other injuries when the window curtain air bag is deployed.
- Air bag system components will be hot after an air bag has inflated. Do not touch them.
- Never place your feet on the instrument panel, dashboard, or on the seat. Always keep both feet on the floor in front of the seat.
- Improper repair work on the SRS creates a risk of rendering the SRS inoperative or causing unintended air bag deployment. Work on the SRS must therefore only be

performed by qualified technicians. Contact an authorized Mercedes-Benz Center.

- For your protection and the protection of others, when scrapping the air bag unit or ETD, our safety instructions must be followed. These instructions are available from any authorized Mercedes-Benz Center.
- Given the considerable deployment speed, required inflation volume, and the material of the air bags, there is the possibility of abrasions or other, potentially more serious injuries resulting from air bag deployment.

If you sell your vehicle, Mercedes-Benz strongly recommends that you inform the subsequent owner that the vehicle is equipped with SRS. Also refer them to the applicable section in the Operator's Manual.

Air bags

Important safety notes

Warning

Air bags are designed to reduce the incidence of injuries and fatalities in certain situations:

- frontal impacts (driver's and front-passenger front air bags and driver's knee bag)
- side impacts (side impact air bags, window curtain air bags and pelvis air bags)
- rollover (window curtain air bags)

However, no system available today can completely eliminate injuries and fatalities. When the air bags are deployed, a small amount of powder is released. The powder generally does not constitute a health hazard and does not indicate that there is a fire in the vehicle. In order to prevent potential breathing difficulties, you should leave the vehicle as soon as it is safe to do so. If you have any breathing difficulty but cannot get out of the vehicle after the air bag inflates,

then get fresh air by opening a window or door.

Warning

To reduce the risk of injuries during front air bag inflation, the driver and front-passenger must always be seated correctly and have their seat belts fastened accordingly.

For maximum protection in the event of a collision, you must always be in the normal seat position with your back against the backrest. Fasten your seat belt and make sure that it is correctly positioned on your body.

Since the air bag inflates with considerable speed and force, a proper seating position and correct positioning of the hands on the steering wheel will help to keep you at a safe distance from the air bag. Occupants who are not wearing their seat belt, are not seated properly or are too close to the air bag can be seriously injured or killed by an air bag as it inflates with great force instantaneously:

- Sit with the seat belt properly fastened in a position that is as upright as possible with your back against the seat backrest.
- Move the driver's seat as far back as possible, still permitting proper operation of vehicle controls. The distance from the center of the driver's chest to the center of the air bag cover on the steering wheel must be at least 10 inches (25 cm) or more. You should be able to accomplish this by adjusting the seat and steering wheel. If you have any difficulties, please contact an authorized Mercedes-Benz Center.
- Do not lean your head or chest close to the steering wheel or dashboard.
- Only hold the steering wheel by the rim. Placing hands and arms inside the rim can increase the risk and potential severity of hand/arm injury when the driver front air bag inflates.
- Adjust the front-passenger seat as far back as possible from the dashboard when the seat is occupied.

- Occupants, especially children, should never place their bodies or lean their heads in the area of the door where the side impact air bag inflates. This could result in serious injuries or death should the side impact air bag be deployed. Always sit as upright as possible, wear the seat belt properly and use an appropriately sized child restraint, infant restraint or booster seat recommended for the size and weight of the child.
- Canada only: children under 12 years may only sit in the front-passenger seat if they are seated in a child restraint system which is compatible with BabySmart™ and approved by Mercedes-Benz. If the child restraint system is installed properly, the front-passenger front air bag is deactivated in conjunction with the BabySmart™ system installed in the vehicle. Otherwise, the child could be struck by the air bag when it inflates in a crash. This could lead to serious or fatal injuries.

Failure to follow these instructions can result in severe injuries to you or other occupants.

If you sell your vehicle, it is important that you make the buyer aware of this safety information. Be sure to give the buyer this Operator's Manual.

Warning

Accident research shows that the safest place for children in an automobile is in a rear seat.

A side impact air bag related injury may occur if occupants, especially children, are not properly seated or restrained when next to a side impact air bag which needs to deploy rapidly in a side impact in order to do its job.

To help avoid the possibility of injury, please follow these guidelines:

- (1) Always sit as upright as possible and use the seat belts properly. Make sure that children 12 years old and under use an appropriately sized child restraint, infant restraint, or booster seat

recommended for the size and weight of the child.

- (2) Always wear seat belts properly.

The air bags are only deployed if the airbag control unit detects the need for deployment. Only in the event of such a situation will they provide their supplemental protection.

The driver and passenger should always wear their seat belts. Otherwise, it is not possible for the air bags to provide their supplemental protection.

In the event of other types of impacts and impacts below air bag deployment thresholds, air bags will not deploy. The driver and passengers will then be protected to the extent possible by a properly fastened seat belt. A properly fastened seat belt is also needed to provide the best possible protection in a rollover.

Air bags offer supplemental protection but are not a substitute for seat belts. All vehicle occupants must fasten their seat belts regardless of whether your vehicle is equipped with airbags or not.

It is important for your safety and that of your passenger to have deployed air bags replaced and to have any malfunctioning air bags repaired. This will help to make sure the air bags continue to perform their protective function for the vehicle occupants in the event of a crash.

Front air bags

Warning

Observe "Important safety notes" (▷ page 36).

The front air bags increase protection for the driver's and front-passenger's head and chest.



Driver's air bag ① deploys in front of the steering wheel; front-passenger air bag ② deploys in front of and above the glove box. They are deployed:

- in the event of certain frontal impacts
- if the system determines that air bag deployment can offer additional protection to that provided by the seat belt
- if the seat belt is fastened
- independently of other air bags in the vehicle

If the vehicle overturns, the front air bags are generally not deployed unless the system detects high vehicle deceleration in a longitudinal direction.

Your vehicle has adaptive, two-stage front air bags. In the event of a collision, the air bag control unit evaluates the vehicle deceleration. When the first deployment threshold is reached, the front air bag is filled with enough propellant gas to reduce the risk of injuries. The front air bag is fully deployed if a second deployment threshold is exceeded within a few milliseconds.

Vehicles with OCS (USA only): front-passenger front air bag deployment is also influenced by the passenger's weight category as identified by the Occupant Classification System (OCS) (▷ page 41).

Vehicles with OCS (USA only): the lighter the passenger side occupant, the higher the vehicle deceleration rate required for second stage inflation of the front-passenger front air bag. In the second stage, the front air bags

are inflated with the maximum amount of propellant gas available.

In impact situations with deceleration or acceleration values lower than the vehicle deceleration or acceleration values preset in the system, the front air bags are not deployed. You will then be protected by the seat belt.

- ❗ Vehicles with BabySmart™ (Canada only): do not place any objects which weigh more than 20 lb (9 kg) on the front-passenger seat. This could cause the system to identify the seat as being occupied. In the event of an accident, the restraint systems on the front-passenger side are triggered. Have restraint systems that have been triggered replaced.

The front-passenger air bag will only deploy if:

- the system, based on the OCS weight sensor readings, detects that the front-passenger seat is occupied (USA only).
- the  indicator lamp in the center console is not lit, USA: (▷ page 41), Canada: (▷ page 46).
- the impact exceeds a preset deployment threshold.

Driver's knee bag

Warning

Observe "Important safety notes" (▷ page 36).



Driver's knee bag ① increases protection for the driver against the risk of:

- knee injuries
- thigh injuries
- lower leg injuries

Driver's knee bag ① inflates beneath the steering column. If the system determines that deployment of driver's knee bag ① can offer additional protection to that provided by the seat belt in the event of a frontal impact, the system will deploy it together with the driver's front air bag. Driver's knee bag ① operates best in conjunction with a properly positioned and fastened seat belt.

Side impact air bags

Warning

Observe "Important safety notes" (> page 36).

Warning!

The pressure sensors for side impact air bag control are located in the doors. Do not modify any components of the doors or door trim panels including, for example, the addition of door speakers.

Improper repair work on the doors or the modification or addition of components to the doors create a risk of rendering the side impact air bags inoperative or causing unintended air bag deployment. Work on the doors must therefore only be performed by qualified technicians. Contact an authorized Mercedes-Benz Center.

Warning

Only use seat covers which have been tested and approved by Mercedes-Benz for your vehicle model. Using seat covers or other seat coverings can cause a malfunction of the side impact air bags and/or the pelvis air bags. Contact an authorized Mercedes-Benz Center for availability.

When deployed, the side impact air bags offer additional protection for the thorax of the vehicle occupants on the side of the vehicle on which the impact occurs. However, they do not protect the:

- head
- neck
- arms

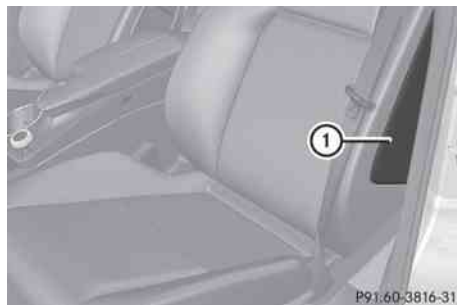

Side impact air bags ① deploy next to the outer seat cushion.

Side impact air bags ① are deployed:

- on the side on which an impact occurs
- at the start of an accident with a high rate of lateral vehicle deceleration or acceleration, e.g. in a side impact
- independently of seat belt use
- independently of the front air bags
- independently of the Emergency Tensioning Devices

If the vehicle overturns, the side impact air bags are generally not deployed. They are deployed if the system detects high vehicle deceleration or acceleration in a lateral direction and determines that side impact air bag deployment can offer additional protection to that provided by the seat belt.

Side air bags ① will not deploy in side impacts with deceleration rates which do not exceed the system's preset deployment thresholds for vehicle deceleration or acceleration. You will then be protected by the seat belt.

Vehicles with OCS (USA only): if the OCS detects that the front-passenger seat is not

occupied and the front-passenger seat belt is not fastened (the belt tongue is not engaged in the seat belt buckle), the side impact air bag on the front-passenger side will not deploy. The side impact air bag on the front-passenger side will deploy if the front-passenger seat belt is fastened, regardless of whether the front-passenger seat is occupied or not.

! Vehicles with BabySmart™ (Canada only): do not place any objects which weigh more than 20 lb (9 kg) on the front-passenger seat. This could cause the system to identify the seat as being occupied. In the event of an accident, the restraint systems on the front-passenger side are triggered. Have restraint systems that have been triggered replaced.

Pelvis air bags

Warning

Observe "Important safety notes" (▷ page 36).

Warning

Only use seat covers which have been tested and approved by Mercedes-Benz for your vehicle model. Using seat covers or other seat coverings can cause a malfunction of the side impact air bags and/or the pelvis air bags. Contact an authorized Mercedes-Benz Center for availability.

Pelvis air bag deployment enhances the level of protection of the vehicle occupants on the side of the vehicle on which the impact occurs.

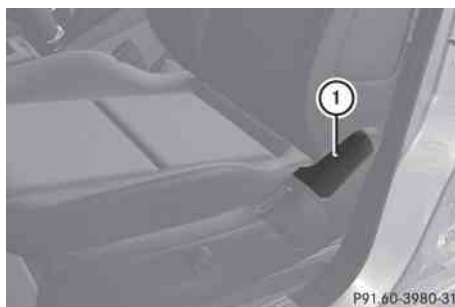

Pelvis air bags ① deploy next to and below the outer seat cushions. They are deployed:

- on the side on which an impact occurs
- at the start of an accident with a high rate of lateral vehicle deceleration or acceleration, e.g. in a side impact
- independently of seat belt use
- independently of the front air bags
- independently of the Emergency Tensioning Devices

The pelvis air bags are generally not deployed if the vehicle overturns, unless the system detects high vehicle deceleration or acceleration in a lateral direction and determines that they can offer additional protection to that provided by the seat belt. Pelvis air bags ① will not deploy in side impacts with deceleration rates which do not exceed the system's preset deployment thresholds for vehicle deceleration or acceleration. You will then be protected by the seat belt.

Vehicles with OCS (USA only): if the OCS detects that the front-passenger seat is not occupied and the front-passenger seat belt is not fastened (the belt tongue is not engaged in the seat belt buckle), the pelvis air bag on the front-passenger side will not deploy. The pelvis air bag on the front-passenger side will deploy if the front-passenger seat belt is fastened, regardless of whether the front-passenger seat is occupied or not.

Window curtain air bags

Warning

Observe "Important safety notes"
(▷ page 36).

The window curtain air bags enhance the level of protection for the head (but not chest or arms) of the vehicle occupants on the side of the vehicle on which the impact occurs.

The window curtain air bags are integrated into the side of the roof frame and deploy into the area extending from the front door (A-pillar) to the rear door (C-pillar).

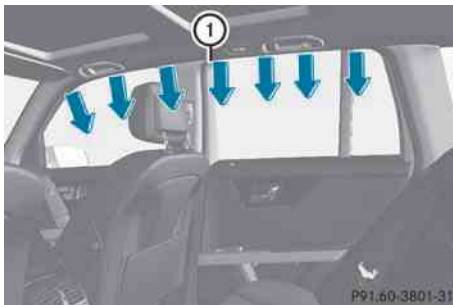

Window curtain air bags ① are deployed:



- on the side on which an impact occurs
- at the start of an accident with a high rate of lateral vehicle deceleration or acceleration, e.g. in a side impact
- regardless of whether the front-passenger seat is occupied
- independently of seat belt use
- if the vehicle overturns and the system determines that window curtain air bag deployment can offer additional protection to that provided by the seat belt
- independently of the front air bags

Window curtain air bags ① will not deploy in impacts with deceleration rates which do not exceed the system's preset deployment thresholds for vehicle deceleration or acceleration. You will then be protected by the seat belt.

Occupant Classification System (OCS)

How the occupant classification system works

The Occupant Classification System (OCS) is standard equipment in the USA.

OCS categorizes the occupant on the front-passenger seat by means of a weight sensor. The front-passenger front air bag is automatically deactivated for certain weight categories. The respective status can be recognized by the  "PASSENGER AIR BAG OFF" indicator lamp. With the  "PASSENGER AIR BAG OFF" indicator lamp illuminated, the front-passenger front air bag is deactivated.

The system does not deactivate:

- the side impact air bag
- the pelvis air bag
- the window curtain air bag
- the Emergency Tensioning Devices

To be classified correctly, the front passenger must sit:

- with the seat belt properly fastened
- in a position that is as upright as possible with the back against the seat backrest
- with their feet on the floor



If the front-passenger's weight is transferred to another object in the vehicle (e.g. by leaning on armrests), OCS may not be able to approximate the occupant's weight category.

If the front passenger seat, the seat cover, or the seat cushion are damaged, have the necessary repair work carried out at an authorized Mercedes-Benz Center.

For reasons of safety, Mercedes-Benz recommends that you only use seat accessories that have been approved by Mercedes-Benz.

Both the driver and the front passenger should observe the  "PASSENGER AIR BAG OFF" indicator lamp to determine whether or not the front passenger is positioned correctly.



Warning

If the  indicator lamp illuminates when an adult or someone larger than a small individual is in the front-passenger seat, have the front passenger reposition himself or herself in the seat until the  indicator lamp goes out.

In the event of a collision, the air bag control unit will not allow front-passenger front air bag deployment when the OCS has classified the front-passenger seat occupant as weighing as much as or less than a typical 12-month-old child in a standard child restraint or if the front-passenger seat is classified as being empty.

When the OCS senses that the front-passenger seat occupant is classified as being up to or less than the weight of a typical 12-month-old child in a standard child restraint, the  indicator lamp will illuminate when the engine is started and remain illuminated, indicating that the front-passenger front air bag is deactivated.

When the OCS senses that the front-passenger seat is classified as being empty, the  indicator lamp will illuminate when the engine is started and remain illuminated, indicating that the front-passenger front air bag is deactivated.

When the OCS senses that the front-passenger seat occupant is classified as being heavier than the weight of a typical 12-month-old child seated in a standard child restraint or as being a small individual (such as a young teenager or a small adult), the  indicator lamp will illuminate for approximately 6 seconds when the engine is started and then, depending on occupant weight sensor readings from the front-passenger seat, remain illuminated or go out. With the  indicator lamp illuminated, the front-passenger front air bag is deactivated. With the  indicator lamp out, the front-passenger front air bag is activated.

When the OCS senses that the front-passenger seat occupant is classified as an adult or someone larger than a small individual, the  indicator lamp will illuminate for approximately 6 seconds when the engine is started and then go out, indicating that the front-passenger front air bag is activated.

If the  indicator lamp is illuminated, the front-passenger front air bag is deactivated and will not be deployed.

If the  indicator lamp is not illuminated, the front-passenger front air bag is activated and will be deployed:

- in the event of certain frontal impacts
- if impact exceeds a preset deployment threshold
- independently of the side impact air bags

If the front-passenger front air bag is deployed, the rate of inflation will be influenced by:

- the rate of relevant vehicle deceleration as assessed by the air bag control unit
- the front passenger's weight category as identified by OCS

For further information, see the section regarding air bag display messages ([▷ page 179](#)).

Warning





According to accident statistics, children are safer when properly restrained on the rear seats than on the front-passenger seat. Thus, we strongly recommend that children be placed in the rear seats whenever possible. Regardless of seating position, children 12 years old and under must be seated and properly secured in an appropriate infant restraint, toddler restraint, or booster seat recommended for the size and weight of the child.

The infant or child restraint must be properly secured with the vehicle's seat belt, the seat belt and Top Tether strap, or lower anchors

and Top Tether strap, fully in accordance with the child seat manufacturer's instructions.

Occupants, especially children, should always sit as upright as possible, wear the seat belt properly and use an appropriately sized infant restraint, toddler restraint, or booster seat recommended for the size and weight of the child.

Children can be killed or seriously injured by an inflating air bag. Note the following important information when circumstances require you to place a child in the front-passenger seat:

- Your vehicle is equipped with air bag technology designed to deactivate the front-passenger front air bag in your vehicle when the system senses the weight of a typical 12-month-old child or less along with the weight of a standard appropriate child restraint on the front-passenger seat.
- A child in a rear-facing child restraint on the front-passenger seat will be seriously injured or even killed if the front-passenger front air bag inflates in a collision which could occur under some circumstances, even with the air bag technology installed in your vehicle. The only means to eliminate this risk completely is never to place a child in a rear-facing child restraint in the front-passenger seat. We therefore strongly recommend that you always place a child in a rear-facing child restraint on the rear seat.
- If you install a rear-facing child restraint on the front-passenger seat, make sure the  **AIR BAG OFF** indicator lamp is illuminated, indicating that the front-passenger front air bag is deactivated. Should the  **AIR BAG ON** indicator lamp not illuminate or go out while the restraint is installed, please check installation. Periodically check the  **AIR BAG OFF** indicator lamp while driving to make sure that the  **AIR BAG ON** indicator lamp is illuminated. If the  **AIR BAG OFF** indicator lamp goes out or remains out, do

not transport a child on the front-passenger seat until the system has been repaired.

A child in a rear-facing child restraint on the front-passenger seat will be seriously injured or even killed if the front-passenger front air bag inflates.

- If you place a child in a forward-facing child restraint on the front-passenger seat:
 - move the seat as far back as possible
 - use the proper child restraint recommended for the age, size and weight of the child
 - secure child restraint with the vehicle's seat belt according to the child seat manufacturer's instructions
- For children larger than the typical 12-month-old child, the front-passenger front air bag may or may not be activated.

Deployment of the driver front air bag does not mean that the front-passenger front air bag should also have deployed.



OCS may have determined:

- that the seat was unoccupied or occupied by a weight of up to or less than that of a typical 12-month-old child seated in a standard child restraint
- that the seat was occupied by a small individual (e.g. a young teenager or a small adult) or a child who weighs more than a typical 12-month-old child in a standard child restraint system



These are examples of when OCS deactivates the front-passenger front air bag. The air bag is deactivated despite the impact fulfilling the criteria for deploying the driver's front air bag.



If the SmartKey has been removed from the ignition lock or is in position **0**, indicator lamp

  **1** does not light up.

Warning

If the red  SRS warning lamp in the instrument cluster and the  indicator lamp light up simultaneously, the OCS is malfunctioning. The front passenger front air bag will be deactivated in this case. Have the system checked by qualified technicians as soon as possible. Contact an authorized Mercedes-Benz Center.

Only have the seat repaired or replaced at an authorized Mercedes-Benz Center.

In order to ensure proper operation of the air bag system and OCS:

- Sit with the seat belt properly fastened in a position that is as upright as possible with your back against the seat backrest.
- When seated, a passenger should not position him/herself in such a way as to cause the passenger's weight to be lifted from the seat cushion as this may result in the OCS being unable to correctly approximate the passenger's weight category.
- Read and observe all warnings in this chapter.

System self-test

The  indicator lamp illuminates when you:

- turn the SmartKey to position **1** or **2** in the ignition lock
- on vehicles with KEYLESS-GO, press the Start/Stop button once or twice

If an adult is seated properly on the passenger seat and the OCS classifies the occupant as an adult, the  indicator lamp illuminates and goes out again after approximately 6 seconds.

If the seat is not occupied and the OCS classifies the front passenger seat as being unoccupied, the  indicator lamp will illuminate and not go out.

Warning!

If the  indicator lamp does not illuminate, the system is not functioning. You must contact an authorized Mercedes-Benz Center before seating any child on the front passenger seat.

For more information, see "Problems with the Occupant Classification System" ([▷ page 45](#)).

Warning

Never place anything between seat cushion and child seat (e.g. a pillow), since it reduces the effectiveness of the OCS. The underside and rear side child restraint system must be placed entirely on the seat cushion and the backrest of the front-passenger seat backrest.

If necessary, adjust the tilt of the passenger seat backrest.

An incorrectly mounted child seat could cause injuries to the child in case of an accident, instead of increasing protection for the child.



Follow the manufacturer's instructions for installation of child restraint systems.

Problems with the occupant classification system

Problem	Possible causes/consequences and ► Solutions
<p>The  indicator lamp illuminates and remains illuminated. The person sitting on the front-passenger seat:</p> <ul style="list-style-type: none"> • weighs as much as a typical adult • weighs more than a child 	<p>OCS is malfunctioning.</p> <ul style="list-style-type: none"> ► Have OCS checked as soon as possible at an authorized Mercedes-Benz Center. ► Observe the additional display messages in the multifunction display (► page 179).

Warning

If the  indicator lamp illuminates and remains illuminated when the weight of a typical adult or someone larger than a small individual has been detected on the passenger seat, do not allow any occupant to use the passenger seat until the system has been repaired.

Problem	Possible causes/consequences and ► Solutions
<p>The  indicator lamp does not illuminate and/or does not remain illuminated. The front-passenger seat is:</p> <ul style="list-style-type: none"> • unoccupied • occupied with the weight of a typical 12-month-old child in a standard child restraint or less 	<p>OCS is malfunctioning.</p> <ul style="list-style-type: none"> ► Make sure there is nothing between the seat cushion and the child seat. ► Check the installation of the child restraint system. ► Make sure there are no objects applying additional weight onto the seat. ► If the  indicator lamp remains out, have OCS checked as soon as possible at an authorized Mercedes-Benz Center. Do not transport a child on the front-passenger seat until OCS has been repaired. ► Observe the additional display messages in the multifunction display (► page 179).

Warning

If the  indicator lamp does not illuminate or remains out with the weight of a typical 12-month-old child in a standard child restraint or less, or is unoccupied, on the front-passenger seat, do not transport a child on the front-passenger seat until the system has been repaired.

BabySmart™ air bag deactivation system

How the air bag deactivation system functions

The BabySmart™ system is standard equipment in Canada.

Warning

According to accident statistics, children are safer when properly restrained on the rear seats than on the front-passenger seat. For this reason, Mercedes-Benz strongly advises that you always secure children in the rear seats. Regardless of seating position, children 12 years old and under must be seated and properly secured in an appropriately sized child restraint system or booster seat recommended for the size and weight of the child.

Secure the infant restraint system or child restraint system, using:

- the vehicle's seat belt
- the seat belt and a Top Tether belt
- the LATCH-type (ISOFIX) child seat mount and a Top Tether belt





The child restraint system must be installed and secured correctly, observing the manufacturer's installation instructions.

Occupants, especially children, should always sit as upright as possible, wear the seat belt properly and use an appropriately sized infant restraint, toddler restraint, or booster seat recommended for the size and weight of the child.

Children can be killed or seriously injured by an inflating air bag. Observe the following important information if it is necessary to carry a child on the front-passenger seat:

- Children under 12 years may only sit in the front-passenger seat if they are seated in a child restraint system which is compatible with BabySmart™ and approved by Mercedes-Benz. If the child restraint system is installed properly, the front-

passenger front air bag is deactivated in conjunction with the BabySmart™ system. Otherwise, the child could be struck by the air bag when it inflates in a crash. This could lead to serious or fatal injury.

- A child in a rear-facing child restraint on the front-passenger seat will be seriously injured or even killed if the front-passenger front air bag inflates in a collision which could occur under some circumstances, even with the air bag technology installed in your vehicle. The only means to eliminate this risk completely is never to place a child in a rear-facing child restraint in the front-passenger seat. We therefore strongly recommend that you always place a child in a rear-facing child restraint on the rear seat.
- If it is necessary to install a BabySmart™-compatible rear-facing child restraint system on the front-passenger seat, make sure the  indicator lamp is illuminated. This indicates that the front-passenger front air bag is deactivated. If the  indicator lamp does not light up or goes out when the child restraint system is installed, check the anchorages of the restraint system. Periodically check the  indicator lamp while driving to make sure the  is illuminated. If the  indicator lamp goes out or remains out, do not transport a child on the front-passenger seat until the system has been repaired.

A child in a rear-facing child restraint on the front-passenger seat will be seriously

injured or even killed if the front-passenger front air bag inflates.

- If you have to place a child in a forward-facing child restraint system on the front-passenger seat, you must:
 - move the seat as far back as possible
 - use the proper child restraint recommended for the age, size and weight of the child
 - secure child restraint with the vehicle's seat belt according to the child seat manufacturer's instructions

Warning



The BabySmart™ air bag disabling system ONLY works with specially adapted child restraint systems. It does not work with child restraint systems that are not compatible with BabySmart™.

Never place anything between the seat cushion and the child restraint system (e.g. a cushion), as this reduces the effectiveness of the BabySmart™ air bag deactivation system. The underside of the child restraint system must lie against the seat cushion of the front-passenger seat. In the event of an accident, an incorrectly installed child restraint system could injure the child instead of offering protection.

Observe the manufacturer's instructions when installing special child restraint systems.

Warning

When using a BabySmart™-compatible child restraint system on the front-passenger seat, the front-passenger front air bag is only disabled if the  indicator lamp is illuminated.

Check the  indicator lamp repeatedly, every time you use a BabySmart™-compatible child restraint system on the front-passenger seat. Should the  indicator lamp not illuminate or go out while the restraint is installed, please check installation. If the 

indicator lamp remains out, do not use the BabySmart™ child restraint system to carry a child on the front-passenger seat until the system has been repaired.



Special child restraint systems which are compatible with BabySmart™ are necessary for deactivating the front-passenger front air bag. When the special child restraint system which is compatible with BabySmart™ is installed correctly and is recognized by the sensor system in the front-passenger seat, the front-passenger front air bag is deactivated. In this case,  indicator lamp ① illuminates. If you have any questions regarding the special child restraint systems which are compatible with BabySmart™, consult an authorized Mercedes-Benz Center.

If the key has been removed from the ignition lock or is in position 0, indicator lamp

 ① does not light up.

The system does not deactivate:

- the side impact air bag
- the pelvis air bag
- the window curtain air bag
- the Emergency Tensioning Devices

System self-test

The  indicator lamp illuminates when you:

- turn the SmartKey to position **1** or **2** in the ignition lock
- on vehicles with KEYLESS-GO, press the Start-Stop button once or twice



The  indicator lamp goes out again after approximately six seconds.

If the  indicator lamp does not illuminate or is lit continuously, the system is malfunctioning. Before transporting a child on the front-passenger seat, have the BabySmart™ system checked at an authorized Mercedes-Benz Center.



For more information, see "Problems with the air bag deactivation system" section (▷ page 49)

Warning



Do not place powered-on laptops, mobile phones, electronic tags such as those used in ski passes or similar electronic devices on the front passenger seat. Signals from such devices may interfere with the BabySmart™ air bag deactivation system. Such signal interference may cause the  indicator lamp not to come on during self-test.





The  SRS indicator lamp and/or the  indicator lamp could be continuously lit, indicating that the system is not functioning. The front-passenger front air bag could deploy inadvertently or fail to deploy in an accident.

Problems with the air bag deactivation system

Problem	Possible causes/consequences and ► Solutions
The   indicator lamp illuminates and remains illuminated.	<p>A special BabySmart™ compatible child restraint system is installed on the front-passenger seat.</p> <p>The front-passenger front air bag is therefore deactivated.</p> <p>A BabySmart™-compatible child restraint system is not installed on the front-passenger seat. The BabySmart™ system is malfunctioning.</p> <p>► Have the BabySmart™ system checked as soon as possible at an authorized Mercedes-Benz Center.</p>

Warning

If the   indicator lamp illuminates and remains illuminated when the weight of a typical adult or someone larger than a small individual has been detected on the passenger seat, do not allow any occupant to use the passenger seat until the system has been repaired.

Problem	Possible causes/consequences and ► Solutions
The   indicator lamp does not illuminate or does not remain illuminated with a BabySmart™-compatible child restraint system properly installed on the front-passenger seat.	<p>The BabySmart™ system is malfunctioning.</p> <ul style="list-style-type: none"> ► Make sure there is nothing between the seat cushion and the child seat. ► Check the installation of the child restraint system. ► If the   indicator lamp does not illuminate, have the BabySmart™ system checked as soon as possible at an authorized Mercedes-Benz Center. <p>Do not transport a child on the front-passenger seat until the child seat recognition system has been repaired.</p>

NECK-PRO head restraints

The NECK-PRO head restraints increase protection for the driver's and front-passenger's head and neck. In the event of a rear collision of a certain severity, the NECK-PRO head restraints on the driver's and front-passenger seats are moved forwards and upwards. This provides better head support.

Warning

Do not secure any objects (e.g. coat hangers) on the NECK-PRO head restraints. Otherwise, the NECK-PRO head restraints may not

function properly, or in the event of a rear-end collision may not be able offer the level of protection they are designed to provide.

Warning

Only use seat covers/head restraint covers that have been tested and approved by Mercedes-Benz for your model.

Using seat covers and head restraint covers other than those recommended may cause a malfunction when NECK-PRO head restraints are triggered or front side impact air bags/

pelvis air bags may be prevented from deploying.

Contact an authorized Mercedes-Benz Center for availability.

If the NECK-PRO head restraints have been triggered in an accident, you must reset the NECK-PRO head restraints on the driver's and front-passenger seat (▷ page 50).

Otherwise, the additional protection will not be available in the event of another rear-end collision. You can recognize that NECK-PRO head restraints have been triggered by the fact that they have moved forwards and can no longer be adjusted.

Warning!

For your protection, drive only with properly positioned head restraints.

Adjust the head restraint so that it is as close to the head as possible and the center of the head restraint supports the back of the head at eye level. This will reduce the potential for injury to the head and neck in the event of an accident or similar situation.

Resetting triggered NECK-PRO head restraints

Warning

For safety reasons, have the NECK-PRO head restraints checked at an authorized Mercedes-Benz Center after a rear-end collision.

Warning

When pushing back the NECK-PRO head restraint cushion, make sure your fingers do not become caught between the head restraint cushion and the cover. Failure to observe this could result in injuries.

-  Resetting the NECK-PRO head restraints requires a lot of strength. If you have difficulty resetting the NECK-PRO head restraints, have this work carried out at a

qualified specialist workshop, e.g. an authorized Mercedes-Benz Center.

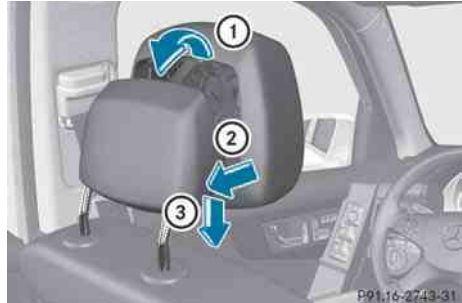

- ▶ Press the base of the NECK-PRO head restraint cushion back in the direction of arrow ② as far as it will go.
- ▶ Push the NECK-PRO head restraint cushion down into the guide in the direction of arrow ③ as far as it will go.
- ▶ Firmly fold the NECK-PRO head restraint cushion back in the direction of arrow ① until it engages.
- ▶ Repeat this procedure for the second NECK-PRO head restraint.

Seat belts

Important safety notes

The use of seat belts and infant and child restraint systems is required by law in all 50 states, the District of Columbia, the U.S. territories and all Canadian provinces.

Even where this is not the case, all vehicle occupants should have their seat belts fastened when the vehicle is in motion.

-  See "Children in the vehicle" (▷ page 55) for more information on infants and children traveling with you in the vehicle and restraints for infants and children.

Warning!

Always fasten your seat belt before driving off. Always make sure all of your passengers are

properly restrained. You and your passengers should always wear seat belts.

Failure to wear and properly fasten and position your seat belt greatly increases your risk of injuries and their likely severity in an accident.

If you are ever in an accident, your injuries can be considerably more severe without your seat belt properly buckled. Without your seat belt buckled, you are much more likely to hit the interior of the vehicle or be ejected from it. You can be seriously injured or killed.

In the same crash, the possibility of injury or death is lessened if you are properly wearing your seat belt. The air bags can only protect as intended if the occupants are properly wearing their seat belts.

Warning

Never ride in a moving vehicle with the seat backrest in an excessively reclined position as this can be dangerous. You could slide under the seat belt in a collision. If you slide under it, the seat belt would apply force at the abdomen or neck. That could cause serious or even fatal injuries. The seat backrest and seat belt provide the best restraint when the wearer is in a position that is as upright as possible and the seat belt is properly positioned on the body.

Warning

Never let more people ride in the vehicle than there are seat belts available. Make sure everyone riding in the vehicle is correctly restrained with a separate seat belt. Never use a seat belt for more than one person at a time.

Warning

Damaged seat belts or seat belts that have been subjected to stress in an accident must be replaced and their anchoring points must also be checked.

Only use seat belts which have been approved by Mercedes-Benz.

Do not make any modifications to the seat belts. This can lead to unintended activation of the ETDs or to their failure to activate when necessary.

Do not bleach or dye seat belts as this may severely weaken them. In a crash they may not be able to provide adequate protection.

Have all work carried out only by qualified technicians. Contact an authorized Mercedes-Benz Center.

Correct use of the seat belt

Warning

USE SEAT BELTS PROPERLY

- Seat belts can only work when used properly. Never wear seat belts in any other way than as described in this section, as that could result in serious injuries in the event of an accident.
- Each occupant should wear their seat belt at all times, because seat belts help reduce the likelihood of and potential severity of injuries in accidents, including rollovers. The integrated restraint system includes SRS (driver front air bag, driver's side knee bag, front-passenger front air bag, side impact air bags, pelvis air bags, window curtain air bags for the side windows), Emergency Tensioning Devices, seat belt force limiters, and front seat knee bolsters. The system is designed to enhance the protection offered to properly belted occupants in certain frontal (front air bags, driver's side knee bag and ETDs) and side (side impact air bags, window curtain air bags, and ETDs) impacts which exceed preset deployment thresholds and in certain rollovers (window curtain air bags and ETDs).
- Never wear the shoulder belt under your arm, across your neck or off your shoulder. In a frontal crash, your body would move too far forward. That would increase the chance of head and neck injuries. The seat belt would also apply too much force to the

ribs or abdomen, which could severely injure internal organs such as your liver or spleen.

Adjust the seat belt so that the shoulder section is located as close as possible to the middle of the shoulder. It should not touch the neck. Never pass the shoulder portion of the seat belt under your arm. For this purpose, you can adjust the height of the seat belt outlet.

- Position the lap belt as low as possible on your hips and not across the abdomen. If the lap belt is positioned across your abdomen, it could cause serious injuries in a crash.
- Never wear seat belts over rigid or breakable objects in or on your clothing, such as eyeglasses, pens, keys etc., as these might cause injuries.
- Make sure the seat belt is always fitted snugly. Take special care of this when wearing loose clothing.
- Never use a seat belt for more than one person at a time. Do not fasten a seat belt around a person and another person or other objects at the same time.
- Seat belts should not be worn twisted. In a crash, you would not have the full width of the seat belt to distribute impact forces. The twisted seat belt against your body could cause injuries.
- Pregnant women should also always use a lap-shoulder belt. The lap belt portion should be positioned as low as possible on the hips to avoid any possible pressure on the abdomen.
- Place the seat backrest in a position that is as upright as possible.
- Check your seat belt during travel to make sure it is properly positioned.
- Never place your feet on the instrument panel, dashboard, or on the seat. Always

keep both feet on the floor in front of the seat.

- When using a seat belt to secure infant restraints, toddler restraints, or children in booster seats, always follow the child seat manufacturer's instructions.

Warning

Do not pass seat belts over sharp edges. They could tear.

Do not allow the seat belt to get caught in the door or in the seat adjustment mechanism. This could damage the seat belt.

Never attempt to make modifications to seat belts. This could impair the effectiveness of the seat belts.

Fastening seat belts

Warning

According to accident statistics, children are safer when properly restrained on the rear seats than on the front-passenger seat. Thus, we strongly recommend that children be placed in the rear seat whenever possible. Regardless of seating position, children 12 years old and under must be seated and properly secured in an appropriately sized child restraint system or booster seat recommended for the size and weight of the child. For additional information, see the "Children in the vehicle" section.

A child's risk of serious or fatal injuries is significantly increased if the child restraints are not properly secured in the vehicle and/or the child is not properly secured in the child restraint.

Warning

Canada only: children 12 years old and under may ride on the front seat if a BabySmart™ compatible child restraint system is installed on the front-passenger seat. Use only Mercedes-Benz approved BabySmart™ compatible child restraint systems. A BabySmart™ compatible child restraint

system will deactivate the front-passenger front air bag when installed correctly. The front-passenger front air bag will not be deactivated if the child restraint systems that are installed are not BabySmart™ compatible or if BabySmart™ compatible child restraint systems are not installed correctly. If the front-passenger front air bag is deployed in a collision, the child will be struck by the air bag. If this happens, serious or fatal injury will result.



- ▶ Adjust the seat and move the backrest to an almost vertical position (▷ page 90).
- ▶ Pull the seat belt smoothly through belt sash guide ①.
- ▶ Without twisting it, guide the shoulder section of the seat belt across the middle of your shoulder and the lap section across your hips.
- ▶ Engage belt tongue ② in buckle ③.
- ▶ If necessary, adjust the seat belt to the appropriate height (▷ page 53).
- ▶ If necessary, pull upwards on the shoulder section of the seat belt to tighten the belt across your body.

All seat belts in the vehicle, except the driver's seat belt, are equipped with a special seat belt retractor to secure child restraint systems properly. For further information on

"Special seat belt retractors", see (▷ page 58).

For more information about releasing the seat belt with release button ④, see "Releasing seat belts" (▷ page 54).

Seat belt outlet height adjustment

You can adjust the seat belt height on the driver's seat and the front-passenger seat.



Adjust the height so that the upper part of the seat belt is routed across the center of your shoulder.

- ▶ **To raise:** slide the belt sash guide upwards. The belt sash guide engages in various positions.
- ▶ **To lower:** press and hold belt sash guide release ①.
- ▶ Slide the belt sash guide downwards.
- ▶ Release belt sash guide release ① and make sure that the belt sash guide has engaged.

Using the seat belt on the center rear seat

If the left-hand rear seat backrest is folded down and back up again, the rear center seat belt may lock. The seat belt can then not be pulled out.

- ▶ **To unlock the rear center seat belt:** pull the seat belt out approximately 1 in (25 mm) from the belt outlet on the seat backrest and release again. The seat belt is retracted and released.

Releasing seat belts

▶ Press release button ④ (▷ page 52) and guide belt tongue ② back towards belt sash guide ①.



❗ Make sure that the seat belt is fully rolled up. Otherwise, the seat belt or belt tongue will be trapped in the door or in the seat mechanism. This could damage the door, the door trim panel and the seat belt. Damaged seat belts can no longer fulfill their protective function and must be replaced. Consult an authorized Mercedes-Benz Center.

Belt warning for driver and front passenger

Regardless of whether the driver's and front-passenger seat belts have already been fastened, the  seat belt warning lamp lights up for six seconds each time the engine is started. It then goes out once the driver and the front passenger have fastened their seat belts.

If the driver's seat belt is not fastened after the engine is started, an additional warning tone will sound. The warning tone goes out after approximately six seconds or once the driver's seat belt is fastened.

If, after six seconds, the driver or front-passenger have not fastened their seat belts and the doors are closed:

- the  seat belt warning lamp remains illuminated as long as either the driver's or front-passenger seat belt is not fastened.
- if the vehicle speed exceeds 15 mph (25 km/h), the  seat belt warning lamp lights up. Additionally, a warning tone will sound with increasing intensity for a maximum of 60 seconds or until the driver's and front-passenger seat belt are fastened.

If the driver/front passenger unfasten their seat belt while the vehicle is in motion, the

 seat belt warning lamp lights up and a warning tone sounds again.

The warning tone ceases even if the driver or front passenger have still not fastened their seat belt after 60 seconds. The  seat belt warning lamp stops flashing but remains illuminated.

After the vehicle comes to a standstill, the warning tone is reactivated and the  seat belt warning lamp flashes again if the vehicle speed again exceeds 15 mph (25 km/h).

The  seat belt warning lamp only goes out if:

- both the driver and the front passenger have fastened their seat belts.

or

- the vehicle is stationary and a door is open.

❗ For more information on the  seat belt warning lamp, see "Indicator and warning lamps in the instrument cluster, seat belt" (▷ page 196).

Emergency Tensioning Devices and seat belt force limiters

The front seat belts and the outer seat belts in the rear are equipped with ETDs and belt force limiters.

❗ If the front-passenger seat is not occupied, do not engage the seat belt tongue in the buckle on the front-passenger seat. Otherwise, the Emergency Tensioning Device could be triggered in the event of an accident.

The ETDs tighten the seat belts in an accident, pulling them close against the body.

ETDs do not correct incorrect seat positions or incorrectly fastened seat belts.

ETDs do not pull vehicle occupants back towards the backrest.

Seat belt force limiters, when activated, are employed to help reduce the force exerted by the seat belts on occupants during a crash.

The front belt force limiters are synchronized with the front air bags, which take on a part of the deceleration force. Thus, the force exerted on the occupant is distributed over a greater area.

The ETDs can only be activated if:

- the ignition is switched on.
- the restraint systems are operational; see "SRS warning lamp" (▷ page 34).
- the belt tongue is engaged in the buckle on each of the lap-shoulder belts in the front.
- the front-passenger seat is occupied and the belt tongue is engaged in the buckle on the front-passenger side.

The ETDs on the outside seats in the rear compartment are triggered independently of the lock status of the seat belts.

The ETDs are triggered depending on the type and severity of an accident:

- in the event of a head-on or rear-end collision if the vehicle decelerates or accelerates rapidly in a longitudinal direction during the initial stages of the impact
- in the event of a side impact, on the side opposite the impact if the vehicle decelerates or accelerates rapidly in a lateral direction
- in certain situations if the vehicle overturns and the system determines that it can provide additional protection

If the Emergency Tensioning Devices (ETDs) are triggered, you will hear a bang, and a small amount of powder may also be released. Only in rare cases will the bang affect your hearing. The powder that is released generally does not constitute a health hazard. The  SRS warning lamp lights up.

Warning

Pyrotechnic ETDs that were activated must be replaced.

For your safety, when disposing of the pyrotechnic ETDs always follow our safety

instructions. These are available at any authorized Mercedes-Benz Center.

Children in the vehicle

Important safety notes

Warning

When leaving the vehicle, always remove the SmartKey from the ignition lock. Always take the SmartKey with you and lock the vehicle. Do not leave children unattended in the vehicle, even if they are secured in a child restraint system, or with access to an unlocked vehicle. A child's unsupervised access to a vehicle could result in an accident and/or serious personal injury. The children could:

- injure themselves on parts of the vehicle
- be seriously or fatally injured through excessive exposure to extreme heat or cold
- injure themselves or cause an accident with vehicle equipment that can be operated even if the SmartKey is removed from the ignition lock or removed from the vehicle, such as seat adjustment, steering wheel adjustment, or the memory function

If children open a door, they could injure other persons or get out of the vehicle and injure themselves or be injured by following traffic.

Do not expose the child restraint system to direct sunlight. The child restraint system's metal parts, for example, could become very hot, and the child could be burned on these parts.

Warning!

Do not carry heavy or hard objects in the passenger compartment or trunk unless they are firmly secured in place.

Unsecured or improperly positioned cargo increases a child's risk of injury in the event of

- strong braking maneuvers
- sudden changes of direction
- an accident

If an infant or child is traveling in the vehicle:

- ▶ Secure the child using an infant or child restraint system appropriate to the age and weight of the child.
- ▶ Make sure that the infant or child is properly secured at all times while the vehicle is in motion.

Child restraint systems

Important safety notes

Warning

Observe "Important safety notes" (▶ page 55).

We recommend all infants and children be properly restrained using the child restraint systems at all times while the vehicle is in motion.

The use of infant or child restraints is required by law in all 50 states, the District of Columbia, the U.S. territories and all Canadian provinces.

Infants and small children should always be seated in an infant or child seat restraint system appropriate for the size and weight of the child. They must be properly secured in accordance with the manufacturer's installation instructions for the infant or child seat restraint system. All infant and child seat restraint systems must comply with the US Federal Motor Vehicle Safety Standards 213 and 225 and Canadian Motor Vehicle Safety Standards 213 and 210.2.

A statement by the child restraint manufacturer of compliance with these standards can be found on the instruction

label on the restraint system. You will also find the statement in the instruction manual provided with the child restraint system.

When using an infant restraint system, child restraint system or booster seat, make sure to carefully read and follow all manufacturer's instructions for installation and use.

Please read the warning labels affixed to the interior of the vehicle or to the infant restraint or child restraint system.

Warning

Accident statistics show that children secured in the rear seats are safer than children secured in the front-passenger seat. For this reason, we strongly advise that you always secure children in the rear seats. Regardless of the seat position, children under 12 years must be secured correctly in a suitable infant or child restraint system or booster seat suitable for the size and weight of the child.



The infant or child restraint system must be correctly secured using the vehicle's seat belt, the seat belt and Top Tether belt or the lower anchorages and the Top Tether belt in complete accordance with the child seat manufacturer's instructions.





Occupants, in particular children, must sit as upright as possible, fasten the seat belt correctly and use a suitable infant restraint system, child restraint system or booster seat suitable for the size and weight of the child.

Children can be seriously or even fatally injured by an air bag deploying. Observe the following important information if it is absolutely necessary to carry a child on the front-passenger seat:

- USA only: Your vehicle is equipped with air bag technology that is designed to deactivate the front-passenger front air bag, when the system on the front-passenger seat detects the weight of a

typical 12-month old child in a standard child restraint.

- USA only: For children that weigh more than a typical 12-month old child, the front-passenger front air bag can be activated or deactivated. Always make sure that the  indicator lamp is illuminated indicating that the front-passenger front air bag is deactivated.
- Canada only: Children 12 years old and under may ride on the front seat if a BabySmart™ compatible child restraint system is installed on the front-passenger seat. Use only Mercedes-Benz approved BabySmart™ compatible child restraint systems. A BabySmart™ compatible child restraint system will deactivate the front-passenger front air bag when installed correctly. The front-passenger front air bag will not be deactivated if the child restraint systems that are installed are not BabySmart™ compatible or if BabySmart™ compatible child restraint systems are not installed correctly. If the front-passenger front air bag is deployed in a collision, the child could be struck by the air bag. This could lead to serious or fatal injury.
- A child in a rear-facing child restraint on the front-passenger seat will be seriously injured or even killed if the front-passenger front air bag inflates in a collision which could occur under some circumstances, even with the air bag technology installed in your vehicle. The only way to completely rule out this risk is by making sure you never place a child in a rearward-facing child restraint system on the front-passenger seat. For this reason, we strongly advise that you always carry children in a rearward-facing child restraint system on a rear seat.
- If you must install a rear-facing child restraint on the front-passenger seat because circumstances require you to do so, make sure the  indicator lamp is illuminated, indicating that the front-

passenger front air bag is deactivated. If the  indicator lamp does not light up or goes out when the child restraint system is installed, check the anchorages of the restraint system. Check the  indicator lamp regularly while driving to ensure that the  indicator lamp is illuminated. If the  indicator lamp goes out or remains out, you may only carry a child on the front-passenger seat once the system has been repaired.

A child in a rear-facing child restraint on the front-passenger seat will be seriously injured or even killed if the front-passenger front air bag inflates.

- when securing a child in a child restraint system on the front-passenger seat, you must:
 - move the front-passenger seat as far back as possible
 - use a child restraint system that is suitable for the age, size and weight of the child
 - observe the manufacturer's installation instructions in order to install and secure the child restraint system correctly.

Warning

Infants and small children should never share a seat belt with another occupant. During an accident, they could be crushed between the occupant and seat belt.

A child's risk of serious or fatal injuries is significantly increased if the child restraints are not properly secured in the vehicle and/or the child is not properly secured in the child restraint.

Children too big for a toddler restraint must ride in seats using regular seat belts. Position the shoulder belt across the chest and shoulder, not face or neck. A booster seat may be necessary to achieve proper seat belt positioning for children over 41 lb (18 kg) until they reach a height where a lap/shoulder belt fits properly without a booster.

When the child restraint is not in use, remove it from the vehicle or secure it with the seat belt to prevent the child restraint from becoming a projectile in the event of an accident.

Special seat belt retractor

Warning

Observe "Important safety notes" (▷ page 55).

All seat belts in the vehicle, except the driver's seat belt, are equipped with a special seat belt retractor. When activated, the special seat belt retractor ensures that the seat belt cannot slacken after being fastened.

Installing a child restraint system:

- ▶ Always comply with the manufacturer's installation instructions.
- ▶ Pull the seat belt smoothly from the inertia reel.
- ▶ Engage the seat belt tongue in the belt buckle.

Activating the special seat belt retractor:

- ▶ Pull the seat belt out fully and let the inertia reel retract it again.
While the seat belt is retracting, you should hear a ratcheting sound. The special seat belt retractor function is enabled.
- ▶ Push down on the child restraint system to take up any slack.

Removing a child restraint system/
deactivating the special seat belt retractor:

- ▶ Always comply with the manufacturer's installation instructions.
- ▶ Press the seat belt release button and guide the belt tongue to the belt outlet. The special seat belt retractor function is deactivated.

Warning

Never release the seat belt buckle while the vehicle is in motion, since the special seat belt retractor will be deactivated.

LATCH-type (ISOFIX) child seat anchors in the rear

Warning

Observe "Important safety notes" (▷ page 55).

Warning

Children that are too large for a child restraint must travel in seats using normal seat belts. Position shoulder belt across the chest and shoulder, not face or neck.

In order to attain the correct seating position for children weighing over 41 lb (18 kg), it may be necessary to use a booster seat until they reach a height where a normal lap/shoulder seat belt lies properly across their bodies without the need for a booster seat.

Install the child restraint system according to the manufacturer's instructions.

The child restraint system must be installed firmly on both brackets.

An incorrectly installed child restraint system can come loose in the event of an accident, causing the child to be severely or fatally injured.

Child restraint systems/child restraint retaining brackets that are damaged or have suffered damage due to an impact must be replaced.

ISOFIX is a standardized securing system for specially designed child restraint systems on the rear seats. Securing rings for two LATCH-type (ISOFIX) child restraint systems are installed on the left and right of the rear seats. Use the vehicle's seat belts to install child restraint systems without the ISOFIX securing system. Follow the manufacturer's instructions for of child restraint systems.

- ❗ When installing the child restraint system, make sure that the seat belt for the center seat does not get trapped. Otherwise, the seat belt could be damaged.

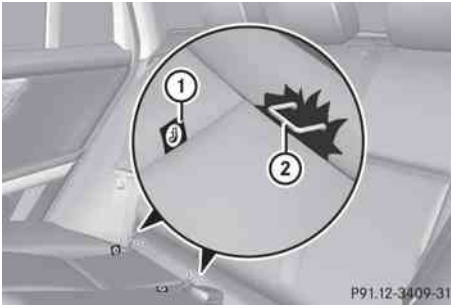

Installation instruction ① indicates the installation point of securing ring ②.

- ▶ Install the LATCH-type (ISOFIX) child restraint system. Comply with the manufacturer's instructions when installing the LATCH-type (ISOFIX) child restraint system.

Top Tether

Warning

Observe "Important safety notes" (▶ page 55).

Warning

Always lock the rear seat backrests in their upright position when the rear seats are occupied by passengers. Lock the rear seat backrests in their upright position before installing the Top Tether straps or when the cargo compartment is not in use. Make sure that rear seat backrests are secured properly by pushing and pulling on the seat backrests. If the seat backrest is not locked properly, the seat backrest could fold forward. The child restraint system is no longer supported properly or held in position and can no longer fulfill its function. This could cause serious or even fatal injuries.

Top Tether provides an additional attachment point between the "LATCH" type child seat mount (ISOFIX) child restraint system and the rear seat. This can further reduce the risk of injury.

The Top Tether anchorages are located on the rear of the rear seat backrests.

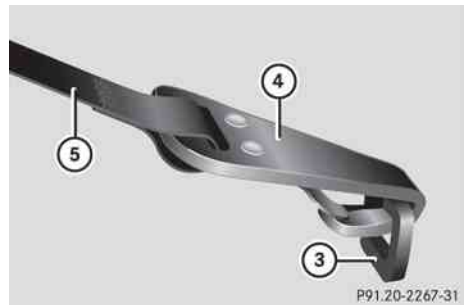
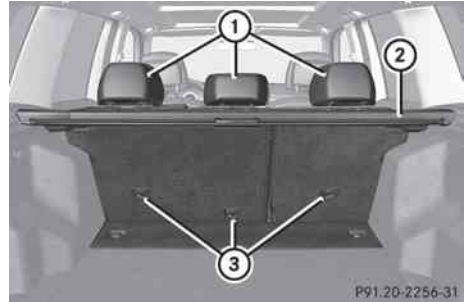

- ▶ Move head restraint ① upwards.
- ▶ Install the LATCH-type (ISOFIX) child restraint system with Top Tether. Always comply with the manufacturer's installation instructions.
- ▶ Route Top Tether belt ⑤ under the head restraint ① between both head restraint bars.
- ▶ Route Top Tether belt ⑤ downwards between the cargo compartment cover ② and rear seat backrest.
- ▶ Engage Top Tether hook ④ of Top Tether belt ⑤ into Top Tether anchorage ③.

Make sure that:

- Top Tether hook ④ is engaged in Top Tether anchorage ③, as illustrated.
 - Top Tether belt ⑤ is not twisted.
 - Top Tether belt ⑤ is routed between rear seat backrest and cargo compartment cover ② if cargo compartment cover ② is installed.
 - Top Tether belt ⑤ is routed between the rear seat backrest and the cargo net if the cargo net is installed.
- Tension Top Tether belt ⑤. Always comply with the manufacturer's installation instructions.
- If necessary, push head restraint ① back down slightly (► page 93). Make sure that the routing of Top Tether belt ⑤ is not impaired.

Child-proof locks

Child-proof locks for the rear doors

Warning

Observe "Important safety notes" (► page 55).

Warning

Children could open a rear door from inside the vehicle. This could result in serious injuries or an accident. Therefore, when children ride in the rear always secure the rear doors with the child-proof locks.

You can secure each door individually with the child-proof locks on the rear doors. A door secured with a child-proof lock cannot be opened from inside the vehicle. When the vehicle is unlocked, the door can be opened from the outside.

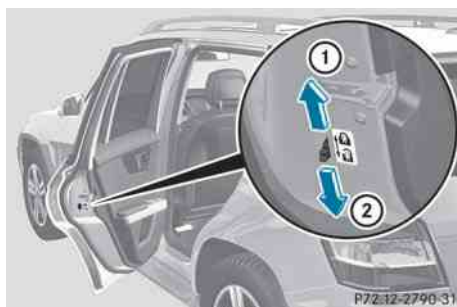

- **To activate:** press the child-proof lock lever up in the direction of arrow ①.
- Make sure that the child-proof locks are working properly.
- **To deactivate:** press the child-proof lock lever down in the direction of arrow ②.

Override feature for the rear side windows

Warning

Observe "Important safety notes" (► page 55).

Warning

When children ride on the vehicle's rear seats, activate the override switch. Otherwise, the children could be injured, e.g. by trapping themselves in the rear side window.

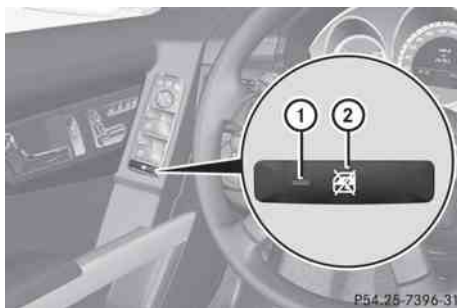

- **To activate/deactivate:** press button ②. If indicator lamp ① is lit, operation of the rear side windows is disabled. Operation is only possible using the switches in the driver's door. If indicator lamp ① is off,

operation is possible using the switches in the rear compartment.

Panic alarm



► **To activate:** press and hold **PANIC** button ① for about one second. An alarm sounds and the exterior lighting flashes.

► **To deactivate:** press **PANIC** button ① again.

or

► Insert the SmartKey into the ignition lock. or

► Press the KEYLESS-GO Start-Stop button. The KEYLESS-GO key must be in the vehicle.

i USA only:

This device complies with the part 15 of the FCC regulations. Operation is subject to the following two conditions:

1. This device may not cause interference, and
2. This device must withstand any interference received, including interference that may cause undesired operation.

Any unauthorized modification to this device could void the user's authority to operate the equipment.

i Canada only:

This device complies with the RSS-210 regulations of Industry Canada. Operation is subject to the following two conditions:

1. This device may not cause interference, and
2. This device must withstand any interference received, including interference that may cause undesired operation of the device.

Any unauthorized modification to this device could void the user's authority to operate the equipment.

Driving safety systems

Overview of driving safety systems

In this section, you will find information about the following driving safety systems:

- ABS (**A**nti-**l**ock **B**raking **S**ystem)
- BAS (**B**rake **A**ssist **S**ystem)
- ESP® (**E**lectronic **S**tability **P**rogram)
- EBD (**E**lectronic **B**rake-**p**ower **D**istribution)

Important safety notes

⚠ Warning

The following factors increase the risk of accidents:

- Excessive speed, especially in turns
- Wet and slippery road surfaces
- Following another vehicle too closely

The driving safety systems described in this section cannot reduce these risks or prevent the natural laws of physics from acting on the vehicle. They cannot increase braking or steering efficiency beyond that afforded by the condition of the vehicle brakes and tires or the traction afforded.

Only a safe, attentive, and skillful driver can prevent accidents.

The capabilities of a vehicle equipped with the driving safety systems described in this section must never be exploited in a reckless

or dangerous manner which could jeopardize the user's safety or the safety of others.

Always adjust your driving style to the prevailing road and weather conditions and keep a safe distance to other road users and objects on the street.

If a driving system malfunctions, other driving safety systems may also switch off. Observe indicator and warning lamps that may come on as well as messages in the multifunction display that may appear.

- i** In wintry driving conditions, always use winter tires (M+S tires) and if necessary, snow chains. Only in this way will the driving safety systems described in this section work as effectively as possible.

ABS (Anti-lock Braking System)

Important safety notes

Warning

Observe "Important safety notes" (▷ page 61).

Warning

Do not pump the brake pedal. Use firm, steady brake pedal pressure instead. Pumping the brake pedal defeats the purpose of the ABS and significantly reduces braking effectiveness.

ABS regulates brake pressure in such a way that the wheels do not lock when you brake. This allows you to continue steering the vehicle when braking.

ABS works from a speed of about 5 mph (8 km/h) upwards, regardless of road-surface conditions. ABS works on slippery surfaces, even when you only brake gently.

The  warning lamp in the instrument cluster lights up when the ignition is switched on. It goes out when the engine is running.

Braking

If ABS intervenes when braking, you will feel a pulsing in the brake pedal.

- ▶ **If ABS intervenes:** continue to depress the brake pedal with force until the braking situation is over.
- ▶ **To make a full brake application:** depress the brake pedal with full force.

Warning

If the ABS malfunctions, other driving systems such as the BAS or the ESP® are also switched off. Observe indicator and warning lamps that may come on as well as messages in the multifunction display that may appear.

If the ABS malfunctions, the wheels may lock during hard braking, reducing the steering capability and extending the braking distance.

The pulsating brake pedal can be an indication of hazardous road conditions and functions as a reminder to take extra care while driving.

BAS (Brake Assist)

Warning

Observe "Important safety notes" (▷ page 61).

BAS operates in emergency braking situations. If you depress the brake pedal quickly, BAS automatically boosts the braking force, thus shortening the stopping distance.

- ▶ Keep the brake pedal firmly depressed until the emergency braking situation is over. ABS prevents the wheels from locking.

The brakes will function as usual once you release the brake pedal. BAS is deactivated.

Warning

If the BAS malfunctions, the brake system still functions, but without the additional brake boost available that the BAS would normally provide in an emergency braking maneuver. Therefore, the braking distance may increase.

ESP® (Electronic Stability Program)**Important safety notes** **Warning**

Observe "Important safety notes"
(▷ page 61).

If ESP® detects that the vehicle is deviating from the direction desired by the driver, one or more wheels are braked to stabilize the vehicle. If necessary, the engine output is also modified to keep the vehicle on the desired course within physical limits. ESP® assists the driver when pulling away on wet or slippery roads. ESP® can also stabilize the vehicle during braking.

If ESP® intervenes, the  warning lamp flashes in the instrument cluster.

 **Warning!**

Never switch off the ESP when you see the ESP warning lamp  flashing in the instrument cluster. In this case proceed as follows:

- When driving off, apply as little throttle as possible.
- While driving, ease up on the accelerator pedal.
- Adapt your speed and driving style to the prevailing road conditions.

Failure to observe these guidelines could cause the vehicle to skid. The ESP cannot prevent accidents resulting from excessive speed.

-  Vehicles without 4MATIC: switch the ignition off when:
- the parking brake is being tested using a dynamometer
 - the vehicle is being towed with the front/rear axle raised

Application of the brakes by ESP® may otherwise destroy the brake system.

-  Vehicles with 4MATIC: switch off the ignition when the parking brake is being tested on a brake dynamometer.

Application of the brakes by ESP® may otherwise destroy the brake system.

-  Vehicles with 4MATIC: function or performance tests may only be carried out on a 2-axle dynamometer. If you wish to operate the vehicle on such a dynamometer, please consult an authorized Mercedes-Benz Center in advance. You could otherwise damage the drive train or the brake system.

-  Only use wheels with the recommended tire sizes. Only then will ESP® function properly.

ETS/4ETS (Electronic Traction System) **Warning**

Observe "Important safety notes"
(▷ page 61).

Traction control is part of ESP®.

Traction control brakes the drive wheels individually if they spin. This enables you to pull away and accelerate on slippery surfaces, for example if the road surface is slippery on one side. On vehicles with 4MATIC, more drive torque is also transferred to the wheel or wheels with traction.

Traction control remains active if you deactivate ESP®.

Deactivating/activating ESP® **Warning**

The ESP® should not be switched off during normal driving other than in the circumstances described below. Disabling the system will reduce vehicle stability in driving maneuvers.

Do not switch off the ESP® when a spare wheel is mounted.

ESP® is activated automatically when the engine is running.

It may be best to deactivate ESP® in the following situations:

- when using snow chains
- in deep snow
- on sand or gravel

Warning!

Activate ESP® as soon as the situations described above no longer apply. ESP® will otherwise not be able to stabilize the vehicle if the vehicle starts to skid or a wheel starts to spin.

When you deactivate ESP®:

- ESP® no longer improves driving stability.
- the engine's torque is no longer limited and the drive wheels can spin. The spinning of the wheels results in a cutting action, which provides better grip.
- traction control is still activated.
- ESP® still provides support when you brake.

If ESP® is deactivated and one or more wheels start to spin, the  warning lamp in the instrument cluster flashes. In such situations, ESP® will not stabilize the vehicle.





► **To deactivate:** press button ①.

The  warning lamp in the instrument cluster lights up.

Warning

When the  ESP OFF warning lamp lights up, ESP is switched off.

When the  ESP warning lamp and the  ESP OFF warning lamp are on continuously, ESP is not operational due to a malfunction.

When ESP is switched off or not operational, the vehicle's stability during standard driving maneuvers is reduced.

Adapt your driving style to suit the prevailing road conditions/weather conditions and to the non-operating status of ESP.

❗ Avoid spinning a drive wheel for an extended period with ESP® switched off. This could cause serious damage to the drive train.

► **To activate:** press button ①.

The  warning lamp in the instrument cluster goes out.

ESP® trailer stabilization

If your trailer begins to lurch, you can only stabilize the vehicle/trailer combination by depressing the brake firmly.

In this situation, ESP® assists you and can detect if the trailer begins to lurch. ESP® slows the vehicle down by braking and limiting the engine output until the vehicle/trailer combination has stabilized.

Trailer stabilization is active from a speed above 40 mph (65 km/h).

Warning!

The system will not be able to assist when the trailer jackknifes

- if the ESP® has switched off due to a malfunction
- on wet or icy roads
- on roads with slippery surface
- in sand or gravel

Trailers with a high center of gravity may tip over before the system recognizes swaying of the trailer.

Trailer stabilization does not work if ESP® is deactivated or disabled because of a malfunction.

EBD

Warning

Observe "Important safety notes" (▷ page 61).

EBD monitors and controls the brake pressure on the rear wheels to improve driving stability while braking.

Warning!

If the EBD malfunctions, the brake system will still function with full brake boost. However, the rear wheels could lock up during emergency braking situations, for example. You could lose control of the vehicle and cause an accident.

Adapt your driving style to the changed driving characteristics.

Anti-theft systems

Immobilizer

The immobilizer prevents your vehicle from being started without the correct key.

When leaving the vehicle, always take the SmartKey with you and lock the vehicle. The engine can be started by anyone with a valid key that is left inside the vehicle.

- ▶ **To activate with the SmartKey:** remove the SmartKey from the ignition lock.
- ▶ **To activate with KEYLESS-GO:** switch the ignition off and open the driver's door.
- ▶ **To deactivate:** switch on the ignition.

 The immobilizer is always deactivated when you start the engine.

In the event that the engine cannot be started when the starter battery is fully charged, the immobilizer may be faulty. Contact an authorized Mercedes-Benz Center or call 1-800-FOR-MERCEdes (in USA) or 1-800-387-0100 (in Canada).

ATA (Anti-Theft Alarm system)

A visual and audible alarm is triggered if the alarm system is armed and you open:

- a door
- the vehicle with the mechanical key
- the tailgate
- the hood

The alarm is not switched off, even if you close the open door that has triggered it, for example.

-  If the alarm stays on for more than 30 seconds, the emergency call system mbrace (USA only) or TELEAID (Canada only) initiates a call to the Customer Assistance Center automatically. The emergency call system initiates the call provided that:
 - you have subscribed to the mbrace/TELEAID service.
 - the mbrace/TELEAID service has been activated properly.
 - the required mobile phone, power supply and GPS are available.





- ▶ **To arm:** lock the vehicle with the SmartKey or KEYLESS-GO.

Indicator lamp ① flashes. The alarm system is armed after approximately 15 seconds.

- ▶ **To deactivate:** unlock the vehicle using the SmartKey or KEYLESS-GO.

- ▶ **To stop the alarm using the SmartKey:** insert the SmartKey into the ignition lock. The alarm is switched off.

or

- ▶ Press the  or  button on the SmartKey. The alarm is switched off.

- ▶ **To stop the alarm using KEYLESS-GO:** grasp the outside door handle. The key must be outside the vehicle. The alarm is switched off.

or

- ▶ Press the Start/Stop button on the dashboard. The key must be inside the vehicle. The alarm is switched off.

Vehicle equipment	68
SmartKey	68
Doors	75
Cargo compartment	78
Side windows	81
Sliding sunroof	85

Vehicle equipment

- i** This manual describes all the standard and optional equipment of your vehicle which was available at the time of purchase. Country-specific differences are possible. Bear in mind that your vehicle may not feature all functions described here. This also refers to safety-related systems and functions.

SmartKey

Important safety notes

Warning!

When leaving the vehicle, always remove the SmartKey from the starter switch. Always take the SmartKey with you and lock the vehicle. Do not leave children unattended in the vehicle, even if they are secured in a child restraint system, or with access to an unlocked vehicle. A child's unsupervised access to a vehicle could result in an accident and/or serious personal injury. The children could

- injure themselves on parts of the vehicle
- be seriously or fatally injured through excessive exposure to extreme heat or cold
- injure themselves or cause an accident with vehicle equipment that can be operated even if the SmartKey is removed from the starter switch or removed from the vehicle, such as seat adjustment, steering wheel adjustment, or the memory function

If children open a door, they could injure other persons or get out of the vehicle and injure themselves or be injured by following traffic.

Do not expose the child restraint system to direct sunlight. The child restraint system's metal parts, for example, could become very hot, and the child could be burned by these parts.

Warning!

Do not carry heavy or hard objects in the passenger compartment or cargo compartment unless they are firmly secured in place.

Unsecured or improperly positioned cargo increases a child's risk of injury in the event of

- strong braking maneuvers
- sudden changes of direction
- an accident

General information

All doors and the tailgate must be closed.

If you cannot open or lock the vehicle with the SmartKey, either the battery in the SmartKey is empty, the SmartKey is faulty, or the vehicle battery is discharged.

- ▶ Check the battery in the SmartKey and replace it if necessary (▷ page 72).
- ▶ Unlock the driver's door using the mechanical key (▷ page 71).
- ▶ Lock the vehicle using the mechanical key (▷ page 71).
- ▶ Have the vehicle battery and battery contacts checked by an authorized Mercedes-Benz Center.

If the SmartKey is faulty, contact Roadside Assistance or an authorized Mercedes-Benz Center.



SmartKey functions

Locking and unlocking centrally

The SmartKey centrally locks/unlocks:

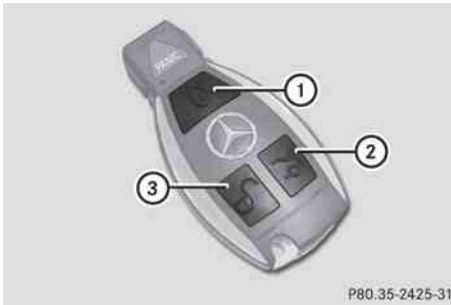
- the doors
- the tailgate
- the fuel filler flap



- ①  To lock the vehicle
- ②  To unlock the tailgate
- ③  To unlock the vehicle

When unlocking, the turn signals flash once. When locking, they flash three times.

When it is dark, the surround lighting also comes on if it is activated in the on-board computer.

You can also set an audible signal to confirm that the vehicle has been locked or unlocked. The audible signal can be activated and deactivated using the on-board computer (► page 173).

i Only for USA:

This equipment complies with Part 15 of the FCC regulations. Operation is subject to the following conditions:

- this equipment must not emit harmful, electromagnetic radiation.
- this equipment may be affected by electromagnetic radiation, including radiation which can trigger unwanted functions.

Any unauthorized change to this equipment can lead to the user's operating license being withdrawn.

i Only for Canada:

This equipment complies with the RSS-210 regulations of Industry Canada. Operation is subject to the following conditions:

- this equipment must not emit harmful, electromagnetic radiation.
- this equipment receives electromagnetic radiation, including radiation which can trigger unwanted functions.

Any unauthorized change to this equipment can lead to the user's operating license being withdrawn.

- ▶ **To unlock centrally:** press the  button.

If you do not open a door or the tailgate within approximately 40 seconds of unlocking the vehicle:

- the vehicle is locked again.
- the theft deterrent locking system is activated again.

- ▶ **To lock centrally:** press the  button.

KEYLESS-GO

General notes

i Only for USA:

This equipment complies with Part 15 of the FCC regulations. Operation is subject to the following conditions:

- this equipment must not emit harmful, electromagnetic radiation.
- this equipment may be affected by electromagnetic radiation, including radiation which can trigger unwanted functions.

Any unauthorized change to this equipment can lead to the user's operating license being withdrawn.

i Only for Canada:

This equipment has been released in accordance with RSS - 210 of Industry Canada. Operation is subject to the following conditions:

- this equipment must not emit harmful, electromagnetic radiation.
- this equipment receives electromagnetic radiation, including radiation which can trigger unwanted functions.

Any unauthorized change to this equipment can lead to the user's operating license being withdrawn.

Important information for using KEYLESS-GO

- You can use the KEYLESS-GO key as a conventional key.
- You can combine KEYLESS-GO functions with those of a conventional key (e.g. open with KEYLESS-GO and close with the  button).
- Always carry your KEYLESS-GO key on your person.
- Never keep the KEYLESS-GO key with:
 - electronic equipment, such as your mobile phone or another key
 - metal objects, such as coins or metal foil

This may impair the functioning of KEYLESS-GO.

- To open or close the vehicle, the KEYLESS-GO key should be no more than 3 ft (1 m) from the door or tailgate.
- When the vehicle is parked for more than 72 hours, the KEYLESS-GO function is deactivated. Pull one of the outer door handles and turn on the ignition to reactivate the KEYLESS-GO function.
- If the KEYLESS-GO key is not near the vehicle, it is possible that the system may not recognize it. In this case, the vehicle cannot be locked or started with KEYLESS-GO.
- If the KEYLESS-GO key has been removed from the vehicle (e.g. if a passenger leaves the vehicle with the KEYLESS-GO key):
 - while someone is holding the Start/Stop button or attempting to lock the vehicle with the outer door handle, the message

Key not detected appears in the multifunction display

- while the engine is running, the red message **Key not detected** appears in the multifunction display as you pull away. Find the KEYLESS-GO key or change its current position immediately (e.g. place it on the front-passenger seat or carry it in your shirt pocket.)
 - If you have started the engine using the Start/Stop button, you can turn it off again by:
 - pressing the Start/Stop button again
 - inserting the KEYLESS-GO key in the ignition lock when the vehicle is stationary and the automatic transmission is in parking position **P**.
 - You may accidentally unlock the vehicle if the KEYLESS-GO key is within 3 ft (1 m) of the vehicle and:
 - an outer door handle comes into contact with water
 - or
 - you are cleaning an outer door handle.
 - Note that the engine can be started by any vehicle occupant if a KEYLESS-GO key is in the vehicle.

Option 1: there is a KEYLESS-GO key in the vehicle and a KEYLESS-GO key outside the vehicle. If you leave the KEYLESS-GO key behind when you get out and lock the vehicle, a message does not appear in the multifunction display.

Option 2: there is a KEYLESS-GO key in the vehicle but no KEYLESS-GO key outside the vehicle. When you get out and try to lock the vehicle, the message **Key still in vehicle** appears in the multifunction display. The vehicle is not locked in this case.
- When starting the engine and while driving, KEYLESS-GO also checks whether a valid key is in the vehicle by periodically establishing radio contact.

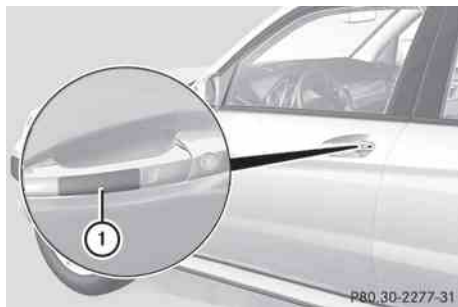

- ▶ **To unlock the vehicle:** touch the inner surface of the door handle.
- ▶ **To lock the vehicle:** touch sensor surface ①.



If you pull on the handle of the tailgate, only the cargo area of the vehicle is unlocked.

i If the vehicle has been parked for a long time, the sensor surfaces are deactivated automatically.



Pull the door handle to unlock the door and turn on the ignition once to activate the sensor surfaces again.

Changing the settings of the locking system

You can change the settings of the locking system in such a way that only the driver's door and the fuel filler flap are unlocked. This is useful if you frequently travel on your own.

- ▶ **To change the setting:** press the  and  buttons simultaneously for approximately six seconds until the battery check lamp flashes twice.



The SmartKey now functions as follows:

- ▶ **To unlock the driver's door:** press the  button once.
- ▶ **To unlock centrally:** press the  button twice.
- ▶ **To lock centrally:** press the  button.

The KEYLESS-GO function is changed as follows:

- ▶ **To unlock the driver's door:** touch the inner surface of the door handle on the driver's door.
- ▶ **To unlock centrally:** touch the inner surface of the door handle on the front-passenger door or the rear door.
- ▶ **To lock centrally:** touch sensor surface ① on one of the door handles.

Restoring the factory settings

- ▶ Press the  and  buttons simultaneously for approximately six seconds until the battery check lamp flashes twice.



Mechanical key

General notes

If the vehicle can no longer be locked or unlocked with the SmartKey, use the mechanical key.

If you use the mechanical key to unlock and open the driver's door, the anti-theft alarm system will be triggered (▷ page 65).

There are several ways to turn off the alarm:

- ▶ Press the  or  button on the SmartKey.
- or
- ▶ Insert the SmartKey into the ignition lock.
- or
- ▶ Press the Start/Stop button in the ignition lock. The SmartKey must be in the vehicle.
- or
- ▶ Lock or unlock the vehicle using KEYLESS-GO. The SmartKey must be outside the vehicle.

If you unlock the vehicle using the mechanical key, the fuel filler flap will not be unlocked automatically.

Removing the mechanical key

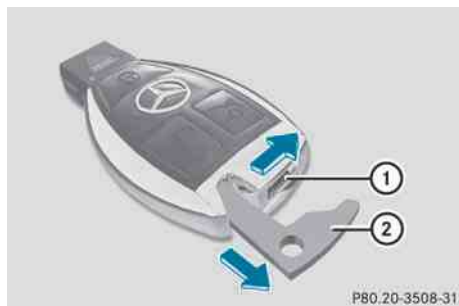

- ▶ Push release catch ① in the direction of the arrow and at the same time remove mechanical key ② from the SmartKey.

SmartKey battery

Important safety notes

It is advisable to have batteries replaced at a qualified specialist workshop, e.g. at an authorized Mercedes-Benz Center.

Warning!

Batteries are toxic and contain caustic substances. For this reason, keep batteries out of the reach of children.



If a battery has been swallowed, visit a doctor immediately.

Warning

SmartKey batteries contain perchlorate material, which may require special handling and regard for the environment. Check with your local government's disposal guidelines. California residents, see www.dtsc.ca.gov/HazardousWaste/Perchlorate/index.cfm.

Checking the battery





- ▶ Press the  or  button. The battery is working properly if battery charge indicator lamp ① lights up briefly.

If battery charge indicator lamp ① does not light up briefly during the test, the key batteries are discharged.

- ▶ Change the key battery (▷ page 72).

i Consult any authorized Mercedes-Benz Center for a key battery.

i If the battery is tested within the signal range of the vehicle, you can open or close the vehicle by pressing  or  respectively.

Changing the battery

You require a CR 2025 3 V cell battery.

- ▶ Take the mechanical key out of the SmartKey (▷ page 71).

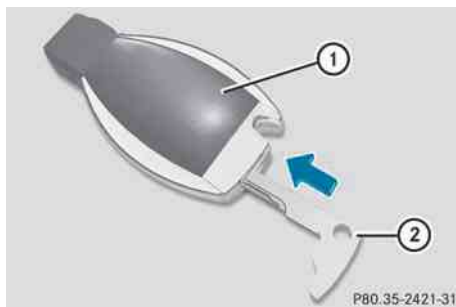



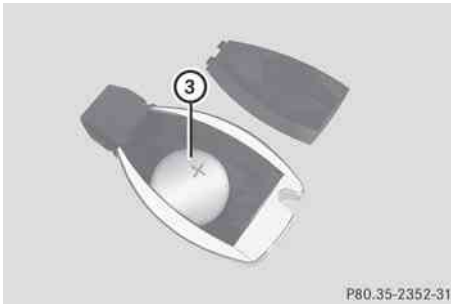

- ▶ Press mechanical key ② into the opening in the SmartKey in the direction of the

arrow until battery tray cover ① opens. Do not hold the cover closed while doing so.



- ▶ Remove the cover of the battery tray.
- ▶ Repeatedly tap the SmartKey against your palm until battery ③ falls out.
- ▶ Insert the new battery with the positive pole facing upwards. Use a lint-free cloth to do so.
- ▶ Insert the front tabs of the battery tray's cover first and then press to close it.
- ▶ Check the function of all SmartKey buttons on the vehicle.

Problems with the SmartKey	
Problem	Possible causes/consequences and ► Solutions
You cannot lock/unlock the vehicle using the SmartKey.	<p>The SmartKey battery is discharged or nearly discharged.</p> <ul style="list-style-type: none"> ► Point the tip of the SmartKey at the driver's door handle from a distance of approximately 1.5 ft (50 cm) and try to unlock or lock the vehicle again. <p>If this does not work:</p> <ul style="list-style-type: none"> ► Lock or unlock the vehicle using the mechanical key (▷ page 71). ► Check the key battery and replace it if necessary (▷ page 72).
	<p>The SmartKey is faulty.</p> <ul style="list-style-type: none"> ► Lock the vehicle as described in the "Locking the vehicle (mechanical key)" section (▷ page 77) or unlock it using the mechanical key (▷ page 71). ► Have the SmartKey checked at a qualified specialist workshop.
You can no longer lock/unlock the vehicle using KEYLESS-GO.	<p>KEYLESS-GO is in standby mode because the vehicle has not been unlocked for an extended period.</p> <ul style="list-style-type: none"> ► Pull the door handle and then turn the SmartKey to position 2 in the ignition lock.
	<p>There is a malfunction with KEYLESS-GO.</p> <ul style="list-style-type: none"> ► Lock/unlock the vehicle using the remote control function of the SmartKey. Point the tip of the SmartKey at the driver's door handle from close range and press the  /  button. ► Have the SmartKey checked at a qualified specialist workshop.
	<p>There is interference from a powerful source of radio waves.</p> <ul style="list-style-type: none"> ► Lock/unlock the vehicle using the remote control function of the SmartKey. Point the tip of the SmartKey at the driver's door handle from close range and press the  /  button.
You have lost a SmartKey.	<ul style="list-style-type: none"> ► Have the SmartKey canceled at an authorized Mercedes-Benz Center. ► Report the loss immediately to the vehicle insurers. ► If necessary, have the locks changed as well.
You have lost the mechanical key.	<ul style="list-style-type: none"> ► Report the loss immediately to the vehicle insurers. ► If necessary, have the locks changed as well.

Problem	Possible causes/consequences and ► Solutions
The engine cannot be started using the SmartKey.	The on-board voltage is too low. <ul style="list-style-type: none"> ► Switch off non-essential consumers, e.g. seat heating or interior lighting, and try to start the engine again. If this does not work: <ul style="list-style-type: none"> ► Check the starter battery and charge it if necessary (► page 253). or <ul style="list-style-type: none"> ► Jump-start the vehicle (► page 256). or <ul style="list-style-type: none"> ► Consult a qualified specialist workshop.
The engine cannot be started using KEYLESS-GO. The SmartKey is in the vehicle.	A door is open. Therefore, the SmartKey cannot be detected as easily. <ul style="list-style-type: none"> ► Close the door and try to start the vehicle again. There is interference from a powerful source of radio waves. <ul style="list-style-type: none"> ► Start your vehicle with the SmartKey in the ignition lock.

Doors

Important safety notes

 **Warning!**

When leaving the vehicle, always remove the SmartKey from the starter switch. Always take the SmartKey with you and lock the vehicle. Do not leave children unattended in the vehicle, even if they are secured in a child restraint system, or with access to an unlocked vehicle. A child's unsupervised access to a vehicle could result in an accident and/or serious personal injury. The children could

- injure themselves on parts of the vehicle
- be seriously or fatally injured through excessive exposure to extreme heat or cold
- injure themselves or cause an accident with vehicle equipment that can be operated even if the SmartKey is removed from the starter switch or removed from the vehicle, such as seat adjustment, steering wheel adjustment, or the memory function

If children open a door, they could injure other persons or get out of the vehicle and injure themselves or be injured by following traffic.

Do not expose the child restraint system to direct sunlight. The child restraint system's metal parts, for example, could become very hot, and the child could be burned by these parts.

 **Warning!**

Do not carry heavy or hard objects in the passenger compartment or cargo compartment unless they are firmly secured in place.

Unsecured or improperly positioned cargo increases a child's risk of injury in the event of

- strong braking maneuvers
- sudden changes of direction
- an accident

Unlocking and opening doors from the inside

You can open a door from inside the vehicle even if it has been locked, unless the child-proof locks have been activated (▷ page 60). Only open the door if traffic conditions allow you to do so.

If the vehicle has previously been locked with the SmartKey or with KEYLESS-GO, opening a door from the inside will trigger the anti-theft alarm system. Switch off the alarm (▷ page 65).



► **Front door:** pull door handle ②.

If the door is locked, locking knob ① pops up. The door is unlocked and can be opened.

► **Rear door:** pull up locking knob ① on the respective rear door.

The rear door is unlocked and can be opened.

Centrally locking and unlocking the vehicle from the inside

The locking or unlocking buttons of the central locking do not lock or unlock the fuel filler flap.

i You cannot unlock the vehicle centrally from the inside if the vehicle has been locked with the SmartKey.

i It is only possible to lock the vehicle centrally if the front-passenger door is closed.



► **To unlock:** press button ①.

► **To lock:** press button ②.

You can open a locked front door from inside the vehicle. Only open the door if traffic conditions allow you to do so.

If the vehicle has previously been locked with the central locking button:

- and the KEYLESS-GO key is restored to the factory settings, the entire vehicle is unlocked if a front door is opened from inside the vehicle.
- and the KEYLESS-GO key is set to individual settings, only the front door which is opened from inside the vehicle is unlocked.

If the vehicle has been locked centrally with the SmartKey or with KEYLESS-GO, it does not unlock if you use the unlocking button of the central locking.

Automatic locking

i The vehicle locks automatically when the ignition is switched on and the wheels of the vehicle are moving at a speed of more than 9 mph (15 km/h). You may therefore lock yourself out if the vehicle is being pushed, towed, or located on a test rig.

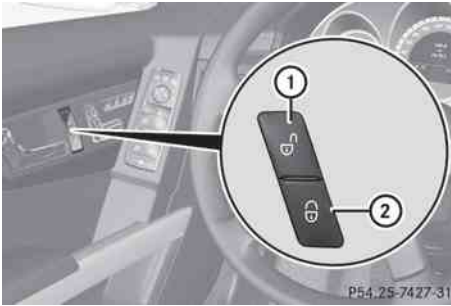

- ▶ **To deactivate:** press and hold button ① for about five seconds until a tone sounds.
 - ▶ **To activate:** press and hold button ② for about five seconds until a tone sounds.
- i** When you push either of the two buttons and an audible warning signal does not sound, the relevant setting has already been selected.

On vehicles with a luxury multifunction steering wheel, you can also activate and deactivate the automatic locking using the on-board computer (▷ page 173).

Unlocking the driver's door (mechanical key)

If the vehicle can no longer be unlocked centrally with the SmartKey:

- ▶ Take the mechanical key out of the SmartKey (▷ page 71).

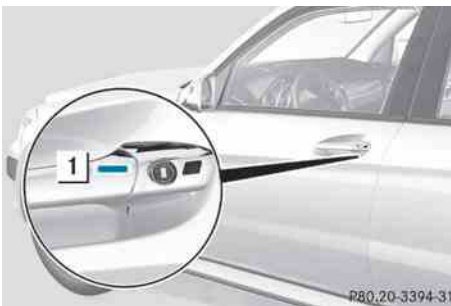

- ▶ Insert the mechanical key into the lock of the driver's door as far as it will go.
- ▶ Turn the mechanical key counter-clockwise to position ①. The door is unlocked.
- ▶ Turn the mechanical key back and remove it.

Locking the vehicle (mechanical key)

Emergency locking

If the vehicle can no longer be locked centrally with the SmartKey:

- ▶ Open the driver's door.
- ▶ Close the front-passenger door, the rear doors and the tailgate.
- ▶ Press the locking button (▷ page 76).
- ▶ Make sure that the locking knobs on the doors are still visible. Press down the locking knobs by hand, if necessary.
- ▶ Close the driver's door.
- ▶ Take the mechanical key out of the SmartKey (▷ page 71).

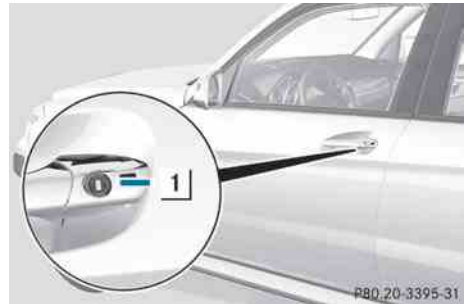

- ▶ Insert the mechanical key into the lock of the driver's door as far as it will go.
- ▶ Turn the mechanical key clockwise as far as it will go to position ①.
- ▶ Turn the mechanical key back and remove it.
- ▶ Make sure that the doors and the tailgate are locked.

- i** If you lock the vehicle as described above, the fuel filler flap is not locked. The anti-theft alarm system is not activated.

Cargo compartment

Important safety notes

Warning!

Exhaust fumes could enter the vehicle interior if the engine is running and the tailgate is open. This could poison you. Therefore, you should make sure that the tailgate is always closed when the engine is running.

- !** The tailgate swings upwards and to the rear when opened. Therefore, make sure that there is sufficient clearance above and behind the tailgate.

Do not leave the SmartKey in the cargo area. You could otherwise lock yourself out.

The tailgate can be:

- opened and closed manually
- opened and closed automatically from outside
- opened and closed automatically from inside

Opening and closing from the outside

Opening

- Press the  button on the SmartKey.

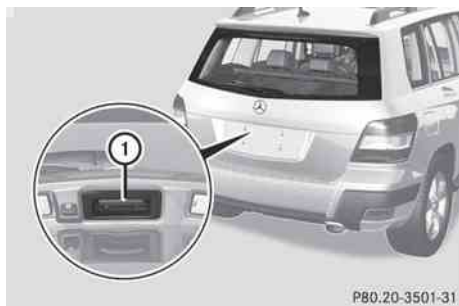

- Pull handle ①.

On vehicles with the EASY-PACK tailgate: if you pull handle ① and keep it in this position, you can open the tailgate manually. If you release the handle, the tailgate automatically opens fully.

Closing

Risk of injury

Make sure that nobody can become trapped as you close the tailgate.

Warning!

To prevent possible personal injury, always keep hands and fingers away from the cargo compartment opening when closing the tailgate. Be especially careful when small children are around.



- Pull the tailgate down using recess ①.
- If necessary, lock the vehicle with the  button on the SmartKey.

Automatic opening and closing from the outside

Important safety guidelines

To open the tailgate completely, a minimum clearance of 6.90 ft (210 cm) above the ground is necessary.

Opening the trunk lid

You can open the tailgate automatically with the SmartKey or the handle in the tailgate.

Open or close the tailgate fully using the automatic function if you have stopped the tailgate in an intermediate position.

- ▶ Press and hold the  button on the SmartKey until the tailgate opens.

or

- ▶ When the tailgate is unlocked, pull the handle and let it go again immediately.

i You can also close the tailgate manually if it is fully opened.

! If you have opened the tailgate automatically, you should wait a moment before closing the tailgate manually.

Closing the trunk lid

Warning!

Monitor the closing procedure carefully to make sure no one is in danger of being injured. To prevent possible personal injury, always keep hands and fingers away from the cargo compartment opening when closing the tailgate. Be especially careful when small children are around. To stop the closing procedure, do one of the following:

- Press or pull the remote tailgate opening/closing switch on the driver's door.
- Press the tailgate closing switch.
- Press the KEYLESS-GO locking/closing switch.
- Pull outside handle on the tailgate.
- When no SmartKey is inserted in the starter switch (vehicles with KEYLESS-GO: Make sure the vehicle's on-board electronics have status **0**): Press button  on the SmartKey.

You can close the tailgate automatically using the SmartKey, the closing button⁴ or the locking button⁵.

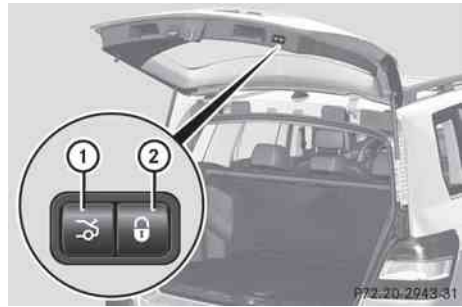

Example: vehicle with the EASY-PACK tailgate and KEYLESS-GO

- ▶ **To close:** press closing button **1** on the tailgate or press and hold down the  button on the SmartKey until the tailgate closes.

- ▶ **To close and lock simultaneously:** Press locking button **2** on the tailgate.

i The tailgate can only be opened and closed with the SmartKey if there is no SmartKey in the ignition lock. If the tailgate touches an object while closing, the closing procedure is interrupted and the tailgate reopens.

i Only with KEYLESS-GO: if you leave a KEYLESS-GO key in the cargo area, the tailgate will not lock. The tailgate is not closed unless a KEYLESS-GO key is detected.

Automatic opening and closing from the inside

You can open and close the tailgate from the driver's seat when the vehicle is stationary.

Warning!

Maintain sight of the area around the rear of the vehicle while operating the tailgate with the door-mounted remote tailgate switch. Monitor the closing procedure carefully to

⁴ For vehicles with the EASY-PACK tailgate only.

⁵ For vehicles with the EASY-PACK tailgate and KEYLESS-GO only.

make sure no one is in danger of being injured.

To interrupt the closing procedure, press or pull the door-mounted remote tailgate switch.

Warning!

To prevent possible personal injury, always keep hands and fingers away from the cargo compartment opening when closing the tailgate. Be especially careful when small children are around.

Warning!

Make sure the tailgate is closed when the engine is running and while driving. Among other dangers, deadly carbon monoxide (CO) gases may enter vehicle interior resulting in unconsciousness and death.

Warning!

Maintain sight of the area around the rear of the vehicle while operating the tailgate with the door-mounted remote tailgate switch. Monitor the opening procedure carefully to make sure no one is in danger of being injured.

To interrupt the opening procedure, press or pull the door-mounted remote tailgate switch.

When the SmartKey is not inserted in the starter switch (vehicles with KEYLESS-GO: Make sure the vehicle's on-board electronics have status **0**): Press button  on the SmartKey.



P54.25.7935.31

- ▶ **To open:** pull remote operating switch ① for the tailgate until the tailgate opens.
- ▶ **To close:** turn the SmartKey to position **1** or **2** in the ignition lock.
- ▶ Press remote operating switch for tailgate ① until the tailgate is closed. You will hear an acoustic signal during the closing procedure.

Limiting the opening angle of the tailgate

Important safety guidelines

You can limit the opening angle of the tailgate. This is possible in the top half of its opening range, up to approximately 0.6 ft (20 cm) before the stop.

Limiting the opening angle can be useful if there is not sufficient clearance above the open tailgate, for example.

- Make sure there is sufficient clearance to open the tailgate fully when setting the opening angle. The tailgate could otherwise be damaged. Ideally, set the opening angle outside.

Activating the tailgate

- ▶ **To open the tailgate:** pull the handle on the tailgate.
- ▶ **To stop the opening procedure at the desired position:** press the close button (▷ page 78) on the tailgate or pull the handle on the outside of the tailgate again.
- ▶ **To store the position:** press and hold the closing button on the tailgate until you hear a short tone. The opening angle limiter is activated. The tailgate will now stop in the stored position when opening.

- ❗ If you wish to open the tailgate fully, pull the handle of the tailgate again after it has stopped automatically. This does not delete the stored position.

Deactivating the tailgate

- ▶ Press and hold the closing button (▷ page 78) in the tailgate until you hear two short tones.

Tailgate emergency release

If the tailgate can no longer be opened from outside the vehicle, use the emergency release on the inside of the tailgate.

- ▶ Take the mechanical key out of the SmartKey (▷ page 71).

To open the tailgate completely, a minimum clearance of 6.90 ft (210 cm) above the ground is necessary.

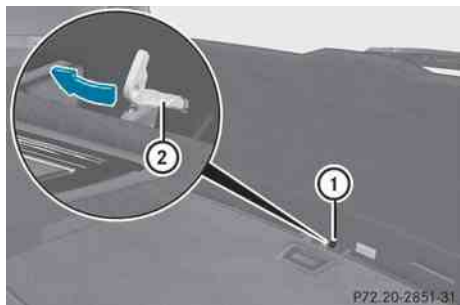

! The tailgate swings upwards and to the rear when opened. Therefore, make sure that there is sufficient clearance above and behind the tailgate.

- ▶ Insert mechanical key ② into opening in trim ①.
- ▶ Turn mechanical key ② 90° clockwise.
- ▶ Push mechanical key ② in the direction of arrow and open the tailgate.

Side windows

Important safety notes

Warning!

When leaving the vehicle, always remove the SmartKey from the starter switch. Always take the SmartKey with you and lock the vehicle. Do not leave children unattended in the vehicle, even if they are secured in a child restraint system, or with access to an unlocked vehicle. A child's unsupervised access to a vehicle could result in an accident and/or serious personal injury. The children could

- injure themselves on parts of the vehicle
- be seriously or fatally injured through excessive exposure to extreme heat or cold
- injure themselves or cause an accident with vehicle equipment that can be operated even if the SmartKey is removed from the starter switch or removed from the vehicle, such as seat adjustment, steering wheel adjustment, or the memory function

If children open a door, they could injure other persons or get out of the vehicle and injure themselves or be injured by following traffic.

Do not expose the child restraint system to direct sunlight. The child restraint system's metal parts, for example, could become very hot, and the child could be burned by these parts.

Warning!

Do not carry heavy or hard objects in the passenger or cargo compartment unless they are firmly secured in place.

Unsecured or improperly positioned cargo increases a child's risk of injury in the event of

- strong braking maneuvers
- sudden changes of direction
- an accident

Warning!

When opening or closing the door windows, make sure there is no danger of anyone being harmed by the opening/closing procedure.

The door windows are equipped with the express operation and automatic reversal function. If in express operation mode a door window encounters an obstruction that blocks its path, the automatic reversal function will stop the door window and open it slightly.

The door windows operate differently when the switch is pulled and held. See the section about the side windows.

The closing of the door windows can be immediately halted by releasing the switch or, if the switch was pulled past the resistance point and released, by either pressing or pulling the respective switch.

If a door window encounters an obstruction that blocks its path in a circumstance where you are closing the door windows by pressing and holding button  on the SmartKey the automatic reversal function will not operate.

Activate the override switch when children are riding in the back seats of the vehicle. The children may otherwise injure themselves, e.g. by becoming trapped in the door window opening.

Warning!

Do not keep any part of your body up against the window pane when opening a window. The downward motion of the pane may pull that part of your body down between the window pane and the door frame and trap it there. If there is a risk of entrapment, release the switch and pull it to close the window.

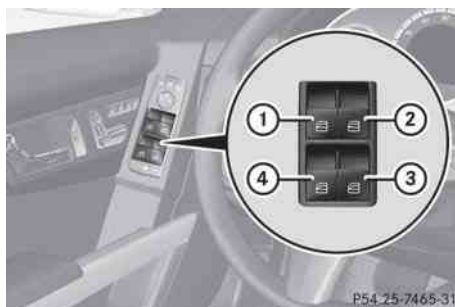
Opening and closing the side windows

- ① Front left
- ② Front right
- ③ Rear right
- ④ Rear left

The switches for all side windows are located on the driver's door. There is also a switch on each door for the corresponding side window.

i Operation of the side windows in the rear compartment is not possible when the override switch for the side windows is activated.

► Turn the key to position **2** in the ignition lock.

i You can continue to operate the side windows after you switch off the engine. This function remains active for five minutes or until one of the front doors is opened.

► **To open:** press the corresponding switch.

► **To close:** pull the corresponding switch.

i If you press the switch beyond the point of resistance, an automatic opening/closing process is started in the corresponding direction. You can stop automatic operation by pressing again.

Convenience opening



You can ventilate the vehicle before you start driving. To do this, you can use the key to simultaneously:

- open the side windows
- open the panorama roof with power tilt/sliding panel and roller sunblinds

i The convenience opening feature can only be operated using the key. The key must be near the handle of the driver's door.

- ▶ Point the tip of the key at the driver's door handle.
- ▶ Press and hold the  button until the side windows and the panorama roof with power tilt/sliding panel are in the desired position.
The vehicle is unlocked.

If the roller sunblinds of the panorama roof with power tilt/sliding panel are closed, the roller sunblinds are opened first.

- ▶ Press and hold the  button again until the panorama roof with power tilt/sliding panel is in the desired position.
- ▶ **To interrupt the convenience opening procedure:** release the  button.

Convenience closing

General information

When you lock the vehicle, you can simultaneously:

- close the side windows
- close the panorama roof with power tilt/sliding panel



On vehicles with a panorama roof with power tilt/sliding panel, you can then close the roller sunblinds.

Warning

When closing the side windows and the panorama roof with power tilt/sliding panel,

make sure that nobody can be injured during the closing procedure.

Proceed as follows in the event of a potentially dangerous situation:

- Release the  button to stop the closing procedure. To open, press and hold the  button. To continue with the closing procedure (after making sure that nobody can be injured during the closing procedure) press and hold the  button.



Vehicles with KEYLESS-GO:

- Release the locking button on the exterior door handle in order to interrupt the closing procedure.
- Pull the same exterior door handle immediately and hold it firmly. The side windows and the panorama roof with power tilt/sliding panel open for as long as the door handle is held without actually opening the door.

Using the SmartKey

- i** The key must be near the handle of the driver's door.
- ▶ Point the tip of the key at the driver's door handle.
- ▶ Press and hold the  button until the side windows and the panorama roof with power tilt/sliding panel are fully closed.
- ▶ Make sure that all the side windows and the panorama roof with power tilt/sliding panel are closed.

On vehicles with a panorama roof with power tilt/sliding panel:

- ▶ Press and hold the  button again until the roller sunblinds of the panorama roof with power tilt/sliding panel close.
- ▶ **To interrupt the convenience closing procedure:** release the  button.

Using KEYLESS-GO

The SmartKey with KEYLESS-GO must be outside the vehicle but no more than 3 ft (1 m) away from a door.

- ▶ Close all the doors.

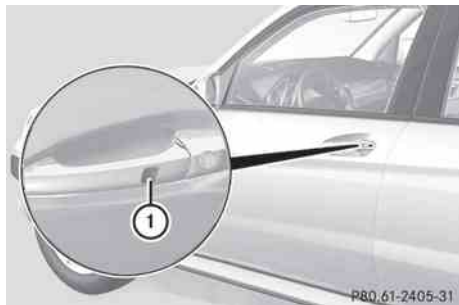

- ▶ Touch the sensor surface on door handle ① until the side windows and the panorama roof with power tilt/sliding panel are fully closed.

i Make sure you only touch sensor surface ①.

- ▶ Make sure that all the side windows and the panorama roof with power tilt/sliding panel are closed.

On vehicles with a panorama roof with power tilt/sliding panel:

- ▶ Touch sensor surface ① on the door handle again until the roller sunblinds of the panorama roof with power tilt/sliding panel close.
- ▶ **To interrupt convenience closing:** release sensor surface ① on the door handle.

Resetting the side windows

You must reset all the side windows if the side window cannot be closed fully.

- ▶ Close all the doors.
- ▶ Turn the key to position **2** in the ignition lock.

- ▶ Pull on the corresponding switch on the door control panel until the side window is completely closed (▷ page 82).
- ▶ Hold the switch for an additional second.

If the side window opens again slightly:

- ▶ Pull the corresponding switch again immediately and hold it for approximately one second.

Problems with the side windows

Problem: a side window cannot be closed because objects are trapped between the side window and the door frame.

- ▶ Remove the objects.
- ▶ Close the side window.

Problem: a side window cannot be closed because objects in the guide rail are preventing the window from being raised.

- ▶ Remove the objects.
- ▶ Close the side window.

Problem: a side window cannot be closed, and you cannot see the cause.

Warning!

Closing the side windows with increased force or without the anti-entrapment feature could lead to serious or even fatal injury. Make sure that nobody can become trapped when closing the side windows.

If a side window is obstructed during closing and reopens again slightly:

- ▶ Immediately after the window blocks, pull on the corresponding switch again until the side window has closed. The side window is closed with increased force.

If a side window is obstructed again during closing and reopens again slightly:

- ▶ Immediately after the window blocks, pull on the corresponding switch again until the side window has closed.
The side window is closed without the anti-entrapment feature.

Warning!

Pulling and holding the switch to close the door window immediately after it had been blocked two times will cause the door window to close without the anti-entrapment feature for as long as you hold the switch.

Sliding sunroof

Important safety notes

Warning!

When leaving the vehicle, always remove the SmartKey from the starter switch. Always take the SmartKey with you and lock the vehicle. Do not leave children unattended in the vehicle, even if they are secured in a child restraint system, or with access to an unlocked vehicle. A child's unsupervised access to a vehicle could result in an accident and/or serious personal injury. The children could

- injure themselves on parts of the vehicle
- be seriously or fatally injured through excessive exposure to extreme heat or cold
- injure themselves or cause an accident with vehicle equipment that can be operated even if the SmartKey is removed from the starter switch or removed from the vehicle, such as seat adjustment, steering wheel adjustment, or the memory function

If children open a door, they could injure other persons or get out of the vehicle and injure themselves or be injured by following traffic.

Do not expose the child restraint system to direct sunlight. The child restraint system's metal parts, for example, could become very

hot, and the child could be burned by these parts.

Warning!

Do not carry heavy or hard objects in the passenger or cargo compartment unless they are firmly secured in place.

Unsecured or improperly positioned cargo increases a child's risk of injury in the event of

- strong braking maneuvers
- sudden changes of direction
- an accident

Warning!

When opening or closing the tilt/sliding panel, make sure there is no danger of anyone being harmed by the opening/closing procedure.

The tilt/sliding panel is equipped with the automatic operation and anti-entrapment features. If the movement of the tilt/sliding panel is blocked during the closing procedure, the tilt/sliding panel will stop and open slightly.

The tilt/sliding panel operates differently when the roof panel switch is pressed and held. See the relevant section in this chapter for details.

The opening/closing procedure of the tilt/sliding panel can be immediately halted by releasing the roof panel switch or, if the roof panel switch was moved past the resistance point and released, by moving the roof panel switch in any direction.

Warning!

The panorama roof with tilt/sliding panel is made out of glass. In the event of an accident, the glass may shatter. This may result in an opening in the roof.

In a vehicle rollover, occupants not wearing their seat belts or not wearing them properly may be thrown out of the opening. Such an opening also presents a potential for injury for occupants wearing their seat belts properly as

entire body parts or portions of them may protrude from the passenger compartment.

! Only open the sliding sunroof if it is free of snow and ice. Otherwise, malfunctions may occur.

Do not allow anything to protrude from the sliding sunroof. Otherwise, the seals could be damaged.

! If the sliding sunroof cannot be opened or closed due to a malfunction, contact a qualified specialist workshop, e.g. an authorized Mercedes-Benz Center.

! Do not forget that the weather can change abruptly. Make certain that the sliding sunroof is closed when you leave the vehicle. The vehicle electronics can be damaged if water enters the vehicle interior.

i Resonance noises can occur in addition to the usual airflow noises when the sliding sunroof is open. They are caused by minor pressure fluctuations in the vehicle interior. Change the position of the sliding sunroof or open a side window slightly to reduce or eliminate these noises.

Operating the panorama sliding sunroof

Opening and closing



Overhead control panel

- ① To raise
- ② To open
- ③ To close

The panorama roof with power tilt/sliding panel can only be moved when the roller sunblinds are open.

- ▶ Turn the key to position **2** in the ignition lock.
- ▶ Push or pull the  switch in the corresponding direction.

i If you press the  switch beyond the point of resistance, an automatic opening/closing process is started in the corresponding direction. You can stop automatic operation by pressing again. Automatic raising is only available if the panorama roof with power tilt/sliding panel is in the closed position.

Operating the roller sunblinds of the panorama sliding sunroof

General notes

The roller sunblinds provide protection from the sun. The two roller sunblinds can only be opened and closed together when the panorama roof with power tilt/sliding panel is closed.

Warning

When opening the roller sunblinds, make sure that nobody can be injured during the opening procedure.

The roller sunblinds are equipped with the express operation and anti-entrapment features. If the roller sunblinds block during the opening procedure, the anti-entrapment feature stops the roller sunblinds and opens them again slightly.



The opening procedure of the roller sunblinds can be stopped immediately by releasing the roof switch or by operating the roof switch in any direction if the roof switch has been pressed beyond the point of resistance and has been released.

Opening and closing



Overhead control panel

- ① To open
- ② To open
- ③ To close







- ▶ Turn the key to position **2** in the ignition lock.
- ▶ Push or pull the  switch in the corresponding direction.
- i** If you press the  switch beyond the point of resistance, an automatic opening/closing process is started in the corresponding direction. You can stop automatic operation by pressing again.

Resetting the panorama roof with power tilt/sliding panel and the roller sunblinds

Reset the panorama roof with power tilt/sliding panel and the roller sunblinds if the panorama roof with power tilt/sliding panel or the roller sunblind do not open smoothly.

- !** Do not open the panorama sliding sunroof until it has been reset properly. Otherwise, the panorama roof with power tilt/sliding panel may lock in the open position.

If the panorama roof with power tilt/sliding panel cannot be closed or adjusted, contact a qualified specialist workshop, e.g. a Mercedes-Benz Service Center.

- ▶ Turn the key to position **2** in the ignition lock.
- ▶ Press the  switch to the point of resistance in the direction of arrow ② and hold it until the roller sunblinds are fully open.
- ▶ Press the  switch to the point of resistance in the direction of arrow ② and hold it until the panorama roof with power tilt/sliding panel has opened about 10 cm.
- ▶ Pull the  switch repeatedly to the point of resistance in the direction of arrow ③ until the panorama roof with power tilt/sliding panel is fully closed.
- ▶ Keep the  switch pulled for an additional second.
- ▶ Pull the  switch to the point of resistance in the direction of arrow ③ and hold it until the roller sunblinds are fully closed.
- ▶ Keep the  switch pulled for an additional second.
- ▶ Make sure that the panorama roof with power tilt/sliding panel can be opened fully again (> page 86).
- ▶ If this is not the case, the previously described steps must be repeated or you should consult a qualified specialist workshop.

Problems with the sliding sunroof

Problem: the sunroof cannot be closed and you cannot see the cause.

Warning!

You could be severely or even fatally injured when closing the sliding sunroof with increased closing force or if the anti-entrapment feature is deactivated. Make sure that nobody can become trapped when closing the sliding sunroof.

If the sliding sunroof is obstructed during closing:

- ▶ Immediately after the sliding sunroof blocks, pull the  switch in the overhead control panel down to the point of resistance and hold it until the sliding sunroof is closed.

The sliding sunroof is closed with increased force.

If the sliding sunroof is obstructed during closing again:

- ▶ Immediately after the sliding sunroof blocks, pull the  switch in the overhead control panel down to the point of resistance and hold it until the sliding sunroof is closed.

The sliding sunroof is closed without the anti-entrapment feature.

Warning!

Pressing and holding the sliding sunroof switch to close the sliding sunroof immediately after it had been blocked two times will cause the sliding sunroof to close without the anti-entrapment feature for as long as you hold the switch.

Vehicle equipment	90
Correct driver's seat position	90
Seats	91
Steering wheel	95
Mirrors	97
Memory functions	100

Vehicle equipment

i This manual describes all the standard and optional equipment of your vehicle which was available at the time of purchase. Country-specific differences are possible. Bear in mind that your vehicle may not feature all functions described here. This also refers to safety-related systems and functions.

Correct driver's seat position



Observe the important safety notes on (▷ page 91).

► Check whether you have adjusted seat ③ properly.

Electrical seat adjustment (▷ page 92)

When adjusting the seat, make sure:

- you are as far away from the driver's air bag as possible.
- you are sitting in a normal upright position.
- you can fasten the seat belt properly.
- you have moved the backrest to an almost vertical position.

- you have set the seat cushion angle so that your thighs are gently supported.
- you can depress the pedals properly.

► Check whether the head restraint is adjusted properly (▷ page 93).

When doing so, make sure that you have adjusted the head restraint so that the back of your head is supported at eye level by the center of the head restraint.

Observe the important safety notes on (▷ page 95).

► Check whether steering wheel ① is adjusted properly.

Adjusting the steering wheel manually (▷ page 96)

Adjusting the steering wheel electrically (▷ page 96)

When adjusting the steering wheel, make sure:

- you can hold the steering wheel with your arms slightly bent.
- you can move your legs freely.
- you can see all the displays in the instrument cluster clearly.

Observe the important safety notes on (▷ page 50).

► Check whether you have fastened seat belt ② properly (▷ page 52).

The seat belt should:

- fit snugly across your body
- be routed across the middle of your shoulder
- be routed in your pelvic area across the hip joints

► Before starting off, adjust the rear-view mirror and the exterior mirrors (▷ page 97) in such a way that you have a good view of road and traffic conditions.

► **Vehicles with memory function:** save the seat, steering wheel and exterior mirror settings (▷ page 100).

Seats

Important safety notes

Warning

In order to avoid possible loss of vehicle control, all seat, head restraint, steering wheel and rear view mirror adjustments, as well as fastening of seat belts, must be done before setting the vehicle in motion.

Warning

Do not adjust the driver's seat while driving. Adjusting the seat while driving could cause the driver to lose control of the vehicle.

Never travel in a moving vehicle with the seat backrest in an excessively reclined position as this can be dangerous. You could slide under the seat belt in a collision. If you slide under it, the seat belt would apply force at the abdomen or neck. This could cause serious or fatal injuries. The seat backrest and seat belts provide the best restraint when the wearer is in a position that is as upright as possible and seat belts are properly positioned on the body.

Warning

Your seat belt must be adjusted so that you can correctly fasten your seat belt.

Observe the following points:

- adjust the seat backrest until your arms are slightly angled when holding the steering wheel.
- adjust the seat to a comfortable seating position that still allows you to reach the accelerator/brake pedal safely. The position should be as far back as possible with the driver still able to operate the controls properly.
- adjust the head restraint so that it is as close to the head as possible and the center

of the head restraint supports the back of the head at eye level.

- never place hands under the seat or near any moving parts while a seat is being adjusted.

Failure to do so could result in an accident and/or serious personal injury.

Warning

The electrically adjustable seats can be operated at any time. Therefore, do not leave children unattended in the vehicle, or with access to an unlocked vehicle. A child's unsupervised access to a vehicle could result in an accident and/or serious personal injury.

Warning!

According to accident statistics, children are safer when properly restrained in the rear seating positions than in the front seating position. Thus, we strongly recommend that children be placed in the rear seats whenever possible. Regardless of seating position, children 12 years old and under must be seated and properly secured in an appropriately sized infant restraint, toddler restraint, or booster seat recommended for the size and weight of the child. For additional information, see "Children in the vehicle".

A child's risk of serious or fatal injuries is significantly increased if the child restraints are not properly secured in the vehicle and/or the child is not properly secured in the child restraint.

Warning

For your protection, drive only with properly positioned head restraints.

Adjust the head restraint so that it is as close to the head as possible and the center of the head restraint supports the back of the head at eye level. This will reduce the potential for injury to the head and neck in the event of an accident or similar situation.

Do not drive the vehicle without the seat head restraints. Head restraints are intended to help reduce injuries during an accident.

! To avoid damage to the seats and the seat heating, observe the following information:

- do not spill any liquids on the seats. If liquid is spilled on the seats, dry them as soon as possible.
- if the seat covers are damp or wet, do not switch on the seat heating. The seat heating should also not be used to dry the seats.
- clean the seat covers as recommended; see the "Interior care" section.
- do not transport heavy loads on the seats. Do not place sharp objects on the seat cushions, e.g. knives, nails or tools. The seats should only be occupied by passengers, if possible.
- when the seat heating is in operation, do not cover the seats with insulating materials, e.g. covers, bags, seat covers, child seats or booster seats.

! When you move the seats, make sure that there are no objects in the footwell or behind the seats. Otherwise, you could damage the seats and the objects.

i The head restraints in the front seats are installed with the NECK-PRO system (> page 49). For this reason, it is not possible to remove the head restraints from the front seats.

The rear-compartment head restraints can be removed (> page 94).

Please contact an authorized Mercedes-Benz Center for more information.

i Related topics:

- Cargo compartment enlargement (folding the rear bench seat forwards) (> page 208)

Adjusting the seats

i Vehicles without the memory function: the seats can be adjusted within five minutes of opening a front door.

The time span starts over if, within these five minutes, you:

- open or close a front door
- insert the key into or remove the key from the ignition lock
- switch the ignition on or off.

If the key is in position **2** in the ignition, you can adjust the seats at any time.

Depending on the equipment, the seat adjustment switches are located either on the side of the seat or on the door control panel.

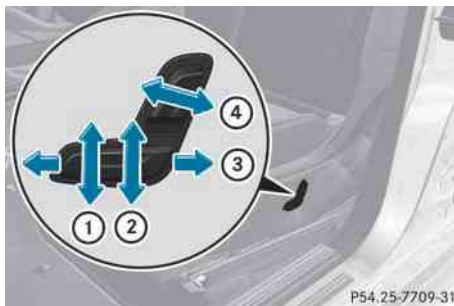

P54.25-7709-31

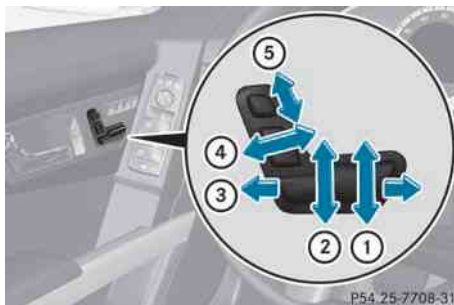

P54.25-7708-31

- ① Seat cushion angle
- ② Seat height
- ③ Seat fore-and-aft adjustment
- ④ Backrest angle
- ⑤ Head restraint height⁶

⁶ Only for vehicles with the memory function.

i You can store the seat settings using the memory function (▷ page 100).

Adjusting the head restraints

Adjusting the head restraints manually

Adjusting the head restraint height⁷

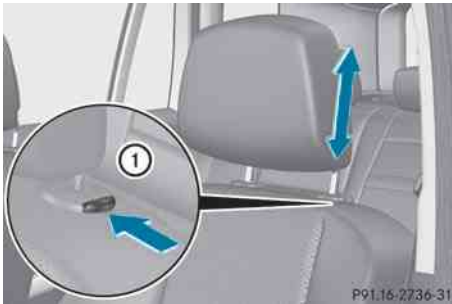

- ▶ **To raise:** pull the head restraint up to the desired position.
- ▶ **To lower:** press release catch ① in the direction of the arrow and push the head restraint down to the desired position.

Adjusting the angle of the head restraints



- ▶ Push or pull the lower edge of the head restraint in the direction of the arrow.

Adjusting the head restraints electrically⁸

- ▶ **To adjust the head restraint height:** slide the switch for head restraint adjustment (▷ page 92) up or down in the direction of the arrow.

Rear seat head restraints

⚠ Warning!

For your protection, drive only with properly positioned head restraints.

Adjust the head restraint in such a way that it is as close to the head as possible and the center of the head restraint supports the back of the head at eye level. This will reduce the potential for injury to the head and neck in the event of an accident or similar situation.

With a rear seat occupied, make sure to move the respective head restraint up from the lowest non-use position and have the occupant adjust the head restraint properly. Do not drive the vehicle without the seat head restraints installed when the rear seats are occupied. Head restraints are intended to help reduce injuries during an accident.

Adjusting the rear seat head restraint height

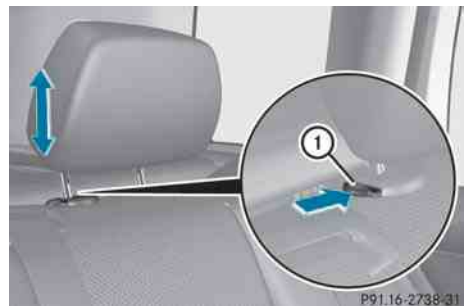

If the head restraint is fully lowered, it is necessary to press release catch ①.

⁷ For vehicles without memory function only.

⁸ Only for vehicles with memory function.

- ▶ **To raise:** pull the head restraint up to the desired position.
- ▶ **To lower:** press release catch ① and push the head restraint down until it is in the desired position.

Adjusting the rear seat head restraint angle

Adjust the head restraints so that they are as close as possible to your head.

You can only adjust the two outer head restraints.



- ▶ Pull or push the top of the head restraint until it is in the desired position.

Removing and installing the rear head restraints

⚠ Warning!

Occupants should only travel sitting on seats which have the head restraints installed. In the event of an accident, this reduces the risk of injury for passengers seated in the rear compartment.

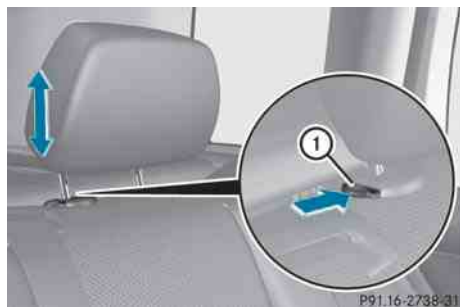

- ▶ **To remove:** pull the head restraint up to the stop.
- ▶ Press release catch ① and pull the head restraint out of the guides.
- ▶ **To re-install:** insert the head restraint so that the notches on the bar are on the left when viewed in the direction of travel.
- ▶ Push the head restraint down until you hear it engage in position.

Adjusting the lumbar support

Vehicles without the memory function:

You can adjust the contour of the front seats so as to provide optimum support for your back.



- ▶ Move adjustment lever ① in the direction of the arrow until the desired backrest contour is achieved.

Adjusting the four-way lumbar support

Vehicles with memory function:

You can adjust the contour of the front seat backrests individually to provide optimum support for your back.

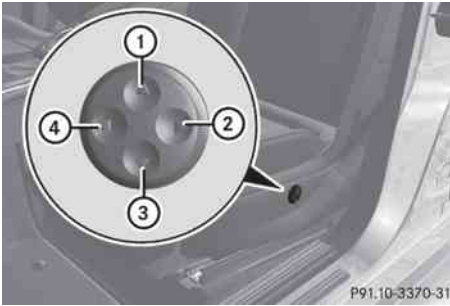

- ① To raise the backrest contour
- ② To soften the backrest contour
- ③ To lower the backrest contour
- ④ To harden the backrest contour

Switching the seat heating on/off

Switching on/off

Warning!

Repeatedly setting the seat heating to level **3** may result in excessive seat temperatures. The health of passengers that have limited temperature sensitivity or a limited ability to react to excessively high temperatures may be affected or they may even suffer burn-like injuries. Therefore, do not use seat heating level **3** repeatedly.

The three red indicator lamps in the button indicate the heating level you have selected.

- i** If the battery voltage is too low, the seat heating may switch off.



Driver's and front-passenger seat

The system automatically switches down from level **3** to level **2** after approximately eight minutes.

The system automatically switches down from level **2** to level **1** after approximately ten minutes.

The system automatically switches off approximately 20 minutes after it is set to level **1**.

- ▶ Make sure that the key is in position **2** in the ignition lock.
- ▶ **To switch on:** press button ① repeatedly until the desired heating level is set.
- ▶ **To switch off:** press button ① repeatedly until all the indicator lamps go out.

Problems with the seat heating

The seat heating has switched itself off prematurely or cannot be switched on. The vehicle's electrical system voltage is too low because too many electrical consumers are switched on.

- ▶ Switch off electrical consumers which you do not need, such as the rear window defroster or interior lighting.

Steering wheel

Important safety notes

Warning

Do not adjust the steering wheel while driving. Adjusting the steering wheel while driving, or driving without the steering wheel adjustment feature locked could cause the driver to lose control of the vehicle.

The electrical steering wheel adjustment feature can be operated at any time. Therefore, do not leave children unattended in the vehicle, or with access to an unlocked vehicle. A child's unsupervised access to a vehicle could result in an accident and/or serious personal injury.

Adjusting the steering wheel manually

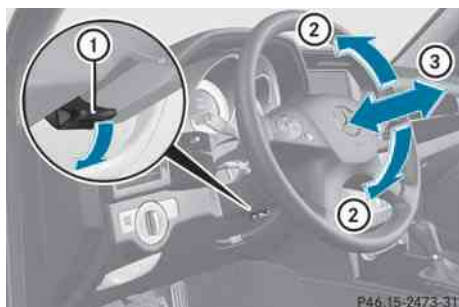

- ① Release lever
 - ② To adjust the steering wheel height
 - ③ To adjust the steering wheel position (fore-and-aft adjustment)
- ▶ Push release lever ① down completely. The steering column is unlocked.
 - ▶ Adjust the steering wheel to the desired position.
 - ▶ Push release lever ① up completely. The steering column is locked.
 - ▶ Check if the steering column is locked. When doing so, try to push the steering wheel up or down or try to move it in the fore-and-aft direction.

Adjusting the steering wheel electrically

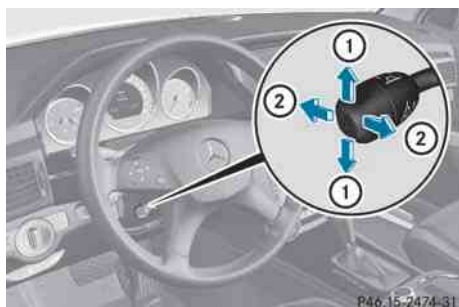

- ① To adjust the steering wheel height
- ② To adjust the steering wheel position (fore-and-aft adjustment)

Related topics:

- EASY-ENTRY/EXIT feature (▷ page 96)
- storing settings (▷ page 100)

EASY-ENTRY/EXIT

Warning!

You must make sure no one can become trapped or injured by the moving steering wheel when the easy-entry/exit feature is activated.

To stop steering wheel movement, move steering wheel adjustment stalk or press the memory position switch.

Do not leave children unattended in the vehicle, or with access to an unlocked vehicle. Children could open the driver's door and unintentionally activate the easy-entry/exit feature, which could result in an accident and/or serious personal injury.

The EASY-ENTRY/EXIT feature makes getting in and out of your vehicle easier.

The steering wheel swings upwards when you:

- remove the key from the ignition lock.
- open the driver's door and KEYLESS-GO is in position 1
- open the driver's door and the key is in position 0 or 1 in the ignition lock.

The steering wheel only moves upwards if it has not already reached the upper end stop.

The steering wheel is moved to the last selected position when:

- the driver's door is closed, and
- you insert the key into the ignition lock. or
- in vehicles with KEYLESS-GO, you press the Start/Stop button once.

When you close the driver's door with the ignition switched on, the steering wheel is

also automatically moved to the previously set position.

The last position of the steering wheel is stored when you switch off the ignition or when you store the setting with the memory function (> page 100).

You can activate and deactivate the EASY-ENTRY/EXIT feature in the on-board computer (> page 173).

Warning

Let the system complete the adjustment procedure before setting the vehicle in motion. All steering wheel adjustment must be completed before setting the vehicle in motion. Driving off with the steering wheel still adjusting could cause the driver to lose control of the vehicle.

- i** If the crash-responsive EASY-EXIT feature is triggered in an accident, the steering column will move upwards when the driver's door is opened. This occurs irrespective of the position of the key in the ignition lock. This makes it easier to exit the vehicle and rescue the occupants. The crash-responsive EASY-EXIT feature is only operational after an accident if the EASY-EXIT/ENTRY feature is activated in the on-board computer.

Mirrors

Rear-view mirror

Rear-view mirror (manual anti-glare)



- ▶ **Anti-glare mode:** flick anti-glare switch **①** forwards or back.

Exterior mirrors

Adjusting the exterior mirrors

Warning

Exercise care when using the passenger-side exterior rear view mirror. The mirror surface is convex (outwardly curved surface for a wider field of view). Objects in mirror are closer than they appear. Check your interior rear view mirror and glance over your shoulder before changing lanes.

The exterior mirrors are automatically heated if the rear window defroster is switched on and the outside temperature is low.



- ▶ Make sure that the key is in position **1** or **2** in the ignition lock.
- ▶ Press button **①** for the left-hand exterior mirror or button **②** for the right-hand exterior mirror. The indicator lamp in the corresponding button lights up in red. The indicator lamp goes out again after some time. You can adjust the selected mirror using adjustment button **③** as long as the indicator lamp is lit.
- ▶ Press adjustment button **③** up, down, to the right or to the left until the exterior mirror is set to a position which provides you with a good overview of traffic conditions.

Folding the exterior mirrors in or out electrically

This function is only available in vehicles for Canada.

- ❗ Fold in the exterior mirrors when driving the vehicle into an automatic car wash. The mirrors could otherwise be damaged.



- ▶ Make sure that the key is in position **1** or **2** in the ignition lock.
- ▶ Briefly press button **1**. Both exterior mirrors fold in or out.
- i** Make sure that the exterior mirrors are always folded out fully while the vehicle is in motion as they may otherwise vibrate.
- i** If you are driving faster than 9 mph (15 km/h), you can no longer fold in the exterior mirrors.

Resetting the exterior mirrors

This function is only available in vehicles for Canada.

If the battery has been disconnected or completely discharged, the exterior mirrors must be reset. The exterior mirrors will otherwise not fold in when you select the "Fold in mirrors when locking" function in the on-board computer (▷ page 174).

- ▶ Make sure that the key is in position **1** in the ignition lock.
- ▶ Briefly press button **1**.

Folding the exterior mirrors in or out automatically

This function is only available in vehicles for Canada.

If the "Fold in mirrors when locking" function is activated in the on-board computer (▷ page 174):

- the exterior mirrors fold in automatically as soon as you lock the vehicle from the outside.
 - the exterior mirrors fold out again automatically as soon as you unlock the vehicle and then open the driver's or front-passenger door.
- i** The mirrors do not fold out if they have been folded in manually.

Exterior mirror out of position

If an exterior mirror has been pushed out of position, proceed as follows:

- ▶ **Vehicles without electrically folding exterior mirrors:** move the exterior mirror into the correct position manually.
- ▶ **Vehicles with electrically folding exterior mirrors (only vehicles for Canada):** press the mirror-folding button (▷ page 98) repeatedly until you hear the mirror engage in position. The mirror housing is engaged again and you can adjust the exterior mirrors as usual (▷ page 97).

Automatic anti-glare mirrors

Warning!

The auto-dimming function does not react if incoming light is not aimed directly at sensors in the interior rear view mirror.

The interior rear view mirror and the exterior rear view mirror on the driver's side do not react, for example, when transporting cargo which covers the rear window.

Light hitting the mirror(s) at certain angles (incident light) could blind you. As a result, you may not be able to observe traffic conditions and could cause an accident.

The rear-view mirror and the exterior mirror on the driver's side automatically go into anti-glare mode if the ignition is switched on and incident light from headlamps strikes the sensor in the rear-view mirror.

The mirrors do not go into anti-glare mode if reverse gear is engaged or the interior lighting is switched on.

Parking position for the exterior mirror on the front-passenger side

Setting and storing the parking position

You can position the front-passenger side exterior mirror in such a way that you can see the rear wheel on that side as soon as you engage reverse gear. You can store this position.



- ▶ Make sure that the vehicle is stationary and that the key is in position **2** in the ignition lock.
- ▶ Press button **②** for the exterior mirror on the front-passenger side.

- ▶ Engage reverse gear.
The exterior mirror on the front-passenger side moves to the preset parking position.
- ▶ Use adjustment button **③** to adjust the exterior mirror to a position which allows you to see the rear wheel and the curb. The parking position is stored.

i If you shift the transmission to another position, the exterior mirror on the front-passenger side returns to the driving position.

i You can also store the parking position using memory button **M** **④**.

- ▶ With the key in position **2** in the ignition lock and with the exterior mirror on the front-passenger side activated, use adjustment button **③** to set the exterior mirror such that the rear wheel and curb are visible.
- ▶ Press memory button **M** **④** and one of the arrows on adjustment button **③** within three seconds.
The parking position is stored if the exterior mirror does not move.

If the mirror moves out of position, repeat the steps.

Calling up a stored parking position setting

- ▶ With the key in position **2** in the ignition lock and the exterior mirror on the front-passenger side activated, engage reverse gear.
The exterior mirror on the front-passenger side moves to the stored parking position.

The exterior mirror on the front-passenger side moves back to its original position:

- as soon as you exceed a speed of 6 mph (10 km/h)
- about ten seconds after you have disengaged reverse gear
- if you press button **①** for the exterior mirror on the driver's side

Memory functions

Storing settings

With the memory function, you can store up to three different settings, e.g. for three different people.

The following settings are stored as a single memory preset:

- position of the seat, backrest and head restraint
- driver's side: steering wheel position
- driver's side: position of the exterior mirrors on the driver's and front-passenger sides

Warning!

The memory function can still be used when the key has been removed. For this reason, children should never be left unsupervised in the vehicle. They could otherwise become trapped when adjusting the seat or the steering wheel.

Warning!

Only use the memory function on the driver's side when the vehicle is stationary. You could otherwise be distracted from the traffic conditions by the steering wheel and seat moving of their own accord, and as a result cause an accident.

- ▶ Adjust the seat (▷ page 92).
- ▶ On the driver's side, adjust the steering wheel (▷ page 96) and the exterior mirrors (▷ page 97).
- ▶ Press memory button **M** and one of the storage position buttons **1**, **2** or **3** within three seconds.
The settings are stored in the selected preset position. A tone sounds when the settings have been completed.

Calling up a stored setting

- ❗ If you want to move the seat from the fully reclined position to a stored seat position, first raise the backrest. The seat could otherwise be damaged.
- ▶ Press and hold the relevant storage position button **1**, **2** or **3**, until the seat, steering wheel and exterior mirrors are in the stored position.
- i** The setting procedure is interrupted as soon as you release the storage position button.



P54_25-7434-31

Vehicle equipment	102
Exterior lighting	102
Interior lighting	106
Changing bulbs	107
Windshield wipers	113

Vehicle equipment

i This manual describes all the standard and optional equipment of your vehicle which was available at the time of purchase. Country-specific differences are possible. Bear in mind that your vehicle may not feature all functions described here. This also refers to safety-related systems and functions.

Exterior lighting

Important safety notes

For reasons of safety, Mercedes-Benz recommends that you drive with the lights switched on even during the daytime. In some countries, operation of the headlamps varies due to legal requirements and self-imposed obligations. In these countries, the daytime running lamps are automatically switched on when the engine is started.

Notes on driving abroad

Converting to symmetrical low beam when driving abroad: switch the headlamps to symmetrical low beam in countries in which traffic drives on the opposite side of the road to the country where the vehicle is registered. This prevents oncoming traffic from being dazzled. Symmetrical lights do not illuminate as large an area of the edge of the road.

Have the headlamps converted at a qualified specialist workshop, e.g. an authorized Mercedes-Benz Center, as close to the border as possible before driving in these countries.

Converting to asymmetrical low beam after returning: have the headlamps converted back to asymmetrical low beam at a qualified specialist workshop, e.g. an authorized Mercedes-Benz Center, as soon as possible after crossing the border when returning.

Light switch

Operation

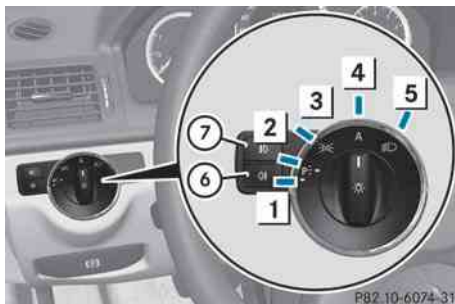

- 1** Left-hand standing lamps
- 2** Right-hand standing lamps
- 3** Parking lamps, license plate and instrument lighting
- 4** **A** Automatic headlamp mode/daytime running lamps
- 5** Low-beam/high-beam headlamps
- 6** Rear fog lamp
- 7** Front fog lamps

The turn signals, high-beam headlamps and the high beam flasher are operated using the combination switch (> page 104).

! Switch off the parking lamps and standing lamps when you leave the vehicle. This prevents the battery from discharging.



The exterior lighting (except the parking lamps/standing lamps) switches off automatically if you:

- remove the key from the ignition lock
- open the driver's door with the key in position **0**

If you hear a warning tone when you leave the vehicle, the lights may still be switched on.

► Turn the light switch to **A**.

Low-beam headlamps

- ▶ **To switch on the low-beam headlamps:** turn the key in the ignition lock to position **2** or start the engine.
- ▶ Turn the light switch to . The  indicator lamp in the instrument cluster lights up.

Daytime running lamps

Daytime running lamps in Canada

In Canada, the "daytime running lamps" function is required by law. It can therefore not be deactivated.

- ▶ Turn the light switch to . With the engine running: depending on the ambient light, either the daytime running lamps or the low-beam headlamps are switched on.

If the low-beam headlamps are switched on, the  indicator lamp in the instrument cluster lights up.

With the engine running while the vehicle is stationary: the low-beam headlamps switch off after 3 minutes if you shift the selector lever to **P** from a driving position.

With the engine running while the vehicle is stationary: if you set the light switch to , the parking lamps and the low-beam headlamps switch on.

If you set the light switch to  while the engine is running, the manual setting overrides the daytime running lamps.



Daytime running lamps in the USA

This function is only available on vehicles equipped with daytime running lamps.

The daytime running lamps are deactivated ex works on vehicles for the USA.



- ▶ **To switch on the daytime running lamps (vehicles with luxury multifunction steering wheel):** switch on

the "daytime running lamps" function via the on-board computer (▷ page 172).

- ▶ Turn the light switch to . With the engine running: depending on the ambient light, either the daytime running lamps or the low-beam headlamps are switched on. If the low-beam headlamps are switched on, the  indicator lamp in the instrument cluster lights up.



You can only switch on the high-beam headlamps if there is little ambient light.

However, the headlamp flashers can always be applied.

If you set the light switch to  or  while the engine is running, the manual setting overrides the daytime running lamps.

Automatic headlamps

Risk of accident

If the light switch is set to , the low-beam headlamps will not come on automatically if it is foggy. This could endanger you and others. Therefore, turn the light switch to  in fog.

The automatic headlamp feature is only an aid. The driver is responsible for the vehicle's lighting at all times.

- ▶ **To switch on automatic headlamp mode:** turn the light switch to . SmartKey in position **1** in the ignition lock: the parking lamps are switched on or off automatically depending on the brightness of the ambient light.

With the engine running: depending on the brightness of the ambient light, the daytime running lamps⁹ or the low-beam headlamps are switched on or off automatically.

When the low-beam headlamps are switched on, the  indicator lamp in the instrument cluster lights up.

⁹ Only if daytime running lamps have been activated via the on-board computer.





Fog lamps and rear fog lamps

Front fog lamps





Only vehicles with front fog lamps have the "fog lamps" function.

Warning!

If you suspect that driving conditions will be foggy, turn the light switch to  before you start your journey. Otherwise, your vehicle may not be visible and you could endanger yourself and others.

- ▶ **To switch on the front fog lamps:** turn the key in the ignition lock to position **2** or start the engine.
- ▶ Turn the light switch to  or **A**.
- ▶ Press the  button.
The green  indicator lamp in the instrument cluster lights up.
- ▶ **To switch off the front fog lamps:** press the  button.
The green  indicator lamp in the instrument cluster goes out.

Rear fog lamp

- ▶ **To switch on the rear fog lamp:** turn the key in the ignition lock to position **2** or start the engine.
- ▶ Turn the light switch to  or **A**.
When the light switch is set to **A**, the rear fog lamp only lights up if the low-beam headlamps are switched on.
- ▶ Press the  button.
The yellow  indicator lamp in the instrument cluster lights up.
- ▶ **To switch off the rear fog lamp:** press the  button.
The yellow  indicator lamp in the instrument cluster goes out.

Combination switch

Turn signals

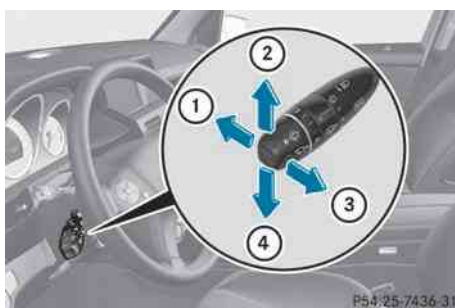

- ① High-beam headlamps
 - ② Right turn signal
 - ③ High beam flasher
 - ④ Left turn signal
- ▶ **To indicate briefly:** press the combination switch briefly to the pressure point in the direction of arrow ② or ④.
The corresponding turn signal flashes three times.
 - ▶ **To indicate:** press the combination switch beyond the pressure point in the direction of arrow ② or ④.

High-beam headlamps

- ▶ **To switch on the high-beam headlamps:** turn the key in the ignition lock to position **2** or start the engine.
- ▶ Turn the light switch to  or **A**.
- ▶ Press the combination switch beyond the pressure point in the direction of arrow ①.
In the **A** position, the high-beam headlamps are only switched on when it is dark and the engine is running.

The  indicator lamp in the instrument cluster lights up when the high-beam headlamps are switched on.

- ▶ **To switch off the high-beam headlamps:** move the combination switch back to its normal position.

The  indicator lamp in the instrument cluster goes out.

High-beam flasher

- ▶ **To switch on:** turn the key in the ignition lock to position **1** or **2** or start the engine.
- ▶ Pull the combination switch briefly in the direction of arrow .

Hazard warning lamps

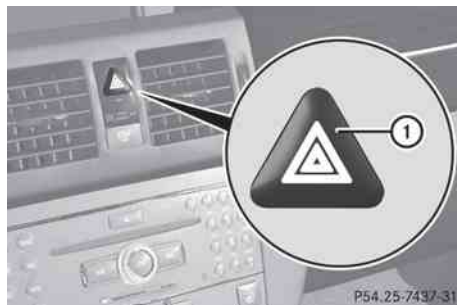

The hazard warning lamps automatically switch on:

- if an air bag is deployed
- the vehicle decelerates rapidly from a speed of more than 45 mph (70 km/h) and comes to a standstill.

- ▶ **To switch on the hazard warning lamps:** press button .

All turn signals flash. If you now switch on a turn signal using the combination switch, only the turn signal lamp on the corresponding side of the vehicle will flash.

- ▶ **To switch off the hazard warning lamps:** press button .

The hazard warning lamp switches off automatically after full brake application if the

vehicle then reaches a speed above 6 mph (10 km/h) again.

- ▶ **i** The hazard warning lamps still operate if the ignition is switched off.

Headlamp cleaning system

The headlamps are cleaned automatically if the "Wipe with washer fluid" function is operated ten times while the lights are on and the engine is running (▷ page 113). When you switch off the ignition, the automatic headlamp cleaning system is reset and counting is resumed from 0.

Active light function



The active light function is a system that moves the headlamps according to the steering movements of the front wheels. In this way, relevant areas remain illuminated while driving. This allows you to recognize pedestrians, cyclists and animals.

Active: when the lights are switched on.

Cornering light function



The cornering light function improves the illumination of the road over a wide angle in the direction you are turning, enabling better visibility in tight bends, for example. It can only be activated when the low-beam headlamps are switched on.

Active: if you are driving at speeds below 25 mph (40 km/h) and switch on the turn signals or turn the steering wheel.

Not active: if you are driving at speeds above 25 mph (40 km/h) or switch off the turn signal or turn the steering wheel to the straight-ahead position.

The cornering light function may remain lit for a short time, but is automatically switched off after no more than three minutes.

Headlamps fogged up on the inside

The headlamps may fog up on the inside if there is high atmospheric humidity.

- ▶ Drive with the headlamps switched on. The headlamps clear up after a short distance.





If the moisture does not disappear, the headlamp casing is not sealed correctly and moisture has been able to enter.

- ▶ Have the headlamps checked at a qualified specialist workshop.

Interior lighting



Overview of interior lighting

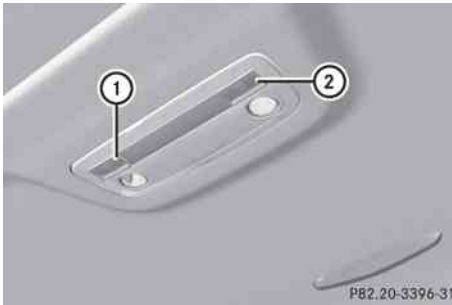

- ①  To switch the rear interior lighting on/off
- ②  To switch the automatic interior lighting control on/off
- ③  To switch the right-hand front reading lamp on/off
- ④  To switch the front interior lighting on/off
- ⑤  To switch the left-hand front reading lamp on/off
- ⑥ Front reading lamps
- ⑦ Front interior lighting



Rear-compartment overhead control panel

- ①  To switch the right-hand reading lamp on/off
- ②  To switch the left-hand reading lamp on/off

Interior lighting control

Important notes

In order to prevent the vehicle's battery from discharging, the interior lighting functions are automatically deactivated after some time except for when the key is in position **2** in the ignition lock.

Automatic interior lighting control



- ▶ **To switch on/off:** press the  button. When the automatic interior lighting control is activated, the button is flush with the overhead control panel.

The interior lighting automatically switches on if you:

- unlock the vehicle
- open a door
- remove the key from the ignition lock

The interior light is activated for a short while when the key is removed from the ignition lock. You can activate this delayed switch-off using the on-board computer (▷ page 173).

Manual interior lighting control

- ▶ **To switch the front interior lighting on/off:** press the  button.
- ▶ **To switch the rear interior lighting on/off:** press the  button.
- ▶ **To switch the reading lamps on/off:** press the  button.

Crash-responsive emergency lighting

If the interior lighting is set to automatic, the interior lighting is activated automatically if the vehicle is involved in an accident.

- ▶ **To switch off the crash-responsive emergency lighting:** press the hazard warning lamp button.

or

- ▶ Lock and then unlock the vehicle using the key.

Changing bulbs

Important safety notes

Xenon bulbs

If your vehicle is equipped with Xenon bulbs, you can recognize this by the following: the cone of light from the Xenon bulbs moves from the top to the bottom and back again when you start the engine. For this to be observed, the lights must be switched on before starting the engine.

Warning!

Xenon bulbs carry a high voltage. You could get an electric shock and be seriously or even fatally injured if you touch the electric contacts on Xenon bulbs. Therefore, never remove the cover from Xenon bulbs.

Do not change Xenon bulbs yourself, but have them replaced at a qualified specialist workshop which has the necessary specialist knowledge and tools to carry out the work required.

Mercedes-Benz recommends that you use an authorized Mercedes-Benz Center for this purpose. In particular, work relevant to safety or on safety-related systems must be carried out at a qualified specialist workshop.

Bulbs and lamps are an important aspect of vehicle safety. You must therefore make sure that these function correctly at all times. Have the headlamp setting checked regularly.

Other bulbs

Warning!

Bulbs and lamps can be very hot. You should therefore allow them to cool down before you change them. Otherwise, you could be burned if you touch them.

Keep bulbs out of the reach of children. Otherwise, they could damage the bulbs, for example, and injure themselves.

Never use a bulb which has been dropped. Such a bulb may break or even explode and injure you.

Halogen bulbs are pressurized and can explode when you change them, particularly if they are very hot. You should therefore wear eye protection and gloves when you are changing them.

There are bulbs other than the Xenon bulbs that you cannot replace. Replace only the bulbs listed (▷ page 108). Have the bulbs that you cannot replace yourself changed at a qualified specialist workshop.

Mercedes-Benz recommends that you use an authorized Mercedes-Benz Center for this purpose. In particular, work relevant to safety or on safety-related systems must be carried out at a qualified specialist workshop.

If you require assistance changing bulbs, consult a qualified specialist workshop.

Do not touch the glass tube of new bulbs with your bare hands. Even minor contamination can burn into the glass surface and reduce the service life of the bulbs. Always use a lint-

free cloth or only touch the base of the bulb when installing.

Only use bulbs of the correct type.

If the new bulb still does not light up, consult a qualified specialist workshop.

Bulbs and lamps are an important aspect of vehicle safety. You must therefore make sure that these function correctly at all times.

Have the headlamp setting checked regularly.

Overview: changing bulbs/bulb types

You can change the following bulbs. The bulb type can be found in the legend.

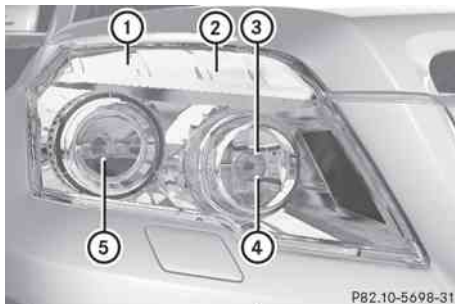

Halogen headlamps

- ① Turn signal lamp/side marker lamp: WY 5 W
- ② Turn signal lamp: PY 21 W
- ③ High-beam headlamp: H7 55 W
- ④ Parking lamp/standing lamp: W 5 W
- ⑤ Low-beam headlamp: H7 55 W

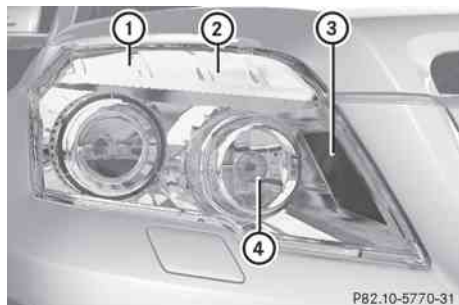

P82.10-5770-31

Bi-Xenon headlamps

- ① Turn signal lamp/side marker lamp: WY 5 W
- ② Turn signal lamp: PY 21 W
- ③ Cornering lamp: H7 55 W
- ④ Parking lamp/standing lamp: W 5 W

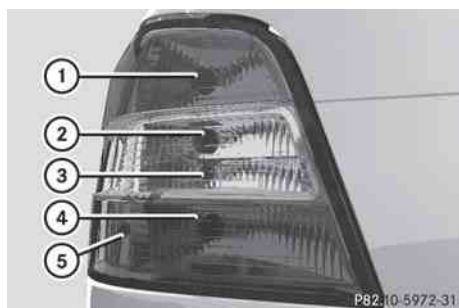

P82.10-5972-31

Tail lamp with/without LED

- ① Tail lamp/brake lamp: P 21 W
- ② Turn signal lamp: PY 21 W
- ③ Backup lamp: P 21 W or W 16 W¹⁰
- ④ Tail lamp/rear fog lamp: P 21 W
- ⑤ Side marker lamp: W 3 W



P82.10-5571-31

License plate lamp

- ① License plate lamp: W 5 W

Changing the front bulbs

Removing/installing the cover on top of the headlamp

You must remove the headlamp cover in the engine compartment before you can replace the bulbs in the headlamp.

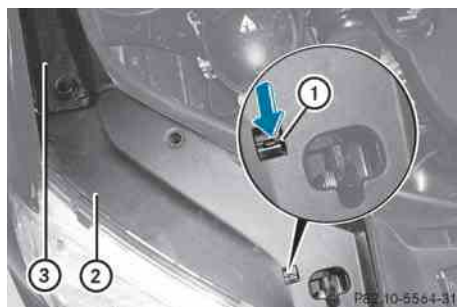

P82.10-5564-31

- ▶ **To remove:** press retaining clip ① in the direction of the arrow.
- ▶ Pull cover ② forward underneath cover ③ and remove.
- ▶ **To install:** slide cover ② under cover ③. Connect the two covers by inserting the tongue into the groove.
- ▶ Press cover ② until retaining clip ① engages.

¹⁰ Vehicles without LED turn signals (W 16 W)/vehicles with LED turn signals (P 21 W).

Loosening/tightening the washer fluid reservoir

You must remove the washer fluid reservoir from the engine compartment before you can replace the bulbs in the left-hand headlamp.

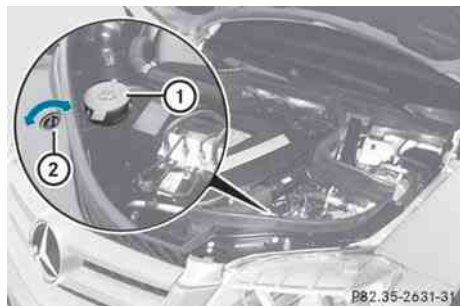

- ▶ **To detach:** turn catch ② counter-clockwise.
- ▶ Swing washer fluid reservoir ① far enough to the side to allow the bulbs of the headlamp to be replaced.
- ▶ **To attach:** swing back washer fluid reservoir ①.
- ▶ Turn catch ② clockwise.

Low-beam headlamp (halogen headlamp)

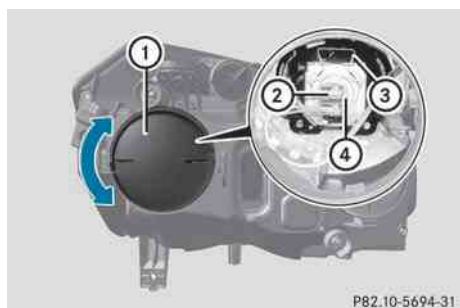

- ▶ Switch off the lights.
- ▶ Open the hood.
- ▶ Remove the headlamp cover (▷ page 109).
- ▶ Left-hand headlamp: detach the washer fluid reservoir (▷ page 110).

- ▶ Turn housing cover ① counter-clockwise and pull it out.
- ▶ Pull connector ② from bulb ④.
- ▶ Detach retaining spring ③ downwards.
- ▶ Pull out bulb ④.
- ▶ Insert the new bulb.
- ▶ Attach retaining spring ③.
- ▶ Attach connector ② to bulb ④.
- ▶ Place housing cover ① and turn it clockwise until it engages.
- ▶ Left-hand headlamp: fasten the washer fluid reservoir (▷ page 110).
- ▶ Install the headlamp cover (▷ page 109).

High-beam headlamps

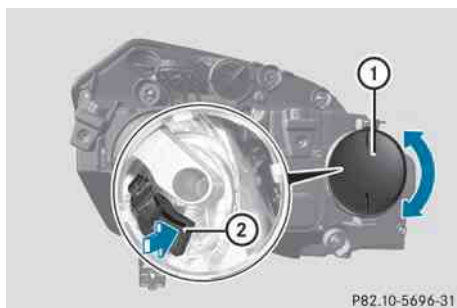

- ▶ Switch off the lights.
- ▶ Open the hood.
- ▶ Remove the headlamp cover (▷ page 109).
- ▶ Left-hand headlamp: detach the washer fluid reservoir (▷ page 110).
- ▶ Turn housing cover ① counter-clockwise and pull it out.
- ▶ Press the handle of bulb holder ② in the direction of the arrow until bulb holder ② is released.
- ▶ Take out the handle with bulb holder ②.
- ▶ Take the bulb out of bulb holder ②.

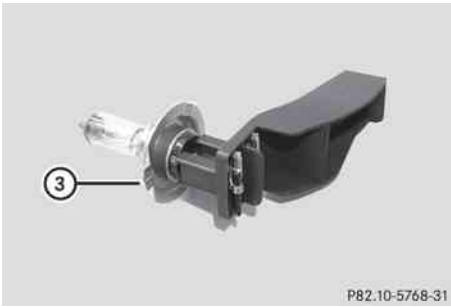

- ▶ Insert the new bulb into bulb holder ②. Lug ③ of the bulb must be pointing upward.
- ▶ Insert bulb holder ②.
- ▶ Push the handle of bulb holder ② in the opposite direction from the arrow until holder ② engages.
- ▶ Align housing cover ① and turn it clockwise until it engages.
- ▶ Left-hand headlamp: fasten the washer fluid reservoir (▷ page 110).
- ▶ Install the headlamp cover (▷ page 109).

Standing lamps/parking lamps

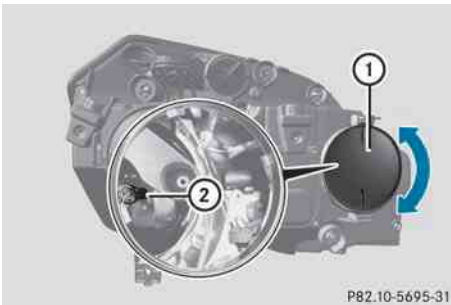

- ▶ Switch off the lights.
- ▶ Open the hood.
- ▶ Remove the headlamp cover (▷ page 109).
- ▶ Left-hand headlamp: detach the washer fluid reservoir (▷ page 110).
- ▶ Turn housing cover ① counter-clockwise and pull it out.
- ▶ Pull out bulb holder ②.

- ▶ Take the bulb out of bulb holder ②.
- ▶ Insert the new bulb into bulb holder ②.
- ▶ Insert bulb holder ②.
- ▶ Align housing cover ① and turn it clockwise until it engages.
- ▶ Left-hand headlamp: fasten the washer fluid reservoir (▷ page 110).
- ▶ Install the headlamp cover (▷ page 109).

Turn signal lamps/side marker lamps

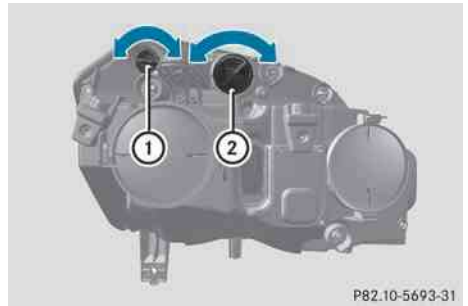

- ▶ Switch off the lights.
- ▶ Open the hood.
- ▶ Remove the headlamp cover (▷ page 109).
- ▶ Left-hand headlamp: detach the washer fluid reservoir (▷ page 110).
- ▶ Turn bulb holder ① or ② counter-clockwise and pull it out.
- ▶ WY 5 W (turn signals and side marker lamps): pull the bulb out of bulb holder ①.
- ▶ PY 21 W (turn signals): turn the bulb counter-clockwise, applying slight pressure, and remove it from bulb holder ②.
- ▶ WY 5 W (turn signals and side marker lamps): insert the new bulb into bulb holder ①.
- ▶ PY 21 W: insert the new bulb into bulb holder ② and turn it clockwise while applying slight pressure.
- ▶ Insert bulb holder ① or ② and turn it clockwise.

- ▶ Left-hand headlamp: fasten the washer fluid reservoir (▷ page 110).
- ▶ Install the headlamp cover (▷ page 109).

Changing the rear bulbs

Opening/closing the side trim

You must open the side trim panel in the cargo compartment before you can change the bulbs in the tail lamps.

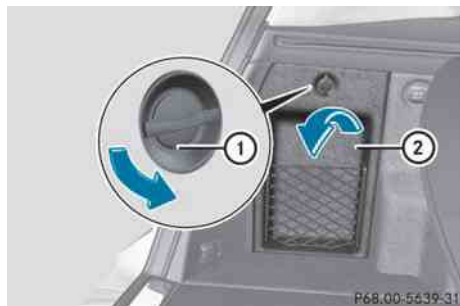

Left-hand side trim panel

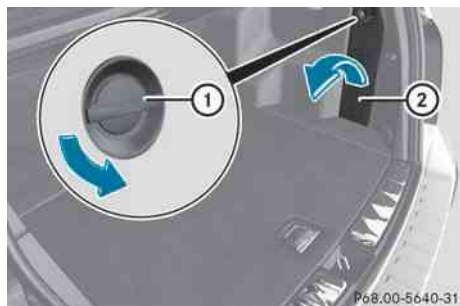

Right-hand side trim panel

- ▶ **To open:** turn release knob ① 90° in the direction of the arrow and remove side trim panel ②.
- ▶ **To close:** insert side trim panel ② and turn release knob ① 90° in the opposite direction to the arrow.

Tail lamp

- ▶ Switch off the lights.
- ▶ Open the cargo compartment.
- ▶ Open the side trim panel (▷ page 112).



- ▶ Pull out connector ②.
- ▶ Press retaining lugs ① simultaneously in the direction of the arrow and pull the bulb holder out.

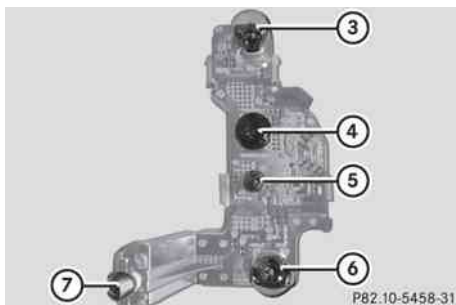

Bulb holder without LED turn signal lamp

- ③ Tail lamp/braking lamp
 - ④ Turn signals
 - ⑤ Backup lamp
 - ⑥ Rear fog lamp/tail lamp
 - ⑦ Side marker lamp
- ▶ Lightly press the corresponding bulb into the holder, turn it counter-clockwise and remove it from the bulb holder.
 - ▶ Insert the corresponding new bulb into the bulb holder and turn it clockwise.
 - ▶ Attach the bulb holder and press firmly. The retaining lugs on the bulb holder engage audibly.

- ▶ Insert the connector.
- ▶ Close the side trim panel (▷ page 112).

License plate lamp



- ▶ Switch off the lights.
- ▶ Open the tailgate.
- ▶ Press lug ② of license plate lamp ① in the direction of the arrow and remove license plate lamp lens ①.
- ▶ Remove license plate lamp lens ①.
- ▶ Replace the bulb.
- ▶ Insert license plate lamp lens ① and press it in until it engages.

Windshield wipers

Important safety notes

Warning!

Wiper blades are components that are subject to wear and tear. Replace the wiper blades twice a year, preferably in the spring and fall. Otherwise the windows will not be wiped properly. As a result, you may not be able to observe surrounding traffic conditions and could cause an accident.

- !** Do not operate the windshield wipers when the windshield is dry, as this could damage the wiper blades. Moreover, dust that has collected on the windshield/rear

window can scratch the glass if wiping takes place when the windshield/rear window is dry.





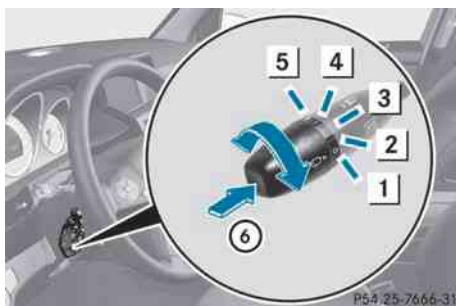

If it is necessary to switch on the windshield wipers in dry weather conditions, always use washer fluid when operating the windshield wipers.

- !** If the windshield wipers leave smears on the windscreen after the vehicle has been washed in an automatic car wash, wax or other residues may be the reason for this. Clean the windshield using washer fluid after washing the vehicle in an automatic car wash.

Switching the windshield wipers on/off



Combination switch

- 1  Windshield wipers off
- 2  Intermittent wipe, low¹¹
- 3  Intermittent wipe, high¹²
- 4  Continuous wipe, slow
- 5  Continuous wipe, fast
- 6  Single wipe/  to wipe the windshield using washer fluid

- ▶ Switch the ignition on.
- ▶ Turn the combination switch to the corresponding position.

- i** When you stop the vehicle, the wipers wipe more slowly.

¹¹ Rain sensor set to low sensitivity.

¹² Rain sensor set to high sensitivity.

! Vehicles with a rain sensor: if the windshield becomes dirty in dry weather conditions, the windshield wipers may be activated inadvertently. This could then damage the windshield wiper blades or scratch the windshield.

For this reason, you should always switch off the windshield wipers in dry weather.

Vehicles with a rain sensor: in the **[...]** or **[....]** position, the appropriate wiping frequency is automatically set according to the intensity of the rain. In the **[....]** position, the rain sensor is more sensitive than in the **[...]** position, causing the windshield wipers to wipe more frequently.

Intermittent wiping is interrupted when you stop the vehicle and open a front door. This prevents a person from being splashed inadvertently when getting into or out of the vehicle.

Intermittent wiping continues when all doors are closed and

- you shift AUTOTRONIC to drive position **D** or reverse gear **R** or
- you change the wipe setting on the combination switch.

i To prevent smearing on the windshield or noise when wiping, wipe the windshield occasionally with washer fluid.

Switching the rear window wiper on/off

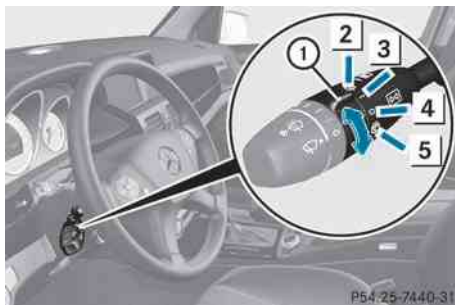

Combination switch

- ① Switch
- ② To wipe with washer fluid
- ③ To switch on intermittent wiping
- ④ To switch off intermittent wiping
- ⑤ To wipe with washer fluid

- ▶ Turn the key to position **1** or **2** in the ignition lock.
- ▶ Turn switch ① on the combination switch to the corresponding position. When the rear window wiper is switched on, the icon appears in the instrument cluster.

Replacing the wiper blades

Important safety notes

Warning

For safety reasons, switch off the windshield wipers and remove the key from the ignition lock before changing the wiper blades (vehicles with KEYLESS-GO: make sure that the on-board electronics are in state **0**). Otherwise, the wiper motor could be switched on suddenly and cause injury.

- !** To avoid damaging the wiper blades, make sure that you touch only the wiper arm of the wiper.
- !** Never open the hood if a windshield wiper arm has been folded away from the windshield.

Never fold a windshield wiper arm without a wiper blade back onto the windshield/rear window.

Hold the windshield wiper arm firmly when you change the wiper blade. If you release the windshield wiper arm without a wiper blade and it falls onto the windshield, the windshield may be damaged by the force of the impact.

Mercedes-Benz recommends that you have the wiper blades replaced by a qualified specialist workshop, e.g. at an authorized Mercedes-Benz Center.

Replacing the windshield wiper blades

Removing the wiper blades

! Before changing the wiper blades, always set the wiper arms to a vertical position using the combination switch. There is otherwise a risk of damaging the hood.

Moving the wiper arms to a vertical position

Vehicles without KEYLESS-GO

- ▶ Turn the key to position **1** or **2** in the ignition lock.
- ▶ Set the windshield wipers to position  on the combination switch.
- ▶ When the wiper arms have reached a vertical position, turn the key to position **0** and remove it from the ignition lock.

Vehicles with KEYLESS-GO

- ▶ Switch off the engine.
- ▶ Take your foot off the brake pedal.
- ▶ Set the windshield wipers to position  on the combination switch.
- ▶ Press the Start/Stop button repeatedly until the windshield wipers start.
- ▶ When the wiper arms have reached a vertical position, press the Start/Stop button.

Removing the wiper blades

- ▶ Fold the wiper arm away from the windshield until it engages.
- ▶ Set the wiper blade at right angles to the wiper arm.



- ▶ Remove the wiper blade from the retainer on the wiper arm in the direction of the arrow.

Installing the wiper blade

- ▶ Slide the new wiper blade into the retainer on the wiper arm in the opposite direction to the arrow.
Make sure that the wiper blade slides fully into the retainer on the wiper arm.
- ▶ Turn the wiper blade parallel to the wiper arm.
- ▶ Fold the wiper arm back onto the windshield.

Replacing the rear window wiper blade

Warning

The wiper arm could be set in motion and injure you if the windscreen wipers are switched on.

Remove the key from the ignition lock before replacing the wiper blade.

Removing the wiper blade

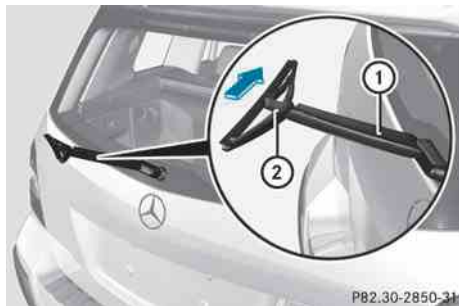

P82.30-2850-31

- ▶ Remove the key from the ignition lock.
- ▶ Fold wiper arm ① away from the rear window until it engages.
- ▶ Position wiper blade ② at a right angle to wiper arm ①.
- ▶ Hold wiper arm ① and press wiper blade ② in the direction of the arrow until it is released.
- ▶ Remove wiper blade ②.

Installing the wiper blade

- ▶ Place new wiper blade ② onto wiper arm ①.
- ▶ Hold wiper arm ① and press wiper blade ② in the opposite direction to the arrow until it engages.
- ▶ Make sure that wiper blade ② is seated correctly.
- ▶ Position wiper blade ② parallel to wiper arm ①.
- ▶ Fold wiper arm ① back onto the rear window.

- ▶ For safety reasons, you should remove the key from the ignition lock.

or

- ▶ Switch off the engine using the Start/Stop button and open the driver's door.
- ▶ Remove the cause of the obstruction.
- ▶ Switch the windshield wipers back on.

The windshield wipers are inoperative

The windshield wiper drive is malfunctioning.

- ▶ Select another wiper speed on the combination switch.
- ▶ Have the windshield wipers checked at a qualified specialist workshop.

Problems with the windshield wipers

The windshield wipers are obstructed

Leaves or snow, for example, may be obstructing the windshield wiper movement. The wiper motor has been deactivated.

Vehicle equipment	118
Overview of climate control systems	118
Operating the control systems	120
Setting the air vents	124

Vehicle equipment

- i** This manual describes all the standard and optional equipment of your vehicle which was available at the time of purchase. Country-specific differences are possible. Bear in mind that your vehicle may not feature all functions described here. This also refers to safety-related systems and functions.

Overview of climate control systems

Important safety notes

Warning

Severe conditions (e.g. strong air pollution) may require replacement of the filter before its scheduled replacement interval. A clogged filter will reduce the air volume to the interior and the windows could fog up, impairing visibility and endangering you and others. Have a clogged filter replaced as soon as possible at an authorized Mercedes-Benz Center.

Warning

Follow the recommended settings for heating and cooling given on the following pages. Otherwise, the windows could fog up, impairing visibility and endangering you and others.

Dual-zone automatic climate control controls the temperature and the humidity of the vehicle interior and filters out undesirable substances from the air.

Dual-zone automatic climate control is only operational when the engine is running. Optimum operation is only achieved when you drive with the side windows and panorama roof with power tilt/sliding panel closed.

- i** Ventilate the vehicle for a brief period during warm weather, e.g. using the convenience opening feature (> page 83).

This will speed up the cooling process and the desired vehicle interior temperature will be reached more quickly.

- i** The integrated filter can filter out most particles of dust and completely filters out pollen. A clogged filter reduces the amount of air supplied to the vehicle interior. For this reason, you should always observe the interval for replacing the filter, which is specified in the Service Booklet. As it depends on environmental conditions, e.g. heavy air pollution, the interval may be shorter than stated in the Service Booklet.

Control panel for the dual-zone automatic climate control

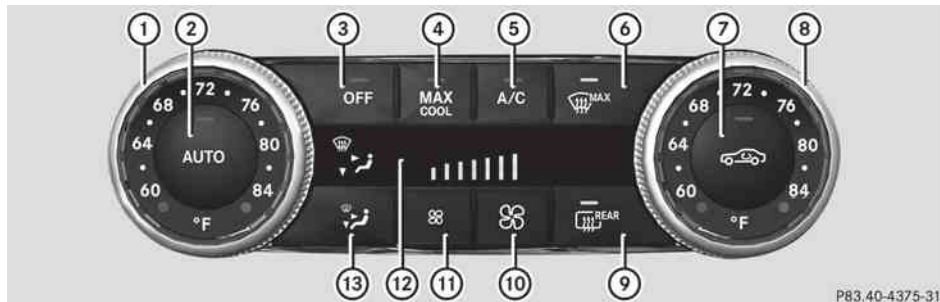

P83.40-4375-31

Function	Notes/tips
① Sets the temperature, left	Set the temperature to 72 °F (22 °C).
② Sets climate control to automatic	Activate climate control using the AUTO and A/C buttons. The indicator lamps in the AUTO and A/C buttons light up.
③ Switches climate control on/off	Activate climate control using the AUTO and A/C buttons. The indicator lamps in the AUTO and A/C buttons light up.
④ Switches the MONO/ZONE function on/off ¹³ Switches maximum cooling MAX COOL on/off ¹⁴	Use the MONO function if you want to adopt the temperature and air distribution settings from the driver's side for the front-passenger side. The indicator lamp in the MONO button lights up.
⑤ Switches cooling with air dehumidification on/off	Activate climate control using the AUTO and A/C buttons. The indicator lamps in the AUTO and A/C buttons light up.
⑥ Defrosts the windshield	Only use the "defrosting" function briefly until the windshield is clear again.
⑦ Activates/deactivates air-recirculation mode	Only use "air-recirculation" mode briefly, e.g. if there are unpleasant outside odors or when in a tunnel. The windows could otherwise fog up as, in air-recirculation mode, no fresh air is drawn into the vehicle.
⑧ Sets the temperature, right	Set the temperature to 72 °F (22 °C).
⑨ Switches the rear window heating on/off	
⑩ Increases the airflow	

¹³ Only for Canada.

¹⁴ Only for USA.

	Function	 Notes/tips
⑪	Reduces the airflow	
⑫	Display	
⑬	Sets the air distribution	

Operating the control systems

Switching the control on/off

Important information

Warning!

When the climate control system is deactivated, the outside air supply and circulation are also deactivated. Only choose this setting for a short time. Otherwise the windows could fog up, impairing visibility and endangering you and others.

-  Activate climate control primarily using the **AUTO** button (▷ page 121).

Activating/deactivating

- ▶ Turn the key to position **2** in the ignition lock.
 - ▶ **To activate:** press the **AUTO** button.
The indicator lamp in the **AUTO** button lights up. Airflow and air distribution are set to automatic mode.
- or
- ▶ Press the **OFF** button.
The indicator lamp in the **OFF** button goes out. The previously selected settings come into effect again.
 - ▶ **To deactivate:** press the **OFF** button.
The indicator lamp in the **OFF** button lights up.

Switching cooling with air dehumidification on/off

Important information

The cooling with air dehumidification function is only available when the engine is running. The air inside the vehicle is cooled and dehumidified according to the temperature selected.

Warning

If you switch off the cooling function, the vehicle will not be cooled when weather conditions are warm. The windows can fog up more quickly. Window fogging may impair visibility and endanger you and others.





Condensation may drip from the underside of the vehicle when automatic climate control is in cooling mode. This is normal and not a sign that there is a malfunction.

-  The cooling with air dehumidification function uses refrigerant R134a. This coolant does not contain chlorofluorocarbons, and therefore does not damage the ozone layer.

Activating/deactivating

-  The evaporator is ventilated when the air-conditioning system is operated. The blower switches on automatically approximately one hour after the vehicle is locked. The blower runs for 30 minutes on the lowest level. The blower noise is normal and not a sign that there is a malfunction. If you unlock the vehicle during this time, the ventilation will be interrupted. To save battery power, the evaporator will not

ventilate automatically if the starter battery is weak.

- ▶ **To switch on:** press the  button. The indicator lamp in the  button lights up.
- ▶ **To switch off:** press the  button. The indicator lamp in the  button goes out. The cooling with air dehumidification function has a delayed switch-off feature.

Problems with the "cooling with air dehumidification" function

If the indicator lamp in the  button does not go out when switched off, the cooling with air dehumidification function is switched off due to a malfunction. You can no longer activate the cooling with air dehumidification function.

- ▶ Consult a qualified specialist workshop.







Setting climate control to automatic

Warning

If you switch off the cooling function, the vehicle will not be cooled when weather conditions are warm. The windows can fog up more quickly. Window fogging may impair visibility and endanger you and others.

In automatic mode, the set temperature is maintained automatically at a constant level. The system automatically regulates the temperature of the dispensed air, the airflow and the air distribution.

Automatic mode will achieve optimal operation if cooling with air dehumidification is also activated. If desired, cooling with air dehumidification can be deactivated.

- ▶ Turn the SmartKey to position **2** in the ignition lock.
- ▶ Set the desired temperature.
- ▶ **To activate:** press the  button. The indicator lamp in the  button lights up. Automatic air distribution and airflow are activated.
- ▶ **To deactivate:** press the  button.
or
- ▶ Press the  or  button. The indicator lamp in the  button goes out. Automatic air distribution and airflow are deactivated.





Setting the temperature

Different temperatures can be set for the driver's and front-passenger sides.



- ▶ Turn the SmartKey to position **2** in the ignition lock.
- ▶ **To increase/reduce:** turn controls ① and ② clockwise or counter-clockwise (▶ page 119). Only change the temperature setting in small increments. Start at 72 °F (22 °C).

Setting the air distribution

Dual-zone automatic climate control: the air distribution can be set individually for the driver's and front-passenger sides.

-  directs the airflow through the defroster vents
-  directs the airflow through the center and side air vents
-  directs the airflow through the footwell air vents
-  directs the airflow through the center and side air vents, as well as the footwell air vents¹⁵



¹⁵ USA only.

-  directs the airflow to the entire vehicle interior¹⁶
-  directs the airflow through the defroster, center and side air vents¹⁶
-  directs the airflow through the footwell and defroster vents

i Regardless of the air distribution setting, airflow is always directed through the side air vents. The side air vents can only be closed when the controls on the side air vents are turned downwards.

- ▶ Turn the key to position **2** in the ignition lock.
- ▶ Press the  button repeatedly until the desired symbol appears in the display. The indicator lamp in the **AUTO** button goes out. Automatic control is deactivated and the air distribution is controlled according to the selected setting.

Setting the airflow

- ▶ Turn the SmartKey to position **2** in the ignition lock.
- ▶ **To increase/reduce:** press the  or  button.

Switching the MONO function on/off

This function is only available in vehicles in Canada.



You can use the MONO function to adopt the temperature and air distribution settings on the driver's side for the front-passenger side.

- ▶ Press the **MONO** button. The indicator lamp in the **MONO** button lights up or goes out.



Defrosting the windshield

You can use this function to defrost the windshield or to defrost the inside of the windshield and the side windows.

i You should only select the defrosting function until the windshield is clear again.

- ▶ Turn the SmartKey to position **2** in the ignition lock.
- ▶ **To activate:** press the  button. The indicator lamp in the  button lights up.

The climate control system switches to the following functions:

- cooling with air dehumidification on
 - high airflow¹⁷
 - high temperature¹⁷
 - air distribution to the windshield and front side windows
 - air-recirculation mode off
- ▶ **To deactivate:** press the  button. The indicator lamp in the  button goes out. The previously selected settings come into effect again. The cooling with air dehumidification function remains on. Air-recirculation mode remains deactivated.

or

- ▶ Press the **AUTO** button. The indicator lamp in the  button goes out. Airflow and air distribution are set to automatic mode.

or

- ▶ Turn controls ① or ⑧ clockwise or counter-clockwise (▷ page 119).

or

- ▶ Press the  or  button.

Maximum cooling MAX COOL



The MAX COOL function is only available in vehicles for the USA.

¹⁶ Canada only.

¹⁷ Depending on the outside temperature.



MAX COOL is only operational when the engine is running.

When you activate MAX COOL, climate control switches to the following functions:

- maximum cooling
 - maximum airflow
 - air-recirculation mode on
- ▶ **To activate:** press the  button. The indicator lamp in the button lights up.
- ▶ **To deactivate:** press the  button again. The indicator lamp goes out. The previously selected settings come into effect again.



Defrosting the windows

Windows fogged up on the inside

- ▶ Activate the "cooling with air dehumidification" function .
- ▶ Activate automatic mode .
- ▶ If the windows continue to fog up, activate the defrosting function (▶ page 122).

i You should only select this setting until the windshield is clear again.

Windows fogged up on the outside

- ▶ Switch on the windshield wipers.
- ▶ Press the  button repeatedly until the  or  symbol appears in the display.

i You should only select this setting until the windshield is clear again.

Rear window defroster



Activating/deactivating

Warning

Any accumulation of snow and ice should be removed from the rear window before driving. Visibility could otherwise be impaired, endangering you and others.

The rear window heating has a high current draw. You should therefore switch it off as soon as the window is clear as it only switches off automatically after several minutes.

If the battery voltage is too low, the rear window heating may switch off.

- ▶ Turn the SmartKey to position **2** in the ignition lock.
- ▶ Press the  button. The indicator lamp in the  button lights up or goes out.

Problems with the rear window heating

The rear window heating has deactivated itself prematurely or cannot be activated.



- ▶ Switch off any consumers that are not required, e.g. reading lamps or interior lighting. When the battery is sufficiently charged, the rear window heating is activated again automatically.

Activating/deactivating air-recirculation mode

You can deactivate the flow of fresh air if unpleasant odors are entering the vehicle from outside. The air already inside the vehicle will then be recirculated.



Warning

Fogged windows impair visibility, endangering you and others. If the windows begin to fog on the inside, switching off the air recirculation mode immediately should clear interior window fogging. If interior window fogging persists, make sure the air conditioning is activated, or press the  button.

- ▶ Turn the SmartKey to position **2** in the ignition lock.
- ▶ **To activate:** press the  button. The indicator lamp in the  button lights up.

i Air-recirculation mode is activated automatically at high outside temperatures. When air-recirculation mode is activated automatically, the indicator lamp in the  button is not lit.

Outside air is added after about 30 minutes.

► **To deactivate:** press the  button. The indicator lamp in the  button goes out.

i Air-recirculation mode switches off automatically:

- after approximately five minutes if outside temperatures are under about 41 °F (5 °C)
- after approximately five minutes if cooling with air dehumidification is deactivated
- after approximately 30 minutes if outside temperatures are over about 41 °F (5 °C)

Setting the air vents

Important safety notes

Warning

When operating the climate control, the air that enters the passenger compartment through the air vents can be very hot or very cold (depending on the set temperature). This could cause burns or frostbite to unprotected skin in the immediate area of the air vents.

Always keep sufficient distance between unprotected parts of the body and the air vents. If necessary, use the air distribution adjustment to direct the air to air vents in the vehicle interior that are not in the immediate area of unprotected skin.

In order to ensure the direct flow of fresh air through the air vents into the vehicle interior, please observe the following notes:

- keep the air inlet between the windshield and the hood free of blockages, such as ice, snow or leaves
- never cover the vents or air inlet and outlet grilles in the vehicle interior.

i For virtually draft-free ventilation, adjust the sliders of the air vents to the center position.

Setting the center air vents



- ① Center air vent, left
- ② Center air vent, right
- ③ Center vent thumbwheel, right
- ④ Center vent thumbwheel, left

► **To open/close:** turn thumbwheels ③ and ④ up or down.

Setting the side air vents

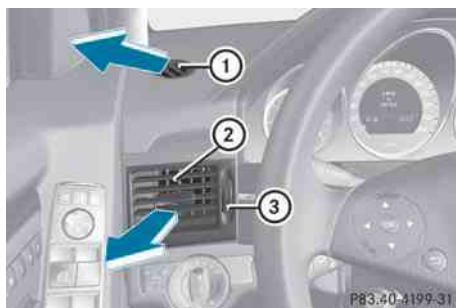

► **To open/close:** turn thumbwheel ③ up or down.

❗ Side window defroster vent ① is never completely shut, even if side air vent ② is shut.

Setting the air vent in the glove box

When automatic climate control is activated, the glove box can be ventilated, for instance to cool its contents. The level of airflow depends on the airflow and air distribution settings.

❗ Close the air vent when heating the vehicle.

At high outside temperatures, open the air vent and activate the "cooling with air dehumidification" function. Otherwise, temperature-sensitive items stored in the glove box could be damaged.



- ① Air vent thumbwheel
- ② Air vent

► **To open/close:** turn thumbwheel ① clockwise or counter-clockwise.

Setting the rear-compartment air vents

Setting the center vents in the rear compartment

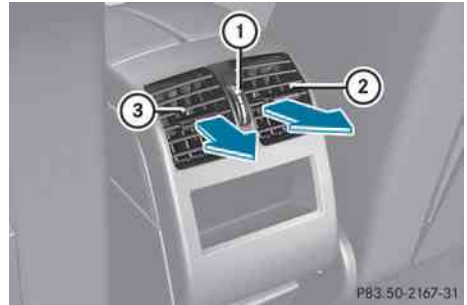

- ① Rear-compartment air vent thumbwheel
- ② Rear-compartment air vent, right
- ③ Rear-compartment air vent, left

► **To open/close:** turn thumbwheel ① up or down.

Vehicle equipment	128
Notes on breaking-in a new vehicle	128
Driving	128
Automatic transmission	134
Refueling	140
Parking	142
Driving tips	144
Driving systems	149
Off-road driving systems	156
Towing a trailer	156

Vehicle equipment

- i** This manual describes all the standard and optional equipment of your vehicle which was available at the time of purchase. Country-specific differences are possible. Bear in mind that your vehicle may not feature all functions described here. This also refers to safety-related systems and functions.

Notes on breaking-in a new vehicle

The first 1000 miles (1500 km)

The more you look after the engine when it is new, the happier you will be with its performance in the future.

- Drive at varying vehicle speeds and engine speeds for the first 1000 miles (1500 km) for this reason.
- Avoid overstraining the vehicle during this period, e.g. driving at full throttle.
- Change gear in good time, at the latest when the tachometer needle is $\frac{2}{3}$ of the way to the red area in the tachometer display.
- Do not manually shift to a lower gear to brake the vehicle.
- If possible, do not depress the accelerator pedal past the point of resistance (kickdown).
- Only select shift ranges **3**, **2** or **1** when driving slowly, e.g. in mountainous terrain.
- Ideally, drive program **E** should be selected for driving the first 1000 miles (1500 km).

After 1000 miles (1500 km) you may gradually bring the vehicle up to full road and engine speeds.

- i** Also observe these breaking-in notes when the vehicle's engine, front-axle transmission or differential have been replaced.
- i** Always observe the respective limit speeds.

Driving

Important safety notes

Warning

Make sure absolutely no objects are obstructing the pedals' range of movement. Keep the driver's footwell clear of all obstacles. If there are any floor mats or carpets in the footwell, make sure the pedals still have sufficient clearance.

During sudden driving or braking maneuvers the objects could get caught between the pedals. You could then no longer brake or accelerate. This could lead to accidents and injury.

Warning

On slippery road surfaces, never downshift in order to obtain braking action. This could result in drive wheel slip and reduced vehicle control. Your vehicle's ABS will not prevent this type of loss of control.

Warning

It is dangerous to shift AUTOTRONIC out of parking position **P** or neutral position **N** if the engine speed is higher than idle speed. If your foot is not firmly on the brake pedal, the vehicle could accelerate quickly forward or in reverse. You could lose control of the vehicle and hit someone or something. Only shift into gear when the engine is idling normally and when your right foot is firmly on the brake pedal.

- I** Warm up the engine quickly. Do not use the engine's full performance until it has reached operating temperature.

Only shift the automatic transmission to the desired drive position when the vehicle is stationary.

Where possible, avoid spinning the drive wheels when pulling away on slippery roads. You could otherwise damage the drive train.

SmartKey positions

SmartKey



- 0 To remove the SmartKey (shift the transmission to position **P**)
- 1 Power supply for some consumers, such as the windshield wipers
- 2 Ignition (power supply for all consumers) and drive position
- 3 To start the engine

Once the ignition is switched on, all the indicator lamps in the instrument cluster light up. The indicator lamps of the low-beam headlamps, high-beam headlamps, turn signal lamps or front fog lamps only light up if the low-beam headlamps, high-beam headlamps, turn signal lamps or front fog lamps are switched on. If an indicator lamp does not light up when the ignition is switched on, check it and replace it if necessary. If an indicator lamp does not go out after starting the engine or lights up while the vehicle is in motion, see (▷ page 195).

If the SmartKey is in position **0** in the ignition lock for an extended period of time, it can no longer be turned in the ignition lock. The steering is then locked. To unlock, remove the SmartKey and reinsert it in the ignition lock. The steering is locked when you remove the SmartKey from the ignition lock.

- ▶ Remove the SmartKey when the engine is switched off.
The battery may otherwise discharge.

If you cannot turn the SmartKey in the ignition lock, the vehicle battery may not be charged sufficiently.

- ▶ Check the vehicle battery and charge if necessary (▷ page 254).

or

- ▶ Jump-start the vehicle (▷ page 256).

i The SmartKey can be turned in the ignition lock even if it is not the correct SmartKey for the vehicle. The ignition is not switched on. The engine cannot be started.

KEYLESS-GO

Vehicles with KEYLESS-GO are equipped with a SmartKey with an integrated KEYLESS-GO function and a detachable Start/Stop button.

The Start/Stop button must be inserted in the ignition lock and the SmartKey must be in the vehicle.

Pressing the Start/Stop button several times in succession corresponds to the different key positions in the ignition lock. This is only the case if you are not depressing the brake pedal.

If you depress the brake pedal and press the Start/Stop button, the engine starts immediately.

The Start/Stop button can be removed from the ignition lock. Then you can insert the SmartKey in the ignition lock.

i You do not have to remove the Start/Stop button from the ignition lock when you leave the vehicle. However, you should always take the SmartKey with you when leaving the vehicle. The vehicle can be started with the Start/Stop button and the electrical equipment can be operated while the SmartKey is in the vehicle.



① Start/Stop button

② Ignition lock

► Insert Start/Stop button ① into ignition lock ②.

❗ When you insert Start/Stop button ① into ignition lock ②, the system requires a detection time of two seconds before you can use Start/Stop button ①.

► Shift the transmission to position **P**.

► Do not press the brake pedal.

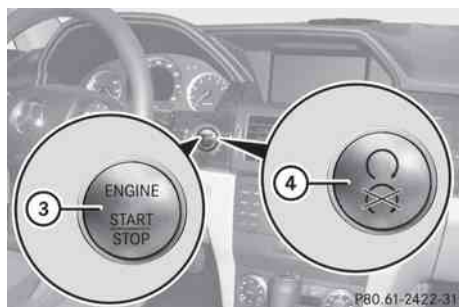

Start/Stop button

③ USA only

④ Canada only

► Position **0**: if Start/Stop button ① has not yet been pressed, this corresponds to the SmartKey being removed from the ignition.

► Position **1**: press Start/Stop button ①. You can now activate the windshield wipers, for example.

❗ If you then open the driver's door when in this position, the power supply is deactivated.

► Position **2** (ignition): press Start/Stop button ① twice.

❗ If you press Start/Stop button ① once when in this position and the driver's door is open, the power supply is deactivated again.

As soon as the ignition is switched on, all the indicator lamps in the instrument cluster light up. The indicator lamps of the low-beam headlamps, high-beam headlamps, turn signal lamps or front fog lamps only light up if the low-beam headlamps, high-beam headlamps, turn signal lamps or front fog lamps are switched on. If an indicator lamp does not light up when the ignition is switched on, check it and replace it if necessary. If an indicator lamp does not go out after the engine is started or if it lights up while the vehicle is in motion, see (▷ page 195).

Starting the engine

Important safety notes

⚠ Warning

Inhalation of exhaust gas is hazardous to your health. All exhaust gas contains carbon monoxide (CO), and inhaling it can cause unconsciousness and possible death.

Do not run the engine in confined areas (such as a garage) which are not properly ventilated. If you think that exhaust gas fumes are entering the vehicle while driving, have the cause determined and corrected immediately. If you must drive under these conditions, drive only with at least one window fully open at all times.

❗ Do not depress the accelerator pedal when starting the engine.

Automatic transmission

- ▶ Shift the transmission to position **P**.

i The transmission position display in the multifunction display shows **P**.

Starting procedure with the SmartKey

- ▶ Turn the SmartKey to position **3** in the ignition lock (▷ page 129) and release it as soon as the engine is running.

Using KEYLESS-GO to start the engine

Warning!

As long as the SmartKey is in your vehicle, the vehicle can be started. Therefore, never leave children unattended in the vehicle, as they could otherwise accidentally start the engine. When leaving the vehicle, always take the SmartKey with you and lock the vehicle. Do not leave children unattended in the vehicle, or with access to an unlocked vehicle. A child's unsupervised access to a vehicle could result in an accident and/or serious personal injury.

- i** The Start/Stop button can be used to start the vehicle without inserting the SmartKey in the ignition lock. The SmartKey must be in the vehicle.
- ▶ The Start/Stop button must be inserted in the ignition lock.
- i** To start the engine with the SmartKey instead of with KEYLESS-GO, remove the Start/Stop button from the ignition lock.
- ▶ Depress the brake pedal and keep it depressed.
- ▶ Press the Start/Stop button once (▷ page 129).
The engine starts.

Pulling away

Automatic transmission

Warning

It is dangerous to shift AUTOTRONIC out of parking position **P** or neutral position **N** if the engine speed is higher than idle speed. If your foot is not firmly on the brake pedal, the vehicle could accelerate quickly forward or in reverse. You could lose control of the vehicle and hit someone or something. Only shift into gear when the engine is idling normally and when your right foot is firmly on the brake pedal.

- i** It is only possible to shift the transmission from position **P** to the desired position if you depress the brake pedal. Only then is the selector lever lock released.
- ▶ Depress the brake pedal and keep it depressed.
- ▶ Shift the transmission to position **D** or **R**.
- ▶ Wait until the gear change is completed before pulling away.
- ▶ Release the parking brake (▷ page 143).
- ▶ Release the brake pedal.
- ▶ Carefully depress the accelerator pedal.
- !** If a warning tone sounds and the Release Park. Brake message appears in the instrument cluster, the parking brake is still applied. Release the parking brake.
- i** The vehicle locks centrally once you have pulled away. The locking knobs in the doors drop down.
You can open the doors from the inside at any time.
You can also deactivate the automatic locking feature (▷ page 173).
- i** Upshifts take place at higher engine speeds after a cold start. This helps the catalytic converter to reach its operating temperature more quickly.

Hill start assist

Hill start assist helps you when pulling away forwards or in reverse on an uphill gradient. It holds the vehicle for a short time after you have removed your foot from the brake pedal. This gives you enough time to move your foot from the brake pedal to the accelerator pedal and depress it before the vehicle begins to roll.

Warning

Never leave the vehicle when it is held by hill start assist. After approximately one second, hill start assist will no longer brake your vehicle and it could roll away.

- ▶ Take your foot off the brake pedal.
- i** Once you have taken your foot off the brake pedal, the vehicle is held for around one second.
- ▶ Pull away.

Hill start assist will not function if:

- you are pulling away on a level road or a downhill gradient.
- the transmission is in position **N**.
- the parking brake is applied.
- ESP® is malfunctioning.

Problems with the engine	
Problem	Possible causes/consequences and ► Solutions
The engine does not start. The starter motor can be heard.	<ul style="list-style-type: none"> • There is a malfunction in the engine electronics. • There is a malfunction in the fuel supply. <ul style="list-style-type: none"> ► Turn the SmartKey back to position 0 in the ignition lock before the next attempt to start with the SmartKey. ► Before the next starting attempt with KEYLESS-GO: shut all open vehicle doors so that the signals from the SmartKey may be better received. <p>or</p> <ul style="list-style-type: none"> ► Pull the Start/Stop button out of the ignition. ► Use the SmartKey to start the engine, (> page 131) as external radio signals cause KEYLESS-GO to malfunction. Avoid excessively long and frequent attempts to start the engine as these will drain the battery. <p>If the engine does not start after several attempts:</p> <ul style="list-style-type: none"> ► Consult a qualified specialist workshop.
The engine does not start. You cannot hear the starter motor.	<p>The on-board voltage is too low because the starter battery is too weak or discharged.</p> <ul style="list-style-type: none"> ► Jump-start the vehicle (> page 256). <p>If the engine does not start despite attempts to jump-start it:</p> <ul style="list-style-type: none"> ► Consult a qualified specialist workshop. <p>The starter motor was exposed to a thermal load that was too high.</p> <ul style="list-style-type: none"> ► Allow the starter motor to cool down for approximately two minutes. ► Try to start the engine again. <p>If the engine still does not start:</p> <ul style="list-style-type: none"> ► Consult a qualified specialist workshop.

Problem	Possible causes/consequences and ► Solutions
The engine is not running smoothly and is misfiring.	<p>There is a malfunction in the engine electronics or a mechanical component of the engine management system.</p> <ul style="list-style-type: none"> ► Only depress the accelerator pedal slightly. ► Have the cause rectified immediately at a qualified specialist workshop. <p>Otherwise, non-combusted fuel may get into the catalytic converter and damage it.</p>
The coolant temperature gauge shows a value above 248 °F (120 °C).	<p>The coolant level is too low. The coolant is too hot and the engine is no longer being cooled sufficiently.</p> <ul style="list-style-type: none"> ► Stop as soon as possible and allow the engine and the coolant to cool down. ► Check the coolant level (► page 234). Observe the warning notes as you do so and add coolant if necessary.

Automatic transmission

Important safety notes

Warning

It is dangerous to shift AUTOTRONIC out of parking position **P** or neutral position **N** if the engine speed is higher than idle speed. If your foot is not firmly on the brake pedal, the vehicle could accelerate quickly forward or in reverse. You could lose control of the vehicle and hit someone or something. Only shift into gear when the engine is idling normally and when your right foot is firmly on the brake pedal.

Warning!

Keep in mind that turning off the engine alone only will shift AUTOTRONIC into neutral position **N** automatically.

Always shift AUTOTRONIC into park position **P** before turning off the engine.

Otherwise the vehicle could roll away which could result in an accident and/or serious personal injury.

Selector lever

Overview of transmission positions

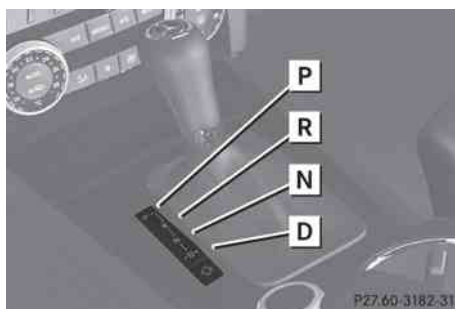

Selector lever

P Park position with selector lever lock

R Reverse

N Neutral

D Drive

Transmission position display



① Transmission position display

Displays on the cover beside the selector lever also indicate the current position of the selector lever.

The displays light up when the SmartKey is inserted in the ignition lock. The displays go out when the SmartKey is removed from the ignition lock.

Drive program display



① Drive program display

Transmission positions

P Park position

Do not shift the transmission into position **P** unless the vehicle is stationary. The parking lock should not be used as a brake when parking. In addition to engaging the parking lock, you must always apply the parking brake to secure the vehicle.

The SmartKey can only be removed if the transmission is in position **P**. If the SmartKey is removed from the ignition lock, the selector lever is locked.

In the event of a fault in the vehicle electronics, the selector lever can be locked in position **P**. To release the selector lever lock, see "Releasing the parking lock manually" (▷ page 139).

R Reverse

Only shift the transmission to **R** when the vehicle is stationary.

N**Neutral**

Do not shift the transmission to **N** while driving. The transmission could otherwise be damaged.

No power is transmitted from the engine to the drive wheels.

Releasing the brakes will allow you to move the vehicle freely, e.g. to push it or tow it.

If ESP® is deactivated or faulty: only shift the transmission to position **N** if the vehicle is in danger of skidding, e.g. on icy roads.

! Driving in neutral **N** can damage the drive train.

D**Drive**

The automatic transmission changes gear automatically. All forward gears are available.

Gearshifting

The automatic transmission shifts to the individual gears automatically when it is in transmission position **D**. This automatic gearshifting behavior is determined by:

- a shift range restriction, if selected
- the selected drive program
E/S (▷ page 137)
- the position of the accelerator pedal
- the road speed

Driving tips**Kickdown**

Use kickdown for maximum acceleration.

- ▶ **Vehicles for USA:** fully depress the accelerator pedal.
The transmission shifts to a lower gear depending on the engine speed.
- ▶ **Vehicles for Canada:** depress the accelerator pedal beyond the pressure point.
The transmission shifts to a lower gear depending on the engine speed.

Working on the vehicle**Warning**

When working on the vehicle, engage the parking brake and shift AUTOTRONIC into park position **P**. Otherwise the vehicle could roll away which could result in an accident and/or serious personal injury.

Trailer towing

- ▶ When towing a trailer and driving downhill, shift to a lower gear if the automatic transmission constantly shifts between two gears.
- ▶ Engaging a lower gear and reducing the speed reduces the risk of the engine overheating.

Program selector button

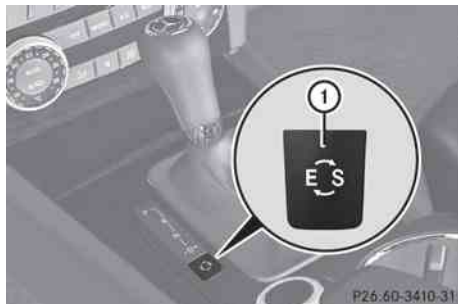

Program selector button

E Economy	Comfortable, economical driving
S Sport	Sporty driving style

i For further information on "Automatic drive program" (▷ page 137).

- ▶ Press program selector button ① repeatedly until the letter for the desired gearshift program appears in the multifunction display.

Automatic drive program

Drive program **E** is characterized by the following:

- the vehicle pulling away more gently in forward and reverse gears, unless the accelerator pedal is depressed fully
- increased sensitivity, which improves driving stability on slippery road surfaces, for example
- the automatic transmission shifting up sooner, which results in the vehicle being driven at lower engine speeds and the wheels being less likely to spin

In drive program **S**, the automatic transmission shifts up later.

Shift ranges

Introduction

When the automatic transmission is in position **D**, it is possible to restrict or derestrict the shift range (▷ page 137). The shift range selected is shown in the multifunction display. The automatic transmission shifts only as far as the selected gear.

Driving situations

- | | |
|----------|---|
| 3 | You can use the engine's braking effect. |
| 2 | To use the braking effect of the engine on downhill gradients and for driving: <ul style="list-style-type: none"> • on steep mountain roads • in mountainous terrain • in arduous conditions |
| 1 | To use the braking effect of the engine on extremely steep downhill gradients and on long downhill stretches |

Restricting the shift range

- ▶ Press the selector lever to the left towards **D-**.

The shift range is restricted.

- i** In order to prevent the engine from overrevving, the automatic transmission does not shift down when the engine speed is too high.
- i** If the maximum engine speed for the shift range is reached and you continue to accelerate, the automatic transmission shifts up in order to prevent the engine from overrevving, even if the shift range is restricted.

Derestricting the shift range

- ▶ Briefly press the selector lever to the right towards **D+**.
The shift range is derestricted.

Clearing the shift range restriction

- ▶ Press and hold the selector lever towards **D+** until **D** is shown once more in the multifunction display.
The automatic transmission shifts from the current shift range directly to **D**.

Selecting the ideal shift range

- ▶ Press the selector lever to the left towards **D-** and hold it in position.
The automatic transmission shifts to the gear which allows ideal acceleration and deceleration. To do this, the automatic transmission shifts down one or more gears.

Problems with the transmission

Problem	Possible causes/consequences and ► Solutions
<p>The acceleration ability is deteriorating.</p> <p>The transmission no longer changes gear.</p>	<p>The transmission is in emergency mode.</p> <p>It is only possible to shift into 2nd gear and reverse gear.</p> <ul style="list-style-type: none"> ► Stop the vehicle. ► Shift the transmission to position P. ► Switch off the engine. ► Wait at least 10 seconds before restarting the engine. ► Shift the transmission to position D or R. <p>If D is selected, the transmission shifts into 2nd gear; if R is selected, the transmission shifts into reverse gear.</p> <ul style="list-style-type: none"> ► Have the transmission checked at a qualified specialist workshop immediately.

Releasing the parking lock manually

In the event of an electrical malfunction, it is possible to release the selector lever lock manually to move it out of position **P**, e.g. if you wish to tow the vehicle away.

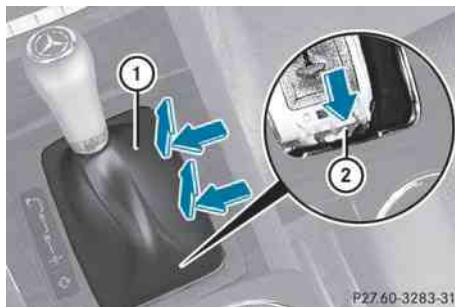

! Do not use any sharp-edged objects to remove the selector lever cover in the center console. This can damage the selector lever cover.

- Depress the parking brake firmly.
- Pry out selector lever gaiter ① with a flat, blunt object (e.g. a screwdriver wrapped in

cloth) from the right-hand edge, pulling it up and out.

- Press release button ② down and simultaneously move the selector lever out of position **P**.

The selector lever can now be moved freely until it is returned to position **P**.

Transfer case

This section is only valid for vehicles with 4-wheel drive (4MATIC). Power is always transmitted to both axles.

- !** Performance tests may only be carried out on a 2-axle dynamometer. The brake system or transfer case could otherwise be damaged. Contact an authorized Mercedes-Benz Center for a performance test. Mercedes-Benz recommends that you use an authorized Mercedes-Benz Center for this purpose.

! To prevent ESP® from intervening, the ignition must be switched off (SmartKey in position **0** or **1**) if:

- the parking brake is being tested on a brake dynamometer.
- the vehicle is being towed with only one axle raised (not permitted for vehicles with 4MATIC).

The brake system could otherwise be damaged.

Refueling

Important safety notes

Warning

Gasoline is highly flammable and poisonous. It burns violently and can cause serious personal injury.

Never allow sparks, flames or smoking materials near gasoline.

Turn off the engine before refueling.

Whenever you are around gasoline, avoid inhaling fumes and any skin or clothing contact.

Direct skin contact with fuels and the inhalation of fuel vapors are damaging to your health.

Warning

Overfilling of the fuel tank may create pressure in the system which could cause a gas discharge. This could cause the gasoline to spray back out when removing the fuel pump nozzle, which could cause personal injury.

! Do not use diesel to refuel vehicles with a gasoline engine. Even small amounts of the wrong fuel result in damage to the fuel system and engine.

! Do not switch on the ignition if you accidentally refuel with the wrong fuel. Otherwise, the fuel will enter the fuel lines. Notify a qualified specialist workshop and

have the fuel tank and fuel lines drained completely.

Gasoline

Fuel grade

! You should only refuel with unleaded premium-grade gasoline as this avoids damaging the catalytic converter.

If engine running problems are apparent, have the cause checked immediately and repaired. Excess unburned fuel can otherwise enter the catalytic converter, leading to overheating and possibly causing a fire.

i Only refuel with unleaded premium-grade gasoline with a specified minimum octane number of 91 (average value of 96 RON/86 MON).

Usually you will find information about the fuel grade on the pump. If you cannot find the label on the gasoline pump, ask the gas station staff.

You can find further information under "Fuel" (> page 296), by consulting an authorized Mercedes-Benz Center or visiting <http://www.mbusa.com> (USA only).

Refueling

Fuel filler flap

The fuel filler flap is unlocked or locked automatically when you open or close the vehicle with the SmartKey or using KEYLESS-GO.

The position of the fuel filler flap is to the rear on the right. The position of the fuel filler cap is displayed in the instrument cluster . The arrow next to the gas pump indicates the side of the vehicle.

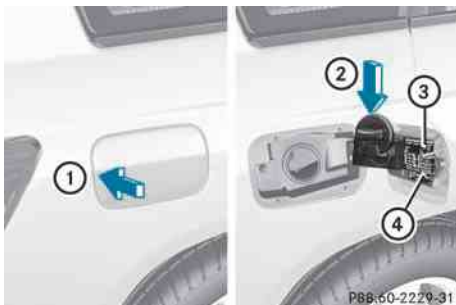

- ① To open the fuel filler flap
- ② To insert the fuel filler cap
- ③ Tire pressure table
- ④ Fuel type

Opening

- ▶ Switch off the engine.

i When the engine is running and the fuel filler flap is open, the  engine diagnostics warning lamp may light up.

For further information on warning and indicator lamps in the instrument cluster, see (▶ page 200).

- ▶ Remove the SmartKey from the ignition lock.
KEYLESS-GO: the driver's door is open. This returns the ignition to position **0**, which corresponds to the SmartKey being removed. The driver's door can be closed again.
- ▶ Press the fuel filler flap in the direction of arrow ①.
The fuel filler flap opens slightly.
- ▶ Open the fuel filler flap.
- ▶ Turn the fuel filler cap counter-clockwise and remove it.
- ▶ Insert the fuel filler cap into the holder bracket on the inside of filler flap ②.
- ▶ Completely insert the filler neck of the fuel pump nozzle into the tank and refuel.
- ▶ Only fill the tank until the pump nozzle switches off.

! Overfilling the fuel tank could damage the fuel system.

Closing

- ▶ Replace the fuel filler cap and turn it clockwise. The fuel filler cap audibly engages.
- i** Close the fuel filler flap before locking the vehicle. A locking pin otherwise prevents the fuel filler flap from closing after the vehicle has been locked.
- ▶ Close the fuel filler flap.

Emergency fuel filler flap release

Warning!

Avoid contact with the vehicle walls as they may contain sharp edges. Otherwise, you could injure yourself while releasing the fuel filler flap.

The emergency release is located behind the side trim panel in the cargo compartment.

- ▶ Open the tailgate.
- ▶ Open the right-hand side trim panel (▶ page 112).

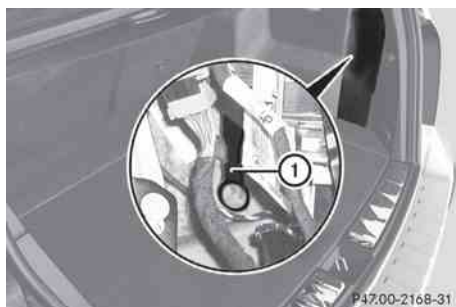

- ▶ Pull emergency release ①.
The fuel filler flap is unlocked.
- ▶ Open the fuel filler flap.

Problems with the fuel and fuel tank

Problem	Possible causes/consequences and ► Solutions
Fuel is leaking from the vehicle.	<p> Risk of explosion or fire</p> <p>The fuel line or the fuel tank is defective.</p> <ul style="list-style-type: none"> ► Turn the key to position 0 (► page 129) in the ignition lock immediately and remove it. ► Do not restart the engine under any circumstances. ► Consult a qualified specialist workshop.
The fuel filler flap cannot be opened.	<p>The fuel filler flap is not unlocked.</p> <p>or</p> <p>The key batteries are discharged.</p> <ul style="list-style-type: none"> ► Unlock the vehicle using the mechanical key (► page 71). ► Open the tailgate. ► Manually unlock the fuel filler flap using the emergency release (► page 141).
	<p>The fuel filler flap is unlocked, but the opening mechanism is jammed.</p> <ul style="list-style-type: none"> ► Manually unlock the fuel filler flap using the emergency release (► page 141). ► Consult a qualified specialist workshop.

Parking

Important safety notes

Warning!

Do not park this vehicle in areas where combustible materials such as grass, hay or leaves can come into contact with the hot exhaust system. These materials could be ignited and cause a vehicle fire.

Vehicle movement may result in serious personal injury or damage to the vehicle or vehicle drivetrain. Therefore, always do the following before turning off the engine and leaving the vehicle:

- Keep right foot on the brake pedal.
- Engage the parking brake.
- Shift the automatic transmission into park position **P**.

- Slowly release the brake pedal.
- When parked on an incline, always turn the front wheels towards the road curb.
- Turn the SmartKey in the starter switch to position **0** and remove the SmartKey from the starter switch, or press the KEYLESS-GO start/stop button.
- Take the SmartKey with you and lock the vehicle when leaving.

Switching off the engine

Important safety notes

Warning

Do not turn off the engine before the vehicle has come to a complete stop. With the engine not running, there is no power assistance for

the brake and steering systems. In this case, it is important to keep in mind that a considerably higher degree of effort is necessary to brake and steer the vehicle.

Vehicles with automatic transmission

- ▶ Apply the parking brake firmly.
- ▶ Shift the transmission to position **P**.

Using the SmartKey

- ▶ Turn the SmartKey to position **0** in the ignition lock and remove it. The immobilizer is activated.
- i** The SmartKey can only be removed if the transmission is in position **P**.

Using KEYLESS-GO

- ▶ Press the Start/Stop button (▷ page 129). When the driver's door is closed, the Start/Stop button is in position **1**. When the driver's door is opened, the Start/Stop button moves to position **0**. This corresponds to removing the SmartKey.

If you attempt to turn off the engine when the selector lever is not in position **P**, a warning signal sounds.

Observe the messages in the multifunction display.

- i** In an emergency, you can turn off the engine while the vehicle is in motion by pressing and holding the Start/Stop button for three seconds.

If you have started the engine with the Start/Stop button and it cannot be switched off as described:

- ▶ remove the Start/Stop button from the ignition lock.
- ▶ insert the SmartKey into the ignition lock. The engine stops. The ignition lock is in position **0**.

Parking brake



Warning

Engaging the parking brake while the vehicle is in motion can cause the rear wheels to lock up. You could lose control of the vehicle and cause an accident. In addition, the vehicle's brake lights do not light up when the parking brake is engaged.

Warning!

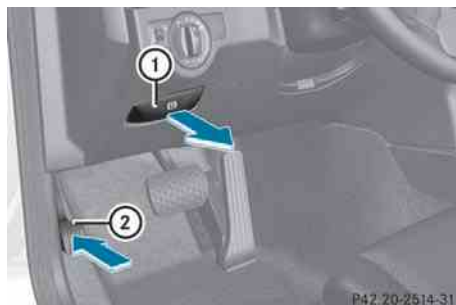
When leaving the vehicle, always remove the SmartKey from the starter switch, take it with you, and lock the vehicle. Do not leave children unattended in the vehicle, or with access to an unlocked vehicle. Children could release the parking brake and/or shift the automatic transmission out of park position **P**, either of which could result in an accident and/or serious personal injury.



- ▶ **To apply:** depress parking brake **2** firmly. When the engine is running, the **BRAKE** (USA only) or  (Canada only) indicator lamp lights up in the instrument cluster.
- ▶ **To release:** depress the brake pedal and keep it depressed.
- ▶ Pull release handle **1**. When the ignition is switched on or the engine is running, the **BRAKE** (USA only) or  (Canada only) indicator lamp goes out in the instrument cluster.

Parking up the vehicle

If you leave the vehicle parked up for longer than four weeks, the battery may be damaged by exhaustive discharge.

- ▶ Disconnect the battery or connect it to a trickle charger.
- ❗ You can obtain information about trickle chargers from a qualified specialist workshop, e.g. an authorized Mercedes-Benz Center.

If you leave the vehicle parked up for longer than six weeks, the vehicle may suffer damage as a result of lack of use.

- ▶ Visit a qualified specialist workshop and seek advice.

Driving tips

General driving tips

Important safety notes

Warning

Please do not forget that your primary responsibility is to drive the vehicle. A driver's attention to the road must always be his/her primary focus when driving. For your safety and the safety of others, we recommend that you pull over to a safe location and stop before placing or taking a telephone call.

If you use the telephone¹⁸ while driving, please use the hands-free device and only use the telephone when road, weather and traffic conditions permit. Some jurisdictions prohibit the driver from using a mobile telephone while driving a vehicle.

Only operate the audio system or COMAND¹⁸ (Cockpit Management and Data System) if road, weather and traffic conditions permit. Otherwise, you may not be able to observe traffic conditions and could endanger yourself and others.

Bear in mind that at a speed of just 30 mph (approximately 50 km/h), your vehicle is covering a distance of 44 feet (approximately 14 m) every second.

Drive sensibly – save fuel

To save fuel, observe the following notes:

- ▶ Keep tires at the recommended inflation pressures.
- ▶ Remove unnecessary cargo.
- ▶ Remove the roof rack when not in use.
- ▶ Maintain a low engine speed until the engine is warm.
- ▶ Avoid frequent acceleration and deceleration.
- ▶ Have all maintenance work performed at the service intervals specified in the Service Booklet or indicated by the service interval indicator.

Fuel consumption is also increased by driving in cold weather, in stop-and-go traffic, on short trips and in mountainous areas.

Drinking and driving

Warning

Drinking and driving and/or taking drugs and driving are very dangerous combinations. Even a small amount of alcohol or drugs can affect your reflexes, perceptions and judgment.

The possibility of a serious or even fatal accident are greatly increased when you drink or take drugs and drive.

Do not drink or take drugs and drive or allow anyone to drive who has been drinking or taking drugs.

Pedals

Warning

Make sure absolutely no objects are obstructing the pedals' range of movement.

¹⁸ Observe all legal requirements.

Keep the driver's footwell clear of all obstacles. If there are any floor mats or carpets in the footwell, make sure that the pedals still have sufficient clearance.

During sudden driving or braking maneuvers, the objects could get caught between the pedals. You could then no longer brake or accelerate. This could lead to accidents and injury.

Coasting with the engine switched off

Warning!

There is no power assistance for the steering and the brake when the engine is not running. Steering and braking requires significantly more effort and you could lose control of the vehicle and cause an accident as a result.

Do not turn off the engine while the vehicle is in motion.

Exhaust check

Warning

Inhalation of exhaust gas is hazardous to your health. All exhaust gas contains carbon monoxide (CO), and inhaling it can cause unconsciousness and possible death.

Do not run the engine in confined areas (such as a garage) which are not properly ventilated. If you think that exhaust gas fumes are entering the vehicle while driving, have the cause determined and corrected immediately. If you must drive under these conditions, drive only with at least one window fully open at all times.

Certain engine systems are designed to keep the level of poisonous components in exhaust fumes within legal limits.

These systems only work optimally if they are maintained exactly in accordance with the manufacturer's specifications. For this reason, all work on the engine must be carried out by qualified and authorized Mercedes-Benz technicians.

The engine settings must not be changed in any circumstances. Furthermore, all specific service work must be carried out at regular intervals and in accordance with the Mercedes-Benz service requirements. Details can be found in the Service Booklet.

Brakes

Important safety notes

Warning

On slippery road surfaces, never downshift in order to obtain braking action. This could result in drive wheel slip and reduced vehicle control. Your vehicle's ABS will not prevent this type of loss of control.

Warning

Make sure that you do not endanger other road users when you apply the brakes.

Downhill gradients

-  On long and steep gradients, you must reduce the cargo on the brakes by shifting to a lower gear in good time. This allows you to take advantage of engine braking and helps you to avoid overheating the brakes and wearing them out excessively. When you take advantage of engine braking, a drive wheel may not turn for some time, e.g. on a slippery road surface. This could cause damage to the drive train. Such damage is not covered by the Mercedes-Benz warranty.

Heavy and light loads

Warning

Depressing the brake pedal constantly results in excessive and premature wear to the brake pads.

It may also cause the brakes to overheat, seriously impairing their effectiveness. It may then not be possible to stop the vehicle in sufficient time to avoid an accident.

If the brakes have been subjected to a heavy cargo, do not stop the vehicle immediately, but drive on for a short while. This allows the airflow to cool the brakes more quickly.

Wet roads

Warning

After driving in heavy rain for some time without applying the brakes or through water deep enough to wet brake components, the first braking action may be somewhat reduced. You have to depress the brake pedal more firmly. Maintain a safe distance from vehicles in front.

After driving on a wet road or having the vehicle washed, brake firmly while paying attention to the traffic conditions. This will warm up the brake discs, thereby drying them more quickly and protecting them against corrosion.

Limited braking performance on salt treated roads

Warning

The layer of salt on the brake discs and the brake pads/linings may cause a delay in the braking effect, resulting in a significantly longer braking distance, which could lead to an accident.

To avoid this danger, you should:

- occasionally brake carefully, without putting other road users at risk, when you are driving on salted roads. This helps to remove any salt that may have started to build up on the brake discs and the brake pads/linings.
- maintain a greater distance to the vehicle ahead and drive with particular care.
- carefully apply the brakes at the end of a trip and immediately after commencing a new trip, so that salt residues are removed from the brake discs.

Maintenance of the brakes

 If the red brake warning lamp lights up in the instrument cluster and you hear a warning tone while the engine is running, the brake fluid level may be too low. Observe additional warning messages in the multifunction display.

The brake fluid level may be too low due to brake pad wear or leaking brake lines.

Have the brake system checked immediately. This work should be carried out at an authorized Mercedes-Benz Center.

All checks and maintenance work on the brake system must be carried out at a qualified specialist workshop. This work should be carried out at an authorized Mercedes-Benz Center.

Only install brake pads and use brake fluid recommended by Mercedes-Benz.

Warning

If other than recommended brake pads are installed, or other than recommended brake fluid is used, the braking properties of the vehicle can be degraded to an extent that safe braking is substantially impaired. This could result in an accident.

 **Vehicles with 4MATIC:** a function or performance test may only be carried out on a two-axle dynamometer. If you are planning to have the vehicle tested on such a dynamometer, contact an authorized Mercedes-Benz Center to obtain further information first. Otherwise, the drive train or the brake system may suffer damage.

 As the ESP® system operates automatically, the engine and the ignition must be switched off (SmartKey in position **0** or **1** in the ignition lock) when:

- testing the parking brake on a brake dynamometer.
- you intend to have the vehicle towed with the front or rear axle raised (not permitted for vehicles with 4MATIC).

Braking maneuvers triggered automatically by ESP® may seriously damage the brake system.

If your brake system is only subjected to moderate loads, you should regularly test your brake system's function by forcefully depressing the brake pedal when driving at high speed. This will give the brake pads better grip.

Warning

Make sure that you do not endanger other road users when you apply the brakes.

You can find a description of Brake Assist (BAS) on (▷ page 62).

Parking brake

If you drive on wet roads or dirt-covered surfaces, road salt and/or dirt could get into the parking brake.

In order to prevent corrosion and a reduction in the braking power of the parking brake, observe the following:

- gently depress the parking brake from time to time before beginning the journey.
- drive approximately 110 yd (100 m) without exceeding a speed of 12 mph (20 km/h).

Warning!

While performing this procedure please assure that the vehicle is stopped before applying the parking brake. Otherwise the rear wheels could lock up. You could lose control of the vehicle and cause an accident. In addition, the vehicle's brake lights do not light up when the parking brake is engaged. Make sure not to endanger any other road users when you engage the parking brake.

Driving on wet roads

Hydroplaning

If water has accumulated to a certain depth on the road surface, there is a danger of hydroplaning occurring, even if:

- you drive at low speeds
- the tires have adequate tread depth

For this reason, in the event of heavy rain or in conditions in which hydroplaning can occur you must drive in the following manner:

- Lower your speed
- Avoid ruts
- Brake carefully

Driving on flooded roads

 Do not drive through flooded areas. Check the depth of any water before driving through it. Drive slowly through standing water. Otherwise, water may enter the vehicle interior or the engine compartment. This can damage the electronic components in the engine or AUTOTRONIC. Water can also be drawn in by the engine's air suction nozzles and this can cause engine damage.

Prevent water from entering the vehicle interior or engine compartment. If you have to drive through standing water, please note that:

- the maximum permissible still water depth is 12 in. (30 cm).
- you should drive no faster than at walking pace.

Winter driving

Important safety notes

Have your vehicle winterproofed at a qualified specialist workshop, e.g. at an authorized Mercedes-Benz Center, at the onset of winter.

Observe the notes in the "Winter operation" section (> page 149).

Winter tires

At temperatures below 45 °F(+7 °C), use winter tires or all-season tires. Both types of tire are identified by the M+S marking.

Only winter tires also bearing the  snowflake symbol next to the M+S marking provide the best possible grip in wintry road conditions. Only these tires will allow driving safety systems such as ABS and ESP® to function optimally in winter, as these tires have been designed specifically for driving on snow.

Use M+S tires of the same make and tread on all wheels to maintain safe handling characteristics.

Warning

M+S tires with a tread depth of less than $\frac{1}{6}$ inch (4 mm) must be replaced. They are no longer suitable for winter operation.

Always observe the maximum permissible speed specified for the M+S tires you have mounted.

Once you have installed the winter tires:

- ▶ Check the tire pressures (> page 269).
- ▶ Restart the tire pressure monitor (> page 271).

Warning

If you use your spare wheel when M+S tires are fitted on the other wheels, be aware that the difference in tire characteristics may very well impair turning stability and that overall driving stability may be reduced. Adapt your driving style accordingly.

Have the spare wheel replaced by a regular road wheel with an M+S tire at the nearest authorized Mercedes-Benz Center.

Snow chains

For safety reasons, Mercedes-Benz recommends that you only use snow chains which have been specially approved for your vehicle by Mercedes-Benz, or are of a corresponding standard of quality.

 There is not enough space for snow chains on some wheel sizes. Observe the information under "Tires and wheels" in the "Technical Data" section to avoid damage to the vehicle or the wheels.

- Only use snow chains when driving on an area completely covered by snow. Do not exceed the maximum permissible speed of 30 mph (50 km/h). Remove the snow chains as soon as possible when you are no longer driving on snow-covered roads.
- Local regulations may restrict the use of snow chains. Applicable regulations must be observed if you wish to mount snow chains.
- Snow chains must not be mounted on emergency spare wheels.

If you intend to mount snow chains, please bear the following points in mind:

- you may not attach snow chains to all wheel-tire combinations; see the "Tires and wheels" section in the "Technical data" chapter.
- mount snow chains only in pairs and only on the rear wheels. Observe the manufacturer's installation instructions.

 If snow chains are mounted on the front wheels, the snow chains could grind against the bodywork or components of the chassis. This could result in damage to the vehicle or the tires.

 Vehicles with steel wheels

If you wish to mount snow chains to steel wheels, make sure that you remove the respective wheels' hubcaps first. The hubcaps may otherwise be damaged.

- i** You may wish to deactivate ESP® (▷ page 63) when pulling away with snow chains installed. This way you can allow the wheels to spin in a controlled manner, achieving an increased driving force (cutting action).

Slippery road surfaces

Warning

If the vehicle becomes stuck in snow, make sure snow is kept clear of the exhaust pipe and from around the vehicle with the engine running. Otherwise, deadly carbon monoxide (CO) gases may enter vehicle interior resulting in unconsciousness and death.

To assure sufficient fresh air ventilation, open a window slightly on the side of the vehicle not facing the wind.

Warning!

The outside temperature indicator is not designed to serve as an ice-warning device and is therefore unsuitable for that purpose.

Indicated temperatures just above the freezing point do not guarantee that the road surface is free of ice. The road may still be icy, especially in wooded areas or on bridges.

Warning

On slippery road surfaces, never downshift in order to obtain braking action. This could result in drive wheel slip and reduced vehicle control. Your vehicle's ABS will not prevent this type of loss of control.

You should drive particularly carefully on slippery road surfaces. Avoid sudden acceleration, steering and braking maneuvers. Do not use cruise control.

If the vehicle threatens to skid or cannot be stopped when moving at low speed:

- ▶ Shift the transmission to position **N**.

- i** For more information on driving with snow chains, see (▷ page 148).

Warning

Make sure that you do not endanger other road users when you apply the brakes.

Driving abroad

An extensive Mercedes-Benz Service network is also available in other countries. The Service Hotline's current telephone numbers for use when you are abroad are to be found in the "Service24h" section of the Service Booklet.

Driving systems

Cruise control

Important safety notes

Cruise control maintains a constant road speed for you. It brakes automatically in order to avoid exceeding the set speed. On long and steep downhill gradients, especially if the vehicle is laden or towing a trailer, you must select shift range **1**, **2** or **3** in good time. By doing so, you will make use of the braking effect of the engine, which relieves the load on the brake system and prevents the brakes from overheating and wearing too quickly.

Use cruise control only if road and traffic conditions make it appropriate to maintain a steady speed for a prolonged period. You can store any road speed above 20 mph (30 km/h).

Warning

The cruise control is a convenience system designed to assist the driver during vehicle operation. The driver is and must always remain responsible for the vehicle's speed and for safe brake operation.

Only use the cruise control if the road, traffic, and weather conditions make it advisable to travel at a constant speed.

- The use of the cruise control can be dangerous on winding roads or in heavy

traffic because conditions do not allow safe driving at a constant speed.

- The use of the cruise control can be dangerous on slippery roads. Rapid changes in tire traction can result in wheel spin and loss of control.
- Deactivate the cruise control when driving in fog.

The "Resume" function should only be operated if the driver is fully aware of the previously set speed and wishes to resume this particular preset speed.

Warning!

The cruise control brakes automatically so that the set speed is not exceeded.

- i** Cruise control should not be activated during off-road driving.

Cruise control lever

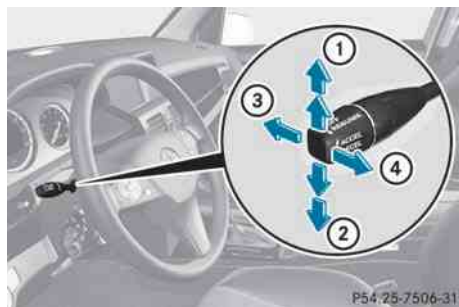

- ① To store the current speed or a higher speed
- ② To store the current speed or a lower speed
- ③ To deactivate cruise control
- ④ To store the current speed or to call up the last stored speed

When you activate cruise control, the stored speed is shown in the multifunction display for five seconds. In the multifunction display, the segments between the stored speed and the maximum speed light up.

Storing and maintaining the current speed

You can store the current speed if you are driving faster than 20 mph (30 km/h).

- ▶ Accelerate the vehicle to the desired speed.
- ▶ Briefly press the cruise control lever up ① or down ② to the pressure point.
- ▶ Remove your foot from the accelerator pedal. Cruise control is activated. The vehicle automatically maintains the stored speed.

- i** Cruise control may be unable to maintain the stored speed on uphill gradients. The stored speed is resumed when the gradient evens out. Cruise control maintains the stored speed on downhill gradients by automatically applying the brakes.

Storing the current speed or calling up the last stored speed

Warning

The set speed stored in memory should only be set again if prevailing road conditions and legal speed limits permit. Possible acceleration or deceleration differences arising from returning to the preset speed could cause an accident and/or serious injury to you and others.

- ▶ Briefly pull the cruise control lever towards you ④.
- ▶ Remove your foot from the accelerator pedal. The first time cruise control is activated, it stores the current speed or regulates the speed of the vehicle to the previously stored speed.

Setting a speed

Warning

Keep in mind that it may take a brief moment until the vehicle has made the necessary adjustments.

Increase or decrease the set vehicle speed to a value that the prevailing road conditions and legal speed limits permit. Otherwise, sudden and unexpected acceleration or deceleration of the vehicle could cause an accident and/or serious injury to you and others.

- ▶ Press the cruise control lever to the pressure point, up ① for a higher speed or down ② for a lower speed.
 - ▶ Keep the cruise control lever pressed until the desired speed is reached.
 - ▶ Release the cruise control lever. The new speed is stored.
- i** Cruise control is not deactivated if you depress the accelerator pedal. For example, if you accelerate briefly to overtake, cruise control adjusts the vehicle's speed to the last speed stored after you have finished overtaking.

Setting in 1 mph (Canada: 1 km/h) increments

- ▶ Briefly press the cruise control lever to the pressure point, up ① for a higher speed or down ② for a lower speed. The last speed stored is increased or reduced.

Setting in 5 mph (Canada: 10 km/h) increments

- ▶ Briefly press the cruise control lever beyond the pressure point, up ① for a higher speed or down ② for a lower speed. The last speed stored is increased or reduced.

Deactivating cruise control

There are several ways to deactivate cruise control:

- ▶ Briefly press the cruise control lever forwards ③.

or

- ▶ Brake.

Cruise control is automatically deactivated if:

- you depress the parking brake.
- you are driving below 20 mph (30 km/h).
- ESP® intervenes or you deactivate ESP®.
- you shift the transmission to position **N** while driving.

If cruise control is deactivated, you will hear a warning tone. You will see the **Cruise control off** message in the multifunction display for approximately five seconds.

- i** The last speed stored is cleared when you switch off the engine.

PARKTRONIC

Important safety notes

Warning!

The PARKTRONIC is a supplemental system. It is not intended to, nor does it replace, the need for extreme care. The responsibility during parking and other critical maneuvers always remains with the driver.

Warning!

Make sure no persons or animals are in or near the area in which you are parking/maneuvering. Otherwise, they could be injured.

PARKTRONIC is an electronic parking aid with ultrasonic sensors. It indicates visually and audibly the distance between your vehicle and an object.

PARKTRONIC is activated automatically when you:

- switch on the ignition.
- shift the transmission to position **D**, **R** or **N**.
- release the parking brake.

PARKTRONIC is deactivated at speeds above 11 mph (18 km/h). It is reactivated at lower speeds.

PARKTRONIC monitors the area around your vehicle using six sensors in the front bumper and four sensors in the rear bumper.

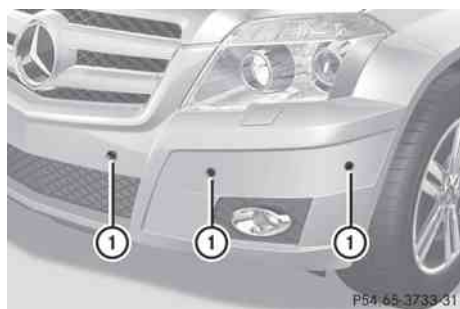

- ① Sensors in the front bumper, left-hand side (example)

Range of the sensors

The sensors must be free of dirt, ice and slush; otherwise they may not function correctly. Clean the sensors regularly, taking care not to scratch or damage them (▷ page 240).

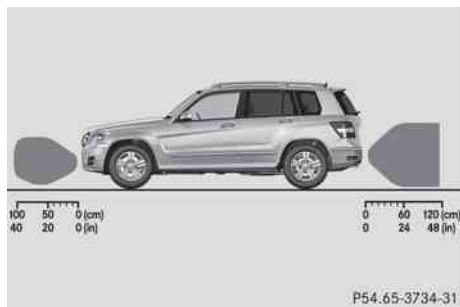

Side view

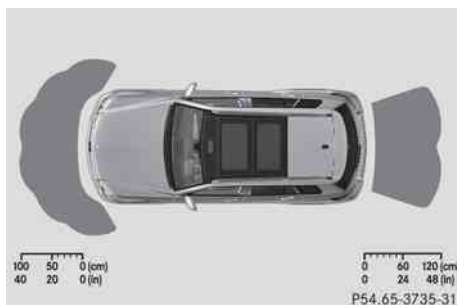

Top view

Front sensors

Center	Approx. 40 in (100 cm)
Corners	Approx. 24 in (60 cm)

Rear sensors

Center	Approx. 48 in (120 cm)
Corners	Approx. 32 in (80 cm)

- ⚠ When parking, pay particular attention to objects above or below the sensors, such as flower pots or trailer drawbars.

PARKTRONIC does not detect such objects when they are in the immediate vicinity of the vehicle. You could damage the vehicle or the objects.

Ultrasonic sources such as an automatic car wash, a truck's compressed-air brakes or a pneumatic drill could cause PARKTRONIC to malfunction.

Minimum distance

If there is an obstacle within this range, all warning displays light up and a warning tone sounds. If the distance falls below the minimum, the distance may no longer be shown.

Warning displays

The warning displays show the distance between the sensors and the obstacle. The warning display for the front area is located on the dashboard above the center air vents.

The warning display for the rear area is located on the headliner in the rear compartment.

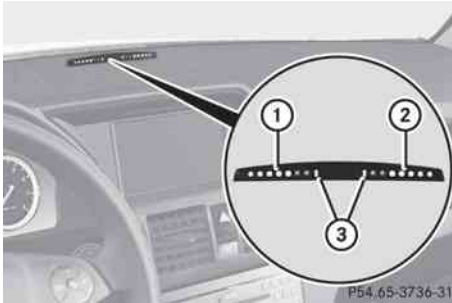

Warning display for the front area

- ① Segments on the left-hand side of the vehicle
- ② Segments on the right-hand side of the vehicle
- ③ Segments showing operational readiness

The warning display for each side of the vehicle is divided into five yellow and two red segments. PARKTRONIC is operational if yellow segments showing operational readiness ③ light up.

The selected transmission position determines which warning display is active when the engine is running.

Transmission position	Warning display
D	Front area activated
R or N	Rear and front areas activated
P	No areas activated

One or more segments light up as the vehicle approaches an obstacle, depending on the vehicle's distance from the obstacle.

From the:

- sixth segment onwards, you will hear an intermittent warning tone for approximately two seconds.
- seventh segment onwards, you will hear a warning tone for approximately two seconds. This indicates that you have now reached the minimum distance.

Deactivating/activating PARKTRONIC



- ① To deactivate/activate PARKTRONIC
- ② Indicator lamp

If indicator lamp ② lights up, PARKTRONIC is deactivated.

- ❗ PARKTRONIC is automatically activated when you turn the SmartKey to position 2 in the ignition lock.

Towing a trailer

PARKTRONIC is deactivated for the rear area when you establish an electrical connection between your vehicle and a trailer.

- ❗ Fold in the ball coupling if the trailer tow hitch is not required. PARKTRONIC measures the minimum detection range to an obstacle from the bumper, not the ball coupling.

Problems with PARKTRONIC

Problem	Possible causes/consequences and ► Solutions
Only the red segments in the PARKTRONIC warning displays are lit. You also hear a warning tone for approximately two seconds. PARKTRONIC is deactivated after approximately 20 seconds, and the indicator lamp in the PARKTRONIC button lights up.	PARKTRONIC has malfunctioned and has switched off. ► If problems persist, have PARKTRONIC checked at a qualified specialist workshop.
Only the red segments in the PARKTRONIC warning displays are lit. PARKTRONIC is deactivated after approximately 20 seconds.	The PARKTRONIC sensors are dirty or there is interference. ► Clean the PARKTRONIC sensors (► page 240). ► Switch the ignition back on. The problem may be caused by an external source of radio or ultrasound waves. ► See if PARKTRONIC functions in a different location.

Rear view camera

Important safety notes

The rear view camera is an optical parking aid. It shows the area behind your vehicle in the COMAND display.

Warning!

Make sure no persons or animals are in or near the area in which you are parking/maneuvering. Otherwise, they could be injured.

The rear view camera is located in the handle strip of the tailgate.



① Rear view camera

View through the camera

The area behind the vehicle is displayed as a mirror image, as in the rear-view mirror.

⚠ Warning!

The rear view camera is only an aid and may display obstacles

- from a distorted perspective
- inaccurately
- may not display obstacles at all

The rear view camera does not relieve you of the responsibility to be cautious. Take care and pay careful attention. The rear view camera may not show objects which are

- very close to the rear bumper
- under the rear bumper
- above the tailgate handle

You are responsible for safety at all times and must continue to pay attention to the immediate surroundings when parking and maneuvering. This includes the area behind, in front of, and beside the vehicle. Otherwise you could endanger yourself and/or others.

⚠ Warning!

The rear view camera either will not function or will not function to its full capability if

- the tailgate is open
- it is raining very hard, snowing or foggy
- it is night or you are parking/maneuvering your vehicle in an area where it is very dark
- the camera is exposed to a very bright white light
- the immediate surroundings are illuminated with fluorescent light (the display may flicker)
- there is a sudden change in temperature, e.g. if you drive into a heated garage from the cold (lens condensation)
- the camera lens is dirty or covered
- the rear of your vehicle is damaged

In this case, have the position and setting of the camera checked by a qualified specialist workshop. Mercedes-Benz recommends that you contact a Mercedes-Benz Center for this purpose.

Do not use the rear view camera in these situations. Otherwise you could injure yourself or others and/or damage property including your vehicle while parking/maneuvering.

Activating the rear view camera

- ▶ Make sure that the SmartKey is in position **2** in the ignition lock.
- ▶ Make sure that the "rear view camera" function is selected in COMAND (see the separate operating instructions for COMAND).
- ▶ Engage reverse gear.
The area behind the vehicle is shown in the COMAND display with guide lines.

Guide lines in the COMAND display**⚠ Warning!**

Use of rear view camera can be dangerous if you are color-blind or have impaired color vision.

Only use rear view camera if you can see and distinguish all colored guidelines shown by rear view camera on the COMAND system display.

⚠ Warning

Please note that objects that do not touch the ground may appear to be further away than they actually are, for example:

- the bumper of a vehicle parked behind you
- the trailer drawbar
- the ball coupling of a trailer tow hitch
- the rear end of a truck
- a slanted post

In such cases, you should not use the guide lines to judge the distance. You may misjudge the distance, which increases the risk of impacting the objects.

Even if the object you approach is directly on the ground, do not approach the object any closer than the red guide line.

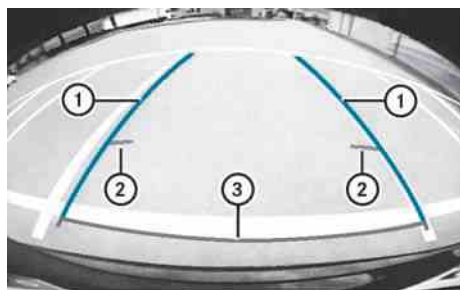

P54.65-3644-31

Guide lines ② and ③ show the approximate distance from the rear of the vehicle. Yellow guide line ② indicates a distance of approximately 3 ft (1 m) and red guide line ③ indicates a distance of approximately 10 in (0.25 m). The distances only apply to objects at ground level. Blue guide line ① depicts the width required for the vehicle. It is used to align the vehicle with the edge of the road, e.g. the curb.

Off-road driving systems

4MATIC (permanent four-wheel drive)

4MATIC ensures that all four wheels are permanently driven. Together with ESP® and ETS, it improves the traction of your vehicle whenever a drive wheel spins due to insufficient grip.

Warning!

If a drive wheel is spinning due to insufficient traction:

- While driving off, apply as little throttle as possible.
- While driving, ease up on the accelerator pedal.
- Adapt your speed and driving style to the prevailing road conditions.

Failure to observe these guidelines could cause the vehicle to skid.

The 4MATIC cannot prevent accidents resulting from excessive speed.

 Never tow the vehicle with one axle raised. This may damage the transfer case. Damage of this sort is not covered by the Mercedes-Benz Limited Warranty. All wheels must remain either on the ground or be fully raised. Observe the instructions for towing the vehicle with all wheels in full contact with the ground.

 In wintry driving conditions, the maximum effect of 4MATIC can only be achieved if you use winter tires (M+S tires), with snow chains if necessary.

 When testing the parking brake, operate the vehicle only briefly (for a maximum of ten seconds) on a brake test dynamometer. When doing this, turn the key to position **0** or **1** in the ignition. Failure to do this can cause damage to the drive train or the brake system.

 Function or performance tests may only be performed on a 2-axle dynamometer. If you wish to operate the vehicle on such a dynamometer, please consult an authorized Mercedes-Benz Center beforehand. You could otherwise damage the drive train or the brake system.

Information on "Off-road driving"; see .

Towing a trailer

Notes on towing a trailer

Important safety instructions

Warning!

Failure to use proper equipment and driving technique can result in a loss of vehicle control when towing a trailer.

Improper towing or failure to follow the instructions in this manual can result in vehicle damage and/or serious personal injury. Follow the guidelines below carefully to assure safe trailer operation.

Contact an authorized Mercedes-Benz Center should you require an explanation of information contained in this manual.

General information

- Only install an approved trailer coupling on your vehicle.
Further information on availability and on installation is available from any authorized Mercedes-Benz Center.
- The bumpers of your vehicle are not suitable for installing detachable trailer couplings.
- Do not install hired trailer couplings or other detachable trailer couplings on the bumpers of your vehicle.
- To reduce the risk of damage to the ball coupling, remove it from the ball coupling recess when not in use.

Coupling up a trailer

Observe the maximum permissible trailer dimensions (width and length).

Most federal states and all Canadian provinces require by law:

- safety chains between the towing vehicle and the trailer. The chains should be cross-wound under the trailer drawbar. They must be fastened to the vehicle's trailer coupling, not to the bumper or the axle.
Allow for enough play in the chains to facilitate turning tight corners.
- a separate brake system for certain types of trailer.
- a safety switch for braked trailers. Check the specific legal requirements applicable to your federal state.

If the trailer detaches from the towing vehicle, the safety switch applies the trailer's brakes.

! Do not connect the trailer's brake system (if featured) to the hydraulic brake system of the towing vehicle, as the latter is

equipped with an anti-lock brake system. Doing so will result in a loss of function of the brake systems of both the vehicle and the trailer.

- i** The vehicle's wiring harness features a line to the brake indicator lamp.
- ▶ Make sure that the automatic transmission is set to position **P**.
- ▶ Apply the vehicle's parking brake.
- ▶ Close all doors and the tailgate.
- ▶ Couple up the trailer.
- ▶ Establish all electrical connections.

Towing a trailer

There are numerous legal requirements concerning the towing of a trailer, e.g. speed restrictions. Make sure that your vehicle/trailer combination complies with the local requirements not only in your area of residence but also at any location to which you are traveling. The police and local authorities can provide reliable information. Please observe the following when towing a trailer:

- To acquaint yourself with driving with a trailer and with the resulting changes to handling, you should practice cornering, stopping and reversing in a traffic-free location.
- Before driving, check:
 - the trailer coupling
 - the safety switch for braked trailers
 - the safety chains
 - the electrical connections
 - the lights
 - the wheels
- Adjust the exterior mirrors to provide an unobstructed view of the rear section of the trailer.
- If the trailer features electronically controlled brakes, pull away the vehicle/trailer combination carefully, manually

brake using the brake controller, and check the brakes for correct function.

- Secure any objects on the trailer to prevent the cargo from slipping when the vehicle is in motion.
- If you couple up a trailer, regularly check the cargo for secure fastening and make sure that the trailer lamps and (if applicable) the trailer brakes are functioning correctly.
- Bear in mind that the handling will be less stable when towing a trailer than when driving without one. Avoid sudden steering movements.
- The vehicle/trailer combination is heavier, accelerates more slowly, has a decreased gradient climbing capability and a longer braking distance.

It is more susceptible to side winds and requires more careful steering.

- If possible, avoid abrupt braking. Depress the brake pedal moderately at first, so that the trailer can activate its own brakes. Then increase the pressure on the brake pedal.
 - If the automatic transmission continues to shift back and forth between two gears when driving up or downhill, restrict the shift range. Select shift range **4**, **3**, **2**, or **1**.
- A lower gear and lower speed reduce the risk of engine failure.
- When driving downhill, shift to a lower gear to utilize the engine's braking effect. Avoid continuous brake application as this may overheat the vehicle brakes and, if installed, the trailer brakes.
 - If the coolant temperature increases dramatically while the air-conditioning system is switched on, switch off the air-conditioning system.

Coolant heat can additionally be dissipated by opening the windows and by setting the

blower fan and the interior temperature to maximum.

- When overtaking, pay particular attention to the extended length of your vehicle/trailer combination.

Due to the length of your vehicle/trailer combination, you will have to travel an additional distance beyond the vehicle you are overtaking before returning to the previous lane.

Decoupling a trailer

- ▶ Make sure that the automatic transmission is set to position **P**.
- ▶ Apply the vehicle's parking brake.
- ▶ Close all doors and the tailgate.
- ▶ Apply the trailer's parking brake.
- ▶ Detach the trailer cable and decouple the trailer.
- ▶ Detach the trailer cable and decouple the trailer.

Permissible trailer load and drawbar noseweight

Weight specifications

The Gross Trailer Weight (GTW) is the combined weight of the trailer together with the cargo and equipment loaded on the trailer. Permissible gross weight: 3500 lb (1588 kg).

The permissible Trailer drawbar Weight Rating (TWR) is the maximum weight permitted on the trailer drawbar: 280 lb (127 kg) limit for Mercedes-Benz-approved trailer couplings.

Loading a trailer

- When loading a trailer, please note that neither the permissible gross trailer weight nor the permissible Gross Vehicle Weight Rating (GVWR) may be exceeded. The permissible Gross Vehicle Weight Rating

(GVWR) is specified on the type plate located on the B-pillar on the driver's side of your vehicle.

You can find the maximum permissible values on the type plates of your vehicle and the trailer. Always observe the lowest respective value when determining the maximum weight with which you can load the vehicle and the trailer.

- The drawbar noseweight acting on the ball coupling has to be added to the rear axle weight in order to prevent the permissible Gross Axle Weight Rating (GAWR) from being exceeded. The permissible Gross Vehicle Weight Rating (GVWR) is specified on the type plate located on the B-pillar on the driver's side of your vehicle.
- **i** Mercedes-Benz recommends loading the trailer so that the drawbar noseweight remains between 8% and 10% of the permissible gross trailer weight.
- **i** The weight of additional accessories, passengers, and cargo reduces the permissible trailer load and drawbar noseweight for your vehicle.

Checking the vehicle and trailer weight

- To check that the weights of the towing vehicle and the trailer comply with the maximum permissible values, have the vehicle/trailer combination (including the driver, passengers, and cargo with a fully laden trailer) weighed on a calibrated weighbridge.
- Check the permissible axle weight of the front and rear axle, the Gross Trailer Weight (GTW), and the drawbar noseweight.
Check the permissible axle weight of the front and rear axle, the Gross Trailer Weight (GTW), and the drawbar noseweight.

supplied as part of the Mercedes-Benz-approved trailer coupling.

- **i** Depending on your trailer, you may need an adapter to connect your trailer to the vehicle.

Further information is available from any authorized Mercedes-Benz Center.

Trailer power supply

The trailer power socket of your vehicle is designed for connecting the 7-pin connector

Vehicle equipment	162
Important safety notes	162
Displays and operation	162
Menus and submenus	165
Display messages	175
Warning and indicator lamps in the instrument cluster	195

Vehicle equipment

- i** This manual describes all the standard and optional equipment of your vehicle which was available at the time of purchase. Country-specific differences are possible. Bear in mind that your vehicle may not feature all functions described here. This also refers to safety-related systems and functions.

Important safety notes

You will find an illustration of the instrument cluster in the "At a glance" section (▷ page 26).

Warning

A driver's attention to the road and traffic conditions must always be his/her primary focus when driving.

For your safety and the safety of others, selecting features through the multifunction steering wheel should only be done by the driver when traffic and road conditions permit it to be done safely.

Bear in mind that at a speed of just 30 mph (approximately 50 km/h), your vehicle is covering a distance of 44 feet (approximately 14 m) every second.

Warning!

No messages will be displayed if either the instrument cluster or the multifunction display is inoperative.

As a result, you will not be able to see information about your driving conditions, such as

- speed
- outside temperature
- warning/indicator lamps
- malfunction/warning messages
- failure of any systems

Driving characteristics may be impaired.

If you must continue to drive, do so with added caution. Contact an authorized Mercedes-Benz Center as soon as possible.

Warning

Malfunction and warning messages are only indicated for certain systems and are intentionally not very detailed. The malfunction and warning messages are simply a reminder with respect to the operation of certain systems. They do not replace the owner's and/or driver's responsibility to maintain the vehicle's operating safety. Have all required maintenance and safety checks performed on the vehicle. Bring the vehicle to an authorized Mercedes-Benz Center to address the malfunction and warning messages.

Displays and operation

Coolant temperature gauge

Warning

Driving when your engine is overheated can cause some fluids which may have leaked into the engine compartment to catch fire. You could be seriously burned.

Steam from an overheated engine can cause serious burns which can occur just by opening the engine hood. Stay away from the engine if you see or hear steam coming from it.

Stop the vehicle in a safe location away from other traffic. Turn off the engine, get out of the vehicle and do not stand near the vehicle until the engine has cooled down.

The coolant temperature gauge is in the instrument cluster on the right-hand side. Under normal operating conditions and with the specified coolant level, the coolant temperature may rise to 248 °F (120 °C).

- !** If the coolant temperature is too high a display message is shown.

If the coolant temperature rises above 248 °F(120 °C), do not drive any further as this could damage the engine.

Tachometer

The red band in the tachometer indicates the engine's overrevving range.

! Do not drive in the overrevving range, as this could damage the engine.

The fuel supply is interrupted to protect the engine when the red band is reached.

Outside temperature display

The outside temperature display is in the multifunction display.

Warning!

The outside temperature indicator is not designed to serve as an ice-warning device and is therefore unsuitable for that purpose. Indicated temperatures just above the freezing point do not guarantee that the road surface is free of ice. The road may still be icy, especially in wooded areas or on bridges.

Changes in the outside temperature are displayed after a short delay.

Speedometer with segments

The segments in the speedometer indicate which speed range is available.

Cruise control mode:

The segments light up from the stored speed to the maximum speed.







Operating the on-board computer

The on-board computer is activated as soon as you turn the SmartKey to position **1** in the ignition lock.

You can control the multifunction display and the settings in the on-board computer using

the buttons on the multifunction steering wheel.



①	Multifunction display
②	 Makes/accepts or rejects/ends a call  Adjusts the volume  Mute
③	 Activates voice control; see the separate operating instructions
④	 Press briefly: Back Deactivates voice control Hides display messages
	 Press and hold: Selects the standard display
⑤	 Calls up the menu and menu bar

  **Press briefly:**

Selects the submenu or scrolls through lists

In the Audio menu: selects a stored station, an audio track or a video scene

In the Tel (telephone) menu: switches to the phone book and selects a name or telephone number

  **Press and hold:**

In the Audio menu: selects the previous/next station or selects an audio track or a video scene using rapid scrolling

In the Tel (telephone) menu: starts rapid scrolling through the phone book





Confirms selections and hides display messages

In the Tel (telephone) menu: switches to the phone book and starts dialing



① Description field

② Menu bar

► **To show menu bar** ②: press the  or  button on the steering wheel.

Multifunction display

To activate the multifunction display:

- switch on the ignition.
- switch on the lights.
- open the driver's door.

Values and settings as well as display messages are shown in the multifunction display.

Menus and submenus

Menu overview

The number of menus shown depends on the optional equipment in the vehicle.

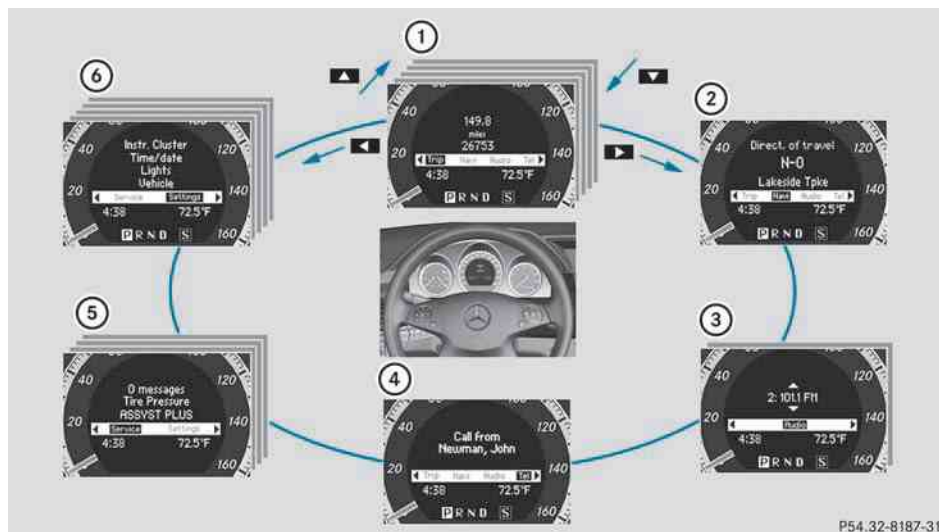

P54.32-8187-31

Function

- | | |
|---|---|
| ① | Trip menu (▷ page 166) |
| ② | Navi menu (navigation details) (▷ page 167) |
| ③ | Audio menu (▷ page 168) |
| ④ | Tel menu (telephone) (▷ page 169) |
| ⑤ | Serv. menu (▷ page 170) <ul style="list-style-type: none"> • call up display messages (▷ page 175) • tire pressure loss warning system (Canada only) (▷ page 269) • tire pressure monitor (USA only) (▷ page 271) • ASSYST PLUS service interval display (▷ page 237) |
| ⑥ | Settings (▷ page 171) menu |

The Audio and Tel menus differ slightly in vehicles with an audio system and vehicles with COMAND. The examples given in this Operator's Manual apply to vehicles equipped with COMAND.

Trip menu





Standard display



- ▶ Press and hold the  button on the steering wheel until the Trip menu with odometer ① and trip odometer ② is shown.

Trip computer "From start" or "From reset"

The values in the From Start submenu are calculated from the start of a journey whilst the values in the From Reset submenu are calculated from the last time the submenu was reset.

- ▶ Press  or  on the steering wheel to select the Trip menu.
- ▶ Press  or  to select From Start or From Reset.



Trip computer "After start" (example)

- ① Distance
- ② Time
- ③ Average speed
- ④ Average fuel consumption





The From Start trip computer is reset automatically when

- the ignition has been switched off for more than 4 hours.
- 999 hours have been exceeded.
- 9999 miles have been exceeded.

The From Reset trip computer is automatically reset if the trip exceeds 9999 hours or 99,999 miles.

You can select km or miles as the unit of measurement for distance (> page 171).

Displaying the range and current fuel consumption



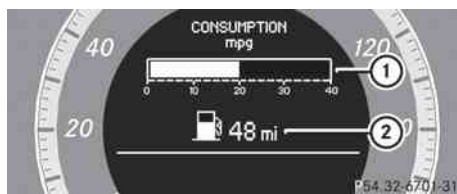

- ▶ Press  or  on the steering wheel to select the Trip menu.
- ▶ Press the  or  button to select current fuel consumption and approximate range.



- ① Current fuel consumption
- ② Approximate range

Approximate range ② is calculated according to current driving style and the amount of fuel in the tank. If there is only a small amount of fuel left in the fuel tank, the display shows a vehicle being refueled  instead of range ②.

Digital speedometer

- ▶ Press  or  on the steering wheel to select the Trip menu.
- ▶ Press  or  to select the digital speedometer.

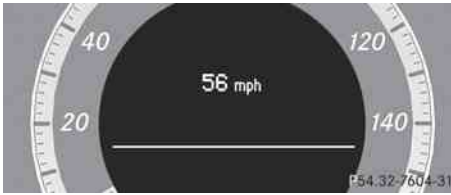

Resetting values

You can reset the values of the following functions:

- Trip odometer
- Trip computer "From start"
- Trip computer "From reset"
- ▶ Press or on the steering wheel to select the Trip menu.
- ▶ Press or to select the function that you wish to reset.
- ▶ Press .

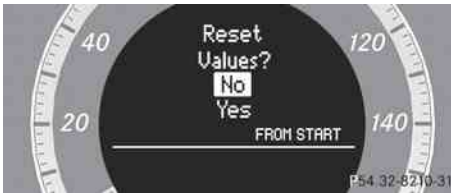

Resetting the trip computer "From start" (example)

- ▶ Press the button to select Yes and press the button to confirm.

Navigation menu

Displaying navigation instructions

In the Navi menu, the multifunction display shows navigation instructions. For more information, see the separate operating instructions.

- ▶ Switch on COMAND (see the separate operating instructions).
- ▶ Press the or button on the steering wheel to select the Navi menu.

Route guidance inactive



- ① Direction of travel
- ② Current road

Route guidance active

No change of direction announced



- ① Distance to destination
- ② Distance to next change of direction
- ③ Current road
- ④ Symbol for "follow the road's course"

Change of direction announced without a lane recommendation



- ① Road into which the change of direction leads
- ② Distance to change of direction and visual distance display
- ③ Symbol for change of direction

When a change of direction has been announced, you will see visual distance display ② next to symbol ③ for the change of direction. This decreases in size as you approach the announced change of direction.

Change of direction announced with a lane recommendation

Lane recommendations are only displayed if the relevant data is available on the digital map.



- ① Road into which the change of direction leads
- ② Distance to change of direction and visual distance display
- ③ Lane recommendation
- ④ Symbol for change of direction

On multi-lane roads, lane recommendation ③ may be shown for the next change of direction. Lanes may be added during a change of direction.



Lane recommendation display (example)

- ① Uninterrupted lane
- ② New lane during a change of direction
- ③ Lane recommended for the change of direction

Other status indicators of the navigation system

-  : you have reached the destination.
- New Route... or Calculating Route: a new route is being calculated.

- Off Map or Off Mapped Road: the vehicle position is outside the area of the digital map (off-map position).
- No Route: no route could be calculated to the selected destination.



Audio menu

Selecting a radio station

- ① SIRIUS XM satellite radio acts like a normal radio.







For more information on satellite radio operation, see the separate operating instructions.

You can only change the waveband and store new stations using the audio system or COMAND.

- ▶ Switch on the audio system or COMAND and select Radio (see the separate operating instructions).
- ▶ Press the  or  button on the steering wheel to select the Audio menu.



- ① Waveband¹⁹
- ② Station

- ▶ **To select a stored channel:** briefly press the  or  button.
- ▶ **To select a channel from the channel list:** press and briefly hold the  or  button.
- ▶ **To select a station using the station search²⁰:** press and briefly hold the  or  button.

¹⁹ When station ② has been stored, the memory position will also be displayed.

²⁰ Only if no station list is received.

Audio player or audio media operation

Audio data from various audio devices or media can be played, depending on the equipment installed in the vehicle.

- ▶ Switch on the audio system or COMAND APS and select the audio device or medium; see the separate operating instructions.
- ▶ Press the ◀ or ▶ button on the steering wheel to select the Audio menu.



CD player display (example)

① Current track

- ▶ **To select the next/previous track:** briefly press the ▲ or ▼ button.
- ▶ **To select a track from the track list (rapid scrolling):** press and hold the ▲ or ▼ button until the desired track has been reached.

If track information is stored on the audio device or medium, the multifunction display will show the number and name of the track. The current track does not appear in audio AUX mode (**A**uxiliary audio mode: external audio source connected).

Video DVD operation

- ▶ Switch on COMAND and select video DVD (see the separate operating instructions).
- ▶ Press the ◀ or ▶ button on the steering wheel to select the Audio menu.



① Current scene

- ▶ **To select the next or previous scene:** briefly press the ▲ or the ▼ button.
- ▶ **To select a scene from the scene list (rapid scrolling):** press and hold the ▲ or ▼ button until the desired scene has been reached.

Telephone menu

Introduction

You can establish a Bluetooth® wireless connection to the audio system or to COMAND (see the separate operating instructions).

Warning

A driver's attention to the road must always be his/her primary focus when driving. For your safety and the safety of others, we recommend that you pull over to a safe location and stop before placing or taking a telephone call. If you choose to use the telephone while driving, please use the hands-free device and only use the telephone when weather, road and traffic conditions permit.

Some jurisdictions prohibit the driver from using a mobile phone while driving a vehicle. Bear in mind that at a speed of just 30 mph (approximately 50 km/h), your vehicle is covering a distance of 44 feet (approximately 14 m) every second.

- ▶ Switch on the mobile phone and audio system or COMAND (see the separate operating instructions).
- ▶ Press the ◀ or ▶ button on the steering wheel to select the Tel menu.

You will see one of the following display messages in the multifunction display:

- Telephone Ready or the name of the network provider: the mobile phone has found a network and is ready to receive.
- No Service: No network is available.

Accepting a call

If someone calls you when you are in the Te1 menu, a display message appears in the multifunction display, for example:

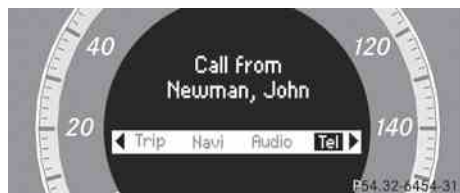

- ▶ Press on the steering wheel to accept an incoming call.

You can accept a call even if you are not in the Te1 menu.

Rejecting or ending a call

- ▶ Press the button on the steering wheel.

You can end or reject a call even if you are not in the Te1 menu.

Dialing a number from the phone book

If your mobile phone is able to receive calls, you can search for and dial a number from the phone book in the audio system or COMAND at any time.

- ▶ Copy the telephone book of the mobile phone into the audio system or to COMAND (see the separate operating instructions).
- ▶ Press the or button on the steering wheel to select the Te1 menu.
- ▶ Press the , or button to call up the phone book.
- ▶ Press or to select the name you are searching for.

To start scrolling rapidly, press and hold the or button for longer than one second. After a short time, the rapid scroll speeds up.

Rapid scrolling stops when you release the button or reach the end of the list.

- ▶ **If only one telephone number is stored for a name:** press the or button to start dialing.

or

- ▶ **If there is more than one number for a particular name:** press the or button to display the numbers.

- ▶ Press the or button to select the number you want to dial.

- ▶ Press the or button to start dialing.

or

- ▶ **If you do not want to make a call:** press the button.

Redialing

The on-board computer saves the last names or numbers dialed in the redial memory.

- ▶ Press the or button on the steering wheel to select the Te1 menu.
- ▶ Press the button to switch to the redial memory.
- ▶ Press the or button to select the desired name or number.
- ▶ Press the or button to start dialing.

Maintenance menu



In the Service menu you can:

- call up display messages (▷ page 175)
- restart the tire pressure loss warning system (Canada only) (▷ page 269)
- check the tire pressure electronically (USA only) (▷ page 271)
- call up the service due date (▷ page 237)

Settings menu

Introduction



In the Settings menu, you have the following options:

- Changing the instrument cluster settings
- Changing the time/date settings²¹
- Changing the lighting settings
- Changing the vehicle settings
- Changing the convenience settings
- Restoring the factory settings

Instrument cluster

Selecting the unit of measurement for distance

The Display Unit Speed-/Odometer: function allows you to choose whether certain displays appear in km/h or mph in the multifunction display.

The selected unit of measurement for distance applies to:

- the digital speedometer in the Trip menu
 - the odometer and the trip odometer
 - the trip computer
 - the navigation instructions in the Navi menu
- ▶ Press the or button on the steering wheel to select the Settings menu.
- ▶ Press the or button to select the Instr. Cluster submenu.
- ▶ Press the button to confirm.

- ▶ Press the or button to select the Display Unit Speed-/Odometer. function.

You will see the selected setting: km or miles.

- ▶ Press the button to save the setting.

Selecting the permanent display function

The Permanent Display: function allows you to choose whether the multifunction display always shows the outside temperature or the speed in km/h (USA) or mph (Canada).

- ▶ Press the or button on the steering wheel to select the Settings menu.
- ▶ Press the or button to select the Instr. Cluster submenu.
- ▶ Press the button to confirm.
- ▶ Press or to select the Permanent Display: function.
- You will see the selected setting Outside Temperature or Speedometer [km/h]:.
- ▶ Press the button to save the setting.





Time/date

This submenu is only available on vehicles with Audio 20. To set the time and date on vehicles with COMAND, see the separate operating instructions.

In the Time/date submenu, you can set the time and date.

- ▶ Press the or button on the steering wheel to select the Settings menu.
- ▶ Press the or button to select the Time/date submenu.
- ▶ Press the button to confirm.
- ▶ Press the or button to select Time: or Date:.
- The current time or date set is displayed.
- ▶ Press to change the setting.

²¹ This function is not available in vehicles with COMAND.

- ▶ Press the  or  button to select the display you want to change: hour, minute, day, month, year.
- ▶ Press the  or  button to set the selected display.
- ▶ Press the  button to store the entry.









Lights

Switching the daytime running lamps on/off

This function is not available in Canada.

If you have activated the Daytime Running Lights: function and the light switch is in the  position the daytime running lamps are switched on automatically when the engine is running.

In the dark, the following also light up:

- the low-beam headlamps
- the parking lamps
- the tail lamps
- the license plate lamp
- the side marker lamps
- ▶ Press the  or  button on the steering wheel to select the Settings menu.
- ▶ Press the  or  button to select the Lights submenu.
- ▶ Press the  button to confirm.
- ▶ Press the  or  button to select the Daytime Running Lights: function. You will see the selected setting: Enabled or Disabled.
- ▶ Press the  button to save the setting.

Activating/deactivating surround lighting and exterior lighting delayed switch-off

If you switch on the Locator Lighting: function and the light switch is set to ,









- the exterior lighting switches on when it is dark after unlocking the vehicle with the SmartKey.

The exterior lighting switches off when you open the driver's door.

- the exterior lighting remains on for 15 seconds when it is dark after closing the doors.

If the engine is switched off and then none of the doors are opened, or if an open door is not closed, the exterior lighting goes out after 60 seconds.

If you activate the Locator Lighting: function, the following light up:

- the parking lamps
- the tail lamps
- the fog lamps²²
- the low-beam headlamps²³
- the license plate lamp
- the side marker lamps
- ▶ Press the  or  button on the steering wheel to select the Settings menu.
- ▶ Press the  or  button to select the Lights submenu.
- ▶ Press the  button to confirm.
- ▶ Press the  or  button to select the Locator Lighting: function. You will see the selected setting: Enabled or Disabled.
- ▶ Press the  button to save the setting.

To deactivate the delayed shut-off temporarily:

- ▶ Before leaving the vehicle, turn the SmartKey to position **0** in the ignition lock.
- ▶ Turn the SmartKey to position **2** in the ignition lock and back to position **0**. The delayed shut-off is deactivated.









The delayed shut-off is reactivated the next time you start the engine.

²² Only for vehicles with front fog lamps.

²³ Only for vehicles without front fog lamps.

Activating/deactivating the interior lighting delayed switch-off









If the Interior Lighting Delay: function is activated and you pull the SmartKey out of the ignition lock, the interior lighting remains on for around 10 seconds.

- ▶ Press the  or  button on the steering wheel to select the Settings menu.
- ▶ Press the  or  button to select the Lights submenu.
- ▶ Press the  button to confirm.
- ▶ Press the  or  button to select the Interior Lighting Delay: function. You will see the selected setting: Enabled or Disabled.
- ▶ Press the  button to save the setting.

Vehicle

Activating/deactivating the automatic locking feature









If you select the Automatic Door Lock: function, the vehicle is centrally locked above a speed of around 9 mph (15 km/h).

-  Further information on the automatic locking feature (▷ page 76).
- ▶ Press the  or  button on the steering wheel to select the Settings menu.
- ▶ Press the  or  button to select the Vehicle submenu.
- ▶ Press the  button to confirm.
- ▶ Press the  or  button to select the Automatic Door Lock: function. You will see the selected setting: Enabled or Disabled.
- ▶ Press the  button to save the setting.

Activating/deactivating the acoustic locking confirmation

If you switch on the Acoustic Lock Feedback: function, an acoustic signal sounds when you lock or unlock the vehicle.

When unlocking, the signal sounds once. When locking, it sounds three times.

- ▶ Press the  or  button on the steering wheel to select the Settings menu.
- ▶ Press the  or  button to select the Vehicle submenu.
- ▶ Press the  button to confirm.
- ▶ Press the  or  button to select the Acoustic Lock Feedback: function. You will see the selected setting: Enabled or Disabled.
- ▶ Press the  button to save the setting.

Convenience

Activating/deactivating the EASY-ENTRY/EXIT feature





You can use the Easy Entry/Exit: function to activate or deactivate the easy-entry/exit feature (▷ page 96).



Warning!

You must make sure no one can become trapped or injured by the moving steering wheel when the easy-entry/exit feature is activated.

To stop steering wheel movement, move steering wheel adjustment lever or press one of the memory position buttons.

Do not leave children unattended in the vehicle, or with access to an unlocked vehicle. Children could open the driver's door and unintentionally activate the easy-entry/exit feature, which could result in an accident and/or serious personal injury.

- ▶ Press the  or  button on the steering wheel to select the Settings menu.
- ▶ Press the  or  button to select the Convenience submenu.
- ▶ Press the  button to confirm.









- ▶ Press the  or  button to select the Easy Entry/Exit: feature.
You will see the selected setting: Enabled or Disabled.
- ▶ Press the  button to save the setting.

Switching the fold in mirrors when locking function on/off

This function is only available in Canada.





If you switch on the Fold Mirrors In when Locking: function, the exterior mirrors fold in when you lock the vehicle. When you unlock the vehicle and then open the driver's or front-passenger door, the exterior mirrors fold out again.





If you have switched the function on and you fold the exterior mirrors in using the button on the door (▷ page 98), they will not fold out automatically. The exterior mirrors can then only be folded out using the button on the door.

- ▶ Press the  or  button on the steering wheel to select the Settings menu.
- ▶ Press the  or  button to select the Convenience submenu.
- ▶ Press the  button to confirm.
- ▶ Press the  or  button to select the Fold Mirrors in when Locking: function.
You will see the selected setting: Enabled or Disabled.
- ▶ Press the  button to save the setting.

Resetting to factory settings

For safety reasons, the Daytime Running Lights: function in the Light submenu is only reset if the vehicle is stationary.

- ▶ Press the  or  button on the steering wheel to select the Settings menu.
- ▶ Press the  or  button to select the Factory Setting submenu.

- ▶ Press the  button to confirm.
The Reset All Settings? message appears.
- ▶ Press the  or  button to select No or Yes.
- ▶ Press the  button to confirm the selection.
If you have selected Yes, the multifunction display shows a confirmation message.

Display messages



Hiding display messages

Warning

All categories of messages contain important information which should be taken note of and, where a malfunction is indicated, addressed as soon as possible at an authorized Mercedes-Benz Center.

Failure to repair the condition noted may cause damage not covered by the Mercedes-Benz Limited Warranty, or result in property damage or personal injury.

Display messages appear in the multifunction display.

- ▶ Press the  or  button on the steering wheel to hide the display message. The display message is cleared.

The multifunction display shows high-priority display messages in red.







You cannot hide display messages of the highest priority. The multifunction display shows these messages continuously until the causes for the messages have been remedied.

Certain display messages are accompanied by an audible warning tone or a continuous tone.

Please respond in accordance with the display messages and follow the additional notes in this Operator's Manual.

Message memory

You can read the display messages in the **message memory**.

- ▶ Press  or  on the steering wheel to select the Service menu. If there are display messages, the multifunction display shows 2 messages, for example.
- ▶ Press the  or  button to select the entry, e.g. 2 messages.
- ▶ Confirm with .
- ▶ Press the  or  button to scroll through the display messages.

When the ignition is switched off, all display messages are deleted apart from some high-priority display messages. Once the causes of the high-priority display messages have been rectified, the corresponding display messages are also deleted.

Safety systems



Display messages



Inoperative See Operator's Manual

Possible causes/consequences and ► Solutions

 **Risk of accident**

ESP® (Electronic Stability Program), BAS (Brake Assist), hill start assist and trailer stabilization are not available due to a malfunction. In addition, the  and  warning lamps light up in the instrument cluster.



The brake system continues to function normally, but without the functions listed above.

- Drive on carefully.
- Visit a qualified specialist workshop.



ESC Currently Unavailable See Operator's Manual

 **Risk of accident**

ESP®, BAS, hill start assist and ESP® trailer stabilization are temporarily unavailable. In addition, the  and  warning lamps light up in the instrument cluster.

The self-diagnosis function might not be complete, for example.



The brake system continues to function normally, but without the functions listed above.

- Carefully drive a suitable distance making slight steering movements at a speed above 12 mph (20 km/h).
If the display message disappears, the functions mentioned above are available again.

If the display message continues to be displayed:

- Drive on carefully.
- Visit a qualified specialist workshop.

 **Risk of accident**

ESP®, BAS, hill start assist and ESP® trailer stabilization are temporarily unavailable. In addition, the  and  warning lamps light up in the instrument cluster.













The on-board voltage may be insufficient, for example.









The brake system continues to function normally, but without the functions listed above.

- Drive on carefully.
If the display message disappears, the functions mentioned above are available again.

If the display message continues to be displayed:

- Visit a qualified specialist workshop.



Display messages	Possible causes/consequences and ► Solutions
	<p> Risk of accident</p> <p>If the display message is shown and the  warning lamp flashes at the same time, ETS (Electronic Traction System) is deactivated. The brakes on the drive wheels could otherwise overheat.</p> <p>► Let the brakes cool down until the display message disappears and the  warning lamp goes out. ETS is active again.</p>
<p> Tele Aid Inoperative</p>	<p>USA only: one or more main functions in the mbrace system are malfunctioning.</p> <p>Canada only: one or more of the main functions of the TELEAID system is malfunctioning.</p> <p>► USA only: have the mbrace system checked at a qualified specialist workshop.</p> <p>► Canada only: have the TELEAID system checked at a qualified specialist workshop.</p>
<p>Check Child Seat Pos. See Operator's Manual</p>	<p> Risk of injury</p> <p>Vehicles with BabySmart™ (Canada only): The BabySmart™ child seat is positioned incorrectly.</p> <p>► Install the child seat in the correct position.</p> <p> Risk of injury</p> <p>Vehicles with BabySmart™ (Canada only): The sensor for automatic child seat recognition is faulty.</p> <p>► Visit a qualified specialist workshop.</p>
<p> SRS Malfunction Service Required</p>	<p> Risk of injury</p> <p>There is a malfunction in the SRS (Supplemental Restraint System). The  warning lamp also lights up in the instrument cluster.</p> <p>► Visit a qualified specialist workshop.</p>
<p> Front Left SRS Malfunction Service Required or Front Right SRS Malfunction Service Required</p>	<p> Risk of injury</p> <p>SRS has malfunctioned at the front on the left or right. The  warning lamp also lights up in the instrument cluster.</p> <p>► Visit a qualified specialist workshop.</p>

Display messages	Possible causes/consequences and ► Solutions
 <p>Rear Left SRS Malfunction Service Required or Rear Right SRS Malfunction Service Required</p>	<p> Risk of injury</p> <p>SRS has malfunctioned at the rear on the left or right. The  warning lamp also lights up in the instrument cluster.</p> <p>► Visit a qualified specialist workshop.</p>
 <p>Rear Center SRS Malfunction Service Required</p>	<p> Risk of injury</p> <p>SRS has malfunctioned at the rear center. The  warning lamp also lights up in the instrument cluster.</p> <p>► Visit a qualified specialist workshop.</p>
 <p>Left Side Curtain Airbag Malfunction Service Required or Right Side Curtain Airbag Malfunction Service Required</p>	<p> Risk of injury</p> <p>There is a malfunction in the left-hand and/or right-hand window curtain air bag. The  warning lamp also lights up in the instrument cluster.</p> <p>► Visit a qualified specialist workshop.</p>

Warning



In the event a malfunction of the SRS is indicated as outlined above, the SRS may not be operational.

For your safety, we strongly recommend that you contact an authorized Mercedes-Benz Center immediately to have the system checked. Otherwise the SRS may not be activated when needed in an accident, which could result in serious or fatal injury, or it might deploy unexpectedly and unnecessarily which could also result in injury.

Display messages	Possible causes/consequences and ► Solutions
<p>Front Passenger Airbag Enabled See Operator's Manual</p>	<p>The front-passenger air bag is enabled during the journey, although:</p> <ul style="list-style-type: none"> • there is a child, a small adult or an object weighing less than the system's weight threshold on the front-passenger seat. • the front-passenger seat is unoccupied. <p>The system may detect the additional weight of objects on the seat or forces acting on the seat.</p> <ul style="list-style-type: none"> ► Pull over and stop the vehicle safely as soon as possible, paying attention to road and traffic conditions. ► Engage the parking brake. ► Switch off the ignition. ► Open the front-passenger door. ► Remove the child and the child restraint system from the front-passenger seat. ► If necessary, secure the child in a child restraint system on a suitable rear seat. ► Make sure that there are no objects adding to the weight applied to the seat. The system may otherwise detect the additional weight and interpret the seat occupant's weight as greater than it actually is. ► Make sure that the seat is unoccupied and has no objects placed on it, close the front-passenger door, and switch on the ignition. <p>Observe the  <small>FRONT PASSENGER AIR BAG OFF</small> (► page 41) indicator lamps and the multifunction display and check the following:</p> <p>Seat unoccupied and ignition switched on:</p> <ul style="list-style-type: none"> • the  <small>FRONT PASSENGER AIR BAG OFF</small> indicator lamp must light up and remain lit. When the indicator lamp is on, OCS (► page 41) has deactivated the front-passenger air bag. • The Front Passenger Airbag Enabled See Operator's Manual or Front Passenger Airbag Disabled See Operator's Manual display messages must not appear. Wait for at least 60 seconds until the necessary system checks have been completed and to make sure that the display messages do not appear in the multifunction display. <p>If these conditions are met, the front-passenger seat can be occupied again. Whether the  <small>FRONT PASSENGER AIR BAG OFF</small> indicator lamp remains lit or goes out depends on how OCS classifies the occupant.</p> <p>If the conditions are not met, the system is not operating correctly.</p> <ul style="list-style-type: none"> ► Visit a qualified specialist workshop immediately.











Warning

















If the  indicator lamp remains off even after performing the above corrective steps, do not have any children 12 years old and under and other small individuals use the front-passenger seat until the system has been repaired.

Display messages	Possible causes/consequences and ► Solutions
Front Passenger Airbag Disabled See Operator's Manual	<p>The front-passenger air bag is deactivated during the journey even though an adult or a person larger than a certain size is occupying the front-passenger seat. If additional forces are applied to the seat, the system may interpret the occupant's weight as lower than it actually is.</p> <ul style="list-style-type: none"> ► Pull over and stop the vehicle safely as soon as possible, paying attention to road and traffic conditions. ► Engage the parking brake. ► Switch off the ignition. ► Have the occupant get out of the vehicle. ► Make sure that the seat is unoccupied and has no objects placed on it, close the front-passenger door, and switch on the ignition. <p>Observe the  indicator lamps and the multifunction display and check the following: Seat unoccupied and ignition switched on:</p> <ul style="list-style-type: none"> • the  indicator lamp must light up and remain lit. When the indicator lamp is on, OCS (► page 41) has deactivated the front-passenger air bag. • The Front Passenger Airbag Enabled See Operator's Manual or Front Passenger Airbag Disabled See Operator's Manual display messages must not appear. Wait for at least 60 seconds until the necessary system checks have been completed and to make sure that the display messages do not appear in the multifunction display. <p>If these conditions are met, the front-passenger seat can be occupied again. Whether the  indicator lamp remains lit or goes out depends on how OCS classifies the occupant. If the conditions are not met, the system is not operating correctly.</p> <ul style="list-style-type: none"> ► Visit a qualified specialist workshop immediately.

Warning

If the  indicator lamp remains lit with an adult occupant on the front-passenger seat even after performing the above corrective steps, do not have any passenger use the front-passenger seat until the system has been repaired.

Brakes	
Display messages	Possible causes/consequences and ► Solutions
<p> (USA only)</p> <p> (Canada only)</p> <p>ABS and ESC Currently Unavailable See Operator's Manual</p>	<p> Risk of accident</p> <p>ABS (Anti-lock Braking System), ESP® (Electronic Stability Program), BAS (Brake Assist), hill start assist and ESP® trailer stabilization are temporarily unavailable. The self-diagnosis might not be finished, for example. In addition, the ,  and  warning lamps light up in the instrument cluster.</p> <p>The brake system continues to function normally, but without the functions listed above. The wheels could therefore lock if you brake hard, for example.</p> <ul style="list-style-type: none"> ► Carefully drive a suitable distance making slight steering movements at a speed above 12 mph (20 km/h). If the display message disappears, the functions mentioned above are available again. <p>If the display message continues to be displayed:</p> <ul style="list-style-type: none"> ► Drive on carefully. ► Visit a qualified specialist workshop. <p> Risk of accident</p> <p>ABS, ESP®, BAS, hill start assist and trailer stabilization are temporarily unavailable. The on-board voltage may be insufficient, for example. In addition, the ,  and  warning lamps light up in the instrument cluster.</p> <p>The brake system continues to function normally, but without the functions listed above. The wheels could therefore lock if you brake hard, for example.</p> <ul style="list-style-type: none"> ► Drive on carefully. If the display message disappears, the functions mentioned above are available again. <p>If the display message continues to be displayed:</p> <ul style="list-style-type: none"> ► Drive on carefully. ► Visit a qualified specialist workshop.

Display messages	Possible causes/consequences and ► Solutions
 <p>(USA only) (Canada only)</p> <p>ABS and ESC Inoperative See Operator's Manual</p>	<p> Risk of accident</p> <p>ABS, ESP[®], BAS, hill start assist and ESP[®] trailer stabilization are unavailable due to a malfunction. In addition, the ,  and  warning lamps light up in the instrument cluster.</p> <p>The brake system continues to function normally, but without the functions listed above. The wheels could therefore lock if you brake hard, for example.</p> <ul style="list-style-type: none"> ► Drive on carefully. ► Visit a qualified specialist workshop.
 <p>(USA only) (Canada only)</p> <p>EBD, ABS, and ESC Inoperative See Operator's Manual</p>	<p> Risk of accident</p> <p>EBD (Electronic Brake force Distribution), ABS, ESP[®], BAS, hill start assist and ESP[®] trailer stabilization are unavailable due to a malfunction. In addition, the ,  and  warning lamps in the instrument cluster light up and a warning tone sounds.</p> <p>The brake system continues to function normally, but without the functions listed above. The wheels could therefore lock if you brake hard, for example.</p> <ul style="list-style-type: none"> ► Drive on carefully. ► Visit a qualified specialist workshop immediately.
 <p>Check Brake Pad Wear</p>	<p>The brake pads/linings have reached their wear limit.</p> <ul style="list-style-type: none"> ► Visit a qualified specialist workshop.
 <p>(USA only) (Canada only)</p> <p>Release Park. Brake</p>	<p>You are driving with the parking brake engaged. A warning tone also sounds.</p> <ul style="list-style-type: none"> ► Release the parking brake.
 <p>(USA only) (Canada only)</p> <p>Check Brake Fluid Level</p>	<p> Risk of accident</p> <p>There is insufficient brake fluid in the brake fluid reservoir. Additionally, the red  (USA only)/  (Canada only) warning lamp lights up in the instrument cluster and a warning tone sounds.</p> <ul style="list-style-type: none"> ► Pull over and stop the vehicle safely as soon as possible, paying attention to road and traffic conditions. Do not continue driving under any circumstances. ► Engage the parking brake. ► Consult a qualified specialist workshop. ► Do not add brake fluid. This will not rectify the malfunction.





Warning





Driving with the message Check Brake Fluid Level displayed can result in an accident. Have your brake system checked immediately.





Do not add brake fluid before checking the brake system. Overfilling the brake fluid reservoir can result in spilling brake fluid on hot engine parts and the brake fluid catching fire. You can be seriously burned.







Lights**i** Display messages concerning LEDs:

This display message will only appear if all LEDs have failed.

Display messages	Possible causes/consequences and ► Solutions
 Check Left Corner'g Lite or Right Corner'g Lite	<p>The left or right-hand cornering light is faulty.</p> <p>► Check whether you are permitted to change the bulb yourself (► page 107).</p> <p>or</p> <p>► Visit a qualified specialist workshop.</p>
 Check Left Low Beam or Check Right Low Beam	<p>The left or right-hand low-beam headlamp is faulty.</p> <p>► Check whether you are permitted to change the bulb yourself (► page 107).</p> <p>or</p> <p>► Visit a qualified specialist workshop.</p>
 Chk. Trailer Lt Tail Lamp or Chk. Trailer Rt Tail Lamp	<p>The left or right-hand trailer tail light is faulty.</p> <p>► Check whether you are permitted to change the bulb yourself.</p> <p>or</p> <p>► Visit a qualified specialist workshop.</p>
 Check Trailer Lt. Turn Sig. or Chk. Trailer Rt Turn Sig.	<p>The left or right-hand trailer turn signal lamp is faulty.</p> <p>► Check whether you are permitted to change the bulb yourself.</p> <p>or</p> <p>► Visit a qualified specialist workshop.</p>
 Chk. Trailer Brake Lamp	<p>The trailer brake lamp is faulty.</p> <p>► Check whether you are permitted to change the bulb yourself.</p> <p>or</p> <p>► Visit a qualified specialist workshop.</p>

Display messages	Possible causes/consequences and ► Solutions
 <p>Turn Signal Rear Left or Chk. Rear Rt Turn Signal</p>	<p>The rear left-hand or rear right-hand turn signal is faulty.</p> <ul style="list-style-type: none"> ► Check whether you are permitted to change the bulb yourself (▷ page 107). or ► Visit a qualified specialist workshop.
 <p>Chk. Front Lt. Turn Signal or Front right indicator</p>	<p>The front left-hand or front right-hand turn signal is faulty.</p> <ul style="list-style-type: none"> ► Check whether you are permitted to change the bulb yourself (▷ page 107). or ► Visit a qualified specialist workshop.
 <p>Check Left Mirror Signal or Check Right Mirror Signal</p>	<p>The turn signal in the left-hand and/or right-hand exterior mirror is faulty.</p> <ul style="list-style-type: none"> ► Check whether you are permitted to change the bulb yourself (▷ page 107). or ► Visit a qualified specialist workshop.
 <p>Chk. Center Brake Lamp</p>	<p>The high-mounted brake lamp is faulty.</p> <ul style="list-style-type: none"> ► Check whether you are permitted to change the bulb yourself (▷ page 107). or ► Visit a qualified specialist workshop.
 <p>Chk. Lt. Tail +Brake Lmp. or Chk. Rt. Tail +Brake Lmp.</p>	<p>The left or right-hand tail lamp/brake lamp is faulty.</p> <ul style="list-style-type: none"> ► Check whether you are permitted to change the bulb yourself (▷ page 107). or ► Visit a qualified specialist workshop.
 <p>Check Left High Beam or Check Right High Beam</p>	<p>The left or right-hand high beam is faulty.</p> <ul style="list-style-type: none"> ► Check whether you are permitted to change the bulb yourself (▷ page 107). or ► Visit a qualified specialist workshop.

Display messages	Possible causes/consequences and ► Solutions
 <p>Chk. Left Lic. Pl Lamp or Chk. Right Lic. Pl Lamp</p>	<p>The left or right-hand license plate lamp is faulty.</p> <ul style="list-style-type: none"> ► Check whether you are permitted to change the bulb yourself (► page 107). or ► Visit a qualified specialist workshop.
 <p>Check Left Fog Lamp or Check Right Fog Lamp</p>	<p>The left-hand or right-hand front fog lamp is faulty.</p> <ul style="list-style-type: none"> ► Check whether you are permitted to change the bulb yourself (► page 107). or ► Visit a qualified specialist workshop.
 <p>Chk. Rear Lt. Fog Lamp or Chk. Rear Rt Fog Lamp</p>	<p>The left-hand or right-hand rear fog lamp is faulty.</p> <ul style="list-style-type: none"> ► Check whether you are permitted to change the bulb yourself (► page 107). or ► Visit a qualified specialist workshop.
 <p>Chk. Front Lt. Park'g Lmp or Chk. Front Rt. Park'g Lmp.</p>	<p>The front left or front right standing lamp is faulty.</p> <ul style="list-style-type: none"> ► Check whether you are permitted to change the bulb yourself (► page 107). or ► Visit a qualified specialist workshop.
 <p>Check Left Revers. Lmp or Check Right Revers. Lamp</p>	<p>The left or right-hand backup lamp is faulty.</p> <ul style="list-style-type: none"> ► Check whether you are permitted to change the bulb yourself (► page 107). or ► Visit a qualified specialist workshop.
 <p>Chk. Front Lt Sidemarker or Chk. Front Rt Sidemarker</p>	<p>The front left or right side marker lamp is faulty.</p> <ul style="list-style-type: none"> ► Check whether you are permitted to change the bulb yourself (► page 107). or ► Visit a qualified specialist workshop.

Display messages	Possible causes/consequences and ► Solutions
 <p>Check Rear Lt. Sidemarker or Chk. Rear Rt Sidemarker</p>	<p>The rear left or right side marker lamp is faulty.</p> <ul style="list-style-type: none"> ► Check whether you are permitted to change the bulb yourself (▷ page 107). or ► Visit a qualified specialist workshop.
 <p>Chk. Lt. Day Running Lite or Chk. Rt. Day Running Lite</p>	<p>The left or right-hand daytime running lamp is defective.</p> <ul style="list-style-type: none"> ► Check whether you are permitted to change the bulb yourself (▷ page 107). or ► Visit a qualified specialist workshop.
 <p>Active Headlamps Inoperative</p>	<p>The active light function is faulty.</p> <ul style="list-style-type: none"> ► Visit a qualified specialist workshop.
 <p>Malfunction See Operator's Manual</p>	<p>The exterior lighting is faulty.</p> <ul style="list-style-type: none"> ► Visit a qualified specialist workshop.
 <p>AUTO Lamps Inoperative</p>	<p>The light sensor is faulty. The low-beam headlamps are switched on.</p> <ul style="list-style-type: none"> ► USA only: switch off the daytime driving lights in the on-board computer (▷ page 172). ► Switch the lights on and off using the light switch. ► Visit a qualified specialist workshop.
 <p>Switch Off Lights</p>	<p>The lights are still switched on when you leave the vehicle. A warning tone also sounds.</p> <ul style="list-style-type: none"> ► Turn the light switch to .

Engine

Display messages	Possible causes/consequences and ► Solutions
 <p>Check Coolant Level See Operator's Manual</p>	<p>The coolant level is too low.</p> <ul style="list-style-type: none"> ► Add coolant, observing the warning notes when doing so (▷ page 234). ► If coolant needs adding more often than usual, have the engine coolant system checked at a qualified specialist workshop.

 **Warning**

Do not spill antifreeze on hot engine parts. Antifreeze contains ethylene glycol which may burn if it comes into contact with hot engine parts. You could be seriously burned.

- !** The coolant level is too low. Avoid making long journeys with too little coolant in the cooling system. The engine will otherwise be damaged.

The display messages and the corresponding symbol that indicate that the coolant level is too low must not be ignored.

Display messages	Possible causes/consequences and ► Solutions
 <p>Coolant Level Low Stop Vehicle Turn Engine Off</p>	<p>The coolant is too hot.</p> <ul style="list-style-type: none"> ► Pull over and stop the vehicle safely as soon as possible, paying attention to road and traffic conditions. ► Make sure that the air supply to the radiator is not blocked, e.g. by snow, slush or ice. ► Wait until the display message disappears before restarting the engine. There is otherwise a risk of engine damage. ► Pay attention to the coolant temperature display. ► If the temperature increases again, visit a qualified specialist workshop immediately. <p>The poly-V-belt may have torn.</p> <ul style="list-style-type: none"> ► Pull over and stop the vehicle safely as soon as possible, paying attention to road and traffic conditions. ► Open the hood. ► Check whether the poly-V-belt is torn. <p>If the poly-V-belt is torn:</p> <ul style="list-style-type: none"> ! Do not continue driving. The engine could otherwise overheat. ► Consult a qualified specialist workshop. <p>If the poly-V-belt is OK:</p> <ul style="list-style-type: none"> ► Wait until the display message disappears before restarting the engine. There is otherwise a risk of engine damage. ► Pay attention to the coolant temperature display. ► Visit a qualified specialist workshop.



 **Warning**

Driving when your engine is overheated can cause some fluids which may have leaked into the engine compartment to catch fire. You could be seriously burned.

Steam from an overheated engine can cause serious burns which can occur just by opening the engine hood. Stay away from the engine if you see or hear steam coming from it.

Stop the vehicle in a safe location away from other traffic. Turn off the engine, get out of the vehicle and do not stand near the vehicle until the engine has cooled down.



! If the coolant temperature exceeds 248 °F (120 °C) do not continue driving. The engine will otherwise be damaged.

Display messages	Possible causes/consequences and ► Solutions
	<p>The engine fan is faulty.</p> <ul style="list-style-type: none"> ► At coolant temperatures below 248 °F (120 °C), continue driving to the next qualified specialist workshop. ► Avoid subjecting the engine to heavy loads, e.g. driving in mountainous terrain, and stop-start driving.
	<p>The battery is not being charged.</p> <p>Possible causes are:</p> <ul style="list-style-type: none"> • a faulty alternator • a torn poly-V-belt • a malfunction in the electronics <ul style="list-style-type: none"> ► Pull over and stop the vehicle safely and switch off the engine, paying attention to road and traffic conditions. ► Open the hood. ► Check whether the poly-V-belt is torn. <p>If the poly-V-belt is torn:</p> <p>! Do not continue driving. The engine could otherwise overheat.</p> <ul style="list-style-type: none"> ► Consult a qualified specialist workshop. <p>If the poly-V-belt is OK:</p> <ul style="list-style-type: none"> ► Visit a qualified specialist workshop.
 Check Engine Oil At Next Refueling Check Engine Oil at Next Refueling	<p>The engine oil level has dropped to a critical level.</p> <p>A warning tone also sounds.</p> <ul style="list-style-type: none"> ► Check the oil level (▷ page 233). ► If necessary, add the engine oil (▷ page 234). ► Have the engine checked for leaks if engine oil has to be added more often than usual.

Information on approved engine oils can be obtained from any qualified specialist workshop or on the Internet at <http://www.mbusa.com> (USA only).

! The oil level is too low. Avoid long journeys with too little engine oil. There is a risk of engine damage.

The display messages and the corresponding symbol that indicate that the oil level is too low must not be ignored.

Display messages	Possible causes/consequences and ► Solutions
	There is only a small amount of fuel in the fuel tank. ► Refuel at the nearest gas station.
 Fuel Level Low	The fuel level has dropped into the reserve range. ► Refuel at the nearest gas station.
 Gas Cap Loose	The fuel system pressure is too low. The fuel filler cap is not closed correctly or the fuel system is leaking. ► Check that the fuel filler cap is correctly closed. ► If the fuel filler cap is not correctly closed: close the fuel filler cap. ► If the fuel filler cap is closed: visit a qualified specialist workshop.

Driving systems

Display messages	Possible causes/consequences and ► Solutions
Cruise Control Inoperative	Cruise control is faulty. A warning tone also sounds. ► Visit a qualified specialist workshop.
Cruise Control --- mph	A condition for activating cruise control has not been met. You attempted to save a speed of less than 20 mph (30 km/h). ► If the situation allows, drive faster than 20 mph (30 km/h) and save the speed. ► Check the activation conditions for cruise control (► page 149).

Tires

Warning

Do not drive with a flat tire. A flat tire affects the ability to steer or brake the vehicle. You may lose control of the vehicle. Continued driving with a flat tire will cause excessive heat build-up and possibly a fire.





Warning



Follow recommended tire inflation pressures.

Do not underinflate tires. Underinflated tires wear excessively and/or unevenly, adversely affect handling and fuel economy, and are more likely to fail from being overheated.





Do not overinflate tires. Overinflated tires can adversely affect handling and ride comfort, wear unevenly, increase stopping distance, and result in sudden deflation (blowout) because they are more likely to become punctured or damaged by road debris, potholes etc.





Display messages	Possible causes/consequences and ► Solutions
Check Tire Pressure Soon	<p> Risk of accident</p> <p>The tire pressure loss warning system has detected a significant loss in pressure. A warning tone also sounds.</p> <ul style="list-style-type: none"> ► Stop the vehicle without making any sudden steering or braking maneuvers. Pay attention to the traffic conditions as you do so. ► Check the tires and, if necessary, change the wheel (> page 280). ► Check the tire pressures and, if necessary, set to the correct tire pressure. ► Restart the tire pressure loss warning system when the tire pressure is correct (> page 269).
Check Tire Pressure Then Restart Run Flat Indicator	<p>A display message from the tire pressure loss warning system was shown and the system has not been restarted since.</p> <ul style="list-style-type: none"> ► Set the correct tire pressure in all four tires. ► Restart the tire pressure loss warning system (> page 269).
Run Flat Indicator Inoperative	<p>The tire pressure loss warning system is faulty.</p> <ul style="list-style-type: none"> ► Visit a qualified specialist workshop.
Tire pressures will be displayed after driving a few minutes	<p>The tire pressure monitor is measuring the tire pressure.</p> <ul style="list-style-type: none"> ► Drive on. The tire pressures appear in the multifunction display after you have been driving for a few minutes.
Tire Press. Monitor Inoperative	<p>The TPMS is faulty.</p> <ul style="list-style-type: none"> ► Visit a qualified specialist workshop.
Tire Pressure Monitor Inoperative No Wheel Sensors	<p>The wheels mounted do not have a suitable tire pressure sensor. The tire pressure monitor is deactivated.</p> <ul style="list-style-type: none"> ► Mount wheels with suitable tire pressure sensors. The TPMS is activated automatically after driving for a few minutes.

Display messages	Possible causes/consequences and ► Solutions
Check Tires	<p> Risk of accident</p> <p>The tire pressure in one or more tires has dropped significantly. The wheel position is displayed in the multifunction display.</p> <ul style="list-style-type: none"> ► Stop the vehicle without making any sudden steering or braking maneuvers. Pay attention to the traffic conditions as you do so. ► Correct the tire pressure (▷ page 271). ► If necessary, change a wheel (▷ page 280).
Caution Tire Malfunction	<p> Risk of accident</p> <p>The tire pressure in one or more tires has dropped suddenly. The wheel position is displayed in the multifunction display.</p> <ul style="list-style-type: none"> ► Stop the vehicle without making any sudden steering or braking maneuvers. Pay attention to the traffic conditions as you do so. ► If necessary, change a wheel (▷ page 280).
Correct Tire Pressure	<p>The tire pressure is insufficient in at least one of the tires or the tire pressure difference between the wheels is too great.</p> <ul style="list-style-type: none"> ► Check the tire pressures at the next opportunity. If necessary, correct the tire pressure (▷ page 271). ► Restart the tire pressure monitor (▷ page 273).
Tire Press. Sensor(s)Missing	<p>There is no signal from the tire pressure sensor of one or several wheels. The pressure of the affected tire is not displayed in the multifunction display.</p> <ul style="list-style-type: none"> ► Have the faulty tire pressure sensor replaced at a qualified specialist workshop.
Tire Press. Monitor Currently Unavailable	<p>No signals are being received from the tire pressure sensors due to radio interference. The tire pressure monitor is temporarily malfunctioning.</p> <ul style="list-style-type: none"> ► Drive on. The TPMS restarts automatically as soon as the problem has been solved.
 <p>Tire Press. Warning Caution Tire Malfunction</p>	<p> Risk of accident</p> <p>The tire pressure in one or more tires has dropped suddenly.</p> <ul style="list-style-type: none"> ► Stop the vehicle without making any sudden steering or braking maneuvers. Pay attention to the traffic conditions as you do so. ► If necessary, change a wheel (▷ page 280).



Display messages	Possible causes/consequences and ► Solutions
 Check Tire Pressure	 Risk of accident The tire pressure in one or more tires has dropped significantly. <ul style="list-style-type: none"> ► Stop the vehicle without making any sudden steering or braking maneuvers. Pay attention to the traffic conditions as you do so. ► If necessary, change a wheel (▷ page 280). ► Check the tire pressure. If necessary, correct the tire pressure (▷ page 271).
 Correct Tire Pressure	The tire pressure is insufficient in at least one of the tires or the tire pressure difference between the wheels is too great. <ul style="list-style-type: none"> ► Check the tire pressures at the next opportunity. If necessary, correct the tire pressure (▷ page 271).





Vehicle



Display messages	Possible causes/consequences and ► Solutions
Shift to 'P' or 'N' to Start Engine	You have attempted to start the engine with the transmission in position R or D . <ul style="list-style-type: none"> ► Shift the transmission to position P or N.
P Shift to 'P'	You turned off the engine with the Start/Stop button and opened the driver's door while the transmission was in position N . or You have attempted to turn off the engine with the Start/Stop button while the transmission was in position R or D . <ul style="list-style-type: none"> ► Shift the transmission to position P.
	The tailgate is open. <ul style="list-style-type: none"> ► Close the tailgate.
	 Risk of accident The hood is open. <ul style="list-style-type: none"> ► Pull over and stop the vehicle safely as soon as possible, paying attention to road and traffic conditions. ► Engage the parking brake. ► Close the hood.
	At least one door is open. <ul style="list-style-type: none"> ► Close all doors.

Display messages	Possible causes/consequences and ► Solutions
 <p>Rear Lt. Backrest Not Latched or Rear Rt. Backrest Not Latched</p>	<p> Risk of injury</p> <p>The backrest in the rear is not engaged on the left-hand and/or right-hand side.</p> <p>► Push the backrest back until it engages.</p>
 <p>Power Steering Malfunction See Operator's Manual</p>	<p> Risk of accident</p> <p>The power steering assistance is faulty. You will need to use more force to steer.</p> <p>A warning tone also sounds.</p> <p>► Check whether you are able to apply the extra force required.</p> <p>► If you are able to steer safely: carefully drive on to a qualified specialist workshop.</p> <p>► If you are unable to steer safely: do not drive on. Contact the nearest qualified specialist workshop.</p>
<p>No Service</p>	<p>Your vehicle is outside the network provider transmitter/receiver range.</p> <p>► Wait until the mobile phone operational readiness symbol appears in the multifunction display.</p>
 <p>Check Washer Fluid</p>	<p>The washer fluid level in the washer fluid reservoir has dropped below the minimum.</p> <p>► Add washer fluid (► page 235).</p>

SmartKey





Display messages	Possible causes/consequences and ► Solutions
 <p>Key Does Not Belong to Vehicle</p>	<p>You have put the wrong SmartKey in the ignition lock.</p> <p>► Use the correct SmartKey.</p>
 <p>Take Your Key from Ignition</p>	<p>The SmartKey is in the ignition lock.</p> <p>► Remove the SmartKey.</p>
 <p>Obtain a new key</p>	<p>The SmartKey needs to be replaced.</p> <p>► Visit a qualified specialist workshop.</p>

Display messages	Possible causes/consequences and ► Solutions
 Replace Key Battery	The batteries of the KEYLESS-GO key are discharged. ► Change the batteries (▷ page 72).
 Don't Forget Your Key	The display message is displayed for a maximum of 60 seconds and is just a reminder. You have opened the driver's door with the engine switched off. The KEYLESS-GO key is not in the ignition lock. ► Take the KEYLESS-GO key with you when leaving the vehicle.
 Key Not Detected (red display message)	The KEYLESS-GO key is not in the vehicle. A warning tone also sounds. If the engine is switched off, you can no longer lock the vehicle centrally or start the engine. ► Pull over and stop the vehicle safely as soon as possible, paying attention to road and traffic conditions. ► Engage the parking brake. ► Locate the KEYLESS-GO key. The KEYLESS-GO key is not detected while the engine is running because there is interference from a strong source of radio waves. A warning tone also sounds. ► Pull over and stop the vehicle safely as soon as possible, paying attention to road and traffic conditions. ► Engage the parking brake. ► Operate the vehicle with the KEYLESS-GO key in the ignition lock if necessary.
 Key Not Detected (white display message)	The KEYLESS-GO key cannot be detected at present. ► Change the location of the key with the KEYLESS-GO functions in the vehicle. If the KEYLESS-GO key is still not detected: ► Change the location of the key with the KEYLESS-GO functions in the vehicle. ► Operate the vehicle with the KEYLESS-GO key in the ignition lock if necessary.
 Key Detected in Vehicle	The KEYLESS-GO key has been detected inside the vehicle during locking. ► Remove the KEYLESS-GO key from the vehicle.

Display messages	Possible causes/consequences and ► Solutions
 <p>Remove 'Start' Button and Insert Key</p>	<p>KEYLESS-GO is temporarily malfunctioning or is defective. A warning tone also sounds.</p> <ul style="list-style-type: none"> ► Insert the SmartKey into the ignition lock and turn it to the desired position. ► Visit a qualified specialist workshop.
 <p>Close Doors to Lock Vehicle</p>	<p>At least one door is open. A warning tone also sounds.</p> <ul style="list-style-type: none"> ► Close all doors and lock the vehicle again.

Warning and indicator lamps in the instrument cluster









Brakes





Problem	Possible causes/consequences and ► Solutions
 (USA only)  (Canada only) <p>The red brake system warning lamp comes on while the vehicle is moving. A warning tone also sounds.</p>	<p>You are driving with the parking brake engaged.</p> <ul style="list-style-type: none"> ► Release the parking brake. <p>The warning lamp goes out and the warning tone ceases.</p>
 (USA only)  (Canada only) <p>The red brake system warning lamp comes on while the engine is running. A warning tone also sounds.</p>	<p> Risk of accident</p> <p>There is insufficient brake fluid in the fluid reservoir.</p> <ul style="list-style-type: none"> ► Pull over and stop the vehicle safely as soon as possible, paying attention to road and traffic conditions. Do not continue driving under any circumstances. ► Engage the parking brake. ► Consult a qualified specialist workshop immediately. ► Observe the additional display messages in the multifunction display. <p>Do not add brake fluid. This will not rectify the problem.</p>







Warning









Driving with the brake warning lamp illuminated can result in an accident. Have your brake system checked immediately if the brake warning lamp stays on. Do not add brake fluid before checking the brake system.

Overfilling the brake fluid reservoir can result in spilling brake fluid on hot engine parts and the brake fluid catching fire. You can be seriously burned.

Seat belts	
Problem	Possible causes/consequences and ► Solutions
 <p>After starting the engine, the red seat belt warning lamp lights up for 6 seconds.</p>	<p>The seat belt warning lamp reminds the driver and front passenger to fasten their seat belts.</p> <p>► Fasten your seat belt (▷ page 50).</p>
 <p>After starting the engine, the red seat belt warning lamp lights up. In addition, a warning tone sounds for up to 6 seconds.</p>	<p> Risk of injury</p> <p>The driver's seat belt is not fastened.</p> <p>► Fasten your seat belt (▷ page 50). The warning tone ceases.</p>
 <p>The red seat belt warning lamp lights up after the engine starts, as soon as the driver's or the front-passenger door is closed.</p>	<p> Risk of injury</p> <p>The driver or front passenger has not fastened their seat belt.</p> <p>► Fasten your seat belt (▷ page 50). The warning lamp goes out.</p>
	<p> Risk of injury</p> <p>There are objects on the front-passenger seat.</p> <p>► Remove the objects from the front-passenger seat and stow them in a secure place. The warning lamp goes out.</p>
 <p>The red seat belt warning lamp flashes and an intermittent audible warning sounds.</p>	<p> Risk of injury</p> <p>The driver or front passenger has not fastened their seat belt. In addition, you are driving faster than 15 mph (25 km/h) or you have briefly driven faster than 15 mph (25 km/h).</p> <p>► Fasten your seat belt (▷ page 50). The warning lamp goes out and the intermittent audible warning ceases.</p>
	<p> Risk of injury</p> <p>There are objects on the front-passenger seat. In addition, you are driving faster than 15 mph (25 km/h) or you have briefly driven faster than 15 mph (25 km/h).</p> <p>► Remove the objects from the front-passenger seat and stow them in a secure place. The warning lamp goes out and the intermittent audible warning ceases.</p>

Safety systems	
Problem	Possible causes/consequences and ► Solutions
 <p>The yellow ABS warning lamp is lit while the engine is running.</p>	<p> Risk of accident</p> <p>ABS (Anti-lock Brake System) is deactivated due to a malfunction. Therefore, ESP® (Electronic Stability Program), BAS (Brake Assist), EBD (Electronic Brake force Distribution), hill start assist and ESP® trailer stabilization are also deactivated.</p> <p>The brake system continues to function normally, but without the functions listed above. The wheels could therefore lock if you brake hard, for example.</p> <ul style="list-style-type: none"> ► Observe the additional display messages in the multifunction display. ► Drive on carefully. ► Visit a qualified specialist workshop. <p>If the ABS control unit is faulty, there is also a possibility that other systems, such as the navigation system or AUTOTRONIC, will not be available.</p>
 <p>The yellow ABS warning lamp is lit while the engine is running.</p>	<p> Risk of accident</p> <p>ABS is temporarily unavailable. ESP®, BAS and EBD, for example, are therefore not available either.</p> <p>Self diagnosis is not yet complete.</p> <p>The brake system continues to function normally, but without the functions listed above. The wheels could therefore lock if you brake hard, for example.</p> <ul style="list-style-type: none"> ► Carefully drive a suitable distance making slight steering movements at a speed above 12 mph (20 km/h). The functions mentioned above are available again when the warning lamp goes out. <p>If the warning lamp is still on:</p> <ul style="list-style-type: none"> ► Observe the additional display messages in the multifunction display. ► Drive on carefully. ► Visit a qualified specialist workshop.

Problem	Possible causes/consequences and ► Solutions
 <p>The yellow ESP® and ESP® OFF warning lamps and the yellow ABS warning lamp are lit while the engine is running. A warning tone also sounds.</p>	<p> Risk of accident</p> <p>EBD is faulty. Therefore, ABS, BAS, hill start assist and ESP® trailer stabilization are not available either, due to a malfunction.</p> <p>The brake system continues to function normally, but without the functions listed above. The wheels could therefore lock if you brake hard, for example.</p> <ul style="list-style-type: none"> ► Observe the additional display messages in the multifunction display. ► Drive on carefully. ► Visit a qualified specialist workshop.
 <p>The yellow ESP® and ESP® OFF warning lamps and the yellow ABS warning lamp are lit while the engine is running.</p>	<p> Risk of accident</p> <p>ABS and ESP® are faulty. Therefore, BAS, hill start assist and ESP® trailer stabilization are not available either, due to a malfunction.</p> <p>The brake system continues to function normally, but without the functions listed above. The wheels could therefore lock if you brake hard, for example.</p> <ul style="list-style-type: none"> ► Observe the additional display messages in the multifunction display. ► Drive on carefully. ► Visit a qualified specialist workshop.
 <p>The yellow ESP® warning lamp flashes while the vehicle is in motion.</p>	<p> Risk of accident</p> <p>ESP® or traction control has intervened because there is a risk of skidding or at least one wheel has started to spin.</p> <p>Cruise control is deactivated.</p> <ul style="list-style-type: none"> ► Only depress the accelerator pedal as far as necessary when pulling away. ► Release the accelerator pedal while the vehicle is in motion. ► Adapt your driving style to suit the road and weather conditions. ► Do not deactivate ESP®. <p>Exceptions: (► page 63).</p>



Problem	Possible causes/consequences and ► Solutions
 <p>The yellow ESP® warning lamp flashes while the vehicle is in motion.</p>	<p>At least one wheel is spinning and ETS (Electronic Traction System) is deactivated to prevent the brakes on the drive wheels from overheating.</p> <ul style="list-style-type: none"> ► Observe the additional display messages in the multifunction display. <p>ETS switches back on again as soon as the brakes have cooled down.</p> <p>The display message disappears and the  warning lamp goes out.</p>
 <p>The yellow ESP® OFF warning lamp is lit while the engine is running.</p>	<p> Risk of accident</p> <p>ESP® and ESP® trailer stabilization are deactivated. ESP® will not stabilize the vehicle if it starts to skid or if a wheel starts to spin.</p> <ul style="list-style-type: none"> ► Reactivate ESP®. Exceptions: (► page 63). ► Adapt your driving style to suit the road and weather conditions. <p>If ESP® cannot be activated:</p> <ul style="list-style-type: none"> ► Have ESP® checked at a qualified specialist workshop.
  <p>The yellow ESP® and ESP® OFF warning lamps are lit while the engine is running.</p>	<p> Risk of accident</p> <p>ESP®, BAS, hill start assist and ESP® trailer stabilization are not available, due to a malfunction. ESP® will not stabilize the vehicle if it starts to skid or if a wheel starts to spin.</p> <p>The brake system continues to function normally, but without the functions listed above.</p> <ul style="list-style-type: none"> ► Observe the additional display messages in the multifunction display. ► Drive on carefully. ► Visit a qualified specialist workshop.
 <p>The red SRS warning lamp is lit while the engine is running.</p>	<p> Risk of injury</p> <p>The restraint systems are malfunctioning. The air bags or ETDs may either be triggered unintentionally or, in the event of an accident, not be triggered at all.</p> <ul style="list-style-type: none"> ► Drive on carefully. ► Visit a qualified specialist workshop immediately.



 **Warning**

In the event a malfunction of the SRS is indicated as outlined above, the SRS may not be operational.

For your safety, we strongly recommend that you contact an authorized Mercedes-Benz Center immediately to have the system checked. Otherwise the SRS may not be activated when needed in an accident, which could result in serious or fatal injury, or it might deploy unexpectedly and unnecessarily which could also result in injury.

Engine

Problem	Possible causes/consequences and ► Solutions
 <p>The yellow Check Engine warning lamp lights up while the engine is running.</p>	<p>There may be a malfunction, for example:</p> <ul style="list-style-type: none"> • in the engine management • in the fuel injection system • in the exhaust system • in the ignition system • the fuel system <p>The emission limit values may have been exceeded and the engine may be breaking in emergency mode.</p> <p>► Have the vehicle checked as soon as possible at a qualified specialist workshop.</p> <p>i In some states/provinces, you are required by law to visit a qualified specialist workshop as soon as the Check Engine warning lamp lights up. If necessary, check whether this is the case in the state/province you are in.</p>
 <p>The yellow reserve fuel warning lamp flashes while the engine is running.</p>	<p>The fuel system pressure is too low. The fuel filler cap is not closed correctly or the fuel system is leaking.</p> <p>► Check that the fuel filler cap is correctly closed.</p> <p>► If the fuel filler cap is not correctly closed: close the fuel filler cap.</p> <p>► If the fuel filler cap is closed: visit a qualified specialist workshop.</p>
 <p>The yellow reserve fuel warning lamp lights up while the engine is running.</p>	<p>The amount of fuel in the tank has dropped into the reserve range.</p> <p>► Refuel at the nearest gas station.</p>

Problem	Possible causes/consequences and ► Solutions
 <p>The red coolant warning lamp lights up while the engine is running and the coolant temperature gauge is at the start of the scale.</p>	<p>The temperature sensor for the coolant temperature gauge is faulty.</p> <p>The coolant temperature is no longer being monitored. There is a risk of engine damage if the coolant temperature is too high.</p> <ul style="list-style-type: none"> ► Pull over and stop the vehicle safely and switch off the engine, paying attention to road and traffic conditions. Do not continue driving under any circumstances. ► Engage the parking brake. ► Consult a qualified specialist workshop.
 <p>The red coolant warning lamp comes on while the engine is running.</p>	<p>The coolant level is too low.</p> <p>If the coolant level is correct, the airflow to the radiator may be blocked or the electric radiator fan may be malfunctioning.</p> <p>The coolant is too hot and the engine is no longer being cooled sufficiently.</p> <ul style="list-style-type: none"> ► Pull over and stop the vehicle safely and switch off the engine, paying attention to road and traffic conditions. ► Allow the engine and coolant to cool. ► Check the coolant level and add the coolant (► page 234). Observe the warning notes. ► If the coolant needs adding more often than usual, have the engine coolant system checked. ► Make sure that the air supply to the radiator is not blocked, e.g. by snow, slush or ice. ► At coolant temperatures below 248 °F (120 °C), continue driving to the next qualified specialist workshop. ► Avoid subjecting the engine to heavy loads, e.g. driving in mountainous terrain, and stop-start driving.
 <p>The red coolant warning lamp comes on while the engine is running. A warning tone also sounds.</p>	<p>The coolant has exceeded a temperature of 248 °F (120 °C). The airflow to the radiator may be blocked or the coolant level may be too low.</p> <p>The engine is not being cooled sufficiently and may be damaged.</p> <ul style="list-style-type: none"> ► Pull over and stop the vehicle safely and switch off the engine, paying attention to road and traffic conditions. ► Allow the engine and coolant to cool.

Warning



Driving when your engine is overheated can cause some fluids which may have leaked into the engine compartment to catch fire. You could be seriously burned.

Steam from an overheated engine can cause serious burns which can occur just by opening the engine hood. Stay away from the engine if you see or hear steam coming from it.

Stop the vehicle in a safe location away from other traffic. Turn off the engine, get out of the vehicle and do not stand near the vehicle until the engine has cooled down.

- !** If the coolant temperature exceeds 248 °F (120 °C) do not continue driving. The engine will otherwise be damaged.

Tires

Problem	Possible causes/consequences and ► Solutions
 <p>USA only: The yellow combination low tire pressure warning lamp/TPMS malfunction warning lamp is lit.</p>	<p> Risk of accident</p> <p>The tire pressure monitor has detected a loss of pressure in at least one of the tires.</p> <ul style="list-style-type: none"> ► Stop the vehicle without making any sudden steering or braking maneuvers. Pay attention to the traffic conditions as you do so. ► Observe the additional display messages in the multifunction display. ► Check the tire pressure. If necessary, correct the tire pressure (► page 271). ► If necessary, change a wheel (► page 280).
 <p>USA only: The yellow combination low tire pressure warning lamp/TPMS malfunction warning lamp flashes for sixty seconds and then remains lit.</p>	<p>The tire pressure monitor is faulty.</p> <ul style="list-style-type: none"> ► Observe the additional display messages in the multifunction display. ► Visit a qualified specialist workshop.

Warning

Each tire, including the spare (if provided), should be checked every other week when cold and inflated to the inflation pressure recommended by the vehicle manufacturer on the Tire and Loading Information placard on the driver's door B-pillar or, if available, the tire inflation pressure label on the inside of the fuel filler flap. If your vehicle has tires of a different size than the size indicated on the Tire and Loading Information placard or, if available, the tire inflation pressure label, you should determine the proper tire inflation pressure for those tires.

As an added safety feature, your vehicle has been equipped with a tire pressure monitoring system (TPMS) that illuminates a low tire pressure warning lamp when one or more of your tires are significantly underinflated. Accordingly, when the low tire pressure warning lamp illuminates, you should stop and check your tires as soon as possible, and inflate them to the proper pressure. Driving on a significantly underinflated tire causes the tire to overheat and can lead to tire failure.

Underinflation also reduces fuel efficiency and tire tread life, and may affect the vehicle's handling and stopping ability. Please note that the TPMS is not a substitute for proper tire maintenance, and it is the driver's responsibility to maintain correct tire pressure, even if underinflation has not reached the level to trigger illumination of the TPMS low tire pressure warning lamp.

Your vehicle has also been equipped with a TPMS malfunction indicator to indicate when the system is not operating properly. The TPMS malfunction indicator is combined with the low tire pressure warning lamp. When the system detects a malfunction, the warning lamp will flash for approximately one minute and then remain continuously illuminated. This sequence will continue upon subsequent vehicle start-ups as long as the malfunction exists. When the malfunction indicator is lit, the system may not be able to detect or signal low tire pressure as intended.

TPMS malfunctions may occur for a variety of reasons, including the installation of incompatible replacement or alternate tires or wheels on the vehicle that prevent the TPMS from functioning properly. Always check the TPMS malfunction warning lamp after replacing one or more tires or wheels on your vehicle to ensure that the replacement or alternate tires and wheels allow the TPMS to continue to function properly.

Vehicle equipment	206
Loading guidelines	206
Stowage compartments	206
Stowage areas	208
Features	214

Vehicle equipment

i This manual describes all the standard and optional equipment of your vehicle which was available at the time of purchase. Country-specific differences are possible. Bear in mind that your vehicle may not feature all functions described here. This also refers to safety-related systems and functions.

Loading guidelines

Warning!

Always fasten items being carried as securely as possible using cargo tie-down rings and fastening materials appropriate for the weight and size of the load.

In an accident, during hard braking or sudden maneuvers, loose items will be thrown around inside the vehicle. This can cause injury to vehicle occupants unless the items are securely fastened in the vehicle.

To help avoid personal injury during a collision or sudden maneuver, exercise care when transporting cargo. Do not pile luggage or cargo higher than the seat backrests.

Never drive a vehicle with the tailgate open. Deadly carbon monoxide (CO) gases may enter vehicle interior resulting in unconsciousness and death.

The gross vehicle weight (GVW) is the weight of the vehicle including fuel, the vehicle tool kit, spare tire, any installed accessories, vehicle occupants and luggage/cargo.

The load limit and the gross vehicle weight rating (GVWR) of your vehicle must never be exceeded. The load limit and the GVWR are stated on the vehicle identification plate on the B-pillar on the driver's side (▷ page 274).

Additionally, the cargo must be distributed so that the weight on each axle never exceeds the maximum gross axle weight rating

(GAWR) for the front and rear axles. The data on GVWR and GAWR is stated on the vehicle identification plate on the B-pillar on the driver's side (▷ page 274).

Further information can be found in the "Loading the vehicle" section (▷ page 274). The handling characteristics of a laden vehicle are dependent on the distribution of the load within the vehicle. For this reason, you should observe the following notes when transporting a load:

- Position heavy loads as far forwards as possible and as low down in the cargo compartment as possible.
- The load must not protrude above the upper edge of the seat backrests.
- always place the load against the rear or front seat backrests. Make sure that the seat backrests are securely locked into place.
- Hook in the cargo net when loading.
- Always place the load behind unoccupied seats if possible.
- Secure the load with sufficiently strong and wear-resistant tie down. Pad sharp edges for protection.

Stowage compartments

Important safety notes

Warning!

To help avoid personal injury during a collision or sudden maneuver, exercise care when storing objects in the vehicle. Put luggage or cargo in the cargo compartment if possible. Do not pile luggage or cargo higher than the seat backrests.

Keep compartment lids closed. This will help to prevent stored objects from being thrown about and injuring vehicle occupants during

- braking
- vehicle maneuvers
- an accident

Stowage compartments in the front

Glove box

i Depending on the vehicle equipment, there is an AUX-IN connection or a Media Interface installed in the glove box. Media Interface is a universal interface for mobile audio equipment, e.g. for an iPod® or USB devices; see separate COMAND operating instructions.

i The glove box can be ventilated (▷ page 125).



▶ **To open:** pull handle ① and open glove box flap ②.

▶ **To close:** fold glove box flap ② upwards until it engages.

The glove box can only be locked and unlocked using the mechanical key.

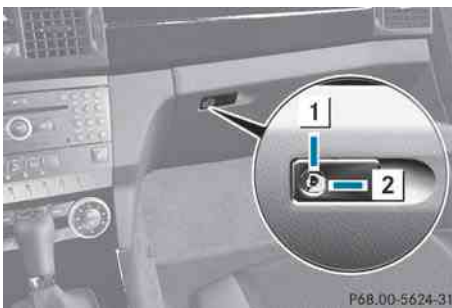

▶ **To lock:** insert the mechanical key into the lock and turn it 90° clockwise to position ②.

▶ **To unlock:** insert the mechanical key into the lock and turn it 90° counter-clockwise to position ①.

Stowage compartment under the armrest

i A small and a large stowage compartment are located under the armrest. The small stowage compartment can be removed for emptying.

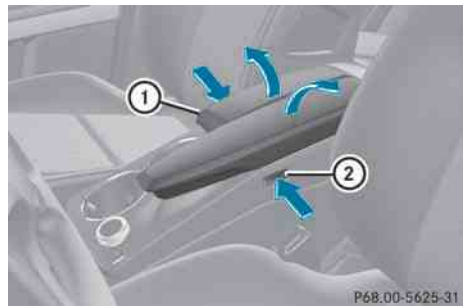

▶ **To open:** press left-hand button ② or right-hand button ①.

The stowage compartment opens.

Stowage compartments in the rear

Stowage pockets

⚠ Warning!

Storage bags are intended for storing light-weight items only.

Heavy objects, objects with sharp edges or fragile objects may not be transported in the storage bag. In an accident, during hard braking, or sudden maneuvers, they could be thrown around inside the vehicle and cause injury to vehicle occupants.

Storage bags cannot protect transported goods in the event of an accident.

Storage bags are located in the rear compartment on the driver's and front-passenger seat backrests.

Stowage areas

Parcel nets

Warning!

Parcel nets are intended for storing light-weight items only, such as road maps, mail, etc.

Heavy objects, objects with sharp edges, or fragile objects may not be transported in the parcel nets. In an accident, during hard braking, or sudden maneuvers, they could be thrown around inside the vehicle and cause injury to vehicle occupants.

Parcel nets cannot protect transported goods in the event of an accident.

Parcel nets are located in the front-passenger footwell and on the left-hand side of the cargo compartment.

Enlarging the luggage compartment

Important safety notes

Warning!

Always lock the seat backrest in its upright position when the rear seat bench is occupied, or the extended cargo volume is not in use.

Check for secure locking by pushing and pulling on the seat backrest.

In an accident, during hard braking or sudden maneuvers, loose items will be thrown around inside the vehicle. This can cause injury to vehicle occupants unless the items are securely fastened in the vehicle.

To help avoid personal injury during a collision or sudden maneuver, exercise care when transporting cargo.

Warning!

Never drive a vehicle with the tailgate open. Deadly carbon monoxide (CO) gases may enter vehicle interior resulting in unconsciousness and death.

The left-hand and right-hand rear seat backrests can be folded forwards separately to increase the cargo compartment capacity.

Folding the rear seat backrest forward

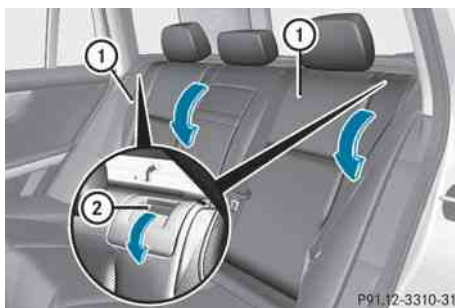

- ▶ Fully insert the backrest head restraints (▷ page 93).
- ▶ Move the driver's or front-passenger seat forward if necessary.
- ▶ Pull left-hand or right-hand release handle ② of the seat backrest forwards. Corresponding seat backrest ① is released.
- ▶ Fold seat backrest ① forwards.
- ▶ Move the driver's or front-passenger seat back if necessary.

Folding the rear seat backrest back

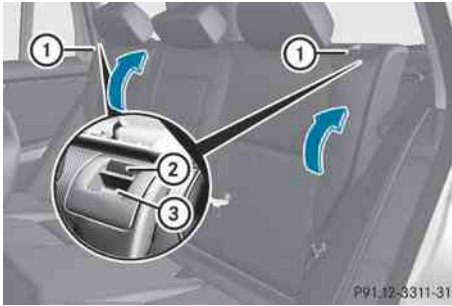

- ① Backrest
- ② Lock verification indicator
- ③ Backrest release handle

► Move the driver's or front-passenger seat forward if necessary.

! Make sure that the seat belt does not become trapped when folding the rear seat backrest back. Otherwise, it could be damaged.

► Fold seat backrest ① back until it engages. Red lock verification indicator ② is no longer visible.

Warning!

If a red indicator is visible with the seat backrest up, then the seat backrest is not properly locked into position.

Always lock seat backrest in its upright position when rear seat bench is occupied, or the expanded cargo volume is not in use.

Check for secure locking by pushing and pulling on the seat backrest.

In an accident, during hard braking or sudden maneuvers, loose items will be thrown around inside the vehicle. This can cause injury to vehicle occupants unless the items are securely fastened in the vehicle.

To help avoid personal injury during a collision or sudden maneuver, exercise care when transporting cargo.

- Adjust the head restraints if necessary (▷ page 93).
- Move the driver's or front-passenger seat back if necessary.

Securing cargos

Lashing eyelets

Observe the following notes on securing loads:

- secure the load using the cargo tie down rings.
- do not use elastic straps or nets to secure a load, as these are only intended as an anti-slip protection for light loads.
- do not route tie downs across sharp edges or corners.
- pad sharp edges for protection.

There are four cargo tie down rings in the cargo compartment and two cargo tie down rings in the rear footwells²⁴.



- ① Cargo tie down rings in the cargo compartment

²⁴ Canada only.

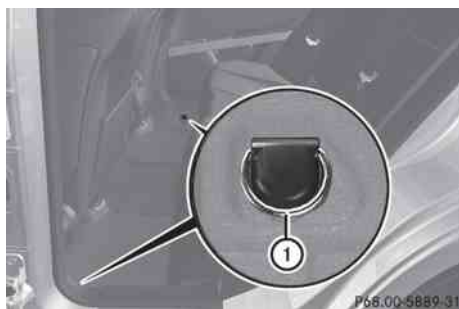

- ① Cargo tie down rings in the rear footwells (Canada only)

Bag hooks

! The bag hook can bear a maximum load of 11 lbs (5 kg). Do not use it to secure a load.

There is one bag hook on the left side wall in the cargo compartment and there are two hooks on the right and left of the lower D-pillar trim.

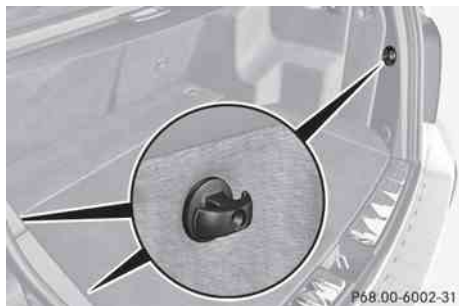

Luggage compartment cover

Important safety notes

! When loading the vehicle, make sure that you do not stack the load in the cargo compartment higher than the lower edge of the side windows. Do not place heavy objects on top of the cargo compartment cover.

The cargo compartment cover is located behind the rear bench seat backrest.

- i** You can fold up the solid section of the cargo compartment cover approximately 45° to facilitate loading the cargo compartment.

Extending/retracting the luggage compartment cover



- ▶ **To extend:** pull cargo compartment cover ① back and clip it into the retainers on the left and right.
- ▶ **To retract:** unhook cargo compartment cover ① from the retainers on the left and right and guide it forwards by the grab handle until it is fully retracted.

Removing/installing the luggage compartment cover



- ▶ **To remove:** make sure that cargo compartment cover ① is rolled up.
- ▶ Press handle ② on the right underside to the left.
- ▶ Remove cargo compartment cover ①.

- ▶ **To install:** attach cargo compartment cover ① to the opening on the left-hand side.
- ▶ Press handle ② to the right.
- ▶ Allow cargo compartment cover ① to engage in the appropriate recess.

Cargo net

Important safety notes

Warning!

Make sure the cargo net is properly engaged at top and bottom position and the tightening belts are securely fastened.

Never use a damaged cargo net.

Always use cargo net when transporting cargo. This helps to avoid personal injury from smaller objects being thrown around in the occupant compartment during a collision or sudden maneuver.

The cargo net cannot prevent the movement of large, heavier objects into the passenger compartment in an accident. Such items must be properly secured using the cargo tie-down rings in the cargo compartment floor.

Passenger use of seats behind installed cargo net is restricted because of the footwell being taken up by the net.

When the vehicle is loaded with objects that extend beyond the seat backrests, using a cargo net is particularly important. For reasons of safety, a cargo net should always be used when transporting cargo.

Preparing the cargo net

The cargo net can be used in two different positions (behind the B-pillar or the C-pillar).



- The brackets behind B-pillar ① are required for the cargo compartment enlargement (▷ page 208).
The corresponding cargo tie down rings to tighten the net are located in the footwell of the rear bench seat (▷ page 209).
- The brackets behind C-pillar ② are required for the cargo compartment behind the rear bench seat.
The corresponding cargo tie down rings to tension the net are located in the cargo compartment (▷ page 209).

The cargo net is located in the loading tray in the stowage well under the trunk floor (▷ page 212).

- ▶ Open both Velcro fasteners and remove the cargo net.
- ▶ Unroll and unfold the cargo net.
The upper and lower guide rods must engage audibly.

Attaching the cargo net



Cargo net attached behind the C-pillar

- ▶ Insert guide rod ② into retainer ① in the direction of the arrow.
- ▶ Slide guide rod ② forwards into retainer ① in the direction of the arrow.

Tightening the cargo net

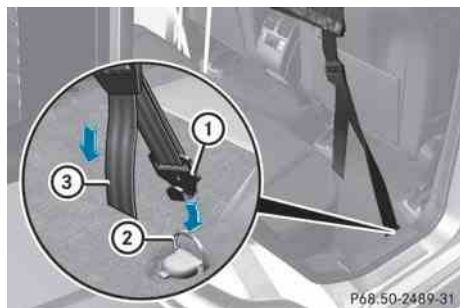

Seat belt reel holder behind the front seats

- ▶ Insert belt hook ① into cargo tie-down ring ② in the direction of the arrow.
- ▶ Pull tensioning strap ③ by the loose end in the direction of the arrow until the cargo net is tight.
- ▶ After driving a short distance, check the tension of the cargo net and retighten it if necessary.

Releasing the cargo net

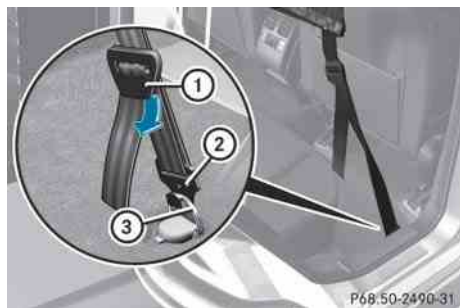

Seat belt reel holder behind the front seats

- ▶ Pull belt adjuster ① upwards in the direction of the arrow to reduce the tension on the tensioning strap.
- ▶ Unhook belt hook ② from cargo tie-down ring ③.

Detaching and storing the cargo net

- ▶ Detach guide rod ② from bracket ① (▷ page 211).
- ▶ Press the red button on the upper and lower guide rods.
- ▶ Fold the cargo net and roll it up.
- ▶ Close the two Velcro fasteners on the cargo net holder.

Coat hooks on the tailgate

⚠ Warning!

The tailgate may close if too great a load is placed on the coat hooks.

You and/or others could be trapped and injured.

Only use the coat hooks for light clothing.



- ① Coat hooks

Stowage well under the cargo compartment floor

⚠ Warning!

If items are stored in the compartment, make sure compartment is securely closed.

In an accident, during hard braking or sudden maneuvers, they could be thrown around inside the vehicle, and cause injury to vehicle occupants.

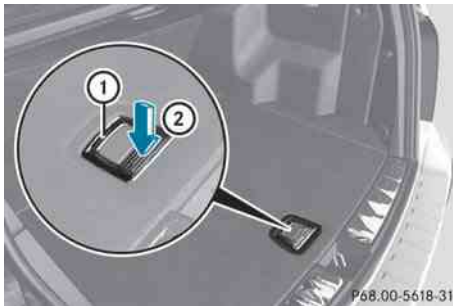

- ▶ **To open:** open the tailgate.
- ▶ Holding the ribbing, press handle ① downwards ②. Handle ① folds upwards.
- ▶ Swing the trunk floor upwards using handle ① until it rests against the cargo compartment cover.



- ▶ Release hook ③ from the bracket on the underside of the trunk floor.

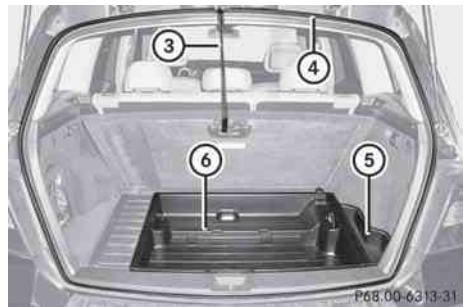

- ▶ Engage hook ③ into rain trough ④.
- ▶ **i** Stowage compartments ⑤ and ⑥ can be used to stow small, light and flat objects.
- ▶ **!** Before you close the tailgate, unhook the hook from the rain trough and fold the trunk floor down.
- ▶ **To close:** unhook hook ③ from rain trough ④.
- ▶ Fasten the hook to the bracket on the underside of the trunk floor
- ▶ Fold the trunk floor down.
- ▶ Press the trunk floor down ② until it engages.

Roof carrier

Important safety notes

⚠ Warning!

Only use roof racks approved by Mercedes-Benz for your vehicle model to avoid damage to the vehicle.

Follow the manufacturer's installation instructions. Otherwise, an improperly attached roof rack system or its load could become detached from the vehicle.

Do not exceed the maximum roof load of 165 lb (75 kg).

Take into consideration that when the roof rack is loaded, the handling characteristics are different from those when operating the vehicle without the roof rack loaded.

! Mercedes-Benz recommends that you only use roof carriers that have been tested and approved for Mercedes-Benz vehicles. This helps to prevent damage to the vehicle.

Position the cargo on the roof rack in such a way that the vehicle will not sustain damage even when it is in motion.

Ensure that, depending on the vehicle's equipment, you can raise the panorama roof with power tilt/sliding panel fully and open the tailgate fully when the roof carrier is installed.

Fastening the roof carrier

- ▶ Secure the roof carrier to the roof rails.
- ▶ Observe the manufacturer's installation instructions.

Features

Cup holder

Points to observe before use

Warning

In order to help prevent spilling liquids on vehicle occupants and/or vehicle equipment, only use containers that fit into the cup holder. Use lids on open containers and do not fill containers to a height where the contents, especially hot liquids, could spill during braking, vehicle maneuvers, or in an accident. Liquids spilled on vehicle occupants may cause serious personal injury. Liquids spilled on vehicle equipment may cause damage not covered by the Mercedes-Benz Limited Warranty.

When not in use, keep the cup holder closed. An open cup holder may cause injury to you or others when contacted during braking, vehicle maneuvers, or in an accident.

Keep in mind that objects placed in the cup holder may come loose during braking, vehicle maneuvers, or in an accident and be thrown around in the vehicle interior. Objects

thrown around in the vehicle interior may cause an accident and/or serious personal injury.

Cup holder in the center console



P68.00-5725-31

Cup holder in the rear seat armrest

! Do not sit or lean your bodyweight on the armrests when they are folded out as you could damage them.

! Only fold the armrests up when the cup holder is closed. The cup holder may otherwise be damaged.

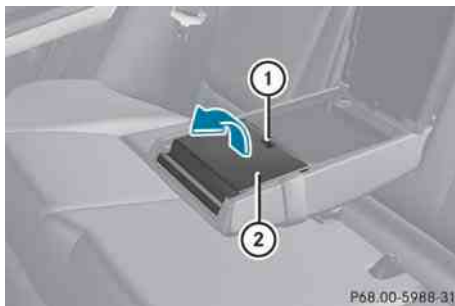

P68.00-5988-31

- ▶ **To open:** raise the armrest cover.
- ▶ Press release catch ①.
Cup holder ② folds out forwards.
- ▶ Swing the armrest cover back down, if necessary.
- ▶ **To close:** raise the armrest cover.
- ▶ Swing cup holder ② back until it engages.
- ▶ Swing the armrest cover back down, if necessary.

Sun visors

Overview of the sun visor

Warning

Do not use the vanity mirror while driving. Keep the vanity mirrors in the sun visors closed while the vehicle is in motion. Reflected glare can endanger you and others.



- ① Mirror light
- ② Bracket
- ③ Retaining clip, e.g. for a car park ticket
- ④ Vanity mirror
- ⑤ Mirror cover

Vanity mirror in the sun visor

Mirror light ① only functions if the sun visor is clipped into retainer ② and mirror cover ⑤ has been folded up.

Glare from the side

- ▶ Fold down the sun visor.
- ▶ Pull the sun visor out of retainer ②.
- ▶ Swing the sun visor to the side.

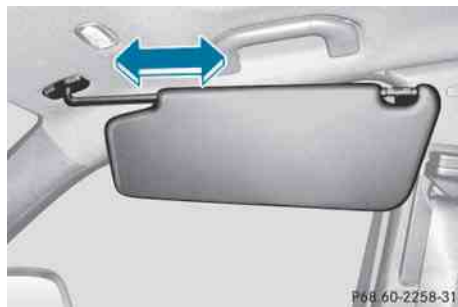

- ▶ Pull or push the sun visor in the direction of the arrow.

Ashtray

Ashtray in the cockpit

- ❗ There is a stowage space under the ashtray.

- ⚠ The stowage space under the ashtray is not heat resistant. Before placing lit cigarettes in the ashtray, make sure that the ashtray is properly engaged. Otherwise, the stowage space could be damaged.

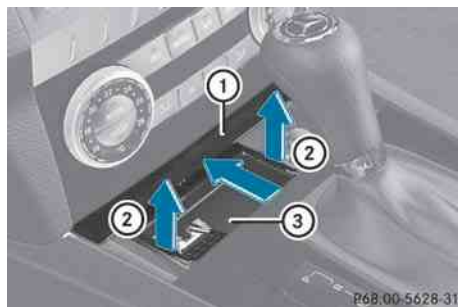

- ▶ **To open:** slide cover ① forwards until it engages.
- ▶ **To remove the insert:** hold insert ③ by the ribbing at the sides and lift it up and out ②.

- ▶ **To refit the insert:** press insert ③ into the holder until it engages.
- ▶ **To close:** press cover ① briefly at the front.
The cover moves back.

Ashtray in the rear compartment

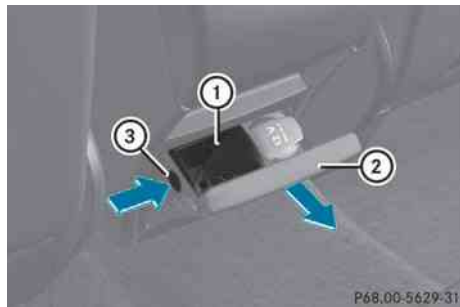

- ▶ **To open:** pull cover ② out by its top edge.
- ▶ **To remove the insert:** press release button ③ and lift the insert up and out.
- ▶ **To re-insert the insert:** replace insert ① from above.
- ▶ Press insert ① into the holder until it engages.

Cigarette lighter

⚠ Warning

When leaving the vehicle, always remove the SmartKey from the ignition lock. Always take the SmartKey with you and lock the vehicle. Do not leave children unattended in the vehicle, even if they are secured in a child restraint system, or with access to an unlocked vehicle. A child's unsupervised access to a vehicle could result in an accident and/or serious personal injury. The children could:

- injure themselves on parts of the vehicle
- be seriously or fatally injured through excessive exposure to extreme heat or cold
- injure themselves or cause an accident with vehicle equipment that can be operated

even if the SmartKey is removed from the ignition lock or removed from the vehicle, such as seat adjustment, steering wheel adjustment, or the memory function

If children open a door, they could injure other persons or get out of the vehicle and injure themselves or be injured by following traffic.

Do not expose the child restraint system to direct sunlight. The child restraint system's metal parts, for example, could become very hot, and the child could be burned on these parts.

⚠ Warning

Never touch the heating element or sides of the lighter; they are extremely hot. Hold the knob only.

Make sure any children traveling with you do not injure themselves or start a fire with the hot cigarette lighter.

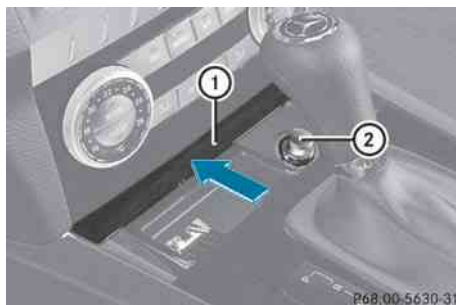

Center console, front

- ▶ Turn the key to position 2 in the ignition lock.
- ▶ Slide cover ① forwards until it engages.
- ▶ Press in cigarette lighter ②.
Cigarette lighter ② will pop out automatically when the heating element is red-hot.

12 V sockets

Points to observe before use

! If you are using all sockets in the vehicle, make sure that you do not exceed the maximum current draw of 55 A. Otherwise, you will overload the fuses.

The socket can be used for accessories with a maximum power consumption of 180 W, e.g. lamps or chargers for mobile phones. If you use the socket for long periods when the engine is switched off, the battery may discharge.

Dashboard socket

The socket is installed in vehicles with audio equipment or COMAND.

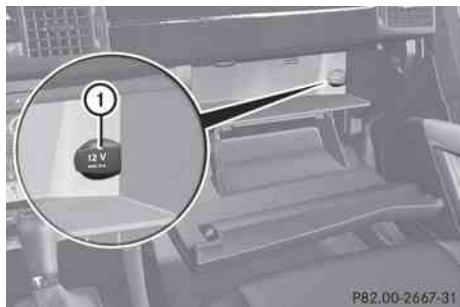

- ▶ Open the glove box (> page 207).
- ▶ Lift up the cover of socket ①.

An additional socket is installed in the center console on vehicles without an ashtray with cigarette lighter.

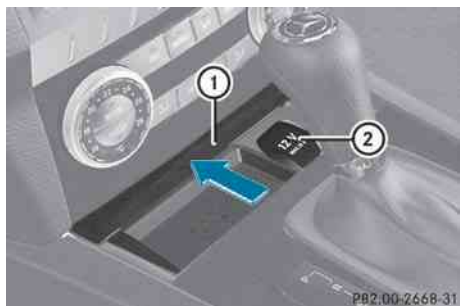

- ▶ **To open:** slide cover ① forwards until it engages.
- ▶ Lift up the cover of socket ②.
- ▶ **To close:** press cover ① briefly at the front. The cover moves back.

Socket in the rear compartment

A socket is installed in the center console in the rear compartment in vehicles with an ashtray and a cigarette lighter.

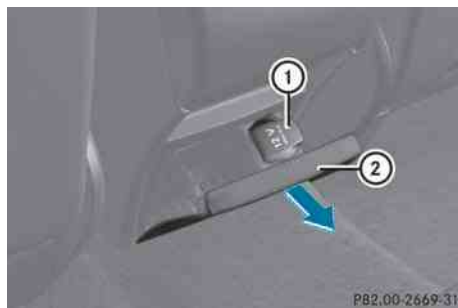

- ▶ Pull cover ② out by its top edge.
- ▶ Lift up the cover of socket ①.

Socket in the cargo compartment

The socket is located in the cargo compartment on the left-hand side trim.

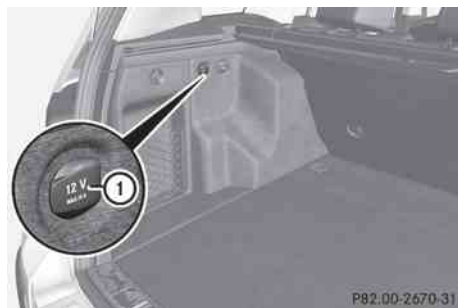

- ▶ Lift up the cover of socket ①.

115 V socket

⚠ Warning!

The 115V AC socket operates at high voltage. Use the 115V AC socket in the vehicle with the same caution and prudence that you exercise when using power outlets at home. Keep any fluids away from the 115V AC socket. Do not clean the socket with fluids or tapered objects. Keep the 115V AC socket cover in the closed position, when not in use. Otherwise, you could suffer an electric shock and be seriously or even fatally injured.

⚠ Warning!

A device that you connect must have a suitable plug that complies with U.S. standards. Never pull on the cable to unplug a plug from the 115V AC socket. Do not use a damaged connection cable. The 115V AC socket may not be connected to another 115V AC power source. Do not use converters to a grounding plug with the 115V AC socket. This could cause serious personal injury to you and/or others.

⚠ Warning!

If the 115V AC socket is damaged or torn out of the trim, do not use or touch the 115V AC socket. Using a 115V AC socket that is damaged or torn out of the trim could cause serious personal injury to you and/or others.



The 115 V AC power socket ① provides an alternating voltage of 115 V, so that small electronic devices can be connected. These

devices, such as games consoles, chargers and laptops, should not consume more than a maximum of 150 W altogether.

Requirements for operation of these devices:

- 12 V power sockets in the footwell of the second row of seats and in the stowage compartment must be functioning correctly (▷ page 217).
 - the plug of the electronic device is plugged into the 115 V power socket ①.
 - the on-board voltage is within a permissible voltage range.
 - the maximum wattage of the device to be connected must not exceed 150 W.
- ▶ Open flap ③.
- ▶ Switch the ignition on.
- ▶ Insert the plug of the electrical device into the 115 V power socket ①. Indicator lamp ② lights up.

If indicator lamp ② does not light up, please read the chapter on malfunctions.

- ▶ **To turn off:** disconnect the plug from the 115 V power socket ①.

Ensure that you do not pull on the cord.

- ▶ Close flap ③.

Possible causes of malfunction:

- the on-board voltage of the vehicle is not within the permissible voltage range.
- the temperature of the DC/AC converter is momentarily too high.
- some small electronic devices have a constant nominal power of less than 150 W, but a very high inrush current. These devices will not work. If you connect such a device, the 115 V power socket ① will not supply it with power.

If indicator lamp ② still does not light up, consult a specialist workshop, e.g. an authorized Mercedes-Benz Center.

mbrace²⁵**Important safety notes**

! A license agreement must exist in order to activate the mbrace service. Make sure that your system is activated and ready for use, and press the  MB info call button to register. If you cannot carry out any of the steps mentioned, the system may not be activated.

If you have any questions concerning activation, please contact one of the following service hotlines:

- **USA:** Response Center under 866-990-9007
- **Canada:** Customer Service under 1-888-923-8367

Shortly after successfully registering with the mbrace service, a user ID and password will be sent to you by post. You can use this password to log in to the mbrace section under "Owners Online" at <http://www.mbusa.com>²⁶.

The mbrace system is available if:



- it has been activated and is operational. Activation requires an available cellular phone network, a valid SIM card and a service subscription to a surveillance service provider.
 - the battery is sufficiently charged.
 - the corresponding cellular phone network is available for transmitting data to the customer center.
- i** Determining the location of the vehicle on a map is only possible if there is sufficient GPS reception and the vehicle position can be forwarded to the customer center.

The mbrace system

The mbrace system provides three different services:

- automatic and manual emergency call
- Roadside Assistance call
- MB info call

To control the volume during an mbrace call, proceed as follows:

▶ Press the  or  button on the multifunction steering wheel.

or

▶ Use the volume controller of the audio system.





You can find information and a description of all available features under "Owners Online" at <http://www.mbusa.com>²⁷

System self-test

After you have switched on the ignition, the system carries out a self-diagnosis.

 Warning

A malfunction in the system has been detected if any or all of the following conditions occur:

- The indicator lamp in the SOS button does not come on during the system self-test.
- The indicator lamp in Roadside Assistance button  does not come on during the system self-test.
- The indicator lamp in Information button  does not come on during the system self-test.
- The indicator lamp in the SOS button, Roadside Assistance button , or Information button  remains illuminated constantly in red after the system self-test.
- The message Tele Aid Inoperative or Tele Aid Not Activated appears in the

²⁵ The system is called TELEAID in Canada.

²⁶ USA only.

²⁷ USA only.

multifunction display after the system self-test.

If a malfunction is indicated as outlined above, the system may not operate as expected. In case of an emergency, help will have to be summoned by other means.

Have the system checked at the nearest authorized Mercedes-Benz Center or contact the following service hotlines:

- **USA:** Response Center under the number 866-990-9007
- **Canada:** Customer Service under 1-888-923-8367.

Emergency call

Important safety notes

! A license agreement must exist in order to activate the mbrace service. Make sure that your system is activated and ready for use, and press the  MB info call button to register. If you cannot carry out any of the steps mentioned, the system may not be activated.

If you have any questions concerning activation, please contact one of the following service hotlines:

- **USA:** Response Center under 866-990-9007
- **Canada:** Customer Service under 1-888-923-8367

An emergency call is dialed automatically if an air bag or Emergency Tensioning Device is triggered.

i An automatically dialed mbrace emergency call cannot be canceled.

An emergency call can also be dialed manually.

Once the emergency call is in progress, the indicator lamp in the SOS button flashes. The Connecting Call message appears in the multifunction display.

COMAND is muted.

Once a connection has been established, the Call Connected message appears in the multifunction display.

All important information on the emergency is compiled, for example:

- current location of the vehicle (as determined by the GPS system)
- vehicle model
- vehicle color
- vehicle identification number

A voice connection between the Response Center and the occupants of the vehicle will be established automatically soon after the emergency call has been initiated. If the vehicle occupants are able to respond, the Response Center will attempt to obtain more detailed information on the emergency.

i If no vehicle occupant answers, an ambulance is immediately sent to the vehicle.

Warning

If the indicator lamp in the SOS button is flashing continuously and there was no voice connection to the Response Center established, then the mbrace system could not initiate an emergency call (e.g. the relevant cellular phone network is not available).

The message Call Failed appears in the multifunction display for approximately 10 seconds.

Should this occur, assistance must be summoned by other means.

Making an emergency call

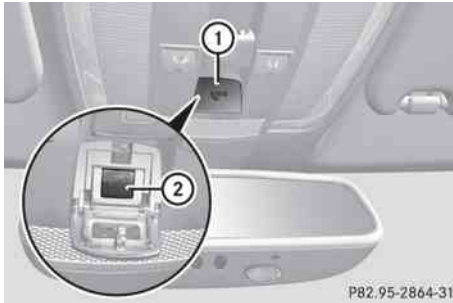

- ▶ **To initiate an emergency call manually:** press cover ① briefly to open.
- ▶ Press SOS button ② briefly. The indicator lamp in SOS button ② flashes until the emergency call is ended.
- ▶ Wait for the voice connection with the Response Center.
- ▶ After the emergency call is ended, close cover ①.

Warning

If you feel at any way in jeopardy when in the vehicle (e.g. smoke or fire in the vehicle, vehicle in a dangerous road location), please do not wait for voice contact after you have pressed the SOS button. Carefully leave the vehicle and move to a safe location. The Response Center will automatically contact local emergency officials with the vehicle's approximate location if they receive an automatic SOS signal and cannot make voice contact with the vehicle occupants.

Roadside Assistance call button



- ▶ Press and hold Roadside Assistance button ① for more than two seconds. A call to a Mercedes-Benz Roadside Assistance Representative is initiated. The indicator lamp in Roadside Assistance button ① flashes while the call is active. The Connecting Call message appears in the multifunction display and the audio system or COMAND is muted.

If a connection can be established, the Call Connected message appears in the multifunction display.

If a mobile phone network is available and there is sufficient GPS reception, the mbrace system transmits data to the Response Center, for example:

- current location of the vehicle
- vehicle identification number
- vehicle model
- vehicle color

- ▶ **i** The audio system or COMAND display shows that an mbrace call is active. You can switch to the navigation menu by pressing the NAVI button on COMAND during the call. Spoken commands are not available.

A voice connection is established between the Mercedes-Benz Roadside Assistance Representative and the vehicle occupants.

- ▶ Describe the type of assistance needed.

The Mercedes-Benz Roadside Assistance Representative either sends a qualified Mercedes-Benz technician or organizes for

your vehicle to be transported to the nearest authorized Mercedes-Benz Center. You may be charged for services such as repair work and/or towing. Further details are available in your mbrace manual.

- i If the indicator lamp in MB info call button 1 flashes continuously and it was not possible to establish a voice connection to the Response Center, then the mbrace system has failed to initiate a Roadside Assistance call (e.g. the corresponding cellular phone network is not available). The **Call Failed** message appears in the multifunction display.

► **To end a call:** press the  button on the multifunction steering wheel.

or

► Press the corresponding button for ending a phone call on the audio system or on COMAND.

- i Sign and Drive services²⁸: you are not charged for services such as jump-starting, providing a few gallons of fuel for a fuel tank that has been run dry or changing a flat tire with the vehicle's own spare tire.

MB Info call button



- Press and hold MB info call button 1 for more than two seconds.
 A call to the Response Center is initiated.
 MB info call button indicator lamp 1

flashes while the connection is being established. The **Connecting Call** message appears in the multifunction display and COMAND is muted.

If a connection can be established, the **Call Connected** message appears in the multifunction display.

If a mobile phone network is available and there is sufficient GPS reception, the mbrace system transmits data to the Response Center, for example:

- current location of the vehicle
- vehicle identification number
- vehicle model
- vehicle color

- i The audio system or COMAND display shows that an mbrace call is active. You can switch to the navigation menu by pressing the NAVI button on COMAND during the call. Spoken commands are not available.

A voice connection between the Response Center and the vehicle occupants is established. You can obtain information on how to operate your vehicle's systems, on the location of the nearest authorized Mercedes-Benz Center, and on further products and services offered by Mercedes-Benz USA.

Further details on the mbrace system can be found under <http://www.mbusa.com>²⁹. Log in under "Owners Online".

- i If the indicator lamp in MB info call button 1 flashes continuously and no voice connection to the Response Center has been established, then the mbrace system has failed to initiate an MB info call (e.g. the corresponding mobile phone network is not available). The **Call Failed** message appears in the multifunction display.

²⁸ USA only.

²⁹ USA only.

► **To end a call:** press the  button on the multifunction steering wheel.

or

► Press the corresponding button for ending a phone call on the audio system or on COMAND.

Call priority

An emergency call can still be initiated even if a service call is currently active, e.g. a Roadside Assistance call or an MB info call. In this case, an emergency call will take priority and override all other active calls.

The indicator lamp of the respective button flashes until the call is ended. An emergency call can only be terminated by the Response Center. All other calls can be ended by pressing the  button on the multifunction steering wheel or the corresponding button for ending a telephone call on the audio system or on COMAND.

- ❗ When an mbrace call has been initiated, the audio system or COMAND is muted. The mobile phone is no longer connected to COMAND. If you must use your mobile phone, we recommend that you do this only when the vehicle is stationary and in a safe location.

Downloading destinations in COMAND

Destination Download gives you access to a database with over 10 million points of interest (POIs) which can be downloaded to the navigation system of your vehicle. If you know the destination, you can download the address or obtain the location of points of interest (POIs) or important destinations in the surrounding area.

You are prompted to confirm route guidance to the entered address.

The system calculates the route and subsequently starts the route guidance with the address entered.

³⁰ USA only.

- ❗ If you select No, the address can be stored in the address book.

- ❗ The Destination Download function is available if the corresponding cellular phone network is available and data transfer is possible.

Search & Send

"Search & Send" is a destination entry service. You can find further information on "Search & Send" in the separate COMAND operating instructions.

Vehicle remote opening

If you have unintentionally locked your vehicle (e.g. the SmartKey is inside the vehicle) and a replacement key is not available:

- Contact the following service hotlines:
 - **USA:** Response Center under the number 866-990-9007
 - **Canada:** Customer Service under 1-888-923-8367
 You will be asked for your password.
- Return to your vehicle at the time arranged with the Response Center.
- Pull the tailgate handle for at least 20 seconds until the indicator lamp in the SOS button (▷ page 220) flashes. The *Connecting Call* message appears in the multifunction display.

Alternatively, the vehicle can also be opened via the Internet in the "Owners Online" section using your ID number and password³⁰.

- ❗ Vehicle remote unlocking is only possible if the corresponding cellular phone network is accessible.

The SOS button flashes and the *Connecting Call* message appears in the multifunction display to confirm that the

command for vehicle remote unlocking has been received.

If you pull the tailgate handle for more than 20 seconds before receiving authorization for remote unlocking from the Response Center, you must wait 15 minutes before you can pull on the handle of the tailgate again.

Vehicle remote closing in an emergency

If you forget to lock your vehicle but are no longer in the vicinity of the vehicle, it can be locked for you by the Response Center.

The vehicle can be locked remotely up to four days after the ignition was last switched off.

► Contact the following service hotlines:

- **USA:** Response Center under 866-990-9007
- **Canada:** Customer Service under 1-888-923-8367

You will be asked for your PIN.

The next time you are in your vehicle and switch on the ignition, the Tele Aid Doors locked by remote control message appears in the multifunction display.

- ❗ The vehicle remote locking feature is available when the relevant mobile phone network is available and data connection is possible.

Stolen Vehicle Recovery Services

If your vehicle has been stolen:

- Contact the police.
The police will issue an incident report. This report has a number.
- This number will be forwarded to the Response Center together with your PIN. The Response Center will then attempt to covertly contact the mbrace system. The Response Center contacts you and the local law enforcement authority if the vehicle is located. However, only the law enforcement authority is informed of the location of the vehicle.

- ❗ If the anti-theft alarm system remains activated for longer than thirty seconds, mbrace is automatically connected to the Customer Assistance Center.

Garage door opener

Important safety notes

Up to three different door and gate systems can be operated using the remote control integrated in the overhead control panel.

- ❗ Certain garage door openers are not compatible with the integrated remote control. If you experience difficulties with the programming of the integrated remote control, contact an authorized Mercedes-Benz Center or call the following telephone assistance service:

- **USA:** Mercedes-Benz Customer Assistance Center on 1-800-FOR-MERCEdes
- **Canada:** Customer Service on 1-800-387-0100

⚠ Warning

Before programming the integrated remote control to a garage door opener or gate operator, make sure people and objects are out of the way of the device to prevent potential harm or damage. When programming a garage door opener, the door moves up or down. When programming a gate operator, the gate opens or closes.

Do not use the integrated remote control with any garage door opener that lacks safety stop and reverse features as required by U.S. federal safety standards (this includes any garage door opener model manufactured before April 1, 1982). A garage door that cannot detect an object - signaling the door to stop and reverse - does not meet current U.S. federal safety standards.

When programming a garage door opener, park vehicle outside the garage.

Do not run the engine while programming the integrated remote control. Inhalation of exhaust gas is hazardous to your health. All exhaust gas contains carbon monoxide (CO), and inhaling it can cause unconsciousness and possible death. All exhaust gas contains carbon monoxide (CO), and inhaling it can cause unconsciousness and possible death.

i USA only:

This device complies with part 15 of the FCC rules. Operation is subject to the following two conditions:

1. The device must not cause harmful interference.
2. The device must withstand any interference received, including interference that may cause undesired operation.

Unauthorized modification of this device could void the device's operating permit.

i Canada only:

This device complies with the RSS-210 requirements of Industry Canada. Operation is subject to the following two conditions:

1. The device must not cause harmful interference.
2. The device must accept any interference received, including interference that may cause undesired operation.

Unauthorized modification of this device could void the user's authority to legally operate the device.

Programming the remote control

Programming

⚠ Warning!

Only press the transmitter button on the integrated remote control if there are no persons or objects present within the sweep of the garage door. People could otherwise be injured by the movement of the door.

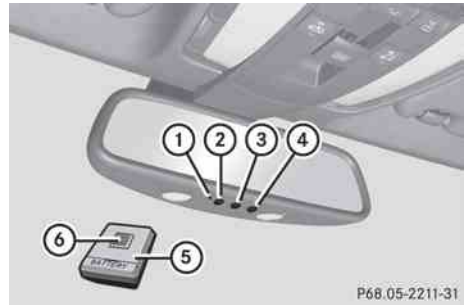

Remote control in the rear-view mirror

Garage door remote control ⑤ is not part of the garage door opener.

- i** To achieve the best result, insert new batteries in garage door remote control ⑤ of your garage door drive before programming.
- ▶ Erase the memory of the integrated remote control (▷ page 227) before programming it for the first time.
 - ▶ Turn the SmartKey to position **2** in the ignition lock.
 - ▶ Press and hold one of transmitter buttons ② to ④ on the integrated remote control. After a short time, indicator lamp ① will start flashing. It flashes about once per second.
 - i** Indicator lamp ① flashes immediately the first time that the transmitter button is programmed. If this transmitter button has already been programmed, indicator lamp ① will only start flashing at a rate of once per second after 20 seconds have elapsed.
 - ▶ Keep the transmitter button depressed.
 - ▶ Point transmitter button ⑥ of garage door remote control ⑤ towards the transmitter buttons on the rear-view mirror from a distance of 2 to 12 inches (5 to 20 cm).
 - i** The distance between garage door remote control ⑤ and the integrated garage door opener depends on the system of the garage door drive. You might require

several attempts. You should test every position for at least 20 seconds before trying another position.

- ▶ Keep transmitter button ⑥ on garage door remote control ⑤ pressed until indicator lamp ① starts to flash rapidly. The programming has been successful if indicator lamp ① flashes rapidly.
- ▶ Release transmitter buttons ②, ③ or ④ on the integrated remote control or transmitter button on the garage door remote control ⑥.

If indicator lamp ① goes out after approximately 20 seconds and has not flashed rapidly:

- ▶ Release transmitter buttons ②, ③ or ④ on the integrated remote control or transmitter button on the garage door remote control ⑥.
- ▶ Repeat the procedure for the other transmitter buttons. When doing so, vary the distance between the garage door's remote control and the transmitter buttons in the rear-view mirror.

- ❗ If the garage door system works with a rolling code, you must synchronize the remote control integrated into the rear-view mirror with the garage door system receiver after programming.

You will find further information in the garage door opening system's operating instructions, e.g. the sections on "Synchronizing the transmitter" or "Registering a new transmitter". You can also call the hotline mentioned above.

Notes on programming the remote control

Canadian radio frequency laws require transmitter signals to "time-out" (or quit) after several seconds of transmission. This may not be long enough for the integrated signal transmitter to pick up the signal during programming. Similar to this Canadian law,

some U.S. gate operators are designed to "time-out" in the same manner.

If you live in Canada or have difficulties programming the garage door opener (regardless of where you live) when using the programming steps (see above), proceed as follows:

- ▶ Press transmitter button (②, ③ or ④) and hold it down during the following steps until the setup has been completed successfully.
- ▶ At the same time, press transmitter button ⑥ of the garage door remote control for two seconds, then release it for two seconds, then press it again for two seconds.
- ▶ Repeat this sequence on transmitter button ⑥ of the garage door remote control until the frequency signal has been learned.
- ▶ If the setup procedure is successful, indicator lamp ① flashes once slowly and goes out after a few seconds.
- ▶ Continue with the other programming steps (see above).

Problems when programming

If you have problems when programming the integrated remote control, please note the following:

- check the transmitter frequency of garage door remote control ⑤ (which can usually be found on the rear of the remote control). The integrated remote control is compatible with equipment that operates in the frequency range 280 to 390 MHz.
- replace the batteries in garage door remote control ⑤. This increases the likelihood of garage door remote control ⑤ sending a strong and precise signal to the integrated remote control on the rear-view mirror.
- When aiming the garage door remote control at the transmitter buttons on the rear-view mirror, hold garage door remote control ⑤ at differing distances and angles

from the transmitter button that you are programming. Try different angles from a distance of 2 to 12 inches (5 to 30 cm) or the same angle from differing distances.

- If there is another garage door remote control for the same device, perform the programming steps again using the remote control. Before performing these steps, make sure that new batteries have been installed in the garage door remote control.
- Align the antenna cable of the garage door opener unit. This can improve signal reception/transmission.

Opening or closing the garage door

Once programmed, the integrated remote control will assume the function of the garage door system's remote control. Please also read the operating instructions for the garage door system.

- ▶ Turn the SmartKey to position **2** in the ignition lock.
- ▶ Press transmitter button ②, ③ or ④ in the overhead control panel that you have programmed to operate the garage door. Garage door system with fixed code: indicator lamp ① lights up continuously. Garage door system with rolling code: indicator lamp ① flashes briefly and then lights up for approximately two seconds. This is repeated for up to 20 seconds.

- ❗ The transmitter will transmit a signal for as long as the transmitter button is being pressed. The transmission will be halted after a maximum of 20 seconds and indicator lamp ① will flash. Press the transmitter button again, if necessary.

Clearing the remote control memory

- ▶ Turn the SmartKey to position **2** in the ignition lock.
- ▶ Press and hold transmitter buttons ② and ④ for approximately 20 seconds until indicator lamp ① flashes rapidly. The memory is cleared.
- ❗ You should clear the remote control memory before selling the vehicle.

Compass

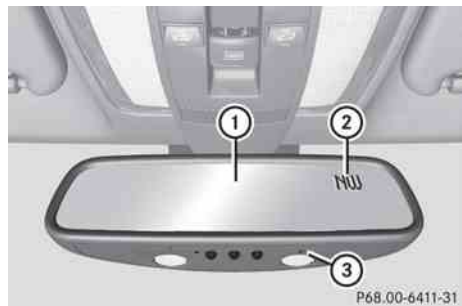

To obtain correct direction display in rearview mirror ①, the compass must be calibrated and the magnetic field zone set.

- ▶ **To call up the compass:** briefly press button ③. The compass indicates the direction in which the vehicle is currently driving: N, NE, E, SE, S, SW, W or NW.
- ▶ **To calibrate the compass:** determine your position using the following the zone maps.

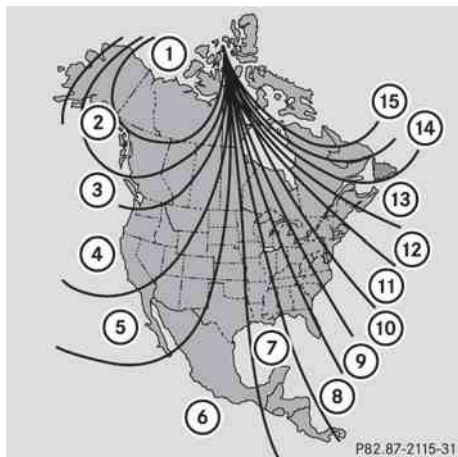

Zone map for North America

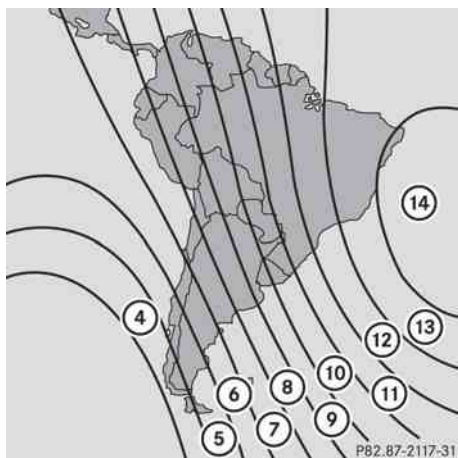

Zone map for South America

- ▶ Press and hold button ③ for approximately three seconds.

The currently selected zone appears in compass display ②.

- ▶ **To select the zone:** press button ③ repeatedly until the desired zone is selected.
The zone has been selected when compass display ② shows the point of the compass. This takes a few seconds.
- ▶ **To calibrate the compass:** make sure that there is sufficient space for you to drive in

a circle without impeding the remaining traffic.

In order to calibrate the compass correctly, observe the following points:

- calibrate the compass in the open and not in the vicinity of steel structures or high-voltage power lines
 - switch off electrical consumers such as climate control, the windscreen wipers or the rear window heating
 - close all doors and the tailgate
- ▶ Switch on the ignition.
- ▶ Press and hold button ③ for approximately six seconds until the C symbol appears in compass display ②.
- ▶ Drive a full circle at approximately 3 mph (5 km/h) to 6 mph (10 km/h).
Once the calibration has been successfully completed, the current heading appears in compass display ②.

Floormat on the driver's side

⚠ Warning!

Whenever you are using a floormat, make sure there is enough clearance and that the floormat is securely fastened.

The floormat should always be securely fastened using the fastening equipment.

Before driving off, check that the floormat is securely in place and adjust it if necessary. A loose floormat could slip and hinder proper functioning of the pedals.

Do not place several floormats on top of each other as this may impair pedal movement.

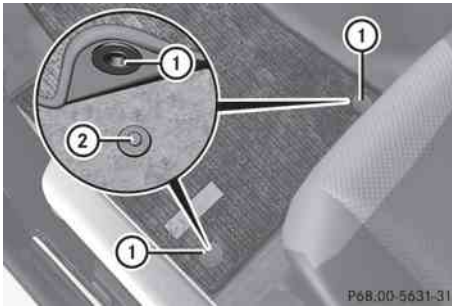

- ▶ Slide seat backwards.
- ▶ **To install:** place the floor mat in position.
- ▶ Press floor mat eyelets ① onto retainer pins ②.
- ▶ **To remove:** pull the floor mats off retainers ②.
- ▶ Remove the floor mat.

Vehicle equipment	232
Engine compartment	232
Service	236
Care	237

Vehicle equipment

- i** This manual describes all the standard and optional equipment of your vehicle which was available at the time of purchase. Country-specific differences are possible. Bear in mind that your vehicle may not feature all functions described here. This also refers to safety-related systems and functions.

Engine compartment

Hood

Opening the hood

Warning

Do not pull the release lever while the vehicle is in motion. Otherwise, the hood could be forced open by passing air flow.

This could cause the hood to come loose and injure you and/or others.

Warning

Do not open the hood when the engine is overheated. You could be seriously injured. Observe the coolant temperature gauge to determine whether the engine may be overheated. If you see flames or smoke coming from the engine compartment, move away from the vehicle. Wait until the engine has cooled. If necessary, call the fire department.

Warning

There is a risk of injury if the hood is open, even if the engine is not running. Some engine components can become very hot.

To avoid the risk of burns, only touch those components described in the Operator's Manual and observe the relevant safety notes.

Warning

To help prevent personal injury, stay clear of moving parts when the hood is open and the engine is running.

The radiator fan may continue to run for approximately 30 seconds or may even restart after the engine has been turned off. Stay clear of fan blades.

Warning

The engine is equipped with a transistorized ignition system. Because of the high voltage, it is dangerous to touch any components (ignition coils, spark plug sockets, diagnostic socket) of the ignition system:

- with the engine running
- while starting the engine
- when the ignition is switched on and the engine is turned manually

- Make sure that the windshield wipers are switched off.

Warning

The windshield wipers and wiper linkage could be set in motion.

When the hood is open, you or others could be injured by the wiper linkage.

Make sure that the windshield wipers are switched off. Remove the SmartKey or make sure that no ignition position has been selected with KEYLESS-GO. All indicator lamps must be off in the instrument cluster.

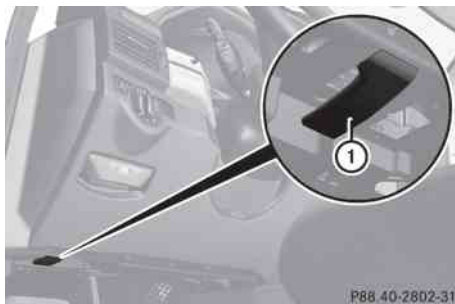

- ▶ Pull release lever ① on the hood.
The hood is released.

! Make sure that the windshield wipers are not folded away from the windshield. You could otherwise damage the windshield wipers or the hood.



- ▶ Reach into the gap, pull hood catch handle ② up and lift the hood.

Closing the hood

Warning

When closing the hood, use extreme caution not to catch hands or fingers. Be careful that you do not close the hood on anyone.

Make sure the hood is securely engaged before driving off. Do not continue driving if the hood can no longer engage after an accident, for example. The hood could otherwise come loose while the vehicle is in motion and injure you and/or others.

- ▶ Lower the hood and let it fall from a height of approximately 8 inches (20 cm).
- ▶ Check that the hood has engaged properly. If the hood can be raised slightly, it is not properly engaged. Open it again and close it with a little more force.

Engine oil

Notes on the oil level

Depending on the driving style, the vehicle consumes up to 0.9 US qt (0.8 l) of oil over a distance of 600 miles (1000 km). The oil consumption may be higher than this when the vehicle is new or if you frequently drive at high engine speeds.

When checking the oil level:

- park the vehicle on a level surface.
- the engine should be switched off for at least five minutes if the engine is at normal operating temperature.
- the engine should be switched off for at least 30 minutes if it is not at normal operating temperature (i.e. if you only start the engine briefly).

Checking the oil level using the oil dipstick

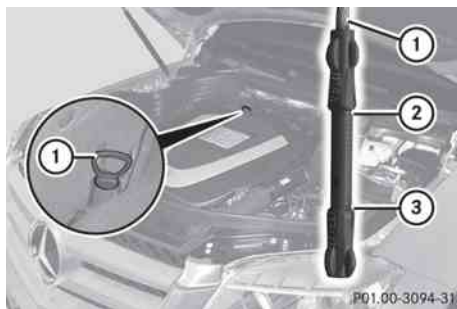

- ▶ Pull oil dipstick ① out of the dipstick guide tube.
- ▶ Wipe off oil dipstick ①.
- ▶ Slowly insert oil dipstick ① into the dipstick guide tube to the stop, and take it out again.
The oil level is correct if the level is between MIN mark ③ and MAX mark ②.
- ▶ Add oil if necessary.

Adding engine oil

Environmental note

When adding oil, take care not to spill any. If oil enters the soil or waterways, it is harmful to the environment.

- ❗ Only use engine oils and oil filters which have been approved for vehicles with a service system. A list of the engine oils and oil filters that have been tested and approved according to the Mercedes-Benz specifications for service products can be found on the Internet at <http://www.mbusa.com> (USA only). Further information on tested and approved engine oils and oil filters can be obtained from any authorized Mercedes-Benz Center.

The following causes engine failure or damage to the exhaust system:

- using engine oils and oil filters that are not specifically approved for the service system
- replacing the engine oil and oil filter later than the specified replacement interval required by the service system
- using engine oil additives

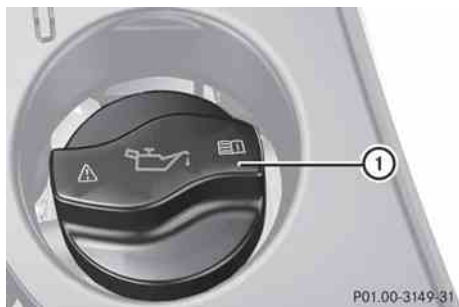

Example: engine oil cap

- ▶ Turn cap ① counter-clockwise and remove it.
- ▶ Add the amount of oil required.

Fill carefully to the maximum mark on the oil dipstick.

- ❗ The difference in quantity between the MIN mark and the MAX mark on the dipstick is (depending on the engine) approximately 1.6 to 2.1 US qt. (1.5 to 2 l).

- ❗ Do not add too much oil. If the oil level is above the MAX mark on the dipstick, too much oil has been added. This can lead to damage to the engine or the catalytic converter. Have excess oil siphoned off.

Further information on engine oil (▷ page 297).

- ▶ Replace cap ① on the filler neck and tighten clockwise. Ensure that the cap locks into place securely.

Checking and adding other service products

Checking the coolant level

Only check the coolant level when the vehicle is on a level surface and the engine has cooled down.

- ▶ Turn the SmartKey to position 2 (▷ page 129) in the ignition lock. On vehicles with KEYLESS-GO, press the Start/Stop button twice (▷ page 129).
- ▶ Check the coolant temperature display in the instrument cluster. The coolant temperature must be below 158 °F (70 °C).

Warning

In order to avoid any potentially serious burns:

- use extreme caution when opening the hood if there are any signs of steam or coolant leaking from the cooling system, or if the coolant temperature display indicates that the coolant is overheated.
- do not remove the pressure cap on the coolant reservoir if the coolant temperature is above 158 °F (70 °C). Allow the engine to cool down before removing the cap. The

coolant reservoir contains hot fluid and is under pressure.

- using a rag, slowly turn the cap approximately $1/2$ turn to relieve excess pressure. If opened immediately, scalding hot fluid and steam will be blown out under pressure.
- do not spill antifreeze on hot engine parts. Antifreeze contains ethylene glycol which may burn if it comes into contact with hot engine parts.



- ▶ Slowly turn cap ① half a turn counter-clockwise and allow excess pressure to escape.
- ▶ Turn cap ① further counter-clockwise and remove it.
If the coolant is at the level of marker bar ③ in the filler neck when cold, there is enough coolant in coolant expansion tank ②.
If the coolant is approximately 0.6 in (1.5 cm) higher when warm, there is enough coolant in coolant expansion tank ②.
- ▶ If necessary, add coolant which has been tested and approved by Mercedes-Benz.
- ▶ Replace cap ① and turn it clockwise as far as it will go.

For further information on coolant, see (▷ page 298).

Windshield washer system/headlamp cleaning system

The washer fluid reservoir is used for both the windshield washer system and the headlamp cleaning system.

Warning

Washer solvent/antifreeze is highly flammable. Do not spill washer solvent/antifreeze on hot engine parts, because it may ignite and burn. You could be seriously burned.

- ❗ At temperatures below freezing, always fill the washer fluid container with a mix of windshield washer concentrate and antifreeze additive. There is otherwise a risk of damaging the windshield washer system/headlamp cleaning system.
- ❗ Only use washer fluid concentrate which is suitable for plastic lenses. Unsuitable washer fluid concentrate could damage the plastic lenses of the headlamps.
- ❗ Do not add distilled or de-ionized water to the washer fluid container. Otherwise, the fluid level measuring gauge could be damaged.
- i Add windshield washer concentrate, e.g. MB SummerFit, to the washer fluid all year round.



Example: washer fluid reservoir

- ▶ Mix the windshield washer fluid in a container beforehand.
- ▶ **At temperatures above freezing:** fill the washer fluid reservoir with a mix of water and windshield washer concentrate (e.g. MB SummerFit).
- ▶ **At temperatures below freezing:** fill the washer fluid reservoir with a mix of water and MB SummerFit windshield washer concentrate. For information on the mixing ratio, see (▶ page 299) or use the premixed windshield washer solution with antifreeze available in specialist stores.
- ▶ **To open:** pull cap ① upwards by the tab.
- ▶ Add the premixed washer fluid.
- ▶ **To close:** press cap ① onto the filler neck until it engages.

Brake fluid level

❗ If you discover that the brake fluid level in the brake fluid reservoir has fallen to the MIN mark or below, check the brake system for leaks immediately. Also check the brake lining thickness. Contact a qualified specialist workshop, e.g. an authorized Mercedes-Benz Center immediately.

Do not top up the brake fluid. This will not rectify the malfunction.

Only check the brake fluid level when the vehicle is stationary and on a level surface.

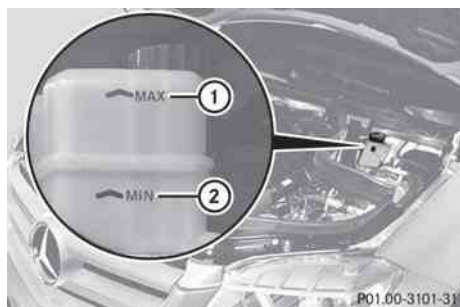

The brake fluid level is correct if it is between MIN marking ② and MAX marking ① on the brake fluid reservoir.

Service

Service interval display

Service messages

Information about the type of service and service intervals (see separate Service Booklet)

You can obtain more information at an authorized Mercedes-Benz Center or at **www.mbusa.com** (USA only).

The service interval display informs you of the next service due date.

If a service is overdue, you will also hear a warning tone.

The multifunction display shows a service message for a few seconds, e.g.

Next Service A in .. mls

Service A due

Service A Exceeded By .. mls

The letter indicates which service is due. A stands for a minor service and B for a major service. A number or another letter may be displayed after the letter. This figure indicates any necessary additional maintenance work to be performed.

You can obtain further information at an authorized Mercedes-Benz Center.

The service interval display does not take into account any periods of time during which the battery is disconnected.



Maintaining the time-dependent service schedule:

- ▶ Before disconnecting the battery, call up the service due date in the multifunction display and note it down.





or

- ▶ Subtract the battery disconnection periods from the service date shown on the display after reconnecting the battery.

Hiding the service message

- ▶ Press  or  on the steering wheel.

Displaying the service message

- ▶ Switch on the ignition.
- ▶ Press  or  to select the Service menu on the steering wheel.
- ▶ Press  or  to select the ASSYST PLUS submenu and press  to confirm. The service due date appears in the multifunction display.

Points to remember

A qualified specialist workshop, e.g. an authorized Mercedes-Benz Center, will reset the service interval display after the necessary service work has been carried out. You can obtain more information, e.g. on maintenance work, at an authorized Mercedes-Benz Center or directly at Mercedes-Benz.

- !** If the service interval indicator has been inadvertently reset, this setting can be corrected at an authorized Mercedes-Benz Center.

Have the service work carried out as described in the Service Booklet. There may otherwise be increased wear, resulting in damage to the vehicle or to the major assemblies.

Care

Notes on care

Regular care of your vehicle is a condition for retaining the quality in the long term.

Use care products and cleaning agents recommended and approved by Mercedes-Benz.

Warning

Many cleaning products can be hazardous. Some are poisonous, others are flammable.

Always follow the instructions on the particular container. Always open your vehicle's doors or windows when cleaning the inside.

Never use fluids or solvents that are not designed for cleaning your vehicle.

Always lock away cleaning products and keep them out of reach of children.

- !** For cleaning your vehicle, do not use any of the following:

- dry, rough or hard cloths
- abrasive cleaning agents
- solvents
- cleaning agents containing solvents

Do not scrub.

Do not touch the surfaces or protective films with hard objects, e.g. a ring or ice scraper. You could otherwise scratch or damage the surfaces and protective film.

Environmental note

Dispose of empty packaging and cleaning cloths in an environmentally responsible manner.

- !** Do not park the vehicle for an extended period right after cleaning it, particularly after having cleaned the wheels with wheel cleaner. Wheel cleaners could cause increased corrosion of the brake discs and brake pads/linings. For this reason, you should drive for a few minutes after cleaning. Braking heats the brake discs and brake pads, thus drying them. The vehicle can then be parked up.

Exterior care

Automatic car wash

Warning!

Braking efficiency is reduced after washing the vehicle. This could cause an accident. For this reason, you must drive particularly

carefully after washing the vehicle until the brakes have dried.

You can wash the vehicle in an automatic car wash from the very start.

! Never clean your vehicle in a Touchless Automatic Car Wash as these use special cleaning agents. These cleaning agents can damage the paintwork or plastic parts.

If the vehicle is very dirty, pre-wash it before cleaning it in an automatic car wash.

! In car washes with a towing mechanism, make sure that AUTOTRONIC is in transmission position **N**, otherwise the vehicle could be damaged.

! Make sure that the side windows are completely closed, that the ventilation/heating is switched off and that the windshield wiper switch is set to **0**. Otherwise, the rain/light sensor could be activated, triggering unintended wiper movements. This can cause damage to the vehicle.

After using an automatic car wash, wipe off wax from the windshield and the wiper blades. This will prevent smears and reduce wiping noises caused by residue on the windshield.

Washing by hand

Carefully remove all deposits of road salt as soon as possible when driving in winter.

Also, clean the insides of the wheels when washing the underbody of the vehicle.

- ▶ Do not use hot water and do not wash the vehicle in direct sunlight.
- ▶ Use a soft car sponge for cleaning.
- ▶ Use a gentle cleaning agent, e.g. a Mercedes-Benz approved car shampoo.
- ▶ Wash down the vehicle with a gentle water jet.
- ▶ Do not point the water jet directly at the air inlets.

- ▶ Use plenty of water and rinse the sponge frequently.
- ▶ Rinse the vehicle with clean water and dry it thoroughly with a chamois.
- ▶ Do not allow the cleaning agent to dry on the paintwork.

Power washers

Warning!

Do not use power washers with circular-jet nozzles (dirt grinders) to clean your vehicle, in particular the tires. You could otherwise damage the tires and cause an accident.

! Keep the distance between the vehicle and the nozzle of the power washer at 11.8 in (30 cm). Information about the correct distance is available from the equipment manufacturer.

Move the power washer nozzle around when cleaning your vehicle.

Do not aim directly at any of the following:

- tires
- door joint
- electrical components
- battery
- connectors
- lights
- seals
- trim elements
- ventilation slots

Damaged seals or electrical components can lead to leaks or failures.

Cleaning the wheels

! Do not use acidic wheel cleaning products to remove brake dust. This could damage wheel bolts and brake components.

! Do not park the vehicle for an extended period right after cleaning it, particularly after having cleaned the wheels with wheel cleaner. Wheel cleaners could cause increased corrosion of the brake discs and

brake pads/linings. For this reason, you should drive for a few minutes after cleaning. Braking heats the brake discs and brake pads, thus drying them. The vehicle can then be parked up.

Cleaning the paintwork

Scratches, corrosive deposits, areas affected by corrosion and damage caused by inadequate care cannot always be completely repaired. In such cases, visit a qualified specialist workshop immediately, e.g. an authorized Mercedes-Benz Center.

- ▶ Remove impurities immediately, where possible, whilst avoiding rubbing too hard.
- ▶ Soak insect remains with insect remover and rinse off the treated areas afterwards.
- ▶ Soak bird droppings with water and rinse off the treated areas afterwards.
- ▶ Remove coolant, brake fluid, tree resin, oils, fuels and greases by rubbing gently with a cloth soaked in petroleum ether or lighter fluid.
- ▶ Use tar remover to remove tar stains.
- ▶ Use silicone remover to remove wax.

! Do not affix:

- stickers
- films
- magnetic plates or similar items to painted surfaces. You could otherwise damage the paintwork.

If water no longer forms "beads" on the painted surface, paint care products should be used that have been approved and recommended by Mercedes-Benz. This is the case approximately every three to five months, depending on climatic conditions and the care product used.

If dirt has entered the paint surface or the paintwork has become dull, a paint cleaner should be used that has been approved and recommended by Mercedes-Benz.

Never use such care products in direct sunlight or on a hot hood.

- ▶ Use a suitable touch-up stick, e.g. MB Touch Up stick, for quick, temporary repair of damaged paintwork.

Cleaning the windows

Warning

Switch off the windshield wipers and remove the SmartKey from the ignition lock before cleaning the windshield or the wiper blades. On vehicles with KEYLESS-GO, press the Start/Stop button repeatedly until all indicator lamps in the instrument cluster have gone off. The windshield wipers could otherwise move and injure you.

- ! Only fold the windshield wipers away from the windshield when vertical. Otherwise, you will damage the hood.
- ▶ Clean the inside and outside of the windows with a damp cloth and a cleaning agent that is recommended and approved by Mercedes-Benz.
- ! Do not use dry cloths, abrasive products, solvents or cleaning agents containing solvents to clean the inside of the windows. Do not use hard objects to clean the insides of the windows, e.g. an ice scraper or ring. There is otherwise a risk of damaging the windows.
- ! Clean the water drainage channels of the windshield and the rear window at regular intervals. Deposits such as leaves, petals and pollen may under certain circumstances prevent water from draining away. This can lead to corrosion damage and damage to electronic components.

Cleaning the wiper blades

Warning

Switch off the windshield wipers and remove the SmartKey from the ignition lock before cleaning the windshield or the wiper blades. On vehicles with KEYLESS-GO, press the Start/Stop button repeatedly until all

indicator lamps in the instrument cluster have gone off. The windshield wipers could otherwise move and injure you.

- ❗ Only fold the windshield wipers away from the windshield when vertical. Otherwise, you will damage the hood.
- ❗ Do not pull the wiper blade. Otherwise, the wiper blade could be damaged.
- ❗ Do not clean wiper blades too often and do not rub them too hard. Otherwise, the graphite coating could be damaged. This could cause wiper noise.
- ▶ Fold the wiper arms away from the windshield.
- ▶ Carefully clean the wiper blades with a damp cloth.
- ▶ Fold the windshield wipers back again before switching on the ignition.
- ❗ Hold the wiper arm securely when folding back. The windshield could be damaged if the wiper arm smacks against it suddenly.

Cleaning the headlamps

- ▶ Clean the plastic lamp lenses on the headlamps using a wet sponge and a mild cleaning agent, e.g. Mercedes-Benz car shampoo or cleaning cloths.
- ❗ Only use cleaning agents or cleaning cloths which are suitable for plastic headlamp lenses. Unsuitable cleaning agents or cleaning cloths could scratch or damage the plastic headlamp lenses.

Cleaning the sensors

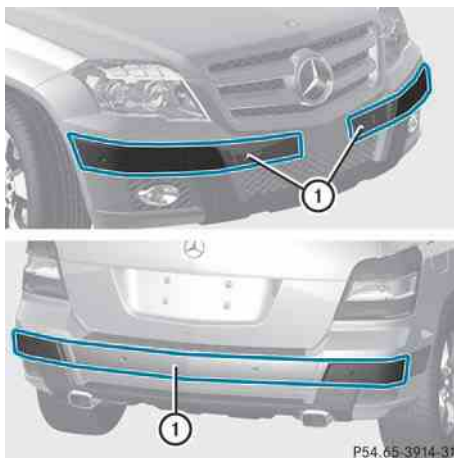

- ▶ Clean sensors ① of the driving systems with water, car shampoo and a soft cloth.
- ❗ When cleaning the sensors with a power washer, maintain a distance between the vehicle and the nozzle of the power washer of at least 11.8 in (30 cm). Information about the correct distance is available from the equipment manufacturer.

Cleaning the rear view camera



- ▶ Use clear water and a soft cloth to clean camera lens ①.
- ❗ Do not clean the camera lens and the area around the rear view camera with a power washer.

Cleaning the exhaust tail pipes

Impurities combined with the effects of road grit and corrosive environmental factors may cause flash rust to form on the surface. You can restore the original shine of the exhaust tail pipe by cleaning it regularly, especially in winter and after washing.

- ❗ Do not clean the exhaust tail pipes with alkaline-based cleaning agents, such as wheel cleaner.
- ▶ Clean the exhaust tail pipes with a chrome care product tested and approved by Mercedes-Benz.

Interior care

Cleaning the display

- ▶ Before cleaning the display, make sure that it is switched off and has cooled down.
- ▶ Clean the display surface using a commercially-available microfiber cloth and TFT/LCD display cleaner.
- ▶ Dry the display surface using a dry microfiber cloth.

❗ For cleaning, do not use any of the following:

- alcohol-based thinner or gasoline
- abrasive cleaning agents
- commercially-available household cleaning agents

These may damage the display surface. Do not put pressure on the display surface when cleaning. This could lead to irreparable damage to the display.

Cleaning the plastic trim

Warning!

When cleaning the steering wheel boss and dashboard, do not use cockpit sprays or cleaning agents containing solvents. Cleaning agents containing solvents cause the surface to become porous, and as a result, plastic

parts may break away and be thrown around the interior when an air bag is deployed, which may result in severe injuries.

❗ Do not affix the following to plastic surfaces:

- stickers
- films
- scented oil bottles or similar items

You can otherwise damage the plastic.

❗ Do not allow cosmetics, insect repellent or sunscreen to come into contact with the plastic trim. This maintains the high-quality look of the surfaces.

- ▶ Wipe the plastic trim with a damp, lint-free cloth, e.g. a microfiber cloth.
- ▶ **Heavy soiling:** use car care and cleaning products recommended and approved by Mercedes-Benz. The surface may change color temporarily. Wait until the surface is dry again.

Cleaning the steering wheel and gear or selector lever

- ▶ Wash thoroughly with a damp cloth or use a leather care agent that has been recommended and approved by Mercedes-Benz.

Cleaning real wood and trim strips

- ▶ Wipe the wooden trim and trim strips with a damp, lint-free cloth, e.g. a microfiber cloth.
- ▶ **Heavy soiling:** use car care and cleaning products recommended and approved by Mercedes-Benz.

❗ Do not use solvent-based cleaning agents such as tar remover, wheel cleaners, polishes or waxes. There is otherwise a risk of damaging the surface.

❗ Do not use chrome polish for trim strips. The trim strips have a chrome look but are mostly made of anodized aluminum and

can lose their shine if chrome polish is used. Use a damp, lint-free cloth instead when cleaning the trim strips.

Chrome polish can be used to remove very heavy soiling from trim strips which you are sure are made of chrome. If you are unsure as to whether a trim strip is chrome-plated or not, consult an authorized Mercedes-Benz Center.

Cleaning the seat covers

! Do not use microfiber cloths to clean genuine leather, artificial leather or Alcantara® covers. If used often, these can damage the cover.

! Observe the following when cleaning:

- clean genuine leather covers carefully with a damp cloth and then wipe the covers down with a dry cloth. Make sure that the leather does not become soaked. It may otherwise become rough and cracked. Only use leather care agents that have been tested and approved by Mercedes-Benz. You can obtain these from a qualified specialist workshop, e.g. an authorized Mercedes-Benz Center.
- clean artificial leather covers with a cloth moistened with a solution containing 1% detergent (e.g. dish washing liquid).
- clean cloth covers with a microfiber cloth moistened with a solution containing 1% detergent (e.g. dish washing liquid). Rub carefully and always wipe entire seat sections to avoid leaving visible lines. Leave the seat to dry afterwards. Cleaning results depend on the type of dirt and how long it has been there.
- clean Alcantara® covers with a damp cloth. Make sure you wipe entire seat sections to avoid leaving visible lines.

i Note that regular care is essential to ensure that the appearance and comfort of the covers is retained over time.

Cleaning the seat belts

► Use clean, luke-warm water and soap solution.

! Do not clean the seat belts using chemical cleaning agents. Do not dry the seat belts by warming them above 176 °F (80 °C) or placing them in direct sunlight.

Warning

Do not bleach or dye seat belts as this may severely weaken them. In a crash, they may not be able to provide adequate protection.

Cleaning the headliner and carpets

► **Roof lining:** use soft brushes or dry shampoo if it is particularly dirty.

► **Carpets:** use carpet and textile cleaners that have been approved and recommended by Mercedes-Benz.

Vehicle equipment	244
After an accident	245
Where will I find...?	245
Flat tire	247
Battery	253
Jump-starting	256
Towing and tow-starting	258
Fuses	260

Vehicle equipment

- i** This manual describes all the standard and optional equipment of your vehicle which was available at the time of purchase. Country-specific differences are possible. Bear in mind that your vehicle may not feature all functions described here. This also refers to safety-related systems and functions.

After an accident

Problem	Possible causes/consequences and ► Solutions
Fuel is leaking from the vehicle.	<p> Risk of explosion or fire</p> <p>The fuel line or the fuel tank is faulty.</p> <ul style="list-style-type: none"> ► Immediately turn the key to position 0 (► page 129) in the ignition lock and remove it. ► Do not restart the engine under any circumstances. ► Consult a qualified specialist workshop.
You are unable to determine the extent of the damage.	<ul style="list-style-type: none"> ► Consult a qualified specialist workshop.
You cannot detect any damage.	<ul style="list-style-type: none"> ► Start the engine as normal.
The NECK-PRO head restraints on the driver's and front-passenger seats have been triggered.	<p>Your vehicle has been involved in a rear-end collision.</p> <ul style="list-style-type: none"> ► Reset the triggered NECK-PRO head restraints (► page 50).

Where will I find...?

First-aid kit

- Open the tailgate.

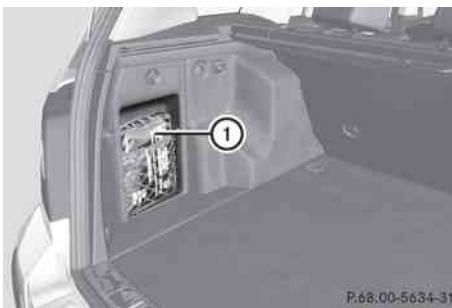

- Remove first-aid kit ① from the parcel net.

- i** Check the expiration date on the first-aid kit at least once a year. Replace the contents if necessary, and replace missing contents.

Vehicle tool kit

The vehicle tool kit can be found in the stowage well under the cargo compartment floor.

- i** Vehicles without a spare wheel are not equipped with the tools needed to change a wheel when they leave the factory, e.g. jack or lug wrench. Some tools for changing a wheel are specific to the vehicle. To obtain tools approved for your vehicle, visit a qualified specialist workshop, e.g. an authorized Mercedes-Benz Center.

- **To remove the cargo compartment stowage trays:** lift up the floor of the cargo compartment (► page 212).

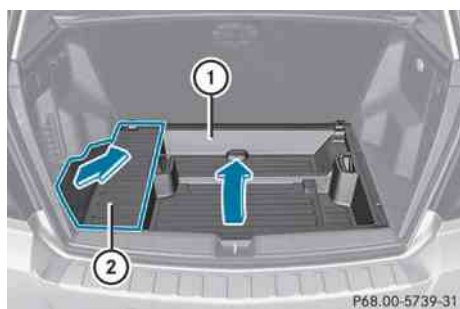

- ▶ Remove stowage tray ① in the direction of the arrow.
- ▶ Remove stowage tray ② in the direction of the arrow.

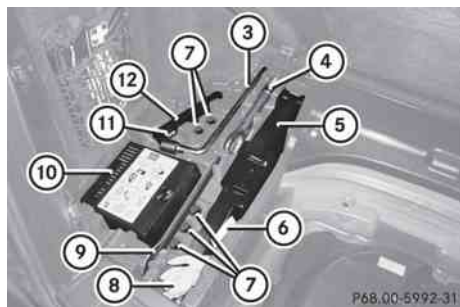

- ③ Lug wrench
- ④ Towing eye
- ⑤ Jack
- ⑥ Fuse allocation chart
- ⑦ Wheel bolts
- ⑧ One pair of gloves
- ⑨ Ratchet ring spanner
- ⑩ Electric air pump
- ⑪ Valve extractor
- ⑫ Folding wheel chock

Collapsible spare wheel

Removing the collapsible spare wheel

The collapsible spare wheel can be found in the stowage well under the cargo compartment floor.

- ▶ Lift the cargo compartment floor up (▷ page 212).

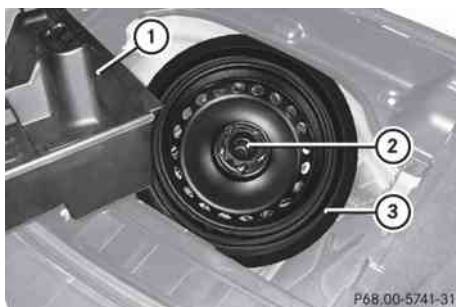

- ▶ Remove stowage well ①.
- ▶ Turn retaining screw ② counter-clockwise.
- ▶ Remove collapsible spare wheel ③.
- ▶ Take the wheel bolts for the collapsible spare wheel from the vehicle tool kit.

For further information on changing a wheel and mounting the spare wheel, see (▷ page 247).

Stowing a used collapsible spare wheel

Take the following steps to stow a used collapsible spare wheel. It will otherwise not fit in the spare wheel well. Mercedes-Benz recommends that you have this work carried out at a qualified specialist workshop, e.g. an authorized Mercedes-Benz Center.

- ❗ Only place the collapsible spare wheel in the vehicle when it is dry. Otherwise, moisture may get into the vehicle.
- ▶ Remove the valve extractor from the vehicle tool kit.
- ▶ Unscrew the valve cap from the valve.
- ▶ Unscrew the valve insert from the valve and release the air.
- ❗ Fully deflating the tire can take a few minutes.
- ▶ Screw the valve insert back into the valve.
- ▶ Screw the valve cap back on.

- ▶ Place the valve extractor back into the vehicle tool kit.
- ▶ Stow the collapsible spare wheel in the emergency spare wheel well under the cargo compartment and fasten in place.

Flat tire

Preparing the vehicle

- ▶ Stop the vehicle as far away as possible from traffic on solid, non-slippery and level ground.
- ▶ Switch on the hazard warning lamps.
- ▶ Firmly depress the parking brake.
- ▶ Bring the front wheels into the straight-ahead position.
- ▶ Move the selector lever to **P**.
- ▶ Switch off the engine.
- ▶ **Vehicles without KEYLESS-GO:** remove the key from the ignition lock.
- ▶ **Vehicles with KEYLESS-GO:** open the driver's door.
The on-board electronics have status **0**, which is the same as the key having been removed.
- ▶ **Vehicles with KEYLESS-GO:** remove the Start/Stop button from the ignition lock (▷ page 129).
- ▶ All occupants must get out of the vehicle. Make sure that they are not endangered as they get out of the vehicle.
- ▶ Make sure that no one is near the danger area whilst a wheel is being changed. Anyone who is not directly assisting in the wheel change should, for example, stand behind the barrier.
- ▶ Get out of the vehicle. Pay attention to traffic conditions when doing so.
- ▶ Close the driver's door.

Changing a wheel and mounting the spare wheel

Preparing the vehicle

Warning!

The wheel and tire size of the emergency spare wheel/spare wheel may differ to that of the damaged wheel. When using an emergency spare wheel/spare wheel the handling characteristics of the vehicle may change.

Adapt your style of driving accordingly.

Never operate the vehicle with more than one emergency spare wheel/spare wheel that differs in size.

Only use an emergency spare wheel/spare wheel of a differing size briefly and do not switch off ESP®.

When using an emergency spare wheel, you must not exceed a maximum speed of 50 mph (80 km/h).

Warning!

Have the emergency spare wheel/spare wheel replaced with a new wheel as soon as possible at a qualified specialist workshop which has the necessary specialist knowledge and tools to carry out the work required. Mercedes-Benz recommends that you use an authorized Mercedes-Benz Center for this purpose. In particular, work relevant to safety or on safety-related systems must be carried out at a qualified specialist workshop.

- i** Vehicles without an emergency spare wheel/spare wheel are not equipped with wheel-changing tools at the factory. For more information on which tools are required to perform a wheel change on your vehicle, e.g. wheel chock, alignment bolt or lug wrench, consult an authorized Mercedes-Benz Center.

- ▶ Prepare the vehicle as described (▷ page 247).
- ▶ If a trailer is coupled to the vehicle, uncouple it.
- ▶ Remove the following items from the stowage well under the trunk floor:
 - the emergency spare wheel
 - the wheel bolts for the emergency spare wheel
 - the electric air pump
 - the lug wrench
 - the folding wheel chock
 - the jack
 - the ratchet ring spanner
- ▶ Secure the vehicle to prevent it from rolling away.

Securing the vehicle to prevent it from rolling away

Warning

Only jack up the vehicle on level ground or on slight inclines/declines. The vehicle could otherwise fall off the jack and injure you or others.

If your vehicle is equipped with a wheel chock, it can be found in the vehicle tool kit (▷ page 245).

The folding wheel chock is an additional securing measure to prevent the vehicle from rolling away, for example when changing a wheel.

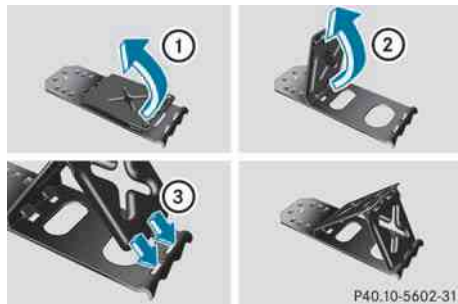

- ▶ Fold both plates upwards ①.

- ▶ Fold out lower plate ②.
- ▶ Guide the lugs on the lower plate fully into openings in base plate ③.



Securing the vehicle on level ground

- ▶ **On level ground:** place chocks or other suitable items under the front and rear of the wheel that is diagonally opposite the wheel you wish to change.



Securing the vehicle on slight downhill gradients

- ▶ **On downhill gradients:** place chocks or other suitable items in front of the wheels of the front and rear axle.

Raising the vehicle

Warning

When jacking up the vehicle, only use the jack which has been specifically approved by Mercedes-Benz for your vehicle.

The jack is designed exclusively for jacking up the vehicle at the jacking points built into both sides of the vehicle. The jack saddle must be placed centrally under the jacking point. The

jack must always be vertical when in use, especially on inclines or declines.

The jack is intended only for lifting the vehicle briefly for wheel changes. It is not suited for performing maintenance work under the vehicle. To help avoid personal injury, use the jack only to lift the vehicle during a wheel change.

Never get beneath the vehicle while it is supported by the jack. Keep hands and feet away from the area under the lifted vehicle. Always lower the vehicle onto sufficient capacity jackstands before working under the vehicle.

Always firmly engage the parking brake and block the wheels with wheel chocks or other sizable objects before raising the vehicle with the jack. Do not disengage the parking brake while the vehicle is raised.

Make sure that the ground on which the vehicle is standing and where you place the jack is solid, level and not slippery. If necessary, use a large underlay. On slippery surfaces, such as tiled floors, you should use a non-slip underlay, for example a rubber mat.

Do not use wooden blocks or similar objects as a jack underlay. Otherwise, the jack may not be able to achieve its load-bearing capacity if it is not at its full height.

Never start the engine when the vehicle is raised.

Also observe the notes on the jack.



- Using lug wrench (1), loosen the bolts on the wheel you wish to change by about one

full turn. Do not unscrew the bolts completely.

The jacking points for the jack are located behind the wheel housings of the front wheels and in front of the wheel housings of the rear wheels (arrows).

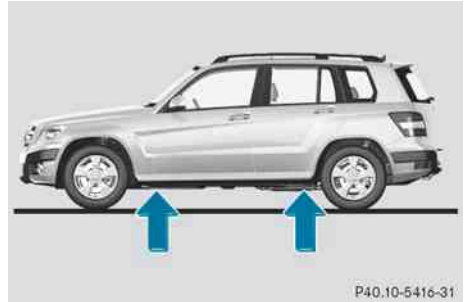

⚠ Warning

The jack is designed exclusively for jacking up the vehicle at the jacking points. The jack saddle must be placed centrally under the jacking point.

If you do not position the jack correctly in the jacking point, the vehicle can fall off the jack and seriously or fatally injure you or others.

- ❗ The jack is designed exclusively for jacking up the vehicle at the jacking points. Otherwise, your vehicle could be damaged.
- Take ratchet ring spanner out of the vehicle tool kit and place it on the hexagon nut of the jack so that the letters **AUF** are visible.

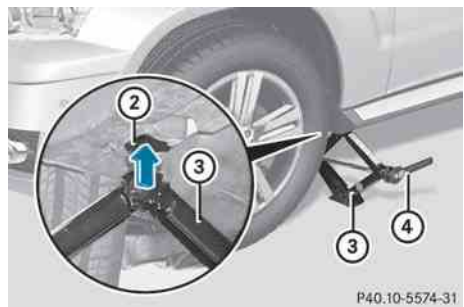

- Position jack (3) at jacking point (2).

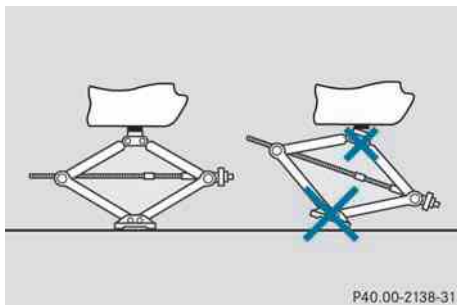

P40.00-2138-31

- ▶ Make sure that the base of the jack is positioned directly under the jacking point.
- ▶ Turn ratchet ring spanner ④ until jack ③ sits completely on jacking point ② and the base of the jack lies evenly on the ground.
- ▶ Turn ratchet ring spanner ④ until the tire is raised a maximum of 1.2 inches (3 cm) off the ground.

Removing a wheel

- ▶ Unscrew the wheel bolts.
- ❗ Do not place wheel bolts in sand or on a dirty surface. The bolt and wheel hub threads could otherwise be damaged when you screw them in.
- ▶ Remove the wheel.

Mounting a new wheel

Warning!

Always replace wheel bolts that are damaged or rusted.

Never apply oil or grease to wheel bolts.

Damaged wheel hub threads should be repaired immediately. Do not continue to drive under these circumstances! Contact an authorized Mercedes-Benz Center or call Roadside Assistance.

Incorrect wheel bolts or improperly tightened wheel bolts can cause the wheel to come off. This could cause an accident. Make sure to use the correct wheel bolts.

Warning

Only use genuine Mercedes-Benz wheel bolts. Other wheel bolts may come loose.

Do not tighten the wheel bolts when the vehicle is raised. Otherwise, the vehicle could fall off the jack.

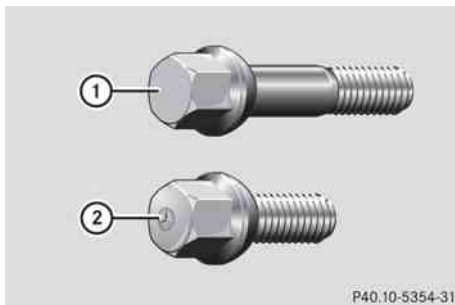

P40.10-5354-31

- ① Wheel bolts for all wheels supplied by the factory
- ② Wheel bolts for the "Minispare" emergency spare wheel
- ❗ Always use wheel bolts ② to mount the collapsible spare wheel. Using other wheel bolts to mount the collapsible spare wheel could damage the brake system.

Warning

Make sure to use the original length wheel bolts when remounting the original wheel after it has been repaired.

- ▶ Clean the wheel and wheel hub contact surfaces.
- ❗ To prevent damage to the paintwork, hold the wheel securely against the wheel hub while screwing in the first wheel bolt.



P40.10-5575-31

- ▶ Place the emergency spare wheel on the wheel hub and push it on.
- ▶ Tighten the wheel bolts until they are finger-tight.
- ▶ Inflate the collapsible spare wheel (▷ page 251).

Inflating the collapsible spare tire

Warning!

Pump up the collapsible spare wheel before lowering the vehicle. You could otherwise damage the wheel rim.

Warning!

Comply with the manufacturer's safety instructions on the sticker on the electric air pump.

Your vehicle is equipped with one of two electric air pumps:

- **Version 1:** electric air pump with pressure gauge on the air hose.
- **Version 2:** electric air pump with integrated pressure gauge.

The following description applies to both versions. Differences in the way they are used will be explained in detail.

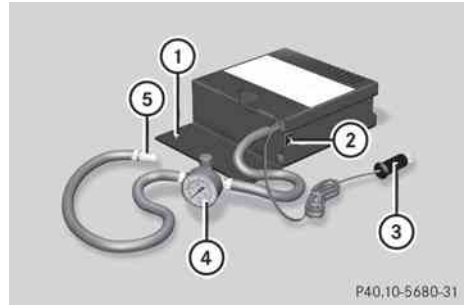

P40.10-5680-31

Version 1

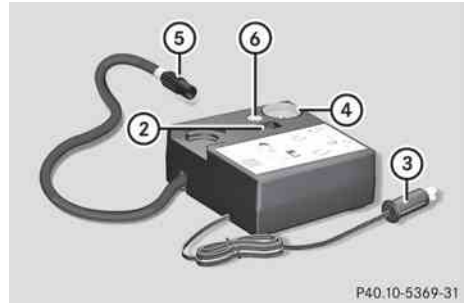

P40.10-5369-31

Version 2

- ▶ **Version 1:** open flap ①.
- ▶ **Version 1:** pull connector ③ and the air hose with pressure gauge ④ out of the housing.
- ▶ **Version 2:** pull connector ③ and the air hose out of the housing.
- ▶ **Version 1:** make sure that the pressure release screw on pressure gauge ④ is closed.
- ▶ Screw the valve cap onto the valve of the collapsible spare wheel.
- ▶ Screw union nut ⑤ on the air hose onto the valve.
- ▶ Make sure on/off switch ② of the electric air pump is set to **0**.
- ▶ Insert connector ③ into the cigarette lighter socket (▷ page 216) or into a 12 V socket (▷ page 217) in your vehicle.

- ▶ Make sure that the key is in position **1** (▷ page 129) in the ignition lock.
- ▶ Press on/off switch **2** on the electric air pump to **I**. The electric air pump is switched on. The tire is inflated.

Warning

The air hose and the union nut can become hot during inflation. Exercise proper caution to avoid burning yourself when using the equipment.

- ▶ **!** Do not operate the electric air pump for longer than eight minutes at a time without a break. It may otherwise overheat.

The air pump can be operated again once it has cooled down.

- ▶ Inflate the tires to the prescribed tire pressure. The prescribed tire pressure is stated on the yellow sticker which is affixed to emergency spare wheel.
- ▶ When the prescribed tire pressure has been attained, press on/off switch **2** on the electric air pump to **0**. The electric air pump is switched off.
- ▶ Turn the key to position **0** in the ignition lock.
- ▶ **Version 1:** if the tire pressure is higher than specified, open the pressure release screw on pressure gauge **4** until the correct tire pressure is set.
- ▶ **Version 2:** if the tire pressure is higher than specified, press pressure release button **6** until the correct tire pressure is set.
- ▶ Unscrew union nut **5** of the air hose from the valve.
- ▶ Screw the valve cap onto the valve of the collapsible spare wheel again.
- ▶ **Version 1:** stow connector **3** and the air hose behind flap **1**.

- ▶ **Version 2:** stow connector **3** and the air hose in the lower section of the pump housing.
- ▶ Stow the electric air pump in the designated place in the vehicle.

Lowering the vehicle

Warning!

Pump up the collapsible spare wheel before lowering the vehicle. You could otherwise damage the wheel rim.

- ▶ Place the ratchet ring spanner onto the hexagon nut of the jack so that the letters **AB** are visible.
- ▶ Turn the ratchet ring spanner until the vehicle is once again standing firmly on the ground.
- ▶ Place the jack to one side.

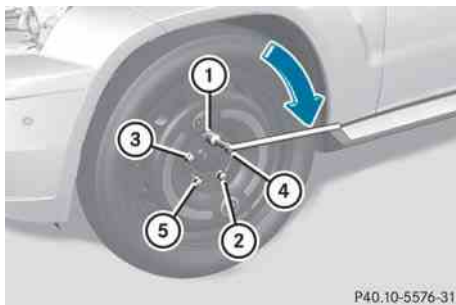

- ▶ Tighten the wheel bolts evenly in a crosswise pattern in the sequence indicated (**1** to **5**). The tightening torque must be **110 lb-ft (150 Nm)**.

Warning!

Have the tightening torque checked immediately after a wheel is changed. The wheels could come loose if they are not tightened to a torque of **110 lb-ft (150 Nm)**.

- ▶ Turn the jack back to its initial position and store it together with the rest of the vehicle tool kit in the cargo compartment.

- ▶ Transport the faulty wheel in the cargo compartment.

Further information on stowing the collapsible spare wheel (▶ page 246).

- i** When you are driving with the collapsible spare wheel mounted, the tire pressure loss warning system or the tire pressure monitor cannot function reliably. Only restart the tire pressure loss warning system/tire pressure monitor when the defective wheel has been replaced with a new wheel.

Vehicles with tire pressure monitor: all mounted wheels must be equipped with functioning sensors and the defective wheel should no longer be in the vehicle.

Battery

Important safety notes

In order for the battery to achieve the maximum possible service life, it must always be sufficiently charged.

- !** Have the battery checked regularly at a qualified specialist workshop, e.g. an authorized Mercedes-Benz Center. Observe the service intervals in the Service Booklet or for further information consult a qualified specialist workshop, e.g. an authorized Mercedes-Benz Center.

Have the battery charge checked more frequently if you use the vehicle mainly for short trips or if you leave it standing idle for a lengthy period.

To prevent damage from corrosion, only replace the battery with one that has a central ventilation cover.

Only replace a battery with a battery that has been recommended by Mercedes-Benz.

Consult an authorized Mercedes-Benz Center if you wish to leave your vehicle parked up for a long period of time.

Warning

Comply with safety precautions and take protective measures when handling batteries.



Risk of explosion



Fire, naked flames and smoking are prohibited when handling the battery. Avoid creating sparks.



Battery acid is caustic. Avoid contact with the skin, eyes or clothing.

Wear suitable protective clothing, in particular gloves, an apron and a face mask.

Immediately rinse acid splashes off with clean water. Consult a doctor if necessary.

Wear eye protection.



Keep children away.



Observe this Operator's Manual.

Environmental note

Do not dispose of batteries in the household rubbish. Dispose of defective batteries in an environmentally responsible manner. Take them to an authorized Mercedes-Benz Center or to a special collection point for old batteries.

Warning

Failure to follow these instructions can result in severe injury or death.

Never lean over batteries while connecting. You might get injured.

Battery fluid contains sulfuric acid. Do not allow this fluid to come in contact with eyes, skin or clothing. In case it does, immediately flush affected area with water and seek medical help if necessary.

A battery will also produce hydrogen gas, which is flammable and explosive. Keep flames or sparks away from battery, avoid improper connection of jumper cables, smoking etc.

Warning

Do not place any metal objects on the battery as this could result in a short circuit.

Use leak-proof batteries only to avoid the risk of acid burns in the event of an accident.

Take care that you do not become statically charged, e.g. by wearing synthetic clothing or rubbing against textiles. For this reason, you also should not pull or push the battery over carpets or other synthetic materials.

Never touch the battery first. First, touch the outside body of the vehicle in order to release any possible electrostatic charges.

Do not rub the battery with rags or cloths. The battery could explode if touched due to electrostatic charge or due to spark formation.

! Switch off the engine and remove the key before disconnecting the terminal clamps from the battery. On vehicles with KEYLESS-GO, make sure that the ignition is switched off. Check that all the indicator lamps in the instrument cluster are off. You may otherwise destroy electronic components, such as the alternator.

! Like other batteries, the vehicle battery may discharge over time if you do not use the vehicle. In this case, have the battery disconnected at a qualified specialist workshop, e.g. an authorized Mercedes-Benz Center. You can also charge the battery with a charger recommended by

Mercedes-Benz. Contact an authorized Mercedes-Benz Center for further information.

The battery, breather hose and cover of the positive terminal clamp must be installed securely during operation.

i Remove the key if you park the vehicle and do not require any electrical consumers. The vehicle will then use very little energy, thus conserving battery power.

Mercedes-Benz recommends that you do not carry out work on batteries yourself, e.g. removing, charging or replacing. Always have this work performed at a qualified specialist workshop, e.g. an authorized Mercedes-Benz Center.

i If the power supply has been interrupted, e.g. if the battery has been reconnected, you must carry out the following tasks:

- set the clock (> page 171).
- reset the panorama roof with power tilt/sliding panel (> page 87).
- reset the function for automatically folding the exterior mirrors in/out by folding the mirrors out once (> page 98).

Charging the battery

Warning

Never charge a battery while still installed in the vehicle unless the accessory battery charge unit approved by Mercedes-Benz is being used. Gases may escape during charging and cause explosions that may result in paint damage, corrosion or personal injury.

An accessory battery charge unit specially adapted for Mercedes-Benz vehicles and tested and approved by Mercedes-Benz is available. It permits the charging of the battery in its installed position. Contact an

authorized Mercedes-Benz Center for information and availability.



Charge the battery in accordance with the separate instructions for the accessory battery charger.

 **Warning!**

There is a risk of acid burns during the charging process due to the gases which escape from the battery. Do not lean over the battery during the charging process.

 **Warning!**

Battery acid is caustic. Avoid contact with the skin, eyes or clothing.

-  Only charge the installed battery with a battery charger which has been tested and approved by Mercedes-Benz. These battery chargers allow the battery to be charged while still installed.
-  Only use battery chargers with a maximum charging voltage of 14.8 V.
-  Only charge the battery using the jump-starting connection point.

The jump-starting connection point is in the engine compartment (▷ page 256).

- ▶ Open the hood (▷ page 232).
- ▶ Connect the battery charger to the positive terminal and earth point in the same order as when connecting the donor battery in the jump-starting procedure (▷ page 256).

Jump-starting

 Warning

Failure to follow these directions will cause damage to the electronic components, and can lead to a battery explosion and severe injury or death.

Never lean over batteries while connecting or jump starting. You might get injured.

Battery fluid contains sulfuric acid. Do not allow this fluid to come in contact with eyes, skin or clothing. In case it does, immediately flush affected area with water, and seek medical help if necessary.

A battery will also produce hydrogen gas, which is flammable and explosive. Keep flames or sparks away from battery, avoid improper connection of jumper cables, smoking, etc.

Attempting to jump start a frozen battery can result in it exploding, causing personal injury.

Read all instructions before proceeding.

! Avoid repeated and lengthy starting attempts. Otherwise, non-combusted fuel may damage the catalytic converter³¹ and create a risk of fire.

Do not use a rapid-charging device to start the engine.

Make sure the jumper cables are not damaged.

Make sure the jumper cables are not touching any other metal objects when they are connected to the battery.

If your vehicle's battery is discharged, the engine can be jump-started from another vehicle or from a second battery using jumper cables.

Observe the following points:

- ▶ The battery is not accessible in all vehicles. If the other vehicle's battery is not accessible, jump-start the vehicle using a second battery or a jump-starting device.
- ▶ Only jump-start the vehicle when the engine is cold and the catalytic converter system has cooled down³².
- ▶ Do not start the engine if the battery is frozen. Let the battery thaw first.
- ▶ Jump-starting may only be performed from batteries with a nominal voltage of 12 V. If you jump-start using a battery with higher voltage, it may damage the electrical systems of the vehicle.
- ▶ Only use jumper cables which have a sufficient cross-section and insulated terminal clamps.
- ▶ Make sure that the jumper cables cannot come into contact with parts, such as the pulley or the fan. These parts move when the engine is started and while it is running.
- ▶ If the battery is fully discharged, leave the battery that is being used to jump-start connected for a few minutes before attempting to start. This charges the battery a little.

i Jumper cables and further information about jump-starting can be obtained from any authorized Mercedes-Benz Center.

- ▶ Make sure that the two vehicles do not touch.
- ▶ Apply the parking brake firmly.

³¹ Only vehicles with a gasoline engine.

³² Only vehicles with a gasoline engine.

- ▶ Move the selector lever to **P**.
- ▶ Switch off all electrical consumers (e.g. radio, blower etc.).
- ▶ Open the hood (> page 232).

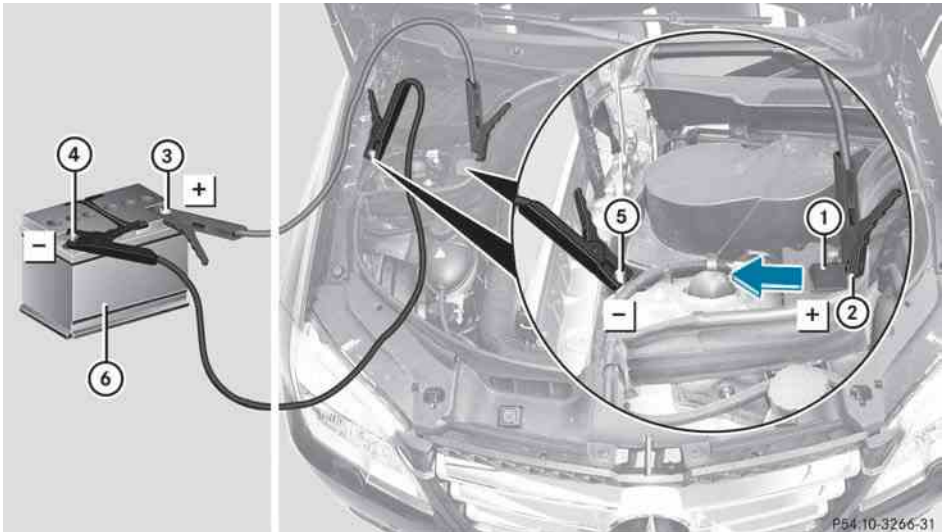

Position number ⑥ identifies the charged battery of the other vehicle or an equivalent jump-starting device.

! Never swap the terminal connections.

- ▶ Slide cover ① of positive terminal ② in the direction of the arrow.
- ▶ Connect positive terminal ② on your vehicle to positive terminal ③ of donor battery ⑥ using the jumper cable, beginning with your own battery.
- ▶ Start the engine of the donor vehicle and run it at idling speed.
- ▶ Connect negative terminal ④ of donor battery ⑥ to earth point ⑤ of your vehicle using the jumper cable, connecting the jumper cable to donor battery ⑥ first.
- ▶ Start the engine.
- ▶ First remove the jumper cable from earth point ⑤ and negative terminal ④, then from positive terminal ② and positive terminal ③, each time disconnecting from the battery on your own vehicle first.
- ▶ Have the battery checked at a qualified specialist workshop, e.g. an authorized Mercedes-Benz Center.

Towing and tow-starting

Important safety notes

Warning

If you tow the vehicle, you must use a rigid towing bar if:

- the engine will not run.
- there is a malfunction in the brake system.
- there is a malfunction in the power supply or the vehicle's electrical system.

With the engine not running, there is no power assistance for the brake and steering systems. You will then need considerably more force to steer and to brake and the brake pedal travel will be longer. If necessary, depress the brake pedal with maximum force.

Before towing away, make sure that the steering can be moved and is not locked.

If you tow or tow-start another vehicle, its weight must not exceed the maximum permissible gross vehicle weight of your vehicle.

It is better to have the vehicle transported than to have it towed.

- !** You may only tow the vehicle a maximum distance of 30 miles (50 km). A towing speed of 30 mph (50 km/h) must not be exceeded.

For towing distances over 30 miles (50 km), the vehicle must be loaded onto a transporter.

- !** Only secure the tow rope or tow bar at the towing eyes. Otherwise, the vehicle could be damaged.
- !** Do not use the towing eye for recovery, as this could damage the vehicle. If in doubt, recover the vehicle with a crane.
- !** Drive slowly and smoothly when towing. Excessive tractive power could otherwise damage the vehicles.
- !** Do not tow with sling-type equipment. This could damage the vehicle.

- !** On vehicles with KEYLESS-GO, use the SmartKey instead of the Start/Stop button. Turn the SmartKey to position **2** in the ignition lock and shift the automatic transmission to **N**. Then, turn the SmartKey back to **0** and leave it in the ignition lock.

- !** Vehicles with automatic transmission must not be started by tow-starting. This could otherwise damage the transmission.

- !** Vehicles with 4MATIC must not be towed with the front or rear axle raised. This could otherwise damage the transmission.

The automatic transmission must be in position **N** while the vehicle is being towed. The battery must be connected and charged. Otherwise:

- you will not be able to turn the SmartKey to position **2** in the ignition lock.
- you will not be able to shift the automatic transmission to position **N**.

Vehicles with automatic transmission: manually release the selector lever lock in position **P** (▷ page 139).

- i** Switch the automatic lock (▷ page 173) off before towing. Otherwise, you could lock yourself out of the vehicle when pushing or towing the vehicle.

Installing/removing the towing eye

Installing the towing eye

Vehicles with a trailer tow hitch: if possible, fasten the towing mechanism to the trailer tow hitch (▷ page 156).

- ▶ Remove the towing eye from the vehicle tool kit (▷ page 245).

Warning

The exhaust tail pipe may be hot. You could burn yourself if you touch the tail pipe. Be particularly careful when removing the rear cover.

The mountings for the removable towing eyes are located in the bumpers. They are at the front and at the rear, behind the covers.



Vehicles without the AMG Sports package



Vehicles with the AMG Sports package

- ▶ Press the mark on cover ① inwards, in the direction of the arrow.

Rear bumper on vehicles with AMG Sports package: pry cover ① out of the bumper by inserting a blunt, rounded object into the recess.

- ▶ Take cover ① off the opening.
- ▶ Screw in and tighten the towing eye clockwise to the stop.

Removing the towing eye

- ▶ Unscrew and remove the towing eye.

- ▶ Attach cover ① to the bumper and press until it engages.
- ▶ Place the towing eye in the vehicle tool kit.

Towing the vehicle with the rear axle raised

Only possible for vehicles without 4MATIC.

When having your vehicle towed with the rear axle raised, observe the important safety notes (▷ page 258).

- ⚠ The ignition must be switched off if you are towing the vehicle with the rear axle raised. Intervention by ESP® could otherwise damage the brake system.

- ▶ Switch on the hazard warning flashers (▷ page 105).
- ▶ Turn the SmartKey to position **0** in the ignition lock and remove the SmartKey.
- ▶ When leaving the vehicle, take the SmartKey or the KEYLESS-GO key with you.

Towing the vehicle with both axles on the ground

When having your vehicle towed, observe the important safety notes (▷ page 258).

Warning

With the engine not running, there is no power assistance for the brake and steering systems. In this case, it is important to keep in mind that a considerably higher degree of effort is necessary to brake and steer the vehicle. Adapt your driving accordingly.

- ▶ Turn the SmartKey to position **2** in the ignition lock.
- ▶ When the vehicle is stationary, depress the brake pedal and hold it down.
- ▶ Release the brake pedal.

- ▶ Release the parking brake.
 - ▶ Switch on the hazard warning flashers (▷ page 105).
- i** When towing with the hazard warning flashers switched on, use the combination switch as usual to signal in which direction you are changing. In this case, only the indicator lamps for the direction of travel flash. When you reset the combination switch, the hazard warning flashers start flashing again.

Transporting the vehicle

The towing eyes or trailer tow hitch can be used to pull the vehicle onto a trailer or transporter if you wish to transport it.

- ▶ Turn the SmartKey to position **2** in the ignition lock.
- ▶ Shift the selector lever to **N**.

As soon as the vehicle has been loaded:

- ▶ Prevent the vehicle from rolling away by applying the parking brake.
- ▶ Move the selector lever to **P**.
- ▶ Turn the SmartKey to position **0** in the ignition lock and remove the SmartKey.
- ▶ Secure the vehicle.

! Only lash the vehicle down by the wheels or wheel rims, not by parts of the vehicle such as axle or steering components. Otherwise, the vehicle could be damaged.

Notes on 4MATIC vehicles

! Vehicles with 4MATIC must not be towed with either the front or the rear axle raised, as doing so will damage the transmission.

If the vehicle's transmission, front, or rear axle is damaged, have the vehicle transported on a truck or trailer.

In the event of damage to the electrical system

If the battery is defective, the automatic transmission will be locked in position **P**. To shift the automatic transmission to position **N**, you must provide power to the vehicle's electrical system in the same way as when jump-starting (▷ page 256).

Have the vehicle transported on a transporter or trailer.

Recovering a vehicle that has become stuck

! Pull away smoothly, slowly, and in a straight line when pulling out a vehicle that has become stuck. Excessive tractive power could damage the vehicles.

If the drive wheels have become stuck in loose or muddy ground, pull the vehicle out with extreme caution, particularly if it is laden.

Never attempt to recover a stuck vehicle with a trailer attached.

Pull out the vehicle backwards, if possible using the tracks it made when it became stuck.

Fuses

Important safety notes

The fuses in your vehicle serve to close down faulty circuits. If a fuse blows, all the components on the circuit and their functions will fail.

Warning

Only use fuses approved by Mercedes-Benz with the specified amperage for the system in question and do not attempt to repair or bridge a blown fuse. Using other than approved fuses or using repaired or bridged fuses may cause an overload leading to a fire, and/or cause damage to electrical components and/or systems. Have the cause

determined and remedied by an authorized Mercedes-Benz Center.

Blown fuses must be replaced with fuses of the same rating, which you can recognize by the color and value. The fuse ratings are listed in the fuse allocation chart. An authorized Mercedes-Benz Center will be happy to advise you.

- i** If a fuse has blown, visit a breakdown service or an authorized Mercedes-Benz Center.

If the newly inserted fuse also blows, have the cause traced and rectified at a qualified specialist workshop, e.g. an authorized Mercedes-Benz Center.

- !** Only use fuses that have been approved for Mercedes-Benz vehicles and which have the correct fuse rating for the system concerned. Otherwise, components or systems could be damaged.

Before changing a fuse

- ▶ Park the vehicle and apply the parking brake.
- ▶ Switch off all electrical consumers.
- ▶ Remove the key from the ignition lock.

The fuses are located in various fuse boxes:

- fuse box on the driver's side of the dashboard
- fuse box in the engine compartment on the left-hand side of the vehicle, when viewed in the direction of travel
- fuse box in the stowage well under the trunk floor on the right-hand side of the vehicle, when viewed in the direction of travel

The fuse allocation chart is located in the vehicle tool kit (> page 245) in the stowage compartment under the trunk floor.

Fuse box in the cockpit

- !** Do not use a pointed object such as a screwdriver to open the cover in the dashboard. You could damage the dashboard or the cover.

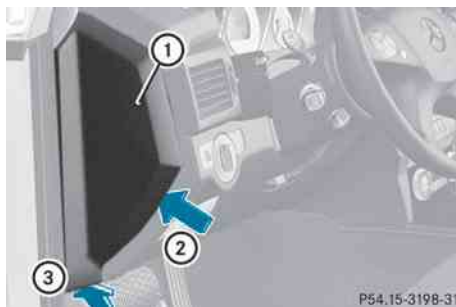

- ▶ **To open:** pull out cover ① slightly at the bottom in the direction of arrow ③.
- ▶ Pull cover ① outwards in the direction of arrow ② and remove it.
- ▶ **To close:** clip in cover ① on the front of the dashboard.
- ▶ Fold cover ① inwards until it engages.

Fuse box in the engine compartment

- ▶ Make sure that the windshield wipers are turned off.

⚠ Risk of injury

Make sure that the windshield wipers are turned off and the key is pulled out of the ignition lock before you open the cover of the fuse box. Otherwise, the windshield wipers and the wiper rods above the cover could be set in motion. This could lead to you or others being injured by the wiper rods.

- ▶ Open the hood (> page 232).

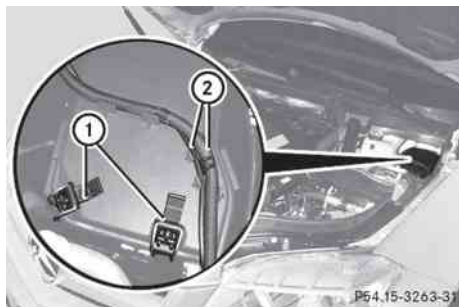

- ▶ **To open:** lift up trunk floor ②
(▷ page 212).
- ▶ Remove stowage compartment ①.
- ▶ Open cover ③ of fuse box downwards.

- ▶ Remove any existing moisture from the fuse box using a dry cloth.
- ▶ Take lines ② from the guides.
- ▶ **To open:** open clamps ①.
- ▶ Remove the fuse box cover forwards.
- ▶ **To close:** check whether the rubber seal is lying correctly in the cover.
- ▶ Insert the cover at the rear of the fuse box into the retainer.
- ▶ Fold down the cover and close clamps ①.
- ▶ Secure lines ② in the guides.

! The cover must be seated properly, otherwise moisture or dirt could impair the function of the fuses.

- ▶ Close the hood (▷ page 233).

Fuse box in the cargo compartment

- ▶ Open the tailgate.

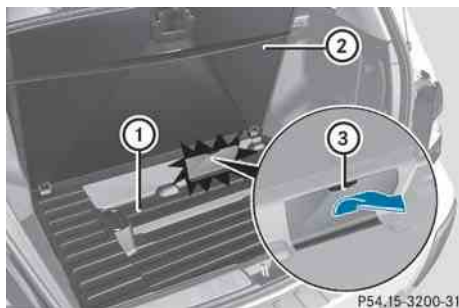

Vehicle equipment	264
Important safety notes	264
Directives to be observed	265
Maintenance and care of wheels and tires	265
Tire pressures	266
Loading the vehicle	274
Maximum tire load	278
Direction of rotation	278
Uniform Tire Quality Grading Standards	278
Interchanging the wheels	280
Tire labeling	280
Definitions for tires and loading	284
Wheel/tire combinations	287

Vehicle equipment

i This manual describes all the standard and optional equipment of your vehicle which was available at the time of purchase. Country-specific differences are possible. Bear in mind that your vehicle may not feature all functions described here. This also refers to safety-related systems and functions.

Important safety notes

Contact an authorized Mercedes-Benz Center if you require information on tested and recommended tires and wheels for summer and winter driving. Advice on purchasing and caring for tires is also available there.

Warning

Replace rims or tires with the same designation, manufacturer and type as shown on the original part. For further information contact an authorized Mercedes-Benz Center. If incorrectly sized rims and tires are mounted, the wheel brakes or suspension components can be damaged. Also, the operating clearance of the wheels and the tires may no longer be correct.

Warning

Worn, old tires can cause accidents. If the tire tread is worn to minimum tread depth, or if the tires have sustained damage, replace them.

When replacing rims, only use genuine Mercedes-Benz wheel bolts specified for the particular rim type. Failure to do so can result in the bolts loosening and possibly an accident.

Retreaded tires are not tested or recommended by Mercedes-Benz, since previous damage cannot always be recognized on retreads. The operating safety of the vehicle cannot be assured when such tires are used.

Warning

If you feel a sudden significant vibration or ride disturbance, or you suspect that possible damage to your vehicle has occurred, you should turn on the hazard warning flashers, carefully slow down, and drive with caution to an area which is a safe distance from the road. Inspect the tires and the vehicle underbody for possible damage. If the vehicle appears unsafe, have the vehicle towed to the nearest authorized Mercedes-Benz Center or tire dealer for repairs.

Warning

Do not drive with a flat tire. A flat tire affects the ability to steer or brake the vehicle. You might lose control of the vehicle. Continued driving with a flat tire or driving at high speed with a flat tire will cause excessive heat build-up and possibly a fire.

i For safety reasons, Mercedes-Benz recommends that you only use tires, wheels and accessories which have been approved by Mercedes-Benz specifically for your vehicle. These tires have been specially adapted for use with the control systems, such as ABS or ESP®, and are marked as follows:

- MO = Mercedes-Benz Original
- MOE = Mercedes-Benz Original Extended (tires with run-flat characteristics)
- MO1 = Mercedes-Benz Original (AMG)

Only use Mercedes-Benz Original Extended tires on wheels that have been specifically approved by Mercedes-Benz.

If you use other tires, wheels and accessories, Mercedes-Benz cannot accept any responsibility for damage that may result from this. Further information about tires, wheels and approved combinations can be obtained from any authorized Mercedes-Benz Center.

i Further information about tires and wheels can be obtained from any authorized Mercedes-Benz Center.

Directives to be observed

- Only mount tires and wheels of the same type and make.
- Only mount tires of the correct size onto the wheels.
- After mounting new tires, run them in at moderate speeds for the first 60 miles (100 km) as they only reach their full performance after this distance.
- Do not use tires until they are excessively worn as the tire traction on wet road surfaces decreases significantly when the tread depth is less than $\frac{1}{8}$ in (3 mm).
- If the vehicle is heavily laden, check the tire pressure and adjust it if necessary.
- When parking your vehicle, make sure that the tires do not get deformed by the curb or other obstacles. If it is necessary to drive over curbs, speed humps or similar elevations, try to do so slowly and at an obtuse angle. Otherwise, the tires, particularly the sidewalls, can get damaged.

Maintenance and care of wheels and tires

Checking wheels and tires

Warning

Regularly check the tires for damage. Damaged tires can cause tire inflation pressure loss. As a result, you could lose control of your vehicle.

Worn, old tires can cause accidents. If the tire tread is worn to minimum tread depth, or if the tires have sustained damage, replace them.

- Regularly check the wheels and tires of your vehicle for damage (e.g. cuts, punctures, tears, bulges on tires and deformation or cracks or severe corrosion on wheels), at least once a month, as well as after driving off-road or on rough roads.

Damaged wheels can cause a loss of tire pressure.

- Regularly check the tire tread depth and the condition of the tread across the whole width of the tire (▷ page 265). If necessary, turn the front wheels to full lock in order to inspect the inner side of the tire surface.
- All wheels must have a valve cap to protect the valve against dirt and moisture. Do not install anything on the valve (such as tire pressure monitoring systems) other than the standard valve cap or other valve caps approved by Mercedes-Benz for your vehicle.
- Regularly check the pressure of all the tires including the emergency spare wheel or the spare wheel, particularly prior to long trips, and correct the pressure as necessary (▷ page 266).

Service life of tires

The service life of tires depends on the following factors amongst other things:

- driving style
- tire pressure
- mileage

Replace the tires after six years at the latest, regardless of wear. This also applies to the emergency spare wheel/spare wheel.

Tire tread

Warning

Although the applicable federal motor vehicle safety laws consider a tire to be worn when the tread wear indicators (TWI) become visible at approximately $\frac{1}{16}$ in (1.6 mm), we recommend that you do not allow your tires to wear down to that level. As tread depth approaches $\frac{1}{8}$ in (3 mm), the adhesion properties on a wet road are sharply reduced.

Depending upon the weather and/or road surface (conditions), the tire traction varies widely.

Do not use tires until they are excessively worn as the tire traction on wet road surfaces decreases significantly when the tread depth is less than $\frac{1}{8}$ in (3 mm).

Tread wear indicators (TWI) are required by law. Six indicators are positioned over the tire tread. They are visible as soon as a tread depth of approximately $\frac{1}{16}$ in (1.6 mm) is reached. If this is the case, the tire is so worn that it must be replaced.

The recommended tread depth for summer tires is at least $\frac{1}{8}$ in (3 mm). The recommended tread depth for winter tires is at least $\frac{1}{6}$ in (4 mm).

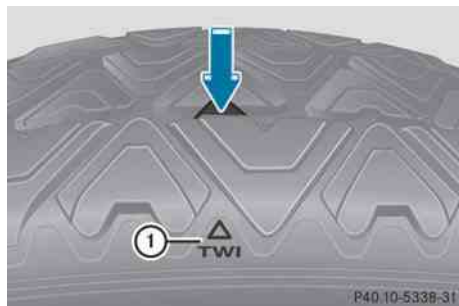

Bar marking ① for tread wear is integrated into the tire tread.

Storing tires

Store tires that are not being used in a cool, dry and preferably dark place. Protect the tires from contact with oil, grease and fuel.

Cleaning tires

⚠ Warning

Do not use power washers with circular jet nozzles (concentrated-power jets) to clean your vehicle, especially for cleaning tires. You

could otherwise damage the tires and cause an accident.

Tire pressures

Recommended tire pressures

⚠ Warning

Follow recommended tire inflation pressures.

Do not underinflate tires. Underinflated tires wear excessively and/or unevenly, adversely affect handling and fuel economy, and are more likely to fail from being overheated.

Do not overinflate tires. Overinflated tires can adversely affect handling and ride comfort, wear unevenly, increase stopping distance, and result in sudden deflation (blowout) because they are more likely to become punctured or damaged by road debris, potholes etc.

Do not overload the tires by exceeding the specified load limit as indicated on the Tire and Loading Information placard on the driver's door B-pillar. Overloading the tires can overheat them, possibly causing a blowout. Overloading the tires can also result in handling or steering problems, or brake failure.

You will find a table of recommended tire pressures on the Tire and Loading Information placard on the B-pillar on the driver's side (> page 274). You will find a table of tire pressures for various operating conditions on the inside of your vehicle's fuel filler flap.

Use a suitable pressure gauge. The outer appearance of a tire does not permit any reliable conclusion about the tire pressure. On vehicles equipped with the electronic tire pressure monitor, the tire pressure can be checked using the on-board computer.

⚠ Warning

Should the tire pressure drop repeatedly:

- check the tire for foreign bodies.
- check whether the wheel is losing air or the valve is leaking.
- make sure that only a valve cap approved by Mercedes-Benz is installed on the tire valve.

Tire pressures that are too low have a negative effect on vehicle safety, which could lead you to cause an accident.

Only correct tire pressures when the tires are cold. The tires are cold when the vehicle has been parked for at least three hours or driven for less than 1 mile (1.6 km). The tire temperature changes depending on the outside temperature, the vehicle speed and the tire load. If the tire temperature changes by 18 °F (10 °C), the tire pressure changes by approximately 10 kPa (0.1 bar/ 1.5 psi). Take this into account when checking the pressure of warm tires and only correct the tire pressure if it is too low for the current operating conditions. If you check the tire pressure when the tires are warm, the reading will be higher than if the tires were cold. This is normal. Do not reduce the tire pressure to the value specified for cold tires. The tire pressure would otherwise be too low. Observe the recommended tire pressure specifications for cold tires on the Tire and Loading Information placard on the B-pillar on the driver's side.

i The specifications given on the following Tire and Loading Information placard are examples. Tire pressure specifications are vehicle-specific and may deviate from the data shown here. The tire pressure specifications for your vehicle can be found on the Tire and Loading Information placard of your vehicle.

TIRE		LOADING INFORMATION	
RENSEIGNEMENTS		SUR LES PNEUS ET LE CHARGEMENT	
SEATING CAPACITY CAPACITE DE SIEGES	7	FRONT AVANT	200 KPA, 29 PSI
FRONT AVANT	255/40 ZR18 99Y XL	MIDDLE MILIEU	200 KPA, 29 PSI
REAR ARRIERE	285/35 ZR18 101Y XL	REAR ARRIERE	200 KPA, 29 PSI
SINRE DE RECHANGE	175/55-16 99P	SPARE DE RECHANGE	420 KPA, 40 PSI

SEE OWNERS MANUAL FOR ADDITIONAL INFORMATION

P40.00-2133-31

You will find recommended tire pressure specifications **1** for cold tires and for a fully loaded vehicle on the Tire and Loading Information placard. The tire pressure specifications apply to tires which are installed at the factory.

Important notes on tire pressures

Warning

If the tire pressure drops repeatedly, check the tires for punctures from foreign objects and/or whether air is leaking from the valves or from around the rim.

The temperature and pressure of the tires increase when the vehicle is in motion. This is dependent on the driving speed and the load.

If you wish to drive at high speeds of 100 mph (160 km/h) or higher when this is allowed, use the tire pressure table on the inside of the fuel filler flap to set the correct tire pressures when the wheels are cold. If the tire pressure is not set correctly, this can lead to an excessive build up of heat and a sudden loss of pressure.

For more information, contact a qualified specialist workshop, e.g. an authorized Mercedes-Benz Center.

i Ride comfort may be affected if the tire pressure is adjusted to the recommended value for speeds of over 100 mph (160 km/h).

Make sure that the tire pressure for normal speeds is adopted again.

Additional specifications of tire pressure values for loads can also be found on the tire pressure table on the inside of the fuel filler flap.

The tire pressure for emergency spare wheels can be found:

- on the yellow label on the wheel rim of the emergency spare wheel
- in the "Wheel and tire combinations" section (▷ page 287) of this Operator's Manual
- on the Tire and Loading Information placard on the B-pillar on the driver's side

i The specifications shown in the examples in the tire pressure tables are only examples. Tire pressure specifications are vehicle-specific and may deviate from the data shown here. The tire pressure specifications that are valid for your vehicle can be found on your vehicle's tire pressure table.

The tire pressures in the tire pressure table on the inside of the fuel filler flap are valid for all approved tires installed at the factory, unless stated otherwise.

COLD TIRE PRESSURE			
normal load			
maximum load			
Warm tires up to: + 4 psi			

P40.00-2179-31

Tire pressure table for all approved tires installed at the factory (example)

If the tire pressure precedes a tire size, the tire pressure specification is only valid for this tire size. The vehicle loading conditions "partially laden" or "fully laden" are specified using a differing number of persons and

luggage in the table. The actual number of seats may differ from this.

LUFTDRUCK PRESSURE PRESSION PRESSION			
für kalte Reifen		for cold tires	
des pneus froids		de inflado	
100 kPa = 1 bar			
195/55 R16			
215/45 R17			
215/40 R18			
Warme Reifen: Warm tires up to:		Pneus chauffés jusqu'à: Neumáticos calientes hasta:	
+ 30 kPa + 4 psi		+ 30 kPa + 4 psi	

P40.00-2183-31

Tire pressure table with tire sizes (example)

Some tire pressure tables only show the rim diameter instead of the complete tire size, e.g. **R18**. The rim diameter is a component of the tire size and can be read from the tire sidewall (▷ page 281).

Luftdruck für kalte Reifen			
Tire pressure cold tires		Pression des pneus froids	
Pressão de inflado			
100 kPa = 1 bar			
R18			
R19			
bis up to: hasta: hasta:		Winter tires: Pneus hiver: Neumáticos de invierno:	
240 km/h 150 mph		+ 30 kPa + 4 psi	
Warme Reifen bis: Warm tires up to:		Pneus chauffés jusqu'à: Neumáticos calientes hasta:	
+ 30 kPa + 4 psi		+ 30 kPa + 4 psi	

P40.00-2184-31

i For vehicles towing a trailer, the fully laden value on the tire inflation pressure label located on the inside of the fuel filler flap is valid for the rear axle.

Tire pressure too low or too high

Underinflated tires

Warning

Follow recommended tire inflation pressures. Do not underinflate tires. Underinflated tires wear excessively and/or unevenly, adversely affect handling and fuel economy, and are more likely to fail from being overheated.

Underinflated tires can:

- wear excessively and/or unevenly
- adversely affect fuel economy
- fail from being overheated
- adversely affect handling

Overinflated tires can:

Warning

Follow recommended tire inflation pressures.

Do not overinflate tires. Overinflated tires can adversely affect handling and ride comfort, wear unevenly, increase stopping distance, and result in sudden deflation (blowout) because they are more likely to become punctured or damaged by road debris, potholes etc.

Overinflated tires can:

- adversely affect handling
- wear excessively and/or unevenly
- be more likely to become damaged
- adversely affect ride comfort
- increase stopping distance

Checking tire pressures

Important safety notes

Warning

Follow recommended tire inflation pressures.

Do not underinflate tires. Underinflated tires wear excessively and/or unevenly, adversely affect handling and fuel economy, and are more likely to fail from being overheated.

Do not overinflate tires. Overinflated tires can adversely affect handling and ride comfort, wear unevenly, increase stopping distance, and result in sudden deflation (blowout) because they are more likely to become punctured or damaged by road debris, potholes etc.

Do not overload the tires by exceeding the specified load limit as indicated on the Tire

and Loading Information placard on the driver's door B-pillar. Overloading the tires can overheat them, possibly causing a blowout. Overloading the tires can also result in handling or steering problems, or brake failure.

Check the tire pressure at least once a month.

Only check and correct tire pressures when the tires are cold (▷ page 266).

Checking the tire pressures manually

In order to determine and adjust the tire pressures, proceed as follows:

- ▶ Remove the valve cap of the tire you wish to check.
- ▶ Press the tire pressure gauge securely onto the valve.
- ▶ Read the tire pressure and compare it with the recommended value on the Tire and Loading Information placard on the B-pillar on the driver's side of your vehicle.
- ▶ If necessary, increase the tire pressure to the recommended value (▷ page 266).
- ▶ If the tire pressure is too high, release air by pressing down the metal pin in the valve using the tip of a pen, for example. Then, check the tire pressure again using the tire pressure gauge.
- ▶ Screw the valve cap onto the valve.
- ▶ Repeat the steps for the other tires.

Tire pressure loss warning system (Canada only)

Important safety notes

While the vehicle is in motion, the tire pressure loss warning system monitors the set tire pressure using the rotational speed of the wheels. This enables the system to detect significant pressure loss in a tire. If the speed of rotation of a wheel changes as a result of a loss of pressure, a corresponding warning

message will appear in the multifunction display.

Warning

If the Check Tire Pressure Soon message appears in the multifunction display, one or more tires are significantly underinflated. Stop the vehicle as soon as possible and inflate the tires to the pressure specified on the vehicle's Tire and Loading Information placard or (where available) in the tire pressure table.

Driving on a significantly underinflated tire causes the tire to overheat and can lead to tire failure. Underinflation also reduces fuel efficiency and tire tread life, and may affect the vehicle's handling and stopping ability.

Check all tires when cold, including the spare tire, at least once a month. The tires should be inflated to the recommended pressure.

This information can be found:

- on the Tire and Loading Information placard on the B-pillar on the driver's side or
- in the table for the tire pressure on the inside of the fuel filler flap

Warning!

The tire pressure loss warning system does not provide a warning for wrongly selected tire inflation pressures. Always adjust tire inflation pressure according to the Tire and Loading Information placard on the driver's door B-pillar or on the tire inflation pressure label located on the inside of the fuel filler flap.

The tire pressure loss warning system does not replace regular checks of the tire inflation pressures since a gradual pressure loss in more than one tire cannot be detected by the tire pressure loss warning system.

The tire pressure loss warning system is not able to issue a warning due to a sudden dramatic loss of tire inflation pressure (e.g. tire blowout caused by a foreign object). In this case bring the vehicle to a halt by carefully

applying the brakes and avoiding abrupt steering maneuvers.

The function of the tire pressure loss warning system is limited or delayed if:

- snow chains are mounted on your vehicle.
- road conditions are wintry.
- you are driving on sand or gravel.
- you adopt a very sporty driving style (cornering at high speeds or driving with high rates of acceleration).
- you are towing a very heavy or large trailer.
- you are driving with a heavy cargo (in the vehicle or on the roof).

Restarting the tire pressure loss warning system

Restart the tire pressure loss warning system if you have:





- changed the tire pressure
 - changed the wheels or tires
 - mounted new wheels or tires
- Before restarting, refer to the Tire and Loading Information placard on the B-pillar on the driver's side or the tire pressure table on the inside of the fuel filler flap to ensure the tire pressure in all four tires is set correctly for the current operating conditions.
- Observe the notes in the section on tire pressures (▷ page 266).

Warning





The tire pressure loss warning system can only give reliable warnings if you have set the correct tire pressure.

If an incorrect tire pressure is set, these incorrect values will be monitored.





A tire with insufficient pressure results in vehicle instability when driving, thus increasing the risk of an accident.

- ▶ Make sure that the SmartKey is in position **2** (▷ page 129) in the ignition lock.
- ▶ Press the  or  button to select the Service menu.
- ▶ Press the  or  button to select Tire Pressure.
- ▶ Press the  button.
The Run Flat Indicator Active Press 'OK' to Restart message appears in the multifunction display.

If you wish to confirm the restart:

- ▶ Press the  button.
The Tire Pressure Now OK? message appears in the multifunction display.
- ▶ Press  or  to select Yes.
- ▶ Press the  button.
The Run Flat Indicator Restarted message appears in the multifunction display.
After a teach-in period, the tire pressure loss warning system will monitor the set tire pressures of all four tires.

If you wish to cancel the restart:

- ▶ Press the  button.
- or
- ▶ If the message: Tire Pressure now OK? appears, use  or  to select Cancel.
 - ▶ Press the  button.
The tire pressure values stored at the last restart will continue to be monitored.

Tire pressure monitoring system (USA only)

Important safety notes

If a tire pressure monitor is installed, the vehicle's wheels have sensors installed that monitor the tire pressures in all four tires. The tire pressure monitor warns you when the pressure drops in one or more of the tires. The tire pressure monitor only functions if the

correct wheel electronics units are installed in all wheels.

The tire pressure monitor has a yellow warning lamp in the instrument cluster for indicating a pressure loss or malfunction. Depending on how the warning lamp flashes or lights up, a tire pressure that is too low or a malfunction in the tire pressure monitor is displayed:

- if the warning lamp is lit continuously, the tire pressure on one or more tires is significantly too low. The tire pressure monitor is not malfunctioning.
- if the warning lamp flashes for 60 seconds and then remains lit constantly, the tire pressure monitor is malfunctioning.

Warning!

Each tire, including the spare (if provided), should be checked at least once a month when cold and inflated to the inflation pressure recommended by the vehicle manufacturer on the tire and loading information table on the driver's door B-pillar or the tire inflation pressure table on the inside of the fuel filler flap. If your vehicle has tires of a different size than the size indicated on the tire and loading information table or the tire inflation pressure table, you should determine the proper tire inflation pressure for those tires.

As an added safety feature, your vehicle has been equipped with a tire pressure monitor (TPMS). An indicator lamp lights up if one or more of your tires are significantly underinflated. Accordingly, when the low tire pressure indicator lamp lights up, you should stop and check your tires as soon as possible, and inflate them to the proper pressure. Driving on a significantly underinflated tire causes the tire to overheat and can lead to tire failure.

Underinflation also reduces fuel efficiency and tire tread life and may affect the vehicle's handling and stopping ability. Please note that the TPMS is not a substitute for proper tire maintenance and it is the driver's

responsibility to maintain correct tire pressure, even if underinflation has not reached the level at which the low tire pressure indicator lamp of the TPMS lights up. Your vehicle has also been equipped with a TPMS malfunction indicator to indicate when the system is not operating properly. The TPMS malfunction indicator is combined with the low tire pressure indicator lamp. When the system detects a malfunction, the indicator lamp will flash for approximately 1 minute and then remain illuminated. This sequence will continue upon subsequent vehicle start-ups as long as the malfunction exists. When the malfunction indicator is lit, the system may not be able to detect or signal low tire pressure as intended.

TPMS malfunctions may occur for a variety of reasons, including the installation of incompatible replacement or alternate tires or wheels on the vehicle that prevent the TPMS from functioning properly. Always check the TPMS malfunction indicator after replacing one or more tires or wheels on your vehicle to ensure that the replacement or alternate tires and wheels allow the TPMS to continue to function properly.

- i** If the tire pressure monitor is malfunctioning, it may take more than 10 minutes for the tire pressure warning lamp to inform you of the malfunction by flashing for 60 seconds and then remaining lit.

When the malfunction has been rectified, the tire pressure warning lamp goes out after driving for a few minutes.

Information on tire pressures is displayed in the multifunction display. After a few minutes of driving, the current tire pressure of each tire is shown in the multifunction display.

- i** The tire pressure values indicated by the on-board computer may differ from those measured at a gas station with a pressure gauge. The tire pressures shown by the on-board computer refer to those measured at

sea level. At high altitudes, the tire pressure values indicated by a pressure gauge are higher than those shown by the on-board computer. In this case, do not reduce the tire pressures.





- i** The operation of the tire pressure monitor can be affected by interference from radio transmitting equipment (e.g. radio headphones, two-way radios) that may be operated in or near the vehicle.

- i** This device complies with Part 15 of the FCC Rules. Operation is subject to the following two conditions:

1. This device may not cause harmful interference, and
2. This device must withstand any interference received, including interference that may cause undesired operation.

Unauthorized modifications to the device could void the user's authority to operate the equipment.

Checking tire pressure electronically

- ▶ Make sure that the SmartKey is in position **2** (▶ page 129) in the ignition lock.
- ▶ Press the  or  button to select the Service menu.
- ▶ Press the  or  button to select Tire Pressure.
- ▶ Press the  button.

The current tire pressure for each wheel will be displayed in the multifunction display.

If the vehicle has been parked for longer than 20 minutes, the Tire pressures will be displayed after driving a few minutes message appears in the display.

After a teach-in period, the tire pressure monitor automatically recognizes new wheels or new sensors. As long as a clear allocation of the tire pressure values to the individual wheels is not possible, the Tire Pressure Monitor Active message is shown instead

of the tire pressure display. The tire pressures are already being monitored.

- i** If a spare wheel/emergency spare wheel is mounted, the system may continue to show the tire pressure of the wheel that has been removed for a few minutes. If this occurs, note that the value displayed for the position where the spare wheel is mounted is not the same as the spare wheel/emergency spare wheel's current tire pressure.

TPMS warning messages

If the tire pressure monitor detects a significant pressure loss on one or more tires, a warning message is shown in the multifunction display. A warning tone also sounds and the tire pressure warning lamp lights up in the instrument cluster.

Each tire that is affected by a significant loss of pressure is highlighted by a red rectangle.

If the Correct Tire Pressure message appears in the multifunction display:

- ▶ Check the tire pressure on all four wheels and correct it if necessary.

- i** If the wheel positions on the vehicle are interchanged, the tire pressures may be displayed for the wrong positions for a short time. This is rectified after a few minutes of driving, and the tire pressures are displayed for the correct positions.

Restarting the tire pressure monitor

Warning





It is the driver's responsibility to set the tire inflation pressure to the recommended cold tire inflation pressure. Underinflated tires affect the ability to steer or brake the vehicle. You might lose control over the vehicle.

When you restart the tire pressure monitor, all existing warning messages are deleted and the warning lamps go out. The monitor uses

the currently set tire pressures as the reference values for monitoring.

The TPMS must be restarted when you set the tire pressure to a new value (as a result of changed handling or load characteristics, for example). The TPMS then monitors the new tire pressure values.

Restart the tire pressure monitor after you have set the tire pressure to the value recommended for the desired driving situation (▷ page 266). Only correct tire pressures on cold tires. Comply with the recommended tire pressures on the Tire and Loading Information placard on the B-pillar on the driver's side. Additional tire pressure values for driving at high speeds or with heavy loads can be found in the Tire Pressure table on the inside of the fuel filler flap.

- ▶ Make sure that the tire pressure is correct on all four wheels.
- ▶ Make sure that the SmartKey is in position **2** in the ignition lock.
- ▶ Press the  or  button to select the Service menu.
- ▶ Press the  or  button to select Tire Pressure.
- ▶ Press the  button.

The current tire pressure of each wheel or the Tire pressures will be displayed after driving a few minutes message is shown in the multifunction display.

- ▶ Press the  button.

The Use Current Pressures as New Reference Values message appears in the multifunction display.

If you wish to confirm the restart:

- ▶ Press the  button.

The Tire Press. Monitor Restarted message appears in the multifunction display.

After driving for a few minutes, the system checks whether the current tire pressures are within the specified range. The new tire

pressures are then accepted as reference values and monitored.

If you wish to cancel the restart:

- ▶ Press the  button.
The tire pressure values stored at the last restart will continue to be monitored.

Maximum tire pressures

Warning

Never exceed the maximum tire inflation pressure. Follow recommended tire inflation pressures.

Do not underinflate tires. Underinflated tires wear excessively and/or unevenly, adversely affect handling and fuel economy, and are more likely to fail from being overheated.

Do not overinflate tires. Overinflated tires can adversely affect handling and ride comfort, wear unevenly, increase stopping distance, and result in sudden deflation (blowout) because they are more likely to become punctured or damaged by road debris, potholes etc.



- ① Maximum permitted tire pressure (example)
-  The actual values for tires are specific to each vehicle and may deviate from the values in the illustration.

When adjusting the tire pressures always observe the recommended tire pressure for your vehicle (> page 266).

Loading the vehicle

Instruction labels for tires and loads

Warning

Do not overload the tires by exceeding the specified load limit as indicated on the Tire and Loading Information placard on the driver's door B-pillar. Overloading the tires can overheat them, possibly causing a blowout. Overloading the tires can also result in handling or steering problems, or brake failure.

Two instruction labels on your vehicle show the maximum possible load.

- (1) The Tire and Loading Information placard is on the B-pillar on the driver's side. The Tire and Loading Information placard shows the permissible number of occupants and the maximum permissible vehicle load. It also contains details of the tire sizes and corresponding pressures for tires mounted at the factory.
- (2) The vehicle identification plate is on the B-pillar on the driver's side. The vehicle identification plate informs you of the gross vehicle weight rating. It is made up of the vehicle weight, all vehicle occupants, the fuel and the cargo. You can also find information about the maximum gross axle weight rating on the front and rear axle.

The maximum gross axle weight rating is the maximum weight that can be carried by one axle (front or rear axle). Never exceed the maximum load or the maximum gross axle weight rating for the front or rear axle.



① B-pillar, driver's side

Maximum permissible gross vehicle weight rating

- ① The data in the illustration of the Tire and Loading Information placard is an example. The maximum permissible gross vehicle weight rating is vehicle-specific and may differ from that which is illustrated. You can find the valid maximum permissible gross vehicle weight rating for your vehicle on the Tire and Loading Information placard.

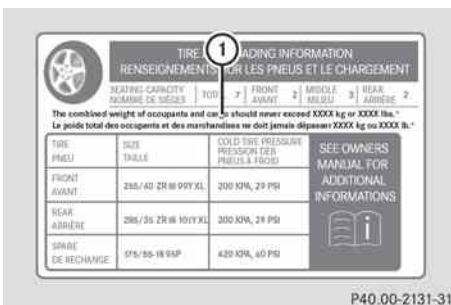

P40.00-2131-31

- The Tire and Loading Information placard gives you details on maximum permissible gross vehicle weight rating ①: "The gross weight of occupants and luggage must

never exceed XXX kilograms or XXX pounds."

The gross weight of all vehicle occupants, cargo, luggage and trailer load/noseweight (if applicable) must not exceed the specified value.

Number of seats

- ① The data in the illustration of the Tire and Loading Information placard is an example. The number of seats is vehicle-specific and can differ from the details shown. The number of seats in your vehicle can be found on the Tire and Loading Information placard.

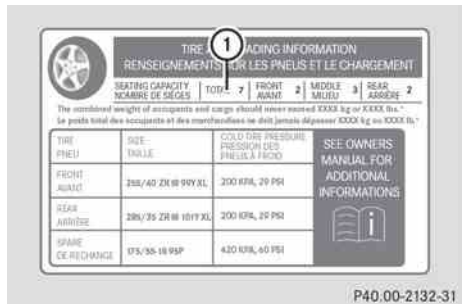

P40.00-2132-31

Maximum number of seats ① determines the maximum number of occupants allowed to travel in the vehicle. This information can be found on the Tire and Loading Information placard.

Determining the maximum load

The following steps have been developed as required of all manufacturers under Title 49, Code of U.S. Federal Regulations, Part 575 pursuant to the "National Traffic and Motor Vehicle Safety Act of 1966".

- ▶ **Step 1:** Locate the statement "The combined weight of occupants and cargo should never exceed XXX kg or XXX lbs." on your vehicle's Tire and Loading Information placard.
- ▶ **Step 2:** Determine the combined weight of the driver and passengers that will be traveling in your vehicle.
- ▶ **Step 3:** Subtract the combined weight of the driver and passengers from XXX kilograms or XXX lbs.
- ▶ **Step 4:** The resulting figure equals the available amount of cargo and luggage load capacity. For example, if the "XXX" amount equals 1400 lbs and there will be five 150 lbs passengers in your vehicle, the amount of available cargo and luggage load capacity is 650 lbs (1400 - 750 (5 x 150) = 650 lbs).
- ▶ **Step 5:** Determine the combined weight of luggage and cargo being loaded on the vehicle. For reasons of safety, that weight must not exceed the available cargo and luggage cargo capacity calculated in step 4.
- ▶ **Step 6 (if applicable):** If you intend to tow a trailer behind your vehicle, the load on the trailer is transferred to your vehicle. Consult this Operator's Manual to determine how this reduces the available cargo and luggage load capacity of your vehicle (▷ page 278).

The following table shows examples of how to calculate total and cargo load capacities with varying seating configurations and number and size of occupants. The following examples use a cargo limit of 1500 lbs (680 kg). **This is for illustration purposes only.** Make sure you always use the actual load limit for your vehicle stated on the vehicle's Tire and Loading Information placard (▷ page 275).

		Example 1	Example 2	Example 3
Step 1	Combined maximum weight of occupants and cargo (data from the Tire and Loading Information placard)	1500 lbs (680 kg)	1500 lbs (680 kg)	1500 lbs (680 kg)

		Example 1	Example 2	Example 3
Step 2	Number of people in the vehicle (driver and occupants)	5	3	1
	Distribution of the occupants	Front: 2 Rear: 3	Front: 1 Rear: 2	Front: 1

		Example 1	Example 2	Example 3
	Weight of the occupants	Occupant 1: 150 lbs (68 kg) Occupant 2: 180 lbs (82 kg) Occupant 3: 160 lbs (73 kg) Occupant 4: 140 lbs (63 kg) Occupant 5: 120 lbs (54 kg)	Occupant 1: 200 lbs (91 kg) Occupant 2: 190 lbs (86 kg) Occupant 3: 150 lbs (68 kg)	Occupant 1: 150 lbs (68 kg)
	Gross weight of all occupants	750 lbs (340 kg)	540 lbs (245 kg)	150 lbs (68 kg)

		Example 1	Example 2	Example 3
Step 3	Permissible cargo and trailer load/noseweight (maximum gross vehicle weight rating from the Tire and Loading Information placard minus the gross weight of all occupants)	1500 lbs (680 kg) - 750 lbs (340 kg) = 750 lbs (340 kg)	1500 lbs (680 kg) - 540 lbs (245 kg) = 960 lbs (435 kg)	1500 lbs (680 kg) - 150 lbs (68 kg) = 1350 lbs (612 kg)

The greater the combined weight of the occupants, the lower the maximum luggage load. Further information can be found under "Towing a trailer" (▷ page 278).

Vehicle identification plate

Even if you have calculated the total cargo carefully, you should still make sure that the gross vehicle weight rating and the gross axle weight rating are not exceeded. Details can be found on the vehicle identification plate on the B-pillar on the driver's side (▷ page 274).

Gross vehicle weight: the gross weight of the vehicle, all passengers, cargo and trailer load/noseweight (if applicable) must not exceed the permissible gross vehicle weight.

Gross axle weight rating: the maximum permissible load that can be carried by one axle (front or rear axle).

To ensure that your vehicle does not exceed the maximum permissible values (gross vehicle weight and maximum gross axle weight rating), have your loaded vehicle (including driver, occupants, cargo, and full trailer load if applicable) weighed on a suitable vehicle weighbridge.

Trailer load/noseweight

The trailer load/noseweight affects the gross weight of the vehicle. If a trailer is attached, the trailer load/noseweight is included in the load along with occupants and luggage. The trailer load/noseweight is usually approximately 8% of the gross weight of the trailer and its cargo.

Maximum tire load

Warning

Do not overload the tires by exceeding the specified load limit as indicated on the Tire and Loading Information placard on the driver's door B-pillar. Overloading the tires can overheat them, possibly causing a blowout. Overloading the tires can also result in handling or steering problems, or brake failure.



- i** The actual values for tires are specific to each vehicle and may deviate from the values in the illustration.

Maximum tire load ① is the maximum permitted weight for which the tire is approved.

Further information on tire loads
(▷ page 280).

Direction of rotation

Tires with a specified direction of rotation have additional benefits, e.g. if there is a risk of hydroplaning. You will only gain these benefits if the correct direction of rotation is observed.

An arrow on the sidewall of the tire indicates its correct direction of rotation.

You may mount an emergency spare wheel/spare wheel against the direction of rotation. Observe the time restriction on use as well as the speed limitation specified on the emergency spare wheel/spare wheel.

Uniform Tire Quality Grading Standards

Overview of tire quality standards

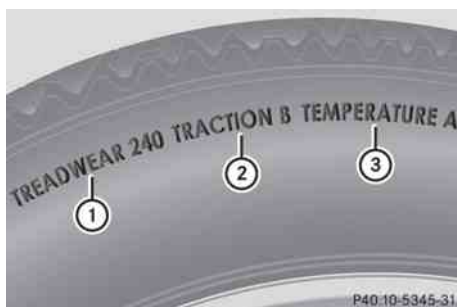

The Uniform Tire Quality Grading Standards are U.S. government specifications. Their purpose is to provide drivers with uniform reliable information on tire performance data. Tire manufacturers have to grade tires using three performance factors: ① tread wear, ② tire traction, and ③ heat resistance. All tires sold in North America are provided with the corresponding quality class mark on the sidewall of the tire, even though these regulations do not apply to Canada.

- i** The actual values for tires are specific to each vehicle and may deviate from the values in the illustration.

Where applicable, the tire grading information can be found on the tire sidewall between the tread shoulder and maximum tire width.

For example:

Tread wear	Traction	Temperature
200	AA	A

All passenger car tires must conform to the statutory safety requirements in addition to these grades.

Tread wear

The tread wear grade is a comparative rating based on the wear rate of the tire when tested under controlled conditions on a specified U.S. government test track. For example, a tire graded 150 would wear one and one-half times as well on the government test track as a tire graded 100.

The relative performance of tires depends upon the actual conditions of their use, however, and may depart significantly from the norm due to variations in driving habits, service practices and differences in road characteristics and climate conditions.

Traction

Warning

The traction grade assigned to this tire is based on straight-ahead braking traction tests, and does not include acceleration, cornering, hydroplaning, or peak traction characteristics.

The traction grades, from highest to lowest, are AA, A, B, and C. These grades represent the tire's ability to stop on a wet surface as measured under controlled conditions on specified government test surfaces of asphalt and concrete. A tire marked C may have poor traction performance.

Warning

If ice has formed on the road, tire traction will be substantially reduced. Under such weather conditions, drive, steer and brake with extreme caution.

The safe speed on a wet, snow covered or icy road is always lower than on dry road surfaces.

You should pay special attention to road conditions when temperatures are around the freezing point.

Mercedes-Benz recommends a minimum tire tread depth of 1/6 in (4 mm) for all four winter tires (▷ page 148) to maintain normal driving characteristics in winter. Winter tires can reduce the braking distance on snow covered surfaces in comparison to summer tires. The braking distance is still much further than on surfaces that are not icy or covered with snow. Take appropriate care when driving.

 Avoid wheelspin. This can lead to damage to the drive train.

Temperature

Warning

The temperature grade for this tire is established for a tire that is properly inflated and not overloaded. Excessive speed, underinflation, or excessive loading, either separately or in combination, can cause excessive heat build-up and possible tire failure.

The temperature grades are A (the highest), B, and C. These represent the tire's resistance to the generation of heat and its ability to dissipate heat when tested under controlled conditions on a specified indoor laboratory test wheel. Sustained high temperature can cause the material of the tire to degenerate and reduce tire life. Furthermore, excessive temperature can lead to sudden tire failure. Grade C corresponds to a level of performance that all passenger

car tires must meet under Federal Motor Vehicle Safety Standard No. 109. Grades B and A represent higher levels of performance on the laboratory test wheel than the minimum required by law.

Interchanging the wheels

Warning

Rotate front and rear wheels only if the tires are of the same dimension.

If your vehicle is equipped with mixed-size tires (different tire dimensions front vs. rear), tire rotation is not possible.

Warning!

Have the tightening torque checked after changing a wheel. The wheels could come loose if they are not tightened to a torque of 110 lb-ft (150 Nm).

Only use genuine Mercedes-Benz wheel bolts specified for your vehicle's rims.

The wear patterns on the front and rear tires differ, depending on the operating conditions. Rotate the wheels before a clear wear pattern has formed on the tires. Front tires typically wear more on the shoulders and the rear tires in the center.

If your vehicle's tire configuration allows, you can rotate the wheels according to the intervals in the tire manufacturer's warranty book in your vehicle documents. If no warranty book is available, the tires should be rotated every 3000 to 6000 miles (5000 to 10000 km), or earlier if tire wear requires. Do not change the direction of wheel rotation.

Clean the contact surfaces of the wheel and the brake disc thoroughly every time a wheel is rotated. Check the tire pressures.

Information on changing a wheel and mounting the spare wheel (▷ page 247).

Tire labeling

Overview of tire labeling

The following markings are on the tire in addition to the tire name (sales designation) and the manufacturer's name:

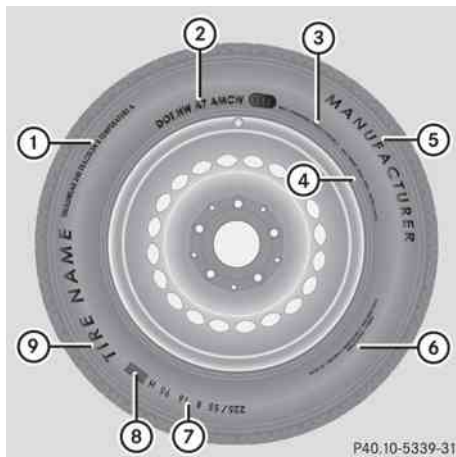

- ① Uniform Tire Quality Grading Standard (▷ page 284)
 - ② DOT, Tire Identification Number (▷ page 283)
 - ③ Maximum tire load (▷ page 278)
 - ④ Maximum tire pressure (▷ page 274)
 - ⑤ Manufacturer
 - ⑥ Tire material (▷ page 284)
 - ⑦ Tire size designation, load-bearing capacity and speed index (▷ page 281)
 - ⑧ Load index (▷ page 283)
 - ⑨ Tire name
- i** Tire data is vehicle-specific and may deviate from the data in the example.

Tire size designation, load-bearing capacity and speed index

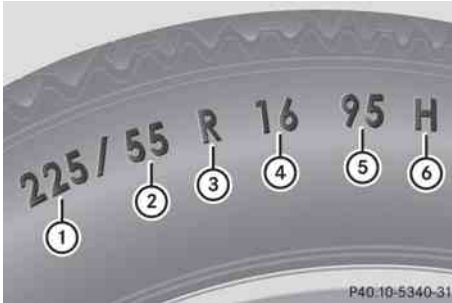

- ① Tire width
- ② Aspect ratio in percent
- ③ Tire code
- ④ Rim diameter
- ⑤ Load bearing index
- ⑥ Speed index

① Tire data is vehicle-specific and may deviate from the data in the example.

General: depending on the manufacturer's standards, the size imprinted in the tire wall may not contain any letters or may contain one letter that precedes the size description. If there is no letter preceding the size description (as shown above): passenger vehicle tires according to European manufacturing standards.

If "P" precedes the size description: passenger vehicle tires according to U.S. manufacturing standards.

If "LT" precedes the size description: light truck tires according to U.S. manufacturing standards.

If "T" precedes the size description: compact emergency spare wheels at high tire pressure, only for temporary use in an emergency.

Tire width: tire width ① shows the nominal tire width in millimeters.

Aspect ratio: aspect ratio ② is relationship between tire height and tire width and is specified in percent. The aspect ratio is

calculated by dividing the tire width by the tire height.

Tire code: tire code ③ specifies the tire type. "R" represents radial tires. "D" represents diagonal tires, "B" represents diagonal radial tires.

Optionally, tires with a maximum speed of over 149 mph (240 km/h) may have "ZR" in the size description depending on the manufacturer (e.g. 245/40 ZR 18).

Rim diameter: rim diameter ④ is the diameter of the bead seat, not the diameter of the rim flange. The rim diameter is specified in inches (in).

Load bearing index: load bearing index ⑤ is a numerical code that specifies the maximum load-bearing capacity of a tire.

Warning

The tire load rating must always be at least half of the GAWR of your vehicle. Otherwise, sudden tire failure may be the result which could cause an accident and/or serious injury to you or others.

Always replace rims and tires with rims and tires having the same specifications (designation, manufacturer and type) as shown on the original part.

Warning

Do not overload the tires by exceeding the specified load limit as indicated on the Tire and Loading Information placard on the driver's door B-pillar. Overloading the tires can overheat them, possibly causing a blowout. Overloading the tires can also result in handling or steering problems, or brake failure.

Example:

The load bearing index 91 is equivalent to a maximum load of 1356 lbs (615 kg) that the tire can carry. For further information on the maximum tire load in kilograms and pounds, see (▷ page 278).

For further information on the load bearing index, see load index (▷ page 283).

Speed index: speed index ⑥ specifies the approved maximum speed of the tire.

Warning

Even when permitted by law, never operate a vehicle at speeds greater than the maximum speed rating of the tires.

Exceeding the maximum speed for which tires are rated can lead to sudden tire failure, causing loss of vehicle control and possibly resulting in an accident and/or serious personal injury and possible death, for you and for others.

Regardless of the speed index always observe the speed limits. Drive carefully and adapt your driving style to the traffic conditions.

Summer tires

Index	Speed rating
Q	up to 100 mph (160 km/h)
R	up to 106 mph (170 km/h)
S	up to 112 mph (180 km/h)
T	up to 118 mph (190 km/h)
H	up to 130 mph (210 km/h)
V	up to 149 mph (240 km/h)
W	up to 168 mph (270 km/h)
Y	up to 186 mph (300 km/h)
ZR...Y	up to 186 mph (300 km/h)
ZR...(..Y)	above 186 mph (300 km/h)
ZR	above 149 mph (240 km/h)

- Optionally, tires with a maximum speed of over 149 mph (240 km/h) may have "ZR" in the size description depending on the manufacturer (e.g. 245/40 ZR 18).

The service specifications consists of load bearing index ⑤ and speed index ⑥.

- If the size description of your tire includes "ZR" and there are no service specifications, ask the tire manufacturer in order to find out the maximum speed.
If a service specification is available, the maximum speed is limited according to the speed index in the service specification. Example: 245/40 ZR18 97 Y. In this example, "97Y" is the service specification. The letter "Y" represents the speed index and the maximum speed of the tire is limited to 186 mph (300 km/h).
- Every tire that has a maximum speed above 186 mph (300 km/h) must have "ZR" in the size description **and** the service specification must be given in brackets. Example: 275/40 ZR 18 (99 Y). The speed index "(Y)" shows that the maximum speed of the tire is above 186 mph (300 km/h). Ask the tire manufacturer to find out the maximum speed.

All-weather tires and winter tires

Index	Speed rating
Q M+S ³³	up to 100 mph (160 km/h)
T M+S ³³	up to 118 mph (190 km/h)
H M+S ³³	up to 130 mph (210 km/h)
V M+S ³³	up to 149 mph (240 km/h)

- i** Not all tires that have the M+S identification offer the driving characteristics of winter tires. Winter tires have, in addition to the M+S identification, the  snowflake symbol on the tire sidewall. Tires with this identification fulfill the requirements of the Rubber Manufacturers Association (RMA) and the Rubber Association of Canada (RAC) regarding the tire traction on snow and

have been especially developed for driving on snow.

An electronic speed limiter prevents your vehicle from exceeding a speed of 130 mph (210 km/h).

The speed index of tires installed at the factory may be higher than the maximum speed that the electronic speed limiter permits.

Make sure that your tires have the required speed index as specified in the "Tires" section (▷ page 287) for your vehicle, e.g. when buying new tires.

More information on reading the tire data can be obtained at any qualified specialist workshop, e.g. at an authorized Mercedes-Benz Center.

Load index



i Tire data is vehicle-specific and may deviate from the data in the example.

In addition to the load bearing index, load index ① may be imprinted after the letters that identify speed index ⑥ (▷ page 281) on the sidewall of the tire.

- If no specification is given: no text (as in the example above), represents a standard load (SL) tire
- XL or Extra Load: represents a reinforced tire

- Light load: represents a light load tire
- C, D, E: represents a load range that depends on the maximum load that the tire can carry at a certain pressure

DOT, Tire Identification Number (TIN)

U.S. tire regulations prescribe that every new tire manufacturer or retreader has to imprint a TIN in or on the sidewall of each tire produced.



The TIN is a unique identification number. The TIN enables the tire manufacturers to inform purchasers of recalls and other safety-relevant matters. It makes it possible for the purchaser to easily identify the affected tires. The TIN is made up of manufacturer identification code ②, tire size ③, tire type code ④ and date of manufacture ⑤.

i Tire data is vehicle-specific and may deviate from the data in the example.

DOT (Department of Transportation): tire symbol ① marks that the tire complies with the requirements of the U.S. Department of Transportation.

Manufacturer identification code: manufacturer identification code ② provides details on the tire manufacturer. New tires have a code with two symbols. Retreaded tires have a code with four symbols. Further information about retreaded tires (▷ page 264).

Tire size: identifier ③ describes the tire size.

Tire type code: tire type code ④ can be used by the manufacturer as a code to describe specific characteristics of the tire.

Date of manufacture: date of manufacture ⑤ provides information about the age of a tire. The first and second positions represent the week of manufacture, starting with "01" for the first calendar week. Positions three and four represent the year of manufacture. For example, a tire that is marked with "3208", was manufactured in week 32 in 2008.

Characteristics of the tire



i Tire data is vehicle-specific and may deviate from the data in the example.

This information describes the tire cord and the number of layers in sidewall ① and under the tread ②.

Definitions for tires and loading

Structure and condition of the tire

Describes the number of layers or the number of rubber-coated belts in the tire tread and the tire wall. These are made of steel, nylon, polyester and other materials.

Bar

Metric unit for tire pressure. 14.5038 pounds per square inch (psi) and 100 kilopascals (kPa) are the equivalent of 1 bar.

DOT (Department of Transportation)

DOT marked tires fulfill the requirements of the United States Department of Transportation.

Average weight of the vehicle occupants

The number of occupants for which the vehicle is designed multiplied by 68 kilograms (150 lb).

Uniform Tire Quality Grading Standards

A uniform standard to grade the quality of tires with regards to tread quality, tire traction and temperature characteristics. The quality grading assessment is made by the manufacturer following specifications from the U.S. government. The quality grade of a tire is imprinted on the sidewall of the tire.

Recommended tire pressure

The recommended tire pressure for your vehicle under normal driving conditions. You will find the recommendation on the Tire and Loading Information placard on the B-pillar on the driver's side of your vehicle. The recommended tire pressure provides the best balance between handling characteristics, ride comfort and wear. Additional information on particular driving conditions is located on the tire pressure table on the inside of the fuel filler flap.

Increased vehicle weight due to optional equipment

The combined weight of all standard and optional equipment available for the vehicle, regardless of whether it is actually installed on the vehicle or not.

Wheel rim

The part of the wheel on which the tire is mounted.

GAWR (Gross Axle Weight Rating)

The GAWR is the maximum gross axle weight rating. The actual load on an axle must never exceed the gross axle weight rating. The gross axle weight rating can be found on the vehicle identification plate on the B-pillar on the driver's side.

Speed index

The speed index is part of the tire identification. Specifies the speed range for which the tire is approved.

GTW (Gross Trailer Weight)

The GTW is the weight of a trailer including the weight of the load, luggage, accessories etc. on the trailer.

GVW (Gross Vehicle Weight)

The gross vehicle weight includes the weight of the vehicle including fuel, tools, the spare wheel, accessories installed, occupants, luggage and the drawbar noseweight if applicable. The gross vehicle weight must not exceed the gross vehicle weight rating GVWR as specified on the vehicle identification plate on the B-pillar on the driver's side.

GVWR (Gross Vehicle Weight Rating)

The GVWR is the maximum permissible gross weight of a fully loaded vehicle (the weight of the vehicle including all accessories, occupants, fuel, luggage and the drawbar noseweight if applicable). The gross vehicle weight rating is specified on the vehicle

identification plate on the B-pillar on the driver's side.

Maximum weight of the laden vehicle

The maximum weight is the sum of the unladen weight of the vehicle, the weight of the accessories, the maximum load and the weight of the optional equipment installed at the factory.

Kilopascal (kPa)

Metric unit for tire pressure. 6.9 kPa is the equivalent of 1 psi. Another unit for tire pressure is bar. 100 kilopascal (kPa) is the equivalent of 1 bar.

Load index

In addition to the load bearing index, the load index may also be imprinted on the sidewall of the tire. This specifies the load bearing capacity more precisely.

Unladen weight

The weight of a vehicle with standard equipment including the maximum capacity of fuel, oil and coolant. It also includes the air-conditioning system and optional equipment if these are installed on the vehicle, but does not include passengers or luggage.

Maximum tire load

The maximum tire load in kilograms or pounds is the maximum weight for which a tire is approved.

Maximum permissible tire pressure

Maximum permissible tire pressure for one tire.

Maximum load on one tire

Maximum load on one tire. This is calculated by dividing the maximum axle load of one axle by two.

PSI (pounds per square inch)

Standard unit of measurement for tire pressure.

Aspect ratio

Relationship between tire height and tire width in percent.

Tire pressure

Pressure inside the tire applying an outward force to every square inch of the tire's surface. The tire pressure is specified in pounds per square inch (psi), in kilopascal (kPa) or in bar. The tire pressure should only be corrected when the tires are cold. For this, the vehicle must have been stationary for at least three hours or not have traveled more than 1.6 km (1 mile) in this time.

Tire tread

The part of the tire that comes into contact with the road.

Tire bead

The tire bead contains steel wire which is bound by steel cords that hold the tire on the wheel rim.

Sidewall

The part of the tire between the tread and the tire bead.

Weight of optional extras

The combined weight of those optional extras that weigh more than the replaced standard part and more than 2.3 kilograms (5 lbs). These optional extras, such as high-performance brakes, level control, a roof rack or a high-performance battery, are not included in the unladen weight and the weight of the accessories.

TIN (Tire Identification Number)

A unique identification number which can be used by a tire manufacturer to identify tires, for example for a product recall, and thus identify the purchasers. The TIN is made up of the manufacturer's identity code, tire size, tire type code and the manufacturing date.

Load bearing index

The load bearing index (also load index) is a code that contains the maximum load bearing capacity of a tire.

Traction

Traction is the result of friction between the tires and the road surface.

TWR (permissible trailer drawbar noseweight)

The TWR is the maximum permissible weight that the ball coupling of the trailer tow hitch can support.

Wear indicator

Narrow bars (tread wear bars) that are distributed over the tire tread. If the tire tread is level with the bars, the wear limit of $\frac{1}{16}$ in (1.6 mm) has been reached.

Distribution of the vehicle occupants

Distribution of vehicle occupants over designated seat positions in a vehicle.

Maximum permissible payload weight

Nominal load and luggage load plus 68 kilograms (150 lb) multiplied by the number of seats in the vehicle.

Wheel/tire combinations

Points to remember

Warning

Observe the "Important safety notes" (> page 264).

- !** For safety reasons, Mercedes-Benz recommends that you only use tires, wheels and accessories which have been approved by Mercedes-Benz specifically for your vehicle.

These tires have been specially adapted for use with the control systems, such as ABS or ESP®, and are marked as follows:

- MO = Mercedes-Benz Original
- MOE = Mercedes-Benz Original Extended (tires with run-flat characteristics)
- MO1 = Mercedes-Benz Original (only certain AMG tires)

Mercedes-Benz Original Extended tires may only be used on wheels that have been specifically approved by Mercedes-Benz.

Only use tires, wheels or accessories tested and approved by Mercedes-Benz. Certain characteristics, e.g. handling, vehicle noise emissions or fuel consumption, may otherwise be adversely affected. In addition, when driving with a load, tire dimension variations could cause the tires to come into contact with the bodywork and axle components. This could result in damage to the tires or the vehicle.

Mercedes-Benz accepts no liability for damage resulting from the use of tires, wheels or accessories other than those tested and approved.

Further information about tires, wheels and approved combinations can be obtained from any authorized Mercedes-Benz Center.

- i** The Tire and Loading Information placard with the recommended tire pressures is attached to the B-pillar on the driver's side. Further information about driving at high speeds or driving with vehicle loads that are lighter than the maximum vehicle load can be found in the tire pressure table on the inside of the fuel filler flap. Check tire pressures regularly, and only when the tires are cold. Follow the tire manufacturer's maintenance recommendations in the vehicle document wallet.

Further information on recommended tire pressures including tire pressures for specific driving situations, see (> page 266).

- i** Notes on the vehicle equipment – always equip the vehicle:
 - with tires of the same size on a given axle (left/right)
 - with the same type of tires at a given time (summer tires, winter tires, MOExtended tires)

- i** The following pages contain information on approved wheel rims and tire sizes for equipping your vehicle with winter tires. Winter tires are not available at the factory as standard equipment or optional extras. If you wish to fit approved winter tires to your vehicle, rims of appropriate size are also required, as the sizes of the approved winter tires can differ from those of the original tires. This is dependent on the model and the equipment installed at the factory.

Tires and wheel rims as well as additional information are available from a qualified

specialist workshop, e.g. an authorized Mercedes-Benz Center.

Tires of the same dimensions

i BA: both axles

		Model	GLK 350 ³⁴ GLK 350 4MATIC
R17	BA	Alloy wheels Offset	7.5 J x 17 H2 1.87 in (47.5 mm)
		Winter tires³⁵	235/60 R17 102 H M+S 
R19	BA	Alloy wheels Offset	7.5 J x 19 H2 1.85 in (47 mm)
		All-weather tires	235/50 R19 99 H M+S
R20	BA	Alloy wheels Offset	8.5 J x 20 H2 1.77 in (45 mm)
		All-weather tires	235/45 R20 100 H XL M+S

Spare wheel

i Please note that the tire pressure of the spare wheel differs from the tire pressure of the other wheels.

i The specified tire pressure is printed in yellow on the emergency spare wheel.

Collapsible emergency spare wheel³⁶

		All models
R17	Alloy wheels Offset	6 B x 17 H2 0.98 in (25 mm)
	Tires	185/75-17 98 P
	Tire pressure	280 kPa (2.8 bar/41 psi)

³⁴ USA only.

³⁵ Not available as standard or optional equipment from the factory.

³⁶ Use of snow chains not permitted.

Vehicle equipment	292
Genuine Mercedes-Benz parts	292
Warranty	292
Vehicle identification plates	293
Service products and capacities	294
Vehicle data	299

Vehicle equipment

i This manual describes all the standard and optional equipment of your vehicle which was available at the time of purchase. Country-specific differences are possible. Bear in mind that your vehicle may not feature all functions described here. This also refers to safety-related systems and functions.

Genuine Mercedes-Benz parts

All Mercedes-Benz Centers maintain a supply of genuine Mercedes-Benz parts for necessary service and repair work. In addition, strategically located parts delivery centers provide for quick and reliable parts service.

More than 300,000 different genuine Mercedes-Benz parts are available for Mercedes-Benz models.

Genuine Mercedes-Benz parts are subjected to stringent quality inspections. Every part has been specifically developed, manufactured or selected for and adapted to Mercedes-Benz vehicles.

Only genuine Mercedes-Benz parts should therefore be used.

! The use of non-approved parts could impair the vehicle's safety. For this reason, Mercedes-Benz recommends genuine Mercedes-Benz parts and approved conversion parts and accessories for your vehicle model.

Environmental note

Daimler AG also supplies reconditioned major assemblies and parts which are of the same quality as new parts. They are covered by the same Limited Warranty entitlements as new parts.

Always specify the vehicle identification number and engine number when ordering genuine Mercedes-Benz parts. You will find

these numbers on your vehicle's identification plates, for example ([▷ page 293](#)).

Warranty

Your vehicle is covered under the terms of the warranties printed in the Service and Warranty Information booklet.

Your authorized Mercedes-Benz Center will exchange or repair any defective parts originally installed in the vehicle in accordance with the terms of the following warranties:

- New Vehicle Limited Warranty
- Emission System Warranty
- Emission Performance Warranty
- California, Connecticut, Maine, Massachusetts, New York, Pennsylvania, Rhode Island and Vermont Emission Control Systems Warranty
- State Warranty Enforcement Laws (Lemon Laws)

Replacement parts and accessories are subject to the Mercedes-Benz Replacement Part and Accessory Warranties. You can obtain these at any Mercedes-Benz Center.

i Should you lose your Service and Warranty Information booklet, have an authorized Mercedes-Benz Center arrange for a replacement. It will be mailed to you.

Vehicle identification plates

Vehicle identification plate with vehicle identification number (VIN) and paint code number

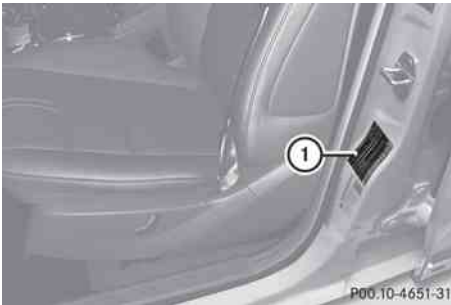

- ▶ Open the driver's door. You see vehicle identification plate ①.



Example: vehicle identification plate (USA only)

- ② Paint code number
- ③ VIN

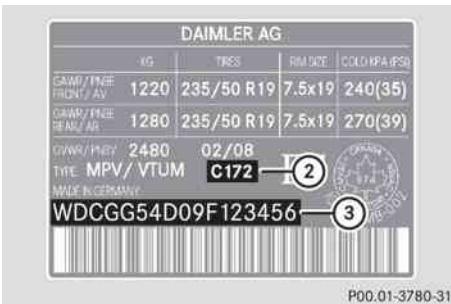

Example: vehicle identification plate (Canada only)

- ② Paint code number
- ③ VIN

i The data on the type plate is only an example. This data is vehicle-specific and can differ from the data given here. The data that applies to your vehicle can be found on your vehicle's type plate.

Vehicle identification number (VIN)

The vehicle identification number (VIN) can be found in the following locations:

- on the vehicle identification plate (▷ page 293)
- at the lower edge of the windshield (▷ page 294)

In addition to being stamped on the vehicle identification plate, the vehicle identification number (VIN) is also stamped onto the vehicle body.

It is located on the floor in front of the front-passenger seat.

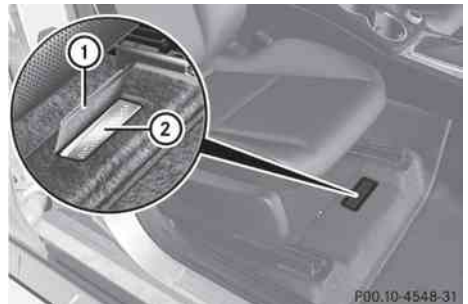

- ▶ Slide the right-hand front seat to its rearmost position.
- ▶ Fold floor covering ① upwards. You will see vehicle identification number (VIN) ②.

Engine number



- ① Emissions control information label, including the certification of both federal and Californian emissions reference values
- ② Engine number (stamped into the crankcase)
- ③ VIN (on the lower edge of the windshield)

Service products and capacities

Important safety notes

Service products include the following:

- fuels (e.g. gasoline, diesel)
- lubricants (e.g. engine oil, transmission oil)
- coolant
- brake fluid
- windshield washer fluid

Vehicle components and their respective lubricants must match. You should therefore only use products that have been tested and approved by Mercedes-Benz.

Information on tested and approved products can be obtained at an authorized Mercedes-Benz Center or on the Internet at <http://www.mbusa.com> (USA only).

Warning

Comply with all valid regulations with respect to handling, storing and disposing of service fluids. Otherwise, you could endanger persons or the environment.

Keep service fluids out of the reach of children.

For health reasons, you should prevent service fluids from coming into direct contact with your skin or clothing.

If a service fluid is swallowed, contact a physician immediately.

Capacities			
	Vehicle model	Capacity	Fuel, coolant, lubricants etc.
Engine oil and filter	All models	7.4 US qt (7.0 l)	Approved engine oils
Power steering	All models	Approximately 1.1 US qt (1.0 l)	MB power steering fluid or approved Dexron III ATF
Cooling system	All models	Approximately 8.9 US qt (8.4 l)	MB 325.0 corrosion inhibitor/antifreeze agent
Tank capacity	All models	17.4 US gal. (66.0 l)	Gasoline engines: premium-grade unleaded gasoline (at least 91 octane, average value between 96 RON/86 MON) Diesel engines: ULTRA-LOW SULFUR DIESEL FUEL (ULSD, maximum sulfur content 15 ppm)
Reserve	All models	Approximately 2.1 US gal. (8.0 l)	
Air-conditioning system	All models	–	Refrigerant R134a and special PAG lubricant (never R 12)
Windshield/headlamp cleaning system	All models	6.3 US qt (6.0 l)	MB windshield washer concentrate ³⁷ (> page 299) Mixing ratio for washer fluid (> page 299)

³⁷ Mixed with water or premixed washer fluid with antifreeze protection.

Fuel

Important safety notes

Warning

Gasoline is highly flammable and poisonous. It burns violently and can cause serious personal injury.

Never allow sparks, flames or smoking materials near gasoline.

Turn off the engine before refueling.

Whenever you are around gasoline, avoid inhaling fumes and any skin or clothing contact.

Direct skin contact with fuels and the inhalation of fuel vapors are damaging to your health.

Premium-grade unleaded gasoline

I To ensure the longevity and full performance of the engine, only premium-grade unleaded gasoline must be used.

If premium-grade unleaded gasoline is unavailable and regular gasoline is used, observe the following precautions:

- only fill the fuel tank to half full with regular unleaded gasoline and add the rest as soon as possible with premium-grade unleaded gasoline.
- do not drive at the maximum speed.
- avoid sudden acceleration.
- when the vehicle is carrying a light cargo, e.g. two passengers without luggage, do not allow the engine to rev above 3000 rpm.
- when the vehicle is fully loaded or being operated in mountainous terrain, do not depress the accelerator pedal further than $\frac{2}{3}$ of the pedal travel.

Fuel requirements

Use only premium-grade unleaded gasoline. The octane number should be at least 91. Details can be found on the gas pump. The

octane number is the average value of the Research Octane Number (RON) and Motor Octane Number (MON): $(RON + MON) / 2$, also known as knock resistance.

Reformulated Gasoline (RFG) and/or unleaded gasoline with additives can be used if the concentration of the additives in the fuel does not exceed 10%, e.g.:

- Ethanol
- TAME
- ETBE
- IPA
- TBA

For MTBE, the concentration should not exceed 15%.

The concentration of methanol in gasoline including other additives must not exceed 3%.

Using mixtures of methanol and ethanol is not permitted. Gasohol, a mixture of 10% ethanol and 90% unleaded gasoline can be used.

All of these mix fuels must fulfill the fuel requirements, e.g.:

- knock resistance
- boiling point
- vapor pressure

Additives in gasoline

One of the major problems in engine design is the creation of carbon deposits during the process of burning fuel. Mercedes-Benz recommends that you use fuel brands that have the additives which prevent the build up of carbon deposits.

If you use fuels without these additives for a longer period of time, there may be a build up of carbon deposits, especially on the inlet valves and in the combustion chamber.

This could lead to engine running problems, e.g.:

- warm-up hesitation
- unstable idle
- knocking/pinging

- misfire
- power loss

In areas where carbon deposits may be encountered due to lack of availability of gasoline which contains these additives, Mercedes-Benz recommends the use of additives approved for use in Mercedes-Benz vehicles.

Consult an authorized Mercedes-Benz Center or visit <http://www.mbusa.com> (USA only) to view a list of approved products. Observe the instructions for use on the product label. Do not mix other fuel additives with fuel. This causes unnecessary costs and could damage the engine.

! Do not refuel with low-grade fuel and do not use fuel additives that are not tested and approved for Mercedes-Benz vehicles. Damage or malfunctions can result that are not covered:

- by the Mercedes-Benz Limited Warranty
- by an existing Limited Warranty
- by an extended Limited Warranty

Engine oil

Points to remember

The engine oils are matched to the performance of Mercedes-Benz engines and service intervals. For this reason, only use engine oils and oil filters that are approved for vehicles with a service system.

Contact an authorized Mercedes-Benz Center or visit <http://www.mbusa.com> (USA only) for a list of approved engine oils and oil filters.

! Never use engine oil or an oil filter of a specification other than is necessary to fulfill the prescribed service intervals. Do not change the engine oil or oil filter in order to achieve longer replacement intervals than those prescribed. Otherwise, you may cause damage to the engine or

exhaust gas aftertreatment; this is not covered by the Mercedes-Benz Limited Warranty.

Follow the instructions in the service interval display regarding the oil change. Otherwise, you may damage the engine and the exhaust gas aftertreatment.

Mercedes-Benz recommends MOBIL OIL.

The table shows which engines oil have been approved for your vehicle.

Model	Engine model	MB Approval
GLK 350 ³⁸	272	229.5
GLK 350 4MATIC	272	229.5

i MB Approval is stated on the containers.

Lubricant additives

! Do not mix any lubricant additives with the engine oil. This could damage the engine. Damage resulting from the use of such lubricant additives in the engine oil is not covered by the Mercedes-Benz Limited Warranty.

Engine oil viscosity

Viscosity describes the flow characteristics of a fluid. If an engine oil has a high viscosity, this means that it is thick; a low viscosity means that it is thin.

Using the table below, make sure that the SAE classification (viscosity) is sufficient for the temperatures at which the vehicle is operated. The low temperature characteristics of engine oils can deteriorate significantly, e.g. by aging, soot and fuel deposits. It is therefore recommended that you carry out oil changes regularly using an approved engine oil with the appropriate SAE classification.

³⁸ USA only.

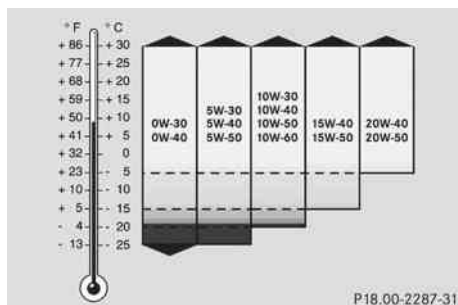

Refrigerant of the air-conditioning system

The air-conditioning system is filled with R134a refrigerant and a special PAG lubricant.

! Never use refrigerant R 12 (CFC) or mineral lubricants. Otherwise, you could damage the air-conditioning system.

Brake fluid

Warning!

The brake fluid constantly absorbs moisture from the air; this lowers its boiling point.

If the boiling point of the brake fluid is too low, vapor pockets may form in the brake system when the brakes are applied hard (e.g. when driving downhill). This would impair braking efficiency.

You should have the brake fluid renewed at regular intervals. The brake fluid change intervals can be found in the Service Booklet.

Only use brake fluid approved by Mercedes-Benz. Information about approved brake fluids can be obtained from any authorized Mercedes-Benz Center.

Coolant

Important safety notes

The coolant is a mixture of water and antifreeze/corrosion inhibitor. It performs the following tasks:

- anti-corrosion protection
- antifreeze protection
- raising the boiling point

The cooling system is filled with coolant at the factory which contains antifreeze/corrosion inhibitor that ensures protection down to approximately -35 °F (-37 °C).

! Only add coolant that has been premixed with the desired antifreeze protection. You could otherwise damage the engine.

Further information on coolants and on filling can be found in the Mercedes-Benz Specifications for Service Products, MB Approval 310.1, e.g. on the Internet at <http://bevo.mercedes-benz.com>. You can also consult an authorized Mercedes-Benz Center.

! Always use a suitable coolant mixture, even in countries where high temperatures prevail.

Otherwise, the cooling system will not be sufficiently protected from corrosion, and the boiling point will be too low.

If the coolant has antifreeze protection down to -35 °F (-37 °C), the boiling point of the coolant in the pressurized system is approximately 266 °F (130 °C).

Your vehicle has a range of aluminum components. Use of aluminum components in the engine make it necessary to specifically match the antifreeze/corrosion inhibitor in these systems in order to protect the aluminum parts. Using other antifreeze/corrosion inhibitors without these characteristics affects the service life.

The coolant must be used throughout the year in order to maintain the necessary corrosion protection and provide protection from

overheating. In the Service Booklet, you can find information on the intervals for renewal.

The renewal interval is determined by the coolant type and the cooling system design. The renewal interval in the Service Booklet is only valid if the coolant is added or renewed with Mercedes-Benz approved products.

Therefore, only use MB 326.0 antifreeze/corrosion inhibitor or another Mercedes-Benz approved product of the same specification.

Information on other Mercedes-Benz approved products of the same specification can be obtained at any authorized Mercedes-Benz Center or on the Internet at

<http://bevo.mercedes-benz.com>.

The coolant is checked at every service date at an authorized Mercedes-Benz Center.

The antifreeze/corrosion inhibitor concentration in the cooling system should:

- be at least 50%. This will protect the cooling system against freezing down to around -35°F (-37°C).
- not exceed 55% (antifreeze protection down to -49°F (-45°C)); otherwise, heat will not be dissipated as effectively.

If the coolant level is too low, MB 326.0 antifreeze/corrosion inhibitor should be added. Have the cooling system checked for leaks.

Windshield and headlamp cleaning system

Warning

Washer solvent/antifreeze is highly flammable. Do not spill washer solvent/antifreeze on hot engine parts, because it may ignite and burn. You could be seriously burned.

- ▶ Use MB Windshield Washer Concentrate MB SummerFit.
- ▶ **At temperatures above freezing:** add 1 part MB SummerFit to 100 parts water, e.g. 1.34 fl oz (40 ml) MB SummerFit to 1 gal (4.0 l) of water.
- ▶ **At temperatures below freezing:** add 1 part MB SummerFit to 100 parts washer fluid, e.g. 1.34 fl oz (40 ml) MB SummerFit to 1 gal (4.0 l) of water.

Vehicle data

Vehicle data, GLK 350

The data quoted here refers specifically to a vehicle with standard equipment. Contact an authorized Mercedes-Benz Center for the data for all vehicle variants and trim levels.

-  This vehicle is only available in the USA.

Vehicle dimensions, GLK 350

Vehicle length	178.3 in (4528 mm)
	179.4 in (4556 mm) ³⁹
Vehicle width including exterior mirrors	79.4 in (2016 mm)
Vehicle height	66.5 in (1688 mm)
	66.4 in (1686 mm) ³⁹
Wheel base	108.5 in (2755 mm)
Front track	61.7 in (1568 mm)
Rear track	62.5 in (1589 mm)
Ground clearance	8.2 in (208 mm) ⁴⁰
Turning circle	37.7 ft (11.5 m)

³⁹ Vehicles with the AMG Sports package.

⁴⁰ When the vehicle is loaded and ready to drive: fuel tank full, all fluids filled, with driver.

Vehicle weight, GLK 350

Maximum roof load	Maximum 165 lb (75 kg)
--------------------------	------------------------

Vehicle data, GLK 350 4MATIC

The data quoted here refers specifically to a vehicle with standard equipment. Contact an authorized Mercedes-Benz Center for the data for all vehicle variants and trim levels.

Vehicle dimensions, GLK 350 4MATIC

Vehicle length	178.3 in (4528 mm)
	179.4 in (4556 mm) ⁴¹
Vehicle width including exterior mirrors	79.4 in (2016 mm)
Vehicle height	66.5 in (1688 mm)
	66.4 in (1686 mm) ⁴¹
Wheel base	108.5 in (2755 mm)
Front track	61.7 in (1568 mm)
Rear track	62.5 in (1589 mm)
Ground clearance	8.2 in (208 mm) ⁴²
Turning circle	37.7 ft (11.5 m)

Vehicle weight, GLK 350 4MATIC

Maximum roof load	Maximum 165 lb (75 kg)
--------------------------	------------------------

⁴¹ Vehicles with the AMG Sports package.

⁴² When the vehicle is loaded and ready to drive: fuel tank full, all fluids filled, with driver.

Publication details

Internet

Further information about Mercedes-Benz vehicles and about Daimler AG can be found on the following websites:

<http://www.mbusa.com> (USA only)

<http://www.mercedes-benz.ca> (Canada only)

Editorial office

Not to be reprinted, translated or otherwise reproduced, in whole or in part, without the written permission of Daimler AG.



2045845481

Order no. 6515 0724 13 Part no. 204 584 54 81 Edition A 2011