



G-Class

Operator's Manual



Mercedes-Benz

Symbols

Registered trademarks:

- BabySmart™ is a registered trademark of the Siemens Automotive Corp.
- Bluetooth® is a registered trademark of the Bluetooth SIG Inc.
- ESP® is a registered trademark of Daimler AG.
- HomeLink® is a registered trademark of Prince, a Johnson Controls Company.
- SIRIUS and related brands are registered trademarks of SIRIUS XM Radio Inc.

In this Operator's Manual, you will find the following symbols:

Warning

Warning notices draw your attention to hazards that endanger your health or life, or the health or life of others.

- !** Warning notices draw your attention to hazards that could cause damage to your vehicle.
- i** This symbol indicates useful instructions or further information that could be helpful to you.
- ▶** This symbol designates an instruction you must follow.
- ▶** Several consecutive symbols indicate an instruction with several steps.
- ▷** Page This symbol tells you where you can find further information on a topic.
- ▷▷** This symbol indicates a warning or an instruction that is continued on the next page.

Display This font indicates a display message in the multifunction display/COMAND display.

Welcome to the world of Mercedes-Benz

Before you drive off, please familiarize yourself with your vehicle and read this manual, especially the safety and warning notices. This will help you to obtain the maximum pleasure from your vehicle and avoid endangering yourself and others.

The equipment or model designation of your vehicle may differ according to:

- model
- order
- country variant
- availability

Mercedes-Benz is constantly updating its vehicles to the state of the art.

Mercedes-Benz therefore reserves the right to introduce changes in the following areas:

- design
- equipment
- technical features

Therefore, you cannot base any claims on the illustrations or text content in this Operator's Manual.

The following are integral components of the vehicle:

- Operator's Manual
- Brief Instructions¹
- Service Booklet
- Equipment-dependent supplements

Keep these documents in the vehicle at all times. When you sell the vehicle, always pass the documents on to the new owner.

The technical documentation team at Daimler AG wishes you safe and pleasant motoring.

Mercedes-Benz USA, LLC

Mercedes-Benz Canada, Inc.

A Daimler Company

¹ Canada only.

Index	4	At a glance	23
Introduction	17	Safety	33
		Opening and closing	61
		Seats, steering wheel and mirrors	75
		Lights and windshield wipers	89
		Climate control	105
		Driving and parking	115
		On-board computer and displays	155
		Loading, stowing and features	191
		Maintenance and care	213
		Roadside Assistance	227
		Wheels and tires	245
		Technical data	273

1, 2, 3 ...	
115 V socket	201
12 V socket	200
4ETS (Electronic Traction System)	
Function/notes	58
4MATIC (permanent four-wheel drive)	149
A	
ABS (Anti-lock Brake System)	
Display message	171
ABS (Anti-lock Braking System)	
Function/notes	56
Warning lamp	185
Accident (notes)	229
Active service system	
see Service interval display	
Additives	
Engine oil	279
Adjusting the seat	78
Air bag	
PASSENGER AIR BAG	
OFF-indicator lamp	39
Air bags	
Front air bag (driver, front passenger)	37
Important safety notes	36
Safety guidelines	35
Window curtain air bag	39
Air-conditioning system	
see Climate control	
Air pressure	
see Tire pressure	249
Air vents	113
Important safety notes	112
Rear	113
Setting the center air vents	113
Setting the side air vents	113
see Air outlets	
Alarm system	
see ATA	
Anti-lock Braking System	
see ABS	
Anti-Theft Alarm system	
see ATA	

Anti-theft system	
ATA (Anti-Theft Alarm system)	59
Tow-away alarm	60
Ashtray	198
ATA (Anti-Theft Alarm system)	
Activating/deactivating	59
Function	59
Switching off the alarm	59
AUTO lights	
Display message	172
Automatic car wash	221
Automatic transmission	
Driving tips	123
Emergency running mode	126
Important safety notes	121
Kickdown	123
Malfunction	126
Pulling away	118
Releasing the parking lock	
manually	126
Selector lever	122
B	
backup lamp	
Display message	174
BAS (Brake Assist System)	56
Battery	
Charging	236
Checking (SmartKey)	64
Display message	176
Important safety guidelines	
(SmartKey)	64
Jump-starting	238
Maintenance (vehicle)	235
Replacing (SmartKey)	64
Battery (vehicle)	
Important safety notes	235
Belt	
see Seat belts	
Brake fluid	
Display message	171
Notes	280
Brake fluid level	219
Brake lamp (display message)	172
Brakes	
ABS	56
BAS	56

- Brake fluid (notes) 280
 - Display messages 171
 - High-performance brake system 139
 - Important safety notes 137
 - Maintenance 138
 - Parking brake 135, 139
 - Warning lamp 183
 - Breakdown**
see Accident (notes)
 - Brush guard** 207
 - Bulbs**
Backup lamp 101
 - Brake lamp 100
 - Cornering light function 98
 - fog lamps 98
 - Overview 97
 - rear fog lamp 101
 - Tail lamp 100
 - Turn signal lamp 99
- C**
- CAC**
(Customer Assistance Center) 20
 - California**
Important notice for retail
customers and lessees 18
 - Capacities**
see Technical data
 - Care**
Carpets 226
 - Car wash 221
 - Chrome parts 224
 - Display 224
 - Gear or selector lever 225
 - Headlamps 224
 - Matte finish 223
 - Notes 220
 - Paint 222
 - Plastic trim 225
 - Power washer 222
 - Rear view camera 224
 - Roof lining 226
 - Seat belt 226
 - Seat covers 225
 - Sensors 224
 - Steering wheel 225
 - Tail pipes 224
 - Trim strips 225
 - Washing by hand 222
 - Wheels 222
 - Windows 223
 - Wiper blades 223
 - Wooden trim 225
 - Cargo compartment enlargement** ... 194
 - Cargo tie down rings** 196
 - CD player/CD changer**
Operating (on-board computer) 161
 - Center console**
Overview 29
 - Central locking**
Automatic locking (on-board
computer) 165
 - SmartKey 62
 - Changing bulbs**
Headlamps 96
 - Changing gears** 123
 - Checklist**
After driving off-road 143
 - Before driving off-road 143
 - Checklist (off-road driving)** 143
 - Child-proof locks**
Rear doors 54
 - Children**
In the vehicle 49
 - Restraint systems 50
 - Child seat**
Automatic recognition 39
 - Automatic recognition/air bag
deactivation, self-test 41
 - LATCH-type (ISOFIX) child seat
anchors 52
 - Special seat belt retractor 51
 - Top Tether 53
 - Troubleshooting 42
 - Chrome parts (cleaning
instructions)** 224
 - Cigarette lighter** 199
 - Climate control**
Activating/deactivating 108
 - Activating/deactivating air-
recirculation mode 111
 - Controlling automatically 109
 - Cooling with air dehumidification . . 108
 - Defrosting the windshield 110

Demisting the windows	110
Dual-zone automatic climate control	107
Important safety notes	106
Indicator lamp	109
Problems with "cooling with air dehumidification"	109
Problems with the rear window heating	111
Refrigerant	279
Setting the air distribution	109
Setting the airflow	110
Setting the air vents	113
Setting the temperature	109
Switching the rear window defroster on/off	111
Switching the residual heat function on/off	112
Windshield defroster	110
Cockpit	
Overview	25
Consumption statistics (on-board computer)	166
Convenience closing feature	71
Convenience opening feature	71
Coolant (engine)	
Checking the level	217
Display message	174
Notes	280
Temperature gauge	156
Cooling	
see Climate control	
Cornering lamps	94
Correct use	20
Cruise control	
Cruise control lever	147
Display message	178
Function/notes	147
Cup holders	197
Customer Assistance Center (CAC)	20
Customer Relations Department	20

D

Daytime running lamps	
Switching on/off (on-board computer)	164
Delayed switch-off	
Exterior lighting (on-board computer)	164
Interior lighting (on-board computer)	165
Demisting the windshield	110
Differential locks	129
Digital speedometer	160
Display (cleaning instructions)	224
Display messages	
Calling up (on-board computer)	169
Clearing (on-board computer)	169
Driving systems	178
Safety systems	170
Service interval display	219
Distance recorder	160
Door	
Automatic locking	68
Automatic locking (on-board computer)	165
Display message	181
Emergency locking	68
Emergency unlocking	68
Opening (from inside)	67
Door control panel	
Overview	31
Doors	
Important safety notes	67
Drinking and driving	136
Drinks holder	
see Cup holders	197
Driving abroad	90
Driving in mountainous terrain	
Approach/departure angle	145
Driving downhill	146
Gradient-climbing capability (maximum)	146
Driving on flooded roads	140

- Driving safety system**
 - EBD (Electronic Brake force Distribution) 59
 - ESP® (Electronic Stability Program) 57
 - Important safety information 55
 - Driving safety systems**
 - 4ETS (Electronic Traction System) ... 58
 - ABS (Anti-lock Braking System) 56
 - BAS (Brake Assist System) 56
 - Overview 55
 - Driving systems**
 - Cruise control 147
 - Rear view camera 152
 - Driving tips** 123
 - Braking 139
 - Downhill gradients 137
 - Driving on flooded roads 140
 - Driving on sand 144
 - Driving on wet roads 140
 - Driving over obstacles 145
 - Off-road driving 142
 - Off-road fording 140
 - Tire ruts 144
 - Wet road surface 138
 - Winter 141
 - DVD audio (on-board computer)** 161
- E**
- EASY-ENTRY feature** 84
 - Activating/deactivating (on-board computer) 165
 - EASY-EXIT feature** 84
 - EBD (Electronic Brake force Distribution)**
 - Function/notes 59
 - Electrical fuses**
 - see Fuses
 - Electronic Brake force**
 - see EBD
 - Electronic Stability Program**
 - see ESP®
 - Electronic Traction Support**
 - see 4ETS
 - Emergency call**
 - see mbrace
 - Emergency release**
 - Fuel filler flap 133
 - Vehicle 68
 - Emergency running mode**
 - Automatic transmission 126
 - Emergency tensioning device**
 - Function 49
 - Safety guidelines 35
 - Emissions purification**
 - Service and warranty information 17
 - Engine**
 - Display message 174
 - Irregular running 120
 - Starting problems 120
 - Starting the engine with the SmartKey 117
 - Switching off 135
 - Warning lamp Check Engine 188
 - Engine electronics**
 - Malfunction 120
 - Engine number** 276
 - Engine oil**
 - Adding 216
 - Additives 279
 - Checking the oil level 215
 - Display message 176
 - Notes about oil grades 279
 - Viscosity 279
 - ESP® (Electronic Stability Program)**
 - Activating/deactivating 58
 - Display message 170
 - Important safety information 57
 - Exhaust check** 137
 - Exhaust tail pipe (cleaning instructions)** 224
 - Exterior lighting**
 - Delayed switch-off (on-board computer) 164
 - Exterior mirrors**
 - Adjusting 85
 - Dipping (automatic) 87
 - Malfunction 87
 - Out of position (troubleshooting) 86
 - Storing settings (memory function) 88
 - Storing the parking position 87

- Exterior view**
 Overview 24
- F**
- First-aid kit** 229
- Flat tire**
 Changing a wheel/mounting the spare wheel 232
 Preparing the vehicle 232
 Raising the vehicle 233
- Floormat** 211
- Front fog lamp (display message)** ... 173
- Fuel**
 Additives 278
 Notes 277
 Premium-grade unleaded gasoline . 278
 Refueling 131
 Specifications 278
 Troubleshooting 134
- Fuel/water separator** 220
- Fuel consumption**
 Notes 136
- Fuel filler cap (display message)** 178
- Fuel filler flap**
 Emergency release 133
 Opening/closing 132
- Fuel filter**
 Display message 178
- Fuel level**
 Calling up the range (on-board computer) 167
- Fuse allocation chart** 243
- Fuse box**
 Battery case 244
 Dashboard 243
 Front-passenger footwell 243
 Transmission tunnel 244
- Fuse extractor** 243
- Fuses**
 Dashboard fuse box 243
 Fuse allocation chart 243
 Fuse box in the front-passenger footwell 243
 Fuse box in the transmission tunnel 244
 In the battery case 244
 Notes 242
- G**
- Garage door opener**
 Clearing the memory 211
 Notes 208
 Opening/closing the garage door .. 210
 Programming the remote control ... 209
- Gear or selector lever (cleaning guidelines)** 225
- Genuine Mercedes-Benz parts** 274
- Genuine wood trim and trim strips (cleaning instructions)** 225
- Glove box** 193
- Gradient-climbing capability (maximum)** 146
- GTW (Gross Trailer Weight) (definition)** 267
- H**
- Hazard warning lamps** 93
- Headlamp cleaning system** 93
 Adding washer fluid 218
 Notes 281
- Headlamp delayed switch-off**
 see Exterior lighting delayed switch-off
- Headlamp protection grille** 100
- Headlamps**
 Cleaning 224
 Misting up 94
- Headlamps (automatic)** 91
- Head restraints**
 Adjusting (angle) 79
 Adjusting (rear) 80
 Installing/removing (rear) 80
 Luxury 80
 Resetting (front) 80
 see NECK-PRO head restraints
- Heating**
 see Climate control 106
- High beam flasher** 93
- high-mounted brake lamp**
 Display message 173
- Hill start assist** 118
- Hood**
 Closing 215
 Display message 181
 Opening 214

- Hydroplaning** 140
- I**
- Immobilizer** 59
- Instrument cluster**
- Overview 26
 - Selecting the language (on-board computer) 163
- Instrument cluster lighting** 163
- Interior lighting**
- Adjusting 94
 - Automatic control 95
 - Cargo compartment lamp 95
 - Delayed switch-off (on-board computer) 165
 - Manual control 95
 - Reading lamp 95
 - Rear interior lighting 96
- J**
- Jack**
- Storage location 229
 - Using 233
- Jump-starting** 238
- K**
- Key positions**
- SmartKey 117
- Kickdown** 123
- L**
- Lamps**
- Display message 172
- LATCH-type (ISOFIX) child seat anchors** 52
- License plate lamp (display message)** 173
- Lighting**
- see Lights 90
- Lights**
- Activating/deactivating the interior lighting delayed switch-off (on-board computer) 165
 - Cornering light function 94
 - Daytime running lamps 91
 - Display message 172
 - Driving abroad 90
 - Fog lamps 92
 - Hazard warning lamps 93
 - High-beam headlamps 93
 - Light switch 90
 - Low-beam headlamps 91
 - Rear fog lamp 92
 - Turn signals 93
- Limited Warranty** 21
- Load anchorage** 196
- Loading guidelines** 192
- Locking**
- Automatic 68
 - Emergency locking 68
 - From inside the vehicle (central locking button) 67
- Low-beam headlamp (display message)** 172
- Low-beam headlamps**
- Automatic headlamps 91
 - Driving abroad 90
- Lubricant additives**
- see Additives
- Luggage compartment**
- Cover 196
- Luggage net** 194
- Lumbar support**
- 4-way lumbar support 81
- Luxury head restraints** 80
- M**
- M+S tires** 248
- Main-beam headlamps (display message)** 173
- Maintenance**
- Battery 235
- Malfunction messages**
- see Display messages
- Malfunctions**
- see Display messages
- Malfunctions relevant to safety**
- Reporting 20
- Matte finish (cleaning instructions)** 223

mbrace

Call priority	206
Display message	170
Downloading destinations (COMAND)	206
Emergency call	203
Important safety notes	202
Locating a stolen vehicle	207
MB info call button	205
Roadside Assistance button	204
Self-test	202
System	202
Vehicle remote unlocking	206

Mechanical key

Function/notes	63
Loss	66

Memory card

Operating (on-board computer)	161
see separate operating instructions	

Memory function 88**Menu (on-board computer)**

Audio	160
DVD	161
Message memory	169
Navigation	162
Overview of menus	159
Resetting to factory settings	162
Settings	162
Standard display	160
Telephone	167
Trip computer	166

Messages

see Display messages	
----------------------	--

Mirrors

Sun visor	198
-----------------	-----

Mobile phone

Menu (on-board computer)	167
--------------------------------	-----

MP3

Operating (on-board computer)	161
see separate operating instructions	

Multicontour seat 81**Multifunction display** 158**Multifunction steering wheel** 28

Operating the on-board computer .	157
-----------------------------------	-----

N**Navigation**

On-board computer	162
see separate operating instructions	

NECK-PRO head restraints

Operation	42
Resetting after being triggered	43

Notes on breaking-in a new**vehicle** 116**Notes on driving**

Gravel roads	144
--------------------	-----

O**Occupant safety**

Children in the vehicle	49
System overview	34

Octane number (fuel) 278**Odometer** 160**Off-road**

4MATIC	149
Differential locks	129
Off-road ABS	56

Off-road driving 142

Checklist	143
Driving on sand	144
Important safety notes	142

Off-road fording 140**Oil**

see Engine oil	
----------------	--

On-board computer

Audio menu	160
Convenience submenu	165
Display messages	169
Factory settings	162
Important safety notes	156
Message memory menu	169
Navigation menu	162
Operating video DVD	161
Operation	157
Overview of menus	159
Settings menu	162
Standard display menu	160
Telephone menu	167
Trip computer menu	166
Vehicle submenu	165

On-board computer language 163

Operating safety	
Important safety note	19
Operating system	
see On-board computer	
Outside temperature	
Calling up (on-board computer)	160
Display	157
Overhead control panel	
Overview	30
Override feature	
Rear side windows	54

P

Paint code number	275
Paintwork (cleaning instructions) ...	222
Panic alarm	54
Parking	134
Parking aid	
Exterior mirror on the front- passenger side	87
Rear view camera	152
Parking brake	135
Display message	171
see Parking brake	139
Parking lamp (display message)	174
Parking lock	
releasing manually	126
Parking position	
Exterior mirror on the front- passenger side	87
Pedals	136
Permanent four-wheel drive	
see 4MATIC	
Permissible gross vehicle weight	
rating	256
Plastic trim (cleaning instructions) .	225
Power washers	222
Product information	17
Programming	
SmartKeys	63
Pulling away	
Automatic transmission	118

R

Radio	
Changing stations (on-board computer)	160
see separate operating instructions	
Range (on-board computer)	167
Rear bench seat	
Folding forward	195
Rear compartment	
Setting the air vents	113
Rear door	
Display message	181
Opening/closing	69
Rear fog lamp (display message)	173
Rear seat bench	
Folding into an upright position	195
Rear view camera	
Function/notes	152
Rear view camera (cleaning	
instructions)	224
Rear-view mirror	
Adjusting	85
Dipping (automatic)	87
Rear window heating	111
Malfunction	111
Rear window wiper	102
Refueling	131
Remote control	
Programming (garage door opener)	209
Reporting	
Malfunctions relevant to safety	20
Reserve fuel	
Display message	178
Warning lamp	188
Residual heat	
Switching on/off	112
Restraint systems	
see SRS	
Roadside Assistance (breakdown)	18
Roof carrier	197
Roof lining and carpets (cleaning	
guidelines)	226
Route	
see Route guidance (on-board computer)	

- Route guidance (on-board computer)** 162
- S**
- Safety**
- Children in the vehicle 49
 - Child restraint systems 50
 - Overview of occupant safety systems 34
- Safety systems**
- see Driving safety systems
- Seat**
- Important safety notes 77
- Seat backrest**
- Folding back 195
 - Folding forwards 195
- Seat belt**
- Fastening, front 46
 - Fastening in the rear, center 46
- Seat belts**
- Adjusting the height 47
 - Belt force limiters 49
 - Cleaning 226
 - Correct usage 44
 - Emergency Tensioning Devices 49
 - Fastening 45, 46
 - Important safety guidelines 43
 - Releasing 48
 - Safety guidelines 35
 - Special seat belt retractor 51
 - Warning lamp 184
 - Warning lamp (function) 48
- Seat heating**
- Indicator lamp (Malfunction) 82
- Seats**
- Adjusting the 4-way lumbar support 81
 - Adjusting the head restraint 79
 - Cleaning the cover 225
 - Correct driver's seat position 76
 - Multicontour seat 81
 - Storing settings (memory function) 88
 - Switching seat heating on/off 81
 - Switching the seat ventilation on/off 82
- Seat ventilation**
- Indicator lamp (Malfunction) 83
- Sensors (cleaning instructions)** 224
- Service indicator**
- see Service interval display
- Service interval display** 219
- Displaying a service message (on-board computer) 220
- Service products**
- Brake fluid 280
 - Capacities 277
 - Coolant (engine) 280
 - Engine oil 279
 - Fuel 277
 - Important safety notes 276
 - Notes 276
 - Refrigerant (air-conditioning system) 279
 - Washer fluid 281
- Settings**
- Calling up a stored setting 88
 - Factory (on-board computer) 162
 - On-board computer 162
- Setting the unit (on-board computer)**
- Speedometer 163
- Shift ranges** 123
- Side marker lamp (display message)** 173
- Side window**
- Important safety information 70
- Side windows**
- Convenience closing feature 71
 - Convenience opening feature 71
 - Opening and closing 71
 - Troubleshooting 72
- Ski rack** 197
- Sliding sunroof**
- Important safety notes 72
 - Opening/closing 73
 - Operating manually 73
- SmartKey**
- Changing the battery 64
 - Changing the programming 63
 - Checking the battery 64
 - Convenience closing feature 71
 - Convenience opening feature 71
 - Important safety notes 62

- Loss 66
 - Malfunction 66
 - Starting the engine 117
 - Snow chains** 248
 - Socket**
 - Front-passenger footwell 200
 - Luggage compartment 200
 - Rear compartment 200
 - SOS**
 - see mbrace
 - Spare fuses** 243
 - Spare wheel**
 - Exterior spare wheel bracket 230
 - Installing 232
 - Notes/data 272
 - Speedometer**
 - Additional speedometer (on-board computer) 160
 - Setting the unit (on-board computer) 163
 - SPEEDTRONIC**
 - Display-Meldung 178
 - SRS (Supplemental Restraint System)**
 - Display message 170
 - Introduction 34
 - Warning lamp 187
 - Warning lamp (function) 34
 - Standard display (on-board computer)** 160
 - Starting the engine**
 - Important safety notes 117
 - Station**
 - see Radio
 - Status line (on-board computer)** 158
 - Selecting the display 163
 - Steering wheel**
 - Adjusting 83
 - Buttons (on-board computer) 157
 - Cleaning 225
 - Important safety notes 83
 - Steering wheel heating 83
 - Storing settings (memory function) 88
 - Steering wheel heating**
 - Indicator lamp (Malfunction) 84
 - Stowage compartments**
 - Armrest (under) 193
 - Glove box 193
 - Stowage pockets 194
 - Stowage space**
 - Cup holders 197
 - Important safety information 193
 - Submenu (on-board computer)**
 - Convenience 165
 - Vehicle 165
 - Summer opening**
 - see Convenience opening feature
 - Summer tires** 248
 - Sun visor** 198
 - Supplemental Restraint System**
 - see SRS
 - Surround lighting**
 - Switching on/off (on-board computer) 164
 - SUV**
 - (Sport Utility Vehicle) 19
 - Switching air-recirculation mode on/off** 111
 - Switching off the alarm (ATA)** 59
- T**
- Tachometer** 156
 - Tail lamps**
 - Changing 100
 - Tail lamps (Display message)** 174
 - Technical data**
 - G 500 281
 - G 55 AMG 282
 - Tires 272
 - Wheels 272
 - TELEAID**
 - Call priority 206
 - Display message 170
 - Downloading destinations (COMAND) 206
 - Emergency call 203
 - Important safety notes 202
 - Locating a stolen vehicle 207
 - MB info call button 205
 - Roadside Assistance button 204
 - Self-test 202

- System 202
- Vehicle remote unlocking 206
- Telephone**
- Menu (on-board computer) 167
- Telephone compartment** 193
- Temperature**
- Coolant 156
- Displaying the outside temperature 160
- Outside temperature 157
- Setting (climate control) 109
- Theft deterrent locking system**
- Immobilizer 59
- Tilt/sliding sunroof**
- see Sliding sunroof
- Tire pressure**
- Calling up (on-board computer) 253
- Checking 252
- Checking manually 253
- Display message 179
- Maximum 252
- Notes 250
- Recommended 249
- Tire pressure monitoring system**
- Function/notes 253
- Restarting 255
- Warning lamp 189
- Tires**
- Aspect ratio (definition) 268
- Average weight of the vehicle occupants (definition) 267
- Bar (definition) 266
- Characteristics 266
- Checking 246
- Definition of terms 266
- Direction of rotation 270
- Distribution of the vehicle occupants (definition) 269
- DOT, Tire Identification Number (TIN) 265
- DOT (Department of Transportation) (definition) 266
- GAWR (Gross Axle Weight Rating) (definition) 267
- GTW (Gross Trailer Weight) (definition) 267
- GVW (Gross Vehicle Weight) (definition) 267
- GVWR (Gross Vehicle Weight Rating) (definition) 267
- Increased vehicle weight due to optional equipment (definition) 267
- Kilopascal (kPa) (definition) 268
- Labeling (overview) 262
- Load bearing index (definition) 269
- Load index 265
- Load index (definition) 268
- Maximum loaded vehicle weight (definition) 267
- Maximum load on a tire (definition) 268
- Maximum permissible tire pressure (definition) 268
- Maximum tire load 260
- Maximum tire load (definition) 268
- Optional equipment weight (definition) 268
- PSI (pounds per square inch) (definition) 268
- Replacing 269
- Service life 248
- Sidewall (definition) 268
- Speed index (definition) 267
- Storing 270
- Structure and characteristics (definition) 266
- Technical data 272
- Temperature 262
- TIN (Tire Identification Number) (definition) 269
- Tire bead (definition) 268
- Tire pressure (definition) 268
- Tire pressures (recommended) 267
- Tire size designation, load-bearing capacity, speed index 263
- Tire tread 247
- Tire tread (definition) 268
- Total load limit (definition) 269
- Traction 261
- Traction (definition) 269
- Tread wear 261
- TWR (permissible trailer drawbar noseweight) (definition) 269
- Uniform Tire Quality Grading Standards 261

Uniform Tire Quality Grading Standards (definition)	267
Unladen weight (definition)	268
Wear indicator (definition)	269
Wheel rim (definition)	267
Top Tether	53
Tow-away alarm	60
Towing	242
Important safety guidelines	240
Towing eye	
Front	240
Rear	240
Trailer loads and drawbar noseweights	260
Transfer case	
Display message	182
Shift ranges	126
Transmission position display	122
Transmission positions	122
Transporting the vehicle	241
Traveling uphill	
Brow of hill	146
Trip computer (on-board computer)	166
Trip odometer	
Calling up	160
Turn signal	
Display message	172
Turn signals	93
TWR (permissible trailer drawbar noseweight) (definition)	269
Type identification plate	
see Vehicle identification plate	

U

Ultrasonic backing up aid	
Function/notes	149
Malfunction	152
Range of the sensors	150
Warning display	150
Unlocking	
Emergency unlocking	68
From inside the vehicle (central unlocking button)	67

V

Vanity mirror	
Sun visor	198
Vehicle	
Data acquisition	21
Emergency unlocking	68
Equipment	17
Individual settings (on-board computer)	162
Loading	256
Lowering	234
Maintenance	18
Parking up	135
Raising	233
Reporting problems	20
Towing away	240
Tow-starting	240
Transporting	241
Vehicle dimensions	
Technical data	281
Vehicle identification number	
see VIN	
Vehicle identification number (VIN)	275
Vehicle identification plate	275
Vehicle tool kit	229
Vehicle weights	
Technical data	281
Ventilation	
Setting the air distribution	109
Setting the airflow	110
Video (DVD)	161
Video DVD (on-board computer)	161
VIN	275

W

Warning and indicator lamps	
ABS	185
Brakes	183
Check Engine	188
ESP® OFF	186
Fuel tank	188
PASSENGER AIRBAG OFF	39
Reserve fuel	188
Seat belt	184

SRS	187
Tire pressure monitor	189
Warranty	274
Washer fluid	
Display message	181
Wheel bolt tightening torque	234
Wheel change	
see Flat tire	232
Wheels	
Changing/replacing	269
Changing a wheel	232
Checking	246
Cleaning	222
Mounting a wheel	234
Removing a wheel	234
Storing	270
Technical data	272
Tightening torque	234
Wheels and tires	
Important safety notes	246
Window curtain air bag	
Operation	39
Windows	
see Side windows	
Windows (cleaning instructions)	223
Windshield heater	110
Windshield heating	
see Windshield defroster	
Windshield washer system	218
Notes	281
Windshield wipers	
Important safety notes	101
Replacing the wiper blades	103
Switching on/off	102
Troubleshooting	104
Winter	
Driving in winter	141
Winter operation	248
Winter operation	141
Winter tires	
M+S tires	248
Wiper blades	
Cleaning	223

Product information

Mercedes-Benz recommends that you use genuine Mercedes-Benz parts, conversion parts and accessories that have been approved for the type of vehicle.

Mercedes-Benz tests genuine parts as well as conversion parts and accessories which have been specifically approved for your vehicle for their reliability, safety and suitability. Despite ongoing market research, Mercedes-Benz is unable to assess other parts. Therefore, Mercedes-Benz accepts no responsibility for the use of such parts in Mercedes-Benz vehicles, even if they have been independently or officially approved. The use of non-approved parts could affect your vehicle's operating safety. Mercedes-Benz therefore recommends that you use genuine Mercedes-Benz parts, conversion parts and accessories that have been approved for the type of vehicle. Genuine Mercedes-Benz parts, approved conversion parts and accessories are available from an authorized Mercedes-Benz Center. Here, you will receive advice about permissible technical modifications, and the parts will be professionally installed.

Operator's Manual

Notes on the Operator's Manual

Before you first drive off, read this Operator's Manual carefully and familiarize yourself with your vehicle.

For your own safety and a longer vehicle life, follow the instructions and warning notices in this manual. Disregarding them may lead to damage to the vehicle or personal injury. Vehicle damage resulting from the disregard of the instructions is not covered by the Mercedes-Benz Limited Warranty.

Vehicle equipment

This manual describes all the standard and optional equipment of your vehicle available at the time of publication of the Operator's Manual. Country-specific differences are possible. Please note that your vehicle may not be equipped with all features described. This also applies to safety-relevant systems and functions. The equipment in your vehicle may therefore differ from that shown in the descriptions and illustrations. All the systems found in your vehicle are listed in the original purchase agreement of your vehicle. Should you have any questions concerning equipment and operation, please consult an authorized Mercedes-Benz Center.

The Operator's Manual and the Maintenance Booklet are important documents and should be kept in the vehicle.

Service and vehicle operation

Service and literature

The Limited Warranty for your vehicle applies in accordance with the warranty terms and conditions in the Service and Guarantee Booklet. Your authorized Mercedes-Benz Center will replace and repair all factory-installed parts in accordance with the following warranty terms and conditions:

- new vehicle limited warranty
- warranty on the exhaust system
- warranty on the emission values
- California, Connecticut, Maine, Massachusetts, New York, Pennsylvania, Rhode Island and Vermont warranty on the emission control system
- extended consumer protection laws which vary by state ("Lemon Laws")

Information for customers in California

In California, you have the right to exchange a vehicle or receive a refund of the purchase or leasing price if Mercedes-Benz USA, LLC and/or an authorized workshop or maintenance facility cannot, after several authorized repairs, rectify considerable damage to or malfunctions of the vehicle that are covered by the contractual warranty. Customers who purchase or lease a vehicle may have their vehicles repaired within 18 months from delivery or up until an odometer reading of 29,000 km (i.e. 18,000 miles), whichever comes first, if:

- (1) the serious defect or damage can result in deadly or serious injury to the vehicle occupants while driving AND this defect has already been repaired at least twice AND Mercedes-Benz, LLC has been informed in writing of the necessity of a repair.
- (2) the defect or damage, though less serious than (1) above, has already been repaired at least four times AND Mercedes-Benz has been informed in writing of the necessity of a repair.
- (3) the vehicle cannot be used for longer than 30 calendar days because of repair work resulting from this or other serious defects or damage.

Please send your written notice to:
 Mercedes-Benz USA, LLC
 Customer Assistance Center
 One Mercedes Drive
 Montvale, NJ 07645-0350

Maintenance

The Service and Guarantee Booklet describes all the necessary maintenance work which should be done at regular intervals. Always bring the Service and Guarantee Booklet with you when bringing the vehicle to an authorized Mercedes-Benz Center. The

customer service advisor will record every service for you in the Service and Guarantee Booklet.

Roadside Assistance

The Mercedes-Benz Roadside Assistance Program offers technical help in the case of a breakdown. Your calls to the toll-free Roadside Assistance Hotline are answered by our agents 24 hours a day, 365 days a year.

1-800-FOR-MERCEdes(1-800-367-6372) (USA)

1-800-387-0100 (Canada)

You can find further information in the Mercedes-Benz Roadside Assistance Program brochure (USA) or the "Roadside Assistance" section in the Service and Warranty booklet (Canada). You will find both in the vehicle document wallet.

In accordance with standard program guidelines, Roadside Assistance is prepared to provide vehicle service up until a reasonable distance from the next paved roadway. We will make every effort to assist in a breakdown situation. However, the accessibility of your vehicle will be determined by our authorized Mercedes-Benz Service technician or the tow service provider on a case-by-case basis.

Additional charges may be applicable for a breakdown location determined not to be a reasonably accessible roadside location as determined by our authorized technician and tow service provider.

Change of address or ownership

In the event of a change of address, please send us the "Notification of Address Change" in the Service and Guarantee Booklet or simply call the Mercedes-Benz Customer Assistance Center (USA) at the hotline number 1-800-FOR-MERCEdes(1-800-367-6372) or Customer Service Center (Canada) at

1-800-387-0100. Thus, if necessary, we can reach you in a timely fashion.

If you sell your Mercedes, please leave the entire literature in the vehicle so that it is available to the next owner.

If you have purchased a used car, please send us the "Notification of Used Car Purchase" in the Service and Guarantee Booklet or simply call the Mercedes-Benz Customer Assistance Center (USA) at the hotline number 1-800-FOR-MERCEdes(1-800-367-6372) or Customer Service (Canada) at 1-800-387-0100.

Vehicle operation outside the USA and Canada

When you are abroad with your vehicle, observe the following points:

- service points or replacement parts may not be available immediately.
- unleaded fuel for vehicles with a catalytic converter may not be available. Leaded fuel may cause damage to the catalytic converter.
- the fuel may have a considerably lower Anti-Knock Index. Unsuitable fuel can cause engine damage.

Some Mercedes-Benz models are available in Europe through our European Delivery Program. Please consult an authorized Mercedes-Benz Center for further information, or write to one of the following addresses.

In the USA:

Mercedes-Benz USA, LLC
European Delivery Department
One Mercedes Drive
Montvale, NJ 07645-0350

In Canada:

Mercedes-Benz Canada, Inc.
European Delivery Department
98 Vanderhoof Avenue
Toronto, Ontario M4G 4C9

Sport Utility Vehicle

Warning!

This Sport Utility Vehicle is designed for both on-road and off-road use. It can go places and perform tasks for which conventional 2-wheel drive passenger cars are not intended. This vehicle will handle and maneuver differently from conventional passenger cars in driving conditions which may occur on streets, highways and off-road use.

This vehicle has a higher ground clearance and a higher center of gravity than many passenger cars. As with other vehicles of this type, if you make sharp turns at excessive speeds or abrupt maneuvers, the vehicle may roll over or may go out of control and crash. Utility vehicles have a significantly higher rollover rate than other types of vehicles. Failure to operate this vehicle safely may result in an accident, rollover of the vehicle, and severe or fatal injury.

Before you start to drive this vehicle, read the Operator's Manual. Take time to become familiar with the driving characteristics of this vehicle. Be sure you are familiar with all vehicle controls. Learn how your vehicle handles on different road surfaces. Do not attempt sharp turns at excessive speeds or abrupt maneuvers or other unsafe driving actions that can cause loss of vehicle control. When driving off-road or working the vehicle hard, do not overload it. And, always wear your seat belts at all times. In a rollover crash, an unbelted person is significantly more likely to die than a person wearing a seat belt.

Operating Safety

Important safety notes

Warning

Work improperly carried out on electronic components and associated software could cause them to cease functioning. Because the vehicle's electronic components are interconnected, any modifications made may

produce an undesired effect on other systems. Electronic malfunctions could seriously impair the operating safety of your vehicle.

Contact an authorized Mercedes-Benz Center for repairs or modifications to electronic components.

Other improper work or modifications on the vehicle could also have a negative impact on the operating safety of the vehicle.

Some safety systems only function when the engine is running. You should therefore never turn off the engine while driving.

Warning

Heavy blows against the vehicle underbody or tires/wheels may cause serious damage and impair the operating safety of your vehicle.

Such blows can be caused, for example, by running over an obstacle, road debris or a pothole. If you feel a sudden significant vibration or ride disturbance, or you suspect that damage to your vehicle has occurred:

- turn on your hazard warning flashers.
- slow down carefully.
- drive with caution to an area which is a safe distance from the road.

Inspect the vehicle underbody and tires/wheels for possible damage. If the vehicle appears unsafe, have it towed to the nearest authorized Mercedes-Benz Center or other qualified maintenance or repair facility for further inspection or repairs.

Correct use

Observe the following information when using your vehicle:

- the safety notes in this manual
- the "Technical data" section in this manual
- traffic rules and regulations
- laws and safety standards pertaining to motor vehicles

Warning!

There are various warning stickers affixed to your vehicle. Their purpose is to alert you and others to various dangers. Therefore, do not remove any warning stickers unless the sticker clearly states that you may do so.

If you remove any warning stickers, you or others could fail to recognize certain dangers and be injured.

Problems with your vehicle

If you should experience a problem with your vehicle, particularly one that you believe may affect its safe operation, we urge you to contact an authorized Mercedes-Benz Center immediately to have the problem diagnosed and rectified. If the problem cannot be rectified to your satisfaction there, consult another authorized Mercedes-Benz Center or write to one of the following addresses.

In the USA:

Customer Assistance Center
Mercedes-Benz USA, LLC
One Mercedes Drive
Montvale, NJ 07645-0350

In Canada:

Customer Relations Department
Mercedes-Benz Canada, Inc.
98 Vanderhoof Avenue
Toronto, Ontario M4G 4C9

Reporting safety-related malfunctions

Only for the USA:

The following text is reproduced as required of all manufacturers according to Title 49, Code of U.S. Federal Regulations, Part 575 pursuant to the National Traffic and Motor Vehicle Safety Act of 1966.

Reporting safety defects:

If you believe that your vehicle has a defect which could cause a crash or could cause

injury or death, you should immediately inform the National Highway Traffic Safety Administration (NHTSA) in addition to notifying Mercedes-Benz USA, LLC.

If NHTSA receives similar complaints, it may open an investigation, and if it finds that a safety defect exists in a group of vehicles, it may order a recall and remedy campaign. However, NHTSA cannot become involved in individual problems between you, your dealer, or Mercedes-Benz USA, LLC.

To contact NHTSA, you may call the Vehicle Safety Hotline toll-free at 1-888-327-4236 (TTY: 1-800-424-9153); go to <http://www.safercar.gov>; or write to: Administrator, NHTSA Headquarters, 1200 New Jersey Avenue, SE, West Building, Washington, DC 20590.

You can find more information on vehicle safety under:

<http://www.safercar.gov>

This information serves, for example, to test vehicle systems after an accident and to continually improve vehicle safety. Daimler AG can access these data and submit them:

- for safety investigations or vehicle diagnoses
- with the agreement of the vehicle owner
- on the instruction of prosecuting authorities
- for use in arbitration of disputes that involve Daimler AG, its subsidiaries or its sales and service organizations
- on the basis of other legislation.

Please observe the mbrace² order agreement regarding further details on data that this system records and transmits.

Limited Warranty

! Follow the instructions in this manual about the proper operation of your vehicle as well as about possible vehicle damage. Damage to your vehicle that arises from culpable contraventions against these instructions are not covered either by Mercedes-Benz Limited Warranty or by the New or Used-Vehicle Warranty of Daimler AG.

Data stored in the vehicle

Information about electronic data acquisition in the vehicle

(Including California Code Supplement § 9951)

Your vehicle records electronic data. If your vehicle is equipped with mbrace² data is transmitted in the event of an accident.

² The system is called TELEAID in Canada.

Exterior view	24
Cockpit	25
Instrument cluster	26
Multifunction steering wheel	28
Center console	29
Overhead control panel	30
Door control panel	31

Exterior view

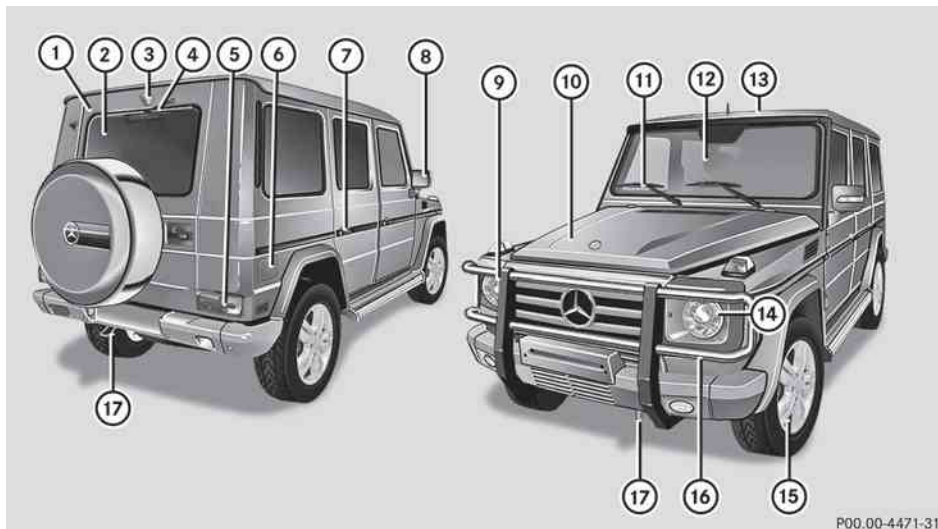

P00.00-4471-31

	Function	Page
①	Rear door	69
	Vehicle tool kit	229
②	Rear window defroster	111
③	Rear view camera	152
④	Rear window wiper	102
⑤	Rear lamps	100
⑥	Fuel filler flap	132
⑦	Opening and closing the doors	62
⑧	Exterior mirrors	85
	Parking position	87
⑨	Front lamps	98

	Function	Page
⑩	Hood	214
⑪	Windshield wipers	101
	Cleaning the wiper blades	223
	Replacing the wiper blades	103
⑫	Cleaning the windows	223
⑬	Sliding sunroof	72
⑭	Headlamp cleaning system	93
⑮	Wheels and tires	246
	Tire pressure monitor	253
⑯	Brush guard	207
⑰	Towing eyes	240

Cockpit

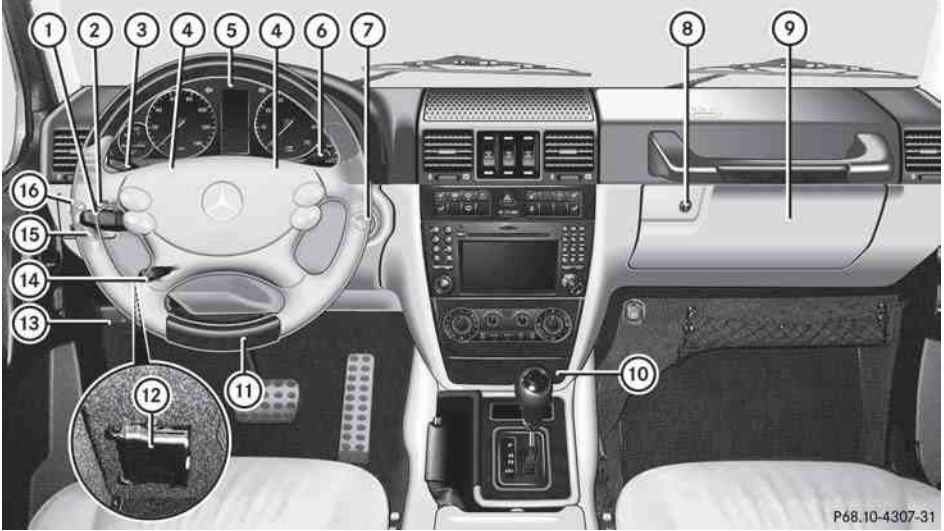

P68.10-4307-31

	Function	Page
①	Combination switch	93
②	Cleans the headlamps	93
③	Cruise control lever	147
④	Horn	
⑤	Instrument cluster	26
⑥	Voice Control System lever; see the separate operating instructions	
⑦	Ignition lock	117
⑧	Glove box lock	193
⑨	Glove box	193

	Function	Page
⑩	Center console	29
⑪	Multifunction steering wheel	28
⑫	On-board diagnostics connection	
⑬	Opens the hood	214
⑭	Adjusts the steering wheel Steering wheel heating	83
⑮	Light switch	90
⑯	Adjusts the exterior mirrors	85

Instrument cluster

Overview

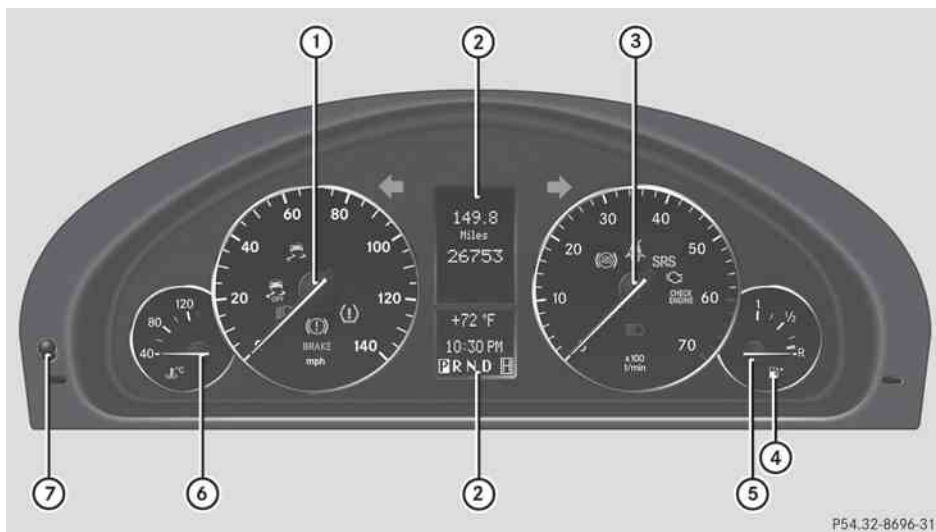

P54.32-8696-31

	Function	Page
①	Speedometer	
②	Multifunction display	158
③	Tachometer	156
④	Fuel filler flap location indicator: the fuel filler cap is to the rear on the right.	131

	Function	Page
⑤	Fuel gauge	
⑥	Coolant temperature gauge	156
⑦	Reset button	160

Warning and indicator lamps

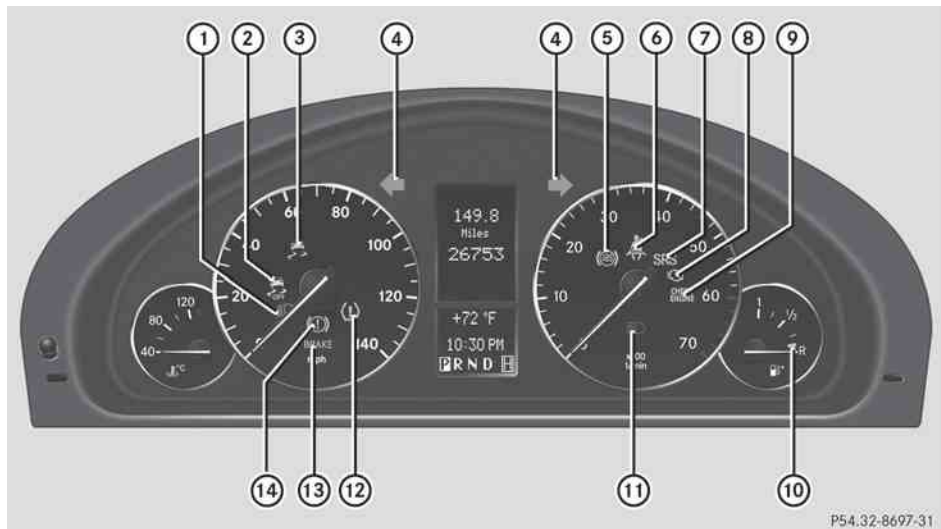

P54.32-8697-31



	Function	Page
①	Low-beam headlamps	91
②	ESP® OFF	186
③	ESP®	185
④	Turn signal	93
⑤	ABS	185
⑥	Seat belt	184
⑦	SRS	187
⑧	Engine diagnostics (Canada only)	188

	Function	Page
⑨	Engine diagnostics (USA only)	188
⑩	Reserve fuel	188
⑪	High-beam headlamps	93
⑫	Tire pressure monitor	189
⑬	Brakes (USA only)	183
⑭	Brakes (Canada only)	183

Multifunction steering wheel

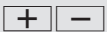

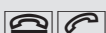
	Function	Page
①	Multifunction display	158
②	COMAND; see the separate operating instructions	
③	 Selects submenus in the Settings menu Changes values Adjusts the volume	162

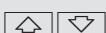
	Function	Page
④	 Makes/accepts or rejects/ends a call	167
⑤	 Selects a menu: scrolls back and forth	159
⑥	 Scrolls back and forth within a menu	159

Center console

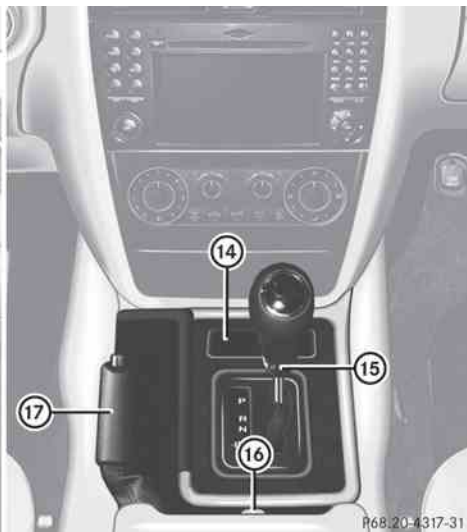
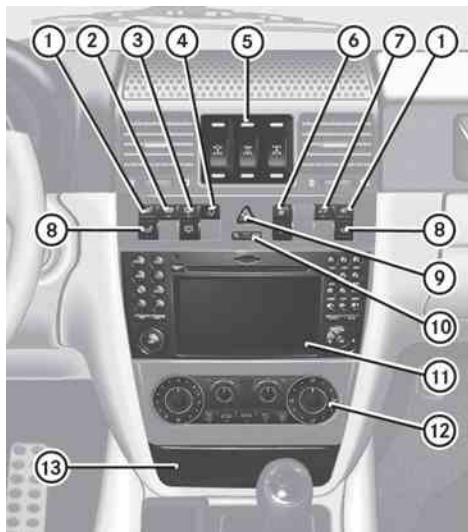

P68.20-4317-31

	Function	Page
①	Seat heating	81
②	Windshield heating	110
③	Rear window wiper	102
④	ESP® OFF	57
⑤	Engages the differential locks	129
⑥	Locks/unlocks centrally	67
⑦	Anti-theft Alarm System (ATA)	60
	Tow-away alarm	60
⑧	Seat ventilation	82
⑨	Hazard warning lamps	93
⑩	PASSENGER AIRBAG OFF indicator lamp	39

	Function	Page
⑪	COMAND; see separate operating instructions	
⑫	Dual-zone automatic climate control	107
⑬	Ashtray	198
	Cigarette lighter	199
⑭	Stowage tray	
⑮	Automatic transmission selector lever	122
⑯	Transfer case switch	126
⑰	Parking brake	135

Overhead control panel

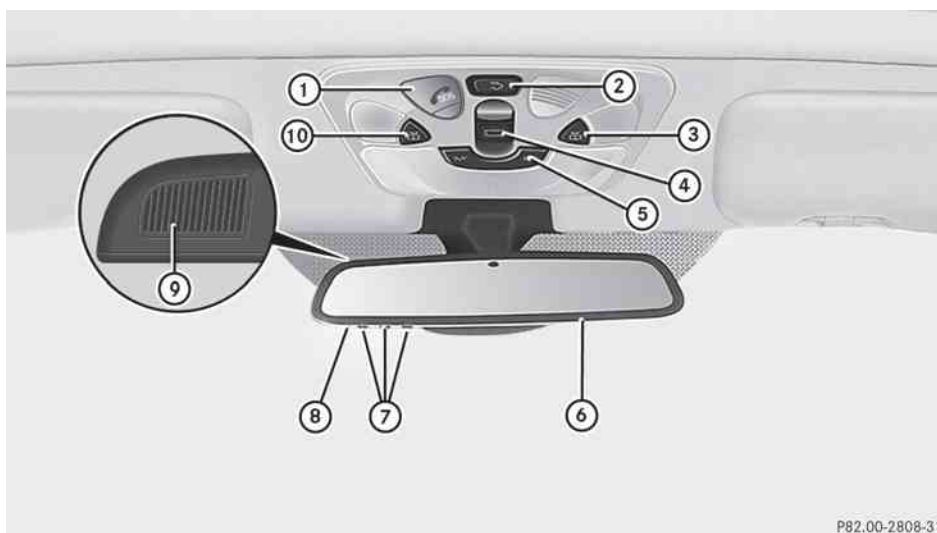

P82.00-2808-31

	Function	Page
①	SOS button (mbrace system)	203
②	To switch the cargo compartment lamp/rear interior lighting on/off	95
③	To switch the right-hand reading lamp on/off	95
④	To open/close the sliding sunroof	72
⑤	Rocker switch (to control the interior lighting)	94

	Function	Page
⑥	Rear-view mirror	85
⑦	Transmitter buttons for the garage door opener	208
⑧	Indicator lamp for the garage door opener	208
⑨	Microphone for mbrace (emergency call system) ³ , telephone and Voice Control System ⁴	
⑩	To switch the left-hand reading lamp on/off	95

³ The system is called TELE AID in Canada.

⁴ See the separate operating instructions.

Door control panel

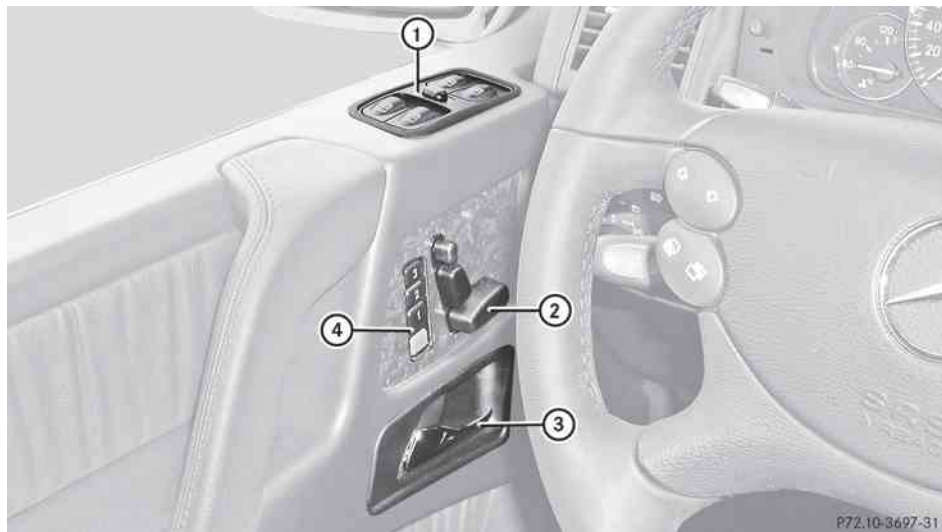

P7Z.10-3697-31

	Function	Page
①	 Opens/closes the side windows Activates/deactivates the override feature for the side windows in the rear compartment	71 54
②	Adjusts the seat electrically	78
③	Opens the door	67
④	Stores settings for the seat, exterior mirrors and steering wheel	88

Vehicle equipment	34
Occupant safety	34
Children in the vehicle	49
Panic alarm	54
Driving safety systems	55
Anti-theft systems	59

Vehicle equipment

i This manual describes all the standard and optional equipment of your vehicle which was available at the time of purchase. Country-specific differences are possible. Please note that your vehicle may not be equipped with all features described. This also applies to safety-relevant systems and functions.

Occupant safety

Overview of occupant safety



In this section you will learn the most important facts about the restraint system components of the vehicle.

The restraint system consists of:

- seat belts
- child restraint systems
- ISOFIX child seat securing system

Additional protection is provided by:

- SRS (Supplemental Restraint System)
- NECK-PRO head restraints
- air bag system components with:

-   indicator lamp
- front-passenger seat with BabySmart™ automatic child recognition

The different air bag systems work independently of each other. The protective functions of the system work in conjunction with each other. Not all air bags are deployed in an accident.

Warning

Modifications to or work improperly conducted on restraint system components or their wiring, as well as tampering with interconnected electronic systems, can lead to the restraint systems no longer functioning as intended.

Air bags or Emergency Tensioning Devices (ETDs), for example, could deploy inadvertently or fail to deploy in accidents

although the deceleration threshold for air bag deployment is exceeded. Therefore, never modify the restraint systems. Do not tamper with electronic components or their software.

i See "Children in the vehicle" (▷ page 49) for further information on infants and children traveling in the vehicle as well as on child restraint systems.

SRS (Supplemental Restraint System)

Introduction

SRS reduces the risk of occupants coming into contact with the vehicle's interior in the event of an accident. It can also reduce the effect of the forces to which occupants are subjected during an accident.

SRS consists of:

- the  SRS warning lamp
- air bags
- air bag control unit (with crash sensors)
- belt tensioners
- belt force limiters

SRS warning lamp

The SRS functions are checked regularly when the SmartKey is in position **1** or **2** in the ignition lock. Therefore, malfunctions can be detected in good time.

The  SRS warning lamp in the instrument cluster lights up:

- for approximately four seconds when you turn the SmartKey to position **1** in the ignition lock

This indicates that the restraint systems are operational.

- permanently when you turn the SmartKey to position **2** in the ignition lock

This indicates that the  SRS warning lamp is operational.

 **Warning**

The SRS self-check has detected a malfunction if the **SRS** SRS warning lamp:

- does not come on at all
- fails to go out approximately 4 seconds after the engine was started
- comes on after the engine was started or while driving

For your safety, Mercedes-Benz strongly recommends that you have the system checked as soon as possible at an authorized Mercedes-Benz Center. Otherwise the SRS may not be activated when it is needed in an accident, which could result in serious or fatal injury. The SRS might also deploy unexpectedly and unnecessarily which could also result in injury.

In addition, improper work on the SRS creates a risk of rendering the SRS inoperative or causing unintended air bag deployment. Work on the SRS must therefore only be performed by qualified technicians. Contact an authorized Mercedes-Benz Center.

If it is necessary to modify an air bag system to accommodate a person with disabilities, contact an authorized Mercedes-Benz Center for details. USA only: Call our Customer Assistance Center at 1-800-FOR-MERCEdes (1-800-367-6372) for details.

Safety guidelines for seat belts, belt tensioners (ETDs) and air bags

 **Warning**

- Damaged seat belts or seat belts that have been subjected to stress in an accident must be replaced. Their anchoring points must also be checked. Only use seat belts installed or supplied by an authorized Mercedes-Benz Center.
- Air bags and pyrotechnic Emergency Tensioning Devices (ETDs) contain perchlorate material, which may require special handling and regard for the environment. Check your national disposal

guidelines. California residents, see www.dtsc.ca.gov/HazardousWaste/Perchlorate/index.cfm.

- Air bags and ETDs are designed to function on a one-time-only basis. An air bag or ETD that has deployed must be replaced.
- Do not pass seat belts over sharp edges. They could tear.
- Do not make any modification that could change the effectiveness of the seat belts.
- Do not bleach or dye seat belts as this may severely weaken them. In a crash they may not be able to provide adequate protection.
- No modifications of any kind may be made to any components or wiring of the SRS.
- Do not change or remove any component or part of the SRS.
- Do not install additional trim material, seat covers, badges, etc. over the steering wheel hub, front-passenger front air bag cover, outer sides of the seat backrests, door trim panels, or door frame trims.
- Do not install additional electrical/electronic equipment on or near SRS components and wiring.
- Keep area between air bags and occupants free of objects (e.g. packages, purses, umbrellas, etc.).
- Do not hang items such as coat hangers from the coat hooks or handles over the door. These items may be thrown around in the vehicle and cause head and other injuries when the window curtain air bag is deployed.
- Air bag system components will be hot after an air bag has inflated. Do not touch them.
- Never place your feet on the instrument panel, dashboard, or on the seat. Always keep both feet on the floor in front of the seat.
- Improper repair work on the SRS creates a risk of rendering the SRS inoperative or causing unintended air bag deployment. Work on the SRS must therefore only be performed by qualified technicians.

Contact an authorized Mercedes-Benz Center.

- For your protection and the protection of others, when scrapping the air bag unit or ETD, our safety instructions must be followed. These instructions are available from any authorized Mercedes-Benz Center.
- Given the considerable deployment speed, required inflation volume, and the material of the air bags, there is the possibility of abrasions or other, potentially more serious injuries resulting from air bag deployment.

If you sell your vehicle, Mercedes-Benz strongly recommends that you inform the subsequent owner that the vehicle is equipped with SRS. Also, refer them to the applicable section in the Operator's Manual.

Air bags

Important safety notes

Warning!

Air bags are designed to reduce the potential of injury and fatality in certain

- frontal impacts (front air bags)
- side impacts (window curtain air bags)

However, no system available today can completely eliminate injuries and fatalities.

Deployment of the air bags temporarily releases a small amount of dust from the air bags. This dust, however, is neither harmful to your health, nor does it indicate a fire in the vehicle. The dust might cause some temporary breathing difficulty for people with asthma or other breathing trouble. To avoid this, you may wish to get out of the vehicle as soon as it is safe to do so. If you have any breathing difficulty but cannot get out of the vehicle after the air bag inflates, then get fresh air by opening a window or door.

Warning!

To reduce the risk of injury when the front air bags inflate, it is very important for the driver and front passenger to always be in a properly seated position and to wear their respective seat belt.

For maximum protection in the event of a collision always be in normal seated position with your back against the seat backrest. Fasten your seat belt and make sure it is properly positioned on your body.

Since the air bag inflates with considerable speed and force, a proper seating position and correct positioning of the hands on the steering wheel will help to keep you at a safe distance from the air bag. Occupants who are not wearing their seat belt, are not seated properly or are too close to the air bag can be seriously injured or killed by an air bag as it inflates with great force instantaneously:

- Sit with the seat belt properly fastened in a position that is as upright as possible with your back against the seat backrest.
- Move the driver's seat as far back as possible, still permitting proper operation of vehicle controls. The distance from the center of the driver's chest to the center of the air bag cover on the steering wheel must be at least 10 inches (25 cm) or more. You should be able to accomplish this by adjusting the seat and steering wheel. If you have any difficulties, please contact an authorized Mercedes-Benz Center.
- Do not lean your head or chest close to the steering wheel or dashboard.
- Keep hands on the outside of the steering wheel rim. Placing hands and arms inside the rim can increase the risk and potential severity of hand/arm injury when the driver front air bag inflates.
- Adjust the front passenger seat as far as possible rearward from the dashboard when the seat is occupied.
- Occupants, especially children, should never place their bodies or lean their heads

in the area of the door where the window curtain air bag inflates. This could result in serious injuries or death should the window curtain air bag be deployed. Always sit as upright as possible, wear the seat belt properly and use an appropriately sized infant restraint, toddler restraint, or booster seat recommended for the size and weight of the child.

- Children 12 years old and under must never ride in the front seat, except in a Mercedes-Benz authorized BabySmart™ compatible child seat, which operates with the BabySmart™ air bag deactivation system installed in the vehicle to deactivate the front passenger front air bag when it is installed properly. Otherwise they will be struck by the air bag when it inflates in a crash. If this happens, serious or fatal injury will result.

Failure to follow these instructions can result in severe injuries to you or other occupants.

If you sell your vehicle, it is important that you make the buyer aware of this safety information. Be sure to give the buyer this Operator's Manual.

Warning!

Accident research shows that the safest place for children in an automobile is in a rear seat. Should you choose to place a child 12 years old or under in the front passenger seat of your vehicle, you must properly use a BabySmart™ child restraint which will turn off the front passenger front air bag.

To help avoid the possibility of injury, please follow these guidelines:

- (1) Always sit as upright as possible, wear the seat belt properly, and for children 12 years old and under, use an appropriately sized infant restraint, toddler restraint, or booster seat recommended for the size and weight of the child.
- (2) Always wear seat belts properly.

The air bags are only deployed if the air bag control unit detects the need for deployment. Only in the event of such a situation will they provide their supplemental protection.

The driver and passenger should always wear their seat belts. Otherwise, it is not possible for the air bags to provide their supplemental protection.

In the event of other types of impacts and impacts below air bag deployment thresholds, the air bags will not deploy. The driver and passengers will then be protected to the extent possible by a properly fastened seat belt. A properly fastened seat belt is also needed to provide the best possible protection in a rollover.

Air bags provide additional protection; they are not, however, a substitute for seat belts. All vehicle occupants must fasten their seat belts regardless of whether your vehicle is equipped with air bags or not.

It is important for your safety and that of your passenger to have deployed air bags replaced and to have any malfunctioning air bags repaired. This will help to make sure the air bags continue to perform their protective function for the vehicle occupants in the event of a crash.

Front air bags

Warning

Observe "Important safety notes" (> page 36).

The front air bags increase protection for the driver's and front-passenger's head, neck and chest.



Driver's air bag ① deploys in front of the steering wheel; front-passenger front air bag ② deploys in front of and above the glove box.

They are deployed:

- in the event of certain frontal impacts
- if the system determines that air bag deployment can offer additional protection to that provided by the seat belt
- if the seat belt is fastened
- independently of other air bags in the vehicle

If the vehicle overturns, the front air bags are generally not deployed unless the system detects high vehicle deceleration in a longitudinal direction.

Your vehicle has an adaptive, two-stage driver's air bag. In the event of a collision, the air bag control unit evaluates the vehicle deceleration. When the first deployment threshold is reached, the front air bag is filled with enough propellant gas to reduce the risk of injuries. The front air bag is fully deployed if a second deployment threshold is exceeded within a few milliseconds.

The front air bags will not deploy in impacts with vehicle deceleration or acceleration rates which do not exceed the system's preset deployment thresholds for vehicle deceleration or acceleration. You will then be protected by the fastened seat belt.

The front-passenger front air bag will only deploy if:

- the front-passenger seat is occupied.
- the  indicator lamp in the center console is not lit (> page 39).
- the impact exceeds a preset deployment threshold.



The front-passenger air bag is automatically enabled and disabled. Both driver and passenger should always check whether the front-passenger air bag is enabled or disabled.

The deployment of the driver's air bag does not mean that the front-passenger air bag will also deploy. If the system recognizes that the front-passenger seat is empty, the front-passenger air bag does not deploy even if the impact fulfills the criteria and the driver's air bag has deployed.

If the front-passenger seat is recognized as occupied, the  indicator lamp lights up for approximately six seconds if

- you turn the SmartKey to position 1 or 2 in the ignition lock.
- the engine is running and then you switch it off.

This indicates the operational readiness of the front-passenger air bag.

Note that objects placed on the front-passenger seat may cause the system to recognize the seat as occupied. This can result in the deployment of the front-passenger air bag if the impact fulfills the specified criteria. If the  indicator lamp is lit up, the front-passenger air bag is disabled and will not deploy should the situation arise. If indicator lamp  is not lit up, the front-passenger air bag is enabled and will deploy should the situation arise.

Warning

Your vehicle is equipped with air bag technology which disables the front-

passenger air bag if the system recognizes that the front-passenger seat is empty .

If the front-passenger seat is occupied by an adult or young person and the  indicator lamp is lit up, the front-passenger air bag is disabled. If the front-passenger seat is recognized as empty, the air bag control unit will not deploy the front-passenger air bag in the event of a collision.

Ask your passenger to sit correctly on the front-passenger seat in an upright position until the  indicator lamp goes out.

If the  indicator lamp does not go out, please consult an authorized Mercedes-Benz Center.

- regardless of whether the front-passenger seat is occupied
- independently of seat belt use
- if the vehicle overturns and the system determines that window curtain air bag deployment can offer additional protection to that provided by the seat belt
- independently of the front air bags

Window curtain air bags ① will not deploy in impacts with deceleration rates which do not exceed the system's preset deployment thresholds for vehicle deceleration or acceleration. You will then be protected by the fastened seat belt.

Window curtain air bags

Warning

Observe "Important safety notes" (▷ page 36).

The window curtain air bags enhance the level of protection for the head (but not chest or arms) of the vehicle occupants on the side of the vehicle on which the impact occurs.

The window curtain air bags are integrated into the side of the roof frame and deploy in the area extending from the front door (A-pillar) to the rear door (C-pillar).

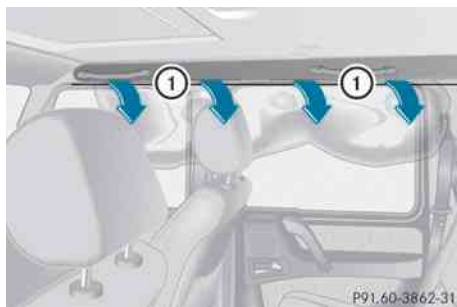

Window curtain air bags ① are deployed:

- on the side on which an impact occurs
- at the start of an accident with a high rate of lateral vehicle deceleration or acceleration, e.g. in a side impact

BabySmart™ air bag deactivation system

How the air bag deactivation system functions

Your vehicle is equipped with a BabySmart™ system.

Warning!





According to accident statistics, children are safer when properly restrained in the rear seating positions than in the front seating position. Thus, we strongly recommend that children be placed in the rear seats whenever possible. Regardless of seating position, children 12 years old and under must be seated and properly secured in an appropriate infant restraint, toddler restraint, or booster seat recommended for the size and weight of the child.

The infant or child restraint must be properly secured with the vehicle's seat belt, the seat belt and top tether strap, or lower anchors and top tether strap, fully in accordance with the child seat manufacturer's instructions.

Occupants, especially children, should always sit as upright as possible, wear the seat belt properly and use an appropriately sized infant restraint, toddler restraint, or booster seat

recommended for the size and weight of the child.

Children can be killed or seriously injured by an inflating air bag. Note the following important information when circumstances require you to place a child in the front passenger seat:



- Children 12 years old and under must never ride in the front seat, except in a Mercedes-Benz authorized BabySmart™ compatible child seat, which operates with the BabySmart™ system installed in the vehicle to deactivate the front passenger front air bag when it is installed properly. Otherwise they will be struck by the air bag when it inflates in a crash. If this happens, serious or fatal injury will result.
- A child in a rear-facing child restraint on the front passenger seat will be seriously injured or even killed if the front passenger front air bag inflates in a collision which could occur under some circumstances, even with the air bag technology installed in your vehicle. The only means to completely eliminate this risk is to never place a child in a rear-facing child restraint in the front seat. We therefore strongly recommend that you always place a child in a rear-facing child restraint in a back seat.
- If you must install a BabySmart™ compatible rear-facing child restraint on the front passenger seat because circumstances require you to do so, make sure the  indicator lamp is illuminated, indicating that the front passenger front air bag is deactivated. Should the  indicator lamp not illuminate or go out while the restraint is installed, please check installation. Periodically check the  indicator lamp while driving to make sure the  indicator lamp is illuminated. If the  indicator lamp goes out or remains out, do not transport a child on the front passenger seat until the system has been repaired.

A child in a rear-facing child restraint on the front passenger seat will be seriously injured or even killed if the front passenger front air bag inflates.

- If you have to place a child in a forward-facing child restraint on the front passenger seat, move the seat as far back as possible, use the proper child restraint recommended for the age, size and weight of the child, and secure child restraint with the vehicle's seat belt according to the child seat manufacturer's instructions.

Warning!

When using a BabySmart™ compatible child seat on the front passenger seat, the front passenger front air bag will not deploy only if the  indicator lamp remains illuminated.

Please be sure to check the  indicator lamp every time you use a BabySmart™ compatible child seat on the front passenger seat. Should the  indicator lamp go out while the restraint is installed, please check installation. If the  indicator lamp remains out, do not use the BabySmart™ restraint to transport a child on the front passenger seat until the system has been repaired.

Warning

The BabySmart™ air bag disabling system ONLY works with specially adapted child restraint systems. It does not work with child restraint systems that are not compatible with BabySmart™.

Never place anything between the seat cushion and the child restraint system (e.g. a cushion), as this reduces the effectiveness of the BabySmart™ air bag deactivation system. The underside of the child restraint system must lie against the seat cushion of the front-passenger seat. In the event of an accident, an incorrectly installed child restraint system could injure the child instead of offering protection.

Observe the manufacturer's instructions when installing special child restraint systems.



Special child restraint systems which are compatible with BabySmart™ are necessary for disabling the front-passenger air bag. When the special BabySmart™-compatible child restraint system is installed correctly and is recognized by the sensor system in the front-passenger seat, the front-passenger air bag is disabled. In this case,  indicator lamp ① lights up. If you have any questions regarding the special BabySmart™-compatible child restraint systems, consult an authorized Mercedes-Benz Center.

If the SmartKey has been removed from the ignition lock or is in position 0,  indicator lamp ① does not light up.

The system does not disable:

- the window curtain air bag
- the Emergency Tensioning Device

System self-test

The  indicator lamp lights up when the SmartKey is turned to position 1 or 2 in the ignition lock.

The  indicator lamp goes out after approximately six seconds.



If the  indicator lamp does not light up or is always lit, then the system is malfunctioning. Have the BabySmart™ system checked at an authorized Mercedes-

Benz Center before transporting a child on the front-passenger seat.

For further information, see "Problems with air bag deactivation system" (▷ page 42).



Warning

Do not leave any switched on notebooks, mobile phones, electronic tags (e.g. a ski pass) or similar electronic devices on the front-passenger seat. Signals emitted from such devices can interfere with the BabySmart™ air bag deactivation system. Such interference can lead to the  indicator lamp not lighting up during the self-test.



If the  SRS warning lamp and the  indicator lamp light up simultaneously in the instrument cluster, the system is malfunctioning. The front-passenger air bag could deploy without cause, or may fail to deploy in the event of an accident.





Have the system checked as soon as possible at an authorized Mercedes-Benz Center.

Problems with air bag deactivation system

Problem	Possible causes/consequences and ► Solutions
The   indicator lamp is on continuously.	<p>A special BabySmart™-compatible child restraint system is mounted on the front-passenger seat. The front-passenger air bag is therefore disabled.</p> <p>There is no BabySmart™-compatible child restraint system mounted on the front-passenger seat. The BabySmart™ system is malfunctioning.</p> <p>► Have the BabySmart™ system checked as soon as possible at an authorized Mercedes-Benz Center.</p>

Warning

If the   indicator lamp illuminates and remains illuminated when the weight of a typical adult or someone larger than a small individual has been detected on the passenger seat, do not allow any occupant to use the passenger seat until the system has been repaired.

Problem	Possible causes/consequences and ► Solutions
The   indicator lamp does not light up and/or stay on when a BabySmart™-compatible child restraint system is installed on the front-passenger seat.	<p>The BabySmart™ system is malfunctioning.</p> <p>► Make sure there is nothing between the seat cushion and the child restraint system.</p> <p>► Check that the child restraint system is installed correctly.</p> <p>► If the   indicator lamp does not light up, have the BabySmart™ system checked as soon as possible at an authorized Mercedes-Benz Center.</p> <p>Do not transport a child on the front-passenger seat until the air bag deactivation system has been repaired.</p>

NECK-PRO head restraints

Important safety notes

The NECK-PRO head restraints increase protection to the driver's and front passenger's head and neck. To this end, the NECK-PRO head restraints on the driver's and front-passenger seats are moved forwards and upwards in the event of a rear-end collision of a certain severity. This provides better head support.

Warning

Do not secure any objects (e.g. coat hangers) on the NECK-PRO head restraints. Otherwise, the NECK-PRO head restraints may not function properly, or in the event of a rear-end collision may not be able offer the level of protection they are designed to provide.

Warning

Head restraint covers prevent the NECK-PRO head restraints from triggering correctly. Consequently, the NECK-PRO head restraints cannot provide the intended level of protection. Do not use head restraint covers.

If the NECK-PRO head restraints have been triggered in an accident, reset the NECK-PRO head restraints on the driver's and front-passenger seat (▷ page 43). Otherwise, the additional protection will not be available in the event of another rear-end collision. You can recognize when NECK-PRO head restraints have been triggered by the fact that they have moved forwards and can no longer be adjusted.

Warning!

For your protection, drive only with properly positioned head restraints.

Adjust the head restraint so that it is as close to the head as possible and the center of the head restraint supports the back of the head at eye level. This will reduce the potential for injury to the head and neck in the event of an accident or similar situation.

Resetting triggered NECK-PRO head restraints

Warning

For safety reasons, have the NECK-PRO head restraints checked at an authorized Mercedes-Benz Center after a rear-end collision.

Warning

When pushing back the NECK-PRO head restraint cushion, make sure your fingers do not become caught between the head restraint cushion and the cover. Failure to observe this could result in injuries.

- i** Resetting the NECK-PRO head restraints requires a lot of strength. If you have difficulty resetting the NECK-PRO head restraints, have this work carried out at a qualified specialist workshop, e.g. an authorized Mercedes-Benz Center.



- ▶ Tilt the top of the NECK-PRO head restraint cushion forwards in the direction of arrow ①.
- ▶ Push the NECK-PRO head restraint cushion down in the direction of arrow ② as far as it will go.
- ▶ Firmly push the NECK-PRO head restraint cushion back in the direction of arrow ③ until the cushion engages.
- ▶ Repeat this procedure for the second NECK-PRO head restraint.

Seat belts

Important safety notes

The use of seat belts and infant and child restraint systems is required by law in all 50 states, the District of Columbia, the U.S. territories and all Canadian provinces.

Even where this is not the case, all vehicle occupants should have their seat belts fastened when the vehicle is in motion.

- i** See "Children in the vehicle" (▷ page 49) for more information on infants and children traveling with you in the vehicle and restraints for infants and children.

Warning!

Always fasten your seat belt before driving off. Always make sure all of your passengers are properly restrained. You and your passengers should always wear seat belts.

Failure to wear and properly fasten and position your seat belt greatly increases your risk of injuries and their likely severity in an accident.

If you are ever in an accident, your injuries can be considerably more severe without your seat belt properly buckled. Without your seat belt buckled, you are much more likely to hit the interior of the vehicle or be ejected from it. You can be seriously injured or killed.

In the same crash, the possibility of injury or death is lessened if you are properly wearing your seat belt. The air bags can only protect as intended if the occupants are properly wearing their seat belts.

Warning

Never ride in a moving vehicle with the seat backrest in an excessively reclined position as this can be dangerous. You could slide under the seat belt in a collision. If you slide under it, the seat belt would apply force at the abdomen or neck. That could cause serious or even fatal injuries. The seat backrest and seat belt provide the best restraint when the wearer is in a position that is as upright as possible and the seat belt is properly positioned on the body.

Warning

Never let more people ride in the vehicle than there are seat belts available. Make sure everyone riding in the vehicle is correctly restrained with a separate seat belt. Never use a seat belt for more than one person at a time.

Warning!

Damaged seat belts or seat belts that have been subjected to stress in an accident must be replaced. Also, the seat belt anchoring points must be checked.

Only use seat belts which have been approved by Mercedes-Benz.

Do not make any modifications to the seat belts. This can lead to unintended activation

of the ETDs or to their failure to activate when necessary.

Do not bleach or dye seat belts as this may severely weaken them. In a crash they may not be able to provide adequate protection.

Have all work carried out only by qualified technicians. Contact an authorized Mercedes-Benz Center.

Correct use of the seat belt

Warning

CORRECT USE OF SEAT BELTS

- Seat belts only work properly if they are fastened correctly. Never wear seat belts in any other way than as described in this section, as that could result in serious injuries in the event of an accident.
- All occupants should wear their seat belt at all times, because seat belts help reduce the likelihood of and potential severity of injuries in accidents, even if the vehicle overturns. The restraint system installed is equipped with SRS (driver's air bag, front-passenger air bag, window curtain air bags), belt tensioners and belt force limiters.

The system is designed to enhance the protection offered to occupants who are wearing their seat belts correctly, in certain frontal impacts (front air bags and belt tensioners) and side impacts (window curtain air bags and belt tensioners) which exceed preset deployment thresholds.

- Never route the shoulder section of the seat belt under your arm, across your neck or anywhere other than across your shoulder. In the event of a frontal impact, your body would be moved too far forward. This would increase the risk of head and neck injuries. The seat belt would then apply excessive force to the ribs or abdomen which could cause severe internal injuries to organs such as the liver or spleen.

Adjust the seat belt so that the upper part of the belt is as close as possible to the center of the shoulder. It should not touch the neck. Never route the belt under the shoulder. The height of the belt outlet can be altered to ensure correct usage.

- The lap belt should be routed as low as possible across the hips, not across the abdomen. If the lap belt is routed across the abdomen, it could cause serious injuries in the event of an impact.
- Never route the seat belt over rigid or fragile objects in or on your clothing, such as eyeglasses, pens, keys etc, as this could cause injuries.
- Always ensure that the seat belt is routed correctly. This is particularly important if you are wearing loose clothing.
- Only one person should use each seat belt at any one time. Never use a seat belt to restrain more than one person or route the belt around additional objects.
- Never wear seat belts when they are twisted. Otherwise, in the event of an impact, the full width of the seat belt is unavailable to distribute the force of the impact. The twisted seat belt routed across your body could cause injuries.
- Pregnant women should also wear a three-point seat belt. The lap belt must always pass across your lap as low down as possible, i.e. across your hips; not across your abdomen.
- The seat backrest should be set as close to vertical as possible.
- Check the seat belt during the journey in order to make sure that it is correctly positioned.
- Never rest your feet on the dashboard or the seat. Always keep both feet on the floor in front of the seat.
- When using a seat belt to secure an infant restraint system, child restraint system or a child on a booster seat, always follow the child seat manufacturer's instructions.

Warning

Do not pass seat belts over sharp edges. They could tear.

Do not allow the seat belt to get caught in the door or in the seat adjustment mechanism. This could damage the seat belt.

Never attempt to make modifications to seat belts. This could impair the effectiveness of the seat belts.

Fastening seat belts

Important safety notes

Warning

According to accident statistics, children are safer when properly restrained on the rear seats than on the front-passenger seat. Thus, we strongly recommend that children be placed in the rear seat whenever possible. Regardless of seating position, children 12 years old and under must be seated and properly secured in an appropriately sized child restraint system or booster seat recommended for the size and weight of the child. For additional information, see the "Children in the vehicle" section.

A child's risk of serious or fatal injuries is significantly increased if the child restraints are not properly secured in the vehicle and/or the child is not properly secured in the child restraint.

Warning!

Children 12 years old and under must never ride in the front seat, except in a Mercedes-Benz authorized BabySmart™ compatible child seat, which operates with the BabySmart™ system installed in the vehicle to deactivate the front passenger front air bag when it is installed properly. Otherwise they will be struck by the air bag when it inflates in a crash. If this happens, serious or fatal injury will result.

Three-point seat belt, front



- ▶ Adjust the seat and move the backrest to an almost vertical position (▷ page 76).
- ▶ Pull the seat belt smoothly through belt sash guide (4).
- ▶ Without twisting it, guide the shoulder section of the seat belt across the middle of your shoulder and the lap section across your hips.
- ▶ Engage belt tongue (2) in buckle (1).
- ▶ If necessary, adjust the seat belt to the appropriate height (▷ page 47).
- ▶ If necessary, pull upwards on the shoulder section of the seat belt to tighten the belt across your body.

For more information about releasing the seat belt with release button (3), see "Releasing seat belts" (▷ page 48).

Three-point seat belt in the rear, center



- ① Bracket for seat belt tongues
- ② Belt buckle for fixed belt tongue
- ③ Release button for fixed belt tongue
- ④ Fixed belt tongue
- ⑤ Belt buckle for moveable belt tongue
- ⑥ Release button for moveable belt tongue
- ⑦ Moveable belt tongue



- ▶ Pull both seat belt tongues (4) and (7) from bracket (1).



- ▶ Pull the seat belt smoothly from the inertia reel.
- ▶ Engage fixed seat belt tongue (4) in buckle (2).



- ▶ Pull movable seat belt tongue (7) and route the seat belt across your body. Without twisting it, guide the shoulder section of the seat belt across the middle of your shoulder and the lap section across your hips.
- ▶ Engage movable seat belt tongue (7) in buckle (5).
- ▶ If necessary, pull upwards on the shoulder section of the seat belt to tighten the belt across your body.

For more information about releasing the seat belt with release buttons (6) and (3), see "Releasing seat belts" (▷ page 48).

Special seat belt retractor

All seat belts in the vehicle with the exception of the driver's are equipped with a special seat belt retractor, to which a child restraint system can be secured. For further information on special seat belt retractors, see (▷ page 51).

Belt height adjustment

You can adjust the belt height on the driver's and front-passenger seat, as well as on the outer rear seats.



Adjust the height so that the upper part of the seat belt is routed across the center of your shoulder.

- ▶ **To raise:** slide the belt sash guide upwards. The belt sash guide engages in various positions.
- ▶ **To lower:** pull belt sash guide release (1) forwards and hold it.
- ▶ Slide the belt sash guide downwards.
- ▶ Release belt sash guide release (1) and make sure that the belt sash guide has engaged.

Releasing seat belts

Notes

! Make sure that the seat belt is fully rolled up. Otherwise, the seat belt or belt tongue will be trapped in the door or in the seat mechanism. This could damage the door, the door trim panel and the seat belt. Damaged seat belts can no longer fulfill their protective function and must be replaced. Consult an authorized Mercedes-Benz Center.

Three-point seat belt, front

▶ Press release button ③ and guide belt tongue ② back towards belt sash guide ④ (▷ page 46).



Three-point seat belt in the rear, center

- ▶ Press release button ⑥ on seat belt buckle ⑤ (▷ page 46).
- ▶ Open belt buckle ② with a screwdriver or similar item (▷ page 46).
- ▶ Let the seat belt roll up to the stop.
- ▶ Guide both seat belt tongues ④ and ⑦ into bracket ① one on top of the other. (▷ page 46).

Warning!



To help prevent the possibility of injury, always store the rear center seat belt latch plates in the attachment when the rear center seat belt is not in use.

Belt warning for the driver and front passenger

The  seat belt warning lamp in the instrument cluster is a reminder for all occupants to fasten their seat belts. Regardless of whether the driver and front-passenger seat belts have already been fastened, the  seat belt warning lamp will always illuminate for six seconds each time the engine is started. It then goes out if the driver and the front passenger have fastened their seat belts.

If the driver or front-passenger seat belt is not fastened when the engine is started, an additional warning tone will sound. This warning tone ceases after a maximum of six seconds or when the driver and front passenger have fastened their seat belts.

If after six seconds, the driver or front passenger have not fastened their seat belts and the doors are closed:

- the  seat belt warning lamp remains illuminated as long as either the driver's or front-passenger seat belt is not fastened.
- the  seat belt warning lamp lights up if the vehicle speed exceeds 15 mph (25 km/h). Additionally, a warning tone will sound with increasing intensity for a maximum of 60 seconds or until the driver's or front-passenger seat belt are fastened.

If the driver or front passenger unfasten their seat belt while the vehicle is in motion, the  seat belt warning lamp lights up and a warning tone sounds again.

The warning tone ceases even if the driver or front passenger have still not fastened their seat belt after 60 seconds. The  seat belt warning lamp stops flashing but remains illuminated.

After the vehicle comes to a standstill, the warning tone is reactivated and the  seat belt warning lamp flashes again if the vehicle speed again exceeds 15 mph (25 km/h).

The  seat belt warning lamp only goes out if:

- both the driver and the front passenger have fastened their seat belts.
- or
- the vehicle is stationary and a door is open.

i For more information on the  seat belt warning lamp, see "Indicator and warning lamps in the instrument cluster, seat belt" (▷ page 184).

Emergency Tensioning Device, belt force limiters

The front seat belts and the outer seat belts in the rear are equipped with ETDs and belt force limiters.

! If the front-passenger seat is not occupied, do not engage the seat belt tongue in the buckle on the front-passenger seat. Otherwise, the Emergency Tensioning Device could be triggered in the event of an accident.

The ETDs tighten the seat belts in an accident, pulling them close against the body.

The ETDs do not correct incorrect seat positions or incorrectly fastened seat belts.

The ETDs do not pull vehicle occupants back towards the backrest.

Belt force limiters, when triggered, help to reduce the peak force exerted by the seat belt on the vehicle occupant.

The front belt force limiters are synchronized with the front air bags, which take on a part of the deceleration force. Thus, the force exerted on the occupant is distributed over a greater area.

The ETDs can only be activated when:

- the SmartKey is in position **1** or **2** in the ignition lock.
- the restraint systems are operational; see "SRS warning lamp" (▷ page 34).
- the belt tongue is engaged in the buckle on each of the lap-shoulder belts in the front.
- the front-passenger seat is occupied and the belt tongue is engaged in the buckle on the front-passenger side.

The ETDs are triggered depending on the type and severity of an accident:

- in the event of a head-on or rear-end collision if the vehicle decelerates or accelerates rapidly in a longitudinal

direction during the initial stages of the impact

- in certain situations if the vehicle overturns and the system determines that it can provide additional protection

If the Emergency Tensioning Devices (ETDs) are triggered, you will hear a bang, and a small amount of smoke may also be released. Only in rare cases will the bang affect your hearing. The smoke that is released generally does not constitute a health hazard. The **SRS** SRS warning lamp lights up.

Warning

Pyrotechnic ETDs that were activated must be replaced.

For your safety, when disposing of the pyrotechnic ETDs always follow our safety instructions. These are available at any authorized Mercedes-Benz Center.

Children in the vehicle

Important safety notes

Warning

When leaving the vehicle, always remove the SmartKey from the ignition lock. Always take the SmartKey with you and lock the vehicle.

Do not leave children unattended in the vehicle, even if they are secured in a child restraint system, or with access to an unlocked vehicle. A child's unsupervised access to a vehicle could result in an accident and/or serious personal injury. The children could:

- injure themselves on parts of the vehicle
- be seriously or fatally injured through excessive exposure to extreme heat or cold
- injure themselves or cause an accident with vehicle equipment that can be operated even if the SmartKey is removed from the ignition lock or removed from the vehicle, such as seat adjustment, steering wheel adjustment, or the memory function

If children open a door, they could injure other persons or get out of the vehicle and injure themselves or be injured by following traffic.

Do not expose the child restraint system to direct sunlight. The child restraint system's metal parts, for example, could become very hot, and the child could be burned on these parts.

Warning!

Do not carry heavy or hard objects in the passenger compartment or trunk unless they are firmly secured in place.

Unsecured or improperly positioned cargo increases a child's risk of injury in the event of

- strong braking maneuvers
- sudden changes of direction
- an accident

If an infant or child is traveling in the vehicle:

- ▶ Secure the child using an infant or child restraint system appropriate to the age and weight of the child
- ▶ Make sure that the infant or child is properly secured at all times while the vehicle is in motion.

Child restraint systems

Important safety notes

Warning!

Observe "Important safety notes" (> page 49).

We recommend all infants and children be properly restrained using the child restraint systems at all times while the vehicle is in motion.

Always use a child restraint system that is compatible with BabySmart™ on the front-passenger seat.

The use of infant or child restraints is required by law in all 50 states, the District of

Columbia, the U.S. territories and all Canadian provinces.

Infants and children should always be seated in an infant or child seat restraint system appropriate for the size and weight of the child. They must be properly secured in accordance with the manufacturer's installation instructions for the infant or child seat restraint system. All infant and child seat restraint systems must comply with the US Federal Motor Vehicle Safety Standards 213 and 225 and Canadian Motor Vehicle Safety Standards 213 and 210.2.

A statement by the child restraint manufacturer of compliance with these standards can be found on the instruction label on the restraint system. You will also find the statement in the instruction manual provided with the child restraint system.

When using an infant restraint system, child restraint system or booster seat, make sure to carefully read and follow all manufacturer's instructions for installation and use.

Please read the warning labels affixed to the interior of the vehicle or to the infant restraint or child restraint system.

Warning!





According to accident statistics, children are safer when properly restrained in the rear seating positions than in the front seating position. Thus, we strongly recommend that children be placed in the rear seats whenever possible. Regardless of seating position, children 12 years old and under must be seated and properly secured in an appropriate infant restraint, toddler restraint, or booster seat recommended for the size and weight of the child.

The infant or child restraint must be properly secured with the vehicle's seat belt, the seat belt and top tether strap, or lower anchors and top tether strap, fully in accordance with the child seat manufacturer's instructions.

Occupants, especially children, should always sit as upright as possible, wear the seat belt properly and use an appropriately sized infant

restraint, toddler restraint, or booster seat recommended for the size and weight of the child.

Children can be killed or seriously injured by an inflating air bag. Note the following important information when circumstances require you to place a child in the front passenger seat:

- Children 12 years old and under must never ride in the front seat, except in a Mercedes-Benz authorized BabySmart™ compatible child seat, which operates with the BabySmart™ system installed in the vehicle to deactivate the front passenger front air bag when it is installed properly. Otherwise they will be struck by the air bag when it inflates in a crash. If this happens, serious or fatal injury will result.
- A child in a rear-facing child restraint on the front passenger seat will be seriously injured or even killed if the front passenger front air bag inflates in a collision which could occur under some circumstances, even with the air bag technology installed in your vehicle. The only means to completely eliminate this risk is to never place a child in a rear-facing child restraint in the front seat. We therefore strongly recommend that you always place a child in a rear-facing child restraint in a backseat.
- If you must install a rear-facing child restraint on the front passenger seat because circumstances require you to do so, make sure the  indicator lamp is illuminated, indicating that the front passenger front air bag is deactivated. Should the  indicator lamp not illuminate or go out while the restraint is installed, please check installation. Periodically check the  indicator lamp while driving to make sure the  indicator lamp is illuminated. If the  indicator lamp goes out or remains out, do not transport a child on the front passenger seat until the system has been repaired.

A child in a rear-facing child restraint on the front passenger seat will be seriously injured or even killed if the front passenger front air bag inflates.

- If you have to place a child in a forward-facing child restraint on the front passenger seat, move the seat as far back as possible, use the proper child restraint recommended for the age, size and weight of the child, and secure child restraint with the vehicle's seat belt according to the child seat manufacturer's instructions.

Warning

Infants and small children should never share a seat belt with another occupant. During an accident, they could be crushed between the occupant and seat belt.

A child's risk of serious or fatal injuries is significantly increased if the child restraints are not properly secured in the vehicle and/or the child is not properly secured in the child restraint.

Children too big for a toddler restraint must ride in seats using regular seat belts. Position the shoulder belt across the chest and shoulder, not face or neck. A booster seat may be necessary to achieve proper seat belt positioning for children over 41 lb (18 kg) until they reach a height where a lap/shoulder belt fits properly without a booster.

When the child restraint is not in use, remove it from the vehicle or secure it with the seat belt to prevent the child restraint from becoming a projectile in the event of an accident.

Special seat belt retractor

Warning

Observe "Important safety notes" ( page 49).

All seat belts except the driver's seat belt are equipped with a special seat belt retractor. When enabled, the special seat belt retractor function ensures that the seat belt does not

slacken once the child restraint system is secured.

Installing a child restraint system:

- ▶ Always comply with the manufacturer's installation instructions.
- ▶ Pull the seat belt smoothly from the inertia reel.
- ▶ Engage the seat belt tongue in the belt buckle.

Activating the special seat belt retractor:

- ▶ Pull the seat belt out fully and let the inertia reel retract it again.
While the seat belt is retracting, you should hear a ratcheting sound. The special seat belt retractor function is enabled.
- ▶ Push down on the child restraint system to take up any slack.

Removing a child restraint system/
deactivating the special seat belt retractor:

- ▶ Always comply with the manufacturer's installation instructions.
- ▶ Press the seat belt release button and guide the belt tongue to the belt outlet.
The special seat belt retractor function is deactivated.

Warning

Never release the seat belt buckle while the vehicle is in motion, since the special seat belt retractor will be deactivated.

ISOFIX child seat securing system for the rear seats

Warning

Observe "Important safety notes" (▷ page 49).

Warning

Children that are too large for a child restraint must travel in seats using normal seat belts. Position shoulder belt across the chest and shoulder, not face or neck.

In order to attain the correct seating position for children weighing over 41 lb (18 kg), it may be necessary to use a booster seat until they reach a height where a normal lap/shoulder seat belt lies properly across their bodies without the need for a booster seat.

Install the child restraint system according to the manufacturer's instructions.

The child restraint system must be installed firmly on both brackets.

An incorrectly installed child restraint system can come loose in the event of an accident, causing the child to be severely or fatally injured.

Child restraint systems/child restraint retaining brackets that are damaged or have suffered damage due to an impact must be replaced.

ISOFIX is a standardized securing system for specially designed child restraint systems on the rear seats. Securing rings for two ISOFIX child restraint systems are installed on the left and right of the rear seats.

Non LATCH-type (ISOFIX) child seats must be secured using the vehicle's seat belts. Follow the manufacturer's instructions for installation of child restraint systems.

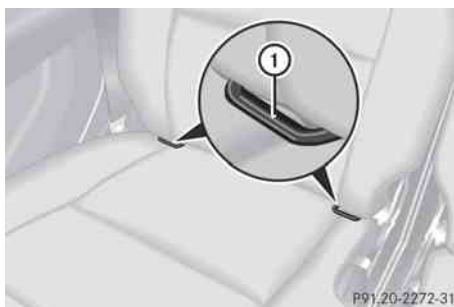

① Securing rings

- ▶ Install the ISOFIX child restraint system.
Comply with the manufacturer's

instructions when installing the ISOFIX child restraint system.

- ▶ When an ISOFIX child seat securing system is installed, make sure that the center seat belt in the rear compartment is fully functional and can move freely.

Top Tether

Warning

Observe "Important safety notes" (▷ page 49).

Warning

Always lock the rear seat backrests in their upright position when the rear seats are occupied by passengers. Lock the rear seat backrests in their upright position before installing the Top Tether straps or when the cargo compartment is not in use. Make sure that rear seat backrests are secured properly by pushing and pulling on the seat backrests. If the seat backrest is not locked properly, the seat backrest could fold forward. The child restraint system is no longer supported properly or held in position and can no longer fulfill its function. This could cause serious or even fatal injuries.

Top Tether provides an additional connection between the child restraint system secured with ISOFIX and the rear seat. It helps reduce the risk of injury even further.

The Top Tether anchorage points are located on the trunk floor behind the rear bench seat.

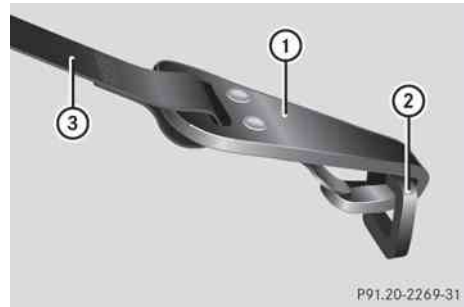
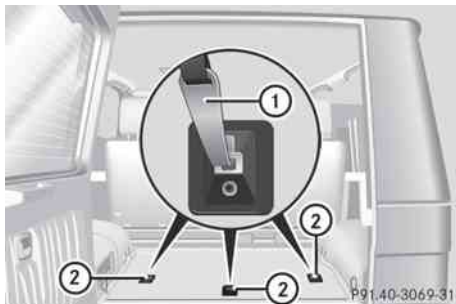

- ▶ Remove the cargo compartment cover (▷ page 196).
- ▶ Move the head restraint upwards.
- ▶ Install the ISOFIX child restraint system with Top Tether. Comply with the manufacturer's installation instructions when doing so.
- ▶ Route Top Tether belt (3) under the head restraint between the two head restraint bars.
- ▶ Attach Top Tether hook (1) to Top Tether anchorage (2) on the trunk floor.
- ▶ Make sure that Top Tether belt (3) is not twisted.
- ▶ Tension Top Tether belt (3). Comply with the manufacturer's installation instructions when doing so.
- ▶ Move the head restraint back down again slightly if necessary (▷ page 80). Make sure that you do not interfere with the correct routing of Top Tether belt (3).

Warning!

Only use the described top tether anchorage rings for the respective child seat. Other lashing eyelets could tear in case of an accident. Make sure the top tether straps are not crossed or twisted and the hook is attached and closed properly.

Child-proof locks

Child-proof locks for the rear doors

Warning

Observe "Important safety notes" (▷ page 49).

Warning

Children could open a rear door from inside the vehicle. This could result in serious injuries or an accident. Therefore, when children ride in the rear always secure the rear doors with the child-proof locks.

You secure each door individually with the child-proof locks on the rear doors. A door secured with a child-proof lock cannot be opened from inside the vehicle. When the vehicle is unlocked, the door can be opened from the outside.



- ▶ **To activate:** press the child-proof lock lever down in the direction of arrow ②.
- ▶ Make sure that the child-proof locks are working properly.
- ▶ **To deactivate:** press the child-proof lock lever up in the direction of arrow ①.

Override feature for the rear side windows



Warning

Observe "Important safety notes" (▷ page 49).

Warning

When children ride on the vehicle's rear seats, activate the override switch. Otherwise, the children could be injured, e.g. by trapping themselves in the rear side window.



- ▶ **To deactivate:** slide override switch ① to the right.
The  symbol becomes visible. Operation is only possible using the switches in the driver's door.
- ▶ **To release:** slide override switch ① to the left.
The  symbol is covered. Operation using the switches in the rear compartment is possible again.

Panic alarm



- ▶ **To activate:** press **[PANIC]** button **(1)** for at least one second.
An alarm sounds and the indicator lamp flashes.
 - ▶ To deactivate: **press [PANIC] button (1) again.**
- or
- ▶ Insert the key into the ignition lock.

i USA only:

This device complies with part 15 of the FCC regulations. Operation is subject to the following two conditions:

1. This device may not cause interference, and
2. This device must withstand any interference received, including interference that may cause undesired operation.

Any unauthorized modification to this device could void the user's authority to operate the equipment.

i Canada only:

This device complies with RSS-210 regulations of Industry Canada. Operation is subject to the following two conditions:

1. This device may not cause interference, and
2. This device must withstand any interference received, including interference that may cause undesired operation of the device.

Any unauthorized modification to this device could void the user's authority to operate the equipment.

Driving safety systems

Driving safety systems overview

In this section, you will find information about the following driving safety systems:

- ABS (**A**nti-**l**ock **B**raking **S**ystem)
- BAS (**B**rake **A**ssist **S**ystem)

- ESP® (**E**lectronic **S**tability **P**rogram)
- EBD (**E**lectronic **B**rake force **D**istribution)

Important safety notes

⚠ Warning

The following factors increase the risk of accidents:

- Excessive speed, especially in turns
- Wet and slippery road surfaces
- Following another vehicle too closely

The driving safety systems described in this section cannot reduce these risks or prevent the natural laws of physics from acting on the vehicle. They cannot increase braking or steering efficiency beyond that afforded by the condition of the vehicle brakes and tires or the traction afforded.

Only a safe, attentive, and skillful driver can prevent accidents.

The capabilities of a vehicle equipped with the driving safety systems described in this section must never be exploited in a reckless or dangerous manner which could jeopardize the user's safety or the safety of others.

Always adjust your driving style to the prevailing road and weather conditions and keep a safe distance to other road users and objects on the street.

If a driving system malfunctions, other driving safety systems may also switch off. Observe indicator and warning lamps that may come on as well as messages in the multifunction display that may appear.

⚠ Warning!

The ABS, the BAS, and the ESP® switch off when the differential locks are switched on. When the ABS, the BAS, and the ESP® are switched off

- wheels may lock during hard braking
- steering capabilities are reduced

- braking distance is increased
- vehicle stability in standard driving maneuvers is increased

Make sure the differential locks are switched on at all times except when driving off-road for example. Switch on the differential locks immediately when returning from off-road driving.

- i** In wintry driving conditions, always use winter tires (M+S tires) and if necessary, snow chains. Only in this way will the driving safety systems described in this section work as effectively as possible.

ABS (Anti-lock Braking System)

Important safety notes

Warning

Observe "Important safety notes" (▷ page 55).

Warning

Do not pump the brake pedal. Use firm, steady brake pedal pressure instead. Pumping the brake pedal defeats the purpose of the ABS and significantly reduces braking effectiveness.

ABS regulates brake pressure in such a way that the wheels do not lock when you brake. This allows you to continue steering the vehicle when braking.

ABS operates above a speed of about 5 mph (8 km/h) regardless of road-surface conditions, provided the differential locks are not active. ABS works on slippery surfaces, even when you only brake gently.

The  warning lamp in the instrument cluster lights up when the ignition is switched on. It goes out when the engine is running.

Braking

If ABS intervenes when braking, you will feel a pulsing in the brake pedal.

- ▶ **If ABS intervenes:** continue to depress the brake pedal with force until the braking situation is over.
- ▶ **To make a full brake application:** depress the brake pedal with full force.

The pulsating brake pedal can be an indication of hazardous road conditions and functions as a reminder to take extra care while driving.

Warning

If the ABS malfunctions, other driving systems such as the BAS or the ESP® are also switched off. Observe indicator and warning lamps that may come on as well as messages in the multifunction display that may appear.

If the ABS malfunctions, the wheels may lock during hard braking, reducing the steering capability and extending the braking distance.

Off-road ABS

If the LOW shift range (▷ page 126) is selected on the transfer case, an ABS system specifically suited to off-road terrain is activated.

At speeds below 37 mph (60 km/h), the front wheels lock periodically when braking. The digging-in effect achieved in the process reduces the stopping distance on off-road terrain. This limits steering capability.

BAS (Brake Assist)

Warning

Observe "Important safety notes" (▷ page 55).

BAS operates in emergency braking situations. If you depress the brake pedal quickly, BAS automatically boosts the braking force, thus shortening the stopping distance.

- Keep the brake pedal firmly depressed until the emergency braking situation is over. ABS prevents the wheels from locking.

The brakes will function as usual once you release the brake pedal. BAS is deactivated.

Warning

If the BAS malfunctions, the brake system still functions, but without the additional brake boost available that the BAS would normally provide in an emergency braking maneuver. Therefore, the braking distance may increase.

ESP® (Electronic Stability Program)

Important safety notes

Warning

Observe "Important safety notes" (▷ page 55).

ESP® monitors driving stability and traction. Traction is the power transmission between the tires and the road surface.

If ESP® detects that the vehicle is deviating from the direction desired by the driver, one or more wheels are braked to stabilize the vehicle. If necessary, the engine output is also modified to keep the vehicle on the desired course within physical limits. ESP® assists the driver when pulling away on wet or slippery roads. ESP® can also stabilize the vehicle during braking.

If ESP® intervenes, the  warning lamp flashes in the instrument cluster.

Warning

Under no circumstances should you deactivate ESP® when the  ESP® warning lamp in the instrument cluster flashes. Proceed as follows:

- when driving off, apply as little throttle as possible.
- while driving, ease up on the accelerator pedal.
- adapt your speed to suit the prevailing road and weather conditions.

failure to observe these guidelines could cause the vehicle to skid. ESP® cannot prevent accidents resulting from excessive speed.

Switch the ignition off when:

- the parking brake is being tested using a dynamometer
- the vehicle is being towed with the front/rear axle raised

Application of the brakes by ESP® may otherwise destroy the brake system.

Only operate the vehicle for a maximum of ten seconds on a brake test dynamometer. Switch off the ignition.

Application of the brakes by ESP® may otherwise destroy the brake system.

Function or performance tests may only be performed on a 2-axle dynamometer. If you wish to operate the vehicle on such a dynamometer, please consult an authorized Mercedes-Benz Center beforehand. You could otherwise damage the drive train or the brake system.

Only use wheels with the recommended tire sizes. Only then will ESP® function properly.

If differential locks are switched on, ABS, BAS and ESP® switch themselves off automatically.

4ETS (Electronic Traction System)

Warning

Observe "Important safety notes"
(▷ page 55).

Traction control is part of ESP®.

Traction control brakes the drive wheels individually if they spin. This enables you to pull away and accelerate on slippery surfaces, for example if the road surface is slippery on one side. In addition, more drive torque is transferred to the wheel or wheels with traction.

Traction control remains active if you deactivate ESP®.

Traction control is no longer active at speeds above approximately 37 mph (60 km/h).

Activating/deactivating ESP®

Warning!

The ESP® should not be switched off during normal driving other than in the circumstances described below. Disabling the system will reduce vehicle stability in driving maneuvers.

ESP® is activated automatically when the engine is started.

It may be best to deactivate ESP® in the following situations:

- when using snow chains
- in deep snow
- on sand or gravel

Warning

Switch on ESP® immediately if one of the previously stated conditions is longer met. Otherwise, ESP® cannot stabilize the vehicle if it begins to lurch or when a wheel spins.

When you deactivate ESP®:

- ESP® no longer improves driving stability.
- the engine's torque is no longer limited and the drive wheels can spin. The spinning of

the wheels results in a cutting action, which provides better grip.

- traction control is still activated.
- ESP® still provides support when you brake.
- and drive over 37 mph (60 km/h), ESP® intervenes when the grip limit of a wheel is reached, even if it is deactivated.

If ESP® is deactivated and one or more wheels start to spin, the  warning lamp in the instrument cluster flashes. In such situations, ESP® will not stabilize the vehicle.



If you have deactivated ESP®, it is automatically reactivated if you exceed a speed of 37 mph (60 km/h) or a certain lateral acceleration.



- ▶ **To deactivate:** press button ① until the  warning lamp lights up in the instrument cluster.

Warning

When the  ESP® OFF warning lamp is lit, ESP® is deactivated.

If the  ESP® warning lamp and the  ESP® OFF warning lamp remain lit, ESP® is not available due to a malfunction.

When ESP® is deactivated or not operational, vehicle stability in standard driving maneuvers is reduced.

Adapt your speed and driving to the prevailing road conditions and to the non-operating status of the ESP®.

- ❗ Avoid spinning a drive wheel for an extended period with ESP® switched off. This could cause serious damage to the drive train.
- ▶ **To activate:** press button ① until the  warning lamp goes out in the instrument cluster.

EBD (Electronic Brake force Distribution)

Warning

Observe "Important safety notes" (▶ page 55).

EBD monitors and controls the brake pressure on the rear wheels to improve driving stability while braking.

Warning!

If the EBD malfunctions, the brake system will still function with full brake boost. However, the rear wheels could lock up during emergency braking situations, for example. You could lose control of the vehicle and cause an accident.

Adapt your driving style to the changed driving characteristics.

Anti-theft systems

Immobilizer

The immobilizer prevents your vehicle from being started without the correct key.

When leaving the vehicle, always take the SmartKey with you and lock the vehicle. The engine can be started by anyone with a valid SmartKey that is left inside the vehicle.

- ▶ **To activate:** remove the SmartKey from the ignition lock.
- ▶ **To deactivate:** switch on the ignition.

- ❗ The immobilizer is always deactivated when you start the engine.

In the event that the engine cannot be started when the starter battery is fully charged, the immobilizer may be faulty. Contact an authorized Mercedes-Benz Center or call 1-800-FOR-MERCEDES (in USA) or 1-800-387-0100 (in Canada).

ATA (Anti-Theft Alarm system)

A visual and audible alarm is triggered if the alarm system is armed and you open:

- a door
- a door using the mechanical key
- the rear door
- the hood

The alarm is also triggered if:

- the position of the vehicle is changed.
- a window is smashed.

The alarm is not switched off, even if you close the open door that has triggered it, for example.

- ❗ If the alarm stays on for more than 30 seconds, the emergency call system mbrace (USA only) or TELEAID (Canada only) initiates a call to the Customer Assistance Center automatically. The emergency call system initiates the call provided that:

- you have subscribed to the mbrace/TELEAID service.
- the mbrace/TELEAID service has been activated properly.
- the required mobile phone, power supply and GPS are available.





P54.25-7773-31

- ▶ **To arm:** lock the vehicle with the SmartKey.
Indicator lamp ① flashes. The alarm system is armed after approximately 15 seconds.
 - ▶ **To deactivate:** unlock the vehicle with the SmartKey.
- i** If you then do not open a side door or the rear door, the alarm system switches itself back on again after approximately 40 seconds.

- ▶ **To stop the alarm:** insert the SmartKey into the ignition lock.
The alarm is switched off.

or

- ▶ Press the  or  button on the SmartKey.
The alarm is switched off.

Tow-away alarm

An audible and visual alarm is triggered if your vehicle's angle of inclination is altered while the tow-away alarm is armed. This occurs if the vehicle is jacked up on one side, for example.

- ▶ **To arm:** lock the vehicle with the SmartKey.
The tow-away alarm is armed after approximately 30 seconds.
- ▶ **To deactivate:** unlock the vehicle with the SmartKey.
The tow-away alarm is deactivated automatically.

To prevent a false alarm, deactivate the tow-away alarm manually if your vehicle:

- is being transported
- is being loaded onto a ferry or car transporter, for example
- is parked on a movable surface, e.g. in a split-level garage

Deactivating:

- ▶ Remove the SmartKey from the ignition lock.



P54.25-7774-31

- ▶ Press button ①.
Indicator lamp ② lights up briefly.
- ▶ Lock the vehicle with the SmartKey.
The tow-away alarm remains deactivated until the vehicle is unlocked and locked again.

Vehicle equipment	62
SmartKey	62
Doors	67
Cargo compartment	69
Side windows	70
Sliding sunroof	72

Vehicle equipment

- i** This manual describes all the standard and optional equipment of your vehicle which was available at the time of purchase. Country-specific differences are possible. Please note that your vehicle may not be equipped with all features described. This also applies to safety-relevant systems and functions.

SmartKey

Important safety notes

Warning

When leaving the vehicle, always remove the SmartKey from the ignition lock. Always take the SmartKey with you and lock the vehicle. Do not leave children unsupervised in the vehicle, even if they are secured in a child restraint system, and do not give them access to an unlocked vehicle. A child's unsupervised access to a vehicle could result in an accident and/or serious personal injury. They could:

- injure themselves on vehicle parts
- be seriously or fatally injured by extreme heat or cold
- injure themselves or have an accident with vehicle equipment that may still be in operation even after the SmartKey has been removed from the ignition, such as the seat adjustment, steering wheel adjustment or memory function.

If children open a door, they could cause severe or even fatal injury to other persons; if they get out of the vehicle, they could injure themselves when doing so or be seriously or even fatally injured by any passing traffic.

Do not expose the child restraint system to direct sunlight. The child restraint system's metal parts, for example, could become very hot, and a child could be burned on these parts.

Warning!

Do not carry heavy or hard objects in the passenger compartment or cargo compartment unless they are firmly secured in place.

Unsecured or improperly positioned cargo increases a child's risk of injury in the event of

- strong braking maneuvers
- sudden changes of direction
- an accident

General notes

If you cannot lock or unlock the vehicle with the SmartKey then the battery in the SmartKey is discharged, the SmartKey is faulty or the starter battery is discharged.

- ▶ Check the battery in the SmartKey and replace it if necessary (▷ page 64).
- ▶ Unlock the driver's door using the mechanical key (▷ page 68).
- ▶ Lock the vehicle using the mechanical key (▷ page 68).
- ▶ Have the starter battery and the battery contacts checked at an authorized Mercedes-Benz Center.

If the SmartKey is faulty, contact Roadside Assistance or an authorized Mercedes-Benz Center.

SmartKey functions

General notes

- i** USA only:

This device complies with Part 15 of the FCC regulations. Operation is subject to the following conditions:

1. This device must not cause any harmful interference, and
2. This device must be able to accommodate interference that is

received, including interference which could cause unwanted functions.

Unapproved modifications to this device may lead to withdrawal of permission to operate it.

i Canada only:

This device complies with Industry Canada's RSS210 regulations. Operation is subject to the following conditions:

1. This device must not cause any harmful interference, and
2. This device must be able to accommodate interference that is received, including interference which could cause unwanted functions.

Unapproved modifications to this device may lead to withdrawal of permission to operate it.

Locking and unlocking centrally

The SmartKey centrally locks/unlocks:

- the doors
- the rear door
- the fuel filler flap



- ① To lock the vehicle
- ② To unlock the vehicle

When unlocking, the turn signals flash once. When locking, they flash three times.

- **To unlock centrally:** press the button.

If you do not open a door or the rear door or the tailgate (Cabriolet) within approximately 40 seconds of unlocking the vehicle:

- the vehicle is locked again.
- the theft deterrent locking system is armed again.

- **To lock centrally:** press the button.

Changing the settings of the locking system

You can change the setting of the locking system in such a way that only the driver's door and the fuel filler flap are unlocked. This is useful if you frequently travel on your own.

- **To change the setting:** press and hold down the and buttons simultaneously for approximately six seconds until battery check lamp flashes twice.

The SmartKey now functions as follows:

- **To unlock the driver's door and fuel filler flap:** press the button once.
- **To unlock centrally:** press the button twice.
- **To lock centrally:** press the button.

Restoring the factory settings

- Press the and buttons simultaneously for approximately six seconds until the battery check lamp flashes twice.

Mechanical key

General notes

If the vehicle can no longer be unlocked with the SmartKey, use the mechanical key.

If you use the mechanical key to unlock and open the driver's door or the trunk lid, the

anti-theft alarm system will be triggered (▷ page 59).

- ▶ **To end the alarm:** insert the key into the ignition lock.

Removing the mechanical key

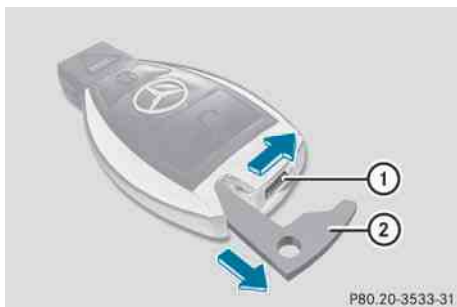

- ▶ Push release catch ① in the direction of the arrow and at the same time, remove mechanical key ② from the SmartKey.

SmartKey battery

Important safety notes

It is advisable to have batteries replaced at a qualified specialist workshop, e.g. at an authorized Mercedes-Benz Center.

Warning

Batteries contain toxic and caustic substances. For this reason, keep batteries out of the reach of children.



If a battery has been swallowed, seek medical help immediately.

Warning





The SmartKey batteries contain perchlorate material, which may require special handling and regard for the environment. Observe government disposal guidelines. California residents, see www.dtsc.ca.gov/HazardousWaste/Perchlorate/index.cfm.

Checking the battery



- ▶ Press the  or  button. The SmartKey battery is working properly if battery check lamp ① lights up briefly.

If battery check lamp ① does not light up briefly during the test, the SmartKey battery is discharged.

- ▶ Replace the SmartKey battery (▷ page 64).
-  You can obtain a SmartKey battery at any authorized Mercedes-Benz Center.
-  If the SmartKey battery is checked within the signal range of the vehicle, pressing the  or  button closes or opens the vehicle.

Changing the battery

You require a CR 2025 3 V cell battery.

- ▶ Take the mechanical key out of the SmartKey (▷ page 63).

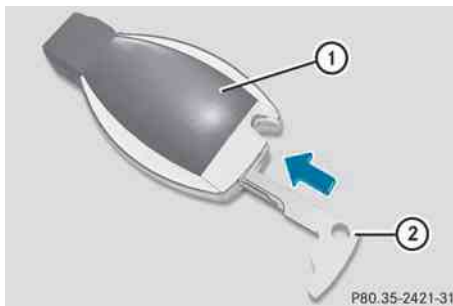

- ▶ Press mechanical key ② into the opening in the SmartKey in the direction of the

arrow until battery tray cover ① opens. Do not hold the cover closed while doing so.

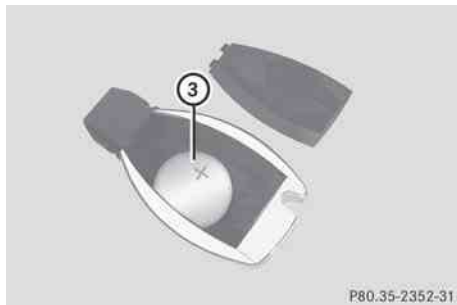

- ▶ Remove the cover of the battery tray.
- ▶ Repeatedly tap the SmartKey against your palm until battery ③ falls out.
- ▶ Insert the new battery with the positive terminal facing upwards. Use a lint-free cloth to do so.
- ▶ Insert the front tabs of the battery tray's cover first, and then press to close it.
- ▶ Check the function of all SmartKey buttons on the vehicle.

Problems with the SmartKey

Problem	Possible causes/consequences and ► Solutions
<p>You cannot lock or unlock the vehicle using the SmartKey.</p>	<p>The SmartKey battery is discharged or nearly discharged.</p> <ul style="list-style-type: none"> ► Point the tip of the SmartKey at the driver's door handle from a distance of approximately 1.5 ft (50 cm) and try to unlock or lock the vehicle again. <p>If this does not work:</p> <ul style="list-style-type: none"> ► Check the SmartKey battery and replace it if necessary (▷ page 64). ► Lock or unlock the vehicle using the mechanical key (▷ page 68). <p>The SmartKey is faulty.</p> <ul style="list-style-type: none"> ► Lock or unlock the vehicle using the mechanical key (▷ page 68). ► Have the SmartKey checked at a qualified specialist workshop.
<p>You have lost a SmartKey.</p>	<ul style="list-style-type: none"> ► Have the SmartKey canceled at an authorized Mercedes-Benz Center. ► Report the loss immediately to the vehicle insurers. ► If necessary, have the locks changed as well.
<p>You have lost the mechanical key.</p>	<ul style="list-style-type: none"> ► Report the loss immediately to the vehicle insurers. ► If necessary, have the locks changed as well.
<p>The SmartKey cannot be turned in the ignition lock.</p>	<p>The SmartKey has been in position 0 for a considerable time.</p> <ul style="list-style-type: none"> ► Remove the SmartKey and reinsert it into the ignition lock. ► Check the battery and charge it if necessary (▷ page 236). ► Start the engine. <p>The on-board voltage is too low.</p> <ul style="list-style-type: none"> ► Switch off non-essential consumers, e.g. seat heating or interior lighting, and try to turn the SmartKey again. <p>If this does not work:</p> <ul style="list-style-type: none"> ► Check the battery and charge it if necessary (▷ page 236). <p>or</p> <ul style="list-style-type: none"> ► Jump-start the vehicle (▷ page 238). <p>or</p> <ul style="list-style-type: none"> ► Consult a qualified specialist workshop.

Doors

Important safety notes

 **Warning**

When leaving the vehicle, always remove the SmartKey from the ignition lock. Always take the SmartKey with you and lock the vehicle. Do not leave children unsupervised in the vehicle, even if they are secured in a child restraint system, and do not give them access to an unlocked vehicle. A child's unsupervised access to a vehicle could result in an accident and/or serious personal injury. They could:

- injure themselves on vehicle parts
- be seriously or fatally injured by extreme heat or cold
- injure themselves or have an accident with vehicle equipment that may still be in operation even after the SmartKey has been removed from the ignition, such as the seat adjustment, steering wheel adjustment or memory function.

If children open a door, they could cause severe or even fatal injury to other persons; if they get out of the vehicle, they could injure themselves when doing so or be seriously or even fatally injured by any passing traffic.

Do not expose the child restraint system to direct sunlight. The child restraint system's metal parts, for example, could become very hot, and a child could be burned on these parts.

 **Warning!**

Do not carry heavy or hard objects in the passenger compartment or cargo compartment unless they are firmly secured in place.

Unsecured or improperly positioned cargo increases a child's risk of injury in the event of

- strong braking maneuvers
- sudden changes of direction
- an accident

Unlocking and opening the doors from the inside

You can open a door anytime from inside the vehicle even if it has been locked, unless the child-proof locks (> page 54) have been activated.

If the vehicle has previously been locked with the SmartKey, opening a door from the inside will trigger the anti-theft alarm system. To switch off the alarm (> page 59)

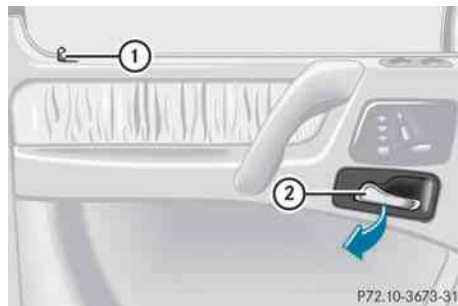

- ▶ **Front doors:** pull door handle (2).
If the door is locked, locking knob (1) pops up. The door is unlocked and can be opened.
- ▶ **Rear doors:** pull locking knob (1) upwards.
The door is unlocked.
- ▶ Pull door handle (2).

Locking and unlocking the vehicle from the inside

You can centrally lock or unlock the vehicle from the inside. This feature may be useful if, for example, you wish to unlock the front-passenger door from the inside or lock the vehicle before you pull away.

The central locking button does not lock or unlock the fuel filler flap.

-  You cannot unlock the vehicle centrally from the inside if the vehicle has been locked from the outside using the SmartKey.

- i** It is only possible to lock the vehicle centrally if all doors are closed.



- ▶ **To unlock:** press button ①.
- ▶ **To lock:** press button ②.

You can open a front door from inside the vehicle even if it has been locked. Only open the door when the traffic situation permits.

If the vehicle has been locked with the central locking button:

- and the SmartKey is restored to the factory settings, the entire vehicle is unlocked if a front door is opened from inside the vehicle.
- and the SmartKey is set to an individual setting, only the front door that is opened from inside the vehicle is unlocked.

If the vehicle has been locked centrally with the SmartKey, it does not unlock if you use the central locking button.

Automatic locking feature

The vehicle locks automatically when the ignition is switched on and the wheels of the vehicle are moving at a speed of more than 9 mph (15 km/h). There is therefore a risk of being locked out when the vehicle is being pushed, towed or tested on a dynamometer.

You can switch the automatic locking function on and off using the on-board computer (▷ page 165).

Unlocking the driver's door (mechanical key)

If the vehicle can no longer be unlocked centrally with the SmartKey:

- ▶ Take the mechanical key out of the SmartKey (▷ page 63).

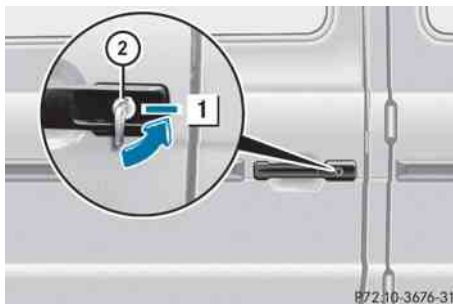

- ▶ Insert the mechanical key into the lock of the driver's door as far as it will go.
- ▶ Turn mechanical key ② counter-clockwise to position ①. The door is unlocked.
- ▶ Turn mechanical key ② back and remove it.

Locking the vehicle

If the vehicle can no longer be locked centrally with the SmartKey:

- ▶ Close the front-passenger door, the rear doors and the tailgate.
- ▶ Press the locking button (▷ page 67).
- ▶ Make sure that the locking knobs on the doors are still visible. Press down the locking knobs by hand, if necessary.
- ▶ Close the driver's door from the outside.

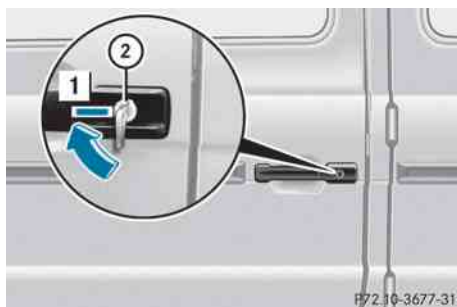

- ▶ Take mechanical key ② out of the SmartKey (▷ page 63).
- ▶ Insert mechanical key ② into the lock of the driver's door as far as it will go.
- ▶ Turn mechanical key ② clockwise as far as it will go to position ①.
- ▶ Turn the mechanical key back and remove it.
- ▶ Make sure that the doors and the tailgate are locked.

i If you lock the vehicle as described above, the fuel filler flap is not locked. The anti-theft alarm system is not armed.

Cargo compartment

Important safety notes

Do not leave the SmartKey in the cargo compartment. Otherwise, you could lock yourself out.

⚠ Warning

When leaving the vehicle, always remove the SmartKey from the ignition lock. Always take the SmartKey with you and lock the vehicle. Do not leave children unsupervised in the vehicle, even if they are secured in a child restraint system, and do not give them access to an unlocked vehicle. A child's unsupervised access to a vehicle could result in an accident and/or serious personal injury. They could:

- injure themselves on vehicle parts
- be seriously or fatally injured by extreme heat or cold
- injure themselves or have an accident with vehicle equipment that may still be in operation even after the SmartKey has been removed from the ignition, such as the seat adjustment, steering wheel adjustment or memory function.

If children open a door, they could cause severe or even fatal injury to other persons; if they get out of the vehicle, they could injure themselves when doing so or be seriously or even fatally injured by any passing traffic.

Do not expose the child restraint system to direct sunlight. The child restraint system's metal parts, for example, could become very hot, and a child could be burned on these parts.

⚠ Warning!

Do not carry heavy or hard objects in the passenger compartment or cargo compartment unless they are firmly secured in place.

Unsecured or improperly positioned cargo increases a child's risk of injury in the event of

- strong braking maneuvers
- sudden changes of direction
- an accident

⚠ Warning!

The tailgate swings open to one side. Always make sure there is sufficient clearance for the tailgate.

Make sure the tailgate is closed when the engine is running and while driving. Among other dangers, deadly carbon monoxide (CO) gases may enter vehicle interior resulting in unconsciousness and death.

- ❗ The tailgate swings out to the side when opened. Therefore, make sure that there is sufficient clearance.

Opening

You can only open the rear door after unlocking it first.

- ▶ Press the  button on the SmartKey.

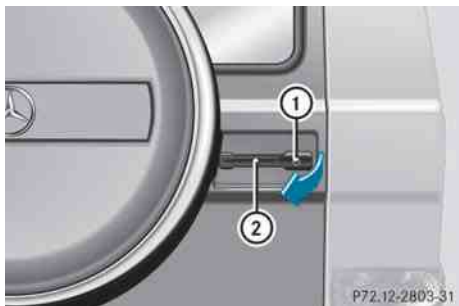

- ▶ Press release button ① and pull door handle ②.
- ▶ Open the rear door.

Closing**⚠ Warning!**

To prevent possible personal injury, always keep hands and fingers away from the cargo compartment opening when closing the tailgate. Be especially careful when small children are around.

Side windows**Important safety notes****⚠ Warning**

When leaving the vehicle, always remove the SmartKey from the ignition lock. Always take the SmartKey with you and lock the vehicle. Do not leave children unsupervised in the vehicle, even if they are secured in a child restraint system, and do not give them access to an unlocked vehicle. A child's unsupervised access to a vehicle could result in an accident and/or serious personal injury. They could:

- injure themselves on vehicle parts
- be seriously or fatally injured by extreme heat or cold
- injure themselves or have an accident with vehicle equipment that may still be in operation even after the SmartKey has been removed from the ignition, such as the seat adjustment, steering wheel adjustment or memory function.

If children open a door, they could cause severe or even fatal injury to other persons; if they get out of the vehicle, they could injure themselves when doing so or be seriously or even fatally injured by any passing traffic.

Do not expose the child restraint system to direct sunlight. The child restraint system's metal parts, for example, could become very hot, and a child could be burned on these parts.

⚠ Warning!

Do not carry heavy or hard objects in the passenger or cargo compartment unless they are firmly secured in place.

Unsecured or improperly positioned cargo increases a child's risk of injury in the event of

- strong braking maneuvers
- sudden changes of direction
- an accident

Warning!

When closing the door windows, make sure there is no danger of anyone being harmed by the closing procedure.

Activate the override switch when children are riding in the back seats of the vehicle. The children may otherwise injure themselves, e.g. by becoming trapped in the window opening.

The closing of the door windows can be immediately halted by releasing the switch or by releasing button  on the SmartKey.

Warning!

Do not keep any part of your body up against the window pane when opening a window. The downward motion of the pane may pull that part of your body down between the window pane and the door frame and trap it there. If there is a risk of entrapment, release the switch and pull it to close the window.

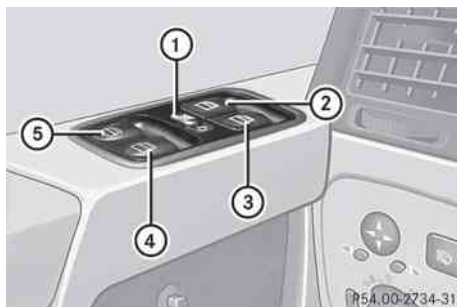
Opening and closing the side windows

- ① Override feature for rear door windows
- ② Front left
- ③ Front right
- ④ Rear right
- ⑤ Rear left

The switches for all side windows are located on the driver's door. There is also a switch on each door for the corresponding side window.

i The side windows cannot be operated from the rear when the override feature for the side windows is activated.

▶ Turn the SmartKey to position **1** or **2** in the ignition lock.

▶ **To open:** press the corresponding switch.

▶ **To close:** pull the corresponding switch.

i If you press the switch beyond the point of resistance while opening, an automatic opening/closing process is started. You can stop automatic operation by pressing again.

Convenience opening feature

You can ventilate the vehicle before you start driving. To do this, you can use the key to simultaneously:

- unlock the vehicle
- open the side windows
- open the sliding sunroof

i The convenience opening feature can only be operated using the key. The SmartKey must be close to the driver's door handle.

▶ Point the tip of the key at the driver's door handle.

▶ Press and hold the  button until the side windows and the sliding sunroof are in the desired position.

Convenience closing feature



When you lock the vehicle, you can simultaneously:



- close the side windows
- close the sliding sunroof

Warning!

When closing the windows and the tilt/sliding sunroof, make sure there is no danger of anyone being harmed by the closing procedure.

If potential danger exists, proceed as follows:

- Release button  to stop the closing procedure. To open, press and hold button . To continue the closing procedure after making sure that there is no danger of anyone being harmed by the closing procedure, press and hold button .

- ▶ **i** The SmartKey must be close to the driver's door handle.
- ▶ Point the tip of the key at the driver's door handle.
- ▶ Press and hold the  button until the side windows and the sliding sunroof are fully closed.
- ▶ Make sure that all the side windows and the sliding sunroof are closed.
- ▶ **To interrupt convenience closing:** release the  button.

Problems with the side windows

Problem: a side window cannot be closed because objects are trapped between the side window and the door frame.

- ▶ Remove the objects.
- ▶ Close the side window.

Problem: a side window cannot be closed because objects in the guide rail are preventing the window from being raised.

- ▶ Remove the objects.
- ▶ Close the side window.

Sliding sunroof

Important safety notes

Warning

When leaving the vehicle, always remove the SmartKey from the ignition lock. Always take the SmartKey with you and lock the vehicle. Do not leave children unsupervised in the vehicle, even if they are secured in a child restraint system, and do not give them access to an unlocked vehicle. A child's unsupervised access to a vehicle could result in an accident and/or serious personal injury. They could:

- injure themselves on vehicle parts
- be seriously or fatally injured by extreme heat or cold
- injure themselves or have an accident with vehicle equipment that may still be in operation even after the SmartKey has been removed from the ignition, such as the seat adjustment, steering wheel adjustment or memory function.

If children open a door, they could cause severe or even fatal injury to other persons; if they get out of the vehicle, they could injure themselves when doing so or be seriously or even fatally injured by any passing traffic.

Do not expose the child restraint system to direct sunlight. The child restraint system's metal parts, for example, could become very hot, and a child could be burned on these parts.

Warning!

Do not carry heavy or hard objects in the passenger or cargo compartment unless they are firmly secured in place.

Unsecured or improperly positioned cargo increases a child's risk of injury in the event of

- strong braking maneuvers
- sudden changes of direction
- an accident

⚠ Warning!

When closing the sliding sunroof, make sure that there is no danger of anyone being harmed by the closing procedure.

The opening procedure of the sliding sunroof can be immediately halted by releasing the sunroof switch or, if the sunroof switch was moved past the resistance point and released, by moving the sunroof switch in any direction.

The closing procedure of the sliding sunroof can be immediately halted by releasing the sliding sunroof switch. The closing procedure of the sliding sunroof can be immediately reversed by moving the sliding sunroof switch toward ① or ④.

If you are not wearing a seat belt, or are not wearing it correctly, there is a risk that you could be thrown through the opening in the event of the vehicle overturning. An opening of this kind poses a risk of injury even to passengers who are wearing their seat belts correctly, as parts of the body could protrude from the vehicle interior.

! Only open the sliding sunroof if it is free of snow and ice. Otherwise, malfunctions may occur.

Do not allow anything to protrude from the sliding sunroof. Otherwise, the seals could be damaged.

! If the sliding sunroof cannot be opened or closed due to a malfunction, contact a qualified specialist workshop, e.g. an authorized Mercedes-Benz Center.

! The weather can change abruptly. It could start to rain or snow. Make sure that the sliding sunroof is closed when you leave the vehicle. The vehicle electronics can be damaged if water enters the vehicle interior.

i Resonance noises can occur in addition to the usual airflow noises when the sliding sunroof is open. They are caused by minor pressure fluctuations in the vehicle interior. Change the position of the sliding sunroof

or open a side window slightly to reduce or eliminate these noises.

Opening and closing the sliding sunroof

Overhead control panel

- ① To raise
- ② To lower
- ③ To close
- ④ To open

- ▶ Turn the SmartKey to position **1** or **2** in the ignition lock.
- ▶ Press or pull the  switch in the corresponding direction.

i If you press the  switch beyond the point of resistance while opening, an automatic opening process is started. You can stop automatic operation by operating the switch again.

Operating the sliding sunroof manually

The actuator is located in the cargo compartment, on the left-hand side behind the rear wall trim.

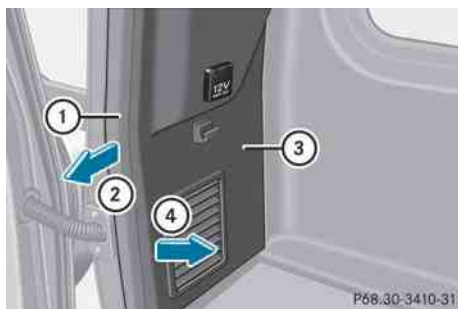

P68.30-3410-31

- ▶ Open the rear door.
- ▶ Pull off edge protection ① from the door pillar in the direction of arrow ②.
- ▶ Pull off rear wall trim ③ in the direction of arrow ④ until the electrical connections can be reached.
- ▶ Disconnect the electrical connections.
- ▶ Remove rear wall trim ③ completely.

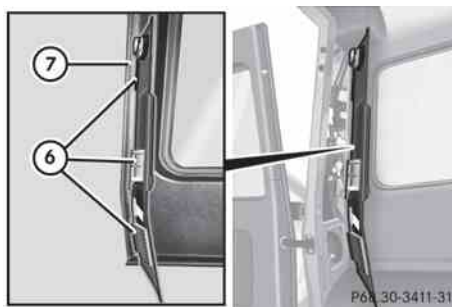

P68.30-3411-31

- ▶ Reconnect the electrical connections.
- ▶ Re-install rear wall trim ③. When doing so, hook lugs ⑥ of rear wall trim ③ into vehicle side wall ⑦.
- ▶ Re-install edge protection ①.
- ▶ Close the rear door.



P77.10-2034-31

- ▶ Take lug wrench ⑤ out of the vehicle tool kit (▷ page 229).
- ▶ Place lug wrench ⑤ onto the hexagonal nut of the actuator.
- ▶ **To open:** turn lug wrench ⑤ counter-clockwise.
- ▶ **To close:** turn lug wrench ⑤ clockwise.

Vehicle equipment	76
Correct driver's seat position	76
Seats	77
Steering wheel	83
Mirrors	85
Memory functions	88

Vehicle equipment

i This manual describes all the standard and optional equipment of your vehicle which was available at the time of purchase. Country-specific differences are possible. Please note that your vehicle may not be equipped with all features described. This also applies to safety-relevant systems and functions.

Correct driver's seat position

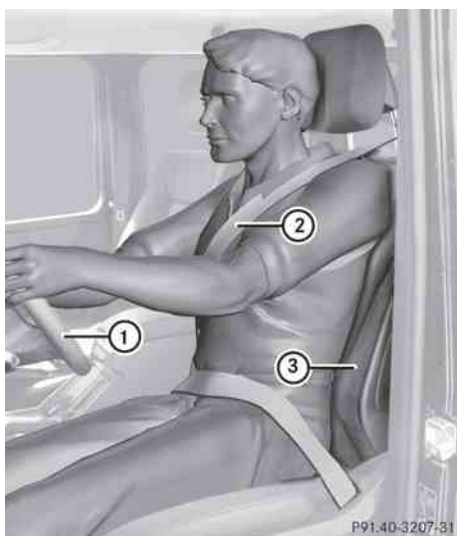

Observe the safety guidelines on (▷ page 77).

► Check whether you have adjusted seat ③ properly.

Electrical seat adjustment (▷ page 78).

When adjusting the seat, make sure:

- you are as far away from the driver's air bag as possible.
- you are sitting in a normal upright position.
- you can fasten the seat belt properly.
- you have moved the backrest to an almost vertical position.

- you have set the seat cushion angle so that your thighs are gently supported.
- you can depress the pedals properly.

► Check whether the head restraint is adjusted properly (▷ page 79).

When doing so, make sure that you have adjusted the head restraint so that the back of your head is supported at eye level by the center of the head restraint.

Observe the safety guidelines on (▷ page 77).

► Check whether steering wheel ① is adjusted properly.

Adjusting the steering wheel electrically (▷ page 83).

When adjusting the steering wheel, make sure:

- you can hold the steering wheel with your arms slightly bent.
- you can move your legs freely.
- you can see all the displays in the instrument cluster clearly.

Observe the safety guidelines on (▷ page 43).

► Check whether you have fastened seat belt ② properly (▷ page 45).

The seat belt should:

- fit snugly across your body
- be routed across the middle of your shoulder
- be routed in your pelvic area across the hip joints

► Before starting off, adjust the rear-view mirror and the exterior mirrors (▷ page 85) in such a way that you have a good view of road and traffic conditions.

► **Vehicles with a memory function:** save the seat, steering wheel and exterior mirror settings (▷ page 88).

Seats

Important safety notes

Warning

In order to avoid possible loss of vehicle control, all seat, head restraint, steering wheel and rear view mirror adjustments, as well as fastening of seat belts, must be done before setting the vehicle in motion.

Warning

Do not adjust the driver's seat while driving. Adjusting the seat while driving could cause the driver to lose control of the vehicle.

Never travel in a moving vehicle with the seat backrest in an excessively reclined position as this can be dangerous. You could slide under the seat belt in a collision. If you slide under it, the seat belt would apply force at the abdomen or neck. This could cause serious or fatal injuries. The seat backrest and seat belts provide the best restraint when the wearer is in a position that is as upright as possible and seat belts are properly positioned on the body.

Warning

Your seat belt must be adjusted so that you can correctly fasten your seat belt.

Observe the following points:

- adjust the seat backrest until your arms are slightly angled when holding the steering wheel.
- adjust the seat to a comfortable seating position that still allows you to reach the accelerator/brake pedal safely. The position should be as far back as possible with the driver still able to operate the controls properly.
- adjust the head restraint so that it is as close to the head as possible and the center

of the head restraint supports the back of the head at eye level.

- never place hands under the seat or near any moving parts while a seat is being adjusted.

Failure to do so could result in an accident and/or serious personal injury.

Warning

The electrically adjustable seats can be operated at any time. Therefore, do not leave children unattended in the vehicle, or with access to an unlocked vehicle. A child's unsupervised access to a vehicle could result in an accident and/or serious personal injury.

Warning

According to accident statistics, children are safer when properly restrained on the rear seats than on the front-passenger seat. Thus, we strongly recommend that children be placed in the rear seat whenever possible. Regardless of seating position, children 12 years old and under must be seated and properly secured in an appropriately sized child restraint system or booster seat recommended for the size and weight of the child. For additional information, see the "Children in the vehicle" section.

A child's risk of serious or fatal injuries is significantly increased if the child restraints are not properly secured in the vehicle and/or the child is not properly secured in the child restraint.

Warning

For your protection, drive only with properly positioned head restraints.

Adjust the head restraint so that it is as close to the head as possible and the center of the head restraint supports the back of the head at eye level. This will reduce the potential for injury to the head and neck in the event of an accident or similar situation.

Do not drive the vehicle without the seat head restraints. Head restraints are intended to help reduce injuries during an accident.

! To avoid damage to the seats and the seat heating, observe the following information:

- do not spill any liquids on the seats. If liquid is spilled on the seats, dry them as soon as possible.
- if the seat covers are damp or wet, do not switch on the seat heating. The seat heating should also not to be used to dry the seats.
- clean the seat covers as recommended; see the "Interior care" section.
- do not transport heavy loads on the seats. Do not place sharp objects on the seat cushions, e.g. knives, nails or tools. The seats should only be occupied by passengers, if possible.
- when the seat heating is in operation, do not cover the seats with insulating materials, e.g. blankets, coats, bags, seat covers, child seats or booster seats.

! Make sure that there are no objects in the footwell or behind the seats when resetting the seats. There is a risk that the seats and/or the objects could be damaged.

! When the rear bench seat is folded forwards, the front seats cannot be moved to their rearmost position. You could otherwise damage the seats and the rear bench seat.

! Make sure that the sun visor is folded up before adjusting the backrest and head restraint height. The head restraint and sun visor could otherwise collide when the head restraint is fully extended.

i If the front door is open, the seats can be adjusted for up 30 minutes after the ignition has been switched off.

i The head restraints in the front and rear seats can be removed (▷ page 80).

Please contact an authorized Mercedes-Benz Center for more information.

i You can find further information about enlarging the cargo compartment (folding the rear bench seat forwards) on (▷ page 194).

Adjusting the seat electrically

Front seat adjustment

The buttons are located on the door control panel.



- ① Head restraint height
- ② Backrest angle
- ③ Seat fore-and-aft adjustment
- ④ Seat cushion angle
- ⑤ Seat height

► Turn the key to position **1** or **2** in the ignition lock.

Seat fore-and-aft adjustment

! Before moving the front passenger seat forward, make sure that the cup holder on the center console is folded down and that the cup holder on the armrest has been removed. Otherwise, the front passenger seat or the cup holders may be damaged.

► Slide the button forwards or back in the direction of arrow ③.

Backrest angle

- ▶ Slide the button forwards or back in the direction of arrow ②.

Seat height

- ▶ Slide the button up or down in the direction of arrow ⑤.

Seat cushion angle

Adjust the seat cushion angle so that your thighs are lightly supported.

- ▶ Slide the button up or down in the direction of arrow ④.

Head restraint height

- ▶ Slide the button up or down in the direction of arrow ①.

- i** For further information on head restraints, see (▶ page 79).
- i** You can store the seat settings using the memory function (▶ page 88).

Adjusting the head restraints

Important safety notes

⚠ Warning!

For safety reasons, always drive with the rear head restraints in the upright position when the rear seats are occupied.

Keep the area around head restraints clear of articles (e.g. clothing) to not obstruct the folding operation of the head restraints.

⚠ Warning

For your protection, drive only with properly positioned head restraints.

Adjust the head restraint so that it is as close to the head as possible and the center of the head restraint supports the back of the head at eye level. This will reduce the potential for injury to the head and neck in the event of an accident or similar situation.

Do not drive the vehicle without the seat head restraints. Head restraints are intended to help reduce injuries during an accident.

Adjusting the front seat head restraint height

The button is located on the door control panel.



- ▶ Slide head restraint adjustment button ① up or down in the direction of the arrow.

Adjusting the front seat head restraint angle

⚠ Warning!

Vehicles with Rear Seat Entertainment System: When adjusting the head restraint, make sure your fingers do not become caught between the head restraint cushion and the monitor. Failing to do so may lead to injury.



- ▶ Push or pull the lower edge of the head restraint in the direction of the arrow.

Resetting the front seat head restraints

It is necessary to reset the front seat head restraints after the voltage supply has been interrupted, e.g. if the battery has been completely discharged or disconnected.

- ▶ Make sure that the cup holder on the center console is folded down (▷ page 197).
- ▶ Move the seat as far forward as possible and the head restraint in as far as possible.

Rear seat head restraints

Important safety notes

Warning!

For safety reasons, always drive with the rear head restraints in the upright position when the rear seats are occupied.

Keep the area around head restraints clear of articles (e.g. clothing) to not obstruct the folding operation of the head restraints.

Warning!

For your protection, drive only with properly positioned head restraints.

Adjust the head restraint in such a way that it is as close to the head as possible and the center of the head restraint supports the back of the head at eye level. This will reduce the potential for injury to the head and neck in the event of an accident or similar situation.

With a rear seat occupied, make sure to move the respective head restraint up from the lowest non-use position and have the occupant adjust the head restraint properly.

Do not drive the vehicle without the seat head restraints installed when the rear seats are occupied. Head restraints are intended to help reduce injuries during an accident.

Warning!

Make sure the rear seat head restraints engage when placing them upright manually. Otherwise their protective function cannot be ensured.

The back of the head will not be supported in the event of a collision. That could cause serious or even fatal injuries. Rear seat occupants can be seriously injured or killed.

Adjusting the head restraint height

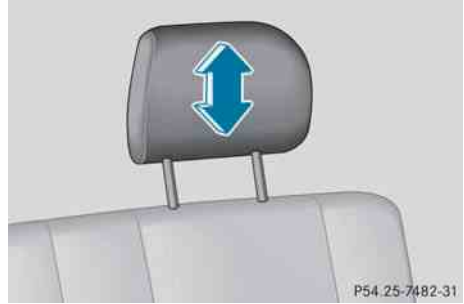

- ▶ **To raise:** pull the head restraint up until the desired height has been reached.
- ▶ **To lower:** push the head restraint down until the desired height has been reached.

Installing/removing the rear seat head restraints

- ▶ **To remove:** pull the head restraint up and out.
- ▶ **To re-install:** insert the head restraint so that the arched side points in the direction of travel.
- ▶ Push the head restraint down until you hear it engage in position.

Adjusting the luxury head restraints

Warning

When folding back the head restraint side bolsters, do not put your hands between the side bolster and the cushion holder. There is a danger of becoming trapped.



- ▶ **To adjust the side bolsters of the head restraint:** push or pull right and/or left-hand side bolster ① into the desired position.
- ▶ **To adjust the angle of the head restraint:** push or pull the head restraint in the direction of arrow ②.

Adjusting the multicontour seat

You can adjust the contour of the front seats individually so as to provide optimum support for your back and sides.

- ▶ Make sure that the key is in position 1 in the ignition lock.

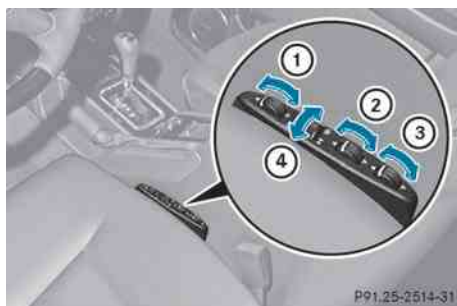

- ① To adjust the thigh cushion
- ② To adjust the backrest contour in the lumbar region
- ③ To adjust the backrest contour in the upper back region
- ④ To adjust the side bolsters of the seat backrest

Adjusting the 4-way lumbar support

You can adjust the contour of the front seat backrests individually to provide optimum support for your back.

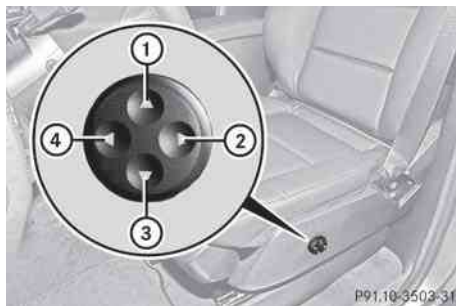

- ① To raise the backrest contour
- ② To soften the backrest contour
- ③ To lower the backrest contour
- ④ To harden the backrest contour

Switching the seat heating on/off

General notes

The red indicator lamps in the button indicate the heating level you have selected.

- ❗ If the battery voltage is too low, the seat heating may switch off.

One or more of the indicator lamps in the seat heating button are flashing.

- ▶ Make sure that the SmartKey is in position 2 in the ignition lock.

Front-seat heating



i The system automatically switches down from level **3** to level **2** after approximately five minutes.

The system automatically switches down from level **2** to level **1** after approximately ten minutes.

The system automatically switches off approximately 20 minutes after it is set to level **1**.

- ▶ **To switch on:** press button ① repeatedly until the desired heating level is set.
- ▶ **To switch off:** press button ① repeatedly until all the indicator lamps go out.

Rear-seat heating



- ① Level **1** (normal heating)
- ② Level **2** (rapid heating)

i The system automatically switches down from level **2** (rapid heating) to level **1** (normal heating) after approximately five minutes.

The system automatically switches off approximately 30 minutes after it is set to level **1**.

- ▶ **To select level 1:** press the upper section of button ①.
An indicator lamp lights up.
- ▶ **To deactivate level 1:** press the upper section of button ①.
The indicator lamp goes out.

- ▶ **To select level 2:** press the lower section of button ②.
Both indicator lamps light up.
- ▶ **To deactivate level 2:** press the lower section of button ②.
Both indicator lamps go out.

Problems with the seat heating

If one or all of the indicator lamps in the seat heating button are flashing, the seat heating has switched off automatically. The vehicle's electrical system voltage is too low because too many electrical consumers are switched on.

- ▶ Switch off electrical consumers which you do not need, such as the rear window defroster or interior lighting.
Once the battery is sufficiently charged, the seat heating will switch back on automatically.

Switching the seat ventilation on/off

Switching on/off

Seat ventilation is only available for the front seats.

The three blue indicator lamps in the buttons indicate the ventilation level you have selected.

- i** If the battery voltage is too low, the seat ventilation may switch off.



- ▶ Make sure that the SmartKey is in position **2** in the ignition lock.
- ▶ **To switch on:** press button ① repeatedly until the desired ventilation level is set.
- ① If you open the side windows and the sliding sunroof using the key (▷ page 71), the driver's seat ventilation automatically switches to the highest level.
- ▶ **To switch off:** press button ① repeatedly until all the indicator lamps go out.

Problems with the seat ventilation

If one or all of the indicator lamps in the seat ventilation button are flashing, the seat ventilation has switched off automatically. The vehicle's electrical system voltage is too low because too many electrical consumers are switched on.

- ▶ Switch off electrical consumers which you do not need, such as the rear window defroster or interior lighting. Once the battery is sufficiently charged, the seat ventilation will switch back on automatically.

Steering wheel

Important safety notes

You can adjust the steering wheel electrically.

Warning!

Do not adjust the steering wheel while driving. Adjusting the steering wheel while driving could cause the driver to lose control of the vehicle.

The electrical steering wheel adjustment feature can be operated at any time. Therefore, do not leave children unattended in the vehicle, or with access to an unlocked vehicle. A child's unsupervised access to a vehicle could result in an accident and/or serious personal injury.

When you adjust the steering wheel, make sure that:

- the steering wheel can be reached with your arms slightly bent.
- you can move your legs freely.
- you can see all the displays in the instrument cluster clearly.

Adjusting the steering wheel



- ① To adjust the steering wheel position (fore-and-aft adjustment)
- ② To adjust the steering wheel height
- ▶ Make sure that the SmartKey is in position **1** or **2** in the ignition lock.
- ① If the driver's door is open, the steering wheel can be adjusted for up to 30 minutes after the ignition has been switched off.
- ▶ Press the lever in the direction of arrow ① or ② until the steering wheel is in the desired position.

You can find more information under:

- EASY-ENTRY/EXIT feature (▷ page 84)
- Storing settings (▷ page 88)

Steering wheel heating

Switching on/off

The steering-wheel heating heats the leather areas of the steering wheel.



- ① To switch on the steering-wheel heating
- ② Indicator lamp
- ③ To switch off the steering-wheel heating

▶ **To switch on/off:** make sure that the key is in position **1** or **2** in the ignition lock.

▶ Turn the lever in the direction of arrow **①** or **③**.

Indicator lamp **②** lights up or goes out.

- i** The steering wheel heating does not switch off automatically.
- i** The steering wheel heating may switch off temporarily if:
 - the temperature of the vehicle interior is above 86 °F (30 °C).
 - the temperature of the steering wheel is above 95 °F (35 °C).

Indicator lamp **②** remains on.

- i** The steering wheel heating is deactivated if you remove the SmartKey from the ignition lock.

Problems with the steering wheel heating

If steering wheel heating indicator lamp **②** is flashing, the steering wheel heating has switched off automatically. The vehicle's electrical system voltage is too low because too many electrical consumers are switched on.

- ▶ Switch off electrical consumers which you do not need, such as the rear window defroster or interior lighting. Once the battery is sufficiently charged, the steering wheel heating will switch back on automatically.

Steering wheel EASY-ENTRY/EXIT feature

General notes

The EASY-ENTRY/EXIT feature makes getting in and out of your vehicle easier.

You can activate and deactivate the EASY-ENTRY/EXIT feature in the on-board computer (▶ page 165).

Important safety notes

⚠ Warning

You must make sure no one can become trapped or injured by the moving steering wheel when the EASY-ENTRY/EXIT feature is activated.

To stop steering maneuver do one of the following:

- press the steering column adjustment switch.
- press one of the memory function position buttons.
- press the memory button.

Do not leave children unattended in the vehicle, or with access to an unlocked vehicle. Children could open the driver's door and unintentionally activate the EASY-ENTRY/

EXIT feature. This could result in an accident and/or serious personal injury.

Warning

Let the system complete the adjustment procedure before setting the vehicle in motion. All steering wheel adjustment must be completed before setting the vehicle in motion. Driving off with the steering wheel still adjusting could cause the driver to lose control of the vehicle.

- !** Do not activate the EASY-ENTRY/EXIT feature, if the seat backrest is reclined too far backwards. This can damage the front or rear seats. You must first move the backrest to a vertical position.

Position of the steering wheel when the EASY-ENTRY/EXIT feature is active

The steering wheel moves upwards and towards the dashboard if:

- an easy-entry/exit steering wheel position has been stored for the key and
- you remove the key from the ignition lock or
- you open the driver's door with the key in position **0** or **1** in the ignition lock.

If you insert the key into the ignition lock with the driver's door closed, the steering wheel is automatically moved to the previously set position.

The last position of the steering wheel is stored when you switch off the ignition or when you store the setting with the memory function (> page 88).

- i** The steering wheel only moves upwards and towards the dashboard if it has not already reached the upper end stop.

Mirrors

Rear-view mirror

- ▶ Adjust the rear-view mirror by hand so you have a good overview of the traffic conditions.

Exterior mirrors

Important safety notes

Warning

Exercise care when using the passenger-side exterior rear view mirror. The mirror surface is convex (outwardly curved surface for a wider field of view). Objects in mirror are closer than they appear. Check your interior rear view mirror and glance over your shoulder before changing lanes.

At low outside temperatures, the exterior mirrors are heated automatically.

Adjusting the exterior mirrors

The switches are located on the dashboard on the left-hand side.

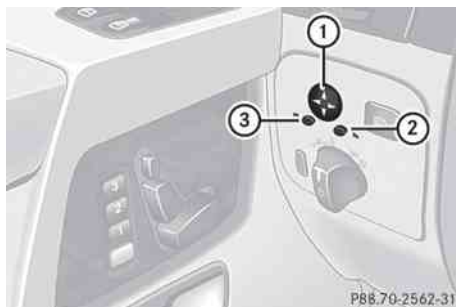

- ▶ Make sure that the SmartKey is in position **1** or **2** in the ignition lock.
- ▶ Press button **2** for the right-hand exterior mirror or button **3** for the left-hand exterior mirror.
- ▶ Press adjustment button **1** up, down, to the right or to the left until the exterior

mirror is set to a position that provides you with a good overview of traffic conditions.

You will find further information in the "Storing settings" section (▷ page 88).

Exterior mirror out of position

If an exterior mirror has been pushed out of position, proceed as follows:

- ▶ Move the exterior mirror into the correct position manually.
The mirror housing is engaged again and you can adjust the exterior mirrors as usual (▷ page 85).

Problems with the exterior mirrors

Problem	Possible causes/consequences and ► Solutions
An exterior mirror has been pushed out of position.	► Move the exterior mirror into the correct position manually.

Automatic anti-glare mirrors

⚠ Warning!

The auto-dimming function does not react if incoming light is not aimed directly at sensors in the interior rear view mirror.

The interior rear view mirror and the exterior rear view mirror on the driver's side do not react, for example, when transporting cargo which covers the rear window.

Light hitting the mirror(s) at certain angles (incident light) could blind you. As a result, you may not be able to observe traffic conditions and could cause an accident.

The rear-view mirror and the exterior mirror on the driver's side automatically go into anti-glare mode if the ignition is switched on and incident light from headlamps strikes the sensor in the rear-view mirror.

The mirrors do not go into anti-glare mode if reverse gear is engaged or the interior lighting is switched on.

Parking position for the exterior mirror on the front-passenger side

General notes

To make it easier to park, you can store the front-passenger side exterior mirror position in such a way that you can see the rear wheel on that side as soon as you engage reverse gear **R**.

Using the memory buttons on the driver's side, you can store three parking positions per key.

Setting and storing the parking position

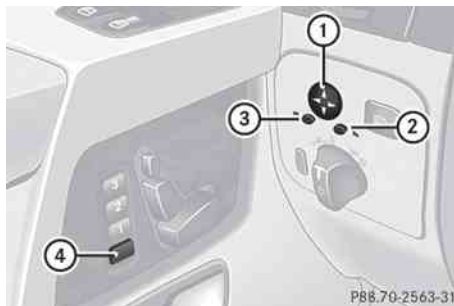

- ① Adjustment button
- ② Right-hand exterior mirror
- ③ Left-hand exterior mirror
- ④ Memory button

- Make sure that the vehicle is stationary and that the key is in position **1** or **2** in the ignition lock.
- Press button ② for the exterior mirror on the front-passenger side.
- Engage reverse gear **R**.
The exterior mirror on the front-passenger side moves to the preset parking position.
- Use adjustment button ① to adjust the exterior mirror to a position which allows you to see the rear wheel and the curb.
- Press memory button ④ and adjustment button ① within three seconds.
The parking position is stored if the exterior mirror does not move.

- ❗ If the mirror moves out of position, repeat the steps.
- ❗ If you shift the transmission to another position, the exterior mirror on the front-

passenger side returns to the driving position.

Calling up a stored parking position setting

- ▶ With the key in position **2** in the ignition lock and the exterior mirror on the front-passenger side activated, engage reverse gear.
The exterior mirror on the front-passenger side moves to the stored parking position.

The exterior mirror on the front-passenger side moves back to its original position:

- as soon as you exceed a speed of 10 km/h
- about ten seconds after you have disengaged reverse gear **R**
- if you press button **③** for the exterior mirror on the driver's side

Memory functions

Storing settings

With the memory function, you can store up to three different settings, e.g. for three different people.

The following settings are stored as a single memory preset:

- position of the seat, backrest and head restraint
- driver's side: steering wheel position
- driver's side: position of the exterior mirrors on the driver's and front-passenger sides

Warning

Do not activate the memory function while driving. Activating the memory function while driving could cause the driver to lose control of the vehicle.

The buttons are located on the door control panel.

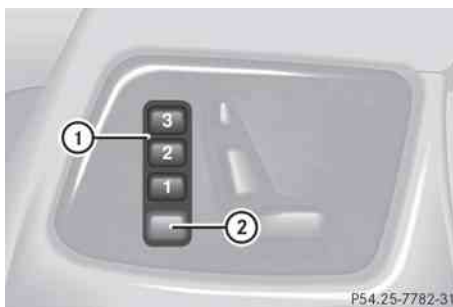

P54.25-7782-31

- ▶ Make sure that the key is in position **2** or that the respective door is open.
- ▶ Adjust the seat (▶ page 78) and head restraint (▶ page 79).
- ▶ On the driver's side, adjust the steering wheel (▶ page 83) and the exterior mirrors (▶ page 85).
- ▶ Press memory button **②**.
- ▶ Press one of memory buttons **① 1, 2 or 3** within three seconds.
The settings are stored in the selected storage position.

Calling up a stored setting

- ▶ Press and hold the relevant memory button **1, 2 or 3**, until the seat, head restraints, steering wheel and mirrors are in the stored position.
- i** The setting procedure is interrupted as soon as you release the memory button.
- !** If you want to move the seat from the fully reclined position to a stored seat position, first raise the backrest using the seat switch. The seat could otherwise be damaged.

Vehicle equipment	90
Exterior lighting	90
Interior lighting	94
Changing bulbs	96
Windshield wipers	101

Vehicle equipment

i This manual describes all the standard and optional equipment of your vehicle which was available at the time of purchase. Country-specific differences are possible. Please note that your vehicle may not be equipped with all features described. This also applies to safety-relevant systems and functions.

Exterior lighting

Important safety notes

For reasons of safety, Mercedes-Benz recommends that you drive with the lights switched on even during the daytime. In some countries, operation of the headlamps varies due to legal requirements and self-imposed obligations. In these countries, the daytime running lamps are automatically switched on when the engine is started.

Information about driving abroad

Converting to symmetrical low beam when driving abroad: switch the headlamps to symmetrical low beam in countries in which traffic drives on the opposite side of the road to the country where the vehicle is registered. This prevents glare to oncoming traffic. Symmetrical lights do not illuminate as large an area of the edge of the road.

Have the headlamps converted at a qualified specialist workshop, e.g. an authorized Mercedes-Benz Center, as close to the border as possible before driving in these countries.

Converting to asymmetrical low beam after returning: have the headlamps converted back to asymmetrical low beam at a qualified specialist workshop, e.g. an authorized Mercedes-Benz Center, as soon as possible after crossing the border when returning.

Light switch

Operation



- 1 Left-hand standing lamps
- 2 Right-hand standing lamps
- 3 **0** Lights off/daytime running lamps
- 4 **AUTO** Automatic headlamp mode/daytime running lamps
- 5 Standing lamps, perimeter lamps, license plate illumination and instrument cluster illumination
- 6 Low-beam/high-beam headlamps
- 7 Front fog lamps
- 8 Rear fog lamp

The turn signals, high-beam headlamps and the high-beam flasher are operated using the combination switch (> page 93).

! Switch off the standing lamps, parking lamps and low-beam headlamps when you leave the vehicle. This prevents the battery from discharging.

The exterior lighting (except the parking lamps) switches off automatically if you:

- remove the SmartKey from the ignition lock
- open the driver's door with the SmartKey in position **0**

If you hear a warning tone when you leave the vehicle, the lights may still be switched on. The **Switch Off Lights** message appears in the multifunction display.



► Turn the light switch to **0** or **AUTO**.

- ▶ If you see the **Turn off lights or remove key** message in the multifunction display, remove the SmartKey from the ignition lock.

or

- ▶ Turn the light switch to **0** or **AUTO**.

Low-beam headlamps

- ▶ **To switch on:** turn the SmartKey to position **2** in the ignition lock or start the engine.
- ▶ Turn the light switch to . The  indicator lamp in the instrument cluster lights up.
- ▶ **To switch off:** turn the light switch to **0**.

Daytime running lamps

Daytime running lamps in Canada

The "daytime running lamps" function is required by law in Canada. It cannot therefore be deactivated.

- ▶ Turn the light switch to **0** or **AUTO**.
When the engine is running: depending on the ambient light, the low-beam headlamps or the parking lamps are switched on.
When the low-beam headlamps are switched on, the  indicator lamp in the instrument cluster lights up.

If the light switch is set to **0** or **AUTO**, you cannot activate the high-beam headlamps. However, the high-beam flasher can always be used. Turn the light switch to  when driving at night. You can switch on the high-beam headlamps in this position.

When the engine is running and the vehicle is stationary: if you move the selector lever from a driving position to **N** or **P**, the low-beam headlamps go out after three minutes.

When the engine is running: if you turn the light switch to , you turn on the parking lamps and low-beam headlamps.

When the engine is running: if you turn the light switch to , the manual settings take precedence over the daytime running lamps.

Daytime running lamps in the USA

In the USA, the daytime running lamps are deactivated upon delivery from the factory.



- ▶ **To switch on:** activate the daytime running lamps function in the on-board computer (▷ page 164).
- ▶ Turn the light switch to **0** or **AUTO**.
When the engine is on: the low-beam headlamps are switched on. The  indicator lamp in the instrument cluster lights up.

If the light switch is set to **0** or **AUTO**, you cannot switch on the high-beam headlamps in bright conditions. Turn the light switch to . You can switch on the high-beam headlamps in this position.

If the light switch is set to **0**, **AUTO** or , you can switch on the high-beam headlamps in less bright conditions.

However, the high-beam flasher can always be used.

Turn the light switch to  when driving at night.

When the engine is running: if you turn the light switch to  or , the manual settings take precedence over the daytime running lamps.



Automatic headlamp mode

Warning

If the exterior lamp switch is set to **AUTO**, the headlamps will not automatically come on under foggy conditions.

To minimize risk to you and to others, activate headlamps by turning exterior lamp switch to  when traffic and/or ambient lighting conditions require you to do so.

In low ambient lighting conditions, only switch from position **AUTO** to  with the vehicle at a standstill in a safe location. Switching

from  to  will briefly switch off the headlamps. Doing so while driving in low ambient lighting conditions may result in an accident.

The automatic headlamp feature is only an aid to the driver. The driver is responsible for the operation of the vehicle's lights at all times.



The parking lamps, low-beam headlamps and license plate lamp are switched on or off automatically, depending on the brightness of the ambient light.

► **To switch on:** turn the light switch to .

SmartKey in position **1** in the ignition lock: the standing lamps are switched on or off automatically depending on the brightness of the ambient light.

When the engine is running: depending on the ambient light, the parking lamps, the low-beam headlamps and the license plate lamp are switched on or off automatically.

When the low-beam headlamps are switched on, the  indicator lamp in the instrument cluster lights up.

Canada only: if the light switch is in position  or , you cannot switch on the high-beam headlamps. However, the high-beam flasher can always be used. Turn the light switch to  when driving at night. You can switch on the high-beam headlamps in this position.



Front fog lamps and rear fog lamp



Front fog lamps





Warning

If you suspect that driving conditions will be foggy, turn the light switch to  before you start your journey. Your vehicle may otherwise not be visible and you could endanger yourself and others.





Warning

In low ambient lighting or foggy conditions, only switch from position  to  with the vehicle at a standstill in a safe location.

Switching from  to  will briefly switch off the headlamps. Doing so while driving in low ambient lighting conditions may result in an accident.

- **To switch on:** turn the SmartKey to position **2** in the ignition lock or start the engine.
- Turn the light switch to  or . If the light switch is set to , you cannot switch on the fog lamps.
- Pull the light switch out to the first detent. The green  indicator lamp on the light switch lights up.
- **To switch off:** press the light switch in as far as it will go. The green  indicator lamp on the light switch goes out.

Rear fog lamp



- **To switch on:** turn the SmartKey to position **2** in the ignition lock or start the engine.
- Turn the light switch to  or . When the light switch is set to , you cannot switch on the rear fog lamp.
- Pull the light switch out to the second stop. The yellow  indicator lamp on the light switch lights up.
- **To switch off:** press the light switch in as far as it will go. The yellow  indicator lamp on the light switch goes out.

Combination switch



Turn signal



P54.25-7947-31

- ▶ **To indicate briefly:** press the combination switch briefly to the pressure point in the direction of arrow ② or ④. The corresponding turn signal flashes three times.
- ▶ **To indicate:** press the combination switch beyond the pressure point in the direction of arrow ② or ④. The corresponding  or  indicator lamp in the instrument cluster flashes.

High-beam headlamps

- ▶ **To switch on:** turn the SmartKey to position 2 in the ignition lock or start the engine.
- ▶ Turn the light switch to .
- ▶ Press the combination switch beyond the pressure point in the direction of arrow ①. The  indicator lamp in the instrument cluster lights up.
- ▶ **To deactivate:** move the combination switch back to its normal position. The  indicator lamp in the instrument cluster goes out.

High-beam flasher

- ▶ **To switch on:** turn the SmartKey in the ignition lock to position 1 or 2 or start the engine.
- ▶ Pull the combination switch briefly in the direction of arrow ③. The  indicator lamp in the instrument cluster lights up briefly.

Hazard warning lamps



P54.25-7786-31

The hazard warning lamp switches on automatically if an air bag or the belt tensioners are triggered and the SmartKey is in position 1 in the ignition lock.

- ▶ **To switch on:** press button ①. All turn signals flash. If you now switch on a turn signal using the combination switch, only the turn signal lamp on the corresponding side of the vehicle will flash.
 - ▶ **To switch off:** press the ① button.
- i** The hazard warning lamps still operate if the ignition is switched off.

Headlamp cleaning system

The headlamps are cleaned automatically if the "Wipe with washer fluid" function is operated fifteen times while the lights are on and the engine is running (▷ page 102). When you switch off the ignition, the automatic headlamp cleaning system is reset and counting is resumed from 0.



- ▶ **To switch on manually:** turn the SmartKey to position **2** in the ignition lock or start the engine.
- ▶ Briefly press button ① of the headlamp cleaning system. The headlamps are cleaned with a high-pressure water jet.

Cornering light function

The cornering light function improves the illumination of the road over a wide angle in the direction you are turning, enabling better visibility in tight bends, for example. It can only be activated if the low-beam headlamps are switched on and the fog lamp is switched off.

Active: if you are driving at speeds below 25 mph (40 km/h) and switch on the turn signals and turn the steering wheel.

Not active: if you are driving at speeds above 25 mph (40 km/h) or switch off the turn signal and turn the steering wheel to the straight-ahead position.

The cornering lamp may remain lit for a short time.

Headlamps and turn signal lamps fogged up on the inside

The headlamps and the indicator lamps in the exterior mirrors may fog up on the inside if there is high atmospheric humidity.

- ▶ Drive with the headlamps switched on. The level of moisture diminishes, depending on the length of the journey and the weather conditions (humidity and temperature).

If the level of moisture does not diminish:





- ▶ Have the headlamps checked at a qualified specialist workshop.

Interior lighting

Overview of interior lighting



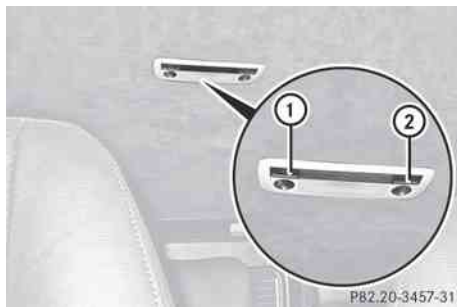

Front overhead control panel

- ①  To switch the cargo compartment lamp/rear interior lighting on/off
- ②  Switches the right-hand reading lamp on/off
- ③  Rocker switch (to control the interior lighting)
- ④  Switches the left-hand reading lamp on/off



Rear-compartment overhead control panel

- ①  Switches the right-hand reading lamp on/off
- ②  Switches the left-hand reading lamp on/off

Interior lighting control

Important notes

In order to prevent the vehicle's battery from discharging, the interior lighting functions are automatically deactivated after some time except for when the SmartKey is in position 2 in the ignition lock.

Automatic interior lighting control

- ▶ **To switch on:** set rocker switch ③ to the center position.

The interior lighting switches on automatically when it is dark if you:

- unlock the vehicle
- open a door
- remove the SmartKey from the ignition lock

The interior light is activated for a short while when the SmartKey is removed from the ignition lock. You can activate this delayed switch-off using the on-board computer (▷ page 165).

When a front door is opened, the front interior lighting comes on. When a rear door is opened, the rear interior lighting comes on. In addition, the courtesy lights come on.

- ❗ If a door remains open and the SmartKey is not in the ignition lock, the interior lighting switches off after a short while.

- ▶ **To switch off:** press the  symbol on rocker switch ③.

The interior lighting remain switched off even when it is dark if you:

- unlock the vehicle
- open a door
- remove the SmartKey from the ignition lock

Manual control

Front interior lighting

- ❗ If the interior lighting has been switched on manually, it will not be switched off automatically.

This can cause the starter battery to discharge.

Make sure that the interior lighting does not remain switched on too long after the engine has been switched off.

- ▶ **To switch on:** press the  symbol on rocker switch ③.
- ▶ **To switch off:** set rocker switch ③ to the center position.

Reading lamps

- ▶ **To switch on/off:** press the  button.

Cargo compartment lamp

Warning!

To prevent possible personal injury, always keep hands and fingers away from the cargo compartment opening when closing the tailgate. Be especially careful when small children are around.

Warning!

Make sure the tailgate is closed when the engine is running and while driving. Among other dangers, deadly carbon monoxide (CO) gases may enter vehicle interior resulting in unconsciousness and death.

! Switch off the cargo compartment lamp if you wish to leave the rear door open for a longer period. The battery may otherwise discharge.

▶ **To switch on/off:** press the  button.

i If you open the rear door, the cargo compartment lamp comes on. Then, you cannot switch it off using the  button.

Switch off the cargo compartment lamp if you wish to leave the rear door open for a longer period. This prevents the battery from discharging.



▶ Open the rear door.

▶ **To switch off with the rear door open:** press lock **1** down in the direction of the arrow until it engages. The cargo compartment lamp is switched off.

! Do not close the rear door while lock **1** is engaged at the bottom. Otherwise, you could damage lock **1**.

▶ **To switch on with the rear door open:** press lock cylinder **2**. The cargo compartment lamp resumes its normal function.

Rear interior lighting

▶ **To switch on/off:** press the  button.

i The rear interior lighting switches on when you open a rear door. Then, you cannot switch it off using the  button.

Switch off the rear interior lighting if you wish to leave the rear doors open for a longer period. This prevents the battery from discharging.

Changing bulbs

Important safety notes

Xenon bulbs

Warning

Xenon bulbs carry a high voltage. You could get an electric shock and be seriously or even fatally injured if you touch the electric contacts on Xenon bulbs. Therefore, never remove the cover from Xenon bulbs.

Do not change Xenon bulbs yourself, but have them replaced at a qualified specialist workshop which has the necessary specialist knowledge and tools to carry out the work required.

Mercedes-Benz recommends that you use an authorized Mercedes-Benz Center for this purpose. In particular, work relevant to safety or on safety-related systems must be carried out at a qualified specialist workshop.

Bulbs and lamps are an important aspect of vehicle safety. You must therefore make sure that these function correctly at all times. Have the headlamp setting checked regularly.

Other bulbs

Warning

Bulbs and lamps can be very hot. You should therefore allow them to cool down before you change them. Otherwise, you could be burned if you touch them.

Keep bulbs out of the reach of children. Otherwise, they could damage the bulbs, for example, and injure themselves.

Never use a bulb which has been dropped. Such a bulb may break or even explode and injure you.

Halogen bulbs are pressurized and could explode when you change them, particularly if they are very hot. You should therefore wear eye protection and gloves when you are changing them.

There are bulbs other than the Xenon bulbs that you cannot replace. Replace only the bulbs listed (▷ page 97). Have the bulbs that you cannot replace yourself changed at a qualified specialist workshop.

Mercedes-Benz recommends that you use an authorized Mercedes-Benz Center for this purpose. In particular, work relevant to safety or on safety-related systems must be carried out at a qualified specialist workshop.

If you require assistance changing bulbs, consult a qualified specialist workshop.

Do not touch the glass tube of new bulbs with your bare hands. Even minor contamination can burn into the glass surface and reduce the service life of the bulbs. Always use a lint-free cloth or only touch the base of the bulb when installing.

Only use bulbs of the correct type.

If the new bulb still does not light up, consult a qualified specialist workshop.

Bulbs and lamps are an important aspect of vehicle safety. You must therefore make sure that these function correctly at all times.

Have the headlamp setting checked regularly.

Before changing bulbs

Have the following bulbs changed at a qualified specialist workshop, e.g. an authorized Mercedes-Benz Center:

- additional turn signals in the exterior mirrors
- high-mounted brake lamp
- high-beam/low-beam headlamps (Xenon bulbs)
- parking lamp/standing lamp
- license plate lamp

- i** Individual segments of the license plate lamp LEDs may fail without a display message appearing in the multifunction display. Check the license plate lamp regularly. Consult a qualified specialist workshop if necessary.

You can replace the following bulbs:

- fog lamp/cornering light with fog lamp function
- turn signal lamp (front)
- brake/tail lamp
- turn signal lamp (rear)
- tail lamp/standing lamp
- backup lamp
- rear fog lamp
- side marker lamp

Overview: changing bulbs/bulb types



Front bulbs

- ① Turn signal lamp: 1156 NA
- ② Side marker lamp: T 4 W
- ③ Cornering light function with fog lamp function: H 11 55 W



Rear bulbs

① Side marker lamp: T 4 W

② Tail lamps:

Turn signal lamp: PY 21 W

Brake lamp/tail lamp: P 21/5 W

Tail lamp/parking lamp: W 5 W

③ Backup lamp: P 21 W

④ License plate lamp: LEDs⁵

⑤ Rear fog lamp: P 21 W

Changing the front bulbs

Front fog lamps/cornering lamps with fog lamp function



- ▶ Switch off the lights.
- ▶ Remove screws ①.
- ▶ Remove cover ②.



- ▶ Remove screws ④.

i Only remove screws ④. Do not turn adjustment screw ⑤. If adjustment screw ⑤ is turned, the front fog lamp adjustment must be checked at a qualified specialist workshop, e.g. an authorized Mercedes-Benz Center.

- ▶ Remove headlamp ③.

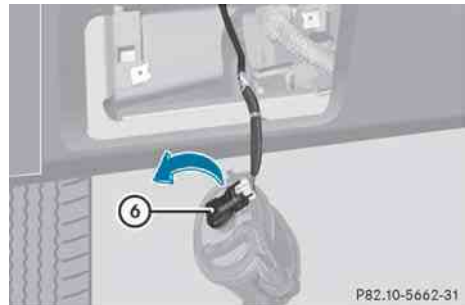

- ▶ Hold headlamp ③.
- ▶ Lightly press bulb holder ⑥, turn it counter-clockwise to the stop and pull it out.

⁵ These bulbs must be replaced at a qualified specialist workshop, e.g. an authorized Mercedes-Benz Center.

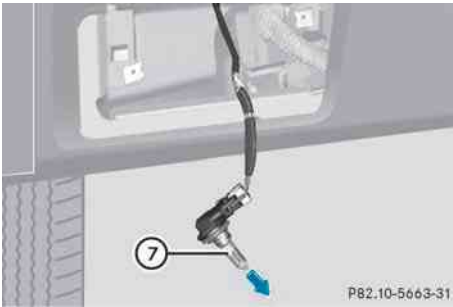

- ▶ Take bulb ⑦ out of bulb holder ⑥.
- ▶ Insert the new bulb into bulb holder ⑥.
- ▶ Insert bulb holder ⑥ into headlamp ③ and turn it clockwise to the stop.
- ▶ Insert headlamp ③.
- ▶ Replace and tighten screws ④.
- ▶ Position cover ②.
- ▶ Replace and tighten screws ①.

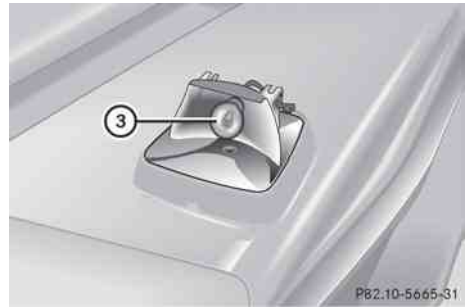

- ▶ Lightly press bulb ③, turn it counter-clockwise and pull it out.
 - ▶ Insert the new bulb and, applying slight pressure, turn it clockwise until it engages.
 - ▶ Install lens ②.
 - ▶ Replace and tighten screws ①.
- !** Do not fasten the screws too tightly. You could otherwise damage the lens.
- ▶ **G 55 AMG:** fold the headlamp protection grille back and engage it into the bracket.

Turn signal

- ▶ **G 55 AMG:** release the turn signal protection grille from the rear of the bracket and fold it forward.

! Make sure that the headlamp protection grille does not strike against painted surfaces. You could otherwise damage the paintwork.

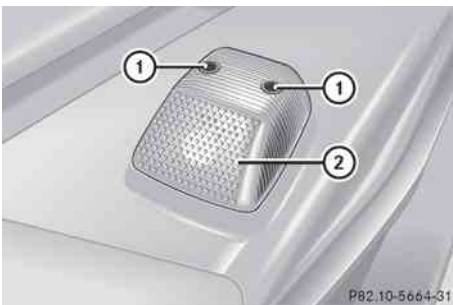

- ▶ Switch off the lights.
- ▶ Remove screws ①.
- ▶ Remove lens ②.

Side marker lamp

The bulbs of the front and rear side marker lamps are changed in the same way.

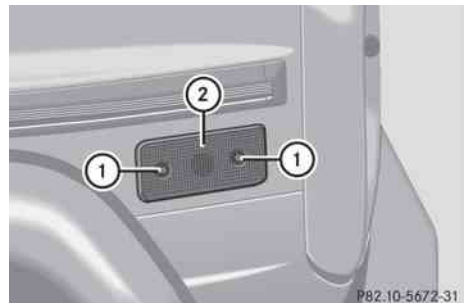

Front side marker lamp (example)

- ▶ Switch off the lights.
- ▶ Remove screws ①.
- ▶ Remove housing ②.

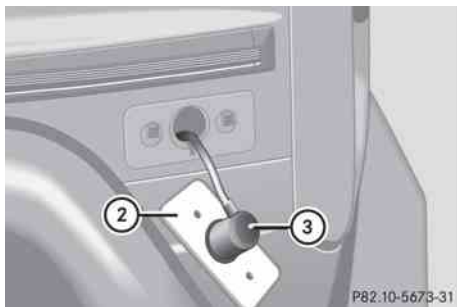

P82.10-5673-31

- ▶ Remove dust cover (3).
- ▶ Push the catch to the side and pull the bulb holder with the bulb out of housing (2).



P82.10-5674-31

- ▶ Lightly press bulb (4), turn it counter-clockwise and pull it out.
- ▶ Insert the new bulb and, applying slight pressure, turn it clockwise until it engages.
- ▶ Insert the bulb holder into housing (2).
- ▶ Attach dust cover (3).
- ▶ Insert housing (2).
- ▶ Replace and tighten screws (1).

! Do not fasten the screws too tightly. You could otherwise damage the lens.

Changing the rear bulbs

G 55 AMG only: headlamp protective grid

You must remove the headlamp protection grille before you can change the bulbs in the tail lamps.

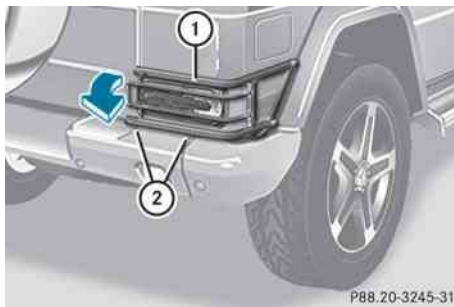

P88.20-3245-31

- G 55 AMG: headlamp protection grille
- ▶ Unscrew screws (2).
- ▶ Swing headlamp protection grille (1) to the right.

! Make sure that the headlamp protection grille does not strike against painted surfaces.

You could otherwise damage the paintwork.

- ▶ After changing the bulbs, swing headlamp protection grille (1) to the left.
- ▶ Tighten screws (2).

Tail lamp



P82.10-5831-31

- ▶ Switch off the lights.
- ▶ Remove screws (1).
- ▶ Remove lens (2).



- ③ Turn signals
- ④ Brake/tail lamp
- ⑤ Tail lamp/standing lamp

- ▶ Turn the bulb counter-clockwise, applying slight pressure, and remove it from bulb holder.
- ▶ Insert the new bulb into the bulb holder and turn it clockwise until it engages.

! When installing the lens, make sure that the seal is positioned correctly.

- ▶ Install lens ②.
- ▶ Tighten screws ①.

! Do not fasten the screws too tightly. You could otherwise damage the lens.

- ▶ **G 55 AMG:** secure the headlamp protection grille (▶ page 100).

Backup lamp/rear fog lamp



Rear fog lamp (example)

- ▶ Switch off the lights.
- ▶ Remove screws ①.
- ▶ Remove lens ②.



- ▶ Turn the bulb ③ counter-clockwise, applying slight pressure, and remove it from the bulb holder.
- ▶ Insert the new bulb into the bulb holder and turn it clockwise until it engages.
- ▶ Install lens ②.
- ▶ Tighten screws ①.

! Do not fasten the screws too tightly. You could otherwise damage the lens.

Windshield wipers

Important safety notes

! Warning!

Wiper blades are components that are subject to wear and tear. Replace the wiper blades twice a year, preferably in the spring and fall. Otherwise the windows will not be wiped properly. As a result, you may not be able to observe surrounding traffic conditions and could cause an accident.

! Do not operate the windshield wipers when the windshield is dry, as this could damage the wiper blades. Moreover, dust that has collected on the windshield/rear window can scratch the glass if wiping takes place when the windshield/rear window is dry.

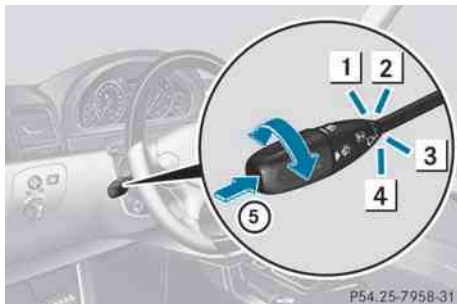

If it is necessary to switch on the windshield wipers in dry weather conditions, always use washer fluid when operating the windshield wipers.

Switching the windshield wipers on/off



P54.25-7958-31

Combination switch

- ① III Continuous wipe, fast
- ② II Continuous wipe, slow
- ③ I Intermittent wipe/rain sensor
- ④ 0 windshield wipers off
- ⑤  Single wipe /  To wipe the windshield using washer fluid

- ▶ Turn the SmartKey to position **1** or **2** in the ignition lock.
- ▶ Turn the combination switch to the corresponding position.

! Intermittent wiping with rain sensor: due to optical influences and the windshield becoming dirty in dry weather conditions, the windshield wipers may be activated inadvertently. This could then damage the windshield wiper blades or scratch the windshield.

For this reason, you should always switch off the windshield wipers in dry weather.

In the **I** position, the appropriate wiping frequency is set automatically according to the intensity of the rain.

Intermittent wiping is interrupted if you stop and open a front door. This protects people

getting into and out of the vehicle from being sprayed with water.



Intermittent wiping continues when all doors are closed and:

- you shift the automatic transmission to drive position **D** or reverse gear **R** or
- you change the wipe setting on the combination switch.

Switching the rear window wiper on/off



P54.25-7490-31

- ①  Intermittent wipe
- ②  Indicator lamp
- ③  To wipe with washer fluid

The rear window wiper comes on automatically if you shift the selector lever to **R** while the windshield wipers are on.

- ▶ Turn the SmartKey to position **1** or **2** in the ignition lock.
- ▶ **To switch on intermittent wiping:** push button ①. Indicator lamp ② lights up.
- ▶ **To switch off intermittent wiping:** push button ① again. Indicator lamp ② goes out.
- ▶ **To wipe with washer fluid:** push button ③ and hold it there until the rear window is clean. The rear window is wiped for a further five seconds after the button is released.

Replacing the wiper blades

Important safety notes

Warning!

For safety reasons, switch off the wipers and remove the SmartKey from the starter switch before replacing a wiper blade. Otherwise, the wiper motor could suddenly turn on and cause injury.

- ❗ To avoid damaging the wiper blades, make sure that you touch only the wiper arm of the wiper.
 - ❗ Never open the hood if a windshield wiper arm has been folded away from the windshield.
- Never fold a windshield wiper arm without a wiper blade back onto the windshield/rear window.
- Hold the windshield wiper arm firmly when you change the wiper blade. If you release the windshield wiper arm without a wiper blade and it falls onto the windshield, the windshield may be damaged by the force of the impact.
- Mercedes-Benz recommends that you have the wiper blades replaced by a qualified specialist workshop, e.g. at an authorized Mercedes-Benz Center.

Removing the wiper blade

- ▶ Remove the SmartKey from the ignition lock.
- ▶ Fold the wiper arm away from the windshield until it engages.
- ▶ Position the wiper blade at right angles.

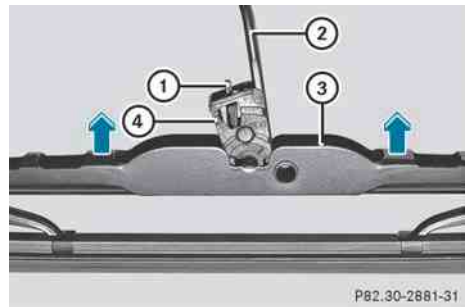

- ▶ Press locking spring ①.
- ▶ Slide wiper blade ③ with hinge piece ④ from wiper arm ②.

Installing the wiper blade

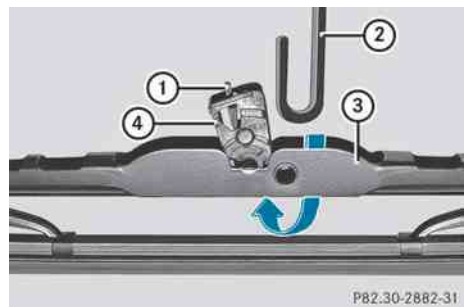

- ① Locking spring
 - ② Wiper arm
 - ③ Wiper blade
 - ④ Hinge piece
- ▶ Slide new wiper blade ③ with the recess onto wiper arm ②.
 - ▶ Engage locking spring ① into the end of the wiper arm.
 - ▶ Make sure that wiper blade ③ is seated correctly.
 - ▶ Fold wiper arm ② back onto the windshield.

Problems with the windshield wipers**The windshield wipers are obstructed**

Leaves or snow, for example, may be obstructing the windshield wiper movement. The wiper motor has been deactivated.

- ▶ For safety reasons, you should remove the SmartKey from the ignition lock.
- ▶ Remove the cause of the obstruction.
- ▶ Switch the windshield wipers back on.

The windshield wipers are inoperative

The windshield wiper drive is malfunctioning.

- ▶ Select another wiper speed on the combination switch.
- ▶ Have the windshield wipers checked at a qualified specialist workshop.

Vehicle equipment	106
Overview of climate control systems	106
Operating the climate control system	107
Setting the air vents	112

Vehicle equipment

- i** This manual describes all the standard and optional equipment of your vehicle which was available at the time of purchase. Country-specific differences are possible. Please note that your vehicle may not be equipped with all features described. This also applies to safety-relevant systems and functions.

Overview of climate control systems

Important safety notes

Warning

Severe conditions (e.g. strong air pollution) may require replacement of the filter before its scheduled replacement interval. A clogged filter will reduce the air volume to the interior and the windows could fog up, impairing visibility and endangering you and others. Have a clogged filter replaced as soon as possible at an authorized Mercedes-Benz Center.

Warning

Follow the recommended settings for heating and cooling given on the following pages. Otherwise, the windows could fog up, impairing visibility and endangering you and others.

Automatic climate control controls the temperature and the humidity in the vehicle interior and filters undesirable substances from the air.

Automatic climate control is only operational when the engine is running⁶. Optimum operation is only achieved when you drive with the side windows and the sliding sunroof closed.

- i** Ventilate the vehicle for a brief period during warm weather, e.g. using the convenience opening feature (▷ page 71).

This will speed up the cooling process and the desired vehicle interior temperature will be reached more quickly.





- i** The integrated filter can filter out most particles of dust and completely filters out pollen. A clogged filter reduces the amount of air supplied to the vehicle interior. For this reason, you should always observe the interval for replacing the filter, which is specified in the Service Booklet. As it depends on environmental conditions, e.g. heavy air pollution, the interval may be shorter than stated in the Service Booklet.

⁶ The "residual heat" function can only be switched on/off if the ignition is switched off.

Control panel for THERMATIC automatic climate control (2-zone)



PB3.30-4664-31

- ① To increase/reduce the airflow (▷ page 110)
To switch climate control on/off (▷ page 108)
- ② To set the temperature, left (▷ page 109)
- ③ To set the temperature, right (▷ page 109)
- ④ To set the air distribution (▷ page 109)
- ⑤  To switch the rear window defroster on/off (USA only) (▷ page 111)
- ⑤  To switch the rear window defroster on/off (Canada only) (▷ page 111)
- ⑥ To activate/deactivate cooling with air dehumidification (▷ page 108)
To activate/deactivate the residual heat function (▷ page 112)
- ⑦ To set climate control to automatic (▷ page 109)
- ⑧ To activate/deactivate air-recirculation mode (▷ page 111)
- ⑨  To defrost the windshield (USA only) (▷ page 110)
- ⑨  To defrost the windshield (Canada only) (▷ page 110)

Operating the climate control system

Notes about using THERMATIC automatic climate control (2-zone)

The following contains notes and recommendations on optimum use of dual-zone automatic climate control.

- Activate climate control using the **AUTO** and **A/C REST** buttons. The indicator lamps above the **AUTO** and **A/C REST** buttons light up.
- Set the temperature to 72 °F (22 °C).
- Only use the "defrosting" function briefly until the windshield is clear again.
- Only use "air-recirculation" mode briefly, e.g. if there are unpleasant outside odors or when in a tunnel. The windows could

otherwise fog up as, in air-recirculation mode, no fresh air is drawn into the vehicle.

- Use the residual heat function if you want to heat or ventilate the vehicle interior when the ignition is switched off. The "residual heat" function can only be activated or deactivated with the ignition switched off.
- At very low temperatures, the rear window defroster is only switched on once the vehicle interior has warmed up.

Activating/deactivating climate control

Important information

Warning!

When the climate control system is deactivated, the outside air supply and circulation are also deactivated. Only choose this setting for a short time. Otherwise the windows could fog up, impairing visibility and endangering you and others.

- i** Switch on climate control primarily using the **AUTO** button (▷ page 109).

Activating/deactivating

- ▶ Turn the key to position **2** in the ignition lock.
- ▶ **To switch on:** turn control **1** clockwise to the desired position (except position **0**) (▷ page 107).
- ▶ The previously selected settings come into effect again.
- ▶ **To switch off:** turn control **1** counter-clockwise to position **0** (▷ page 107).

Switching cooling with air dehumidification on/off

Important information

The cooling with air dehumidification function is only available when the engine is running. The air inside the vehicle is cooled and dehumidified according to the temperature selected.

Warning

If you switch off the cooling function, the vehicle will not be cooled when weather conditions are warm. The windows can fog up more quickly. Window fogging may impair visibility and endanger you and others.

Condensation may drip from the underside of the vehicle when it is in cooling mode. This is normal and not a sign that there is a malfunction.

- i** The cooling with air dehumidification function uses refrigerant R134a. This coolant does not contain chlorofluorocarbons, and therefore does not damage the ozone layer.

Activating/deactivating

- !** If the cooling with air dehumidification does not switch on, it is possible that the climate control system has lost coolant. Have the cooling with air dehumidification checked at a qualified specialist workshop.
- ▶ **To activate:** press the **A/C REST** button. The indicator lamp in the **A/C REST** button lights up.
- ▶ **To switch off:** press the **A/C REST** button. The indicator lamp in the **A/C REST** button goes out. The cooling with air dehumidification function has a delayed switch-off feature.

Problems with the cooling with air dehumidification function

If the indicator lamp in the  button does not go out or flashes when switched on, the cooling with air dehumidification function is switched off due to a malfunction. You can no longer switch on the cooling with air dehumidification function.

- ▶ Consult a qualified specialist workshop.





Setting climate control to automatic

Warning

If you switch off the cooling function, the vehicle will not be cooled when weather conditions are warm. The windows can fog up more quickly. Window fogging may impair visibility and endanger you and others.



In automatic mode, the set temperature is maintained automatically at a constant level. The system automatically regulates the temperature of the dispensed air, the airflow and the air distribution.

Automatic mode will achieve optimal operation if cooling with air dehumidification is also activated. If desired, cooling with air dehumidification can be deactivated.

- ▶ Turn the key to position **2** in the ignition lock.
- ▶ Set the desired temperature.
- ▶ **To switch on:** press the  button. The indicator lamp in the  button lights up. Automatic air distribution and airflow are activated.
- ▶ **To switch off:** press the  button. The indicator lamp in the  button goes out. Automatic air distribution and airflow are deactivated.

Setting the temperature

Different temperatures can be set for the driver's and front-passenger sides.

- ▶ Turn the key to position **2** in the ignition lock.
- ▶ **To increase/reduce:** turn controls  and  clockwise or counter-clockwise (▷ page 107).





Only change the temperature setting in small increments. Start at 72 °F (22 °C).



- i** If you turn the temperature control on one side of the vehicle fully clockwise or counter-clockwise, you will increase or reduce the temperature on the other side of the vehicle at the same time.

Setting the air distribution

You can set the air distribution for the entire vehicle.

The symbols for the air distribution have the following meanings:

Symbol	Meaning
	Directs the airflow through the defroster vents to the windshield and side windows
	Directs the airflow to the entire vehicle interior
	Directs the airflow through the footwell and side air vents
	Directs the airflow through the center and side air vents

- ▶ Turn the key to position **2** in the ignition lock.
- ▶ Press the  button. The indicator lamp in the  button goes out.
- ▶ Turn control  (▷ page 107) to the corresponding symbol. The control can also be turned to the area between two symbols.



Setting the airflow



- ▶ Turn the key to position **2** in the ignition lock.
- ▶ Press the **AUTO** button.
The indicator lamp in the **AUTO** button goes out.
- ▶ **To increase/reduce:** turn thumbwheel ① clockwise or counter-clockwise (▷ page 107).



i The airflow from the rear-compartment vents and the center vents is the same.

Defrosting the windshield

You can use this function to defrost the windshield or to defrost the inside of the windshield and the side windows.

- i** You should only select the defrosting function until the windshield is clear again.
- i** When you switch on the "defrosting" function using the ⁷ or ⁸ button, you cannot adjust any of the other settings.



- ▶ Turn the key to position **2** in the ignition lock.
- ▶ **To switch on:** press the ⁷ or ⁸ button.



The indicator lamp in the ⁷ or ⁸ button comes on.

The climate control system switches to the following functions:

- cooling with air dehumidification on
- high airflow
- high temperature
- air distribution to the windshield and front side windows
- air-recirculation mode off

i If necessary, also activate the windshield defroster (▷ page 110).

- ▶ **To deactivate:** press the ⁷ or ⁸ button.

The indicator lamp in the ⁷ or ⁸ button goes off. The previously selected settings come into effect again.

or

- ▶ Press the **AUTO** button.
The indicator lamp in the **AUTO** button lights up. The indicator lamp in the  button goes out. Airflow and air distribution are set to automatic mode.

Defrosting the windows

Windows fogged up on the inside



- ▶ Activate the "defrosting" function.
- ▶ If necessary, activate the windshield defroster (▷ page 110).

i You should only select this setting until the windshield is clear again.

Windows fogged up on the outside

- ▶ Switch on the windshield wipers.
- ▶ Close the center air vents.

When automatic air distribution is switched off:

- ▶ Turn the air distribution thumbwheel to the  or  symbol.

i You should only select this setting until the windshield is clear again.

- ▶ If necessary, activate the windshield defroster (▷ page 110).

Activating/deactivating windshield heating

Warning

Any accumulation of snow and ice should be removed from the windshield before driving.

⁷ USA only.

⁸ Canada only.

Otherwise, your vision may be impaired, which could endanger you or others.



- i** At outside temperatures over 50 °F (10 °C) the windshield defroster cannot be switched on. Indicator lamp ② lights up briefly when you attempt to activate it and then goes out again.
- i** The windshield defroster has a high current draw. You should therefore switch it off as soon as the windshield is clear. The windshield defroster switches off automatically after ten minutes.
- i** If you switch on the windshield defroster four times in a row, it switches off automatically after five minutes.
- i** If too many electrical consumers are switched on simultaneously and the battery voltage is too low, indicator lamp ② flashes in windshield defroster switch ①. After about 30 seconds the windshield defroster switches off.
 - ▶ Turn the key to position **2** in the ignition lock.
 - ▶ Press button ① on the windshield defroster. Indicator lamp ② lights up or goes out.

Switching the rear window defroster on/off





Activating/deactivating

Warning

Any accumulation of snow and ice should be removed from the rear window before driving. Visibility could otherwise be impaired, endangering you and others.

The rear window defroster has a high current draw. You should therefore switch it off as soon as the window is clear as it only switches off automatically after several minutes.

If the battery voltage is too low, the rear window defroster may switch off.

- ▶ Turn the key to position **2** in the ignition lock.
- ▶ To switch on, press the ⁹ or ¹⁰ button.
The indicator lamp in the ⁹ or ¹⁰ button goes off.

Problems with the rear window defroster

When the indicator lamp in the  rear window defroster button flashes, the on-board voltage is too low. The rear window defroster has deactivated itself prematurely or cannot be activated.

- ▶ Switch off any consumers that are not required, e.g. reading lamps or interior lighting.
When the battery is sufficiently charged, the rear window defroster is activated again automatically.

Activating/deactivating air-recirculation mode

You can deactivate the flow of fresh air if unpleasant odors are entering the vehicle

⁹ USA only.







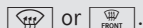

¹⁰ Canada only.

from outside. The air already inside the vehicle will then be recirculated.

Warning!

Fogged windows impair visibility, endangering you and others. If the windows begin to fog on the inside, switching off the air recirculation mode immediately should clear interior window fogging. If interior window fogging persists, make sure the air conditioning is activated, or press button







- ▶ Turn the key to position **2** in the ignition lock.
- ▶ **To switch on:** press the  button. The indicator lamp in the  button lights up.
- ▶ **To switch off:** press the  button. The indicator lamp in the  button goes out.
- ▶ **To activate:** press the  button. The indicator lamp in the  button lights up.
- ▶ **To switch off:** press the  button. The indicator lamp in the  button goes out.
- ▶ **Warning!** Residual heat is deactivated automatically:
 - after about 30 minutes
 - when the ignition is switched on
 - if the battery voltage drops
 - if the coolant temperature is too low
- ▶ **Warning!** Air-recirculation mode is activated automatically at high outside temperatures. When air-recirculation mode is activated automatically, the indicator lamp in the  button is not lit. Outside air is added after about 30 minutes.
- ▶ **Warning!** Air-recirculation mode switches off automatically:
 - after approximately five minutes if outside temperatures are less than about 41 °F (5 °C)
 - after approximately five minutes if cooling with air dehumidification is deactivated
 - after approximately 30 minutes if outside temperatures are over about 41 °F (5 °C)

Activating/deactivating the residual heat function

It is possible to make use of the residual heat of the engine to continue heating the stationary vehicle for up to 30 minutes after

the engine has been switched off. The heating time depends on the coolant temperature and on the interior temperature that has been set.

- ▶ **Warning!** The blower will run at a low speed regardless of the airflow setting.
- ▶ **Warning!** If you activate the residual heat function at high temperatures, only the ventilation will be activated.
- ▶ Turn the key to position **0** in the ignition lock or remove it.
- ▶ **To activate:** press the  button. The indicator lamp in the  button lights up.
- ▶ **To switch off:** press the  button. The indicator lamp in the  button goes out.
- ▶ **Warning!** Residual heat is deactivated automatically:
 - after about 30 minutes
 - when the ignition is switched on
 - if the battery voltage drops
 - if the coolant temperature is too low

Setting the air vents

Important safety notes

Warning

When operating the climate control, the air that enters the passenger compartment through the air vents can be very hot or very cold (depending on the set temperature). This could cause burns or frostbite to unprotected skin in the immediate area of the air vents.

Always keep sufficient distance between unprotected parts of the body and the air vents. If necessary, use the air distribution adjustment to direct the air to air vents in the vehicle interior that are not in the immediate area of unprotected skin.

In order to ensure the direct flow of fresh air through the air vents into the vehicle interior, please observe the following notes:

- keep the air intake grille on the hood free of blockages, such as ice, snow or leaves
 - never cover the air vents or air intake grille in the vehicle interior.
- i** For virtually draft-free ventilation, adjust the sliders of the air vents to the center position.

Setting the center air vents



Center air vents

- ① Center air vent, left
 - ② Center air vent, right
 - ③ Center vent thumbwheel, right
 - ④ Center vent thumbwheel, left
- **To open/close:** turn thumbwheels ③ and ④ to the right or left.

Setting the side air vents



Side air vents

- ① Side air vent
 - ② Swiveling side air vent
 - ③ Control for side air vent
- **To open/close:** turn thumbwheel ③ to the left or right.

Setting the rear-compartment air vents

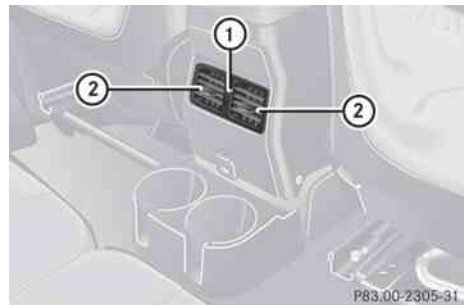

- **To open/close:** turn thumbwheel ① up or down.
- **To set the air direction:** move slider ② for the corresponding rear-compartment air vent to the left, right, up or down.

Vehicle equipment	116
Breaking-in notes	116
Driving	116
Automatic transmission	121
Refueling	131
Parking	134
Driving tips	136
Driving systems	147

Vehicle equipment

- i** This manual describes all the standard and optional equipment of your vehicle which was available at the time of purchase. Country-specific differences are possible. Please note that your vehicle may not be equipped with all features described. This also applies to safety-relevant systems and functions.

Breaking-in notes

The first 1000 miles (1500 km)

The more you look after the engine when it is new, the more satisfied you will be with its performance in the future.

- Drive at varying vehicle speeds and engine speeds for the first 1000 miles (1500 km) for this reason.
- Avoid overstraining the vehicle during this period, e.g. driving at full throttle.
- Change gear in good time, at the latest when the tachometer needle is $\frac{2}{3}$ of the way to the red area in the tachometer display.
- Do not manually shift to a lower gear to brake the vehicle.
- If possible, do not depress the accelerator pedal past the point of resistance (kickdown).
- Only select shift ranges **3**, **2** or **1** when driving slowly, e.g. in mountainous terrain.

After 1000 miles (1500 km), you can increase the engine speed gradually and bring the vehicle up to full speed.

Additional breaking-in notes for AMG vehicles:

- do not drive faster than 85 mph (140 km/h) in the first 1000 miles (1500 km).
- only allow the engine to reach a maximum engine speed of 4500 rpm briefly.
- change gear in good time.

- i** You should also observe these notes on running in if the engine or parts of the drive train on your vehicle have been replaced.

- i** Always observe the respective speed restrictions.

Driving

Important safety notes

Warning

Make sure absolutely no objects are obstructing the pedals' range of movement. Keep the driver's footwell clear of all obstacles. If there are any floor mats or carpets in the footwell, make sure the pedals still have sufficient clearance.

During sudden driving or braking maneuvers the objects could get caught between the pedals. You could then no longer brake or accelerate. This could lead to accidents and injury.

Warning

On slippery road surfaces, never downshift in order to obtain braking action. This could result in drive wheel slip and reduced vehicle control. Your vehicle's ABS will not prevent this type of loss of control.

Warning

It is dangerous to shift AUTOTRONIC out of parking position **P** or neutral position **N** if the engine speed is higher than idle speed. If your foot is not firmly on the brake pedal, the vehicle could accelerate quickly forward or in reverse. You could lose control of the vehicle and hit someone or something. Only shift into gear when the engine is idling normally and when your right foot is firmly on the brake pedal.

- !** Warm up the engine quickly. Do not use the engine's full performance until it has reached operating temperature.

Only shift the automatic transmission to the desired drive position when the vehicle is stationary.

Where possible, avoid spinning the drive wheels when pulling away on slippery roads. You could otherwise damage the drive train.

- !** Avoid high engine speeds when the engine is cold. The engine's service life could otherwise be significantly shortened. Do not use the engine's full performance until it has reached operating temperature.

SmartKey positions



- 0** To remove the SmartKey
 - 1** Power supply for some consumers, such as the windshield wipers
 - 2** Ignition (power supply for all consumers) and drive position
 - 3** To start the engine
- i** You can only remove the SmartKey if:
- the SmartKey is in position **0** in the ignition lock.
 - the automatic transmission selector lever is in **P**.

As soon as the ignition is switched on, all the indicator lamps in the instrument cluster light up. If an indicator lamp does not go out after the engine is started or if it lights up while the vehicle is in motion, see (▷ page 183).

If the SmartKey is in position **0** in the ignition lock for an extended period of time, it can no

longer be turned in the ignition lock. The steering is then locked. To unlock, remove the SmartKey and reinsert it into the ignition lock. The steering is locked when you remove the SmartKey from the ignition lock.

- ▶ Remove the SmartKey when the engine is switched off. The starter battery could otherwise be discharged.

If you cannot turn the SmartKey in the ignition lock, the starter battery may not be charged sufficiently.

- ▶ Check the starter battery and charge if necessary (▷ page 236).

or

- ▶ Jump-start the vehicle (▷ page 238).

Starting the engine

Important safety notes

⚠ Warning

Inhalation of exhaust gas is hazardous to your health. All exhaust gas contains carbon monoxide (CO), and inhaling it can cause unconsciousness and possible death.

Do not run the engine in confined areas (such as a garage) which are not properly ventilated. If you think that exhaust gas fumes are entering the vehicle while driving, have the cause determined and corrected immediately. If you must drive under these conditions, drive only with at least one window fully open at all times.

- !** Do not depress the accelerator pedal when starting the engine.

Starting procedure

- ▶ Shift the automatic transmission to position **P**. The transmission position display in the multifunction display shows **P**.

- i** For further information about the automatic transmission, see (▷ page 121).
- i** If you depress the brake when starting the engine, pedal travel is unusually long and there is less pedal resistance.
- ▶ Make sure that the parking brake is applied.
- ▶ Turn the SmartKey to position **3** in the ignition lock (▷ page 117) and release it as soon as the engine is running.
- i** You can start the engine without preglow if the engine is warm.
- i** You can also use the touch-start function. To do this, turn the SmartKey to position **3** (▷ page 117) and release it immediately. The engine then starts automatically.

Pulling away

Automatic transmission

Warning

It is dangerous to shift AUTOTRONIC out of parking position **P** or neutral position **N** if the engine speed is higher than idle speed. If your foot is not firmly on the brake pedal, the vehicle could accelerate quickly forward or in reverse. You could lose control of the vehicle and hit someone or something. Only shift into gear when the engine is idling normally and when your right foot is firmly on the brake pedal.

- !** Only shift the automatic transmission to reverse gear **R** or park position **P** when the vehicle is stationary. Otherwise, the automatic transmission could be damaged.
- i** It is only possible to shift the automatic transmission from position **P** to a different position if you depress the brake pedal. Only then is the selector lever lock released.

- ▶ Depress the brake pedal and keep it depressed.
- ▶ Shift the automatic transmission to position **D** or **R**.
- i** Before driving off, wait until the gear change is fully completed.
- ▶ Release the parking brake (▷ page 135).
- ▶ Release the brake pedal.
- ▶ Carefully depress the accelerator pedal.

! Do not depress the accelerator pedal while depressing the brake pedal. This impairs engine performance and results in premature wear on the brake system and drivetrain.

! If a warning tone sounds and the **Release Park. Brake** message appears in the multifunction display, the parking brake is still applied. Release the parking brake.

i The vehicle locks centrally once you have pulled away. The locking knobs in the doors drop down.

You can open the doors from the inside at any time.

You can also deactivate the automatic locking feature (▷ page 165).

i Upshifts take place at higher engine speeds after a cold start. This helps the catalytic converter to reach its operating temperature more quickly.

Hill start assist

Hill start assist helps you when pulling away forwards or in reverse on an uphill gradient. It holds the vehicle for a short time after you have removed your foot from the brake pedal. This gives you enough time to move your foot from the brake pedal to the accelerator pedal and depress it before the vehicle begins to roll.

 **Warning**

Never leave the vehicle when it is held by hill start assist. After approximately one second, hill start assist will no longer brake your vehicle and it could roll away.

- ▶ Take your foot off the brake pedal.
- ▶ **i** Once you have taken your foot off the brake pedal, the vehicle is held for around one second.
- ▶ Pull away.

Hill start assist will not function if:

- you are pulling away on a level road or a downhill gradient.
- the transmission is in position **N**.
- the parking brake is applied.
- ESP[®] is malfunctioning.

Problems with the engine

Problem	Possible causes/consequences and ► Solutions
<p>The engine does not start. The starter motor can be heard.</p>	<ul style="list-style-type: none"> • There is a malfunction in the engine electronics. • There is a malfunction in the fuel supply. <p>► Turn the SmartKey back to position 0 in the ignition lock before attempting to start the engine again.</p> <p>► Try to start the engine again (▷ page 117). Avoid excessively long and frequent attempts to start the engine as these will drain the battery.</p> <p>If the engine does not start after several attempts:</p> <p>► Consult a qualified specialist workshop, e.g. an authorized Mercedes-Benz Center.</p>
<p>The engine does not start. The starter motor can be heard. The reserve fuel warning lamp is on. The needle of the fuel gauge is pointing to the reserve range and does not drop any further.</p>	<p>The fuel tank is empty.</p> <p>► Refuel the vehicle.</p>
<p>The engine does not start. You cannot hear the starter motor.</p>	<p>The on-board voltage is too low because the starter battery is too weak or discharged.</p> <p>► Jump-start the vehicle (▷ page 238).</p> <p>If the engine does not start despite attempts to jump-start it:</p> <p>► Consult a qualified specialist workshop, e.g. an authorized Mercedes-Benz Center.</p> <p>The starter motor was exposed to a thermal load that was too high.</p> <p>► Allow the starter motor to cool down for approximately two minutes.</p> <p>► Try to start the engine again.</p> <p>If the engine still does not start:</p> <p>► Consult a qualified specialist workshop, e.g. an authorized Mercedes-Benz Center.</p>

Problem	Possible causes/consequences and ► Solutions
<p>The engine is not running smoothly and is misfiring.</p>	<p>There is a malfunction in the engine electronics or a mechanical component of the engine management system.</p> <ul style="list-style-type: none"> ► Only depress the accelerator pedal slightly. ► Have the cause rectified immediately at a qualified specialist workshop, e.g. an authorized Mercedes-Benz Center. Otherwise, non-combusted fuel may get into the catalytic converter and damage it.
<p>The coolant temperature gauge shows a value above 248 °F(120 °C). Additionally, a display message may appear in the multifunction display and a warning tone may sound.</p>	<p>The coolant level is too low. The coolant is too hot and the engine is no longer being cooled sufficiently.</p> <ul style="list-style-type: none"> ► Stop as soon as possible and allow the engine and the coolant to cool down. ► Check the coolant level (► page 217). Observe the warning notes as you do so and add coolant if necessary.

Automatic transmission

Important safety notes

Warning

It is dangerous to shift AUTOTRONIC out of parking position **P** or neutral position **N** if the engine speed is higher than idle speed. If your foot is not firmly on the brake pedal, the vehicle could accelerate quickly forward or in reverse. You could lose control of the vehicle and hit someone or something. Only shift into gear when the engine is idling normally and when your right foot is firmly on the brake pedal.

Warning

On slippery road surfaces, never downshift in order to obtain braking action. This could result in drive wheel slip and reduced vehicle control. Your vehicle's ABS will not prevent this type of loss of control.

Warning!

Keep in mind that turning off the engine alone only will shift AUTOTRONIC into neutral position **N** automatically.

Always shift AUTOTRONIC into park position **P** before turning off the engine.

Otherwise the vehicle could roll away which could result in an accident and/or serious personal injury.

- i** Bear in mind that the power transmission between the engine and the transmission is interrupted when the engine is switched off. Therefore, to prevent the vehicle from rolling away, shift the automatic transmission to position **P** and apply the parking brake when the engine is switched off and the vehicle is stationary.

Selector lever

Overview of transmission positions

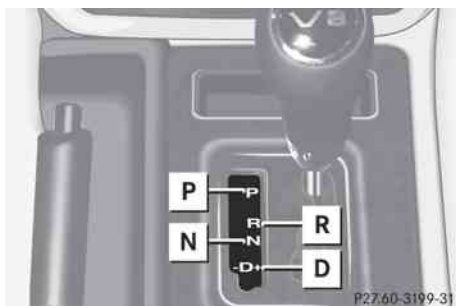

Selector lever

P Park position with selector lever lock

R Reverse gear

N Neutral

D Drive

Transmission position display



① Transmission position/shift range

② Transfer case position

Current shift range ① and current transfer case position ② are shown in the instrument cluster display.

! If the transmission position display in the multifunction display is not working, you should pull away carefully to check whether the desired transmission position is engaged. Select transmission position **D**. Do not restrict the shift range.

Displays on the cover beside the selector lever also indicate the current position of the selector lever.

The displays light up when the SmartKey is inserted into the ignition lock. The displays go out when the SmartKey is removed from the ignition lock.

When the selector lever is in position **D**, you can influence the gearshifts made by the automatic transmission by:

- restricting the shift range
- changing gear yourself

Transmission positions

P

Park position

Do not shift the transmission into position **P** (▷ page 134) unless the vehicle is stationary. The parking lock should not be used as a brake when parking. In addition to engaging the parking lock, you must always apply the parking brake to secure the vehicle.

i The SmartKey can only be removed if the transmission is in position **P**. When there is no SmartKey in the ignition lock, the selector lever is locked in position **P**.

If the vehicle electronics are malfunctioning, the selector lever may be locked in position **P**. To release a locked selector lever, see "Manual override of parking lock" (▷ page 126).

Have the vehicle electronics checked immediately at a qualified specialist workshop, e.g. an authorized Mercedes-Benz Center.

R

Reverse gear

Only shift the transmission to **R** when the vehicle is stationary.

N**Neutral**

No power is transmitted from the engine to the drive wheels.

Releasing the brakes will allow you to move the vehicle freely, e.g. to push it or tow it.

Do not shift the transmission to **N** while driving. Otherwise, the automatic transmission could be damaged.

If ESP® is deactivated or faulty: only shift the transmission to position **N** if the vehicle is in danger of skidding, e.g. on icy roads.

If you want to engage the transfer case, shift briefly into **N** (▷ page 126).

! Rolling in neutral **N** can damage the drive train.

D**Drive**

The automatic transmission changes gear automatically. All forward gears are available.

Changing gears

The automatic transmission shifts to the individual gears automatically when it is in transmission position **D**. This automatic gearshifting behavior is determined by:

- a shift range restriction, if selected
- the position of the transfer case (**HIGH** or **LOW**)
- the position of the accelerator pedal
- the road speed

Driving tips**Accelerator pedal position**

Your style of driving influences how the automatic transmission shifts gear:

- little throttle: early upshifts
- more throttle: late upshifts

Kickdown

Use kickdown for maximum acceleration.

- ▶ Depress the accelerator pedal beyond the pressure point.
The transmission shifts to a lower gear depending on the engine speed.
- ▶ Ease off the accelerator pedal once the desired speed is reached.
The automatic transmission shifts back up.

Working on the vehicle**⚠ Warning**

When working on the vehicle, engage the parking brake and shift AUTOTRONIC into park position **P**. Otherwise the vehicle could roll away which could result in an accident and/or serious personal injury.

Shift ranges**Introduction**

When the automatic transmission is in position **D**, it is possible to restrict or derestrict the shift range (▷ page 123).



- ① Shift range selected
- ② Current transfer case position

Selected shift range ① and current transfer case position ② are shown in the cluster multifunction display. The automatic transmission shifts only as far as the selected gear.

! When the transfer case is in the off-road driving position **LOW** range, the automatic transmission does not shift up, even when the engine has reached the overrevving limit. There is then a risk of engine damage. Make sure that you do not exceed the maximum permissible engine speed.

Driving situations

- | | |
|----------|---|
| 3 | You can use the engine's braking effect. |
| 2 | To use the braking effect of the engine on downhill gradients and for driving: <ul style="list-style-type: none"> • on steep mountain roads • in mountainous terrain • in arduous conditions |
| 1 | To use the braking effect of the engine on extremely steep downhill gradients and on long downhill stretches |

Restricting the shift range

- ▶ Press the selector lever to the left towards **D-**.

The automatic transmission shifts down to the next gear, depending on the gear currently selected. This also restricts the shift range.

- ① If the engine exceeds the maximum engine speed when shifting down, the automatic transmission protects against engine damage by not shifting down.
- ① If the maximum engine speed for the shift range is reached and you continue to accelerate, the automatic transmission shifts up in order to prevent the engine from overrevving, even if the shift range is restricted.

Derestricting the shift range

- ▶ Briefly press the selector lever to the right towards **D+**.

The automatic transmission shifts up to the next gear, depending on the shift range selected. This also derestricts the shift range.

Clearing the shift range restriction

- ▶ Press and hold the selector lever towards **D+** until **D** is shown once more in the multifunction display.
The automatic transmission shifts from the current shift range directly to **D**.

Selecting the ideal shift range

- ▶ Press the selector lever to the left towards **D-** and hold it in position.
The automatic transmission shifts to the gear which allows optimum acceleration and deceleration. To do this, the automatic transmission shifts down one or more gears.
- ① The automatic transmission cannot shift down beyond second gear. To shift into first

gear, the selector lever must be moved towards **D-** again.

Problems with the automatic transmission

Problem	Possible causes/consequences and ► Solutions
The acceleration ability is deteriorating. The transmission no longer changes gear.	The transmission is in emergency mode. It is only possible to shift into second gear and reverse gear. <ul style="list-style-type: none"> ► Stop the vehicle. ► Shift the transmission to position P. ► Turn the SmartKey to position 0 in the ignition lock. ► Wait at least 10 seconds before restarting the engine. ► Shift the transmission to position D or R. If D is selected, the transmission shifts into second gear; if R is selected, the transmission shifts into reverse gear. ► Have the transmission checked at a qualified specialist workshop, e.g. an authorized Mercedes-Benz Service Center, immediately.
You hear a warning tone.	You have: <ul style="list-style-type: none"> • switched off the engine • opened the driver's door • not moved the selector lever to position P <ul style="list-style-type: none"> ► Move the selector lever to P.

Releasing the parking lock manually

In the event of a malfunction, it is possible to release the selector lever lock manually to move it out of position **P**, e.g. if you wish to have the vehicle towed.



- Apply the parking brake.
- Insert a suitable implement ① into the opening protected by the flap.

- Press implement ① downwards and simultaneously move the selector lever out of position **P**.
- Remove implement ①.
The selector lever can now be moved freely until it is returned to position **P**.

① The protective flap only closes completely if you briefly press to selector lever towards **D**-.

Transfer case

General notes

The vehicle has permanent all-wheel drive. The front and rear axles are being constantly driven.

For further information on driving off-road, see (► page 142).

Shift ranges

H	HIGH Position for all normal on-road driving conditions.
L	LOW Low-range position for driving off-road. Also for use on steep uphill or downhill gradients, especially when towing a trailer. ! When the transfer case is in the off-road driving position LOW range, the automatic transmission does not shift up, even when the engine has reached the overrevving limit. There is then a risk of engine damage. Make sure that you do not exceed the maximum permissible engine speed. The vehicle travels around half the speed of on-road driving range HIGH . The drive power is correspondingly higher.
N	Neutral Neutral position. No power is transmitted to the drive wheels.

transfer of power between the engine and the drive axle.

The vehicle is then freely movable, even if a gear has been selected, and could unintentionally be set into motion – particularly on up – or downhill grades. This could lead to an accident and cause injury to yourself and others.

Please observe related messages appearing in the multifunction display.



① Current shift range

② Current transfer case position

Current shift range ① and transfer case position ② are shown in the instrument cluster multifunction display.

The switch for the transfer case is on the lower section of the center console.



Transfer case switch

From HIGH to LOW

! Only carry out the gear selection if:

- the engine is running.
- the vehicle is rolling.

Shifting the transfer case

General notes

Warning!

Always wait until the procedure of shifting from HIGH to LOW – and from LOW to HIGH – has been entirely completed. During this procedure do not turn off the engine or shift the automatic transmission into another gear.

If you do not wait until the shifting procedure has been entirely completed then it might not be correctly performed. The transfer case might be in neutral, thus interrupting the

- the automatic transmission is in selector lever position **N**.
- you are driving no faster than 25 mph (40 km/h).

You could otherwise damage the transfer case.

- ▶ Push the transfer case switch to **LOW**. When the shift procedure is complete, the **L** transfer case position appears in the multifunction display.
- ▶ Shift the transmission to position **D**.

From LOW to HIGH

! Only carry out the gear selection if:

- the engine is running.
- the vehicle is rolling.
- the automatic transmission is in selector lever position **N**.
- you are driving no faster than 43 mph (70 km/h).

You could otherwise damage the transfer case.

- ▶ Push the transfer case switch to **HIGH**. When the shift procedure is complete, the **H** transfer case position appears in the multifunction display.

If the gear change is not completed, the following messages could appear in the display:

• TC Shift Conditions Not Fulfilled

You have not met one or more shift conditions.

• TC In Neutral

The transfer case has canceled the gear change process and is in **N**. The **N** transfer case position appears in the multifunction display.

! Warning!

If the transfer case is in **Neutral**, the park position **P** of the automatic transmission will

not hold the vehicle. The parking brake must be engaged to hold the vehicle in place.

• TC Shift Procedure Canceled

The transfer case has not performed the gear change process.

- ▶ Carry out the gear change process again. Make sure to meet all conditions for changing gears.

• Transfer Case Service Required

There is a malfunction in the transfer case.

- ▶ Do not shift the transfer case.
- ▶ Have the vehicle checked at a qualified specialist workshop as soon as possible, e.g. at an authorized Mercedes-Benz Center.

Shifting to neutral

! Warning!

If the transfer case is in **Neutral**, the park position **P** of the automatic transmission will not hold the vehicle. The parking brake must be engaged to hold the vehicle in place.

- ▶ Turn the SmartKey to position **2** in the ignition lock.
- ▶ Apply the parking brake.
- ▶ Depress the brake pedal.
- ▶ Move the selector lever to position **N** (▷ page 122).
- ▶ Push the transfer case switch to **LOW** for about 30 seconds. When the shift procedure is complete, the **N** transfer case position appears in the multifunction display.

- i** If the transfer case is in **N**, the SmartKey is in the ignition lock and you open the driver's door, the **TC In Neutral** message appears in the multifunction display. If you then release the parking brake, a warning tone will sound.

Differential locks

General notes

Differential locks improve the traction of the vehicle.

Warning!

Never drive on firm road surfaces with differential locks engaged. Never drive on narrow bends with front-axle differential locks engaged. With differential locks engaged, the vehicle's ability to steer is severely restricted and the danger of accidents is therefore higher.

Do not engage or disengage differential locks while driving on a bend. The vehicle may otherwise make a jerking movement. You could thus lose control of the vehicle and cause an accident.

If you select a differential lock, ABS, 4ETS, ESP® and BAS will be deactivated.

Your vehicle is equipped with a differential lock for:

- the transfer case: this controls the balance between the front and rear axles.
- the rear axle: this controls the balance between the wheels on the rear axle.
- the front axle: this controls the balance between the wheels on the front axle.

! In order to avoid damage to the transfer case, you must operate the vehicle on a dynamometer (1-axle dynamometer) only if:

- the axle not driven on is jacked up or
- the corresponding propeller shaft is disconnected and
- the differential lock of the transfer case is engaged.

Otherwise, the transfer case could be damaged.

Information about differentials and differential locks

When the vehicle is driving through a bend, the wheels on the outside of the bend must travel a longer distance and must thus turn more quickly than the wheels on the inside. The differential, a transmission in the drivetrain, balances out the different rotational speeds and therefore enables driving through bends.

The disadvantage of differentials: the wheels with the least road grip are driven the hardest. Example: a wheel on a driven axle stands on snow-covered ground and thus has no traction. This wheel receives the strongest driving power from the differential, as the force progression takes the path of least resistance. The opposite wheel on this axle, however, which stands on firm ground and could therefore allow traction, receives no driving power. 4ETS eliminates this disadvantage and provides good steerability by automatically braking the spinning wheel, thus directing more driving power to the wheel standing on firm ground, which is therefore able to provide traction.

ESP® and 4ETS are traction systems that are ideal for road driving and suitable for light off-road driving. Off-road gear **LOW** likewise improves off-road capabilities.

Moreover, the more difficult conditions in off-road driving require further measures such as locking one or several differentials. Your vehicle is equipped with three differential locks: a central differential lock for the transfer case, a differential lock for the front axle, and a differential lock for the rear axle. Each differential lock can be engaged with the respective switch on the center console. When the central differential lock for the transfer case is locked, the speed of the front wheels is equal to that of the rear wheels. When the differential for the rear axle is locked, both rear wheels turn equally fast, independent of their respective torques. Keep in mind that by engaging the differential

locks, vehicle steerability is severely restricted.

For your own safety, the safety of others, and in order to avoid damage to the vehicle, the differential locks must not be engaged when driving on a firm road surface. Keep in mind that when driving on firm road surfaces, the unimpeded function of the differential is necessary and must never be locked on firm road surfaces. Vehicle steerability may otherwise be lost and you may no longer be able to steer the vehicle. For this reason, the differential locks must be engaged exclusively during off-road driving, and only when activating the other driving systems (4ETS, ESP® and off-road gear **LOW**) is no longer sufficient.

Activating the differential lock

General notes

Warning!

Never drive on firm road surfaces with differential locks engaged. Never drive on narrow bends with front-axle differential locks engaged. With differential locks engaged, the vehicle's ability to steer is severely restricted and the danger of accidents is therefore higher.

Do not engage or disengage differential locks while driving on a bend. The vehicle may otherwise make a jerking movement. You could thus lose control of the vehicle and cause an accident.

If you select a differential lock, ABS, 4ETS, ESP® and BAS will be deactivated.

Activate the differential locks:

- off-road
- to deactivate ABS, 4ETS, ESP® and BAS while off-road
- when fording
- on snow-covered, icy or dirty road surfaces

For further information on driving off-road, see (▷ page 142).

The switches are located on the center console.

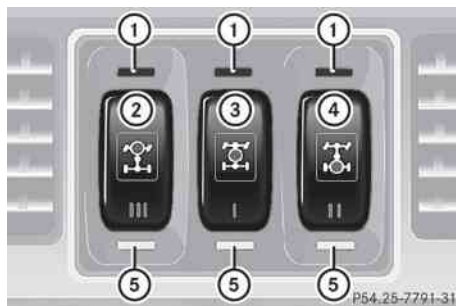

①	Function indicator lamps (red)
②	Differential lock for the front axle
③	Differential lock for the transfer case
④	Differential lock for the rear axle
⑤	Activation indicator lamps (yellow)

! Only activate the differential locks when:

- you are driving at walking pace.
- the driven wheels are not spinning.
- you are not driving on a firm road surface.

i You can only engage the differential locks when the transfer case is in off-road gear **LOW** (▷ page 126).

i You can activate the differential locks in the following order ③, ④, ②.

Differential lock for the transfer case

► **To engage:** switch the transfer case to off-road gear **LOW** (▷ page 126).

► Press switch ③.

The yellow activation indicator lamp under switch ③ lights up when the transfer case is in off-road gear **LOW**.

The  warning lamp in the instrument panel lights up.

The red function indicator lamp above switch ③ lights up when the differential is locked.

In the multifunction display you see the:

ABS not available Differential Locked message.

The    warning lamps light up in the instrument cluster.

The differential lock for the transfer case is engaged.

4ETS, ESP®, BAS and ABS are deactivated.

The vehicle's ability to steer is severely restricted. Drive carefully and accelerate gently for optimum traction.

- ① You can now engage differential lock for the rear axle ④ and differential lock for the front axle ② as desired.

Differential lock for the rear axle

- **To engage:** press switch ④.

First, the yellow activation indicator lamp lights up, followed by the red function indicator lamp.

The differential lock for the rear axle is engaged.

Differential lock for the front axle

- **To engage:** press switch ②.

First, the yellow activation indicator lamp lights up, followed by the red function indicator lamp.



The differential lock for the front axle is engaged.

Deactivating the differential lock

You can deactivate the differential locks in the reverse order: ②, ④, ③.

- **To simultaneously deactivate all differential locks:** press switch ③. Yellow activation indicator lamps ⑤ go out. Red function indicator lamps ① go out once the differential locks have disengaged. After approximately three seconds of normal driving, ABS, 4ETS, ESP® and BAS are activated.

The **ABS not available Differential Locked** message disappears from the

multifunction display and the ,  and  warning lamps in the instrument cluster go out.

- Switch the transfer case to road gear **HIGH** (► page 126).

- ① If red function indicator lamps ① do not go out when you disengage the differential locks, bring the vehicle to a stop in accordance with the traffic conditions, then begin driving again. The load change can disengage the differential locks.

⚠ Warning!

Always remember to disengage the differential locks when returning to drive on paved roads, see “A few words about differentials and differential locks”.

Refueling

Important safety notes

⚠ Warning

Gasoline is highly flammable and poisonous. It burns violently and can cause serious personal injury.

Never allow sparks, flames or smoking materials near gasoline.

Turn off the engine before refueling.

Whenever you are around gasoline, avoid inhaling fumes and any skin or clothing contact.

Direct skin contact with fuels and the inhalation of fuel vapors are damaging to your health.

⚠ Warning

Overfilling of the fuel tank may create pressure in the system which could cause a gas discharge. This could cause the gasoline to spray back out when removing the fuel pump nozzle, which could cause personal injury.

! Do not use diesel to refuel vehicles with a gasoline engine. Even small amounts of the wrong fuel result in damage to the fuel system and engine.

! Do not switch on the ignition if you accidentally refuel with the wrong fuel. Otherwise, the fuel will enter the fuel lines. Notify a qualified specialist workshop and have the fuel tank and fuel lines drained completely.

Gasoline

Fuel grade

! You should only refuel with unleaded premium-grade gasoline as this avoids damaging the catalytic converter.

If engine running problems are apparent, have the cause checked immediately and repaired. Excess unburned fuel can otherwise enter the catalytic converter, leading to overheating and possibly causing a fire.

i Only refuel with unleaded premium-grade gasoline with a specified minimum octane number of 91 (average value of 96 RON/ 86 MON).

Usually, you will find information about the fuel grade on the pump. If you cannot find the label on the gasoline pump, ask the gas station staff.

You can find further information under "Fuel" (▷ page 277), by consulting an authorized Mercedes-Benz Center or visiting <http://www.mbusa.com> (USA only).

! Use a filter when refueling from a fuel can. Otherwise, the fuel lines and/or injection system could be blocked by particles from the fuel can.

Refueling

Fuel filler flap

When you open or close the vehicle with the key, the fuel filler flap is automatically unlocked or locked.

The position of the fuel filler cap is displayed in the instrument cluster . The arrow next to the filling pump indicates the side of the vehicle. The fuel filler flap is located to the rear on the right.

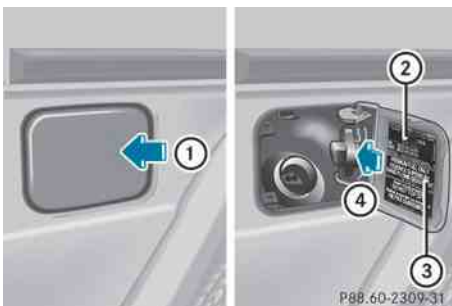



Fuel filler cap G 550 (example)

- ① To open the fuel filler flap
- ② Tire pressure table
- ③ Fuel type
- ④ To insert the fuel filler cap

Opening

► Switch off the engine.

i When the engine is running and the fuel filler flap is open, the yellow reserve fuel warning lamp and the  (USA only) or  (Canada only) engine diagnostics warning lamp may light up.

For further information on warning and indicator lamps in the instrument cluster, see (▷ page 188).

- Remove the key from the ignition lock.
- Press the fuel filler flap in the direction of arrow ①.
 - The fuel filler flap opens slightly.
- Open the fuel filler flap.

- ▶ Turn the fuel filler cap counter-clockwise and remove it.
- ▶ Insert the fuel filler cap into the holder bracket on the inside of filler flap ④.
- ▶ Completely insert the fuel pump nozzle into the filler neck and refuel.
- ▶ Only fill the tank until the pump nozzle switches off.

! Overfilling the fuel tank could damage the fuel system.

Closing

- ▶ Replace the fuel filler cap and turn it clockwise. The fuel filler cap audibly engages.
 - ▶ Close the fuel filler flap.
- i** Close the fuel filler flap before locking the vehicle. A locking pin otherwise prevents the fuel filler flap from closing after the vehicle has been locked.

Fuel filler flap emergency release

Warning!

Avoid contact with the vehicle walls as they may contain sharp edges. Otherwise, you could injure yourself while releasing the fuel filler flap.

The emergency release is located in the cargo compartment, on the right-hand side when viewed in the direction of travel, behind the rear panel trim.

- ▶ Open the rear door.



- ▶ Disconnect edge guard ① on the door pillar.
- ▶ Remove rear panel trim ②.



- ▶ Pull emergency release ③ in the direction of the arrow. The fuel filler flap is unlocked.
- ▶ Open the fuel filler flap.

Problems with the fuel and fuel tank	
Problem	Possible causes/consequences and ► Solutions
Fuel is leaking from the vehicle.	<p> Risk of explosion or fire</p> <p>The fuel line or the fuel tank is defective.</p> <ul style="list-style-type: none"> ► Turn the key to position 0 (▷ page 117) in the ignition lock immediately and remove it. ► Do not restart the engine under any circumstances. ► Consult a qualified specialist workshop.
The fuel filler flap cannot be opened.	<p>The fuel filler flap is not unlocked. or The key batteries are discharged.</p> <ul style="list-style-type: none"> ► Unlock the vehicle (▷ page 62). <p>or</p> <ul style="list-style-type: none"> ► Unlock the vehicle using the mechanical key (▷ page 63). ► Open the rear door. ► Manually unlock the fuel filler flap using the emergency release (▷ page 133). <p>The fuel filler flap is unlocked, but the opening mechanism is jammed.</p> <ul style="list-style-type: none"> ► Manually unlock the fuel filler flap using the emergency release (▷ page 133). ► Consult a qualified specialist workshop.

Parking

Important safety notes

Warning

Do not park this vehicle in areas where combustible materials can come into contact with the hot exhaust system. Do not park the vehicle on dry grassland or harvested grain fields. Combustible materials, such as grass, hay or leaves could be ignited by the hot exhaust system and cause a vehicle fire.

Unintended vehicle movement can cause serious personal injury or damage to the vehicle or the vehicle drivetrain. To reduce such risks, always do the following before turning off the engine and leaving the vehicle:

- keep your right foot on the brake pedal.
- engage the parking brake.
- shift the automatic transmission into park position **P**.
- slowly release the brake pedal.
- when parked on an incline, always turn the front wheels towards the road curb.

- turn the SmartKey in the ignition lock to position **0** and remove the SmartKey from the ignition lock.
- take the SmartKey with you and lock the vehicle when leaving.

Switching off the engine

Warning

Do not turn off the engine before the vehicle has come to a complete stop. With the engine not running, there is no power assistance for the brake and steering systems. In this case, it is important to keep in mind that a considerably higher degree of effort is necessary to brake and steer the vehicle.

Warning!

Keep in mind that turning off the engine alone only will shift AUTOTRONIC into neutral position **N** automatically.

Always shift AUTOTRONIC into park position **P** before turning off the engine.

Otherwise the vehicle could roll away which could result in an accident and/or serious personal injury.

- ▶ Shift the transmission to position **P**.
 - ▶ Turn the SmartKey to position **0** in the ignition lock and remove it. The immobilizer is activated.
 - ▶ Apply the parking brake firmly.
- i** The SmartKey can only be removed if the automatic transmission is in position **P**.

Parking brake



Warning

Engaging the parking brake while the vehicle is in motion can cause the rear wheels to lock up. You could lose control of the vehicle and cause an accident. In addition, the vehicle's brake lights do not light up when the parking brake is engaged.

Warning!

When leaving the vehicle, always remove the SmartKey from the starter switch, take it with you, and lock the vehicle. Do not leave children unattended in the vehicle, or with access to an unlocked vehicle. Children could release the parking brake and/or shift the automatic transmission out of park position **P**, either of which could result in an accident and/or serious personal injury.



- ▶ **To apply:** pull parking brake ② up firmly. When the engine is running, the **BRAKE** (USA only) or  (Canada only) indicator lamp lights up in the instrument cluster.
- ▶ **To release:** depress the brake pedal and keep it depressed. The selector lever lock is released.
- ▶ Pull parking brake ② up firmly.
- ▶ Press release button ① on parking brake ② and move the parking brake down to the stop. When the ignition is switched on or the engine is running, the **BRAKE** (USA only) or  (Canada only) indicator lamp goes out in the instrument cluster.

Parking up the vehicle

If you leave the vehicle parked up for longer than four weeks, the battery may be damaged by exhaustive discharge.

▶ Connect a trickle charger.

i You can obtain information about trickle chargers from a qualified specialist workshop, e.g. an authorized Mercedes-Benz Center.

If you leave the vehicle parked up for longer than six weeks, the vehicle may suffer damage as a result of lack of use.

▶ Visit a qualified specialist workshop and seek advice.

Driving tips

General driving tips

Important safety notes

Warning!

Please do not forget that your primary responsibility is to drive the vehicle. A driver's attention to the road must always be his/her primary focus when driving. For your safety and the safety of others, we recommend that you pull over to a safe location and stop before placing or taking a telephone call.

If you choose to use the telephone¹¹ while driving, please use the hands-free device and only use the telephone when road, weather and traffic conditions permit. Some jurisdictions prohibit the driver from using a mobile telephone while driving a vehicle.

Only operate the COMAND¹¹ (Cockpit Management and Data System) if road, weather and traffic conditions permit.

Otherwise, you may not be able to observe traffic conditions and could endanger yourself and others.

Bear in mind that at a speed of just 30 mph (approximately 50 km/h), your vehicle is covering a distance of 44 feet (approximately 14 m) every second.

Drive sensibly – save fuel

Observe the following tips to save fuel:

- ▶ The tires should always be inflated to the recommended tire pressure.
- ▶ Remove unnecessary loads.
- ▶ Remove roof carriers when they are not needed.
- ▶ Warm up the engine at low engine speeds.
- ▶ Avoid frequent acceleration or braking.
- ▶ Have all maintenance work performed at the service intervals specified in the Service Booklet or indicated by the service interval indicator.

Fuel consumption also increases when driving in cold weather, in stop-and-go traffic and in mountainous terrain.

Drinking and driving

Warning

Drinking and driving and/or taking drugs and driving are very dangerous combinations. Even a small amount of alcohol or drugs can affect your reflexes, perceptions and judgment.

The possibility of a serious or even fatal accident are greatly increased when you drink or take drugs and drive.

Do not drink or take drugs and drive or allow anyone to drive who has been drinking or taking drugs.

Pedals

Warning

Make sure absolutely no objects are obstructing the pedals' range of movement. Keep the driver's footwell clear of all obstacles. If there are any floor mats or carpets in the footwell, make sure that the pedals still have sufficient clearance.

During sudden driving or braking maneuvers, the objects could get caught between the

¹¹ Observe all legal requirements.

pedals. You could then no longer brake or accelerate. This could lead to accidents and injury.

Rolling with the engine switched off

Warning!

There is no power assistance for the steering and the brake when the engine is not running.

Steering and braking requires significantly more effort and you could lose control of the vehicle and cause an accident as a result.

Do not turn off the engine while the vehicle is in motion.

Exhaust check

Warning

Inhalation of exhaust gas is hazardous to your health. All exhaust gas contains carbon monoxide (CO), and inhaling it can cause unconsciousness and possible death.

Do not run the engine in confined areas (such as a garage) which are not properly ventilated. If you think that exhaust gas fumes are entering the vehicle while driving, have the cause determined and corrected immediately. If you must drive under these conditions, drive only with at least one window fully open at all times.

Certain engine systems are designed to keep the level of poisonous components in exhaust fumes within legal limits.

These systems only work at peak efficiency when they are maintained exactly in accordance with the manufacturer's specifications. For this reason, all work on the engine must be carried out only by qualified and authorized Mercedes-Benz technicians.

The engine settings must not be changed in any circumstances. Furthermore, all specific service work must be carried out at regular intervals and in accordance with the Mercedes-Benz service requirements. Details can be found in the Service Booklet.

Brakes

Important safety notes

Warning!

On slippery road surfaces, never downshift in order to obtain braking action. This could result in drive wheel slip and reduced vehicle control. Your vehicle's ABS will not prevent this type of control loss.

Do not engage the transfer case in position **LOW** when driving on ice or packed snow. At speeds below 18 mph (30 km/h) vehicle steering is adversely affected by the Off-road ABS.

Downhill gradients

 On long and steep gradients, you must reduce the load on the brakes by shifting early to a lower gear. This allows you to take advantage of the engine braking effect and helps avoid overheating and excessive wear of the brakes.

When you take advantage of the engine braking effect, a drive wheel may not turn for some time, e.g. on a slippery road surface. This could cause damage to the drive train. This type of damage is not covered by the Mercedes-Benz warranty.

Heavy and light loads

Warning

Depressing the brake pedal constantly results in excessive and premature wear to the brake pads.

It may also cause the brakes to overheat, seriously impairing their effectiveness. It may then not be possible to stop the vehicle in sufficient time to avoid an accident.

If the brakes have been subjected to a heavy load, do not stop the vehicle immediately, but drive on for a short while. This allows the airflow to cool the brakes more quickly.

Wet road surface

Warning

After driving in heavy rain for some time without applying the brakes or through water deep enough to wet brake components, the first braking action may be somewhat reduced. You have to depress the brake pedal more firmly. Maintain a safe distance from vehicles in front.

After driving on a wet road or having the vehicle washed, brake firmly while paying attention to the traffic conditions. This will warm up the brake discs, thereby drying them more quickly and protecting them against corrosion.

Warning

Make sure that you do not endanger other road users when you apply the brakes.

Limited braking performance on salt treated roads

Warning

The layer of salt on the brake discs and the brake pads/linings may cause a delay in the braking effect, resulting in a significantly longer braking distance, which could lead to an accident.

To avoid this danger, you should:

- occasionally brake carefully, without putting other road users at risk, when you are driving on salted roads. This helps to remove any salt that may have started to build up on the brake discs and the brake pads/linings.
- maintain a greater distance to the vehicle ahead and drive with particular care.
- carefully apply the brakes at the end of a trip and immediately after commencing a new trip, so that salt residues are removed from the brake discs.

Brake maintenance

 If the brake warning lamp lights up in the instrument cluster and you hear a warning tone, even though the parking brake has been released, the brake fluid level may be too low. Observe additional warning messages in the multifunction display.

The brake fluid level may be too low due to brake pad wear or leaking brake lines.

Have the brake system checked immediately. This work should be carried out at an authorized Mercedes-Benz Center.

All checks and maintenance work on the brake system must be carried out at a qualified specialist workshop only. Consult an authorized Mercedes-Benz Center for this purpose.

Have the brake pads and the brake fluid replaced at a qualified specialist workshop, e.g. an authorized Mercedes-Benz Center.

Warning

If other than recommended brake pads are installed, or other than recommended brake fluid is used, the braking properties of the vehicle can be degraded to an extent that safe braking is substantially impaired. This could result in an accident.

 A function or performance test may only be carried out on a two-axle dynamometer. If you are planning to have the vehicle tested on such a dynamometer, contact an authorized Mercedes-Benz Center to obtain further information first. Otherwise, the drive train or the brake system may suffer damage.

 As the ESP® system operates automatically, the engine and the ignition must be switched off (the key must be in position **0** or **1** in the ignition lock) if the parking brake is tested on a brake dynamometer (for a maximum of ten seconds).

Braking applications triggered automatically by ESP® may otherwise seriously damage the brake system.

If your brake system is subject only to moderate loads, you should test the functionality of your brakes at regular intervals by pressing firmly on the brake pedal at high speeds. This improves the grip of the brake pads.

Warning

Make sure that you do not endanger other road users when you apply the brakes.

You can find a description of Brake Assist (BAS) on (▷ page 56).

High-performance brake system for AMG vehicles

The high-performance brake system is installed only on the G 55 AMG.

Warning

New vehicle brake pads and discs, and replacement brake pads and discs may take several hundred miles of driving until they provide optimum braking efficiency. Until that time, you may need to use increased brake pedal pressure while braking. Please be aware of this and adjust your driving and braking accordingly during this break-in period.

Excessive high-demand braking will cause correspondingly high brake wear. Please be attentive to the brake warning lamp in the instrument cluster and brake condition messages in the multifunction display.

Especially for high performance driving, it is important to maintain and have the brake system checked regularly.

The high-performance brake system is designed for heavy loads. This may lead to noise when braking. This will depend on:

- speed
- braking force
- environmental conditions, such as temperature and humidity

The wear of individual components of the brake system, such as the brake pads/linings or brake discs, depends on the individual driving style and operating conditions.

For this reason, it is impossible to state a mileage that will be valid under all circumstances. An aggressive driving style will lead to high wear. You can obtain further information about this from your authorized Mercedes-Benz Center.

Parking brake

Warning!

While performing this procedure please assure that the vehicle is stopped before applying the parking brake. Otherwise the rear wheels could lock up. You could lose control of the vehicle and cause an accident. In addition, the vehicle's brake lights do not light up when the parking brake is engaged. Make sure not to endanger any other road users when you engage the parking brake.

To maintain the braking effect of the parking brake between the service intervals, you can briefly apply the parking brake while driving.

- ▶ Drive about 20 mph (30 km/h) on a dry, even road.
- ▶ Pull the parking brake upwards with the release button depressed (▷ page 135), until the vehicle brakes noticeably.
- ▶ Hold the lever in this position for approximately ten seconds and then push it all the way down again.

 Do not drive faster than 25 mph (40 km/h). Otherwise, you could damage the brakes.

Driving on wet roads

Hydroplaning

If water has accumulated to a certain depth on the road surface, there is a danger of hydroplaning occurring, even if:

- you drive at low speeds.
- the tires have adequate tread depth.

For this reason, in the event of heavy rain or in conditions in which hydroplaning can occur you must drive in the following manner:

- reduce your speed
- avoid ruts
- brake carefully

Driving on flooded roads

! Do not drive through flooded areas. Check the depth of any water before driving through it. Drive slowly through standing water. Otherwise, water may enter the vehicle interior or the engine compartment. This can damage the electronic components in the engine or AUTOTRONIC. Water can also be drawn in by the engine's air suction nozzles and this can cause engine damage.

If you have to drive on stretches of road on which water has collected, please bear in mind that:

- the maximum permissible still water depth is 50 cm.
- you should drive no faster than at walking pace.

Off-road fording

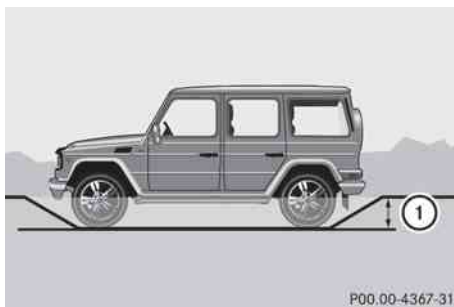

① Fording depth, 20 in (50 cm)

The fording depth must not exceed 20 in (50 cm) when the vehicle is loaded and ready to drive.

! The water depth must not exceed 20 in (50 cm). Note that the possible fording depth is less in flowing water.

i You may only drive through freshwater.

- Observe the safety notes (▷ page 142) and the general notes (▷ page 142) on off-road driving.
- Establish how deep the water is and the characteristics of the body of water before fording.
- Switch off the auxiliary heating and the air-conditioning system.
- Shift the transfer case to **LOW** (▷ page 126).
- Engage the differential locks, if necessary (▷ page 129).
- Restrict the shift range to **1** or **2** (▷ page 123).
- Avoid high engine speeds.
- Enter and exit the water at a flat place and at a steady walking pace.

! Under no circumstances should you accelerate before entering the water. The bow wave could cause water to enter and damage the engine and other assemblies.

- Drive slowly and at an even speed through the water.
- Do not stop and do not switch off the engine.

- !** Do not open any of the vehicle's doors while fording. Otherwise, water could get into the vehicle interior and damage the vehicle's electronics and interior equipment.
- Water offers a high degree of resistance, and the ground is slippery and in some cases unstable. Therefore, it is difficult and dangerous to pull away in the water.
 - Ensure that a bow wave does not form as you drive.
 - Clean any mud from the tire tread after fording.
 - Apply the brakes to dry them after fording.

Winter driving

General notes

Warning

If the vehicle becomes trapped in snow, ensure that snow is kept away from the exhaust pipe and from around the vehicle as long as the engine is running. Otherwise, poisonous carbon monoxide (CO) may enter the vehicle, resulting in loss of consciousness and even death.

To assure sufficient fresh air ventilation, open a window slightly on the side of the vehicle not facing the wind.

Have your vehicle winterproofed at a qualified specialist workshop, e.g. an authorized Mercedes-Benz Center, at the onset of winter.

Observe the notes in the "Winter operation" section (▷ page 248).

Driving with summer tires

Observe the notes in the "Winter operation" section (▷ page 248).

Slippery road surfaces

Warning!

The outside temperature indicator is not designed to serve as an ice-warning device and is therefore unsuitable for that purpose. Indicated temperatures just above the freezing point do not guarantee that the road surface is free of ice. The road may still be icy, especially in wooded areas or on bridges.

Warning!

On slippery road surfaces, never downshift in order to obtain braking action. This could result in drive wheel slip and reduced vehicle control. Your vehicle's ABS will not prevent this type of control loss.

Do not engage the transfer case in position **LOW** when driving on ice or packed snow. At speeds below 18 mph (30 km/h) vehicle steering is adversely affected by the Off-road ABS.

Drive particularly carefully on slippery road surfaces. Avoid sudden acceleration, steering and braking maneuvers. Do not use cruise control.

If the vehicle threatens to skid or cannot be stopped when moving at low speed:

- ▶ Shift the transmission to position **N**.
- ▶ Try to bring the vehicle under control using corrective steering.

i For more information on driving with snow chains, see (▷ page 248).

Warning

Make sure that you do not endanger other road users when you apply the brakes.

Off-road driving

Important safety notes

Warning!

Sand, dirt, mud and other material having friction property can cause exceptional wear and tear as well as brake failure.

Have the brakes checked for dirt build-up and cleaned. There is otherwise a risk that full braking power may not be available in an emergency.

Warning!

Do not load items on the basic carrier bars. It may cause instability during some maneuvers which could result in an accident.

Drive slowly in unknown terrain. This will make it easier to recognize unexpected obstacles and avoid damage to the vehicle.

To help avoid the vehicle rolling over, never turn it around on steep inclines. If the vehicle cannot complete the attempted climb, back it down in reverse gear.

Do not drive along the side of a slope. The vehicle might otherwise rollover. If in doing so the vehicle begins to show a tendency to roll, immediately steer into a line of gravity (straight up or downhill).

Never let the vehicle roll backwards in idle. You may lose control of the vehicle if you use only the service brake. For information on driving downhill, see "Driving downhill".

Warning!

Do not reduce the tire inflation pressure before driving through sand. However, if you do so, remember to correct the tire inflation pressure before continuing your trip. Driving with reduced tire inflation pressure increases the risk of losing control of the vehicle and rolling over.

General notes

Read this section carefully before driving your vehicle off-road. Practice by driving over more gentle off-road terrain first.

Familiarize yourself with the characteristics of your vehicle and the gear shift operation before driving through difficult terrain.

The following driving systems are specially adapted to off-road driving:

- 4ETS (▷ page 58)
- transfer case (▷ page 126)
- differential locks (▷ page 129)

Observe the following notes:

- stop your vehicle and, if necessary, shift the transfer case to **LOW** (▷ page 126) before driving off-road.
- engage the differential locks, if necessary (▷ page 129).

i ABS, 4ETS, ESP® and BAS are deactivated while the differential locks are engaged. This allows the front wheels to lock briefly, so that these can dig into a loose surface. However, please note that locked wheels skid and can no longer steer.

- Check that items of luggage and loads are stowed safely and are well secured (▷ page 196).
- Make sure there is always sufficient ground clearance to prevent damage to the vehicle.
- Always keep the engine running and in gear when driving on a downhill gradient.
- Always keep the engine running and in gear when driving on a slope.
- Drive slowly and evenly, if necessary at a walking pace.
- Ensure that the wheels are in contact with the ground at all times.
- Drive with extreme care on unknown off-road routes where visibility is poor. For safety reasons, get out of the vehicle first and survey the off-road route.

- Check the depth of water before fording rivers and streams.
 - When fording, do not stop and do not switch off the engine.
 - Look out for obstacles such as rocks, holes, tree stumps and furrows.
 - Always keep the doors, rear door, windows and the sliding sunroof closed while the vehicle is in motion.
 - Switch off cruise control.
 - Do not stray from marked routes or paths.
 - Adapt your speed to the terrain. The rougher, steeper or more ruts on the terrain, the slower your speed should be.
 - Drive slowly and at an even speed through the water. Ensure that a bow wave does not form as you drive.
 - On sand, drive quickly to overcome the rolling resistance. Otherwise, the vehicle could dig itself into the sand.
 - Do not jump with the vehicle as this will interrupt the vehicle's propulsion.
 - Avoid high engine speeds. Drive at reasonable engine speeds (maximum 3000 rpm).
 - Do not shift the automatic transmission to transmission position **N**.
 - Always check the vehicle for damage after off-road driving.
- i** Information about retrofitting special all-terrain tires is available from any authorized Mercedes-Benz Center.



Environmental note

Protection of the environment is of primary importance. Treat nature with respect. Observe all prohibiting signs.

Checklist before driving off-road

- ▶ **Engine oil level:** check the engine oil and top it up if necessary. Only then does the engine receive enough oil when the vehicle is standing on a steep incline.

! If the engine oil warning lamp lights up while the vehicle is in motion, stop the vehicle in a safe place as soon as possible. Check the engine oil level. The engine oil warning lamp warning must not be ignored. Continuing the journey while the symbol is displayed could lead to engine damage.

- ▶ **Wheel-changing tool kit:** check that the jack is working and make sure you have the wheelbrace, a robust tow cable and a folding spade in the vehicle.
- ▶ **Wheels and tires:** check the tire tread depth and tire pressure.
- ▶ Check for damage and remove any foreign objects, e.g. small stones, from the wheels/tires.
- ▶ Replace any missing valve caps.
- ▶ Replace dented or damaged wheels.
- ▶ Carry a sound spare wheel.

Checklist after driving off-road

Warning

If you feel a sudden significant vibration or ride disturbance, or you suspect that possible damage to your vehicle has occurred, you should turn on the hazard warning flashers, carefully slow down, and drive with caution to an area which is a safe distance from the road. Inspect the tires and the vehicle underbody for possible damage. If the vehicle appears unsafe, have the vehicle towed to the nearest authorized Mercedes-Benz Center or tire dealer for repairs.

Driving over rough terrain places greater demands on your vehicle than driving on normal roads. After driving off-road, check the vehicle. This allows you to detect damage promptly and reduce the risk of an accident to yourself and other road users.

- ▶ Shift the transfer case to **HIGH** (▷ page 126).
- ▶ Disengage the differential locks (▷ page 129).

- ▶ Clean the headlamps and rear lights and check for damage.
- ▶ Clean the front and rear license plates.
- ▶ Clean the wheels and tires with a water jet and remove any foreign objects.
- ▶ Clean the wheels, tires, wheel arches and the vehicle underside with a water jet; check for any foreign objects and damage.
- ▶ Check whether twigs or other parts of plants have become trapped. These increase the risk of fire and can damage fuel pipes, brake hoses or the rubber bellows of the axle joints and propeller shafts.
- ▶ After the trip, examine without fail the entire undercarriage, wheels, tires, brakes, bodywork structure, steering, chassis and exhaust system for damage.
- ▶ After driving for extended periods across sand, mud, gravel, water or in similarly dirty conditions, have the brake discs, wheels, brake pads/linings and axle joints checked and cleaned.
- ▶ If you detect strong vibrations after off-road driving, check for foreign objects in the wheels and drivetrain and remove any that you find. Foreign objects can disturb the balance and cause vibrations.
- ▶ Test the brakes.

Driving on sand

Warning!

Do not reduce the tire inflation pressure before driving through sand. However, if you do so, remember to correct the tire inflation pressure before continuing your trip. Driving with reduced tire inflation pressure increases the risk of losing control of the vehicle and rolling over.

Observe the following rules when driving on sand:

- shift the transfer case to **LOW** (▷ page 126).
- avoid high engine speeds.
- limit the shift range of the automatic transmission according to the off-road conditions.
- drive quickly to overcome the rolling resistance. Otherwise, the vehicle could dig itself into the sand.
- drive in the tracks of other vehicles if possible. Make sure that the ruts are not too deep, that the sand is firm enough and that your vehicle has sufficient ground clearance.

Tire ruts and gravel roads

Observe the following rules when driving along ruts in off-road terrain or on roads with loose gravel:

- ❗ Check that the ruts are not too deep and that your vehicle has sufficient clearance. Otherwise, your vehicle could be damaged or bottom out and get stuck.
- shift the transfer case to **LOW** (▷ page 126).
- avoid high engine speeds.
- observe the safety notes (▷ page 142) and the general notes (▷ page 142) on off-road driving.
- restrict the shift range of the automatic transmission to **1** (▷ page 123).
- drive slowly.
- where ruts are too deep, drive with the wheels of one side on the center grassy area, if possible.

Driving over obstacles



! Obstacles could damage the floor of the vehicle or components of the chassis. Ask passengers for guidance when driving over large obstacles. The passenger should always keep a safe distance from the vehicle when doing so in order to avoid injury as a result of unexpected vehicle movements. After driving off-road or over obstacles, check the vehicle for possible damage, especially to the underbody and the components of the chassis.

Observe the following rules when driving over tree stumps, large stones and other obstacles:

- observe the safety notes (▷ page 142) and the general notes (▷ page 142) on off-road driving.
- shift the transfer case to **LOW** (▷ page 126).
- avoid high engine speeds.
- select shift range 1 (▷ page 123).
- make sure that you have enough ground clearance before driving across an obstacle.
- drive very slowly.
- try to drive straight over the center of obstacles: front wheel first, then rear wheel.

! Drive with particular care when driving over an obstacle while driving up or down a steep slope.

The vehicle could otherwise tilt and slide sideways or tip over.

Driving in mountainous terrain

Approach/departure angle

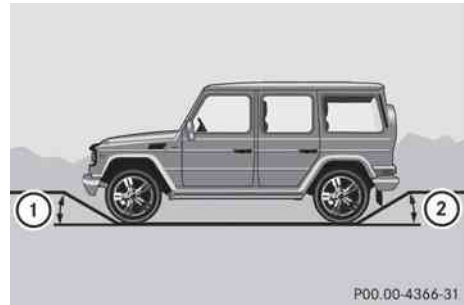

- ① Approach/departure angle, front
- ② Approach/departure angle, rear

	①	②
G 550	37°	31°
G 55 AMG	33°	28°

- Observe the safety notes (▷ page 142) and the general notes (▷ page 142) on off-road driving.
- Do not drive at an angle on slopes, inclines or gradients, but instead follow the direct line of fall. The maximum gradient-climbing capability of your vehicle is 80%, which corresponds to an approach/departure angle of 38°. Note that the vehicle's gradient-climbing capability depends on the off-road conditions.
- Before driving on extreme uphill and downhill gradients, shift the transfer case to **LOW** (▷ page 126).
- Engage the differential locks, if necessary (▷ page 129).
- Drive slowly.
- Accelerate gently and make sure that the wheels are gripping.
- Avoid high engine speeds, except when driving on sandy and muddy routes with high driving resistance.

- Avoid high engine speeds – drive at appropriate engine speeds (no more than 3000 rpm).
- Use the braking power of the engine when driving down a slope. Observe the engine speed, do not overrev the engine.
- ❗ Further information on the maximum engine speed can be found in the "Tachometer" and "Technical Data" sections.
- Select a shift range appropriate to the gradient.
- Before tackling steep downhill gradients, select shift range **1** (▷ page 123).
- Check the brakes after driving off-road for a long time.

Warning!

Never turn the vehicle around on steep inclines. The vehicle might roll over. If the vehicle cannot complete the attempted climb, back it down in reverse gear.

- ❗ Hill start assist will aid you when pulling away on a hill.
For more information, see "Hill start assist" (▷ page 118).

Maximum gradient-climbing capability

Do not drive at an angle on slopes, inclines or gradients, but instead follow the direct line of fall. The maximum gradient-climbing capability of your vehicle is 80%, which corresponds to an approach/departure angle of 38°. Note that the vehicle's gradient-climbing capability depends on the off-road conditions.

Accelerate carefully and make sure that the wheels do not spin when driving on steep terrain.

- ❗ If the load on the front axle is reduced when pulling away on a steep uphill slope, the front wheels have a tendency to spin. 4ETS detects this and brakes the wheels

accordingly. The rear wheel torque is increased, making it easier to drive off.

Brow of hill

When driving on an uphill gradient, reduce pressure slightly on the accelerator immediately before reaching the top of the hill (do not shift the transmission to position **N**). Use the vehicle's own impetus to drive over the top of the hill.

This style of driving prevents:

- the vehicle from lifting off the ground on the brow of a hill
- loss of traction
- the vehicle from traveling too quickly down the other side

Driving downhill

- Before tackling steep downhill gradients, select shift range **1** (▷ page 123).

This way you use the engine's braking effect to reduce the speed. If this is not sufficient, brake gently. When doing so, make sure that the vehicle is facing in the direction of the line of fall.

- Observe the notes on driving in mountainous terrain (▷ page 146).
- Drive slowly.
- Do not drive at an angle down steep inclines. Steer into the line of fall and drive with the front wheels aligned straight. Otherwise, the vehicle could slip sideways, tip and rollover.
- Check that the brakes are working normally after a long downhill stretch.

- ❗ The special off-road ABS (▷ page 56) enables accurate, brief and repeated locking of the front wheels, causing them to dig into the loose ground. Note that when the front wheels are fully braked, they slide easily over the surface of the ground, making it difficult to steer.

Driving systems

Cruise control

Important safety notes

Cruise control maintains a constant road speed for you. On long and steep downhill gradients, especially if the vehicle is laden, you must select shift range **1**, **2** or **3** in good time. By doing so, you will make use of the braking effect of the engine, which relieves the load on the brake system and prevents the brakes from overheating and wearing too quickly.

Use cruise control only if road and traffic conditions make it appropriate to maintain a steady speed for a prolonged period. You can store any road speed above 20 mph (30 km/h).

Warning

The cruise control is a convenience system designed to assist the driver during vehicle operation. The driver is and must always remain responsible for the vehicle's speed and for safe brake operation.

Only use the cruise control if the road, traffic, and weather conditions make it advisable to travel at a constant speed.

- The use of the cruise control can be dangerous on winding roads or in heavy traffic because conditions do not allow safe driving at a constant speed.
- The use of the cruise control can be dangerous on slippery roads. Rapid changes in tire traction can result in wheel spin and loss of control.
- Deactivate the cruise control when driving in fog.

The "Resume" function should only be operated if the driver is fully aware of the previously set speed and wishes to resume this particular preset speed.

Cruise control lever

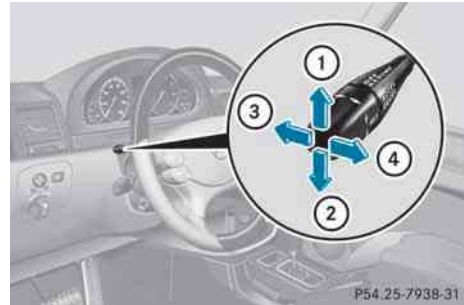





- ① To store the current speed or a higher speed
- ② To store the current speed or a lower speed
- ③ To deactivate cruise control
- ④ To call up the last speed stored

When you activate cruise control, the stored speed is shown in the multifunction display for five seconds.

If an DEF® display message is shown in the multifunction display, you will no longer be able to use the full range of cruise control functions.

The full range of cruise control functions will become available again once you confirm the DEF® display message:

- Briefly press the , ,  or  button on the multifunction steering wheel.

or

- Briefly press the reset button on the instrument cluster.

Storing and maintaining the current speed

You can store the current speed if you are driving faster than 20 mph (30 km/h).

- ▶ Accelerate the vehicle to the desired speed.
- ▶ Briefly press the cruise control lever up ① or down ②.
- ▶ Remove your foot from the accelerator pedal.
Cruise control is activated. The vehicle automatically maintains the stored speed.

i Cruise control may be unable to maintain the stored speed on uphill and downhill gradients. The stored speed is resumed when the gradient levels out.

Calling up the last speed stored

Warning

The set speed stored in memory should only be set again if prevailing road conditions and legal speed limits permit. Possible acceleration or deceleration differences arising from returning to the preset speed could cause an accident and/or serious injury to you and others.

- ▶ Briefly pull the cruise control lever towards you ④.
- ▶ Remove your foot from the accelerator pedal.
Cruise control is activated and adjusts the vehicle's speed to the last speed stored.

i G 350 CDI: if no speed is stored, cruise control stores the current speed and maintains it.

Setting a speed

Warning

Keep in mind that it may take a brief moment until the vehicle has made the necessary adjustments.

Increase or decrease the set vehicle speed to a value that the prevailing road conditions and legal speed limits permit. Otherwise, sudden and unexpected acceleration or deceleration

of the vehicle could cause an accident and/or serious injury to you and others.

- ▶ Press the cruise control lever up ① for a higher speed or down ② for a lower speed.
- ▶ Keep the cruise control lever pressed until the desired speed is reached.
- ▶ Release the cruise control lever.
The new speed is stored.

i Cruise control is not deactivated if you depress the accelerator pedal. For example, if you accelerate briefly to overtake, cruise control adjusts the vehicle's speed to the last speed stored after you have finished overtaking.

Setting in 1 mph (Canada: 1 km/h) increments

- ▶ Briefly press the cruise control lever up ① for a higher speed or down ② for a lower speed.
The last speed stored is increased or reduced.

Deactivating cruise control

There are several ways to deactivate cruise control:

- ▶ Briefly press the cruise control lever forwards ③.

or

- ▶ Brake.

Cruise control is automatically deactivated if:

- you apply the parking brake.
- you are driving below 20 mph (30 km/h).
- ESP® intervenes or you deactivate ESP®.
- you shift the transmission to position **N** while driving.
- G 350 CDI: you engage a differential lock.

i The last speed stored is cleared when you switch off the engine.

4MATIC (permanent all-wheel drive)

4MATIC ensures that all four wheels are permanently driven. Together with ESP® and 4ETS, it improves the traction of your vehicle whenever a drive wheel spins due to insufficient grip.

⚠ Warning!

If a drive wheel is spinning due to insufficient traction:

- While driving off, apply as little throttle as possible.
- While driving, ease up on the accelerator pedal.
- Adapt your speed and driving style to the prevailing road conditions.

Failure to observe these guidelines could cause the vehicle to skid.

The 4MATIC cannot prevent accidents resulting from excessive speed.

! Never tow the vehicle with one axle raised. This may damage the transfer case. Damage of this sort is not covered by the Mercedes-Benz Limited Warranty. All wheels must remain either on the ground or be fully raised. Observe the instructions for towing the vehicle with all wheels in full contact with the ground.

i In wintry driving conditions, the maximum effect of 4MATIC can only be achieved if you use winter tires (M+S tires), with snow chains if necessary.

! When testing the parking brake, operate the vehicle only briefly (for a maximum of ten seconds) on a brake test dynamometer. When doing this, turn the key to position **0** or **1** in the ignition. Failure to do this can cause damage to the drive train or the brake system.

! Function or performance tests may only be performed on a 2-axle dynamometer. If you wish to operate the vehicle on such a dynamometer, please consult an authorized Mercedes-Benz Center

beforehand. You could otherwise damage the drive train or the brake system.

For information about driving off-road, see (> page 142).

Ultrasonic reversing aid

Important safety notes

⚠ Warning!

Make sure no persons or animals are in or near the area in which you are parking/ maneuvering. Otherwise, they could be injured.

⚠ Warning

Rear Parking Assist is a supplemental system. It is not intended to, nor does it replace, the need for extreme care. The responsibility during parking and other critical maneuvers always remains with the driver.

The ultrasonic backing up aid is an electronic parking aid. It indicates visually and audibly the distance between the rear area of your vehicle and an object.

The ultrasonic backing up aid is activated automatically when you switch on the ignition and engage reverse gear.

The ultrasonic backing up aid monitors the rear area of your vehicle using four sensors in the rear bumper.

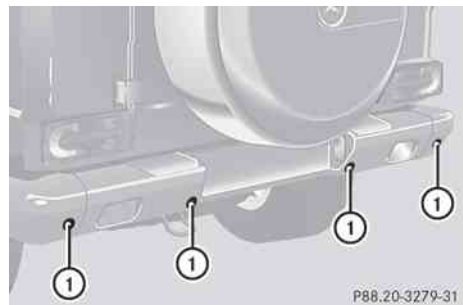

① Sensors in the rear bumper

Range of the sensors

The sensors must be free of dirt, ice and slush; otherwise they may not function correctly. Clean the sensors regularly, taking care not to scratch or damage them (▷ page 224).

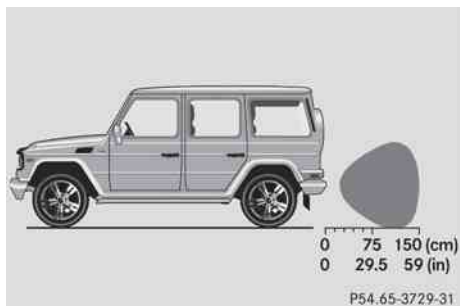

Side view

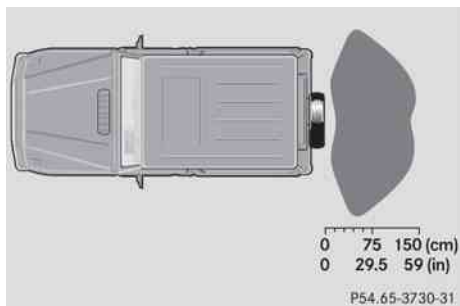

Top view

Sensors

Center	Approx. 59 in (approx. 150 cm)
Corners	Approx. 40 in (approx. 100 cm)

! When parking, pay particular attention to objects above or below the sensors, such as flower pots or trailer towbars. The ultrasonic backing up aid does not detect such objects when they are in the immediate vicinity of the vehicle. You could damage the vehicle or the objects.

Ultrasonic sources such as an automatic car wash, a lorry's compressed-air brakes

or a pneumatic drill could cause the ultrasonic backing up aid to malfunction.

Minimum distance

Center	Approx. 8 in (approx. 20 cm)
Corners	Approx. 8 in (approx. 20 cm)

If there is an obstacle within this range, all warning displays flash and a warning tone sounds. If the distance falls below the minimum, the distance may no longer be shown.

Warning displays

The warning display shows the distance between the sensors and the obstacle.

The warning display is in the rear compartment next to the rear door.



The warning display is divided into four yellow and two red segments ①. The ultrasonic backing up aid is ready for use when you hear a warning tone and segment ② lights up briefly.

One or more segments ① light up as the vehicle approaches an obstacle, depending on the distance from the obstacle.

From the:

- fourth segment you will hear an intermittent warning tone
- fifth segment you will hear a faster intermittent warning tone
- sixth segment you will hear a very fast intermittent warning tone. This indicates that you have now reached the minimum distance.

Problems with ultrasonic reversing aid

Problem	Possible causes/consequences and ► Solutions
You hear a warning signal when backing up.	<p>The ultrasonic backing up aid sensors are dirty or there is interference.</p> <ul style="list-style-type: none"> ► Clean the ultrasonic backing up aid sensors (▷ page 224). ► Switch the ignition back on.
	<p>The problem may be caused by an external source of radio or ultrasound waves. The ultrasonic backing up aid has switched off automatically.</p> <ul style="list-style-type: none"> ► See if the ultrasonic backing up aid functions in a different location.
You hear a warning tone when backing up or you do not hear a warning tone and none of the segments light up.	<p>The ultrasonic backing up aid is malfunctioning and has switched itself off.</p> <ul style="list-style-type: none"> ► Have the ultrasonic backing up aid checked at a qualified specialist workshop as soon as possible.

Rear view camera

Important safety notes

The rear view camera is an optical parking aid. It shows the area behind your vehicle in the COMAND display.

Warning!

Make sure no persons or animals are in or near the area in which you are parking/maneuvering. Otherwise, they could be injured.

The rear view camera is in the tailgate above the rear window wiper.

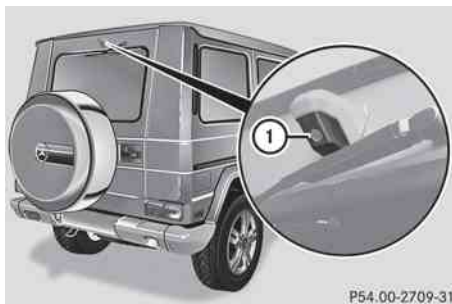

P54.00-2709-31

① Rear view camera

View through the camera

The area behind the vehicle is displayed as a mirror image, as in the rear-view mirror.

Warning!

The rear view camera is only an aid and may display obstacles

- from a distorted perspective
- inaccurately
- may not display obstacles at all

The rear view camera does not relieve you of the responsibility to be cautious. Take care and pay careful attention. The rear view camera may not show objects which are

- very close to the rear bumper
- under the rear bumper
- under the spare wheel
- nearby behind the spare wheel

You are responsible for safety at all times and must continue to pay attention to the immediate surroundings when parking and maneuvering. This includes the area behind, in front of, and beside the vehicle. Otherwise you could endanger yourself and/or others.

Warning!

The rear view camera either will not function or will not function to its full capability if

- the tailgate is open
- it is raining very hard, snowing or foggy
- it is night or you are parking/maneuvering your vehicle in an area where it is very dark
- the camera is exposed to a very bright white light
- the immediate surroundings are illuminated with fluorescent light (the display may flicker)
- there is a sudden change in temperature, e.g. if you drive into a heated garage from the cold (lens condensation)
- the camera lens is dirty or covered
- the rear of your vehicle is damaged

In this case, have the position and setting of the camera checked by a qualified specialist workshop. Mercedes-Benz recommends that you contact a Mercedes-Benz Center for this purpose.

Do not use the rear view camera in these situations. Otherwise you could injure yourself or others and/or damage property including your vehicle while parking/maneuvering.

Activating the rear view camera

- ▶ Make sure that the SmartKey is in position **2** in the ignition lock.
- ▶ Make sure that the "rear view camera" function is selected in COMAND (see the separate operating instructions for COMAND).
- ▶ Engage reverse gear.
The area behind the vehicle is shown in the COMAND display.

Vehicle equipment	156
Important safety notes	156
Displays and operation	156
Menus and submenus	159
Display messages	169
Warning and indicator lamps in the instrument cluster	183

Vehicle equipment

- i** This manual describes all the standard and optional equipment of your vehicle which was available at the time of purchase. Country-specific differences are possible. Please note that your vehicle may not be equipped with all features described. This also applies to safety-relevant systems and functions.

Important safety notes

You will find an illustration of the instrument cluster in the "At a glance" section (▷ page 26).

Warning

A driver's attention to the road and traffic conditions must always be his/her primary focus when driving.

For your safety and the safety of others, selecting features through the multifunction steering wheel should only be done by the driver when traffic and road conditions permit it to be done safely.

Bear in mind that at a speed of just 30 mph (approximately 50 km/h), your vehicle is covering a distance of 44 feet (approximately 14 m) every second.

Warning!

No messages will be displayed if either the instrument cluster or the multifunction display is inoperative.

As a result, you will not be able to see information about your driving conditions, such as

- speed
- outside temperature
- warning/indicator lamps
- malfunction/warning messages
- failure of any systems

Driving characteristics may be impaired.

If you must continue to drive, do so with added caution. Contact an authorized Mercedes-Benz Center as soon as possible.

Warning

Malfunction and warning messages are only indicated for certain systems and are intentionally not very detailed. The malfunction and warning messages are simply a reminder with respect to the operation of certain systems. They do not replace the owner's and/or driver's responsibility to maintain the vehicle's operating safety. Have all required maintenance and safety checks performed on the vehicle. Bring the vehicle to an authorized Mercedes-Benz Center to address the malfunction and warning messages.

Displays and operation

Tachometer

The red band in the tachometer indicates the engine's overrevving range.

! Do not drive in the overrevving range, as this could damage the engine.

The fuel supply is interrupted to protect the engine when the red band is reached.

Displaying the coolant temperature

Warning

Driving when your engine is overheated can cause some fluids which may have leaked into the engine compartment to catch fire. You could be seriously burned.

Steam from an overheated engine can cause serious burns which can occur just by opening the engine hood. Stay away from the engine if you see or hear steam coming from it.

Stop the vehicle in a safe location away from other traffic. Turn off the engine, get out of the vehicle and do not stand near the vehicle until the engine has cooled down.

The coolant temperature gauge is in the instrument cluster on the left-hand side. Under normal driving conditions, with the correct anti-corrosion and antifreeze additive concentration, the reading may rise to 248 °F(120 °C).

! If the coolant temperature exceeds 248 °F(120 °C) do not continue driving. The engine will otherwise be damaged.

Outside temperature display

The outside temperature display is in the multifunction display (▷ page 158).

Warning!

The outside temperature indicator is not designed to serve as an ice-warning device and is therefore unsuitable for that purpose. Indicated temperatures just above the freezing point do not guarantee that the road surface is free of ice. The road may still be icy, especially in wooded areas or on bridges.





Changes in the outside temperature are displayed after a short delay.

Operating the on-board computer

The on-board computer is activated as soon as you turn the SmartKey to position **1** in the ignition lock.

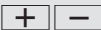
You can control the multifunction display and the settings in the on-board computer using the buttons on the multifunction steering wheel.



- | | |
|---|--|
| ① | Multifunction display |
| ② | 
Selects submenus in the Settings menu
Changes values
Adjusts the volume |
| ③ | 
Rejects or ends a call
Exits phone book/redial memory

Makes or accepts a call
Switches to the redial memory |
| ④ | 
Selects a menu: scrolls back and forth |

⑤ **Press briefly:**

Scrolls back and forth within a menu

In the **Audio** menu: selects a stored station, an audio track or a video scene

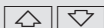
In the **Telephone** menu: switches to the phone book and selects a name or a telephone number

**Press and hold:**

In the **Audio** menu: selects the previous/next station or selects an audio track using rapid scrolling

In the **Telephone** menu: starts rapid scrolling through the phone book

Further information on displaying the transmission position (▷ page 122).

Multifunction display

To activate the multifunction display:

- switch on the ignition.
- switch on the lights.
- open the door.
- press the reset button on the instrument cluster.

The multifunction display shows you values and settings as well as possible messages.



- ① Display area for menus or submenus
- ② Status bar with outside temperature or speed (▷ page 163)
- ③ Transfer case position
- ④ Selector lever position/shift range

Menus and submenus

Overview of menus

The number of menus shown depends on the optional equipment in the vehicle.

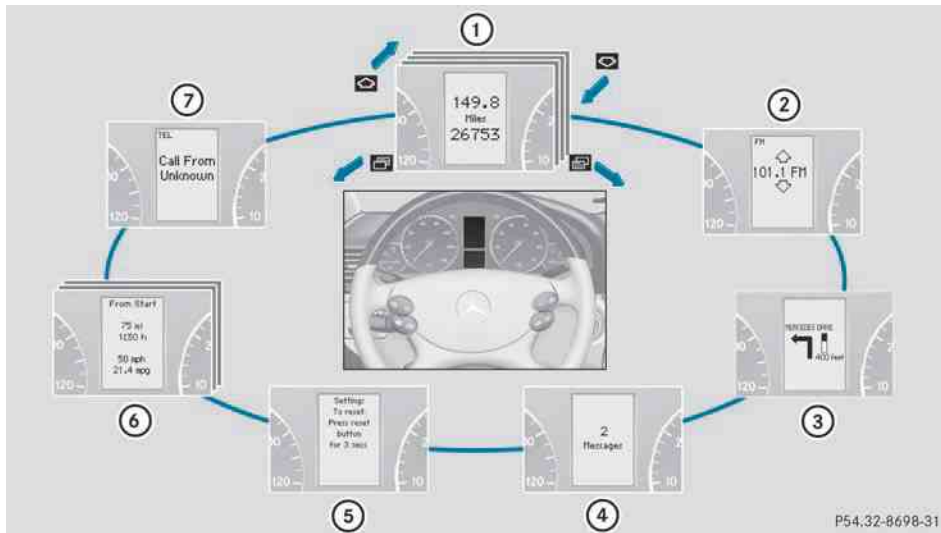



P54.32-8698-31

	Function
①	Standard display menu (▷ page 160) <ul style="list-style-type: none"> • tire pressure monitor (▷ page 253) • service interval display (▷ page 219) • G 55 AMG: oil level (▷ page 215)
②	Audio menu (▷ page 160)
③	Navigation menu (▷ page 162)
④	Message memory ¹² menu (▷ page 169)
⑤	Settings menu (▷ page 162)
⑥	Trip computer menu (▷ page 166)
⑦	Telephone menu (▷ page 167)

¹² The menu is only visible when there is a display message.

Standard display menu



Standard display

- ▶ Press the  or  button on the steering wheel to select the standard display.



Standard display

- ① Trip odometer
- ② Odometer

You can select the following functions in the **Standard display** menu using the  or  button:

- tire pressure monitor (▷ page 253)
- digital speedometer or outside temperature (▷ page 160)
- Service display (▷ page 219)
- **G 55 AMG:** oil level (▷ page 215)
- ▶ **To reset the trip odometer:** press and hold the reset button in the instrument cluster until the trip odometer is reset.

Displaying the digital speedometer or outside temperature

If you have selected the digital speedometer as the status line (▷ page 163), the outside temperature is displayed here¹³.

Warning!

The outside temperature indicator is not designed to serve as an ice-warning device and is therefore unsuitable for that purpose.





Indicated temperatures just above the freezing point do not guarantee that the road surface is free of ice. The road may still be icy, especially in wooded areas or on bridges.



Digital speedometer (example)



Outside temperature (example)

- ▶ Press the  or  button on the steering wheel to select the standard display.
- ▶ Press the  or  button on the steering wheel to select digital speedometer ① or the outside temperature.

Audio menu



Selecting a radio station

- ① SIRIUS XM satellite radio acts like a normal radio.

For more information on satellite radio operation, see the separate operating instructions.





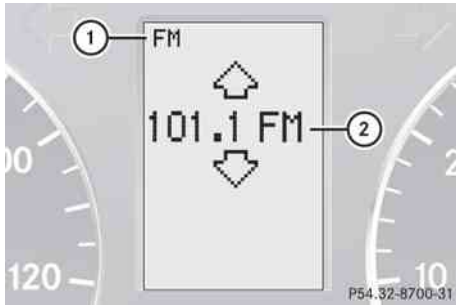

¹³ Vehicles for the United Kingdom: the outside temperature is always displayed.

You can only change the waveband and store new stations using COMAND.



- ▶ Switch on COMAND and select Radio (see the separate operating instructions).
- ▶ Press the  or  button on the steering wheel to select the **Audio** menu.



- ① Waveband
- ② Current station

- ▶ **To select a stored station:** briefly press the  or  button.
- ▶ **To select a station from the station list:** press and briefly hold the  or  button.
- ▶ **To select a station using station search¹⁴:** press and briefly hold the  or  button.



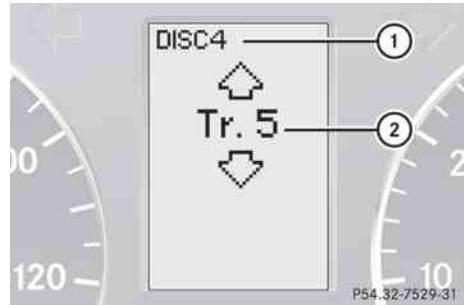

Operating audio devices or media

- ▶ Switch on COMAND and select the audio device or medium (see the separate operating instructions).
- ▶ Press the  or  button on the steering wheel to select the **Audio** menu.





COMAND display (example)

- ① Current CD (for CD/DVD changer)
- ② Current track

- ▶ **To select the next/previous track:** briefly press the  or  button.
- ▶ **To select a track from the track list (rapid scrolling):** press and briefly hold the  or  button.

The current track does not appear in audio AUX mode (**A**uxiliary audio mode: external audio source connected).

Operating the video DVD

- ▶ Switch on COMAND and select video DVD (see the separate operating instructions).
- ▶ Press the  or  button on the steering wheel to select the **Audio** menu.

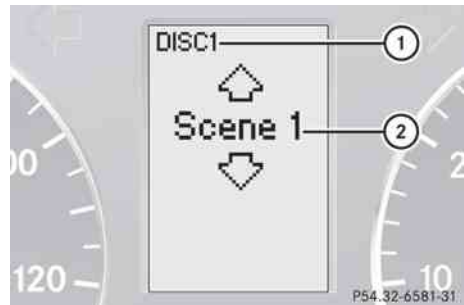

DVD changer display (example)

- ① Current DVD (for DVD changer)
- ② Current scene



¹⁴ Only if no station list is received.

- ▶ Press the  or  button to select a scene.

Navigation menu

Displaying navigation instructions

In the **Navigation** menu: the instructions from the navigation system appear in the multifunction display. For more information, see the separate operating instructions.

- ▶ Switch on COMAND (see the separate operating instructions).
- ▶ Press the  or  button on the steering wheel to select the **Navigation** menu.

Route guidance inactive

The direction of travel appears in the multifunction display. If the name of the street is part of the navigation system data, this will also be displayed.



Route guidance active

The multifunction display shows navigation instructions, for example:



Setup menu

Introduction







In the **Settings** menu, you have the following options:

- restoring the factory settings
- changing the instrument cluster settings
- changing the light settings
- changing the vehicle settings
- changing the convenience settings

Resetting to factory settings











For safety reasons, not all functions are reset: the **Headlamp mode** function in the **Lighting** submenu is only reset if the vehicle is stationary.

- ▶ Press the  or  button on the steering wheel to select the **Settings** menu.
 - ▶ Press and hold the reset button on the left of the instrument cluster for approximately three seconds.
A prompt appears in the multifunction display asking you to confirm by pressing the reset button again.
 - ▶ Press the reset button again.
The settings of most functions are restored to the factory settings.
- or
- ▶ If you want to retain the settings, do not press the reset button a second time.
The **Settings** menu appears again after approximately five seconds.
 - ▶ Press the  or  button to select a different menu.

Instrument cluster











Selecting the unit of measurement for distance

The selected unit of measurement for distance applies to:











- the odometer and the trip odometer
- the trip computer
- the digital speedometer
- ▶ Press the  or  button on the steering wheel to select the **Settings** menu.
- ▶ Press the  button to select submenus.
- ▶ Press the  or  button to select the **Inst. Cluster** submenu.
- ▶ Press the  button to select **Disp. Unit Speed-/Odom.**
- ▶ Press the  or  button to select **Km** (kilometers) or **Miles** as the unit of measurement for distance.
- ▶ Press the ,  or  button to select a different display.

Selecting the language

The **Language** function allows you to select the language for the instrument cluster.

- ▶ Press the  or  button on the steering wheel to select the **Settings** menu.
- ▶ Press the  button to select submenus.
- ▶ Press the  or  button to select the **Inst. cluster** submenu.
- ▶ Press the  button to select **Language**.
- ▶ Press the  or  button to select the desired language.
- ▶ Press the ,  or  button to select a different display.

Selecting the status line display

- ▶ Press the  or  button on the steering wheel to select the **Settings** menu.
- ▶ Press the  button to select submenus.
- ▶ Press the  or  button to select the **Inst. cluster** submenu.
- ▶ Press the  button to select **Status line display**.
- ▶ Press the  or  button to select the status line display: speed (**Speed**) or outside temperature (**Outside temp.**).
The selected display now appears constantly in the lower multifunction display. When you scroll through the **Standard display** menu (▶ page 160), you will see the display you have not selected.
- ▶ Press the ,  or  button to select a different display.

Lighting

Adjusting the instrument cluster lighting

The instrument cluster lighting automatically adjusts to the ambient light.

- ▶ **Brighter or dimmer:** turn reset button (▶ page 26) clockwise or counter-clockwise.

Switching the daytime running lamps on/off











This function is not available in Canada.

If you have activated the daytime running lamps function and the light switch is in the **0** or **AUTO** position, the low-beam headlamps are switched on automatically when the engine is running.

In the dark, the following also light up:

- the low-beam headlamps
- the standing lamps
- the tail lamps
- the license plate lamp
- the side marker lamp

In countries where daytime running lamps are legally required, **Constant** is the factory setting.











- ▶ Press the  or  button on the steering wheel to select the **Settings** menu.
- ▶ Press the  button to select submenus.
- ▶ Press the  or  button to select the **Lighting** submenu.
- ▶ Press the  button to select **Headlamp mode**.
- ▶ Press the  or  button to set the mode for the headlamps to **Manual** or **Constant** (daytime running lamps).
- ▶ Press the ,  or  button to select a different display.

Switching the surround lighting on or off

If you activate the surround lighting function and the light switch is set to **AUTO**, the following will light up if it is dark and you unlock the vehicle using the key:

- the standing lamps
- the license plate lamp
- the tail lamps
- the fog lamps
- the side marker lamp

The surround lighting switches off automatically after 40 seconds or when the driver's door is opened.







- ▶ Press the  or  button on the steering wheel to select the **Settings** menu.
- ▶ Press the  button to select submenus.
- ▶ Press the  or  button to select the **Lighting** submenu.
- ▶ Press the  button to select **Surround Lighting**.
- ▶ Press the  or  button to switch the **Surround lighting** on or off.
- ▶ When leaving the vehicle, turn the light switch to position **AUTO**. The surround lighting is activated.
- ▶ Press the ,  or  button to select a different display.





Activating/deactivating the exterior lighting delayed switch-off

If you have activated the delayed switch-off function, the light switch is set to **AUTO** and you switch off the engine, the following remain lit:

- the standing lamps
- the license plate lamp
- the tail lamps
- the fog lamps
- the side marker lamp

If the engine is switched off and then none of the doors are opened, or if an open door is not closed, the exterior lighting goes out after 60 seconds.

- ▶ Press the  or  button on the steering wheel to select the **Settings** menu.
- ▶ Press the  button to select submenus.
- ▶ Press the  or  button to select the **Lighting** submenu.
- ▶ Press the  button to select **Headl. Delayed Switch Off**.

- ▶ Press the  or  button to activate or deactivate the **Headl. Delayed Switch Off** function.
- ▶ Before switching off the engine, turn the light switch to position **AUTO**. The exterior lighting delayed switch-off is activated.
- ▶ Press the ,  or  button to select a different display.











Deactivating the delayed switch-off temporarily:

- ▶ Before leaving the vehicle, turn the key to position **0** in the ignition lock.
- ▶ Turn the key to position **2** in the ignition lock and back to position **0**. The delayed switch-off is deactivated.

Delayed switch-off is reactivated the next time you start the engine.

Activating/deactivating the interior lighting delayed switch-off













If the **Interior Light. Delay. Sw. Off:** function is activated and you pull the key out of the ignition lock, the interior lighting remains on for around 10 seconds.

- ▶ Press the  or  button on the steering wheel to select the **Settings** menu.
- ▶ Press the  button to select submenus.
- ▶ Press the  or  button to select the **Lighting** submenu.
- ▶ Press the  button to select **Interior Light. Delay Sw. Off**.
- ▶ Press the  or  button to activate or deactivate **Interior Light. Delay. Sw. Off**.
- ▶ Press the ,  or  button to select a different display.

Vehicle

Activating/deactivating the automatic door locking feature

If you select the **Automatic Locking** function, the vehicle is centrally locked above a speed of around 9 mph (15 km/h).

- ▶  For more information on the automatic locking feature, see (▶ page 68).
- ▶ Press the  or  button on the steering wheel to select the **Settings** menu.
- ▶ Press the  button to select submenus.
- ▶ Press the  or  button to select the **Vehicle** submenu.
- ▶ Press the  button to select **Automatic Door Lock**.
- ▶ Press the  or  button to switch the **Automatic Door Lock** feature on or off.
- ▶ Press the ,  or  button to select a different display.

Convenience

Activating/deactivating the EASY-ENTRY/EXIT feature

You can use the **Easy-entry Function** to activate or deactivate the EASY-ENTRY/EXIT feature (▶ page 84).

Warning!











You must make sure no one can become trapped or injured by the moving steering wheel when the easy-entry/exit feature is activated.

To stop steering wheel movement do one of the following:

- Move steering wheel adjustment stalk.
- Press one of the memory position buttons.
- Press the memory button.

Do not leave children unattended in the vehicle, or with access to an unlocked vehicle. Children could open the driver's door and



unintentionally activate the easy-entry/exit feature, which could result in an accident and/or serious personal injury.

- ▶ Press the  or  button on the steering wheel to select the **Settings** menu.
- ▶ Press the  button to select submenu.
- ▶ Press the  or  button to select the **Convenience** submenu.
- ▶ Press the  button to select the **Easy-entry Function**.
- ▶ Press the  or  button to activate or deactivate the **Easy-entry Function**.
- ▶ Press the ,  or  button to select a different display.

Trip computer menu

Trip computer "From start" or "From reset"

The values in the **From Start** submenu are calculated from the start of a journey whilst the values in the **From Reset** submenu are calculated from the last time the submenu was reset.

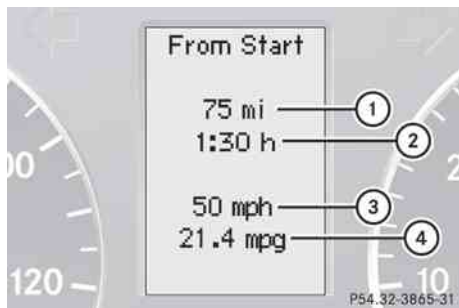

- ▶ Press the  or  button to select **From Start**.



Trip computer "After start" (example)

- ① Distance
- ② Time

- ③ Average speed
- ④ Average fuel consumption

- ▶ Press the  button to select **From Start** or the  button to select **From Reset** in the submenu.

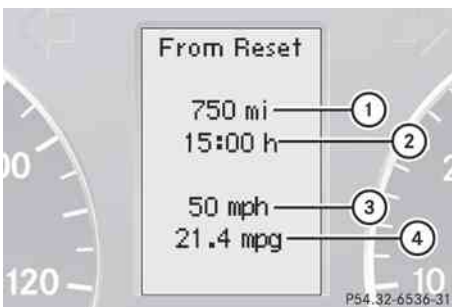

Trip computer "From reset" (example)





- ① Distance
- ② Time
- ③ Average speed
- ④ Average fuel consumption

The trip computer function **From Start** is automatically reset when:





- the ignition has been switched off for more than four hours.
- 999 hours have been exceeded.
- 9999 miles have been exceeded.

If 9999 hours or 99,999 kilometers are exceeded, the trip computer **From Reset** is automatically reset.

Resetting

- ▶ Press the  or  button to select **From Start**.
- ▶ Press the  or  button to select the function that you wish to reset.
- ▶ Press and hold the reset button on the left of the instrument cluster until the values have reverted to "0".

Calling up the range

- ▶ Press the  or  button to select **From Start**.
- ▶ Press the  or  button to select **Range**.

The multifunction display shows the estimated range of the vehicle, based on the current driving style and the fuel level. If there is only a small amount of fuel remaining in the fuel tank, a gas pump  appears instead of the range.

Telephone menu



Introduction

You can establish a Bluetooth® connection to COMAND (see the separate operating instructions).

Warning

A driver's attention to the road must always be his/her primary focus when driving. For your safety and the safety of others, we recommend that you pull over to a safe location and stop before placing or taking a telephone call. If you choose to use the telephone while driving, please use the hands-free device and only use the telephone when weather, road and traffic conditions permit.

Some jurisdictions prohibit the driver from using a mobile phone while driving a vehicle. Bear in mind that at a speed of just 30 mph (approximately 50 km/h), your vehicle is covering a distance of 44 feet (approximately 14 m) every second.

- ▶ Switch on the mobile phone and COMAND (see the separate operating instructions).
- ▶ Press the  or  button on the steering wheel to select the **Telephone** menu.

You will see one of the following display messages in the multifunction display:

- **Ready** or the name of the network provider: the mobile phone has found a network and is ready to receive.
- **Bluetooth Ready**: the mobile phone is not yet connected via Bluetooth® to COMAND.
- **No Service**: no network is available.

Accepting a call

If someone calls you when you are in the **Telephone** menu, a display message appears in the multifunction display, for example:



COMAND display (example)

- ▶ Press the  button on the steering wheel to accept an incoming call.

If you are not in the **Telephone** menu, you can still accept a call.







Rejecting or ending a call

- ▶ Press the  button on the steering wheel.

If you are not in the **Telephone** menu, you can still accept a call.

Dialing a number from the phone book

You can enter new telephone numbers into the phone book via the mobile phone (see the separate operating instructions). If your mobile phone is operational, you can select and dial a number from the phone book at any time.







- ▶ Press the  or  button on the steering wheel to select the **Telephone** menu.
- ▶ Press the  or  button to select the desired name.
To start scrolling rapidly, press and hold the  or  button for longer than one second.
- ▶ Press  to start dialing.
The multifunction display shows the **Connecting call** display message.
The number dialed is stored in the redial memory.
If the call is connected, the call duration appears in the multifunction display. If it is stored in the phone book, the name is also displayed. Otherwise, the number dialed is displayed.

or

- ▶ If you do not want to make a call, press the  button.

Redialing

The on-board computer stores the last phone numbers which have been dialed.

- ▶ Press the  or  button on the steering wheel to select the **Telephone** menu.
- ▶ Press the  button to switch to the redial memory.
- ▶ Press the  or  button to select the desired name or number.
- ▶ Press  to start dialing.

Display messages





Hiding display messages

Warning

All categories of messages contain important information which should be taken note of and, where a malfunction is indicated, addressed as soon as possible at an authorized Mercedes-Benz Center.

Failure to repair the condition noted may cause damage not covered by the Mercedes-Benz Limited Warranty, or result in property damage or personal injury.

Display messages appear in the multifunction display.

► Press the , ,  or  button on the steering wheel to select another display.

or

► Press the reset button on the instrument cluster (▷ page 26).

The display message is cleared.

The multifunction display shows high-priority display messages in red.

You cannot hide display messages of the highest priority. The multifunction display shows these messages continuously until the causes for the messages have been remedied.



Certain display messages are accompanied by an audible warning tone or a continuous tone.

Please respond in accordance with the display messages and follow the additional notes in this Operator's Manual.



Message memory menu

The on-board computer saves certain display messages. You can call up the display messages in the **message memory** menu.

The **message memory** menu is only shown if any display messages have been stored.

► Press the  or  button repeatedly, until either the original menu or the **message memory** menu is shown.

If there are display messages, the multifunction display shows **2 Messages**, for example.

► Press the  or  button to scroll through the display messages.

When the ignition is switched off, all display messages are deleted apart from some high-priority display messages. Once the causes of the high-priority display messages have been rectified, the corresponding display messages are also deleted.

Safety systems

Display messages

Possible causes/consequences and ► Solutions

ESP

Inoperative See
Operator's Manual

 **Risk of accident**

ESP® is not available due to a malfunction.
ABS, BAS, EBD, 4ETS and the tire pressure monitor have also been deactivated.

The brake system continues to function normally, but without the functions listed above.

- Drive on carefully.
- Visit a qualified specialist workshop immediately.



Tele Aid
Inoperative

USA only: one or more main functions of the mbrace system are malfunctioning.

Canada only: one or more main functions of the Tele Aid system are malfunctioning.

- USA only: have the mbrace system checked at a qualified specialist workshop.
- Canada only: have the Tele Aid system checked at a qualified specialist workshop.

SRS

Restraint System
Malfunction
Service Required

 **Risk of injury**







The restraint systems are malfunctioning.

- Visit a qualified specialist workshop immediately.

 **Warning**

In the event a malfunction of the SRS is indicated as outlined above, the SRS may not be operational.

For your safety, we strongly recommend that you contact an authorized Mercedes-Benz Center immediately to have the system checked. Otherwise the SRS may not be activated when needed in an accident, which could result in serious or fatal injury, or it might deploy unexpectedly and unnecessarily which could also result in injury.

Brakes	
Display messages	Possible causes/consequences and ► Solutions
ABS ABS not available Differential Locked	You have engaged the differential locks. <ul style="list-style-type: none"> ► Disengage the differential locks. Subsequently ABS is reactivated.
ABS Inoperative See Operator's Manual	<p> Risk of accident</p> <p>ABS (Anti-lock Brake System) and ESP® (Electronic Stability Program) are not available due to a malfunction. BAS, EBD and 4ETS have also been deactivated. The brake system continues to function normally, but without the functions listed above. The wheels could therefore lock if you brake hard, for example.</p> <ul style="list-style-type: none"> ► Drive on carefully. ► Visit a qualified specialist workshop immediately.
 Brake Wear	<p>The brake pads/linings have reached their wear limit.</p> <ul style="list-style-type: none"> ► Have the brake pads/linings replaced as soon as possible at a qualified specialist workshop.
 (USA only)  (Canada only) Check Brake Fluid Level	<p> Risk of accident</p> <p>There is insufficient brake fluid in the brake fluid reservoir.</p> <ul style="list-style-type: none"> ► Pull over as soon as it is safe to do so. ► Do not continue driving under any circumstances. ► Engage the parking brake. ► Consult a qualified specialist workshop. ► Do not add brake fluid. This does not correct the error.
 (USA only)  (Canada only) Release Parking Brake	<p>You are driving with the parking brake applied.</p> <ul style="list-style-type: none"> ► Release the parking brake

 **Warning**

Driving with the message **Check Brake Fluid Level** displayed can result in an accident. Have your brake system checked immediately.

Do not add brake fluid before checking the brake system. Overfilling the brake fluid reservoir can result in spilling brake fluid on hot engine parts and the brake fluid catching fire. You can be seriously burned.

Lights

Display messages

Possible causes/consequences and ► Solutions



Low Beam Left
or
Low Beam Right

The left or right-hand low-beam headlamp is defective.
► Visit a qualified specialist workshop.



AUTO-Light
Inoperative

The light sensor is defective. The low-beam headlamps are switched on.
► USA only: set the lights to manual operation in the on-board computer (► page 164).
► Switch the lights on and off using the light switch.
► Visit a qualified specialist workshop.



Turn Signal Rear
Left Auxiliary
Bulb On
or
Turn Signal Rear
Right Auxiliary
Bulb On

The rear left-hand or rear right-hand turn signal is defective. Another lamp has taken over its function.
► Replace the bulb (► page 96).



Turn Signal Left
Side Mirror
or
Turn Signal Right
Side Mirror

The turn signal in the left-hand or right-hand exterior mirror is defective. These messages will only appear if all of the turn signal's LEDs have failed.
► Visit a qualified specialist workshop.











Turn Signal Front
Left Auxiliary
Bulb On
or
Turn Signal Front
Right Auxiliary
Bulb On



The front left-hand or front right-hand turn signal is defective. Another lamp has taken over its function.
► Replace the bulb (► page 96).





Brake Lamp Left
or
Brake Lamp Right

The left or right-hand brake lamp is defective.
► Replace the bulb (► page 96).

Display messages	Possible causes/consequences and ► Solutions
 <p>3rd Brake Lamp</p>	<p>The high-mounted brake lamp is faulty. This message will only appear if all of the brake lamp's LEDs have failed.</p> <p>► Visit a qualified specialist workshop.</p>
 <p>High Beam Left or High Beam Right</p>	<p>The left or right-hand high beam is defective.</p> <p>► Visit a qualified specialist workshop.</p>
 <p>License Plate Lamp, Left or License Plate Lamp, Right</p>	<p>There is a short circuit in the LED lamps. The LEDs have been switched off.</p> <p>► Visit a qualified specialist workshop.</p> <p>i Individual segments of the LED lamps may fail without a display message being shown in the multifunction display. Regularly check the license plate lamp. If necessary, visit a qualified specialist workshop.</p>
 <p>Turn off lights or remove key</p>	<p>You have left the key in the ignition lock.</p> <p>► Remove the SmartKey from the ignition lock.</p>
 <p>Switch Off Lights</p>	<p>The lights are still switched on when you leave the vehicle.</p> <p>► Turn the light switch to 0 or AUTO (► page 90).</p>
 <p>Front Foglamp Left or Front Foglamp Right</p>	<p>The left-hand or right-hand front fog lamp is defective.</p> <p>► Replace the bulb (► page 96).</p>
 <p>Front Left Side Marker Lamp or Front Right Side Marker Lamp</p>	<p>The left or right front side marker lamp is defective.</p> <p>► Replace the bulb (► page 96).</p>
 <p>Rear Foglamp Auxiliary Bulb On</p>	<p>The rear fog lamp is defective. Another lamp has taken over its function.</p> <p>► Replace the bulb (► page 96).</p>

Display messages	Possible causes/consequences and ► Solutions
 Parking Lamp Front Left Auxiliary Bulb On or Parking Lamp Front Right Auxiliary Bulb On	The front left-hand or front right-hand standing lamp is faulty. Another lamp has taken over its function. ► Visit a qualified specialist workshop.
 Reverse Lamp Right	The backup lamp is faulty. ► Replace the bulb (> page 96).
 Tail Lamp Left Auxiliary Bulb On or Tail Lamp Right Auxiliary Bulb On	The left or right-hand tail lamp is faulty. Another lamp has taken over its function. ► Replace the bulb (> page 100).

Engine

Display messages	Possible causes/consequences and ► Solutions
	Some electronic systems are unable to send information to the on-board computer. The coolant temperature gauge and the tachometer could be defective. ► Visit a qualified specialist workshop.
 Top Up Coolant See Operator's Manual	The coolant level is too low. ► Add coolant, following the warning notes when doing so (> page 217). ► If you need to add coolant more often than usual, have the engine coolant system checked at a qualified specialist workshop.

Warning

Do not spill antifreeze on hot engine parts. Antifreeze contains ethylene glycol which may burn if it comes into contact with hot engine parts. You could be seriously burned.

! The coolant level is too low. Avoid making long journeys with too little coolant in the cooling system. The engine will otherwise be damaged.

The display messages and the corresponding symbol that indicate that the coolant level is too low must not be ignored.

Display messages	Possible causes/consequences and ► Solutions
 <p data-bbox="113 296 344 352">Coolant Stop, Turn Engine off</p>	<p data-bbox="372 245 605 269">The coolant is too hot.</p> <ul style="list-style-type: none"> <li data-bbox="372 288 1041 339">► Pull over and stop the vehicle safely and switch off the engine, paying attention to road and traffic conditions. <li data-bbox="372 352 1041 403">► Make sure that the air supply to the radiator is not blocked, e.g. by snow, slush or ice. <li data-bbox="372 416 1041 467">► Wait until the display message disappears before restarting the engine. Otherwise, there is a risk of engine damage. <li data-bbox="372 480 904 504">► Pay attention to the coolant temperature display. <li data-bbox="372 517 1024 568">► If the temperature increases again, visit a qualified specialist workshop immediately. <p data-bbox="372 595 688 619">The poly-V-belt may have torn.</p> <ul style="list-style-type: none"> <li data-bbox="372 632 1041 683">► Pull over and stop the vehicle safely and switch off the engine, paying attention to road and traffic conditions. <li data-bbox="372 695 557 719">► Open the hood. <li data-bbox="372 732 788 756">► Check whether the poly-V-belt is torn. <p data-bbox="372 769 645 793">If the poly-V-belt is torn:</p> <ul style="list-style-type: none"> <li data-bbox="372 812 1041 836">! Do not continue driving. The engine could otherwise overheat. <li data-bbox="372 855 807 879">► Consult a qualified specialist workshop. <p data-bbox="372 892 631 916">If the poly-V-belt is OK:</p> <ul style="list-style-type: none"> <li data-bbox="372 935 1041 986">► Wait until the display message disappears before restarting the engine. Otherwise, there is a risk of engine damage. <li data-bbox="372 999 904 1023">► Pay attention to the coolant temperature display. <li data-bbox="372 1035 773 1059">► Visit a qualified specialist workshop.



Warning



Driving when your engine is overheated can cause some fluids which may have leaked into the engine compartment to catch fire. You could be seriously burned.

Steam from an overheated engine can cause serious burns which can occur just by opening the engine hood. Stay away from the engine if you see or hear steam coming from it.

Stop the vehicle in a safe location away from other traffic. Turn off the engine, get out of the vehicle and do not stand near the vehicle until the engine has cooled down.

- ! If the coolant temperature exceeds 248 °F (120 °C) do not continue driving. The engine will otherwise be damaged.





Display messages	Possible causes/consequences and ► Solutions
	<p>The engine fan is defective.</p> <ul style="list-style-type: none"> ► At coolant temperatures under 248 °F (120 °C), drive to the next qualified specialist workshop. ► Avoid subjecting the engine to heavy loads, e.g. driving in mountainous terrain, and stop-and-go traffic.
	<p>The battery is not being charged.</p> <p>Possible causes are:</p> <ul style="list-style-type: none"> • a defective alternator • a torn poly-V-belt • a malfunction in the electronics <ul style="list-style-type: none"> ► Pull over and stop the vehicle safely and switch off the engine, paying attention to road and traffic conditions. ► Open the hood. ► Check whether the poly-V-belt is torn. <p>If the poly-V-belt is torn:</p> <ul style="list-style-type: none"> ! Do not continue driving. The engine could otherwise overheat. ► Consult a qualified specialist workshop. <p>If the poly-V-belt is OK:</p> <ul style="list-style-type: none"> ► Visit a qualified specialist workshop. <p>The battery voltage is too low.</p> <ul style="list-style-type: none"> ► Switch off electrical consumers that are not required. ► Have the battery and alternator checked at a qualified specialist workshop. <p>The battery has been charged or the vehicle has been jump-started.</p> <ul style="list-style-type: none"> ► Have the battery and alternator checked at a qualified specialist workshop.
 <p>Check oil level at next gas station</p>	<p>The engine oil level has dropped to a critical level.</p> <ul style="list-style-type: none"> ► Check the oil level (► page 215). ► If necessary, add engine oil (► page 216). ► Have the engine checked for leaks if you need to add engine oil more often than usual. <p>You have added too much engine oil. There is a risk of damaging the engine or catalytic converter.</p> <ul style="list-style-type: none"> ► Siphon off excess engine oil until it is at the specified level. Observe the legal requirements.

Display messages	Possible causes/consequences and ► Solutions
	<p>There is water in the engine oil.</p> <ul style="list-style-type: none"> ► Have the engine oil examined at a qualified specialist workshop. <p>The measuring system is malfunctioning.</p> <ul style="list-style-type: none"> ► Visit a qualified specialist workshop.
 <p>Engine Oil Level Service Required</p>	<p>The engine oil level has dropped to a critical level.</p> <ul style="list-style-type: none"> ► Check the oil level (▷ page 215). ► If necessary, add engine oil (▷ page 216). ► Have the engine checked for leaks if you need to add engine oil more often than usual. <p>You have added too much engine oil. There is a risk of damaging the engine or catalytic converter.</p> <ul style="list-style-type: none"> ► Siphon off excess engine oil until it is at the specified level. Observe the legal requirements. <p>There is water in the engine oil.</p> <ul style="list-style-type: none"> ► Have the engine oil checked.
 <p>At next-gas station add 1.0 qt. engine oil (USA only) At next-gas station add 1.0 liter engine oil (Canada only)</p>	<p>The engine oil level is too low.</p> <ul style="list-style-type: none"> ► Check the oil level (▷ page 215). ► If necessary, add engine oil (▷ page 216). ► Have the engine checked for leaks if you need to add engine oil more often than usual.

Information on approved engine oils can be obtained from any qualified specialist workshop or on the Internet at <http://www.mbusa.com> (USA only).

! The oil level is too low. Avoid long journeys with too little engine oil. There is a risk of engine damage.

The display messages and the corresponding symbol that indicate that the oil level is too low must not be ignored.

Display messages	Possible causes/consequences and ► Solutions
 <p>Engine Oil Level Stop, Turn Engine Off</p>	<p>The engine oil level is too low. There is a risk of engine damage.</p> <ul style="list-style-type: none"> ► Pull over and stop the vehicle safely and switch off the engine, paying attention to road and traffic conditions. ► Switch off the engine. ► Add engine oil (► page 216) and check the oil level (► page 215).
 <p>Reserve Fuel</p>	<p>The fuel level has fallen below the reserve range. The fuel gauge's needle does not move any further down. The operation of the auxiliary heating can no longer be guaranteed.</p> <ul style="list-style-type: none"> ► Refuel at the nearest gas station.
 <p>Gas cap is open</p>	<p>The fuel system pressure is too low. The fuel filler cap is not closed correctly or the fuel system is leaking.</p> <ul style="list-style-type: none"> ► Check that the fuel filler cap is correctly closed. ► If the fuel filler cap is not correctly closed: close the fuel filler cap. ► If the fuel filler cap is closed: visit a qualified specialist workshop.
 <p>Clean Fuel Filter</p>	<p>There is water in the fuel filter. The water must be drained off.</p> <ul style="list-style-type: none"> ► Visit a qualified specialist workshop.

Driving systems

Display messages	Possible causes/consequences and ► Solutions
<p>AAS Service Required</p>	<p> Risk of accident</p> <p>AAS is not available due to a malfunction. The vehicle may roll back on a gradient as soon as you remove your foot from the accelerator pedal.</p> <ul style="list-style-type: none"> ► Drive on carefully. ► Visit a qualified specialist workshop immediately.
<p>Cruise Cont. Inoperative</p>	<p>Cruise control is inoperative.</p> <ul style="list-style-type: none"> ► Visit a qualified specialist workshop.

Tires

Warning

Do not drive with a flat tire. A flat tire affects the ability to steer or brake the vehicle. You may lose control of the vehicle. Continued driving with a flat tire will cause excessive heat build-up and possibly a fire.



Warning





Follow recommended tire inflation pressures.

Do not underinflate tires. Underinflated tires wear excessively and/or unevenly, adversely affect handling and fuel economy, and are more likely to fail from being overheated.







Do not overinflate tires. Overinflated tires can adversely affect handling and ride comfort, wear unevenly, increase stopping distance, and result in sudden deflation (blowout) because they are more likely to become punctured or damaged by road debris, potholes etc.

Display messages	Possible causes/consequences and ► Solutions
Tire pressure displayed only after driving for a few minutes	The tire pressure monitor is measuring the tire pressure. ► Drive on. The tire pressures appear in the multifunction display after you have been driving for a few minutes.
Tire Pres. Check Tires	 Risk of accident The tire pressure monitor has detected a significant pressure loss. ► Stop the vehicle without making any sudden steering or braking maneuvers. Pay attention to the traffic conditions as you do so. ► Check the tires. ► Check the tire pressure and correct it if necessary (▷ page 246). ► Repair or change the faulty wheel as necessary (▷ page 232). ► Then, restart the tire pressure monitor when the tire pressure is correct (▷ page 253).
Tire Pres. Monitor Inoperative	The tire pressure monitor is deactivated due to a malfunction. ► Visit a qualified specialist workshop.
Tire Pres. Monitor Inoperative No Wheel Sensors	The wheels mounted do not have a suitable tire pressure sensor. The tire pressure monitor is deactivated. ► Mount wheels with suitable tire pressure sensors. The tire pressure monitor is activated automatically after driving for a few minutes.

Display messages	Possible causes/consequences and ► Solutions
Caution Tire Defect	 Risk of accident The tire pressure in one or more tires has dropped suddenly. The wheel position is displayed in the multifunction display. <ul style="list-style-type: none"> ► Stop the vehicle without making any sudden steering or braking maneuvers. Pay attention to the traffic conditions as you do so. ► If necessary, change a wheel (▷ page 232).
Correct The Tire Pres.	The tire pressure is too low in at least one of the tires or the tire pressure difference between the wheels is too great. <ul style="list-style-type: none"> ► Check the tire pressures at the next opportunity. If necessary, correct the tire pressure (▷ page 249). ► Restart the tire pressure monitor (▷ page 255).
Wheel Sensor Missing	There is no signal from the tire pressure sensor of one or several wheels. The pressure of the affected tire is not displayed in the multifunction display. <ul style="list-style-type: none"> ► Have the defective tire pressure sensor replaced at a qualified specialist workshop.
Tire Pres. Monitor Currently Unavailable	Due to a source of radio interference, no signals can be received from the wheel sensors. The tire pressure monitor is temporarily malfunctioning. <ul style="list-style-type: none"> ► Drive on. The tire pressure monitor restarts automatically as soon as the problem has been solved.
 Correct The Tire Pres.	The tire pressure is too low in at least one of the tires or the tire pressure difference between the wheels is too great. <ul style="list-style-type: none"> ► Check the tire pressures at the next opportunity. If necessary, correct the tire pressure (▷ page 252).

Display messages	Possible causes/consequences and ► Solutions
 <p>Tire Pres. Caution Tire Defect</p>	<p> Risk of accident</p> <p>The tire pressure in one or more tires has dropped suddenly.</p> <ul style="list-style-type: none"> ► Stop the vehicle without making any sudden steering or braking maneuvers. Pay attention to the traffic conditions as you do so. ► If necessary, change a wheel (► page 232).
 <p>Tire Pres. Check Tires</p>	<p> Risk of accident</p> <p>The tire pressure in one or more tires has dropped significantly.</p> <ul style="list-style-type: none"> ► Stop the vehicle without making any sudden steering or braking maneuvers. Pay attention to the traffic conditions as you do so. ► If necessary, change a wheel (► page 232). ► Check the tire pressure. If necessary, correct the tire pressure (► page 252).

Vehicle

Display messages	Possible causes/consequences and ► Solutions
	<p>The rear door is open.</p> <ul style="list-style-type: none"> ► Close the rear door.
	<p> Risk of accident</p> <p>Vehicles with anti-theft alarm system: The hood is open. A warning tone also sounds.</p> <ul style="list-style-type: none"> ► Pull over and stop the vehicle safely as soon as possible, paying attention to road and traffic conditions. ► Apply the parking brake. ► Close the hood.
	<p>At least one door is open.</p> <ul style="list-style-type: none"> ► Close all the doors.
 <p>Bluetooth Ready</p>	<p>The Bluetooth[®] connection between your mobile phone and COMAND is not activated.</p> <ul style="list-style-type: none"> ► If desired, activate the Bluetooth[®] connection between your mobile phone and COMAND (see the separate Operator's Manual).
 <p>Top Up Washer Fluid</p>	<p>The washer fluid level in the washer fluid reservoir has dropped below the minimum.</p> <ul style="list-style-type: none"> ► Add washer fluid (► page 218).





Display messages	Possible causes/consequences and ► Solutions
<div style="border: 1px solid black; padding: 2px; display: inline-block;">LOW HIGH</div> TC Shift Procedure Canceled	The gear change process was not carried out. ► Repeat the gearshift process.
<div style="border: 1px solid black; padding: 2px; display: inline-block;">LOW HIGH</div> TC Shift Conditions Not Fulfilled	One or more conditions to shift the transfer case have not been fulfilled. ► Repeat the gearshift process.
<div style="border: 1px solid black; padding: 2px; display: inline-block;">LOW HIGH</div> TC In Neutral	The transfer case is in the neutral position. ► Shifting the transfer case into HIGH or LOW .
<div style="border: 1px solid black; padding: 2px; display: inline-block;">LOW HIGH</div> Transfer Case Service Required	There is a malfunction in the transfer case. ► Do not shift the transfer case. ► Have the vehicle checked as soon as possible at a qualified specialist workshop.

 **Warning!**

If the transfer case is in **Neutral**, the park position **P** of the automatic transmission will not hold the vehicle. The parking brake must be engaged to hold the vehicle in place.

Warning and indicator lamps in the instrument cluster









Brakes





Problem	Possible causes/consequences and ► Solutions
<p> (USA only)  (Canada only)</p> <p>The red brake system warning lamp comes on while the vehicle is moving. A warning tone also sounds.</p>	<p>You are driving with the parking brake applied.</p> <ul style="list-style-type: none"> ► Release the parking brake <p>The warning lamp goes out and the warning tone ceases.</p>
<p> (USA only)  (Canada only)</p> <p>The red brake system warning lamp comes on while the engine is running.</p>	<p> Risk of accident</p> <p>There is not enough brake fluid in the brake fluid reservoir.</p> <ul style="list-style-type: none"> ► Pull over and stop the vehicle safely as soon as possible, paying attention to road and traffic conditions. Do not continue driving under any circumstances. ► Engage the parking brake. ► Consult a qualified specialist workshop immediately. ► Observe the additional display messages in the multifunction display. <p>Do not add brake fluid. This does not correct the error.</p>









 **Warning**



Driving with the brake warning lamp illuminated can result in an accident. Have your brake system checked immediately if the brake warning lamp stays on. Do not add brake fluid before checking the brake system.

Overfilling the brake fluid reservoir can result in spilling brake fluid on hot engine parts and the brake fluid catching fire. You can be seriously burned.

Seat belt	
Problem	Possible causes/consequences and ► Solutions
 <p>After starting the engine, the red seat belt warning lamp lights up for six seconds.</p>	<p>The seat belt warning lamp reminds the driver and front passenger to fasten their seat belts.</p> <p>► Fasten your seat belt (► page 43).</p>
 <p>After starting the engine, the red seat belt warning lamp lights up. In addition, a warning tone sounds for up to six seconds.</p>	<p> Risk of injury</p> <p>The driver's seat belt is not fastened.</p> <p>► Fasten your seat belt (► page 43). The warning tone ceases.</p>
 <p>The red seat belt warning lamp lights up after the engine starts, as soon as the driver's or the front-passenger door is closed.</p>	<p> Risk of injury</p> <p>The driver or front passenger has not fastened their seat belt.</p> <p>► Fasten your seat belt (► page 43). The warning lamp goes out.</p>
	<p> Risk of injury</p> <p>There are objects on the front-passenger seat.</p> <p>► Remove the objects from the front-passenger seat and stow them in a secure place. The warning lamp goes out.</p>
 <p>The red seat belt warning lamp flashes and an intermittent audible warning sounds.</p>	<p> Risk of injury</p> <p>The driver or front passenger has not fastened their seat belt. In addition, you are driving faster than 15 mph (25 km/h) or you have briefly driven faster than 15 mph (25 km/h).</p> <p>► Fasten your seat belt (► page 43). The warning lamp goes out and the intermittent audible warning ceases.</p>
	<p> Risk of injury</p> <p>There are objects on the front-passenger seat. In addition, you are driving faster than 15 mph (25 km/h) or you have briefly driven faster than 15 mph (25 km/h).</p> <p>► Remove the objects from the front-passenger seat and stow them in a secure place. The warning lamp goes out and the intermittent audible warning ceases.</p>

Safety systems	
Problem	Possible causes/consequences and ► Solutions
 <p>The yellow ABS warning lamp is lit while the engine is running.</p>	<p> Risk of accident</p> <p>ABS (Anti-lock Brake System) is deactivated due to a malfunction. BAS (Brake Assist), ESP[®] (Electronic Stability Program), EBD (Electronic Brake force Distribution) and 4ETS are also temporarily unavailable.</p> <p>The brake system continues to function normally, but without the functions listed above. The wheels could therefore lock if you brake hard, for example.</p> <ul style="list-style-type: none"> ► Observe the additional display messages in the multifunction display. ► Drive on carefully. ► Visit a qualified specialist workshop. <p>If the ABS control unit is faulty, there is also a possibility that other systems, such as the navigation system or the automatic transmission, will not be available.</p>
 <p>The yellow ABS warning lamp is lit while the engine is running.</p>	<p> Risk of accident</p> <p>The on-board voltage is too low. ABS has been deactivated due to undervoltage.</p> <p>ESP[®], BAS, EBD and 4ETS are also therefore deactivated.</p> <p>The brake system continues to function normally, but without the functions listed above. The wheels could therefore lock if you brake hard, for example.</p> <ul style="list-style-type: none"> ► Observe the additional display messages in the multifunction display. ► Drive on carefully. ► Switch off consumers that are not required, e.g. the rear window defroster or interior lighting. <p>ABS will be available again as soon as the vehicle's on-board electrical system voltage increases.</p> <p>If the warning lamp is still on:</p> <ul style="list-style-type: none"> ► Have the battery and alternator checked at a qualified specialist workshop.
 <p>The yellow ABS warning lamp is lit while the engine is running.</p>	<p>You have engaged the differential locks. ABS, BAS, EBD, ESP[®] and 4ETS have been deactivated.</p> <ul style="list-style-type: none"> ► Disengage the differential locks. <p>ABS, BAS, EBD, ESP[®] and 4ETS are subsequently reactivated.</p>





Problem	Possible causes/consequences and ► Solutions
 (USA only)  (Canada only)  The red brake system warning lamp and the yellow ABS warning lamp are on while driving. In addition, a warning tone sounds for about five seconds.	 Risk of accident EBD is faulty. The brake system continues to function normally, but without the functions listed above. The wheels could therefore lock if you brake hard, for example. <ul style="list-style-type: none"> ► Drive on carefully. ► Visit a qualified specialist workshop.
 The yellow ESP [®] warning lamp flashes while the vehicle is in motion.	 Risk of accident ESP [®] or traction control is intervening because there is a risk of skidding or at least one wheel has started to spin. <ul style="list-style-type: none"> ► Only depress the accelerator pedal as far as necessary when pulling away. ► Ease off the accelerator pedal after pulling away. ► Adapt your driving style to suit the road and weather conditions. ► Do not deactivate ESP[®]. Exceptions: (> page 57).
 The yellow ESP [®] OFF warning lamp is lit while the engine is running.	 Risk of accident ESP [®] is deactivated. ESP [®] will not stabilize the vehicle if it starts to skid or if a wheel starts to spin. <ul style="list-style-type: none"> ► Reactivate ESP[®]. Exceptions: (> page 57). <ul style="list-style-type: none"> ► Adapt your driving style to suit the road and weather conditions. If ESP [®] cannot be activated: <ul style="list-style-type: none"> ► Have ESP[®] checked at a qualified specialist workshop.



Problem	Possible causes/consequences and ► Solutions
 <p>The yellow ESP® OFF warning lamp is lit while the engine is running.</p>	<p>You have engaged the differential locks. ABS, ESP®, 4ETS and BAS have been deactivated.</p> <ul style="list-style-type: none"> ► Disengage the differential locks. ESP®, 4ETS and BAS are subsequently reactivated. ► Observe the additional display messages in the multifunction display.
 <p>The red SRS warning lamp is lit while the engine is running.</p>	<p> Risk of injury</p> <p>The restraint systems are malfunctioning. The air bags or ETDs may either be triggered unintentionally or, in the event of an accident, not be triggered at all.</p> <ul style="list-style-type: none"> ► Drive on carefully. ► Visit a qualified specialist workshop immediately.

 **Warning**

In the event a malfunction of the SRS is indicated as outlined above, the SRS may not be operational.

For your safety, we strongly recommend that you contact an authorized Mercedes-Benz Center immediately to have the system checked. Otherwise the SRS may not be activated when needed in an accident, which could result in serious or fatal injury, or it might deploy unexpectedly and unnecessarily which could also result in injury.

Engine	
Problem	Possible causes/consequences and ► Solutions
<p> (USA only)  (Canada only)</p> <p>The yellow engine diagnostics warning lamp lights up while the engine is running.</p>	<p>There may be a malfunction, for example:</p> <ul style="list-style-type: none"> • in the engine management • in the fuel injection system • in the exhaust system • in the ignition system • the fuel system <p>The emission limit values may be exceeded and the engine may be running in emergency mode.</p> <p>► Have the vehicle checked as soon as possible at a qualified specialist workshop.</p> <p>i In some states/provinces, you are required by law to immediately visit a qualified specialist workshop as soon as the yellow Check Engine warning lamp lights up. If in doubt, check whether such legal regulations apply in the state/province in which you are currently driving.</p>
<p> (USA only)  (Canada only)</p> <p>The yellow engine diagnostics warning lamp lights up while the engine is running.</p>	<p>The fuel system pressure is too low. The fuel filler cap is not closed correctly or the fuel system is leaking.</p> <p>► Check that the fuel filler cap is correctly closed.</p> <p>► If the fuel filler cap is not correctly closed: close the fuel filler cap.</p> <p>► If the fuel filler cap is closed: visit a qualified specialist workshop.</p>
<p>The yellow reserve fuel warning lamp lights up while the engine is running.</p>	<p>The fuel filler cap is not correctly closed.</p> <p>► Check that the fuel filler cap is correctly closed.</p> <p>► If the fuel filler cap is not correctly closed: close the fuel filler cap.</p> <p>► If the fuel filler cap is closed: visit a qualified specialist workshop.</p>
<p>The yellow reserve fuel warning lamp lights up while the engine is running.</p>	<p>The fuel level has dropped into the reserve range.</p> <p>► Refuel at the nearest gas station.</p>

Tires	
Problem	Possible causes/consequences and ► Solutions
 USA only: The yellow tire pressure monitor warning lamp (pressure loss/malfunction) is lit. Canada only: The yellow tire pressure monitor warning lamp (pressure loss) is lit.	 Risk of accident The tire pressure monitor has detected a loss of pressure in at least one of the tires. <ul style="list-style-type: none"> ► Stop the vehicle without making any sudden steering or braking maneuvers. Pay attention to the traffic conditions as you do so. ► Observe the additional display messages in the multifunction display. ► Check the tire pressure. If necessary, correct the tire pressure (► page 253). ► If necessary, change a wheel (► page 269).
 USA only: The yellow tire pressure monitor warning lamp (pressure loss/malfunction) flashes for 60 seconds and then remains lit.	The tire pressure monitor is defective. <ul style="list-style-type: none"> ► Observe the additional display messages in the multifunction display. ► Visit a qualified specialist workshop.

Warning

Each tire, including the spare tire (if there is one), should be inspected at least every two weeks when they are cold and pumped to the pressure recommended by the vehicle manufacturer (see the tire and load data label on the B-pillar on the driver's side or the tire pressure table on the inside of the fuel filler flap of your vehicle, if there is one). If your vehicle has tires which are a different size to those on the tire and load data label or those specified in the tire pressure table, if there is one, you should determine the correct tire pressure for these tires.

As an added safety feature, your vehicle has been equipped with a tire pressure monitor (TPMS). An indicator lamp lights up if one or more of your tires are significantly underinflated. Accordingly, when the low tire pressure indicator lamp lights up, you should stop and check your tires as soon as possible, and inflate them to the proper pressure. Driving on a significantly underinflated tire causes the tire to overheat and can lead to tire failure.

An excessively low tire pressure also increases fuel consumption, reduces the service life of the tires and may impair the driving and braking characteristics of the vehicle. Please note that the TPMS is not a substitute for proper tire maintenance and it is the driver's responsibility to maintain correct tire pressure, even if underinflation has not reached the level at which the low tire pressure indicator lamp of the TPMS lights up.

USA only:

Your vehicle has also been equipped with a TPMS malfunction indicator to indicate when the system is not operating properly. The TPMS malfunction indicator is combined with the low tire pressure indicator lamp. When the system detects a malfunction, the indicator lamp will flash

for approximately one minute and then remain illuminated. This sequence will continue upon subsequent vehicle start-ups as long as the malfunction exists. When the malfunction indicator is lit, the system may not be able to detect or signal low tire pressure as intended.

TPMS malfunctions may occur for a variety of reasons, including the installation of incompatible replacement or alternate tires or wheels on the vehicle that prevent the TPMS from functioning properly. Always check the TPMS malfunction indicator after replacing one or more tires or wheels on your vehicle to ensure that the replacement or alternate tires and wheels allow the TPMS to continue to function properly.

Vehicle equipment	192
Loading guidelines	192
Stowage compartments	193
Stowage areas	194
Features	197

Vehicle equipment

- i** This manual describes all the standard and optional equipment of your vehicle which was available at the time of purchase. Country-specific differences are possible. Please note that your vehicle may not be equipped with all features described. This also applies to safety-relevant systems and functions.

Loading guidelines

⚠ Warning!

Always fasten items being carried as securely as possible using cargo tie-down rings and fastening materials appropriate for the weight and size of the load.

In an accident, during hard braking or sudden maneuvers, loose items will be thrown around inside the vehicle. This can cause injury to vehicle occupants unless the items are securely fastened in the vehicle.

To help avoid personal injury during a collision or sudden maneuver, exercise care when transporting cargo. Do not pile luggage or cargo higher than the seat backrests.

Never drive a vehicle with the tailgate open. Deadly carbon monoxide (CO) gases may enter vehicle interior resulting in unconsciousness and death.

The handling characteristics of a laden vehicle are dependent on the distribution of the load within the vehicle. You should therefore load your vehicle as shown in the illustrations.

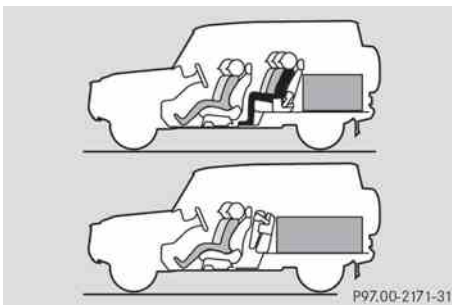

Load distribution

The gross vehicle weight (GVW) is the vehicle weight including fuel, vehicle tool kit, spare wheel, accessories fitted, vehicle occupants and luggage/load.

The gross load limit and the gross vehicle weight rating (GVWR) for your vehicle must never be exceeded. The gross load limit and the GVWR are specified on the vehicle identification plate on the B-pillar of the driver's door (> page 275).

The load must also be distributed so that the weight on each axle never exceeds the gross axle weight rating (GAWR) for the front and rear axles. The specifications for GVWR and GAWR are on the vehicle identification plate on the B-pillar of the driver's door (> page 275).

Further information can be found in the "Loading the vehicle" section (> page 256).

Observe the following notes when transporting a load:

- position heavy loads as far forwards as possible and as low down in the cargo compartment as possible.
- i** Transport loads when possible in the cargo compartment. You should only use the cargo compartment enlargement if the load does not fit in the cargo compartment.
- always place the load against the front or rear seat backrests.



- if the rear bench seat is not occupied, insert the belt tongue on the outer seat belts into the buckle of opposite seat belt ①.
- secure the load with sufficiently strong and wear-resistant tie down. Pad sharp edges for protection.

Stowage compartments

Important safety notes

Warning!

To help avoid personal injury during a collision or sudden maneuver, exercise care when storing objects in the vehicle. Put luggage or cargo in the cargo compartment if possible. Do not pile luggage or cargo higher than the seat backrests.

Keep compartment lids closed. This will help to prevent stored objects from being thrown about and injuring vehicle occupants during

- braking
- vehicle maneuvers
- an accident

Front stowage compartments

Glove box

i Depending on the vehicle's equipment, you will find an AUX-IN jack or a Media Interface installed in the glove box. A Media Interface is a universal interface for portable audio equipment, e.g. for an

iPod® or USB device (see the separate Audio or COMAND operating instructions).

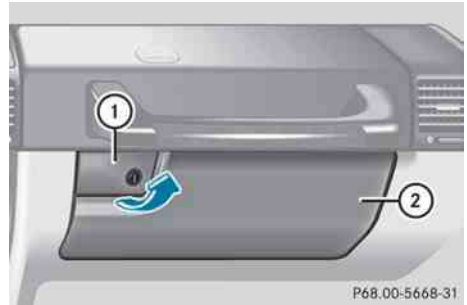

- ▶ **To open:** pull handle ① and open glove box flap ②.
- ▶ **To close:** fold glove box flap ② upwards until it engages.

The glove box can only be locked and unlocked using the mechanical key.

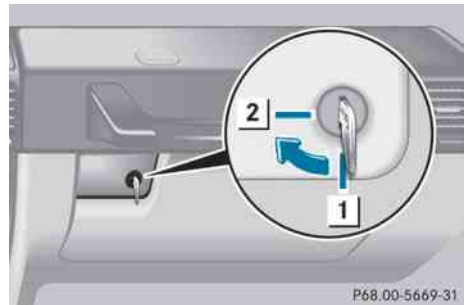

- ① Glove box unlocked
- ② Glove box locked



- ▶ **To lock:** insert the mechanical key (▷ page 63) into the lock and turn it 90° clockwise to position ②.
- ▶ **To unlock:** insert the mechanical key (▷ page 63) into the lock and turn it 90° counter-clockwise to position ①.

Stowage compartment/telephone compartment under the armrest/in the center console.

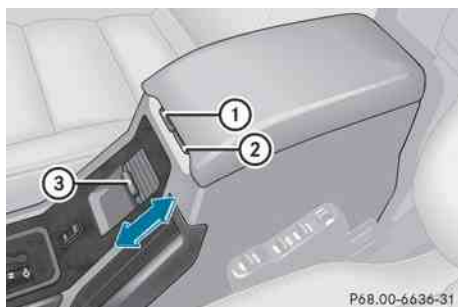
Under the armrest is a shallow stowage tray (telephone compartment), under which is a deeper stowage compartment.



- ▶ **To open the stowage tray (telephone compartment):** press button ① and raise the armrest.
- ▶ **To open the stowage compartment:** press button ② and raise the armrest. The stowage tray is raised together with the armrest.
- ▶ **To open the stowage compartment in the center console:** slide cover ③ back using the handle.

i The  (▷ page 204) Roadside Assistance call button and  (▷ page 205) MB Info call button are located in the stowage compartment under the armrest.

Rear stowage compartments

Stowage pockets

Warning!

Storage bags are intended for storing light-weight items only.

Heavy objects, objects with sharp edges or fragile objects may not be transported in the storage bag. In an accident, during hard braking, or sudden maneuvers, they could be thrown around inside the vehicle and cause injury to vehicle occupants.

Storage bags cannot protect transported goods in the event of an accident.

The stowage pockets are located on the rear side of the front seats.

Stowage areas

Parcel nets

Warning

Parcel nets are intended for storing light-weight items only, such as road maps, mail, etc.

Heavy objects, objects with sharp edges, or fragile objects may not be transported in the parcel nets. In an accident, during hard braking, or sudden maneuvers, they could be thrown around inside the vehicle and cause injury to vehicle occupants.

Parcel nets cannot protect transported goods in the event of an accident.

The parcel nets are located in the front-passenger footwell.

Enlarging the cargo compartment

Important safety notes

Warning!

Always lock the seat backrest in its upright position when the rear seat bench is occupied, or the extended cargo volume is not in use.

Check for secure locking by pushing and pulling on the seat backrest.

In an accident, during hard braking or sudden maneuvers, loose items will be thrown around inside the vehicle. This can cause injury to vehicle occupants unless the items are securely fastened in the vehicle.

To help avoid personal injury during a collision or sudden maneuver, exercise care when transporting cargo.

Warning!

Failure to assure that the seat bench and seat backrests are locked into place could result in an increased chance of injury in an accident.

Never place hands under seat or near any moving parts while a seat is being adjusted. For safety reasons, the rear seat bench must only be adjusted when the vehicle is stationary.

Never drive a vehicle with the tailgate open. Deadly carbon monoxide (CO) gases may enter vehicle interior resulting in unconsciousness and death.

- ❗ Ensure that you remove all containers from the cup holder in the rear before folding the seat backrest and the seat cushion of the rear bench seat forwards.

The left-hand and right-hand rear seats can be folded down to increase the cargo compartment capacity. The following changes are possible:

- fold the seat backrests forward
- fold the rear bench seat back fully.

Folding the seat backrest forwards

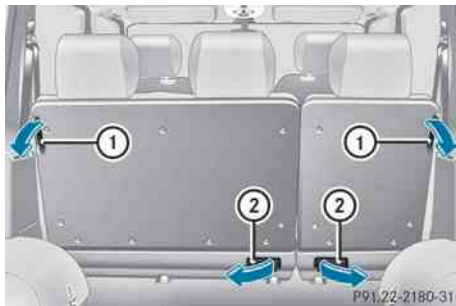

- ① Seat backrest release lever
- ② Rear bench seat release lever

- ❗ Open the rear doors. This allows you better access to release lever ①.
- ▶ Remove the center head restraint (▷ page 80).
- ▶ Pull release lever ①.
The corresponding seat backrest is released.
- ▶ Fold the seat backrest forward until it engages.

Folding back the seat backrest

- ▶ Pull release lever ① and fold the seat backrest up.
- ❗ Make sure that the seat belt does not become trapped when folding the rear seat backrest back. Otherwise, it could be damaged.
- ▶ Fold the seat backrest back until it engages audibly in the seat catch.
- ▶ Install the head restraint.

Folding the rear bench seat forwards

- ▶ Fold the seat backrest forward (▷ page 195).
- ▶ Pull release lever ②.
The corresponding rear bench seat is released.
- ▶ Fold the rear bench seat forward until it engages.

Folding rear bench seat into an upright position

- ▶ Fold back the rear bench seat backrest until it engages audibly in the seat catch.
- ▶ Fold back the seat backrest (▷ page 195).
- ▶ Install the head restraints.

⚠ Warning

Make sure that the rear bench seat and front seat backrest are correctly engaged in position.

If the seat backrests or rear bench seat are not fully engaged and the following occurs:

- sharp braking
- a sudden change of direction
- an accident

the seat backrests or rear bench seat may fold forwards and instead of being restrained by the seats as intended you could be injured by them. Occupants could then also be injured in the event of an accident, e.g. by objects

being thrown forwards from the cargo compartment.

Securing a load

Lashing eyelets

Warning

Distribute the load on the cargo tie down rings evenly.

Otherwise, vehicle occupants could be injured by objects being thrown around if you:

- brake sharply
- change direction suddenly
- are involved in an accident

Please observe the loading guidelines.

Observe the following notes on securing loads:

- secure the load using the cargo tie down rings.
- do not use elastic straps or nets to secure a load, as these are only intended as an anti-slip protection for light loads.
- do not route tie downs across sharp edges or corners.
- pad sharp edges for protection.

There are four cargo tie down rings in the cargo compartment mounted at the sides.



Cargo compartment cover

Important safety notes

! When loading the vehicle, make sure that you do not stack the load in the cargo compartment higher than the lower edge of the side windows. Do not place heavy objects on top of the cargo compartment cover.

The cargo compartment cover is located behind the rear bench seat backrest.

Opening and closing the cargo compartment cover

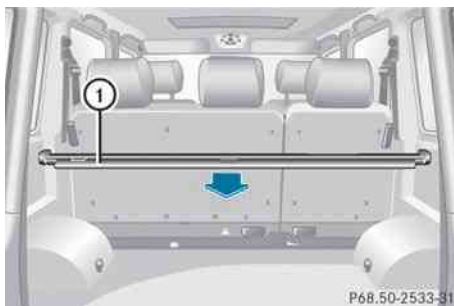

- ▶ **To open:** pull cargo compartment cover ① back and clip it into the retainers on the left and right of the rear door.
- ▶ **To close:** unclip cargo compartment cover ① and guide it forwards until it is completely rolled up.

Installing/removing the cargo compartment cover

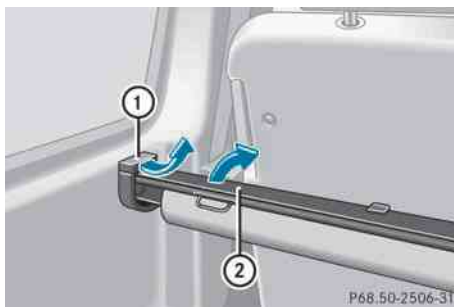

- ▶ **To remove:** make sure that cargo compartment cover ② is rolled up.
- ▶ Slide catches ① on the left-hand and right-hand sides of cargo compartment cover ② towards the center of the vehicle.
- ▶ Swing cargo compartment cover ② up and out.
- ▶ **To install:** slide catches ① towards the center of the vehicle.
- ▶ Insert cargo compartment cover ② into the recesses in the side trim.
- ▶ Press the right and left sides of cargo compartment cover ② downwards until cargo compartment cover ② engages.
- ▶ Slide catches ① in the direction of the side trim.

Roof carrier

The roof is not suited for transporting loads. Never use roof rails or other accessories mounted on the roof.

Warning!

Do not load items on the roof. It may cause instability during some maneuvers which could result in an accident.

Features

Cup holders

Important safety notes

Warning

In order to help prevent spilling liquids on vehicle occupants and/or vehicle equipment, only use containers that fit into the cup holder. Use lids on open containers and do not fill containers to a height where the contents, especially hot liquids, could spill during braking, vehicle maneuvers, or in an accident. Liquids spilled on vehicle occupants may cause serious personal injury. Liquids spilled on vehicle equipment may cause

damage not covered by the Mercedes-Benz Limited Warranty.

When not in use, keep the cup holder closed. An open cup holder may cause injury to you or others when contacted during braking, vehicle maneuvers, or in an accident.

Keep in mind that objects placed in the cup holder may come loose during braking, vehicle maneuvers, or in an accident and be thrown around in the vehicle interior. Objects thrown around in the vehicle interior may cause an accident and/or serious personal injury.

Cup holder on the center console



- ▶ Fold cup holder ① all the way up.

- ⚠ **!** Make sure that the cup holder on the center console is folded down before you move the front-passenger seat forwards.

Cup holder on the armrest

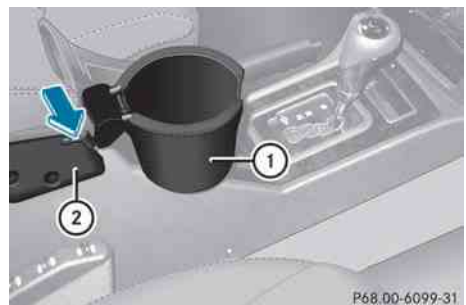

- ▶ Insert cup holder ① as shown with the arrow into the fixture of carrier bar ②.

If you do not require the cup holder, it can be stored in the glove box or in the stowage compartment in the center console, for example.

Cup holders in the rear compartment



! Ensure that you remove all containers from the cup holder in the rear before folding the seat backrest and the seat cushion of the rear bench seat forwards.

Sun visors

Overview of sun visors

Warning

Do not use the vanity mirror while driving. Keep the vanity mirrors in the sun visors closed while the vehicle is in motion. Reflected glare can endanger you and others.

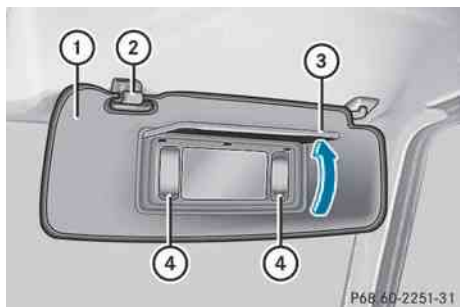

- ① Sun visor
- ② Bracket

- ③ Mirror cover
- ④ Mirror light

Glare from the side

- ▶ Fold down sun visor ①.
- ▶ Pull sun visor ① from bracket ②.
- ▶ Swing sun visor ① to the side.

Vanity mirror in the sun visor

Mirror lights ④ will only function if the sun visor is clipped into bracket ②.

- ▶ Fold down sun visor ①.
 - ▶ Fold up mirror cover ③.
- Mirror lights ④ are switched on automatically.

Ashtray

Ashtray in the cockpit

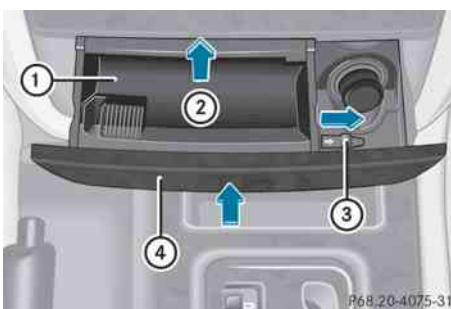

- ▶ **To open:** press cover ④ and then release it. Ashtray ① folds out.
- ▶ **To remove insert:** make sure that the vehicle is secured against rolling away by applying the parking brake.
- ▶ Move the selector lever to **N**.
- ▶ Move slide knob ③ to the right, so that insert ② is released.
- ▶ Pull insert ② upwards and remove it.

- ▶ **To re-install the insert:** press insert ② into the holder until it engages.
- ▶ **To close:** press cover ④ until it engages.

Ashtray in the rear compartment

An ashtray is located in each of the rear doors.

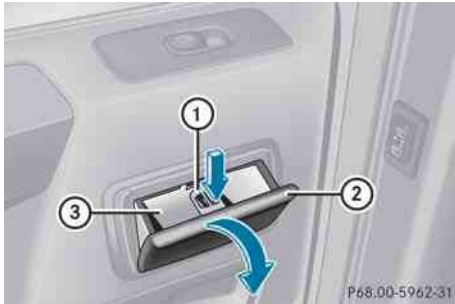

- ▶ **To open:** fold cover ② out in the direction of the arrow.
- ▶ **To remove the insert:** press retaining lug ① and pull insert ③ upwards and out.
- ▶ **To re-install the insert:** replace insert ③ from above.
- ▶ **To close:** close cover ② fully.

Cigarette lighter

Warning

When leaving the vehicle, always remove the SmartKey from the ignition lock. Always take the SmartKey with you and lock the vehicle. Do not leave children unattended in the vehicle, even if they are secured in a child restraint system, or with access to an unlocked vehicle. A child's unsupervised access to a vehicle could result in an accident and/or serious personal injury. The children could:

- injure themselves on parts of the vehicle
- be seriously or fatally injured through excessive exposure to extreme heat or cold
- injure themselves or cause an accident with vehicle equipment that can be operated even if the SmartKey is removed from the ignition lock or removed from the vehicle, such as seat adjustment, steering wheel adjustment, or the memory function

If children open a door, they could injure other persons or get out of the vehicle and injure themselves or be injured by following traffic. Do not expose the child restraint system to direct sunlight. The child restraint system's metal parts, for example, could become very hot, and the child could be burned on these parts.

Warning

Never touch the heating element or sides of the lighter; they are extremely hot. Hold the knob only.

Make sure any children traveling with you do not injure themselves or start a fire with the hot cigarette lighter.

- ❗ The 12 V socket in the cigarette lighter can be used for accessories (up to a maximum of 180 W), as long as they have the standard socket type for cigarette lighters. Note that the socket in the cigarette lighter can be damaged when connecting accessories, for example by

frequent insertion and removal or by sockets that do not fit correctly. A damaged socket can cause the cigarette lighter to stop working.



- ▶ Press cover ② and then release it. The ashtray and cigarette lighter ① fold out.
- ▶ Press in cigarette lighter ①. Cigarette lighter ① will pop out automatically when the heating element is red-hot.

12 V sockets

Points to observe before use

! If you are using all sockets in the vehicle, make sure that you do not exceed the maximum current draw of 45 A. Otherwise, you will overload the fuses.

The sockets can be used for accessories with a maximum power consumption of 180 W (15 A), e.g. lamps or for mobile phones.

If you use the sockets for long periods when the engine is switched off, the battery may discharge.

- ▶ Turn the key to position **2** in the ignition lock.

Socket in the front-passenger footwell



- ▶ Lift up the cover of the socket.

The cigarette lighter socket can be also used (> page 199). It can also be used if the key has been removed from the ignition lock.

Socket in the rear compartment

The socket is located on the center console in the rear compartment.



- ▶ Lift up the cover of the socket.

Socket in the cargo compartment

The socket is located in the cargo compartment on the left-hand-side, next to the rear door.



P68.00-5963-31



P82.10-5992-31

- ▶ Lift up the cover of the socket.

115 V power socket

Warning!

The 115V AC socket operates at high voltage. Use the 115V AC socket in the vehicle with the same caution and prudence that you exercise when using power outlets at home. Keep any fluids away from the 115V AC socket. Do not clean the socket with fluids or tapered objects. Keep the 115V AC socket cover in the closed position, when not in use. Otherwise, you could suffer an electric shock and be seriously or even fatally injured.

Warning!

A device that you connect must have a suitable plug that complies with U.S. standards. Never pull on the cable to unplug a plug from the 115V AC socket. Do not use a damaged connection cable. The 115V AC socket may not be connected to another 115V AC power source. Do not use converters to a grounding plug with the 115V AC socket. This could cause serious personal injury to you and/or others.

Warning!

If the 115V AC socket is damaged or torn out of the trim, do not use or touch the 115V AC socket. Using a 115V AC socket that is damaged or torn out of the trim could cause serious personal injury to you and/or others.

115 V power socket ① provides an alternating voltage of 115 V, so that small electronic devices can be connected. These devices, such as games consoles, chargers and laptops, should not consume more than a maximum of 150 W altogether.

Requirements for operation of these devices:

- the 12 V sockets in the rear compartment and the cargo compartment are operational (▷ page 200).
- the plug of the electronic device is plugged into 115 V power socket ①.
- the on-board voltage is within a permissible voltage range.
- the electronic device's maximum power output does not exceed 150 W.

- ▶ Open flap ③.
- ▶ Switch the ignition on.
- ▶ Insert the plug of the electronic device into 115 V power socket ①. Indicator lamp ② lights up.

If indicator lamp ② does not light up, please read the chapter on malfunctions.

- ▶ **To turn off:** disconnect the plug from 115 V power socket ①. Ensure that you do not pull on the cord.
- ▶ Close flap ③.

Possible causes of malfunction:

- the on-board voltage is not within a permissible voltage range.
- the temperature of the DC/AC converter is temporarily too high.
- some small electronic devices have a constant nominal power of less than 150 W, but a very high switch-on current. In that case, there is a possibility that these devices will not function properly as 115 V socket ① is not able to provide a high enough current.

If indicator lamp ② still does not light up, consult a qualified specialist workshop, e.g. an authorized Mercedes-Benz Center.

mbrace¹⁵

Important safety notes

! A license agreement must exist in order to activate the mbrace service. Make sure that your system is activated and ready for use, and press the  MB info call button to register. If you cannot carry out any of the steps mentioned, the system may not be activated.

If you have any questions concerning activation, please contact one of the following service hotlines:

- **USA:** Response Center under 1-888-990-9007
- **Canada:** Customer Service under 1-888-923-8367

Shortly after successfully registering with the mbrace service, a user ID and password will be sent to you by post. You can use this password to log in to the mbrace section under "Owners Online" at <http://www.mbusa.com>¹⁶.

The mbrace system is available if:

- it has been activated and is operational. Activation requires an available mobile phone network, a valid SIM card and a service subscription to a surveillance service provider.
- the battery is sufficiently charged.
- the corresponding mobile phone network is available for transmitting data to the Customer Center.



i Determining the location of the vehicle on a map is only possible if there is sufficient GPS reception and the vehicle position can be forwarded to the Customer Center.

The mbrace system

The mbrace system provides three different services:

- automatic and manual emergency call
- Roadside Assistance call
- MB Info call

To adjust the volume during an mbrace call, proceed as follows:

▶ Press the  or  button on the multifunction steering wheel.

or

▶ Use the COMAND volume controller.

You can find information and a description of all available features under "Owners Online" at <http://www.mbusa.com>¹⁷.

System self-test

After you have switched on the ignition, the system carries out a self-diagnosis.





¹⁵ The system is called TELE AID in Canada.

¹⁶ USA only.

¹⁷ USA only.

 **Warning**

A malfunction in the system has been detected if any or all of the following conditions occur:

- The indicator lamp in the SOS button does not come on during the system self-test.
- The indicator lamp in Roadside Assistance button  does not come on during the system self-test.
- The indicator lamp in Information button  does not come on during the system self-test.
- The indicator lamp in the SOS button, Roadside Assistance button , or Information button  remains illuminated constantly in red after the system self-test.
- The message **Tele Aid Inoperative** or **Tele Aid Not Activated** appears in the multifunction display after the system self-test.



If a malfunction is indicated as outlined above, the system may not operate as expected. In case of an emergency, help will have to be summoned by other means.

Have the system checked at the nearest authorized Mercedes-Benz Center or contact the following service hotlines:

- **USA:** Response Center under the number 1-888-990-9007
- **Canada:** Customer Service under 1-888-923-8367

Emergency call

Important safety notes

 A license agreement must exist in order to activate the mbrace service. Make sure that your system is activated and ready for use, and press the  MB info call button to register. If you cannot carry out any of the steps mentioned, the system may not be activated.

If you have any questions concerning activation, please contact one of the following service hotlines:

- **USA:** Response Center under 1-888-990-9007
- **Canada:** Customer Service under 1-888-923-8367

An emergency call is dialed automatically if an air bag or Emergency Tensioning Device is triggered.

 An automatically dialed mbrace emergency call cannot be canceled.

An emergency call can also be initiated manually.

As soon as the emergency call has been initiated, the indicator lamp in the SOS button flashes. The **Connecting Call** message appears on the multifunction display.

COMAND is muted.

Once a connection has been established, the **Call Connected** message appears in the multifunction display.

All important information on the emergency is provided, for example:

- current location of the vehicle (as determined by the GPS system)
- vehicle model
- vehicle color
- vehicle identification number

A short time after the emergency call is initiated, a voice connection is automatically established between the Response Center and the vehicle occupants. If the vehicle occupants are able to respond, the Response Center will attempt to obtain more detailed information on the emergency.

 If no vehicle occupant answers, an ambulance is immediately sent to the vehicle.

 **Warning**

If the indicator lamp in the SOS button is flashing continuously and there was no voice connection to the Response Center

established, then the mbrace system could not initiate an emergency call (e.g. the relevant cellular phone network is not available).

The message **Call Failed** appears in the multifunction display for approximately 10 seconds.

Should this occur, assistance must be summoned by other means.

Making an emergency call



- ▶ **To initiate an emergency call manually:** press cover ① briefly to open it.
- ▶ Press SOS button ② briefly. The indicator lamp in SOS button ② flashes until the emergency call is concluded.
- ▶ Wait for the voice connection with the Response Center.
- ▶ After the emergency call is ended, close cover ①.

Warning

If you feel at any way in jeopardy when in the vehicle (e.g. smoke or fire in the vehicle, vehicle in a dangerous road location), please do not wait for voice contact after you have pressed the SOS button. Carefully leave the vehicle and move to a safe location. The Response Center will automatically contact local emergency officials with the vehicle's approximate location if they receive an automatic SOS signal and cannot make voice contact with the vehicle occupants.

Roadside Assistance button

- ▶ Open the stowage space under the armrest (▷ page 193).

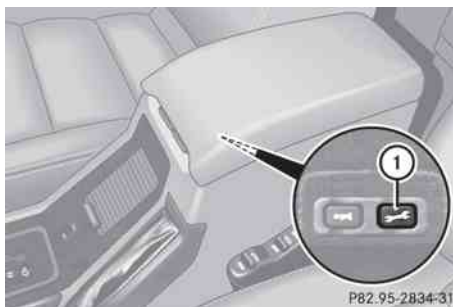

- ▶ Press and hold Roadside Assistance button ① for more than two seconds. A call to a Mercedes-Benz Roadside Assistance Representative is initiated. The indicator lamp in Roadside Assistance button ① flashes while the call is active. The **Connecting call** message appears in the multifunction display and the COMAND system is muted.

If a connection can be established, the **Call Connected** message appears in the multifunction display.

If a mobile phone network is available and there is sufficient GPS reception, the mbrace system transmits data to the Response Center, for example:

- current location of the vehicle
- vehicle identification number
- vehicle model
- vehicle color

- ▶ **i** The COMAND display shows that an mbrace call is active. You can switch to the navigation menu by pressing the NAVI button on COMAND during the call. The voice output is not available.

A voice connection is established between the Mercedes-Benz Roadside Assistance Representative and the vehicle occupants.

- ▶ Describe the type of assistance needed.

The Mercedes-Benz Roadside Assistance Representative either sends a qualified Mercedes-Benz technician or organizes for your vehicle to be transported to the nearest authorized Mercedes-Benz Center. You may be charged for services such as repair work and/or towing. Further details are available in your mbrace manual.

i If the indicator lamp in Roadside Assistance button ① flashes continuously and no voice connection to the Response Center has been established, then the mbrace system has failed to initiate a Roadside Assistance call (e.g. the corresponding mobile phone network is not available). The **Call Failed** message appears in the multifunction display.

▶ **To end a call:** press the  button on the multifunction steering wheel.

or

▶ Press the corresponding button for ending a phone call on COMAND.

i Sign and Drive services¹⁸: you are not charged for services such as jump-starting, providing a few gallons of fuel for a fuel tank that has been run dry or changing a flat tire with the vehicle's own spare wheel.

MB Info call button

▶ Open the stowage space under the armrest (▷ page 193).

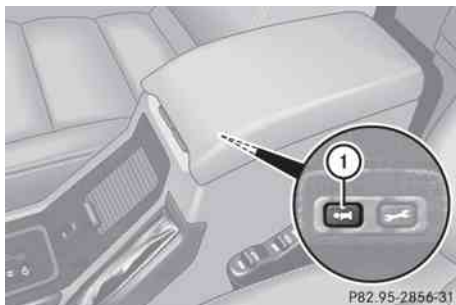

▶ Press and hold MB Info call button ① for more than two seconds. A call to the Response Center is initiated. MB Info call button ① indicator lamp flashes while the connection is being established. The **Connecting call** message appears in the multifunction display and the COMAND system is muted.

If a connection can be established, the **Call Connected** message appears in the multifunction display.

If a mobile phone network is available and there is sufficient GPS reception, the mbrace system transmits data to the Response Center, for example:

- current location of the vehicle
- vehicle identification number
- vehicle model
- vehicle color

i The COMAND display shows that an mbrace call is active. You can switch to the navigation menu by pressing the NAVI button on COMAND during the call. The voice output is not available.

A voice connection between the Response Center and the vehicle occupants is established. You can obtain information on how to operate your vehicle's systems, on the location of the nearest authorized Mercedes-Benz Center, and on further products and services offered by Mercedes-Benz USA.

Further details on the mbrace system can be found at <http://www.mbusa.com>¹⁹. Log in under "Owners Online".

i If the indicator lamp in MB Info call button ① flashes continuously and no voice connection to the Response Center has been established, then the mbrace system has failed to initiate an MB Info call (e.g. because the corresponding mobile phone network is not available). The **Call**

¹⁸ USA only.

¹⁹ USA only.

Failed message appears in the multifunction display.

- ▶ **To end a call:** press the  button on the multifunction steering wheel.
- or
- ▶ Press the corresponding button for ending a phone call on COMAND.

Call priority

When service calls are active, e.g. Roadside Assistance or MB Info calls, an emergency call can still be initiated. In this case, an emergency call has the highest priority and takes precedence over all other active calls. The indicator lamp of the respective button flashes until the call is ended. An emergency call can only be terminated by the Response Center. All other calls can be ended by pressing the  button on the multifunction steering wheel or the corresponding button for ending a telephone call on COMAND.



- i** When an mbrace call has been initiated, COMAND is muted. The mobile phone is no longer connected to COMAND. However, if you want to use your mobile phone, we recommend that you do this only when the vehicle is stationary and in a safe location.

Downloading destinations in COMAND

- i** Information on the components and operating principles of the COMAND system can be found in the separate COMAND operating instructions.

Destination Download gives you access to a database with over ten million points of interest (POIs) which can be downloaded onto the navigation system of your vehicle. If you know the destination, you can download the address or obtain the location of points of interest (POIs) or important destinations in the surrounding area.

You are prompted to confirm route guidance to the address entered.

- ▶ Select **Yes** using the  or  button on COMAND.
- ▶ Press  on COMAND to confirm.

The system calculates the route and subsequently starts the route guidance with the address entered.

- i** If you select **No**, the address can be stored in the address book.
- i** The Destination Download function is available if the corresponding mobile phone network is available and data transfer is possible.

Search & Send

"Search & Send" is a destination entry service. You can find further information on "Search & Send" in the separate COMAND operating instructions.

Vehicle remote unlocking

If you have unintentionally locked your vehicle (e.g. the SmartKey is inside the vehicle) and a replacement key is not available:

- ▶ Contact the following service hotlines:
 - **USA:** Response Center at 1-888-990-9007
 - **Canada:** Customer Service at 1-888-923-8367
 You will be asked for your password.
- ▶ Return to your vehicle at the time arranged with the Response Center.
- ▶ Press and hold the release button on the rear door handle for at least 20 seconds until the indicator lamp in the SOS button ([▷ page 203](#)) begins flashing. The **Connecting Call** message appears on the multifunction display.

Alternatively, the vehicle can also be opened via the Internet in the "Owners Online"

section using your ID number and password²⁰.

- i** Vehicle remote unlocking is only possible if the corresponding mobile phone network is accessible.

The SOS button flashes and the **Connecting Call** message appears in the multifunction display to confirm that the command for vehicle remote unlocking has been received.

If you press the rear door's locking cylinder for more than 20 seconds before receiving authorization for remote unlocking, you must wait 15 minutes before you can press the rear door's locking cylinder again.

Service for recovering stolen vehicles

If your vehicle has been stolen:

- ▶ Contact the police.
The police will issue an incident report. This report has a number.
- ▶ Forward this number to the Response Center together with your PIN.
The Response Center will then attempt to covertly contact the mbrace system. The Response Center contacts you and the local law enforcement authority if the vehicle is located. However, only the law enforcement is informed of the location of the vehicle.
- i** If the anti-theft alarm system remains activated for longer than thirty seconds, mbrace is automatically connected to the Response Center.

Brush guard (USA only)

Warning

The brush guard is designed solely to enhance the appearance of the vehicle and help protect grille and headlamps from minor mishaps, either on or off road.

Since the safety characteristics are limited in the event of an accident, brush guard are not intended to prevent injury or damage in the event of an accident. Also observe state and local regulations on installation and use. Raise and lower the brush guard in an open space with plenty of room.



Example: G 55 AMG with brush guard

- !** Only drive when the brush guard is folded up and locked.
Only fold down the brush guard to replace a bulb, for example.

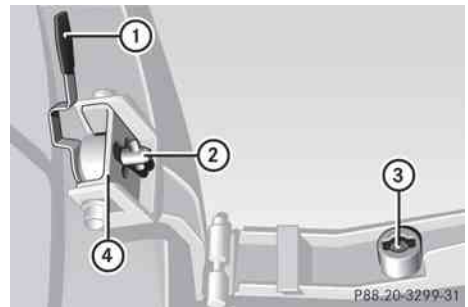

- i** Keep hold of the brush guard when releasing it. It will otherwise swing downwards immediately.
- ▶ **To swing down:** release both quick-release fasteners ② using wrench ①.
- ▶ Slowly guide the brush guard downwards.

²⁰ USA only.

- ▶ **To swing up and secure:** swing the brush guard up to stop joint ④ and hold it in place.
The pins of quick-release fasteners ② need to engage in the openings in lock ③.
 - ▶ Lock quick-release fasteners ② on both sides using wrench ①.
- !** Make sure that the pins of the quick-release fasteners are securely engaged in the lock on both sides.

Garage door opener

Important safety notes

You can use the HomeLink® garage door opener integrated into the rear-view mirror to operate up to three different gate/garage door opener systems.

i Certain garage door drives are incompatible with the integrated garage door opener. If you experience difficulties programming the integrated garage door opener, contact an authorized Mercedes-Benz Center. You can also contact the following service hotlines:

- **USA:** Mercedes-Benz Customer Assistance Center under 1-800-FOR-MERCEdes
- **Canada:** Customer Service under 1-800-387-0100

⚠ Warning

Before programming the integrated remote control to a garage door opener or gate operator, make sure people and objects are out of the way of the device to prevent potential harm or damage. When programming a garage door opener, the door moves up or down. When programming a gate operator, the gate opens or closes.

Do not use the integrated remote control with any garage door opener that lacks safety stop and reverse features as required by U.S. federal safety standards (this includes any

garage door opener model manufactured before April 1, 1982). A garage door that cannot detect an object - signaling the door to stop and reverse - does not meet current U.S. federal safety standards.

When programming a garage door opener, park vehicle outside the garage.

Do not run the engine while programming the integrated remote control. Inhalation of exhaust gas is hazardous to your health. All exhaust gas contains carbon monoxide (CO), and inhaling it can cause unconsciousness and possible death. All exhaust gas contains carbon monoxide (CO), and inhaling it can cause unconsciousness and possible death.

i USA only:

This device complies with part 15 of the FCC requirements. Operation is subject to the following two conditions:

1. The device must not cause harmful interference.
2. The device must withstand any interference received, including interference that may cause undesired operation.

Unauthorized modification of this device could void the device's operating permit.

i Canada only:

This device complies with the RSS-210 requirements of Industry Canada. Operation is subject to the following two conditions:

1. The device must not cause harmful interference.
2. The device must withstand any interference received, including interference that may cause undesired operation.

Unauthorized modification of this device could void the user's authority to legally operate the device.

Programming the remote control

Programming

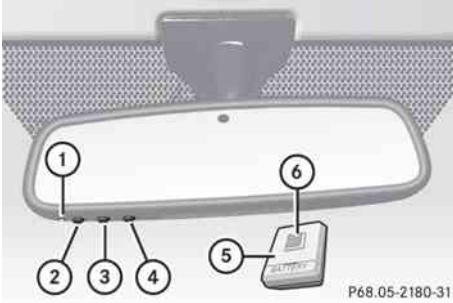

Remote control in the rear-view mirror

Garage door remote control (5) is not part of the garage door opener.

- i** To achieve the best result, insert new batteries in garage door remote control (5) of your garage door drive before programming.
- ▶ Erase the memory of the integrated remote control (▶ page 211) before programming it for the first time.
- ▶ Turn the SmartKey to position **2** in the ignition lock.
- ▶ Press and hold one of transmitter buttons (2) to (4) on the integrated remote control. After a short time, indicator lamp (1) will start flashing. It flashes about once per second.
- i** Indicator lamp (1) flashes immediately the first time that the transmitter button is programmed. If this transmitter button has already been programmed, indicator lamp (1) will only start flashing at a rate of once a second after 20 seconds have elapsed.
- ▶ Keep the transmitter button depressed.
- ▶ Point garage door remote control (5) with transmitter button (6) toward the transmitter buttons on the rear-view mirror at a distance of 2 to 12 inches (5 to 30 cm).

- i** The distance between garage door remote control (5) and the integrated garage door opener depends on the system of the garage door drive. You might require several attempts. You should test every position for at least 20 seconds before trying another position.
- ▶ Keep transmitter button (6) on garage door remote control (5) pressed until indicator lamp (1) starts to flash rapidly. The programming has been successful if indicator lamp (1) flashes rapidly.
- ▶ Release transmitter buttons (2), (3) or (4) on the integrated remote control and transmitter button (6) on the garage door remote control.

If indicator lamp (1) goes out after approximately 20 seconds and has not flashed rapidly:

- ▶ Release transmitter buttons (2), (3) or (4) on the integrated remote control and transmitter button (6) on the garage door remote control.
- ▶ Repeat the procedure for the other transmitter buttons. When doing so, vary the distance between the garage door's remote control and the transmitter buttons in the rear-view mirror.

- i** If the garage door system works with a rolling code, you must synchronize the remote control integrated into the rear-view mirror with the garage door system receiver after programming. You will find further information in the garage door opening system's operating instructions, e.g. the sections on "Synchronizing the transmitter" or "Registering a new transmitter". You can also call the hotline mentioned above.

Notes on programming the remote control

Canadian radio frequency laws require a "break" (or interruption) of the transmission signals a few seconds after broadcasting.

Therefore, these signals may not last long enough for the integrated remote control to recognize the signal during programming. Comparable with Canadian law, some U.S. garage door openers also have a built-in "interruption".

If you live in Canada or have difficulties programming the garage door opener (regardless of where you live) when using the programming steps (see above), proceed as follows:

- ▶ Press transmitter button (②, ③ or ④) and hold it down during the following steps until the setup has been completed successfully.
- ▶ At the same time, press transmitter button ⑥ of the garage door remote control for two seconds, then release it for two seconds, then press it again for two seconds.
- ▶ Repeat this sequence on transmitter button ⑥ of the garage door remote control until the frequency signal has been saved.
- ▶ If the setup procedure is successful, indicator lamp ① flashes once slowly and goes out after a few seconds.
- ▶ Continue with the other programming steps (see above).

Problems when programming

If you have problems when programming the integrated remote control, please note the following:

- check the transmitter frequency of garage door remote control ⑤ (which can usually be found on the rear of the remote control). The integrated remote control is compatible with devices that operate at frequencies between 280 and 390 MHz.
- replace the batteries in garage door remote control ⑤. This increases the likelihood of garage door remote control ⑤ sending a strong and precise signal to the integrated remote control on the rear-view mirror.

- when programming, hold garage door remote control ⑤ at varying distances and angles from the transmitter button which you are programming. Try different angles at a distance between 2 and 12 inches (5 to 30 cm) or the same angle at varying distances.
- if there is another garage door remote control for the same device, perform the programming steps again using that garage door opener. Before performing these steps, make sure that new batteries have been installed in the garage door remote control.
- align the antenna cable of the garage door opener unit. This can improve signal reception/transmission.

Opening/closing the garage door

Once programmed, the integrated remote control will assume the function of the garage door system's remote control. Please also read the operating instructions for the garage door system.

- ▶ Turn the SmartKey to position **2** in the ignition lock.
- ▶ Press transmitter button ②, ③ or ④ on the integrated remote control in the rear-view mirror that is programmed to operate the garage door.

Garage door system with fixed code: indicator lamp ① lights up continuously.

Garage door system with rolling code: indicator lamp ① flashes briefly and then lights up for approximately two seconds. This is repeated for up to 20 seconds.

- ① The transmitter will transmit a signal for as long as the transmitter button is being pressed. The transmission will be halted after a maximum of 20 seconds and indicator lamp ① will flash. Press the transmitter button again, if necessary.

Clearing the remote control memory

- ▶ Turn the SmartKey to position **2** in the ignition lock.
 - ▶ Press and hold transmitter buttons ② and ④ for approximately 20 seconds until indicator lamp ① flashes rapidly.
The memory is cleared.
- i** You should clear the remote control memory before selling the vehicle.

Floormat on the driver's side

Warning!

Whenever you are using a floormat, make sure there is enough clearance and that the floormat is securely fastened.

The floormat should always be securely fastened using the fastening equipment.

Before driving off, check that the floormat is securely in place and adjust it if necessary. A loose floormat could slip and hinder proper functioning of the pedals.

Do not place several floormats on top of each other as this may impair pedal movement.

Vehicle equipment	214
Engine compartment	214
Maintenance	219
Care	220

Vehicle equipment

- i** This manual describes all the standard and optional equipment of your vehicle which was available at the time of purchase. Country-specific differences are possible. Please note that your vehicle may not be equipped with all features described. This also applies to safety-relevant systems and functions.

Engine compartment

Hood

Opening the hood

Warning

Do not pull the release lever while the vehicle is in motion. Otherwise, the hood could be forced open by passing air flow.

This could cause the hood to come loose and injure you and/or others.

Warning!

Do not open the hood when the engine is overheated. You could be seriously injured. Observe the coolant temperature gauge to determine whether the engine may be overheated. If you see flames or smoke coming from the engine compartment, move away from the vehicle. Wait until the engine has cooled. If necessary, call the fire department.

Warning!

You could be injured when the hood is open – even when the engine is turned off.

Parts of the engine can become very hot. To prevent burns, let the engine cool completely before touching any components on the vehicle. Comply with all relevant safety precautions.

Warning

To help prevent personal injury, stay clear of moving parts when the hood is open and the engine is running.

The radiator fan may continue to run for approximately 30 seconds or may even restart after the engine has been turned off. Stay clear of fan blades.

Warning

The engine is equipped with a transistorized ignition system. Because of the high voltage, it is dangerous to touch any components (ignition coils, spark plug sockets, diagnostic socket) of the ignition system:

- with the engine running
- while starting the engine
- when the ignition is switched on and the engine is turned manually

- Make sure that the windshield wipers are switched off.

Warning

The windshield wipers and wiper linkage could be set in motion.

When the hood is open, you or others could be injured by the wiper linkage.

Make sure that the windshield wipers are switched off and that the SmartKey has been pulled out of the ignition lock before opening the hood.

The release lever on the hood is in the footwell on the left-hand side of the vehicle when viewed in the direction of travel.



- ▶ Pull release lever ① on the hood. The hood is released.

! Make sure that the windshield wipers are not folded away from the windshield. You could otherwise damage the windshield wipers or the hood.



- ▶ Lift the hood slightly.
- ▶ Push hood catch handle ② in the direction of the arrow and lift the hood.

Closing the hood

⚠ Warning

When closing the hood, use extreme caution not to catch hands or fingers. Be careful that you do not close the hood on anyone.

Make sure the hood is securely engaged before driving off. Do not continue driving if the hood can no longer engage after an accident, for example. The hood could otherwise come loose while the vehicle is in motion and injure you and/or others.

- ▶ Lower the hood and let it fall from a height of approximately 8 inches (20 cm).
- ▶ Check that the hood has engaged properly. If the hood can be raised slightly, it is not properly engaged. Open it again and close it with a little more force.

Engine oil

Notes on oil level

Depending on the driving style, the vehicle consumes up to 0.9 US qts.(0.8 l) of oil over a distance of 600 miles (1000 km). The oil consumption may be higher than this when the vehicle is new or if you frequently drive at high engine speeds.

Checking the oil level using the oil dipstick

On the G 55 AMG, the oil level can be checked using the on-board computer.

When checking the oil level:

- park the vehicle on a level surface.
- the engine should be switched off for approximately five minutes if the engine is at normal operating temperature.

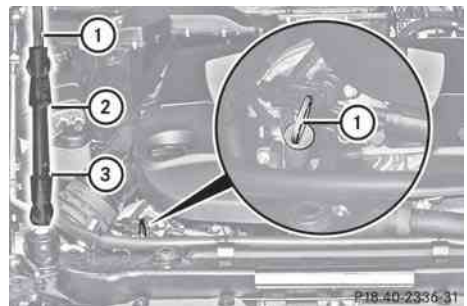

Oil dipstick (example: G 550)



- ▶ Pull oil dipstick ① out of the dipstick guide tube.
- ▶ Wipe off oil dipstick ①.

- ▶ Slowly insert oil dipstick ① into the dipstick guide tube to the stop, and take it out again.
The oil level is correct if the level is between MIN mark ③ and MAX mark ②.
- ▶ Add oil if necessary.

Checking the oil level using the on-board computer

On the G 55 AMG, the oil level can be checked using the on-board computer.

When checking the oil level:

- park the vehicle on a level surface.
- the engine should be switched off for approximately five minutes if the engine is at normal operating temperature.
- ▶ make sure that the SmartKey is in position **2** in the ignition lock.
- ▶ Press the  or  button on the steering wheel to select the following message:



The measurement takes a few seconds. You will see one of the following messages in the multifunction display:

- **Engine Oil Level OK**
- **Add 1.0 qt (Canada: 1.0 liters) to reach maximum oil level**
- **Add 1.5 qts (Canada: 1.5 liters) to reach maximum oil level**
- **Add 2.0 qts (Canada: 2.0 liters) to reach maximum oil level**
- ▶ Add oil if necessary.

If the engine is at normal operating temperature and the **Engine Oil Reduce Oil Level** message appears, the engine oil level is too high.

- ▶ Have excess oil siphoned off.

! Do not add too much oil. Adding too much oil can result in damage to the engine or the catalytic converter. Have excess oil siphoned off.

If the **Switch ignition on to check engine oil level** message appears:

- ▶ Turn the key to position **2** in the ignition lock.

If the **Observe Waiting Time** message appears:



- ▶ If the engine is at normal operating temperature: repeat the measurement after about five minutes.

If the engine is not at normal operating temperature (e.g. if the engine was only started briefly): repeat the measurement after about 30 minutes.

If the **Engine Oil Level Not With Engine On** message appears:

- ▶ Switch off the engine.
- ▶ If the engine is at normal operating temperature: wait about five minutes before carrying out the measurement.

If the engine is not at normal operating temperature, e.g. if the engine was only started briefly: wait about 30 minutes before carrying out the measurement.

- i** If you wish to cancel the measurement, press the  or  button on the multifunction steering wheel.

Adding engine oil

Environmental note

When adding oil, take care not to spill any. If oil enters the soil or waterways, it is harmful to the environment.

! Only use engine oils and oil filters which have been approved for vehicles with a service system. A list of the engine oils and oil filters that have been tested and approved according to the Mercedes-Benz specifications for service products can be found on the Internet at <http://www.mbusa.com> (USA only). Further information on tested and approved engine oils and oil filters can be obtained from any authorized Mercedes-Benz Center.

The following causes engine failure or damage to the exhaust system:

- using engine oils and oil filters that are not specifically approved for the service system
- replacing the engine oil and oil filter after having exceeded the interval for replacement prescribed by the maintenance system
- using engine oil additives

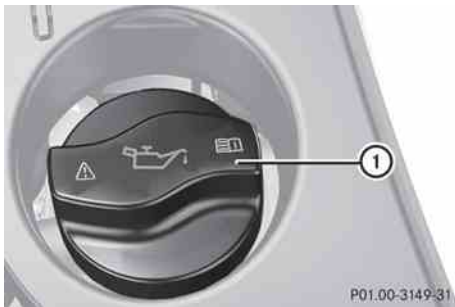

Example: engine oil cap



Engine oil cap (G 55 AMG)

- ▶ Turn cap ① counter-clockwise and remove it.
- ▶ Add the amount of oil required.

Observe the specifications in the on-board computer when doing so or fill carefully to the maximum mark on the oil dipstick.

i The difference in quantity between the MIN mark and the MAX mark on the dipstick is approximately 2.1 US qts. (2 l).

! Do not add too much oil. If the oil level is above the "max" mark on the dipstick, too much oil has been added. This can lead to damage to the engine or the catalytic converter. Have excess oil siphoned off.

For further information on engine oil, see (▷ page 279).

- ▶ Replace cap ① on the filler neck and tighten clockwise. Ensure that the cap locks into place securely.

Checking and adding other service products

Coolant level

Only check the coolant level when the vehicle is on a level surface and the engine has cooled down.

- ▶ Turn the key to position 2 (▷ page 117) in the ignition lock.
- ▶ Check the coolant temperature display in the instrument cluster. The coolant temperature must be below 158 °F (70 °C).

Warning

In order to avoid any potentially serious burns:

- use extreme caution when opening the hood if there are any signs of steam or coolant leaking from the cooling system, or

if the coolant temperature display indicates that the coolant is overheated.

- do not remove the pressure cap on the coolant reservoir if the coolant temperature is above 158 °F (70 °C). Allow the engine to cool down before removing the cap. The coolant reservoir contains hot fluid and is under pressure.
- using a rag, slowly turn the cap approximately $\frac{1}{2}$ turn to relieve excess pressure. If opened immediately, scalding hot fluid and steam will be blown out under pressure.
- do not spill antifreeze on hot engine parts. Antifreeze contains ethylene glycol which may burn if it comes into contact with hot engine parts.

The coolant expansion tank is located in the engine compartment on the right when viewed in the direction of travel.

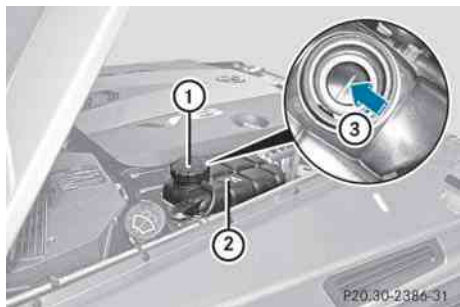

- Slowly turn cap ① half a turn counter-clockwise and allow excess pressure to escape.
- Turn cap ① further counter-clockwise and remove it.

If the coolant is at the level of marker bar ③ in the filler neck when cold, there is enough coolant in coolant expansion tank ②.

If the coolant is approximately 0.6 in (1.5 cm) above marker bar ③ in the filler neck when warm, there is enough coolant in coolant expansion tank ②.

- If necessary, add coolant that has been tested and approved by Mercedes-Benz.
- Replace cap ① and turn it clockwise as far as it will go.

For further information on coolant, see (> page 280).

Windshield washer system and headlamp cleaning system

The washer fluid reservoir is used for both the windshield washer system and the headlamp cleaning system.

Warning

Washer solvent/antifreeze is highly flammable. Do not spill washer solvent/antifreeze on hot engine parts, because it may ignite and burn. You could be seriously burned.

- At temperatures below freezing, always fill the washer fluid container with a mix of windshield washer concentrate and antifreeze additive. There is otherwise a risk of damaging the windshield washer system/headlamp cleaning system.
- Only use washer fluid concentrate which is suitable for plastic lenses. Unsuitable washer fluid concentrate could damage the plastic lenses of the headlamps.
- Do not add distilled or de-ionized water to the washer fluid container. Otherwise, the level sensor may be damaged.
- Add windshield washer concentrate, e.g. MB SummerFit, to the washer fluid all year round.

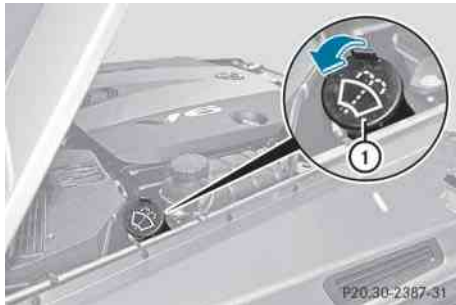

Example: washer fluid reservoir

- ▶ Mix the windshield washer fluid in a container beforehand.
- ▶ **At temperatures above freezing:** fill the washer fluid reservoir with a mix of water and windshield washer concentrate (e.g. MB SummerFit).
- ▶ **At temperatures below freezing:** fill the washer fluid container with a mix of water and MB SummerFit windshield washer concentrate. For information on the mixing ratio, see (> page 281) or use the premixed windshield washer solution with antifreeze available in specialist stores.
- ▶ **To open:** pull cap ① upwards by the tab.
- ▶ Add the premixed washer fluid.
- ▶ **To close:** press cap ① onto the filler neck until it engages.

Brake fluid level

! If you discover that the brake fluid level in the brake fluid reservoir has fallen to the MIN mark or below, check the brake system for leaks immediately. Also check the brake lining thickness. Contact a qualified specialist workshop, e.g. an authorized Mercedes-Benz Center immediately.

Do not top up the brake fluid. This will not rectify the malfunction.

Only check the brake fluid level when the vehicle is stationary and on a level surface.

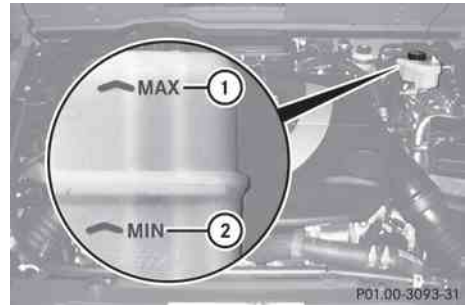

The brake fluid level is correct if it is between MIN marking ② and MAX marking ① on the brake fluid reservoir.

Maintenance

Service interval display

Service messages

Information on the type of service and service intervals (see separate Service Booklet).

You can obtain more information from an authorized Mercedes-Benz Center or at <http://www.mbusa.com> (USA only).

The service interval display informs you of the next service due date.

If a service due date has been exceeded, you also hear a warning tone.

The multifunction display shows a service message for a few seconds, e.g.

Service A In 99999 Miles

Service A Due now

Service A Exceeded By 99999 Miles

The symbol and the letter indicate which type of service is due:

 Minor service **A**

 Major service **B**

The service interval display does not take into account any periods of time during which the battery is disconnected.

Maintaining the time-dependent service schedule:

- ▶ Note down the service due date displayed before disconnecting the battery.

or:

- ▶ Subtract the battery disconnection periods from the service date shown on the display after reconnecting the battery.







- ❗ The service interval display should not be confused with the  engine oil level display.

Hiding a service message

- ▶ Press the reset button on the left of the instrument cluster (▷ page 26).

Displaying service messages

Use the buttons on the multifunction steering wheel.

- ▶ Switch on the ignition.
- ▶ Press  or  to select the **standard display** menu on the steering wheel (▷ page 160).
- ▶ Select  or  to select the service interval display.
The  or  service symbol and the service due date are displayed.

Please bear the following in mind

A qualified specialist workshop, e.g. an authorized Mercedes-Benz Center, will reset the service interval display after the necessary service work has been carried out.

You can obtain further information, e.g. regarding service work, at an authorized Mercedes-Benz Center or directly from Mercedes-Benz.

- ❗ If the service interval indicator has been inadvertently reset, this setting can be corrected at an authorized Mercedes-Benz Center.

Have the service work carried out as described in the Service Booklet. There may otherwise be increased wear, resulting in damage to the vehicle or to the major assemblies.

Fuel/water separator

If the fuel/water separator needs servicing, the following message appears in the multifunction display:



You will also hear a brief warning tone.

- ▶ Consult a qualified specialist workshop, e.g. an authorized Mercedes-Benz Center, as soon as possible.
- ❗ If you continue driving without having the fuel/water separator serviced, this could cause damage to the engine. Any resulting damage is not covered by the warranty.

Environmental note

Dispose of service products in an environmentally responsible manner.

Care

Notes on care

Regular care of your vehicle is a condition for retaining the quality in the long term.

Use care products and cleaning agents recommended and approved by Mercedes-Benz.

 **Warning**

Many cleaning products can be hazardous. Some are poisonous, others are flammable. Always follow the instructions on the particular container. Always open your vehicle's doors or windows when cleaning the inside.

Never use fluids or solvents that are not designed for cleaning your vehicle.

Always lock away cleaning products and keep them out of reach of children.

! For cleaning your vehicle, do not use any of the following:

- dry, rough or hard cloths
- abrasive cleaning agents
- solvents
- cleaning agents containing solvents

Do not scrub.

Do not touch the surfaces or protective films with hard objects, e.g. a ring or ice scraper. You could otherwise scratch or damage the surfaces and protective film.

 **Environmental note**

Dispose of empty packaging and cleaning cloths in an environmentally responsible manner.

! Do not park up the vehicle for an extended period straight after cleaning it, particularly after having cleaned the wheels with wheel cleaner. Wheel cleaners could cause increased corrosion of the brake discs and brake pads/linings. For this reason, you should drive for a few minutes after cleaning. Braking heats the brake discs and the brake pads/linings, thus drying them. The vehicle can then be parked up.

Care of the exterior**Automatic car wash** **Warning**

Braking efficiency is reduced after washing the vehicle. This could cause an accident. For this reason, you must drive particularly carefully after washing the vehicle until the brakes have dried.

You can wash the vehicle in an automatic car wash from the very start.

! Never clean your vehicle in a Touchless Automatic Car Wash as these use special cleaning agents. These cleaning agents can damage the paintwork or plastic parts.

If the vehicle is very dirty, pre-wash it before cleaning it in an automatic car wash.

! Make sure that the automatic car wash is suitable for the size of the vehicle. Fold in the exterior mirrors before the vehicle is washed. The exterior mirrors could otherwise be damaged.

! In car washes with a towing mechanism, make sure that AUTOTRONIC is in transmission position **N**, otherwise the vehicle could be damaged.

! Make sure that:

- the side windows and sliding sunroof are closed completely.
- the blower for the ventilation/heating is switched off (airflow control is turned to position **0**/the **AUTO** and **A/C REST** buttons are switched off).
- the windshield wiper switch is at position **0**.

The vehicle could otherwise be damaged.

After using an automatic car wash, wipe off wax from the windshield and the wiper blades. This will prevent smears and reduce wiping noises caused by residue on the windshield.

Washing by hand

When using the vehicle in winter, remove all traces of road salt deposits carefully and as soon as possible.

When washing the vehicle underbody, also clean the inside of the wheels.

- ▶ Do not use hot water and do not wash the vehicle in direct sunlight.
- ▶ Use a soft sponge to clean.
- ▶ Use a mild cleaning agent, such as a car shampoo approved by Mercedes-Benz.
- ▶ Thoroughly hose down the vehicle with a gentle jet of water.
- ▶ Do not point the water jet directly towards the air inlets.
- ▶ Use plenty of water and rinse out the sponge frequently.
- ▶ Rinse the vehicle with clean water and dry thoroughly with a chamois.
- ▶ Do not let the cleaning agent dry on the paintwork.

High-pressure cleaning equipment

Warning

Do not use power washers with circular jet nozzles (concentrated-power jets) to clean your vehicle, especially for cleaning tires. You could otherwise damage the tires and cause an accident.

- ❗ Maintain a minimum distance of 11.8 in (30 cm) between the vehicle and the power washer nozzle. Information about the correct distance is available from the equipment manufacturer.

Move the power washer nozzle around when cleaning your vehicle.

Do not aim directly at any of the following:

- tires
- door gaps, roof gaps, joints, etc.
- electrical components
- battery
- connectors

- lights
- seals
- trim elements
- ventilation slots

Damaged seals or electrical components can lead to leaks or failures.

Cleaning the wheels

❗ Do not use acidic wheel cleaning products to remove brake dust. This could damage wheel bolts and brake components.

❗ Do not park the vehicle for an extended period right after cleaning it, particularly after having cleaned the wheels with wheel cleaner. Wheel cleaners could cause increased corrosion of the brake discs and brake pads/linings. For this reason, you should drive for a few minutes after cleaning. Braking heats the brake discs and brake pads, thus drying them. The vehicle can then be parked up.

Cleaning the paintwork

Scratches, corrosive deposits, areas affected by corrosion and damage caused by inadequate care cannot always be completely repaired. In such cases, visit a qualified specialist workshop immediately, e.g. an authorized Mercedes-Benz Center.

- ▶ Remove impurities immediately, where possible, whilst avoiding rubbing too hard.
- ▶ Soak insect remains with insect remover and rinse off the treated areas afterwards.
- ▶ Soak bird droppings with water and rinse off the treated areas afterwards.
- ▶ Remove coolant, brake fluid, tree resin, oils, fuels and greases by rubbing gently with a cloth soaked in petroleum ether or lighter fluid.
- ▶ Use tar remover to remove tar stains.
- ▶ Use silicone remover to remove wax.

! Do not affix:

- stickers
 - films
 - magnetic plates or similar items
- to painted surfaces. You could otherwise damage the paintwork.

If water no longer forms "beads" on the paint surface, use the paint care products recommended and approved by Mercedes-Benz. This is the case approximately every three to five months, depending on the climate conditions and the care product used. If dirt has penetrated the paint surface or the paint has become dull, the paint cleaner recommended and approved by Mercedes-Benz should be used.

Do not use these care products in the sun or on the hood while the hood is hot.

- ▶ Use a suitable touch-up stick, e.g. MB Touch-Up Stick, to correct smaller areas of paint damage quickly and provisionally.

Care and treatment of matte paintwork

If your vehicle has a clear matte finish, observe the following instructions in order to avoid damage to the paintwork due to incorrect care.

These notes also apply to light alloy wheels with a clear matte finish.

! Never polish the vehicle or the light alloy wheels. Polishing causes the finish to shine.

! Never use paint cleaner, buffing or polishing products, or gloss preserver, e.g. wax. These products are only suitable for high-gloss surfaces. Their use on vehicles with matte finish leads to considerable surface damage (shiny, spotted areas).

Always have paintwork repairs performed at a qualified specialist workshop, e.g. an authorized Mercedes-Benz Center.

! Do not use wash programs with a hot wax treatment under any circumstances.

i Use only insect remover and car shampoo from the range of recommended and approved Mercedes-Benz care products.

Cleaning the windows**!** Warning

Switch off the windshield wipers and remove the SmartKey from the ignition lock before cleaning the windshield or the wiper blades. The windshield wipers could otherwise move and injure you.

- ▶ Clean the inside and outside of the windows with a damp cloth and a cleaning agent that is recommended and approved by Mercedes-Benz.

! Do not use dry cloths, abrasive products, solvents or cleaning agents containing solvents to clean the inside of the windows. Do not touch the insides of the windows with hard objects, e.g. an ice scraper or ring. There is otherwise a risk of damaging the windows.

! Clean the water drainage channels of the windshield and the rear window at regular intervals. Deposits such as leaves, petals and pollen may under certain circumstances prevent water from draining away. This can lead to corrosion damage and damage to electronic components.

Cleaning the wiper blades**!** Warning

Switch off the windshield wipers and remove the SmartKey from the ignition lock before cleaning the windshield or the wiper blades. The windshield wipers could otherwise move and injure you.

! Do not pull the wiper blade. Otherwise, the wiper blade could be damaged.

! Do not clean wiper blades too often and do not rub them too hard. Otherwise, the

graphite coating could be damaged. This could cause wiper noise.

- ▶ Fold the wiper arms away from the windshield.
- ▶ Carefully clean the wiper blades with a damp cloth.
- ▶ Fold the windshield wipers back again before switching on the ignition.

! Hold the wiper arm securely when folding back. The windshield could be damaged if the wiper arm smacks against it suddenly.

Cleaning the headlamps

- ▶ Clean the plastic lamp lenses on the headlamps using a wet sponge and a mild cleaning agent, e.g. Mercedes-Benz car shampoo or cleaning cloths.

! Only use cleaning agents or cleaning cloths which are suitable for plastic headlamp lenses. Unsuitable cleaning agents or cleaning cloths could scratch or damage the plastic headlamp lenses.

Cleaning the sensors

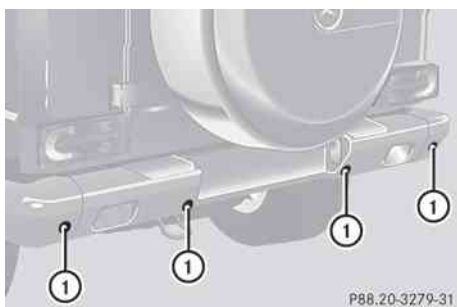

- ▶ Clean sensors ① of the driving systems with water, car shampoo and a soft cloth.
- !** When cleaning the sensors with a power washer, maintain a distance between the vehicle and the nozzle of the power washer of at least 11.8 in (30 cm). Information about the correct distance is available from the equipment manufacturer.

Cleaning the rear view camera

- ▶ Use clear water and a soft cloth to clean camera lens ①.

! Do not clean the camera lens and the area around the rear view camera with a power washer.

Cleaning chrome parts

Impurities combined with the effects of road grit and corrosive environmental factors may cause flash rust to form on the surface. You can restore the original shine of the chrome parts by cleaning them regularly, especially in winter and after washing.

- !** Do not clean chrome parts e.g. the exhaust tail pipes (G 55 AMG) or stainless-steel spare hub cap with alkaline-based cleaning agents such as wheel cleaner.
- ▶ Clean the chrome parts with a chrome care product tested and approved by Mercedes-Benz.

Interior care

Cleaning the display

- ▶ Before cleaning the display, make sure that it is switched off and has cooled down.
- ▶ Clean the display surface using a commercially available microfiber cloth and TFT/LCD display cleaner.
- ▶ Dry the display surface using a dry microfiber cloth.

! For cleaning, do not use any of the following:

- alcohol-based thinner or gasoline
- abrasive cleaning agents
- commercially-available household cleaning agents

These may damage the display surface. Do not put pressure on the display surface when cleaning. This could lead to irreparable damage to the display.

Cleaning the plastic trim

Warning

When cleaning the steering wheel boss and dashboard, do not use cockpit sprays or cleaning agents containing solvents. Cleaning agents containing solvents cause the surface to become porous, and as a result, plastic parts may break away and be thrown around the interior when an air bag is deployed, which may result in severe injuries.

! Do not affix the following to plastic surfaces:

- stickers
- films
- scented oil bottles or similar items

You can otherwise damage the plastic.

! Do not allow cosmetics, insect repellent or sunscreen to come into contact with the plastic trim. This maintains the high-quality look of the surfaces.

- ▶ Wipe the plastic trim with a damp, lint-free cloth, e.g. a microfiber cloth.
- ▶ **Heavy soiling:** use car care and cleaning products recommended and approved by Mercedes-Benz.
The surface may change color temporarily. Wait until the surface is dry again.

Cleaning the steering wheel and gear or selector lever

- ▶ Thoroughly wipe with a damp cloth or use leather care agents that have been recommended and approved by Mercedes-Benz.

Cleaning real wood and trim strips

- ▶ Wipe the wooden trim and trim strips with a damp, lint-free cloth, e.g. a microfiber cloth.
- ▶ **Heavy soiling:** use car care and cleaning products recommended and approved by Mercedes-Benz.

! Do not use solvent-based cleaning agents such as tar remover, wheel cleaners, polishes or waxes. There is otherwise a risk of damaging the surface.

! Do not use chrome polish for trim strips. The trim strips have a chrome look but are mostly made of anodized aluminum and can lose their shine if chrome polish is used. Use a damp, lint-free cloth instead when cleaning the trim strips.

Chrome polish can be used to remove very heavy soiling from trim strips which you are sure are made of chrome. If you are unsure as to whether a trim strip is chrome-plated or not, consult an authorized Mercedes-Benz Center.

Cleaning the seat covers

! Do not use microfiber cloths to clean genuine leather or artificial leather covers, as these are too aggressive and, if used often, may damage the cover.

! Observe the following when cleaning:

- clean genuine leather covers carefully with a damp cloth and then wipe the covers down with a dry cloth. Make sure that the leather does not become soaked. It may otherwise become rough and cracked. Only use leather care agents that have been tested and approved by Mercedes-Benz. You can obtain these from a qualified specialist workshop, e.g. an authorized Mercedes-Benz Center.
- clean artificial leather covers with a cloth moistened with a solution containing 1% detergent (e.g. dish washing liquid).
- clean cloth covers with a microfiber cloth moistened with a solution containing 1% detergent (e.g. dish washing liquid). Rub carefully and always wipe entire seat sections to avoid leaving visible lines. Leave the seat to dry afterwards. Cleaning results depend on the type of dirt and how long it has been there.

- i** Note that regular care is essential to ensure that the appearance and comfort of the covers is retained over time.

Cleaning the seat belts

- ▶ Use clean, lukewarm water and soap solution.

- !** Do not clean the seat belts using chemical cleaning agents. Do not dry the seat belts by warming them above 176 °F (80 °C) or placing them in direct sunlight.

⚠ Warning

Do not bleach or dye seat belts as this may severely weaken them. In a crash, they may not be able to provide adequate protection.

Cleaning the headliner and carpets

- ▶ **Headliner:** if it is very dirty, use a soft brush or dry shampoo.
- ▶ **Carpets:** use the carpet and textile cleaning agents recommended and approved by Mercedes-Benz.

Vehicle equipment	228
After an accident	229
Where will I find...?	229
Flat tire	232
Battery	235
Jump-starting	238
Towing and tow-starting	240
Electrical fuses	242

Vehicle equipment

- i** This manual describes all the standard and optional equipment of your vehicle which was available at the time of purchase. Country-specific differences are possible. Please note that your vehicle may not be equipped with all features described. This also applies to safety-relevant systems and functions.

After an accident

Problem	Possible causes/consequences and ► Solutions
Fuel is leaking from the vehicle.	<p>⚠ Risk of explosion or fire</p> <p>The fuel line or the fuel tank is faulty.</p> <ul style="list-style-type: none"> ► Immediately turn the SmartKey to position 0 (► page 117) in the ignition lock and remove it. ► Do not restart the engine under any circumstances. ► Consult a qualified specialist workshop.
You are unable to determine the extent of the damage.	<ul style="list-style-type: none"> ► Consult a qualified specialist workshop.
You cannot detect any damage.	<ul style="list-style-type: none"> ► Start the engine as normal.
The NECK-PRO head restraints on the driver's and front-passenger seats have been triggered.	<p>Your vehicle has been involved in a rear-end collision.</p> <ul style="list-style-type: none"> ► Reset the NECK-PRO head restraints (► page 43).

Where will I find...?

First-aid kit

- i** Check the expiration date on the first-aid kit at least once a year. Replace the contents if necessary, and replace missing contents.

The first-aid kit is located in the stowage compartment in the front-passenger door.



- Remove first-aid kit **①** from the stowage space.

Vehicle tool kit

General notes

- i** Vehicles are not equipped with the tools needed to change a wheel when they leave the factory, e.g. jack or lug wrench. Some tools for changing a wheel are specific to the vehicle. To obtain tools approved for your vehicle, visit a qualified specialist workshop, e.g. an authorized Mercedes-Benz Center.

The vehicle tool kit contains:

- vehicle tool kit with:
 - fuse extractor
 - Allen key, e.g. to operate the sliding roof manually in an emergency
 - pump lever for vehicle jack
 - screwdriver
 - lug wrench
- jack

Vehicle tool kit

The vehicle tool kit is under the cover in the footwell in front of the rear bench seat.

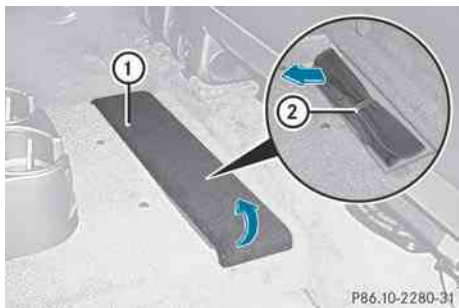

- ▶ Fold cover ① to the side.
- ▶ Pull vehicle tool kit ② out by the tab.

Jack

The jack is located under the rear bench seat on the right-hand side when viewed in the direction of travel.

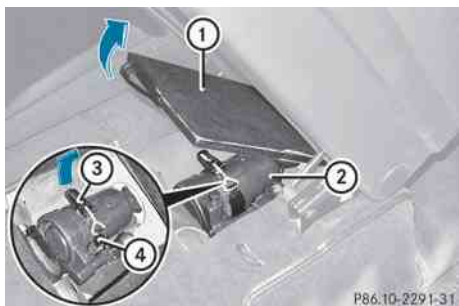

- ▶ Fold the rear bench seat forward (▷ page 195).
- ▶ Open cover ①.
- ▶ Pull bar ③ upwards and detach from tab ④.
- ▶ Take out jack ②.

! Make sure that, while installing the vehicle jack, there are no cables on the holder, in order to avoid them becoming trapped.

! Make sure that, while installing the vehicle jack, there are no cables on the holder, in order to avoid them becoming trapped.

Exterior spare wheel bracket

General notes

! Warning!

If the spare tire is more than 6 years old or is not the same model as the regular tires, have the spare tire replaced with a new tire at the nearest Mercedes-Benz Center.

Never operate the vehicle with more than one spare wheel mounted.

! Warning

G 55 AMG:

Rim and tire sizes are different for the spare wheel and the normal wheel. With the spare wheel mounted, handling is impaired.

Do not exceed a maximum speed of 50 mph (80 km/h).

The spare wheel is mounted in a cover on the tailgate.

Removing the cover

Stainless-steel spare hub cap

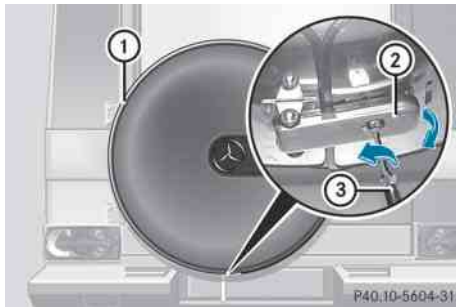

- ▶ Remove the screwdriver from the vehicle tool kit (▶ page 229).
- ▶ Open the lock on cover ring ① with screwdriver ③ or a similar tool.
- ▶ Fold tab ② down.



- ▶ Pull cover ring ① apart and remove it.
- ▶ Pull off cover panel ④.

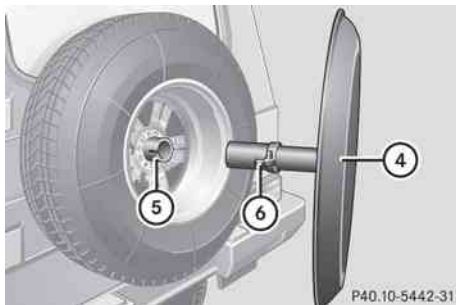

- ▶ **i** When refitting cover panel ④, make sure that retainer ⑥ engages in recess ⑤.

Removing the spare wheel

⚠ Warning!

Make sure no one is injured when removing the spare wheel.

Grip wheel from the sides.

Keep hands from beneath the wheel.

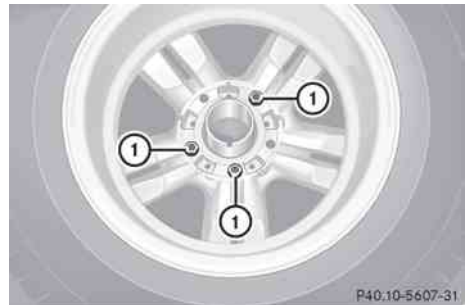

- ▶ Remove wheel nuts ①.
- ▶ Remove the spare wheel.

Mounting the wheel

After changing a wheel:

- ▶ Repair or replace the damaged wheel as soon as possible and secure the spare wheel in place again.
- ▶ Secure the damaged wheel on the spare wheel bracket with wheel nuts ①. When doing so, make sure that the wheel cannot come loose.
- ▶ When refitting cover panel ④, make sure that retainer ⑥ engages in recess ⑤.
- ▶ Make sure that tab ② is below when refitting cover ring ①.
- ▶ For safety reasons, regularly check to ensure that the wheel is securely fastened.

Flat tire

Preparing the vehicle

- ▶ Stop the vehicle as far away as possible from traffic on solid, non-slippery and level ground.
- ▶ Switch on the hazard warning lamps.
- ▶ Apply the parking brake.
- ▶ Bring the front wheels into the straight-ahead position.
- ▶ Move the selector lever to **P**.
- ▶ Switch off the engine.
- ▶ Remove the SmartKey from the ignition lock.
- ▶ All occupants must get out of the vehicle. Make sure that they are not endangered as they do so.
- ▶ Make sure that no one is near the danger area while a wheel is being changed. Anyone who is not directly assisting in the wheel change should, for example, stand behind the barrier.
- ▶ Get out of the vehicle. Pay attention to traffic conditions when doing so.
- ▶ Close the driver's door.

Changing a wheel and mounting the spare wheel

Important safety notes

Warning!

If the spare tire is more than 6 years old or is not the same model as the regular tires, have the spare tire replaced with a new tire at the nearest Mercedes-Benz Center.

Never operate the vehicle with more than one spare wheel mounted.

Warning

G 55 AMG:

Rim and tire sizes are different for the spare wheel and the normal wheel. With the spare wheel mounted, handling is impaired.

Do not exceed a maximum speed of 50 mph(80 km/h).

Preparing the vehicle

- ▶ Prepare the vehicle as described (▷ page 232).

Warning!

You must remove the spare wheel from the spare wheel carrier before lifting the vehicle. Otherwise the vehicle could fall off the jack and injure you or others.

- ▶ Remove the vehicle tool kit and the jack (▷ page 229).
- ▶ Remove the spare wheel from the spare wheel bracket (▷ page 230).

- i** Vehicles without an emergency spare wheel/spare wheel are not equipped with a wheel-changing tool kit at the factory. For more information on which tools are required to perform a wheel change on your vehicle e.g. lug wrench or jack, consult an authorized Mercedes-Benz Center.

Securing the vehicle to prevent it from rolling away

- ▶ Secure the vehicle to prevent it from rolling away.

On level ground: place chocks or similar items under the front and rear of the wheel that is diagonally opposite to the wheel you wish to change.

- ▶ **On downhill gradients:** place chocks or similar items behind both wheels of the other axle.

Warning

Only jack up the vehicle on level ground or on slight inclines/declines. The vehicle could otherwise fall off the jack and injure you or others.

Raising the vehicle

Warning!

When jacking up the vehicle, only use the jack which has been specifically approved by Mercedes-Benz for your vehicle.

The jack is designed exclusively for jacking up the vehicle under the axle housing. Make sure the jack is positioned correctly under the axle housing. The jack must always be vertical when in use, especially on inclines or declines.

The jack is intended only for lifting the vehicle briefly for wheel changes. It is not suited for performing maintenance work under the vehicle. To help avoid personal injury, use the jack only to lift the vehicle during a wheel change.

Never get beneath the vehicle while it is supported by the jack. Keep hands and feet away from the area under the lifted vehicle. Always lower the vehicle onto sufficient capacity jackstands before working under the vehicle.

Always firmly engage the parking brake and block the wheels with wheel chocks or other sizeable objects before raising the vehicle with the jack. Do not disengage the parking brake while the vehicle is raised.

Make sure that the ground on which the vehicle is standing and where you place the jack is solid, level and not slippery. If necessary, use a large underlay. On slippery surfaces, such as tiled floors, you should use a non-slip underlay, for example a rubber mat. Do not use wooden blocks or similar objects to support the jack. Otherwise the jack may not be able to achieve its load-bearing capacity if it is not at its full height.

Never start the engine when the vehicle is raised.

Also observe the notes on the jack.



- ▶ Using lug wrench ①, loosen the bolts on the wheel you wish to change by about one full turn. Do not unscrew the wheel bolts completely.

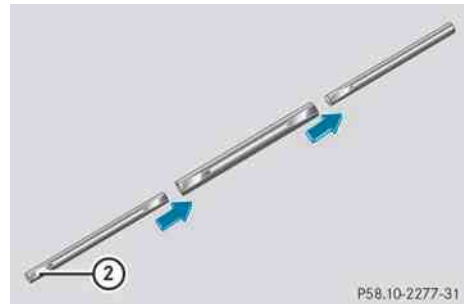

- ② Notch on pump lever

- ▶ Assemble the pump lever for the jack. It can be found with the vehicle tool kit (▷ page 229).

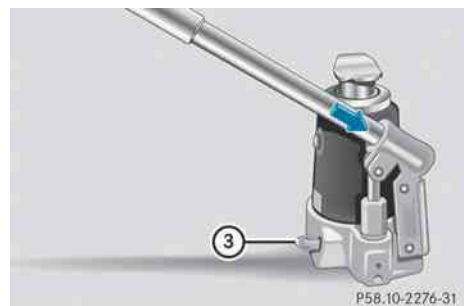

- ▶ Turn pressure release screw ③ clockwise as far as it will go using notch ② on the pump lever. Pressure release screw ③ is closed.

i Never turn pressure release screw **③** by more than one to two revolutions. Otherwise, hydraulic fluid could escape.

! The jack is designed exclusively for jacking up the vehicle at the jacking points. Otherwise, your vehicle could be damaged.

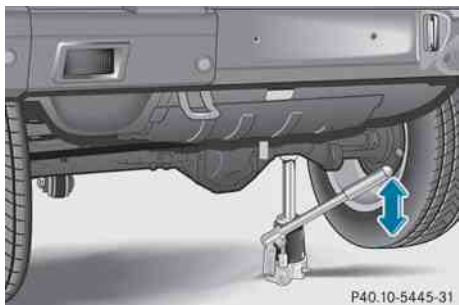

- ▶ Place the jack on solid ground.
- ▶ Position the jack at the front or rear axle carrier tubes. The jack must always stand vertically, even on slopes. Make sure that the jack is placed in the correct position beneath the axle carrier tube. The front or rear axle must fit into the support on the jack.
- ▶ Raise the vehicle by pumping (arrow) until the tire is a maximum of 1.2 inches (3 cm) above the ground.

Removing a wheel

- ▶ Unscrew the wheel bolts.
- !** Do not place wheel bolts in sand or on a dirty surface. The bolt and wheel hub threads could otherwise be damaged when you screw them in.
- ▶ Remove the wheel.

Mounting a new wheel

⚠ Warning!

Always replace wheel bolts that are damaged or rusted.

Never apply oil or grease to wheel bolts.

Damaged wheel hub threads should be repaired immediately. Do not continue to drive under these circumstances! Contact an authorized Mercedes-Benz Center or call Roadside Assistance.

Incorrect wheel bolts or improperly tightened wheel bolts can cause the wheel to come off. This could cause an accident. Make sure to use the correct wheel bolts.

⚠ Warning

Only use genuine Mercedes-Benz wheel bolts. Other wheel bolts may come loose.

Do not tighten the wheel bolts when the vehicle is raised. Otherwise, the vehicle could fall off the jack.

- ▶ Clean the wheel and wheel hub contact surfaces.
- !** To prevent damage to the paintwork, hold the wheel securely against the wheel hub while screwing in the first wheel bolt.
- ▶ Place the wheel on the wheel hub and push it on.
- ▶ Tighten the wheel bolts until they are finger-tight.

Lowering the vehicle

- ▶ Open the pressure release screw on the jack using the pump lever (▶ page 233) by approximately one turn.
- ▶ Lower the vehicle until it is once again standing firmly on the ground.
- ▶ Place the jack to one side.

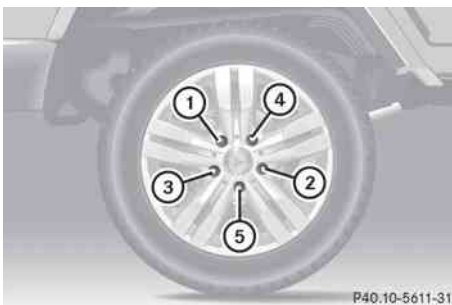

- ▶ Tighten the wheel bolts evenly in a crosswise pattern in the sequence indicated (① to ⑤). The tightening torque must be 96 lb-ft (130 Nm).

⚠ Warning!

Have the tightening torque checked after changing a wheel. The wheels could come loose if they are not tightened to a torque of 96 lb-ft (130 Nm).

- ▶ Disassemble the pump lever.
- ▶ Push the jack piston back in and close the drain plug.
- ▶ Use the bolts to secure the faulty wheel to the exterior spare wheel bracket.
- ▶ Cover the faulty wheel with the tire cover provided.
- ▶ Put the jack and the rest of the vehicle tool kit away.
- ▶ Check the tire pressure and correct it, if necessary.

A table with the tire pressures for your vehicle can be found on the B-pillar on the driver's side.

Battery

Important safety notes

In order for the battery to achieve the maximum possible service life, it must always be sufficiently charged.

- ❗ Have the battery checked regularly at a qualified specialist workshop, e.g. an authorized Mercedes-Benz Center. Observe the service intervals in the Service Booklet or for further information consult a qualified specialist workshop, e.g. an authorized Mercedes-Benz Center.

Have the battery charge checked more frequently if you use the vehicle mainly for short trips or if you leave it standing idle for a long period.

Only replace a battery with a battery that has been recommended by Mercedes-Benz. Consult an authorized Mercedes-Benz Center if you wish to leave your vehicle parked up for a long period of time.

⚠ Warning

Comply with safety precautions and take protective measures when handling batteries.

Risk of explosion



Fire, naked flames and smoking are prohibited when handling the battery. Avoid creating sparks.



Battery acid is caustic. Avoid contact with the skin, eyes or clothing.



Wear suitable protective clothing, in particular gloves, an apron and a face mask.

Immediately rinse acid splashes off with clean water. Consult a doctor if necessary.

Wear eye protection.



Keep children away.



Observe this Operator's Manual.



♻ Environmental note

Do not dispose of batteries in the household rubbish. Dispose of defective batteries in an environmentally responsible manner. Take them to an authorized Mercedes-Benz Center or to a special collection point for old batteries.

⚠ Warning

Failure to follow these instructions can result in severe injury or death.

Never lean over batteries while connecting. You might get injured.

Battery fluid contains sulfuric acid. Do not allow this fluid to come in contact with eyes, skin or clothing. In case it does, immediately flush affected area with water and seek medical help if necessary.

A battery will also produce hydrogen gas, which is flammable and explosive. Keep flames or sparks away from battery, avoid improper connection of jumper cables, smoking etc.

⚠ Warning

Do not place any metal objects on the battery as this could result in a short circuit.

Use leak-proof batteries only to avoid the risk of acid burns in the event of an accident.

Take care that you do not become statically charged, e.g. by wearing synthetic clothing or rubbing against textiles. For this reason, you also should not pull or push the battery over carpets or other synthetic materials.

Never touch the battery first. First, touch the outside body of the vehicle in order to release any possible electrostatic charges.

Do not rub the battery with rags or cloths. The battery could explode if touched due to electrostatic charge or due to spark formation.

! Switch off the engine and remove the SmartKey before disconnecting the terminal clamps from the battery. You may otherwise destroy electronic components, such as the alternator.

! Like other batteries, the vehicle battery may discharge over time if you do not use the vehicle. In this case, have the battery disconnected at a qualified specialist workshop, e.g. an authorized Mercedes-Benz Center. You can also charge the battery with a charger recommended by

Mercedes-Benz. Contact an authorized Mercedes-Benz Center for further information.

The battery, breather hose and cover of the positive terminal clamp must be installed securely during operation.

i Remove the SmartKey if you park the vehicle and do not require any electrical consumers. The vehicle will then use very little energy, thus conserving battery power.

Mercedes-Benz recommends that you do not carry out work on batteries yourself, e.g. removing, charging or replacing. Always have this work performed at a qualified specialist workshop, e.g. an authorized Mercedes-Benz Center.

i If the power supply has been interrupted, e.g. if the battery has been reconnected, you must carry out the following tasks:

- reset the head restraints on the front seats (> page 80).

Charging the battery**⚠ Warning**

Never charge a battery while still installed in the vehicle unless the accessory battery charge unit approved by Mercedes-Benz is being used. Gases may escape during charging and cause explosions that may result in paint damage, corrosion or personal injury.

An accessory battery charge unit specially adapted for Mercedes-Benz vehicles and tested and approved by Mercedes-Benz is available. It permits the charging of the battery in its installed position. Contact an authorized Mercedes-Benz Center for information and availability.



Charge the battery in accordance with the separate instructions for the accessory battery charger.

 **Warning**

There is a risk of acid burns during the charging process due to the gases which escape from the battery. Do not lean over the battery during the charging process.

 **Warning**

Battery acid is caustic. Avoid contact with the skin, eyes or clothing.

-  Only charge the installed battery with a battery charger which has been tested and approved by Mercedes-Benz. These battery chargers allow the battery to be charged while still installed.
-  Only use battery chargers with a maximum charging voltage of 14.8 V.
-  Only charge the battery using the jump-starting connection point.

The jump-starting connection point is in the engine compartment (▷ page 238).

- ▶ Open the hood (▷ page 214).
- ▶ Connect the battery charger to the positive terminal and earth point in the same order as when connecting the donor battery in the jump-starting procedure (▷ page 238).
- ▶ Read the battery charger's operating instructions before charging the battery.

Jump-starting

 **Warning**

Failure to follow these directions will cause damage to the electronic components, and can lead to a battery explosion and severe injury or death.

Never lean over batteries while connecting or jump starting. You might get injured.

Battery fluid contains sulfuric acid. Do not allow this fluid to come in contact with eyes, skin or clothing. In case it does, immediately flush affected area with water, and seek medical help if necessary.

A battery will also produce hydrogen gas, which is flammable and explosive. Keep flames or sparks away from battery, avoid improper connection of jumper cables, smoking, etc.

Attempting to jump start a frozen battery can result in it exploding, causing personal injury.

Read all instructions before proceeding.

! Avoid repeated and lengthy starting attempts. Otherwise, non-combusted fuel may damage the catalytic converter and create a risk of fire.

Do not use a rapid charging device to start the vehicle.

Make sure the jumper cables are not damaged.

Make sure the jumper cables are not touching any other metal objects when they are connected to the battery.

If your vehicle's battery is discharged, the engine can be jump-started from another vehicle or from a second battery using jumper cables.

Observe the following points:

- ▶ The battery is not accessible in all vehicles. If the other vehicle's battery is not accessible, jump-start the vehicle using a second battery or a jump-starting device.
- ▶ You may only jump-start the vehicle when the engine and catalytic converter are cold.
- ▶ Do not start the engine if the battery is frozen. Let the battery thaw first.
- ▶ Jump-starting may only be performed from batteries with a nominal voltage of 12 V.
- ▶ Only use jumper cables that have a sufficient cross-section and insulated terminal clamps.
- ▶ Make sure that the jumper cables cannot come into contact with parts, such as the pulley or the fan. These parts move when the engine is started and while it is running.
- ▶ If the battery is fully discharged, leave the battery that is being used to jump-start connected for a few minutes before attempting to start. This charges the empty battery a little.

i Jumper cables and further information about jump-starting can be obtained from any authorized Mercedes-Benz Center.

- ▶ Make sure that the two vehicles do not touch.
- ▶ Apply the parking brake.
- ▶ Move the selector lever to **P**.
- ▶ Switch off all electrical consumers (e.g. radio, blower, etc.).
- ▶ Open the hood (▷ page 214).

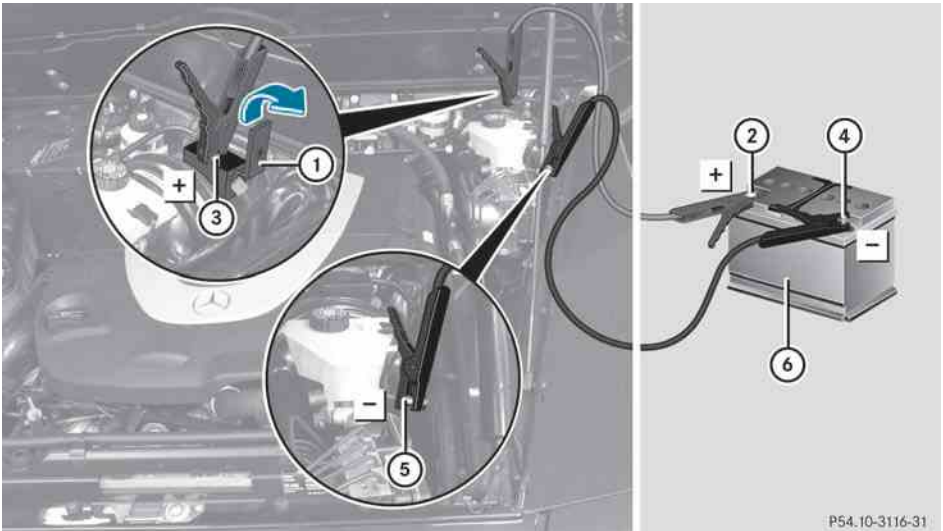

P54.10-3116-31

Position number ⑥ identifies the charged battery of the other vehicle or an equivalent jump-starting device.

- ▶ Lift up cover ① of positive terminal ③ in the direction of the arrow.
- ▶ Connect positive terminal ③ on your vehicle to positive terminal ② of donor battery ⑥ using the jumper cable, beginning with your own battery.
- ▶ Start the engine of the donor vehicle and run it at idling speed.
- ▶ Connect negative terminal ④ of donor battery ⑥ to earth point ⑤ of your vehicle using the jumper cable, connecting the jumper cable to donor battery ⑥ first.
- ▶ Start the engine.
- ▶ First, remove the jumper cable from earth point ⑤ and negative terminal ④, then from positive terminal ③ and positive terminal ②, each time disconnecting from the battery on your own vehicle first.
- ▶ Have the battery checked at a qualified specialist workshop, e.g. an authorized Mercedes-Benz Center.

Towing and tow-starting

Important safety notes

Warning

If circumstances require towing the vehicle with all wheels on the ground, always tow with a tow bar if:

- the engine will not run
- there is a malfunction in the brake system
- there is a malfunction in the power supply or the vehicle's electrical system

This is necessary to adequately control the towed vehicle.

Prior to towing the vehicle with all wheels on the ground, make sure the SmartKey is in starter switch position **2**.

If the SmartKey is left in starter switch position **0** for an extended period of time, it can no longer be turned in the switch. In this case, the steering is locked. To unlock, remove SmartKey from starter switch and reinsert.

It is better to have the vehicle transported than to have it towed.

! You may only tow the vehicle a maximum distance of 30 miles (50 km). A towing speed of 30 mph (50 km/h) must not be exceeded.

For towing distances over 30 miles (50 km), the vehicle must be loaded onto a transporter.

! Only secure the tow cable or tow bar to the towing eyes. You could otherwise damage the vehicle.

! Do not tow with sling-type equipment. This could damage the vehicle.

! Do not use the towing eyes for recovery purposes as this could damage the vehicle. If in doubt, recover the vehicle with a crane.

! When towing, pull away slowly and smoothly. If the tractive power is too high, the vehicles could be damaged.

! Your vehicle is equipped with an automatic transmission. Therefore, you must not have the vehicle tow-started. The transmission may otherwise be damaged.

If the transfer case can be shifted into neutral **N**, you can tow the vehicle.

If the transfer case cannot be shifted into neutral **N**, you can tow the vehicle with one axle raised. Please bear the following in mind:

- remove the propeller shaft between the transfer case and the rolling axle.
- turn the key to position **1** in the ignition lock.

The battery must be connected and charged. Otherwise, you:

- cannot turn the key in the ignition lock to position **2**
- cannot shift the automatic transmission to position **N**

i Deactivate the automatic locking feature (▷ page 165) You could otherwise be locked out when pushing or towing the vehicle.

Towing eye

Towing eye, front

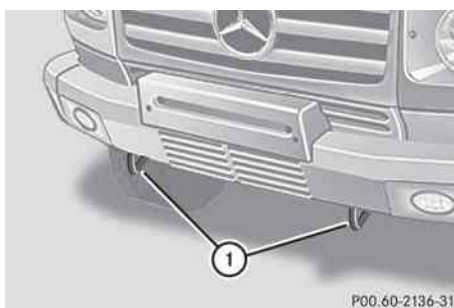

① Towing eyes, front

Towing eye, rear

The rear towing eye is located under the bumper, on the left-hand side when viewed in the direction of travel.

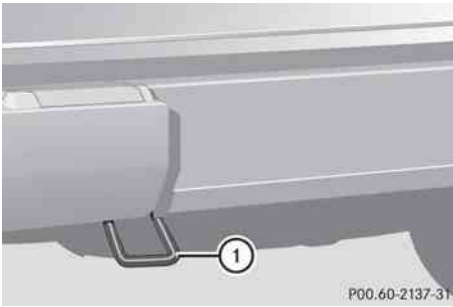

① Towing eye, rear

Towing the vehicle with both axles on the ground

It is important that you observe the safety instructions when towing away your vehicle (▷ page 240).

Warning

With the engine not running, there is no power assistance for the brake and steering systems. In this case, it is important to keep in mind that a considerably higher degree of effort is necessary to brake and steer the vehicle. Adapt your driving accordingly.

- ▶ Switch on the hazard warning lamps (▷ page 93).
- ① When towing with the hazard warning lamps switched on, use the combination switch as usual to signal a change of direction. In this case, only the turn signals for the desired direction flash. When the combination switch is reset, the hazard warning lamps start flashing again.
- ▶ Turn the key to position **2** in the ignition lock.
- ▶ When the vehicle is stationary, depress the brake pedal and keep it depressed.
- ▶ Shift the transfer case to neutral position **N** (▷ page 126).
- ▶ Shift the automatic transmission to position **N**.

- ▶ Release the brake pedal.
- ▶ Release the parking brake.

- ① The transmission can only change gear when the battery has sufficient charge. If you cannot move the selector lever to **N**, you must remove the propeller shafts to the driven axles.

Transporting the vehicle

Use the towing eyes to pull the vehicle if it needs to be transported on a trailer or transporter.

- ▶ Turn the key to position **2** in the ignition lock.
- ▶ Move the selector lever to **N**.
- ▶ Shift the transfer case to neutral position **N** (▷ page 126).

As soon as the vehicle is loaded:

- ▶ Prevent the vehicle from rolling away by applying the parking brake.
 - ▶ Shift the automatic transmission to position **P**.
 - ▶ Turn the key in the ignition lock to position **0** and remove the key from the ignition lock.
 - ▶ Secure the vehicle.
- ⚠ Only lash the vehicle down by the wheels or wheel rims, not by parts of the vehicle such as axle or steering components. Otherwise, the vehicle could be damaged.

Recovering a vehicle that has become stuck

- ⚠ Pull away smoothly, slowly, and in a straight line when pulling out a vehicle that has become stuck. Excessive tractive power could damage the vehicles.

If the drive wheels get trapped on loose or muddy ground, recover the vehicle with the utmost care, especially so if the vehicle is laden.

Never attempt to recover a vehicle with a trailer attached.

Pull out the vehicle backwards, if possible, using the tracks it made when it became stuck.

Towing in the event of malfunctions

General notes

! If you are removing the propeller shaft, use M10 nuts as spacers on the M8 bolts and secure them with M8 nuts.

New self-locking nuts must be used when the propeller shafts are refitted.

► Observe the safety notes as you do so (▷ page 240).

i Consult an authorized Mercedes-Benz Center.

Engine damage, gear damage or electrical malfunctions

► Move the selector lever to **N** (▷ page 122).

► Shift the transfer case to neutral position **N** (▷ page 126).

In the event of damage to the transfer case

Have the propeller shafts between the axles and the transfer case removed.

Have the vehicle towed with the front axle raised.

In the event of damage to the front axle

Have the propeller shaft between the rear axle and the transfer case removed.

Have the vehicle towed with the front axle raised.

In the event of damage to the rear axle

Have the propeller shaft between the front axle and the transfer case removed.

Then, have the vehicle towed with the rear axle raised and with wheel rollers under the front axle.

Electrical fuses

Important safety notes

The fuses in your vehicle serve to close down faulty circuits. If a fuse blows, all the components on the circuit and their functions stop operating.

⚠ Warning

Only use fuses approved by Mercedes-Benz with the specified amperage for the system in question and do not attempt to repair or bridge a blown fuse. Using other than approved fuses or using repaired or bridged fuses may cause an overload leading to a fire, and/or cause damage to electrical components and/or systems. Have the cause determined and remedied by an authorized Mercedes-Benz Center.

Blown fuses must be replaced with fuses of the same rating, which you can recognize by the color and value. The fuse ratings are listed in the fuse allocation chart. An authorized Mercedes-Benz Center will be happy to advise you.

i If a fuse has blown, visit a breakdown service or an authorized Mercedes-Benz Center.

If the newly inserted fuse also blows, have the cause traced and rectified at a qualified specialist workshop, e.g. an authorized Mercedes-Benz Center.

! Only use fuses that have been approved for Mercedes-Benz vehicles and which have the correct fuse rating for the system concerned. Otherwise, components or systems could be damaged.

Before changing a fuse

- ▶ Park the vehicle and apply the parking brake.
- ▶ Switch off all electrical consumers.
- ▶ Remove the key from the ignition lock.

The fuses are located in various fuse boxes:

- main fuse box on the driver's side of the dashboard
- fuse box in the front-passenger footwell
- fuse box in the transmission tunnel
- fuse box in the battery case

The fuse allocation chart and the spare fuses are in the main fuse box on the dashboard (▷ page 243).

You can find the fuse extractor in the vehicle tool kit (▷ page 229).

Dashboard fuse box

! Do not use a pointed object such as a screwdriver to open the cover in the dashboard. You could damage the dashboard or the cover.

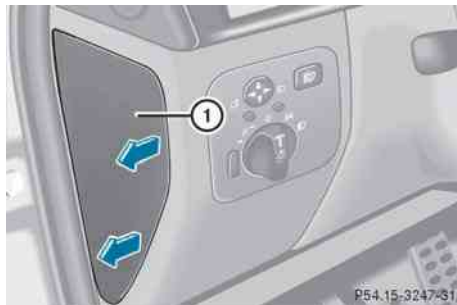

- ▶ Open the driver's door.
- ▶ **To open:** pull cover ① outwards in the direction of the arrow and remove it.

Fuse box in the front-passenger footwell



- ▶ To open: remove screws ①.
- ▶ Remove cover ② in the direction of the arrow.

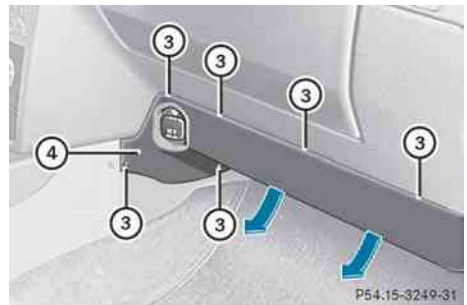

- ▶ Remove screws ③.
- ▶ Remove cover ④ in the direction of the arrow.



To make it easier to change the fuse, you can fold fuse box ⑤ down slightly:

- ▶ Remove screws ⑥.
- ▶ Fold fuse box ⑤ down.

Fuse box on the transmission tunnel

In order to access the fuse box, you have to remove the stop clamps on the front-passenger seat.

Warning!

Do not drive the vehicle when the front end stops are not correctly installed. Failure to reinstall stops as indicated may result in serious injury in certain frontal crashes.

Adjust the front passenger seat as far as possible rearward from the dashboard when the seat is occupied. Comply with information on occupant safety section.

The stop clamps are at the front of the guide rails.

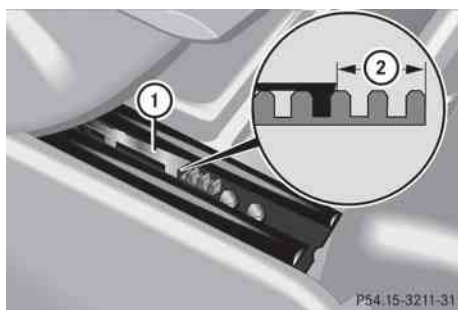

Stop clamp of the right guide rail, reverse image for the left

- ① Stop clamp
- ② Spacing

- ▶ **To remove the stop clamps:** remove both stop clamps ① of the front-passenger seat guide rails using a screwdriver.

- ! When replacing the stop clamps, make sure you maintain the correct spacing.



- ▶ **To open the fuse box:** move the front-passenger seat to its foremost position.
- ▶ Remove screws ①.
- ▶ Remove cover ② in the direction of the arrow.

Fuse box in the battery case

The battery case is under a cover in the rear footwell.

The fuses in the battery case do not usually need to be replaced. If a fuse has to be changed, visit a qualified specialist workshop, e.g. an authorized Mercedes-Benz Center.

- ! The cover must be seated properly, otherwise moisture or dirt could impair the function of the fuses.

Vehicle equipment	246
Important safety notes	246
Operation	246
Winter operation	248
Tire pressure	249
Loading the vehicle	256
Maximum tire load	260
Uniform Tire Quality Grading Standards	261
Tire labeling	262
Definitions for tires and loading	266
Changing a wheel	269
Wheel and tire combinations	270

Vehicle equipment

i This manual describes all the standard and optional equipment of your vehicle which was available at the time of purchase. Country-specific differences are possible. Please note that your vehicle may not be equipped with all features described. This also applies to safety-relevant systems and functions.

Important safety notes

Contact an authorized Mercedes-Benz Center if you require information on tested and recommended tires and wheels for summer and winter driving. Advice on purchasing and caring for tires is also available there.

Warning

Replace rims or tires with the same designation, manufacturer and type as shown on the original part. For further information contact an authorized Mercedes-Benz Center. If incorrectly sized rims and tires are mounted, the wheel brakes or suspension components can be damaged. Also, the operating clearance of the wheels and the tires may no longer be correct.

Warning

Worn, old tires can cause accidents. If the tire tread is worn to minimum tread depth, or if the tires have sustained damage, replace them.

When replacing rims, only use genuine Mercedes-Benz wheel bolts specified for the particular rim type. Failure to do so can result in the bolts loosening and possibly an accident.

Retreaded tires are not tested or recommended by Mercedes-Benz, since previous damage cannot always be recognized on retreads. The operating safety of the vehicle cannot be assured when such tires are used.

Warning

If you feel a sudden significant vibration or ride disturbance, or you suspect that possible damage to your vehicle has occurred, you should turn on the hazard warning flashers, carefully slow down, and drive with caution to an area which is a safe distance from the road. Inspect the tires and the vehicle underbody for possible damage. If the vehicle appears unsafe, have the vehicle towed to the nearest authorized Mercedes-Benz Center or tire dealer for repairs.

Warning

Do not drive with a flat tire. A flat tire affects the ability to steer or brake the vehicle. You might lose control of the vehicle. Continued driving with a flat tire or driving at high speed with a flat tire will cause excessive heat build-up and possibly a fire.

i Further information about wheels and tires can be obtained from any authorized Mercedes-Benz Center.

Operation

Notes on driving

- If the vehicle is heavily laden, check the tire pressures and correct them if necessary.
- When parking your vehicle, make sure that the tires do not get deformed by the curb or other obstacles. If it is necessary to drive over curbs, speed humps or similar elevations, try to do so slowly and at an obtuse angle. Otherwise, the tires, particularly the sidewalls, can get damaged.

Notes on regularly inspecting wheels and tires

Warning

Regularly check the tires for damage. Damaged tires can cause tire inflation

pressure loss. As a result, you could lose control of your vehicle.

Worn, old tires can cause accidents. If the tire tread is worn to minimum tread depth, or if the tires have sustained damage, replace them.

- Regularly check the wheels and tires of your vehicle for damage (e.g. cuts, punctures, tears, bulges on tires and deformation or cracks or severe corrosion on wheels) at least once a month, as well as after driving off-road or on rough roads. Damaged wheels can cause a loss of tire pressure.
- Regularly check the tire tread depth and the condition of the tread across the whole width of the tire (▷ page 247). If necessary, turn the front wheels to full lock in order to inspect the inner side of the tire surface.
- All wheels must have a valve cap to protect the valve against dirt and moisture. Do not install anything onto the valve (such as tire pressure monitoring systems) other than the standard valve cap or other valve caps approved by Mercedes-Benz for your vehicle.
- Regularly check the pressure of all the tires including the spare wheel, particularly prior to long trips, and correct the pressure as necessary (▷ page 249).

Tire tread

Warning

Although the applicable federal motor vehicle safety laws consider a tire to be worn when the tread wear indicators (TWI) become visible at approximately $\frac{1}{16}$ in (1.6 mm), we recommend that you do not allow your tires to wear down to that level. As tread depth approaches $\frac{1}{8}$ in (3 mm), the adhesion properties on a wet road are sharply reduced.

Depending upon the weather and/or road surface (conditions), the tire traction varies widely.

Do not use tires that are excessively worn as the tire traction on wet road surfaces decreases significantly when the tread depth is less than $\frac{1}{8}$ in (3 mm).

Tread wear indicators (TWI) are required by law. Six indicators are positioned over the tire tread. They are visible as soon as a tread depth of approximately $\frac{1}{16}$ in (1.6 mm) is reached. If this is the case, the tire is so worn that it must be replaced.

The recommended tread depth for summer tires is at least $\frac{1}{8}$ in (3 mm). The recommended tread depth for winter tires is at least $\frac{1}{6}$ in (4 mm).

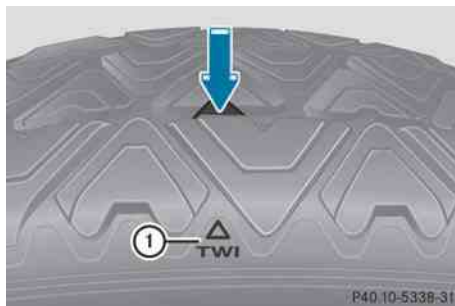

Indicator ① for tread wear is integrated into the tire tread.

Notes on selecting, mounting and replacing tires

- Only mount tires and wheels of the same type and make.
- Only mount tires of the correct size onto the wheels.
- After installing new tires, run them in at moderate speeds for the first 60 miles (100 km) as they only reach their full performance after this distance.
- Do not use tires that are excessively worn as the tire traction on wet road surfaces

decreases significantly when the tread depth is less than $\frac{1}{8}$ in (3 mm).

- Replace the tires after six years at the latest, regardless of wear. This also applies to the spare wheel.

The service life of tires depends, among other things, on the following factors:

- driving style
- tire pressure
- mileage

Winter operation

Please bear the following in mind

Have your vehicle winterproofed at a qualified specialist workshop, e.g. an authorized Mercedes-Benz Center, at the onset of winter.

Observe the notes in the "Changing a wheel" section (▷ page 269).

Driving with summer tires

At temperatures below 45 °F (+7 °C), the elasticity of summer tires and therefore also traction and braking capability are reduced considerably — equip your vehicle with M+S tires. Using summer tires at very cold temperatures could cause tears to form, thereby damaging the tires permanently. Mercedes-Benz cannot accept responsibility for this type of damage.

M+S tires

At temperatures below 45 °F (+7 °C), use winter tires or all-season tires. Both types of tire are identified by the M+S marking.

Not all tires with the M+S marking provide the driving characteristics of winter tires. In addition to the M+S marking, winter tires also bear the snowflake symbol  on the sidewall. Tires with this marking fulfill the requirements of the Rubber Manufacturers

Association (RMA) and the Rubber Association of Canada (RAC) regarding snow traction and were specially developed for driving on snow. Only these tires will allow driving safety systems such as ABS and ESP® to function optimally in winter, as these tires have been designed specifically for driving on snow.

Use M+S tires of the same make and tread on all wheels to maintain safe handling characteristics.

- For further information on tires, see the "Wheels and tires" section (▷ page 232).

Warning

M+S tires with a tread depth of less than $\frac{1}{6}$ inch (4 mm) must be replaced. They are no longer suitable for winter operation.

Always observe the maximum permissible speed specified for the M+S tires you have installed.

When you have installed the M+S tires:

- ▶ Check the tire pressures (▷ page 249).
- ▶ Restart the tire pressure monitor (▷ page 255).

Warning

If you use your spare wheel when M+S tires are fitted on the other wheels, be aware that the difference in tire characteristics may very well impair turning stability and that overall driving stability may be reduced. Adapt your driving style accordingly.

Have the spare wheel replaced by a regular road wheel with an M+S tire at the nearest authorized Sprinter Dealer.

Snow chains

For safety reasons, Mercedes-Benz recommends that you only use snow chains which have been specially approved for your vehicle by Mercedes-Benz, or are of a corresponding standard of quality.

! Information about the use of snow chain compatible AMG winter tires is applicable for AMG tires. Use of snow chains is only permissible with these tires.

! There is not enough space for snow chains on some wheel sizes. Observe the information under "Tires and wheels" in the "Technical Data" section to avoid damage to the vehicle or the wheels.

- Only use snow chains when driving on roads completely covered by snow. Do not exceed the maximum permissible speed of 30 mph (50 km/h). Remove the snow chains as soon as possible when you are no longer driving on snow-covered roads.
- Local regulations may restrict the use of snow chains. Applicable regulations must be observed if you wish to mount snow chains.

If you intend to install snow chains, please bear the following points in mind:

- you may not attach snow chains to all wheel-tire combinations; see the information under "Wheels and tires" in the "Technical data" section.
- mount snow chains only in pairs and only to the rear wheels. Observe the manufacturer's installation instructions.

! If snow chains are mounted on the front wheels, the snow chains could grind against the bodywork or components of the chassis. This could result in damage to the vehicle or the tires.

i You may wish to deactivate ESP® (▷ page 57) when pulling away with snow chains installed. This way you can allow the wheels to spin in a controlled manner, achieving an increased driving force (cutting action).

Tire pressure

Tire pressure specifications

Warning

Follow recommended tire inflation pressures. Do not underinflate tires. Underinflated tires wear excessively and/or unevenly, adversely affect handling and fuel economy, and are more likely to fail from being overheated.

Do not overinflate tires. Overinflated tires can adversely affect handling and ride comfort, wear unevenly, increase stopping distance, and result in sudden deflation (blowout) because they are more likely to become punctured or damaged by road debris, potholes etc.

Do not overload the tires by exceeding the specified load limit as indicated on the Tire and Loading Information placard on the driver's door B-pillar. Overloading the tires can overheat them, possibly causing a blowout. Overloading the tires can also result in handling or steering problems, or brake failure.

You will find a table of recommended tire pressures on the Tire and Loading Information placard on the B-pillar on the driver's side (▷ page 256). You will find a table of tire pressures for various operating conditions on the inside of your vehicle's fuel filler flap.

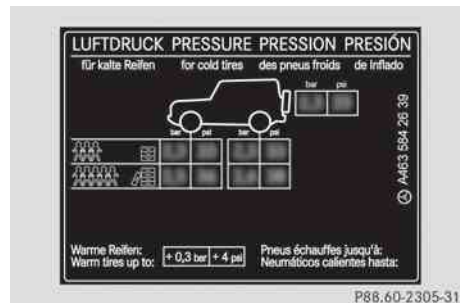

P88.60-2305-31

To test tire pressure, use a suitable tire pressure gauge. The outer appearance of a tire does not permit any reliable conclusion

about the tire pressure. On vehicles equipped with the electronic tire pressure monitoring system, the tire pressure can be checked using the on-board computer.

Warning

Should the tire pressure drop repeatedly:

- check the tire for foreign bodies.
- check whether the wheel is losing air or the valve is leaking.
- make sure that only a valve cap approved by Mercedes-Benz is installed on the tire valve.

Tire pressures that are too low have a negative effect on vehicle safety, which could lead you to cause an accident.

Only correct tire pressures when the tires are cold. The tires are cold when the vehicle has been parked for at least three hours or driven for less than 1 mile (1.6 km). The tire temperature changes depending on the outside temperature, the vehicle speed and the tire load. If the tire temperature changes by 18 °F (10 °C), the tire pressure changes by approximately 10 kPa (0.1 bar / 1.5 psi). Take this into account when checking the pressure of warm tires and only correct the tire pressure if it is too low for the current operating conditions. If you check the tire pressure when the tires are warm, the resulting value will be higher than if the tires were cold. This is normal. Do not reduce the tire pressure to the value specified for cold tires. The tire pressure would otherwise be too low.

Observe the recommended tire pressure specifications for cold tires on the Tire and Loading Information placard on the B-pillar on the driver's side.

- i** The specifications given on the following Tire and Loading Information placard are examples. Tire pressure specifications are vehicle-specific and may deviate from the data shown here. The tire pressures applicable to your vehicle can be found on

the Tire and Loading Information placard on your vehicle.

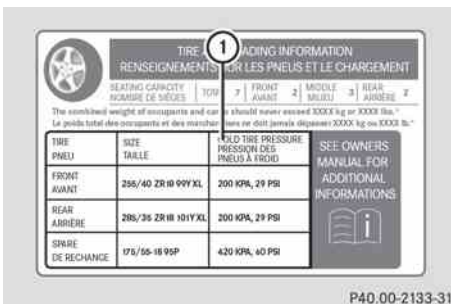

You will find recommended tire pressure specifications **1** for cold tires and for a fully loaded vehicle's Tire and Loading Information placard. The tire pressure information is applicable to all tires mounted at the factory.

Important notes on tire pressures

Warning

If the tire pressure drops repeatedly, check the tires for punctures from foreign objects and/or whether air is leaking from the valves or from around the rim.

The tire temperature and pressure increase when the vehicle is in motion. This is dependent on the driving speed and the load. If you wish to drive at high speeds of 100 mph (160 km/h) or higher when this is allowed, use the tire pressure table on the inside of the fuel filler flap to set the correct tire pressures when the tires are cold. If the tire pressure is not set correctly, this can lead to an excessive build up of heat and a sudden loss of pressure.

For more information, contact a qualified specialist workshop, e.g. an authorized Mercedes-Benz Center.

- i** Ride comfort may be affected if the tire pressure is adjusted to the recommended value for speeds of over 100 mph (160 km/h).

Make sure that the tire pressure for normal speeds is adopted again.

Additional specifications of tire pressure values for loads can also be found on the tire pressure table on the inside of the fuel filler flap.

Observe the following for the tire pressure on the spare wheel:

- the tire and loading information table on the B-pillar on the driver's side.
- the tire pressure sticker on the inside of the fuel filler flap.

i The specifications shown in the examples in the tire pressure tables are only examples. Tire pressure specifications are vehicle-specific and may deviate from the data shown here. The tire pressure specifications that are valid for your vehicle can be found on your vehicle's tire pressure table.

If no other data is stated, the tire pressures specified on the fuel filler flap apply for all tires approved for this vehicle.

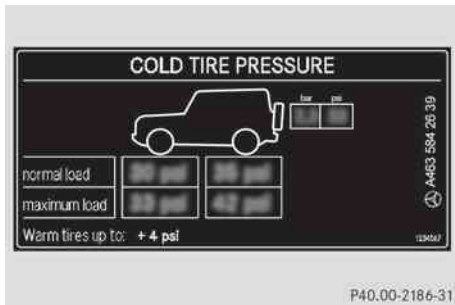

Tire pressure table for all approved tires installed at the factory (example)

If a tire size precedes a tire pressure, the tire pressure information following is only valid for that tire size. The load conditions "partially laden" and "fully laden" are defined in the table for different numbers of passengers and amounts of luggage. The actual number of seats may differ from this.

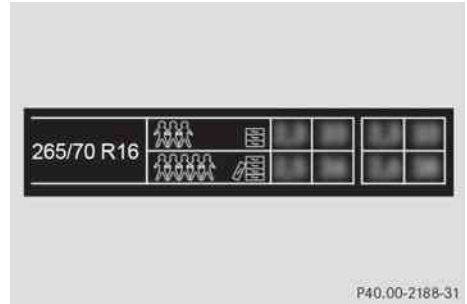

Tire pressure table with tire sizes (example)

Some tire pressure tables only show the rim diameter instead of the complete tire size, e.g. **R16**. The rim diameter is part of the tire size and can be found on the tire sidewall (> page 263).

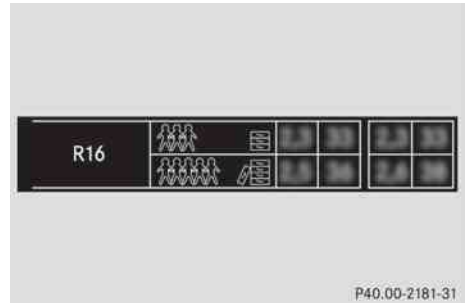

Tire pressure too low or too high

Underinflation

Warning

Follow recommended tire inflation pressures.

Do not underinflate tires. Underinflated tires wear excessively and/or unevenly, adversely affect handling and fuel economy, and are more likely to fail from being overheated.

Underinflated tires may:

- wear quickly and unevenly
- have an adverse effect on fuel consumption
- overheat leading to tire defects
- have an adverse effect on handling characteristics

Overinflation

Warning

Follow recommended tire inflation pressures.

Do not overinflate tires. Overinflated tires can adversely affect handling and ride comfort, wear unevenly, increase stopping distance, and result in sudden deflation (blowout) because they are more likely to become punctured or damaged by road debris, potholes etc.

Overinflated tires may:

- have an adverse effect on handling characteristics
- wear quickly and unevenly
- be more susceptible to damage
- have an adverse effect on ride comfort
- increase the braking distance

Maximum tire pressure

Warning

Never exceed the maximum tire inflation pressure. Follow recommended tire inflation pressures.

Do not underinflate tires. Underinflated tires wear excessively and/or unevenly, adversely affect handling and fuel economy, and are more likely to fail from being overheated.

Do not overinflate tires. Overinflated tires can adversely affect handling and ride comfort, wear unevenly, increase stopping distance, and result in sudden deflation (blowout) because they are more likely to become punctured or damaged by road debris, potholes etc.



① Maximum permissible tire pressure (example)

i The actual values for tires are vehicle-specific and may deviate from the values in the illustration.

Always observe the recommended tire pressure for your vehicle when adjusting the tire pressure (> page 249).

Checking the tire pressures

Important safety notes

Warning

Follow recommended tire inflation pressures.

Do not underinflate tires. Underinflated tires wear excessively and/or unevenly, adversely affect handling and fuel economy, and are more likely to fail from being overheated.

Do not overinflate tires. Overinflated tires can adversely affect handling and ride comfort, wear unevenly, increase stopping distance, and result in sudden deflation (blowout) because they are more likely to become punctured or damaged by road debris, potholes etc.

Do not overload the tires by exceeding the specified load limit as indicated on the Tire and Loading Information placard on the driver's door B-pillar. Overloading the tires can overheat them, possibly causing a blowout. Overloading the tires can also result in handling or steering problems, or brake failure.

Check the tire pressures at least once a month.

Only check and correct tire pressures when the tires are cold (▷ page 249).

Checking the tire pressure manually

To determine and set the correct tire pressure, proceed as follows:

- ▶ Remove the valve cap of the tire that is to be checked.
- ▶ Press the tire pressure gauge securely onto the valve.
- ▶ Read the tire pressure and compare it with the recommended value on the tire and loading information table on the B-pillar on the driver's side of your vehicle.
- ▶ If necessary, increase the tire pressure to the recommended value (▷ page 249).
- ▶ If the tire pressure is too high, release air by pressing down the metal pin in the valve using the tip of a pen, for example. Then, check the tire pressure again using the tire pressure gauge.
- ▶ Screw the valve cap onto the valve.
- ▶ Repeat these steps for the other tires.

Tire pressure monitor

Important safety notes

If a tire pressure monitor system is installed, the vehicle's wheels have sensors that monitor the tire pressures in all four tires. The tire pressure monitor warns you when the pressure drops in one or more of the tires. The tire pressure monitor only functions if the correct wheel electronics units are installed on all wheels.

The tire pressure monitor has a yellow warning lamp in the instrument cluster for indicating pressure loss/malfunctions (USA) or pressure loss (Canada). Whether the warning lamp flashes or lights up indicates whether a tire pressure is too low or the tire pressure monitoring system is malfunctioning:

- If the warning lamp is lit continuously, the tire pressure on one or more tires is significantly too low. The tire pressure monitor is not malfunctioning.
- USA only: if the warning lamp flashes for 60 seconds and then remains lit constantly, the tire pressure monitor is malfunctioning.

Warning!

The TPMS does not indicate a warning for wrongly selected inflation pressures. Always adjust tire inflation pressure according to the Tire and Loading Information placard or the supplemental tire inflation pressure information on the inside of the fuel filler flap. The TPMS is not able to issue a warning due to a sudden dramatic loss of pressure (e.g. tire blowout caused by a foreign object). In this case bring the vehicle to a halt by carefully applying the brakes and avoiding abrupt steering maneuvers.

Warning

Each tire, including the spare (if provided), should be checked at least once a month when cold and inflated to the inflation pressure recommended by the vehicle manufacturer on the Tire and Loading Information placard on the driver's door B-pillar or the tire inflation pressure label on the inside of the fuel filler flap. If your vehicle has tires of a different size than the size indicated on the Tire and Loading Information placard or the tire inflation pressure label, you should determine the proper tire inflation pressure for those tires.

As an added safety feature, your vehicle has been equipped with a tire pressure monitoring system (TPMS) that illuminates a low tire

pressure telltale when one or more of your tires are significantly underinflated. Accordingly, when the low tire pressure telltale illuminates, you should stop and check your tires as soon as possible, and inflate them to the proper pressure. Driving on a significantly underinflated tire causes the tire to overheat and can lead to tire failure.

Underinflation also reduces fuel efficiency and tire tread life, and may affect the vehicle's handling and stopping ability. Please note that the TPMS is not a substitute for proper tire maintenance, and it is the driver's responsibility to maintain correct tire pressure, even if underinflation has not reached the level to trigger illumination of the TPMS low tire pressure telltale.

USA only:

Your vehicle has also been equipped with a TPMS malfunction indicator to indicate when the tire pressure monitoring system is not operating properly. The TPMS malfunction indicator is combined with the low tire pressure telltale. When the system detects a malfunction, the telltale will flash for approximately one minute and then remain continuously illuminated. This sequence will continue upon subsequent vehicle start-ups as long as the malfunction exists. When the malfunction indicator is lit, the system may not be able to detect or signal low tire pressure as intended.

TPMS malfunctions may occur for a variety of reasons, including the installation of incompatible replacement or alternate tires or wheels on the vehicle that prevent the TPMS from functioning properly. Always check the TPMS malfunction telltale after replacing one or more tires or wheels on your vehicle to ensure that the replacement or alternate tires and wheels allow the TPMS to continue to function properly.

i USA only:

If the tire pressure monitor is malfunctioning, it may take more than 10 minutes for the tire pressure warning

lamp to inform you of the malfunction by flashing for 60 seconds and then remaining lit.

When the malfunction has been rectified, the tire pressure warning lamp goes out after driving for a few minutes.

Information on tire pressures is displayed in the multifunction display. After a few minutes of driving, the current tire pressure of each tire is shown in the multifunction display.

i The tire pressure values indicated by the on-board computer may differ from those measured at a gas station with a pressure gauge. The tire pressures shown by the on-board computer refer to those measured at sea level. At high altitudes, the tire pressure values indicated by a pressure gauge are higher than those shown by the on-board computer. In this case, do not reduce the tire pressures.

i The operation of the tire pressure monitor can be affected by interference from radio transmitting equipment (e.g. radio headphones, two-way radios) that may be being operated in or near the vehicle.

i USA only:

This device complies with Part 15 of the FCC Rules. Operation is subject to the following two conditions:

1. This device may not cause harmful interference, and
2. This device must withstand any interference received, including interference that may cause undesired operation.

Unauthorized modifications to the device can lead to the invalidation of the operating agreement of the device.

i Canada only:





This device complies with the RSS-210 Rules from Industry Canada. Operation is subject to the following two conditions:

1. This device may not cause harmful interference, and

2. This device must accept any interference received, including interference that may cause undesired operation.

Unauthorized modifications to the device can lead to the invalidation of the operating agreement of the device.

Checking tire pressure electronically

- ▶ Make sure that the SmartKey is in position 2 (▷ page 117) in the ignition lock.
- ▶ Press and hold the  or  button on the multifunction steering wheel until the standard display appears in the multifunction display (▷ page 160).
- ▶ Press and hold the  or  button until the current tire pressure of each tire is shown in the multifunction display.

If the vehicle has been parked for over 20 minutes, the **Tire pressure displayed only after driving for a few minutes** message appears.

- ❗ If a spare wheel is installed, the system may continue to show the tire pressure of the wheel that has been removed for a few minutes. If this occurs, note that the value displayed for the position where the spare tire is installed is not the same as the spare tire's current tire pressure.

Tire pressure monitor warning messages

If the tire pressure monitor detects a significant pressure loss on one or more tires, a warning message is shown in the multifunction display. A warning tone also sounds and the tire pressure warning lamp lights up in the instrument cluster.

Each tire that is affected by a significant loss of pressure is highlighted by a red rectangle.

- ❗ If the wheel positions on the vehicle are interchanged, the tire pressures may be displayed for the wrong positions for a short time. This is rectified after a few

minutes of driving, and the tire pressures are displayed for the correct positions.

Restarting the tire pressure monitor

Warning



It is the driver's responsibility to set the tire inflation pressure to the recommended cold tire inflation pressure. Underinflated tires affect the ability to steer or brake the vehicle. You might lose control over the vehicle.

When you restart the tire pressure monitor, all existing warning messages are deleted and the warning lamps go out. The monitor uses the currently set tire pressures as the reference values for monitoring.



The tire pressure monitor must be restarted when you set the tire pressure to a new value (as a result of changed drive or load characteristics, for example). The tire pressure monitor then monitors the new tire pressure values.

- ❗ Canada only: in most cases, the tire pressure monitor recognizes the new reference values automatically. However, you can also define reference values manually as described here.

Restart the tire pressure monitor after you have set the tire pressure to the value recommended for the desired driving situation (▷ page 249). Only correct tire pressures on cold tires. Comply with the recommended tire pressures on the tire and loading information table on the B-pillar on the driver's side. Additional tire pressure values for driving at high speeds or with heavy loads can be found in the tire pressure table on the inside of the fuel filler flap.

- ▶ Make sure that the tire pressure is correct on all four wheels.
- ▶ Make sure that the SmartKey is in position 2 in the ignition lock.
- ▶ Press and hold the  or  button on the multifunction steering wheel until the

standard display appears in the multifunction display (▷ page 160).

- ▶ Press and hold the  or  button until the tire pressure of each wheel or the **Tire pressure displayed only after driving for a few minutes** message appears.
- ▶ Press the reset button on the instrument cluster (▷ page 26). The **Restart Tire Pres. Monitor?** message appears in the multifunction display.

If you wish to confirm the restart:

- ▶ Press the  button. The **Tire Pres. Monitor Restarted** message appears in the multifunction display. After driving for a few minutes, the system checks whether the current tire pressures are within the specified range. The new tire pressures are then accepted as reference values and monitored.

If you wish to cancel the restart:

- ▶ Press the  button. The tire pressure values stored at the last restart will continue to be monitored.

Loading the vehicle

Instruction labels for tires and loads

Warning

Do not overload the tires by exceeding the specified load limit as indicated on the Tire and Loading Information placard on the driver's door B-pillar. Overloading the tires can overheat them, possibly causing a blowout. Overloading the tires can also result in handling or steering problems, or brake failure.

Two instruction labels on your vehicle show the maximum possible load.

- (1) The Tire and Loading Information placard on the B-pillar on the driver's side. The Tire and Loading Information placard shows the maximum permissible number of occupants and the maximum permissible vehicle load. It also contains details of the tire sizes and corresponding pressures for tires installed at the factory.
- (2) The vehicle identification plate is on the B-pillar on the driver's side. The vehicle identification plate informs you of the gross vehicle weight rating. It is made up of the vehicle weight, all vehicle occupants, the fuel and the cargo. You can also find information about the maximum gross axle weight rating on the front and rear axle.

The maximum gross axle weight rating is the maximum weight that can be carried by one axle (front or rear axle). Never exceed the maximum load or the maximum gross axle weight rating for the front or rear axle.



① B-pillar, driver's side

Maximum permissible gross vehicle weight rating

- ① The specifications shown on the Tire and Loading Information placard in the illustration are examples. The maximum permissible gross vehicle weight rating is

vehicle-specific and may differ from that in the illustration. You can find the valid maximum permissible gross vehicle weight rating for your vehicle on the Tire and Loading Information placard.

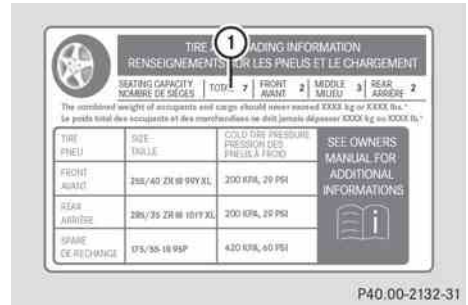
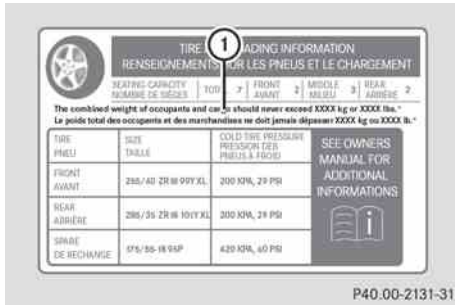

Maximum number of seats ① determines the maximum number of occupants allowed to travel in the vehicle. This information can be found on Tire and Loading Information placard.

- ▶ The Tire and Loading Information placard gives you details on maximum permissible gross vehicle weight rating ①: "The gross weight of occupants and luggage must never exceed XXX kilograms or XXX pounds."

The gross weight of all vehicle occupants, cargo, luggage and trailer load/noseweight (if applicable) must not exceed the specified value.

Number of seats

- ① The specifications shown on the Tire and Loading Information placard in the illustration are examples. The number of seats is vehicle-specific and can differ from the details shown. The number of seats in your vehicle can be found on the Tire and Loading Information placard.

Determining the maximum load

Step-by-step instructions

The following steps have been developed as required of all manufacturers under Title 49, Code of U.S. Federal Regulations, Part 575 pursuant to the "National Traffic and Motor Vehicle Safety Act of 1966".

- ▶ **Step 1:** Locate the statement "The combined weight of occupants and cargo should never exceed XXX kg or XXX lbs." on your vehicle's tire and loading information table.
- ▶ **Step 2:** Determine the combined weight of the driver and passengers that will be traveling in your vehicle.
- ▶ **Step 3:** Subtract the combined weight of the driver and passengers from XXX kilograms or XXX lbs.
- ▶ **Step 4:** The resulting figure equals the available amount of cargo and luggage load capacity. For example, if the "XXX" amount equals 1400 lbs and there will be five 150 lbs passengers in your vehicle, the amount of available cargo and luggage load capacity is 650 lbs (1400 - 750 (5 x 150) = 650 lbs).

- ▶ **Step 5:** Determine the combined weight of luggage and cargo being loaded in/on the vehicle. For reasons of safety, that weight must not exceed the available cargo and luggage cargo capacity calculated in step 4.
- ▶ **Step 6 (if applicable):** If your vehicle will be towing a trailer, load from your trailer will be transferred to your vehicle. Consult this manual to determine how this reduces the available cargo and luggage load capacity of your vehicle (▶ page 260).

Example: step 1 to 3

The following table shows examples on how to calculate total load and cargo capacities with varying seating configurations and number and size of occupants. The following examples use a cargo limit of 1500 lbs (680 kg). **This is for illustration purposes only.** Make sure you always use the actual load limit for your vehicle stated on the vehicle's tire and loading information table (▷ page 256).

		Example 1	Example 2	Example 3
Step 1	Combined maximum weight of occupants and cargo (data from the Tire and Loading Information placard)	1500 lbs (680 kg)	1500 lbs (680 kg)	1500 lbs (680 kg)

		Example 1	Example 2	Example 3
Step 2	Number of people in the vehicle (driver and occupants)	5	3	1
	Distribution of the occupants	Front: 2 Rear: 3	Front: 1 Rear: 2	Front: 1
	Weight of the occupants	Occupant 1: 150 lbs (68 kg) Occupant 2: 180 lbs (82 kg) Occupant 3: 160 lbs (73 kg) Occupant 4: 140 lbs (63 kg) Occupant 5: 120 lbs (54 kg)	Occupant 1: 200 lbs (91 kg) Occupant 2: 190 lbs (86 kg) Occupant 3: 150 lbs (68 kg)	Occupant 1: 150 lbs (68 kg)
	Gross weight of all occupants	750 lbs (340 kg)	540 lbs (245 kg)	150 lbs (68 kg)

		Example 1	Example 2	Example 3
Step 3	Permissible cargo and trailer load/noseweight (maximum gross vehicle weight rating from the Tire and Loading Information placard minus the gross weight of all occupants)	1500 lbs (680 kg) - 750 lbs (340 kg) = 750 lbs (340 kg)	1500 lbs (680 kg) - 540 lbs (245 kg) = 960 lbs (435 kg)	1500 lbs (680 kg) - 150 lbs (68 kg) = 1350 lbs (612 kg)

The higher the weight of all the occupants, the smaller the maximum load for luggage. Further information can be found under "trailer load/noseweight" (▷ page 260).

Vehicle identification plate

Even if you have calculated the total load carefully, you should still make sure that the gross vehicle weight rating and the gross axle weight rating are not exceeded. Details can be found on the vehicle identification plate on the B-pillar on the driver's side of the vehicle (▷ page 256).

Gross vehicle weight: the gross weight of the vehicle, all passengers, cargo and trailer load/noseweight (if applicable) must not exceed the permissible gross vehicle weight.

Gross axle weight rating: the maximum permissible load that can be carried by one axle (front or rear axle).

To ensure that your vehicle does not exceed the maximum permissible values (gross vehicle weight and maximum gross axle weight rating), have your loaded vehicle (including driver, occupants, cargo, and full trailer load if applicable) weighed on a suitable vehicle weighbridge.

trailer load/noseweight is usually approximately 10% of the gross weight of the trailer and its load.

Only use a trailer coupling that has been approved for your vehicle by Mercedes-Benz. Comply with the manufacturer's operating instructions for operation, care and maintenance.

Maximum tire load

Warning

Do not overload the tires by exceeding the specified load limit as indicated on the Tire and Loading Information placard on the driver's door B-pillar. Overloading the tires can overheat them, possibly causing a blowout. Overloading the tires can also result in handling or steering problems, or brake failure.

Trailer load/noseweight

The trailer load/noseweight affects the gross weight of the vehicle. If a trailer is attached, the trailer load/noseweight is included in the load along with occupants and luggage. The



- i** The actual values for tires are vehicle-specific and may deviate from the values in the illustration.

Maximum tire load ① is the maximum permissible weight for which the tire is approved.

Further information on tire loads (▷ page 262).

Uniform Tire Quality Grading Standards

Overview of Tire Quality Grading Standards

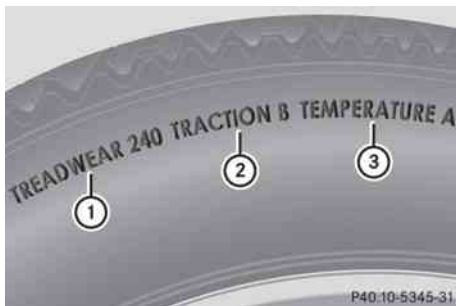

The Uniform Tire Quality Grading Standards are U.S. government specifications. Their purpose is to provide drivers with uniform reliable information on tire performance data. Tire manufacturers have to grade tires using three performance factors: tread wear ①, tire traction ②, and heat resistance ③. All tires sold in North America are provided with the corresponding quality grading markings

on the sidewall of the tire, even though these regulations do not apply to Canada.

- i** The actual values for tires are vehicle-specific and may deviate from the values in the illustration.

Where applicable, the tire grading information can be found on the tire sidewall between the tread shoulder and maximum tire width.

For example:

Tread wear	Traction	Temperature
200	AA	A

All passenger car tires must conform to the statutory safety requirements in addition to these grades.

Tread wear

The tread wear grade is a comparative rating based on the wear rate of the tire when tested under controlled conditions on a specified U.S. government test track. For example, a tire graded 150 would wear one and one-half times as well on the government test track as a tire graded 100.

The relative performance of tires depends upon the actual conditions of their use, however, and may depart significantly from the norm, due to variations in driving habits, service practices and differences in road characteristics and climate conditions.

Traction

Warning

The traction grade assigned to this tire is based on straight-ahead braking traction tests, and does not include acceleration, cornering, hydroplaning, or peak traction characteristics.

The traction grades, from highest to lowest, are AA, A, B, and C. Those grades represent

the tire's ability to stop on a wet surface as measured under controlled conditions on specified government test surfaces of asphalt and concrete. A tire marked C may have poor traction performance.

Warning

If ice has formed on the road, tire traction will be substantially reduced. Under such weather conditions, drive, steer and brake with extreme caution.

The safe speed on a wet, snow covered or icy road is always lower than on dry road surfaces.

You should pay special attention to road conditions when temperatures are around the freezing point.

Mercedes-Benz recommends a minimum tread depth of $\frac{1}{6}$ in (4 mm) for all four winter tires (> page 248) to maintain normal driving characteristics in winter. Winter tires can reduce the braking distance on snow covered surfaces in comparison to summer tires. The braking distance is still much further than on surfaces that are not icy or covered with snow. Take appropriate care when driving.

! Avoid wheelspin. This can lead to damage to the drive train.

Temperature

Warning

The temperature grade for this tire is established for a tire that is properly inflated and not overloaded. Excessive speed, underinflation, or excessive loading, either separately or in combination, can cause excessive heat build-up and possible tire failure.

The temperature grades are A (the highest), B, and C. These represent the tire's resistance to the generation of heat and its ability to dissipate heat when tested under controlled conditions on a specified indoor

laboratory test wheel. Sustained high temperature can cause the material of the tire to degenerate and reduce tire life, and excessive temperature can lead to sudden tire failure. The grade C corresponds to a level of performance which all passenger car tires must meet under the Federal Motor Vehicle Safety Standard No. 109. Grades B and A represent higher levels of performance on the laboratory test wheel than the minimum required by law.

Tire labeling

Overview of tire labeling

The following markings are on the tire in addition to the tire name (sales designation) and the manufacturer's name:

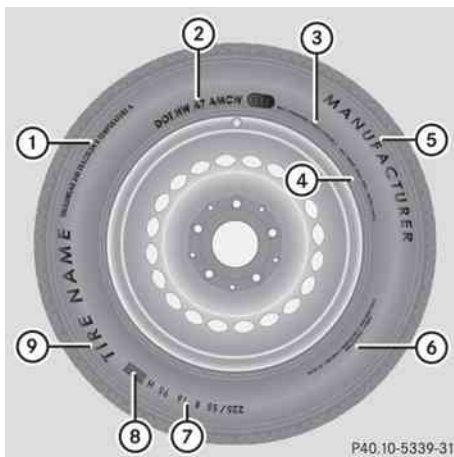

- ① Uniform tire Quality Grading Standard (> page 261)
- ② DOT, Tire Identification Number (> page 265)
- ③ Maximum tire load (> page 260)
- ④ Maximum tire pressure (> page 252)
- ⑤ Manufacturer
- ⑥ Tire material (> page 266)
- ⑦ Tire size designation, load-bearing capacity and speed index (> page 263)

- ⑧ Load index (▷ page 265)
- ⑨ Tire name
- ⑩ Tire data is vehicle-specific and may deviate from the data in the example.

Indication of tire size, load-bearing capacity and speed index



- ① Tire width
- ② Nominal aspect ratio in %
- ③ Tire code
- ④ Rim diameter
- ⑤ Load bearing index
- ⑥ Speed index

- ⑩ Tire data is vehicle-specific and may deviate from the data in the example.

General: depending on the manufacturer's standards, the size imprinted in the tire wall may not contain any letters or may contain one letter that precedes the size description. If there is no letter preceding the size description (as shown above): these are passenger vehicle tires according to European manufacturing standards.

If "P" precedes the size description: these are passenger vehicle tires according to U.S. manufacturing standards.

If "LT" precedes the size description: these are light truck tires according to U.S. manufacturing standards.

If "T" precedes the size description: these are compact emergency spare wheels at high tire

pressure, to be used only temporarily in an emergency.

Tire width: tire width ① shows the nominal tire width in millimeters.

Nominal aspect ratio: aspect ratio ② is the ratio between the tire height and tire width and is shown as a percentage. The aspect ratio is calculated by dividing the tire width by the tire height.

Tire code: tire code ③ specifies the tire type. "R" represents radial tires. "D" represents diagonal tires, "B" represents diagonal radial tires.

Optionally, tires with a maximum speed of over 149 mph (240 km/h) may have "ZR" in the size description depending on the manufacturer (e.g. 245/40 ZR 18).

Rim diameter: rim diameter ④ is the diameter of the bead seat, not the diameter of the rim flange. The rim diameter is specified in inches (in).

Load bearing index: load bearing index ⑤ is a numerical code that specifies the maximum load-bearing capacity of a tire.

⚠ Warning

The tire load rating must always be at least half of the GAWR of your vehicle. Otherwise, sudden tire failure may be the result which could cause an accident and/or serious injury to you or others.

Always replace rims and tires with rims and tires having the same specifications (designation, manufacturer and type) as shown on the original part.

⚠ Warning

Do not overload the tires by exceeding the specified load limit as indicated on the Tire and Loading Information placard on the driver's door B-pillar. Overloading the tires can overheat them, possibly causing a blowout. Overloading the tires can also result in handling or steering problems, or brake failure.

Example:

The load bearing index 91 is equivalent to a maximum load of 1356 lbs (615 kg) that the tire can carry. For further information on the maximum tire load in kilograms and pounds, see (▷ page 260).

For further information on the load bearing index, see Load index (▷ page 265).

Speed index: speed index ⑥ specifies the approved maximum speed of the tire.

Warning

Even when permitted by law, never operate a vehicle at speeds greater than the maximum speed rating of the tires.

Exceeding the maximum speed for which tires are rated can lead to sudden tire failure, causing loss of vehicle control and possibly resulting in an accident and/or serious personal injury and possible death, for you and for others.

Regardless of the speed index, always observe the speed limits. Drive carefully and adapt your driving style to the traffic conditions.

Summer tires

Index	Speed rating
Q	Up to 100 mph (160 km/h)
R	Up to 106 mph (170 km/h)
S	Up to 112 mph (180 km/h)
T	Up to 118 mph (190 km/h)
H	Up to 130 mph (210 km/h)
V	Up to 149 mph (240 km/h)
W	Up to 168 mph (270 km/h)
Y	Up to 186 mph (300 km/h)
ZR...Y	Up to 186 mph (300 km/h)

Summer tires

Index	Speed rating
ZR...(..Y)	above 186 mph (300 km/h)
ZR	above 149 mph (240 km/h)

- Optionally, tires with a maximum speed rating of more than 149 mph (240 km/h) may have "ZR" in the size description depending on the manufacturer (e.g. 245/40 ZR 18).

The service specification is made up of load bearing index ⑤ and speed index ⑥.

- If the size description of your tire includes "ZR" and there are no service specifications, ask the tire manufacturer in order to find out the maximum speed.

If a service specification is available, the maximum speed is limited according to the speed index in the service specification.

Example: 245/40 ZR 18 97 Y. In this example, "97 Y" is the service specification. The letter "Y" represents the speed index and the maximum speed of the tire is limited to 186 mph (300 km/h).

- Every tire that has a maximum speed rating of more than 186 mph (300 km/h) must have "ZR" in the size description **and** the service specification must be given in brackets. Example: 275/40 ZR 18 (99 Y). The speed index "(Y)" shows that the maximum speed of the tire is above 186 mph (300 km/h). Ask the tire manufacturer to find out the maximum speed.

All-weather tires and winter tires

Index	Speed rating
Q M+S ²¹	up to 100 mph (160 km/h)
T M+S ²¹	up to 118 mph (190 km/h)

All-weather tires and winter tires

Index	Speed rating
H M+S ²¹	up to 130 mph (210 km/h)
V M+S ²¹	up to 149 mph (240 km/h)

i Not all tires that have the M+S identification offer the driving characteristics of winter tires. In addition to the M+S marking, winter tires also have the  snowflake symbol on the tire wall. Tires with this marking fulfill the requirements of the Rubber Manufacturers Association (RMA) and the Rubber Association of Canada (RAC) regarding the tire traction on snow and have been especially developed for driving on snow.

An electronic speed limiter prevents your vehicle from exceeding a speed of 130 mph (210 km/h).

The speed index of tires mounted at the factory may be higher than the maximum speed that the electronic speed limiter permits.

Make sure that your tires have the required speed index as specified in the "tires" section (▷ page 272), e.g. if you buy new tires.

Further information about reading tire data can be obtained from any qualified specialist workshop, e.g. an authorized Mercedes-Benz Center.

Load identification

i Tire data is vehicle-specific and may deviate from the data in the example.

In addition to the load bearing index, load index **1** may be imprinted after the letters that identify speed index **6** (▷ page 263) on the sidewall of the tire.

- If no specification is given: no text (as in the example above), represents a standard load (SL) tire
- XL or Extra Load: represents a reinforced tire
- Light Load: represents a light load tire
- C, D, E: represents a load range that depends on the maximum load that the tire can carry at a certain pressure

DOT, Tire Identification Number (TIN)

U.S. tire regulations prescribe that every manufacturer of new tires or retreader has to imprint a TIN in or on the sidewall of each tire produced.

²¹ or M+S  for winter tires.

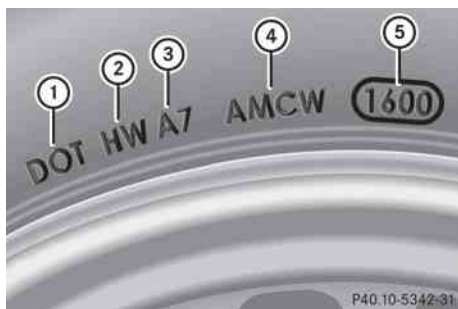

The TIN is a unique identification number. The TIN enables the tire manufacturers to inform purchasers of recalls and other safety-relevant matters. It makes it possible for the purchaser to easily identify the affected tires. The TIN is made up of manufacturer identification code ②, tire size ③, tire type code ④ and manufacturing date ⑤.

- ① Tire data is vehicle-specific and may deviate from the data in the example.

DOT (Department of Transportation): tire symbol ① marks that the tire complies with the requirements of the U.S. Department of Transportation.

Manufacturer identification code: manufacturer identification code ② provides details on the tire manufacturer. New tires have a code with two symbols. Retreaded tires have a code with four symbols.

Further information about retreaded tires (> page 246).

Tire size: identifier ③ describes the tire size.

Tire type code: tire type code ④ can be used by the manufacturer as a code to describe specific characteristics of the tire.

Date of manufacture: date of manufacture ⑤ provides information about the age of a tire. The first and second positions represent the week of manufacture, starting with "01" for the first calendar week. Positions three and four represent the year of manufacture. For example, a tire that is marked with "3208", was manufactured in week 32 in 2008.

Characteristics of the tire



- ① Tire data is vehicle-specific and may deviate from the data in the example.

This information describes the type of tire cord and the number of layers in sidewall ① and under tire tread ②.

Definitions for tires and loading

Tire structure and characteristics

Describes the number of layers or the number of rubber-coated belts in the tread and the sidewall of the tire. These are made of steel, nylon, polyester and other materials.

Bar

Metric unit for tire pressure.

14.5038 pounds per square inch (psi) and 100 kilopascals (kPa) are the equivalent of 1 bar.

DOT (Department of Transportation)

DOT marked tires fulfill the requirements of the United States Department of Transportation.

Average weight of the vehicle occupants

The number of occupants for which the vehicle is designed multiplied by 68 kilograms (150 lb).

Uniform Tire Quality Grading Standards

A uniform standard to grade the quality of tires with regards to tread quality, tire traction and temperature characteristics. The quality grading assessment is made by the manufacturer following specifications from the U.S. government. The quality grade of a tire is imprinted on the sidewall of the tire.

Recommended tire pressure

The recommended tire pressure for your vehicle under normal driving conditions. You will find the recommendation on the Tire and Loading Information placard on the B-pillar on the driver's side of your vehicle. The recommended tire pressure provides the best balance between handling characteristics, ride comfort and wear. Additional information on particular driving conditions is located on the tire pressure table on the inside of the fuel filler flap.

Increased vehicle weight due to optional equipment

This is the combined weight of all standard and optional equipment available for the vehicle, regardless of whether it is actually installed on the vehicle or not.

Wheel rim

This is the part of the wheel on which the tire is mounted.

GAWR (Gross Axle Weight Rating)

The GAWR is the maximum gross axle weight rating. The actual load on an axle must never exceed the gross axle weight rating. The gross axle weight rating can be found on the vehicle identification plate on the B-pillar on the driver's side.

Speed index

The speed index is part of the tire identification. It specifies the speed range for which the tire is approved.

GTW (Gross Trailer Weight)

The GTW is the sum of the weight of a trailer and the weight of the load, luggage, accessories etc. on the trailer.

GVW (Gross Vehicle Weight)

The gross vehicle weight includes the weight of the vehicle including fuel, tools, the spare wheel, accessories installed, occupants, luggage and the drawbar noseweight if applicable. The gross vehicle weight must not exceed the gross vehicle weight rating GVWR as specified on the vehicle identification plate on the B-pillar on the driver's side.

GVWR (Gross Vehicle Weight Rating)

The GVWR is the maximum permitted gross weight of the fully laden vehicle (weight of the vehicle including all accessories, occupants, fuel, luggage and the drawbar noseweight if applicable). The gross vehicle weight rating is specified on the vehicle identification plate on the B-pillar on the driver's side.

Maximum weight of the laden vehicle

The maximum weight is the sum of the curb weight of the vehicle, the weight of the

accessories, the maximum load and the weight of the optional equipment installed at the factory.

Kilopascal (kPa)

Metric unit for tire pressure. 6.9 kPa is the equivalent of 1 psi. Another unit for tire pressure is bar. 100 kilopascal (kPa) is the equivalent of 1 bar.

Load index

In addition to the load bearing index, the load index may also be imprinted on the sidewall of the tire. This specifies the load bearing capacity more precisely.

Curb weight

The weight of a vehicle with standard equipment, including the maximum capacity of fuel, oil and coolant and also includes the air-conditioning system and optional equipment if these are installed on the vehicle, but does not include passengers or luggage.

Maximum tire load

The maximum tire load is the maximum permissible weight in kilograms or lbs for which a tire is approved.

Maximum permissible tire pressure

Maximum permissible tire pressure for one tire.

Maximum load on one tire

Maximum load on one tire. This is calculated by dividing the maximum axle load of one axle by two.

PSI (pounds per square inch)

Standard unit of measurement for tire pressure.

Aspect ratio

Relationship between tire height and tire width in percent.

Tire pressure

This is pressure inside the tire applying an outward force to every square inch of the tire's surface. The tire pressure is specified in pounds per square inch (psi), in kilopascal (kPa) or in bar. The tire pressure should only be corrected when the tires are cold. For this, the vehicle must have been stationary for at least 3 hours or not have traveled more than 1.6 km (1 mile) in this time.

Tire tread

The part of the tire that comes into contact with the road.

Tire bead

The tire bead ensures that the tire sits securely on the wheel. There are several steel wires in the bead to prevent the tire from coming loose from the wheel rim.

Sidewall

The part of the tire between the tread and the tire bead.

Weight of optional extras

The combined weight of those optional extras that weigh more than the replaced standard part and more than 2.3 kg (5 lbs). These optional extras, such as high-performance

brakes, level control, a roof rack or a high-performance battery, are not included in the curb weight and the weight of the accessories.

TIN (Tire Identification Number)

This is a unique identification number which can be used by a tire manufacturer to identify tires, for example for a product recall, and thus identify the purchasers. The TIN is made up of the manufacturer's identity code, tire size, tire type code and the manufacturing date.

Load bearing index

The load bearing index (also load index) is a code that contains the maximum load bearing capacity of a tire.

Traction

Traction is the result of friction between the tires and the road surface.

TWR (permissible trailer drawbar noseweight)

The TWR is the maximum permissible weight that may act on the ball coupling of the trailer tow hitch.

Wear indicator

Narrow bars (tread wear bars) that are distributed over the tire tread. If the tire tread is level with the bars, the wear limit of $1/16$ in (1.6 mm) has been reached.

Distribution of the vehicle occupants

Distribution of vehicle occupants over designated seat positions in a vehicle.

Maximum permissible payload weight

Nominal load and luggage load plus 68 kilograms (150 lb) multiplied by the number of seats in the vehicle.

Changing a wheel

Flat tire

The "Roadside Assistance" section (> page 232) contains information and notes on how to deal with a flat tire. It also provides instructions on changing a wheel or mounting the spare wheel.

Interchanging the wheels

Warning

Rotate front and rear wheels only if the tires are of the same dimension.

If your vehicle is equipped with mixed-size tires (different tire dimensions front vs. rear), tire rotation is not possible.

Warning!

Have the tightening torque checked after changing a wheel. Wheels could become loose if not tightened with a torque of 96 lb-ft (130 Nm).

Only use genuine Mercedes-Benz wheel bolts specified for your vehicle's rims.

The wear patterns on the front and rear tires differ, depending on the operating conditions. Rotate the wheels before a clear wear pattern has formed on the tires. Front tires typically wear more on the shoulders and the rear tires in the center.

If your vehicle's tire configuration allows, you can rotate the wheels according to the intervals in the tire manufacturer's warranty book in your vehicle documents. If no warranty book is available, the tires should be rotated every 3000 to 6000 miles (5000 to 10000 km), or earlier if tire wear

requires. Do not change the direction of wheel rotation.

Clean the contact surfaces of the wheel and the brake disc thoroughly every time a wheel is interchanged. Check the tire pressure and reactivate the tire pressure monitor (> page 253) if necessary.

Information on changing a wheel and mounting the spare wheel (> page 232).

! On vehicles installed with a tire pressure monitor, electronic components are located in the wheel.

Tire-mounting tools should not be applied in the area of the valve, as this could damage the electronic components.

Always have the tires changed at a qualified specialist workshop, e.g. an authorized Mercedes-Benz Center.

Direction of rotation

Tires with a specified direction of rotation have additional benefits, e.g. if there is a risk of hydroplaning. You will only gain these benefits if the correct direction of rotation is maintained.

An arrow on the sidewall of the tire indicates its correct direction of rotation.

You may install the spare wheel against the direction of rotation. Adhere to the time restriction on use as well as the speed limitation specified on the spare wheel.

Storing wheels

Store tires that are not being used in a cool, dry and preferably dark place. Protect the tires from oil, grease, gasoline and diesel.

Cleaning the wheels

Warning

Do not use power washers with circular jet nozzles (concentrated-power jets) to clean

your vehicle, especially for cleaning tires. You could otherwise damage the tires and cause an accident.

Wheel and tire combinations

Please bear the following in mind

Warning

Replace rims or tires with the same designation, manufacturer and type as shown on the original part. For further information contact an authorized Mercedes-Benz Center. If incorrectly sized rims and tires are mounted, the wheel brakes or suspension components can be damaged. Also, the operating clearance of the wheels and the tires may no longer be correct.

Warning

Worn, old tires can cause accidents. If the tire tread is worn to minimum tread depth, or if the tires have sustained damage, replace them.

When replacing rims, only use genuine Mercedes-Benz wheel bolts specified for the particular rim type. Failure to do so can result in the bolts loosening and possibly an accident.

Retreaded tires are not tested or recommended by Mercedes-Benz, since previous damage cannot always be recognized on retreads. The operating safety of the vehicle cannot be assured when such tires are used.

Warning

If you feel a sudden significant vibration or ride disturbance, or you suspect that possible damage to your vehicle has occurred, you should turn on the hazard warning flashers, carefully slow down, and drive with caution to an area which is a safe distance from the road.

Inspect the tires and the vehicle underbody for possible damage. If the vehicle appears unsafe, have the vehicle towed to the nearest

authorized Mercedes-Benz Center or tire dealer for repairs.

Warning

Do not drive with a flat tire. A flat tire affects the ability to steer or brake the vehicle. You might lose control of the vehicle. Continued driving with a flat tire or driving at high speed with a flat tire will cause excessive heat build-up and possibly a fire.

i For safety reasons, Mercedes-Benz recommends that you only use tires, wheels and accessories which have been approved by Mercedes-Benz specifically for your vehicle.

These tires have been specially adapted for use with the control systems, such as ABS or ESP®, and are marked as follows:

- MO = Mercedes-Benz Original

Mercedes-Benz Original Extended tires may only be used on wheels that have been specifically approved by Mercedes-Benz.

Only use tires, wheels or accessories tested and approved by Mercedes-Benz. Certain characteristics, e.g. handling, vehicle noise emissions or fuel consumption, may otherwise be adversely affected. In addition, when driving with a load, tire dimension variations could cause the tires to come into contact with the bodywork and axle components. This could result in damage to the tires or the vehicle.

Mercedes-Benz accepts no liability for damage resulting from the use of tires, wheels or accessories other than those tested and approved.

Further information about tires, wheels and approved combinations can be obtained from any authorized Mercedes-Benz Center.

i The Tire and Load Information placard with the recommended tire pressures is attached to the B-pillar on the driver's side. Further information about driving at high

speeds or driving with vehicle loads that are lighter than the maximum vehicle load can be found in the tire pressure table on the inside of the fuel filler flap. Check tire pressures regularly, and only when the tires are cold. Comply with the maintenance recommendations of the tire manufacturer in the vehicle document wallet.

For further information on the recommended tire inflation pressure and on tire pressures for specific driving conditions, see (▷ page 249).

i Notes on vehicle tires:

Always:

- mount tires of the same size on a given axle (left/right)
- mount tires of the same type on your vehicle at a given time (summer tires, winter tires, all-weather tires, all-terrain tires)

i The following pages contain information on approved wheels and tire sizes for equipping your vehicle with winter tires. Winter tires are not available at the factory as standard equipment or optional extras. If you wish to fit approved winter tires to your vehicle, wheels of appropriate size may also be required as the sizes of the approved winter tires may differ from those of the original tires. This is dependent on the model and the equipment installed at the factory.

Wheels and tires as well as additional information are available from a qualified specialist workshop, e.g. an authorized Mercedes-Benz Center.

The tire and wheel combinations listed in the tables below apply to the following models:

V1	G 550
V2	G 55 AMG

Tires			
All-weather tires ²²	Alloy wheels	V1	V2
265/60 R18 110 VM+S	7.5 J x 18 H2 Wheel offset: 1.69 in (43 mm)	•	–
275/55 R19 111 VM+S ²³	9.5 J x 19 H2 Wheel offset: 1.97 in (50 mm)	–	•

Winter tires ^{22, 24}	Alloy wheels	V1	V2
265/60 R18 109HM+S 	7.5J x 18 H2 ET 63 Wheel offset: 1.69 in (43 mm)	–	•

Spare wheel			
All-weather tires ²²	Alloy wheels	V1	V2
265/60 R18 110 VM+S	7.5J x 18 H2 Wheel offset: 1.69 in (43 mm)	•	•

²² Radial tires.

²³ Use of snow chains is not permitted.

²⁴ Not available as standard equipment or optional equipment at the factory.

Vehicle equipment	274
Genuine Mercedes-Benz parts	274
Warranty	274
Vehicle identification plates	275
Service products and capacities	276
Vehicle data	281

Vehicle equipment

i This manual describes all the standard and optional equipment of your vehicle which was available at the time of purchase. Country-specific differences are possible. Please note that your vehicle may not be equipped with all features described. This also applies to safety-relevant systems and functions.

Genuine Mercedes-Benz parts

All authorized Mercedes-Benz Centers have a stock of genuine Mercedes-Benz parts that are required for servicing and repair work. In addition, strategically located parts delivery centers provide for quick and reliable parts service.

There are more than 300,000 different genuine Mercedes-Benz parts available for Mercedes-Benz models.

Genuine Mercedes-Benz parts are subject to strict quality control. Each part has been specially developed, manufactured or selected for Mercedes-Benz vehicles and fine-tuned for them.

Therefore, only genuine Mercedes-Benz parts should be used.

! The use of non-approved parts could impair the vehicle's safety. For this reason, Mercedes-Benz recommends genuine Mercedes-Benz parts and approved conversion parts and accessories for your vehicle model.

Environmental note

Daimler AG also supplies reconditioned major assemblies and parts which are of the same quality as new parts. They are covered by the same Limited Warranty entitlements as new parts.

Always specify the vehicle identification number and engine number when ordering genuine Mercedes-Benz parts. You will find

these numbers on the vehicle identification plates on your vehicle, for example ([▷ page 275](#)).

Warranty

The Service and Warranty Information booklet contains detailed information about the warranties covering your vehicle.

Your authorized Mercedes-Benz Center will replace and repair any factory-installed parts based on the terms and conditions of the following warranties:

- New Vehicle Limited Warranty
- Emission System Warranty
- Emission Performance Warranty
- California, Connecticut, Maine, Massachusetts, New York, Pennsylvania, Rhode Island and Vermont Emission Control System Warranty
- State Warranty Enforcement Laws (Lemon Laws)

Replacement parts and accessories are covered by the Mercedes-Benz Parts and Accessories warranties. You can obtain information about this from any authorized Mercedes-Benz Center.

i Should you lose your Service and Warranty Information booklet, have an authorized Mercedes-Benz Center arrange for a replacement. It will be mailed to you.

Vehicle identification plates

Vehicle identification plate with vehicle identification number (VIN) and paint code number

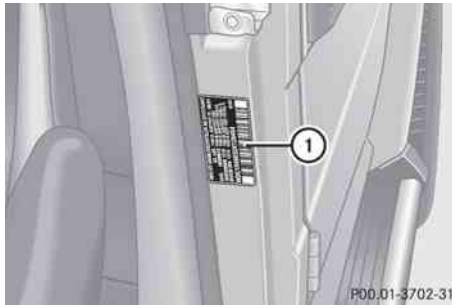

- ▶ Open the front left-hand door. You will see vehicle identification plate ①.

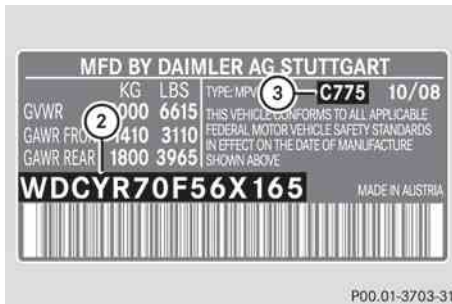

Vehicle identification plate (example, USA only)

- ② VIN
- ③ Paint code



Vehicle identification plate (example, Canada only)

- ② VIN
- ③ Paint code

① The data shown on the vehicle identification plate is used only as an example. This data is different for every vehicle and can deviate from the data shown here. The correct data for your vehicle can be found on the vehicle identification plate that is mounted on your vehicle.

Vehicle identification number (VIN)

The vehicle identification number (VIN) can be found in the following locations:

- on the vehicle identification plate (▶ page 275)
- stamped into the chassis on the right-hand side (when viewed in the direction of travel)
- on the lower edge of the windshield



- ① VIN (stamped into the chassis on the right-hand side, when viewed in the direction of travel)

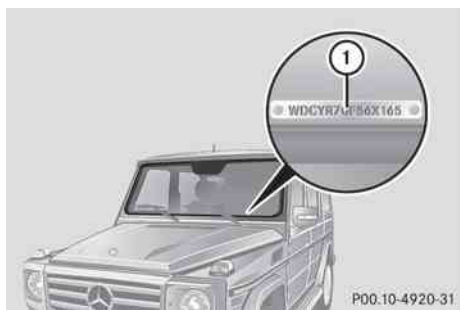

- ① VIN (on the lower edge of the windshield)

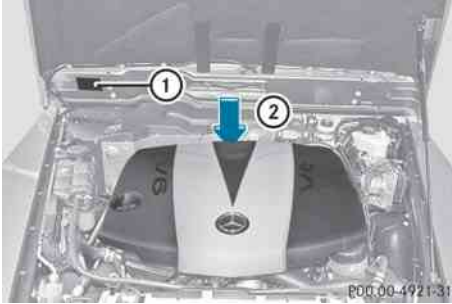
Engine number

G 550 (example)

- ① Plate with information on emissions testing, including the confirmation of the emission standards at U.S. Federal level as well as for California
- ② Engine number (stamped into the crankcase)

Keep service fluids out of the reach of children.

For health reasons, you should prevent service fluids from coming into direct contact with your skin or clothing.

If a service fluid is swallowed, contact a physician immediately.

Service products and capacities**Important safety notes**

Service products include the following:

- fuels
- lubricants (e.g. engine oil, transmission oil)
- coolant
- brake fluid
- windshield washer fluid

Vehicle components and their respective lubricants must match. You should therefore only use products that have been tested and approved by Mercedes-Benz.

Information on tested and approved products can be obtained at an authorized Mercedes-Benz Center or on the Internet at <http://www.mbusa.com> (USA only).

 **Warning**

Comply with all valid regulations with respect to handling, storing and disposing of service fluids. Otherwise, you could endanger persons or the environment.

Capacities			
	Vehicle model	Capacity	Fuel, coolant, lubricants etc.
Engine oil and filter	G 550	9.5 US qt (9.0 l)	Approved engine oils
	G 55 AMG	9.0 US qt (8.5 l)	
Power steering	All models	Approximately 1.06 US qt (1.0 l)	MB power steering fluid or approved Dexron III ATF
Cooling system	G 550	Approximately 12.8 US qt (12.1 l)	MB 325.0 corrosion inhibitor/antifreeze agent
	G 55 AMG	Approximately 13.4 US qt (12.7 l)	
Tank capacity	G 550	25.4 US gal (96.0 l)	Premium-grade unleaded gasoline (at least 91 octane, average value between 96 RON/86 MON)
	G 55 AMG	25.1 US gal (95.0 l)	
Reserve	All models	Approximately 5.3 US gal (20.0 l)	
Air-conditioning system	All models	–	Refrigerant R134a and special PAG lubricant (never R 12)
Windshield/headlamp cleaning system	All models	7.4 US qt (7.0 l)	MB windshield washer concentrate ²⁵ (▷ page 281) Mixing ratio for washer fluid (▷ page 281)

Fuel

Important safety notes

Warning

Gasoline is highly flammable and poisonous. It burns violently and can cause serious personal injury.

Never allow sparks, flames or smoking materials near gasoline.

Turn off the engine before refueling.

Whenever you are around gasoline, avoid inhaling fumes and any skin or clothing contact.

²⁵ Mixed with water or premixed washer fluid with antifreeze protection.

Direct skin contact with fuels and the inhalation of fuel vapors are damaging to your health.

Premium-grade unleaded gasoline

I To ensure the longevity and full performance of the engine, only premium-grade unleaded gasoline must be used.

If premium-grade unleaded gasoline is unavailable and regular gasoline is used, observe the following precautions:

- only fill the fuel tank to half full with regular unleaded gasoline and add the rest as soon as possible with premium-grade unleaded gasoline.
- do not drive at the maximum speed.
- avoid sudden acceleration.
- when the vehicle is carrying a light cargo, e.g. two passengers without luggage, do not allow the engine to rev above 3000 rpm.
- when the vehicle is fully loaded or being operated in mountainous terrain, do not depress the accelerator pedal further than $\frac{2}{3}$ of the pedal travel.

Fuel requirements

Use only premium-grade unleaded gasoline. The octane number should be at least 91. Details can be found on the gas pump. The octane number is the average value of the Research Octane Number (RON) and the Motor Octane Number (MON): $(RON + MON) / 2$, also known as knock resistance. Reformulated Gasoline (RFG) and/or unleaded gasoline with additives can be used if the concentration of the additives in the fuel does not exceed 10%, e.g.:

- Ethanol
- TAME
- ETBE
- IPA
- TBA

For MTBE, the concentration should not exceed 15%.

The concentration of methanol in gasoline including other additives must not exceed 3 %.

Using mixtures of methanol and ethanol is not permitted. Gasohol, a mixture of 10% ethanol and 90% unleaded gasoline, can be used.

All of these mix fuels must fulfill the fuel requirements, e.g.:

- knock resistance
- boiling point
- vapor pressure

Additives in gasoline

One of the major problems in engine design is the creation of carbon deposits during the process of burning fuel. Mercedes-Benz recommends that you use fuel brands that have the additives which prevent the build up of carbon deposits.

If you use fuels without these additives for a longer period of time, there may be a build up of carbon deposits, especially on the inlet valves and in the combustion chamber.

This could lead to engine running problems, e.g.:

- longer engine warm-up phase
- uneven idle
- engine noise
- misfiring
- loss of power

In areas where carbon deposits can build up due to the lack of availability of gasoline with the corresponding additives, Mercedes-Benz recommends the use of additives that have been approved for Mercedes-Benz vehicles.

Consult an authorized Mercedes-Benz Center or visit <http://www.mbusa.com> (USA only) to view a list of approved products. Observe the instructions for use in the product description.

Do not mix other fuel additives with fuel. This causes unnecessary costs and could damage the engine.

! Do not refuel with low-grade fuel and do not use fuel additives that are not tested and approved for Mercedes-Benz vehicles. Damage to or malfunctions of the fuel system may otherwise occur.

Engine oil

Please bear the following in mind

The engine oils are matched to the performance of Mercedes-Benz engines and service intervals. For this reason, only use engine oils and oil filters that are approved for vehicles with a service system.

Contact an authorized Mercedes-Benz Center or visit <http://www.mbusa.com> (USA only) to view a list of approved engine oils and oil filters.

! Never use engine oil or an oil filter of a specification other than is necessary to fulfill the prescribed service intervals. Do not change the engine oil or oil filter in order to achieve longer replacement intervals than those prescribed. You could otherwise cause engine damage or damage to the exhaust gas aftertreatment.

Follow the instructions in the service interval display regarding the oil change. Otherwise, you may damage the engine and the exhaust gas aftertreatment.

Mercedes-Benz recommends MOBIL OIL.

The table shows which engines oil have been approved for your vehicle.

Model	Engine model	MB Approval
G 550	273	229.5
G 55 AMG	113	229.5

i MB Approval is indicated on the oil bottles.

Additives

! Do not use additives in engine oil. This could damage the engine.

Engine oil viscosity

Viscosity describes the flow characteristics of a fluid. If an engine oil has a high viscosity, this means that it is thick; a low viscosity means that it is thin.

Select an engine oil with an SAE (viscosity) classification suitable for the prevailing outside temperatures. The following table shows the correct SAE classification to be used. The low-temperature characteristics of engine oils can deteriorate significantly, e.g. as a result of aging, soot and fuel deposits. It is therefore strongly recommended to observe regular oil changes using an approved engine oil with the appropriate SAE classification.

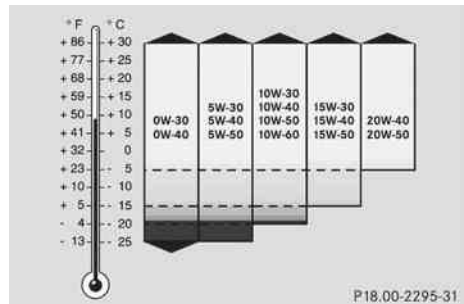

Refrigerant of the air-conditioning system

The air-conditioning system is filled with R134a (HFC) refrigerant and a special PAG lubricant.

! Never use refrigerant R 12 (CFC) or mineral lubricants. Otherwise, you could damage the air-conditioning system.

Brake fluid

Warning

The brake fluid constantly absorbs moisture from the air; this lowers its boiling point.

If the boiling point of the brake fluid is too low, vapor pockets may form in the brake system when the brakes are applied hard (e.g. when driving downhill). This would impair braking efficiency.

You should have the brake fluid renewed at regular intervals. The brake fluid change intervals can be found in the Service Booklet.

Only use brake fluid approved by Mercedes-Benz. Information about approved brake fluids can be obtained from any authorized Mercedes-Benz Center.

Coolant

Important safety notes

The coolant is a mixture of water and antifreeze/corrosion inhibitor. It performs the following tasks:

- anti-corrosion protection
- antifreeze protection
- raising the boiling point

The engine cooling system is filled at the factory with coolant which contains an antifreeze/corrosion inhibitor that ensures protection down to approximately -35 °F (-37 °C).

! Only add coolant that has been premixed with the desired antifreeze protection. You could otherwise damage the engine.

Further information on coolants and on filling can be found in the Mercedes-Benz Specifications for Service Products, MB Approval 310.1, e.g. on the Internet at <http://bevo.mercedes-benz.com>. You can also consult an authorized Mercedes-Benz Center.

! Always use a suitable coolant mixture, even in countries where high temperatures prevail.

Otherwise, the engine cooling system is not sufficiently protected from corrosion and the boiling point will be too low.

If the coolant has antifreeze protection down to -35 °F (-37 °C), the boiling point of the coolant in the pressurized system is approximately 266 °F (130 °C).

Your vehicle has a range of aluminum components. Use of aluminum components in the engine make it necessary to specifically match the antifreeze/corrosion inhibitor in these systems in order to protect the aluminum parts. Using other antifreeze/corrosion inhibitors without these characteristics affects the service life.

The coolant must be used throughout the year in order to maintain the necessary corrosion protection and provide protection from overheating. In the Service Booklet, you can find information on the intervals for renewal.

The renewal interval is determined by the coolant type and the engine cooling system design. The renewal interval in the Service Booklet is only valid if the coolant is renewed or replenished with Mercedes-Benz approved products. Therefore, only use MB 326.0 antifreeze/corrosion inhibitor or another Mercedes-Benz approved product of the same specification.

Information on other Mercedes-Benz approved products of the same specification can be obtained at any authorized Mercedes-Benz Center or on the Internet at <http://bevo.mercedes-benz.com>.

The coolant is checked at every service date at an authorized Mercedes-Benz Center.

The antifreeze/corrosion inhibitor concentration in the engine cooling system should:

- be at least 50%. This will protect the engine cooling system against freezing down to approximately -35 °F (-37 °C).
- not exceed 55% (antifreeze protection to -49 °F [-45 °C]); heat will otherwise not dissipate as effectively.

If the coolant level is too low, MB 325.0 antifreeze/corrosion inhibitor should be added. Have the engine cooling system checked for possible leaks.

Engine cooling system		
Vehicle model	antifreeze protection	
	Approximately -35 °F (-37 °C)	Approximately -49 °F (-45 °C)
G 550	6.4 US qt (6.05 l)	7.1 US qt (6.7 l)
G 55 AMG	6.7 US qt (6.35 l)	7.4 US qt (7.0 l)

Windshield/headlamp cleaning system

 **Warning**

Washer solvent/antifreeze is highly flammable. Do not spill washer solvent/antifreeze on hot engine parts, because it may ignite and burn. You could be seriously burned.

- Use windshield washer concentrate MB SummerFit.
- **At temperatures above freezing:** add 1 part MB SummerFit to 100 parts water, e.g.

1.34 fl oz (40 ml) MB SummerFit to 1 gal (4.0 l) of water.

- **At temperatures below freezing:** add 1 part MB SummerFit to 100 parts washer fluid, e.g. 1.34 fl oz (40 ml) MB SummerFit to 1 gal (4.0 l) of water.

Vehicle data

Vehicle data, G 550 (463.237)

The data stated here refers specifically to a vehicle with standard equipment. Consult an authorized Mercedes-Benz Center for the data for all vehicle variants and trim levels.

Vehicle dimensions, G 550	
Vehicle length ²⁶	183.9 in (4672 mm)
Vehicle width including exterior mirrors	79.0 in (2007 mm)
Vehicle height	76.8 in (1951 mm)
Wheelbase	112.2 in (2850 mm)
Track width	59.7 in (1515 mm)
Ground clearance, front	9.1 in (232 mm)
Ground clearance, rear	8.8 in (223 mm)
Turning circle	44.6 ft (13.6 m)

²⁶ Including spare wheel.

Vehicle weights, G 550	
Gross Vehicle Weight Rating (GVWR)²⁷	6615 lbs (3000 kg)
Gross Axle Weight Rating (GAWR), front²⁸	3110 lbs (1410 kg)
Gross Axle Weight Rating (GAWR), rear²⁸	3965 lbs (1800 kg)

Vehicle weights	
Gross Vehicle Weight Rating (GVWR)³¹	6615 lbs (3000 kg)
Gross Axle Weight Rating (GAWR), front³²	3263 lbs (1480)
Gross Axle Weight Rating (GAWR), rear³²	3965 (1800 kg)

Vehicle data, G 55 AMG (463.271)

The data stated here refers specifically to a vehicle with standard equipment. Consult an authorized Mercedes-Benz Center for the data for all vehicle variants and trim levels.

Vehicle dimensions	
Vehicle length	183.9 in (4672 mm) ²⁹ 188.2 in (4780 mm) ³⁰
Vehicle width including exterior mirrors	79.0 in (2007 mm)
Vehicle height	76.8 in (1951 mm)
Ground clearance	9.2 in (234 mm)
Wheelbase	112.2 in (2850 mm)
Track width	59.1 in (1501 mm)
Turning circle	44.6 ft (13.6 m)

²⁷ GVWR is the maximum total vehicle weight permissible. Gross Vehicle Weight (GVW) is the vehicle weight including fuel, service products, spare wheel, accessories installed, load and, if applicable, trailer drawbar load. The GVW must never exceed the GVWR.

²⁸ The GAWR is the maximum gross axle weight rating.

²⁹ Including spare wheel.

³⁰ Including spare wheel and styling bar (USA only).

³¹ GVWR is the maximum total vehicle weight permissible. Gross Vehicle Weight (GVW) is the vehicle weight including fuel, service products, spare wheel, accessories installed, load and, if applicable, trailer drawbar load. The GVW must never exceed the GVWR.

³² The GAWR is the maximum gross axle weight rating.

Publication details

Internet

Further information about Mercedes-Benz vehicles and about Daimler AG can be found on the following websites

<http://www.mbusa.com> (USA only)

<http://www.mercedes-benz.ca> (Canada only)

Editorial office

Not to be reprinted, translated or otherwise reproduced, in whole or in part, without written permission of Daimler AG.



4635847082

Order no. 6515 4117 13 Part no. 463 584 70 82 Edition A 2011