



Mercedes-Benz

ML 450 HYBRID

Supplemental Operating Instructions

Symbols

Trademarks®:

- ESP® is a registered trademark of Daimler.

The following symbols are found in this Supplemental Operating Instructions:

Warning!

Warning notices draw your attention to hazards that may endanger your health or life, or the health or life of others.

 Highlights hazards that may result in damage to your vehicle.

 Helpful hints or further information you may find useful.

▶ This symbol points to instructions for you to follow.

▶ A number of these symbols appearing in succession indicates a multiple-step procedure.

▷ page This symbol tells you where to look for further information on a topic.

▷▷ This continuation symbol marks a warning or procedure which is continued on the next page.

Display Text in displays, such as the control system, are printed in the type shown here.

Our company and staff congratulate you on the purchase of your new Mercedes-Benz.

Your selection of our product is a demonstration of your trust in our company name. Furthermore, it exemplifies your desire to own an automobile that will be as easy as possible to operate and provide years of service.

Your Mercedes-Benz represents the efforts of many skilled engineers and craftsmen. To help assure your driving pleasure, and also the safety of you and your passengers, we ask you to make a small investment of time:

- Please read this manual carefully, then return it to your vehicle where it will be handy for your reference.
- Please follow the recommendations contained in this manual. They are designed to acquaint you with the operation of your Mercedes-Benz.
- Please pay attention to the warnings and cautions contained in this manual. They are designed to help improve the safety of the vehicle operator and occupants.

We extend our best wishes for many miles of safe, pleasurable driving.

Mercedes-Benz USA, LLC

A Daimler Company

Index	4
Introduction	7
Safety and security	8
Controls in detail	11
Operation	20
Practical hints	24
Technical data	36

A

ABS (Antilock Brake System)	9
Warning lamp	13, 29
Anticorrosion/antifreeze	39
Antilock Brake System	
see ABS	
Automatic shift program	18
Automatic transmission	
Automatic shift program	18
Messages in the multifunction display	25
Program mode indicator	13, 19
Program mode selector switch (automatic shift program)	18
Axle oils	38

B

BAS (Brake Assist System)	9
Battery	
Charging	32
Charging condition high-voltage battery (COMAND)	14
Jump starting	33
Messages in the multifunction display	26
Safety notes	32
see High-voltage battery	
Brake Assist System	
see BAS	
Brakes	
Warning lamp	13, 29
Brake system	
see RBS	

C

Capacities and recommended fuel/lubricants	38
Charging condition high-voltage battery (COMAND)	14
COMAND	
Charging condition high-voltage battery	14
Fuel consumption	15

Generated electric power	15
Overview	13
Combustion engine	
Malfunction	30
Starting	16
Consumption statistics (COMAND) ...	15
Control system	
Overview	13
Coolant	
Anticorrosion/antifreeze	39
Capacities	38
Cruise control	10

D

Displays	
Charging condition high-voltage battery (COMAND)	14
Messages in the multifunction display	24
Driving and parking	
Safety notes	16
Driving off	17
Driving safety systems	
ABS	9
BAS	9
RBS	9
Driving systems	
Cruise control	10
Driving tips	17

E

Engine	16, 30
Malfunction indicator lamp	13
see Combustion engine	
Engine oil	
Adding	22
Checking level	21
Environmental protection	7
ESP® (Electronic Stability Program)	
Warning lamp	13, 29

F

Fluids	
Automatic transmission fluid	38
Brake fluid	38

Capacities	38
Engine coolant	38
Engine oil	38
Power steering fluid	38
Washer and headlamp cleaning system	39
Front axle oil	38
Fuel	20
Capacity, fuel tank	38
Fuel filler flap and cap	21
Premium unleaded gasoline	38
Fuel filler flap	21
Opening manually	31
Unlocking	20
Fuel filler flap switch	20
Fuels, coolants, lubricants etc.	
Capacities	38
Fuel tank	
Capacity	38
Fuel filler flap and cap	21

G**Gasoline**

see Fuel

H**High voltage**

see Safety notes

High-voltage battery 8

Charging condition (COMAND) 14

Exhaustive discharge 32

Messages in the multifunction display 26

HYBRID system

Automatic switch-off 8, 31

Overview 12

READY indicator 13, 16

I**Indicator and warning lamp**

SRS 31

Indicator lamp

see Lamps, indicator and warning

Instrument cluster 13

Lamps 29

Introduction 11**J****Jump starting** 33**L****Lamp**

see Lamps, indicator and warning

Lamps, indicator and warning 29

ABS/ESP® 13, 29

Brakes

(red) 13, 29

Instrument cluster 13, 29

RBS 13, 29

M**Message**

see Lamps, indicator and warning

Motor Octane Number

see MON

Multifunction display

Symbol messages 26

Text messages 25

Vehicle status messages 24

Multifunction display messages

Automatic transmission 25

Battery 26, 28

Display malfunction 24

Gas cap 27

Power steering 27

O**Oil level**

see Engine oil, Checking level

Operating safety 7**P****Parking** 18**Power gauge** 13, 14**Power steering**

Messages in the multifunction

display 27

Program mode selector switch

Automatic shift program 18

R

RBS (Regenerative Brake System)	9, 11
Malfunction	29, 30
Warning lamp	13, 29
READY indicator	13, 16
Rear axle oil	38
Recuperation statistics (COMAND) ...	15
Refueling	20
Research Octane Number see RON	
Rims	37
Risk of fire see Safety notes	

S

Safety see Operating safety	
Safety notes	8
Silent-Start mode	16
SRS (Supplemental Restraint System) Warning lamp	31
Starting see Combustion engine	
Submenu Resetting values (COMAND)	16

T

Technical data Capacities fuels, coolants, lubricants etc.	38
Coolant	39
Engine oils	39
Rims and tires	37
Vehicle specification ML 450 HYBRID	36
Washer and headlamp cleaning system	39
Tires	37

U

Unlocking Fuel filler flap	20
--	----

V

Vehicle Disuse	32
Vehicle fire see Safety notes	
Vehicle modifications	7
Vehicle specification ML 450 HYBRID	36

W

Warning labels	8
Wheels, sizes	37
Winter tires	37

Environmental protection

Have the high-voltage battery disposed of in an environment-friendly manner by an authorized Mercedes-Benz Center.

Warning!

The HYBRID system is energized by high voltage. The components of the HYBRID system are indicated by yellow warning labels. High-voltage cables are orange-colored.

You could be seriously or even fatally injured when you

- tamper with components or high-voltage cables of the HYBRID system
- touch components or high-voltage cables of the HYBRID system after the vehicle has been involved in an accident
- touch damaged components of the HYBRID system

Do not remove the high-voltage battery of the HYBRID system. Have the high-voltage battery disposed of in an environment-friendly manner by an authorized Mercedes-Benz Center.

Operating safety

Warning!

When your vehicle is in electric drive mode the engine produces significantly lower noise levels. Other motorists or pedestrians, especially those who are visually or hearing impaired, may be unable to hear your vehicle while it is in motion. This is particularly true when driving at lower speeds and during parking maneuvers. At all times, it is the responsibility of the driver to be aware of their surroundings, especially in these low speed situations. Otherwise other road users could be seriously or fatally injured.

Warning!

Have all work on the vehicle, especially safety-related work, work on safety-relevant systems, work on the HYBRID system as well as maintenance work, carried out by an authorized Mercedes-Benz Center.

-  For more information on operating safety, refer to the Operator's Manual.

Vehicle modifications

Warning!

Improper work on the HYBRID system or modifications of the vehicle can cause vehicle systems to cease functioning properly. You could lose control over the vehicle and cause an accident.

Therefore, have work on the HYBRID system and modifications of the vehicle such as installation or modification of vehicle equipment carried out by an authorized Mercedes-Benz Center

-  For more information on operating safety, refer to the Operator's Manual.

Proper use of the vehicle

Proper use of the vehicle requires that you are familiar with the following information and rules:

- the safety precautions in this manual
- the "Technical data" section in this manual
- the Operator's Manual
- traffic rules and regulations
- motor vehicle laws and safety standards

Safety notes**Warning labels** **Warning!**

Various warning labels are attached to your vehicle. These warning labels are intended to make you and others aware of various risks. Do not remove any of these warning labels unless explicitly instructed to do so by information on the label itself. Removing warning labels may cause you and others to be unaware of certain risks which may result in an accident and/or personal injury.

Danger of electric shock

The components of the HYBRID system are indicated by yellow warning labels to make you aware of high voltage. High-voltage cables are orange-colored.

 **Warning!**

The HYBRID system is energized by high voltage.

You could be seriously or even fatally injured when you

- tamper with components or high-voltage cables of the HYBRID system
- touch components or high-voltage cables of the HYBRID system after the vehicle has been involved in an accident
- touch damaged components of the HYBRID system

Do not remove covers of components of the HYBRID system that carry the yellow warning

label. Do not tamper with any components or with the orange high-voltage cables of the HYBRID system.

Engine compartment

Before opening the hood do the following:

- ▶ Engage the parking brake.
- ▶ Shift the automatic transmission into park position **P**.
- ▶ Switch off the ignition.
The READY indicator (> page 16) in the instrument cluster goes out.
- ▶ Remove the SmartKey from the starter switch or remove the SmartKey with KEYLESS-GO from the vehicle.
- ▶ Observe the safety notes on the danger of electric shock in this manual.
- ▶ Observe the safety notes regarding the hood in the Operator's Manual.

Automatic HYBRID system switch-off

The HYBRID system switches off automatically if

- the Supplemental Restraint System (SRS) activates the restraint systems in an accident
- a short circuit in the HYBRID system is detected
- a plug connection of the HYBRID system is disconnected

These measures help to prevent you from coming into contact with high voltage.

High-voltage battery **Warning!**

The high-voltage battery of the HYBRID system is located under the cargo compartment. When the pressure inside the high-voltage battery exceeds a certain value,

for example in case of a vehicle fire, inflammable gas will escape via a duct. The inflammable gas escapes to an area underneath the vehicles cargo compartment. This prevents the high-voltage battery from exploding.

Stay away from this area of the vehicle.

Driving safety systems

ABS (Antilock Brake System)

Braking

When the ABS engages during braking, the ABS/ESP® warning lamp  in the instrument cluster (> page 13) flashes. The brake pedal will pulsate only in certain situations, for example on a slippery road.

-  For more information on the ABS, refer to the Operator's Manual.

RBS (Recuperative Brake System)

The RBS controls braking by blending the vehicles friction brakes with the hybrid transmissions recuperative energy function. The RBS system must perform a self-test when the ignition is switched on.



- ▶ Make sure the automatic transmission is in park position **P**.
- ▶ Switch on the ignition.
- ▶ Apply the brake pedal fully and release it. The self-test of the RBS is completed.

During the self-test of the RBS, less brake pedal pressure than usual is required and the brake pedal travel is longer. When you release the brake pedal, the brake pedal travel is as usual again.

For more information on the RBS, see (> page 11).

Warning!

If the RBS malfunctions, the yellow RBS warning lamp  and/or the red brake

warning lamp  (USA only) or  (Canada only) in the instrument cluster comes on. Read and observe the messages in the multifunction display that may appear. Find the subentry “Malfunction” of the entry “RBS (Recuperative Brake System)” in the index of this manual and follow the steps described in that section.

Warning!

If the RBS malfunctions, less brake pedal pressure than usual may be required and the brake pedal travel may be longer. The brake system still functions with full effectiveness. If required, you have to depress the brake pedal further. Adapt your speed and driving accordingly.

Warning!

Have work on the RBS, e.g. brake pad replacement, carried out by qualified technicians only.

When working on the RBS, certain precautions must be taken, e.g. when putting the brake system back into service.

Contact an authorized Mercedes-Benz Center. Service conducted by qualified technicians is required particularly for safety-relevant work and work on safety-relevant systems such as the RBS.

-  For more information on the braking system and for driving instructions, refer to the Operator's Manual.

BAS (Brake Assist System)

If you apply the brakes very quickly, the RBS provides full brake boost as fast as possible. In doing so, less brake pedal pressure than usual is required and the brake pedal travel is longer.

- ▶ Apply continuous full braking pressure until the emergency braking situation is over. The ABS will prevent the wheels from locking.

- i** For more information on the BAS, refer to the Operator's Manual.

Driving systems

Cruise control

When the cruise control brakes the vehicle, the brake pedal is not depressed.

- i** For more information on the cruise control, refer to the Operator's Manual.

Introduction

The HYBRID technology combines an economical combustion engine with a powerful hybrid transmission. The HYBRID system selects the most efficient operating mode for each driving situation automatically. You can drive the vehicle in the usual manner. The HYBRID system turns the combustion engine off as often as possible in order to save fuel.

Depending on various conditions such as the charging level of the high-voltage battery or the operating temperature, the vehicle can run on electrical energy alone. These conditions as well as the degree to which the driver accelerates determine the vehicle speed and range that can be achieved for all electrical driving.

Warning!

When the READY indicator in the instrument cluster is on while the combustion engine is off, the combustion engine has been turned off automatically. All vehicle systems continue to be active as long as the ignition is switched on. When you open the driver's door and unbuckle the seat belt with the READY indicator on, while the automatic transmission is in position **N** or **P**, the combustion engine starts automatically.

Therefore, always do the following before leaving the vehicle:

- Engage the parking brake.
- Shift the automatic transmission into park position **P**.
- Switch off the ignition. The READY indicator goes out.

Driving off and accelerating consumes the most energy. Thus, the hybrid transmission supports the combustion engine with the energy stored in the high-voltage battery. The energy is also used for electrical driving, for operation of the electric compressor of the cooling system and to support the 12-volt on-board power supply. The hybrid drive thereby contributes significantly to the fuel economy of your vehicle.

For information on driving with HYBRID, see (▷ page 16).

The current operating mode of the HYBRID system can be displayed in the instrument cluster (▷ page 13) and in the COMAND display (▷ page 13).

The COMAND can also display a chart of the fuel consumption and the electric power that has been generated (▷ page 15).

RBS (Regenerative Brake System)

With the RBS activated (▷ page 9), the hybrid transmission functions as a generator when coasting and braking. HYBRID converts the energy of movement into electric power and stores it in the high-voltage battery. The high-voltage battery does not require additional charging by other means.

Overview HYBRID system

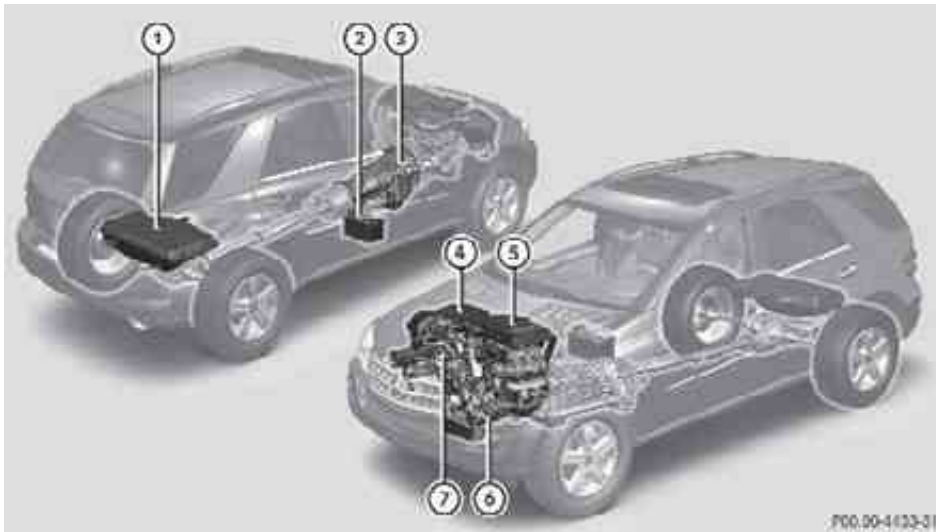

	Component
①	High-voltage battery
②	12-volt battery
③	Hybrid transmission
④	Voltage transformer (transforms the voltage of the 12-volt battery and the high-voltage battery in both directions for best possible power management)

	Component
⑤	Power electronics (control the high-voltage system)
⑥	Electric refrigerant compressor for the climate control system
⑦	Combustion engine

Instrument cluster

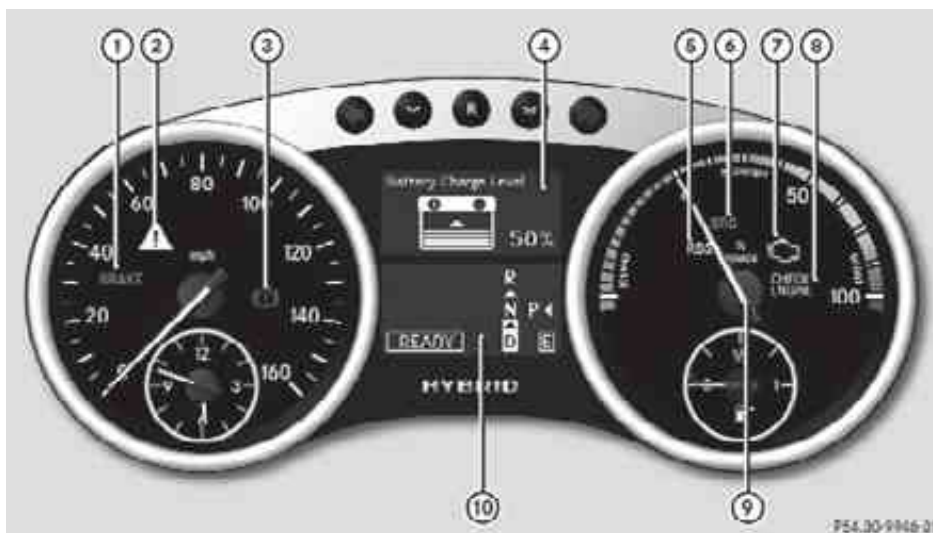

	Function	Page
①	Brake warning lamp, USA only	29
②	ABS/ESP® warning lamp	9, 29
③	Brake warning lamp, Canada only	29
④	Multifunction display with: Charging level high-voltage battery	14
⑤	Recuperative Brake System (RBS) warning lamp	29
⑥	Supplemental Restraint System (SRS) indicator lamp	31
⑦	Engine malfunction indicator lamp, Canada only	21
⑧	Engine malfunction indicator lamp, USA only	21

	Function	Page
⑨	Power gauge	14
⑩	Multifunction display with: Automatic transmission program mode indicator READY indicator for the HYBRID system	18 16

Control system and COMAND





i For information on the instrument cluster control system and COMAND operation, refer to the Operator's Manual.

The current operating mode of the HYBRID system can be displayed in the multifunction display and in the COMAND.

The COMAND can also display a chart of the fuel consumption and the electric power that has been generated (▷ page 15).

Selecting submenu in the multifunction display

Use the buttons on the multifunction steering wheel.

- ▶ Press button  or  repeatedly until the standard display appears.
- ▶ Press button  or  to select the HYBRID menu.

Selecting submenu in the COMAND display

- ▶ Select System → Hybrid → Energy Flow.

COMAND display examples

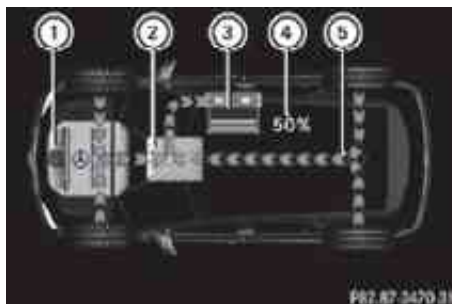

Example illustration: Operating mode display

- ① Combustion engine
- ② Hybrid transmission
- ③ High-voltage battery
- ④ Charging condition of high-voltage battery in percent
- ⑤ Flow of energy

The HYBRID components that are currently active are highlighted in the COMAND display.

Multifunction display



Power gauge





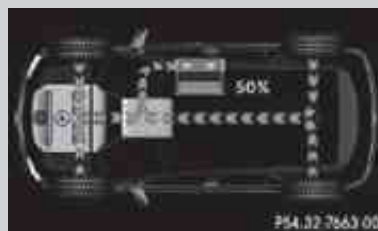



COMAND display



Recuperation – the hybrid transmission functions as a generator, for example when coasting or braking. The kinetic energy of the vehicle is converted into electric power and stored in the high-voltage battery.

The multifunction display indicates charging of the high-voltage battery by an arrow pointing upwards. The pointer of the power gauge moves into the charge section. The COMAND display indicates the flow of energy by green arrows.

Multifunction display	Power gauge	COMAND display
		
<p>Boost effect – the hybrid transmission supports the combustion engine when driving off and when accelerating.</p> <p>The multifunction display indicates discharging of the high-voltage battery by an arrow pointing downwards. The pointer of the power gauge moves into the boost section. The COMAND display indicates the flow of energy by white or red arrows (depending on the acceleration).</p>		

Multifunction display	Power gauge	COMAND display
		
<p>Electric driving – the hybrid transmission powers the vehicle, up to a maximum speed of 30 mph (50 km/h).</p> <p>The multifunction display indicates discharging of the high-voltage battery by an arrow pointing downwards. The pointer of the power gauge moves within the range of its economy section. The COMAND display indicates the flow of energy by green arrows.</p>		

i Maximum Hybrid battery life is ensured by the electronic charge control maintaining a charge level between 25 % and 80 %. This is the ideal range for the Hybrid battery and therefore the charge level displayed in the instrument cluster or COMAND may not approach 100 %. This is intentional and does not indicate a malfunction of the Hybrid battery or the charging components.

Displaying fuel consumption and generated electric power

The COMAND display indicates the fuel consumption and the generated electric power for the last 15 minutes of driving.

- ▶ Select System → Hybrid → Consumption.

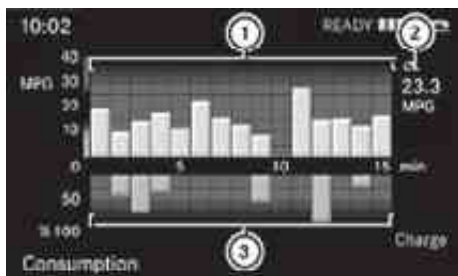

P82,87-3469-31

- ① Fuel consumption
- ② Average fuel consumption From Start as shown in the multifunction display of the instrument cluster in the **Trip computer** menu.
- ③ Generated electric power

Each bar in the chart represents the average value for 1 minute.

Resetting values

The values are reset together when resetting the trip computer in the From Start submenu. Refer to the Operator's Manual.

Driving and parking

Safety notes

Warning!

When your vehicle is in electric drive mode the engine produces significantly lower noise levels. Other motorists or pedestrians, especially those who are visually or hearing impaired, may be unable to hear your vehicle while it is in motion. This is particularly true when driving at lower speeds and during parking maneuvers. At all times, it is the responsibility of the driver to be aware of their surroundings, especially in these low speed situations. Otherwise other road users could be seriously or fatally injured.

Warning!

Make sure absolutely no objects are obstructing the pedals' range of movement.

Keep the driver's footwell clear of all obstacles. If there are any floor mats or carpets in the footwell, make sure the pedals still have sufficient clearance.

During sudden driving or braking maneuvers the objects could get caught between or under the pedals. You could then no longer brake or accelerate. This could lead to accidents and injury.

Starting the engine



- ① READY indicator

- ▶ Switch on the ignition.
- ▶ Apply the brake pedal fully and release it. The self-test of the RBS is completed. For more information on the RBS, see (▷ page 9).
- ▶ Observe the notes on "Starting the engine" in the Operator's Manual and start the combustion engine.

Silent-Start mode

The combustion engine may not start each time you start the vehicle with the SmartKey or with KEYLESS-GO.

Depending on various conditions such as the charging level of the high-voltage battery, you may drive off with electrical energy alone. The vehicle is then in Silent-Start mode. The READY indicator ① will then indicate that the HYBRID systems are operational.

 **Warning!**

When the READY indicator in the instrument cluster is on while the combustion engine is off, the combustion engine has been turned off automatically. All vehicle systems continue to be active as long as the ignition is switched on. When you open the driver's door and unbuckle the seat belt with the READY indicator on, while the automatic transmission is in position **N** or **P**, the combustion engine starts automatically.

Therefore, always do the following before leaving the vehicle:

- Engage the parking brake.
- Shift the automatic transmission into park position **P**.
- Switch off the ignition. The READY indicator goes out.

The combustion engine turns off automatically when the system determines that it is not needed. The combustion engine does not turn off automatically when

- the operation strategy requires that the combustion engine is running
- the self-diagnosis of the combustion engine management is still running
- the combustion engine is running below or above the operating temperature
- the catalytic converter is running below the operating temperature
- the vehicle is being driven up an extremely steep incline
- the hybrid components are below or above their operating temperature
- the accelerator pedal is being depressed to hard
- the vehicle speed is above 34 mph (55 km/h)
- the automatic transmission is malfunctioning

- the hood is open
- the high-voltage battery is not charged sufficiently

Driving off **Warning!**

When your vehicle is in electric drive mode the engine produces significantly lower noise levels. Other motorists or pedestrians, especially those who are visually or hearing impaired, may be unable to hear your vehicle while it is in motion. This is particularly true when driving at lower speeds and during parking maneuvers. At all times, it is the responsibility of the driver to be aware of their surroundings, especially in these low speed situations. Otherwise other road users could be seriously or fatally injured.

Depress the brake pedal and shift the automatic transmission into drive position **D** or reverse gear **R**. If the message **Depress brake to shift out of P.** appears in the multifunction display:

- ▶ Depress the brake pedal with somewhat greater force and select the desired transmission position.

- i** Read and observe messages that may appear in the multifunction display (▷ page 24).

For more information on driving off, refer to the Operator's Manual.

Driving**Driving tips**

- Think ahead and keep sufficient distance.
- Avoid frequent and rapid acceleration as well as abrupt braking.

- The hybrid transmission supports the combustion engine when driving off and when accelerating.
- The hybrid transmission functions as a generator when coasting the vehicle with the automatic transmission in drive position **D** and during braking.

i For additional general driving instructions, refer to the Operator's Manual.

Parking



Warning!

When your vehicle is in electric drive mode the engine produces significantly lower noise levels. Other motorists or pedestrians, especially those who are visually or hearing impaired, may be unable to hear your vehicle while it is in motion. This is particularly true when driving at lower speeds and during parking maneuvers. At all times, it is the responsibility of the driver to be aware of their surroundings, especially in these low speed situations. Otherwise other road users could be seriously or fatally injured.

Warning!

When the READY indicator in the instrument cluster is on while the combustion engine is off, the combustion engine has been turned off automatically. All vehicle systems continue to be active as long as the ignition is switched on. When you open the driver's door and unbuckle the seat belt with the READY indicator on, while the automatic transmission is in position **N** or **P**, the combustion engine starts automatically. Therefore, always do the following before leaving the vehicle:

- Engage the parking brake.
- Shift the automatic transmission into park position **P**.
- Switch off the ignition. The READY indicator goes out.

- ▶ Engage the parking brake.
The parking brake indicator lamp  (USA only) or  (Canada only) in the instrument cluster comes on.
- ▶ Shift the automatic transmission into park position **P**.
- ▶ Switch off the ignition.
The READY indicator goes out.

i For more information on parking and on turning off the combustion engine, refer to the Operator's Manual.

Automatic transmission

Automatic shift program



Program mode selector switch

E Economy	For fuel-efficient operation
S Sport	For sporty driving

The current program mode appears in the multifunction display.



① Program mode indicator

i The automatic program mode **E**, for fuel-efficient driving, is active each time you start the vehicle with the SmartKey or with KEYLESS-GO.

► Press the program mode selector switch repeatedly until the letter of the desired program mode appears in the multifunction display.

Selecting program mode **E** means:

- enabling electric driving with the hybrid transmission whenever possible
- consumption-optimized driving characteristics considering the individual driving style
- maximum driving comfort by smooth gear changes
- continuous power transmission

Selecting program mode **S** means:

- enabling more electric driving as it is possible with selected program mode **E**
- sporty engine and transmission setting
- gear changes according to the driving style and road conditions
- driving characteristics of a conventional eight-speed transmission

i For more information on the automatic transmission, refer to the Operator's Manual.

Refueling

Warning!

Gasoline is highly flammable and poisonous. It burns violently and can cause serious personal injury.

Never allow sparks, flames or smoking materials near gasoline!

Turn off the engine before refueling.

Whenever you are around gasoline, avoid inhaling fumes and any skin or clothing contact. Extinguish all smoking materials.

Direct skin contact with fuels and the inhalation of fuel vapors are damaging your health.

Warning!

Overfilling of the fuel tank may create pressure in the system which could cause a gas discharge. This could cause the gas to spray back out when removing the fuel pump nozzle, which could cause personal injury.

! Never refuel vehicles with gasoline engine with diesel fuel. Even small amounts of diesel fuel will damage the fuel system and engine. Damage resulting from the use of non-approved fuels or fuel additives or resulting from mixing gasoline with diesel fuel is not covered by the Mercedes-Benz Limited Warranty.

! If you have accidentally filled the tank with incorrect or non-approved fuel, do not switch on the ignition. Otherwise the incorrect or non-approved fuel will get into the fuel lines. The fuel system must be drained completely. Contact an authorized Mercedes-Benz Center to have the fuel system drained completely.

! To prevent damage to the catalytic converters, only use premium unleaded gasoline in this vehicle. Any noticeable irregularities in engine operation should be repaired promptly.

Otherwise, excessive unburned fuel may reach the catalytic converter, causing it to overheat and potentially start a fire.

- i** Only use premium unleaded gasoline with a minimum Posted Octane Rating of 91 (average of 96 RON/86 MON). Information on gasoline quality can normally be found on the fuel pump. Please contact gas station personnel in case labels on the pump cannot be found. For more information on gasoline, see Operator's Manual, contact an authorized Mercedes-Benz Center, or visit www.mbusa.com (USA only).

- ▶ Bring the vehicle to a standstill.
- ▶ Engage the parking brake.
- ▶ Shift the automatic transmission into park position **P**.
- ▶ Switch off the ignition. The READY indicator (> page 16) in the instrument cluster goes out.
- ▶ Remove the SmartKey from the starter switch or remove the SmartKey with KEYLESS-GO from the vehicle.

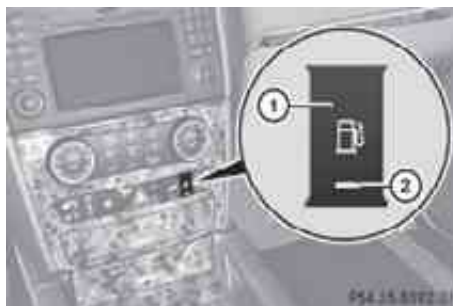

- i** Before refueling your vehicle its fuel tank system needs to be depressurized.



- ▶ Press fuel filler flap switch ①. Indicator lamp ② comes on as the fuel filler flap is unlocked.

In case of a blinking indicator lamp ②, pressure on the fuel tank system needs to be released first.

A malfunction in the system has been detected if

- the indicator lamp ② fails to stop blinking after approximately 10 seconds after the fuel filler flap switch ① has been pressed
- the indicator lamp ② does not come on at all
- the malfunction indicator lamp  (USA only) or  (Canada only) comes on



The fuel filler flap is located on the right-hand side of the vehicle towards the rear.

- ❗ In case the fuel filler flap switch does not release the fuel filler flap, see “Opening the fuel filler flap manually” (▷ page 31).

Warning!

Remove fuel filler cap slowly. Fuel spray may cause injury.

Complete refueling within 20 minutes after opening the fuel filler flap. Otherwise fuel may spray out and cause injury. If the refueling process cannot be completed within 20 minutes, press the fuel filler flap switch again.

- ❗ Leaving the combustion engine running and the fuel filler cap open can cause the yellow fuel tank reserve warning lamp to flash and the malfunction indicator lamp  (USA only) or  (Canada only) to illuminate.

For more information on refueling, see Operator's Manual.

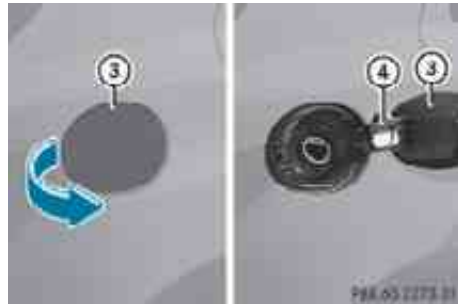

► **Opening:** Pull fuel filler flap ③ out in direction of arrow.

- Turn fuel filler cap ④ counterclockwise.
- Take off fuel filler cap ④.

❗ The fuel filler cap is tethered to the fuel filler neck. Do not drop the cap. It could damage the vehicle paint finish.

- Set fuel filler cap ④ on fuel filler flap ③.
- Fully insert filler nozzle unit and refuel.
- Only fill your tank until the filler nozzle unit cuts out – **do not top off or overfill.**

► **Closing:** Turn fuel filler cap ④ until it audibly engages.

- Close fuel filler flap ③.

The fuel filler flap is locked.

The indicator lamp on the fuel filler flap switch goes out (▷ page 20).

Engine oil

The amount of oil your combustion engine consumes will depend on a number of factors, including driving style. Increased oil consumption can occur when the vehicle is new or the vehicle is driven frequently at higher engine speeds.

Engine oil consumption checks should only be made after the vehicle break-in period.

- ❗ Do not use any special lubricant additives, as these may damage the drive assemblies.

Using special additives not approved by Mercedes-Benz may cause damage not covered by the Mercedes-Benz Limited Warranty.

For further information contact an authorized Mercedes-Benz Center.

Notes on checking engine oil level

When checking the oil level the vehicle must be parked on level ground and the vehicle must have been stationary for at least 5 minutes with the combustion engine turned off.

Checking engine oil level

Before opening the hood do the following:

- ▶ Engage the parking brake.
- ▶ Shift the automatic transmission into park position **P**.
- ▶ Switch off the ignition.
The READY indicator (▶ page 16) in the instrument cluster goes out.
- ▶ Remove the SmartKey from the starter switch or remove the SmartKey with KEYLESS-GO from the vehicle.
- ▶ Observe the safety notes on the danger of electric shock in this manual.
- ▶ Open the hood, see Operator's Manual.



- ▶ Remove cover ① by pulling it in direction of arrow.



- ▶ Pull out oil dipstick ②.
- ▶ Wipe oil dipstick ② clean.
- ▶ Fully insert oil dipstick ② into the dipstick guide tube.
- ▶ Pull out oil dipstick ② again after approximately 3 seconds to obtain accurate reading.
The oil level is correct when it is between lower (min) mark ④ and upper (max) mark ③ of oil dipstick ②.

i The filling quantity between the upper and lower marks on the oil dipstick is approximately 2.1 US qt. (2.0 l).

- ▶ If necessary, add engine oil (▶ page 22).
- ▶ Install cover ①.

For more information on engine oil, see Operator's Manual.

Adding engine oil



- ▶ Remove the cover (▷ page 22).
- ▶ Unscrew filler cap ① from filler neck.
- ▶ Add engine oil as required. Be careful not to overfill with oil.

Be careful not to spill any oil when adding. Avoid environmental damage caused by oil entering the ground or water.

! Excess oil must be siphoned or drained off. It could cause damage to the engine and emission control system not covered by the Mercedes-Benz Limited Warranty.

- ▶ Screw filler cap ① back on filler neck.
- ▶ Install the cover (▷ page 22).

Vehicle status messages in the multifunction display

Notes





Warning and malfunction messages appear in the multifunction display located in the instrument cluster.





Certain warning and malfunction messages are accompanied by an audible signal.

Address these messages accordingly and follow the additional instructions given in this Supplemental Operating Instructions Booklet.

Selecting the Vehicle status message memory menu in the control system displays both cleared and uncleared messages.

High-priority messages appear in the multifunction display in red color.

Certain messages of high priority cannot be cleared from the multifunction display using the reset button or button , ,  or  on the multifunction steering wheel.

Other messages of high priority and messages of less immediate priority can be cleared from the multifunction display using the reset button or button , ,  or  on the multifunction steering wheel. They are then stored in the Vehicle status message memory menu. Remember that clearing a message will only make the message disappear. Clearing a message will not correct the condition that caused the message to appear.

Warning!

All categories of messages contain important information which should be taken note of and, where a malfunction is indicated, addressed as soon as possible at an authorized Mercedes-Benz Center.

Failure to repair the condition noted may cause damage not covered by the Mercedes-Benz Limited Warranty, or result in property damage or personal injury.

Warning!

No messages will be displayed if either the instrument cluster or the multifunction display is inoperative.

As a result, you will not be able to see information about your driving conditions, such as

- speed
- outside temperature
- warning/indicator lamps
- malfunction/warning messages
- failure of any systems

Driving characteristics may be impaired.

If you must continue to drive, do so with added caution. Contact an authorized Mercedes-Benz Center as soon as possible.

On the pages that follow, you will find a compilation of the warning and malfunction messages specific to the HYBRID system. For all other warning and malfunction messages, refer to the Operator's Manual.

Text messages

Display messages		Possible causes/consequences and ► Solutions
Driving in Reverse currently not possible	Wait briefly	Driving in reverse is currently not possible. The hybrid transmission is overheated. <ul style="list-style-type: none"> ► Wait briefly. ► Depress the brake pedal. ► Release the accelerator pedal. ► The message in the multifunction disappears.
Driving in Reverse now possible again		The hybrid transmission has cooled down. <ul style="list-style-type: none"> ► Driving in reverse is now possible again.
Depress brake	to shift out of P.	You have attempted to shift the automatic transmission into drive position D , reverse gear R or neutral position N without depressing the brake pedal or without depressing it fully. <ul style="list-style-type: none"> ► Depress the brake pedal fully.
Engine Can Now Be Started		The high-voltage battery has been charged via the voltage transformer automatically. <ul style="list-style-type: none"> ► Start the combustion engine. ► Disconnect the charge unit or jumper cables. ► Drive the vehicle for some time in order to charge the 12-volt battery and the high-voltage battery.
Fuel Filler Flap Open		The fuel filler flap is open. <ul style="list-style-type: none"> ► Check the fuel filler flap. ► If it is not closed properly: Close the fuel filler flap. ► If it is closed properly: Have the fuel system checked by an authorized Mercedes-Benz Center.

Symbol messages

Display messages

Possible causes/consequences and ► Solutions



Charging
Hybrid
Battery
Please
Wait

The high-voltage battery is discharged. You have switched on the ignition while the 12-volt battery was being charged with an approved charge unit or while jump starting the vehicle.

The high-voltage battery is being charged via the voltage transformer automatically. Depending on the state of the high-voltage battery's discharge, the charging procedure may take up to 60 minutes. The message Engine Can Now Be Started appears in the multifunction display, after the system became adequately charged to start the combustion engine (► page 25).

If the display message Engine Can Now Be Started does not appear after about an hour:

- Try to start the combustion engine.
- If the combustion engine cannot be started: Contact an authorized Mercedes-Benz Center.



Malfunction

The HYBRID system is malfunctioning.

- Have the system checked at an authorized Mercedes-Benz Center.



Stop car,
switch
engine
off.

The HYBRID system is malfunctioning. In addition an acoustic warning sounds.



- Stop the vehicle in a safe location as soon as possible.
- Engage the parking brake.
- Switch off the ignition.
- Wait at least 60 seconds for the system to complete the necessary check cycles before you start the combustion engine again.
- If the combustion engine cannot be started again contact an authorized Mercedes-Benz Center.



Malfunction

The high-voltage system is malfunctioning. In addition an acoustic warning sounds.

- Contact an authorized Mercedes-Benz Center immediately.

Display messages	Possible causes/consequences and ► Solutions	
	Malfunction Service Required	<p>The high-voltage system is malfunctioning. In addition an acoustic warning sounds.</p> <ul style="list-style-type: none"> ► Drive with added caution to the nearest authorized Mercedes-Benz Center. <p>The combustion engine cannot be started again, if</p> <ul style="list-style-type: none"> • the automatic transmission is set to position neutral position N or park position P • the hood is opened • the bolted cover in the trunk is removed
	Gas Cap Open	<p>A loss of pressure has been detected in the fuel system. The fuel cap may not be closed properly or the fuel system may be leaking.</p> <ul style="list-style-type: none"> ► Check the fuel cap. ► If it is not closed properly: Close the fuel cap. ► If it is closed properly: Have the fuel system checked by an authorized Mercedes-Benz Center.
	Power Steering Malfunction See Operator's Manual	<p>Power assistance for the steering system is not available. A considerably higher degree of effort is necessary to steer the vehicle.</p> <ul style="list-style-type: none"> ► Check whether you are capable to apply the higher degree of effort necessary to safely steer the vehicle. <p>If you are able to steer the vehicle safely:</p> <ul style="list-style-type: none"> ► Continue driving with added caution. ► Have the system checked at an authorized Mercedes-Benz Center. <p>If, in any way, you feel that you are not able to steer the vehicle safely:</p> <ul style="list-style-type: none"> ► Stop the vehicle in a safe location as soon as it is safe to do so. ► Apply the parking brake. ► Do not continue to drive. ► Contact an authorized Mercedes-Benz Center.

Display messages



Possible causes/consequences and ► Solutions

The 12-volt battery is no longer charging.

Possible causes:

- voltage transformer malfunctioning
 - the 12-volt battery is malfunctioning
- Stop the vehicle in a safe location or as soon as it is safe to do so.
- Engage the parking brake.
- Do not continue to drive.
- Contact an authorized Mercedes-Benz Center.

What to do if ...

Lamps in instrument cluster

Problem	Possible causes/consequences and ► Solutions
<p>RBS</p> <p>The yellow RBS (Recuperative Brake System) warning lamp is on while the combustion engine is running. In addition, an acoustic warning may sound.</p>	<p>The RBS is malfunctioning. Risk of accident! The combustion engine may not turn off automatically.</p> <ul style="list-style-type: none"> ► Read and observe messages that may appear in the multifunction display (▷ page 24). ► Continue driving with added caution. ► Contact an authorized Mercedes-Benz Center.
<p>BRAKE (USA only)</p> <p>(D) (Canada only)</p> <p>The red brake warning lamp is on while the combustion engine is running. An additional acoustic warning sounds.</p>	<p>The RBS is malfunctioning. Risk of accident! Brake pedal travel may be longer than usual and the braking behavior of the vehicle may change.</p> <ul style="list-style-type: none"> ► Stop the vehicle in a safe location or as soon as it is safe to do so. Do not continue to drive. ► Contact an authorized Mercedes-Benz Center immediately. ► Read and observe messages that may appear in the multifunction display (▷ page 24), see Operator's Manual. <p>The brake fluid level in the brake fluid reservoir is too low. Risk of accident!</p> <ul style="list-style-type: none"> ► Stop the vehicle in a safe location or as soon as it is safe to do so. Do not continue to drive. ► Contact an authorized Mercedes-Benz Center immediately. ► Read and observe messages that may appear in the multifunction display (▷ page 24), see Operator's Manual. <p>Do not add brake fluid. This will not solve the problem.</p>
<p>(A)</p> <p>The yellow ABS/ESP[®] warning lamp flashes while driving.</p>	<p>The ESP[®], the 4-ETS, or the ABS has come into operation because of detected traction loss for at least one wheel. Risk of accident! The cruise control is deactivated.</p> <ul style="list-style-type: none"> ► When driving off, apply as little throttle as possible. ► While driving, ease up on the accelerator pedal. ► Adapt your speed and driving to the prevailing road and weather conditions. ► Do not switch off the ESP[®]. <p>Exceptions, see Operator's Manual.</p>

Problem	Possible causes/consequences and ► Solutions
The warning and indicator lamps in the instrument cluster fail to come on when switching on the ignition.	<p>The 12-volt battery and/or the high-voltage battery are discharged.</p> <ul style="list-style-type: none"> ► Charge the 12-volt battery (▷ page 32). <p>or</p> <ul style="list-style-type: none"> ► Get a jump start (▷ page 33). <p>or</p> <ul style="list-style-type: none"> ► Contact an authorized Mercedes-Benz Center.

Combustion engine

Problem	Possible causes/consequences and ► Solutions
The combustion engine cannot be started. The warning and indicator lamps in the instrument cluster come on when switching the ignition.	<p>The high-voltage battery is discharged.</p> <p>The discharged high-voltage battery is being charged with the ignition switched on while the vehicle is being jump started (▷ page 33).</p> <ul style="list-style-type: none"> ► Read and observe messages that may appear in the multifunction display (▷ page 24).
The combustion engine cannot be started. The multifunction display does not display any messages.	<p>The self-diagnosis has not been completed yet or the HYBRID system is malfunctioning.</p> <ul style="list-style-type: none"> ► Switch off the ignition and switch it back on. ► Try to start the combustion engine once more. ► If the combustion engine cannot be started: Contact an authorized Mercedes-Benz Center.

RBS (Recuperative Brake System)

Problem	Possible causes/consequences and ► Solutions
Less brake pedal pressure is required and the brake pedal travel is longer than usual.	<ul style="list-style-type: none"> ► Apply the brake pedal fully and release it. The required brake pedal pressure and the brake pedal travel are back to normal.
	<p>The RBS is malfunctioning.</p> <p>Risk of accident!</p> <ul style="list-style-type: none"> ► Read and observe the messages in the multifunction display (▷ page 24) and the notes on warning and indicator lamps in the instrument cluster (▷ page 29).

Problem	Possible causes/consequences and ► Solutions
The brake pedal pulsates.	The RBS is providing electronic controlled brake boost. Read and observe the notes on the ABS/ESP® warning lamp (► page 9).

The HYBRID system switches of automatically

Problem	Possible causes/consequences and ► Solutions
The HYBRID system has switched of automatically.	Your vehicle was involved in an accident. The HYBRID system remains switched off, if <ul style="list-style-type: none"> • the combustion engine cannot be started again after a few seconds • the SRS warning lamp SRS in the instrument cluster comes on ► Contact an authorized Mercedes-Benz Center.
The HYBRID system has switched of automatically. An additional message appears in the multifunction display.	A short circuit in the HYBRID system has occurred or a plug connection of the HYBRID system was disconnected. <ul style="list-style-type: none"> ► Read and observe messages that may appear in the multifunction display (► page 24). ► Contact an authorized Mercedes-Benz Center.

Opening the fuel filler flap manually

Warning!

Avoid contact with the vehicle walls as they may contain sharp edges. Otherwise, you could injure yourself while opening the fuel filler flap.

Warning!

Open the fuel filler flap manually only if the fuel filler flap switch is not operational.
With the fuel filler flap opened manually, fuel may spray out during the refueling process.

In case the fuel filler flap switch (► page 20) does not release the fuel filler flap, you can open it manually.

The fuel filler flap release is located behind a cover on the passenger side in the cargo compartment.



- Open the tailgate, see Operator's Manual.
- Insert a suitable object such as a coin into the slot of locks ①.
- Turn locks ① by 90° in direction of the arrows.
- Remove cover ②.



- ▶ Pull light-blue fuel filler flap release ③ in direction of arrow.
The fuel filler flap is unlocked.
- ▶ Open the fuel filler flap (▷ page 21).
- ▶ Close cover ②.
- ▶ Close the tailgate.

Battery

Notes

Your vehicle is equipped with a 12-volt battery and a high-voltage battery. The high-voltage battery stores the power required for the hybrid transmission. The hybrid transmission also starts the combustion engine.

Have any work on the batteries performed at an authorized Mercedes-Benz Center.

- ① Read and observe the safety notes (▷ page 8) and the notes on the 12-volt battery in the Operator's Manual.

⚠ Warning!

The electrolyte, i.e. the battery fluid, is toxic and caustic. Do not allow this fluid to come in contact with eyes, skin or clothing, for example in case of an accident.

In case it does, immediately flush affected area with water and seek medical help immediately.

For information on the location of the 12-volt battery and the high-voltage battery, see (▷ page 12).

⚠ Deep discharge caused by prolonged periods of the vehicle not being used, can damage the high-voltage battery.

During such periods, operate the vehicle every 4 weeks for several minutes in order to charge the high-voltage battery.

During the charging process, switch off electrical consumers that are currently not needed, e.g. climate control system or seat heating.

If necessary, get a jump start.

⚠ Warning!

Inhalation of exhaust gas is hazardous to your health. All exhaust gas contains carbon monoxide (CO), and inhaling it can cause unconsciousness and lead to death. Do not run the engine in confined areas (such as a garage) which are not properly ventilated.

If you do not intend to operate your vehicle for an extended period of time, contact an authorized Mercedes-Benz Center about steps you need to observe.

Charging the battery

Charging the 12-volt battery

⚠ Warning!

Never charge a battery while still installed in the vehicle unless the accessory battery charge unit approved by Mercedes-Benz is being used. Gases may escape during charging and could cause an explosion that may result in personal injury, paint damage or corrosion.

An accessory battery charge unit specially adapted for Mercedes-Benz vehicles and tested and approved by Mercedes-Benz is available. It permits the charging of the battery in its installed position. Contact an authorized Mercedes-Benz Center for information and availability.

Charge battery in accordance with the separate instructions for the accessory battery charger.

- ▶ Open the hood, see Operators' Manual.
- ▶ Follow the instructions in the separate operating instructions of the charge unit.

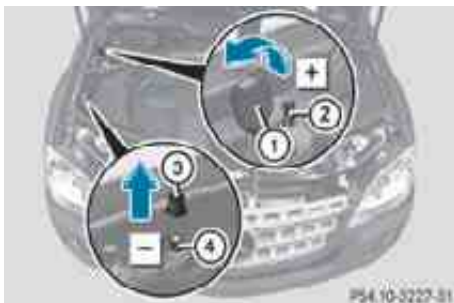

- ▶ Flip up cover ① of the positive terminal in direction of arrow.
- ▶ Connect the positive terminal clamp of the charge unit with positive terminal ②.
- ▶ Slide cover ③ from the negative terminal in direction of arrow.
- ▶ Connect the negative terminal clip of the charge unit with negative terminal ④.
- ▶ Charge the 12-volt battery.

Disconnecting the charge unit

- ▶ After the combustion engine has been started, disconnect the charge unit. Follow the instructions in the separate operating instructions of the charge unit.
- ▶ Close the hood.
- ▶ Drive the vehicle for some time in order to charge the 12-volt battery.

Jump starting

When the 12-volt battery or the high-voltage battery is discharged, the combustion engine can be started with jumper cables and the battery of another vehicle.

Observe the following:

- Jump starting should only be performed when the combustion engine and the catalytic converter are cold.
- Do not jump start if the battery is frozen. Let the battery thaw out first.
- Only jump start from batteries with the same voltage rating (12 V). Jump starting with a more powerful battery could damage the vehicle's electrical system, which is not covered by the Mercedes-Benz Limited Warranty.
- Only use jumper cables with sufficient cross-section and insulated terminal clamps.
- Always make sure the jumper cables are not on or near pulleys, fans or other parts that move when an engine is started or running.
- Should the battery be drained completely, let the donating power source charge the vehicle for several minutes before reattempting the starting process.

i Jumper cables and additional information on jump starting are available at any authorized Mercedes-Benz Center.

! Jump starting should only be performed using the jump-start terminals located in the engine compartment.

Avoid repeated and lengthy starting attempts.

Do not attempt to start the engine using a battery quick-charge unit.

If the engine does not run after several unsuccessful starting attempts, have it checked at the nearest authorized Mercedes-Benz Center.

Excessive unburned fuel generated by repeated failed starting attempts may damage the catalytic converter and may present a fire risk.

Make sure the jumper cables do not have loose or missing insulation.

Make sure the cable clamps do not touch any other metal part while the other end is still attached to a battery.

Connecting the jumper cables

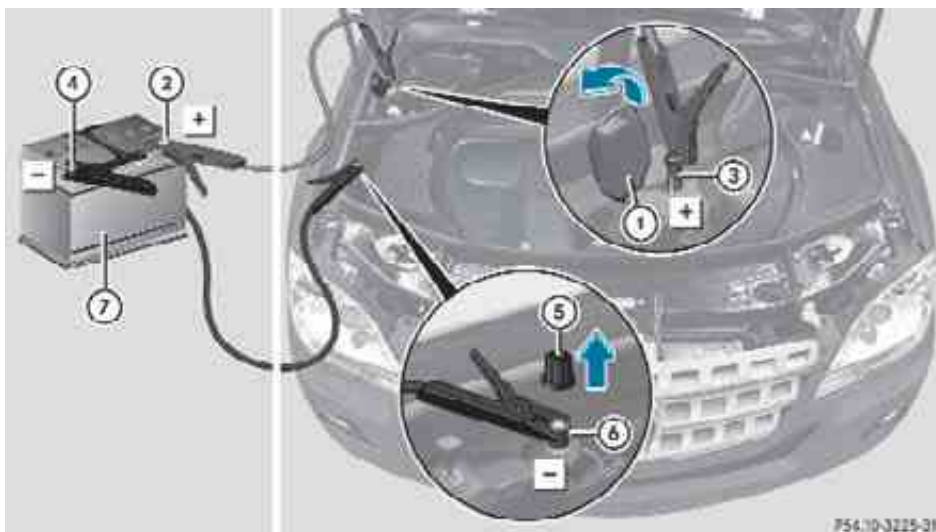

Your vehicle is equipped with two jump start terminals in the engine compartment. Position ⑦ represents the charged battery of another vehicle or an equivalent starter pack.

- ▶ Make sure the two vehicles do not touch.
- ▶ Switch off all electrical consumers.
- ▶ Engage the parking brake.
- ▶ Make sure the automatic transmission is in park position **P**.
- ▶ Open the hood, see Operators' Manual.
- ▶ Flip up cover ① of positive terminal ③ in direction of arrow.
- ▶ Connect positive terminal ② of charged battery ⑦ with positive terminal ③ with a jumper cable. Clamp the cable to positive terminal ② of charged battery ⑦ first.
- ▶ Slide cover ⑤ from negative terminal ⑥ in direction of arrow.
- ▶ Connect negative terminal ④ of charged battery ⑦ with negative terminal ⑥ with

a jumper cable. Clamp the cable to negative terminal ④ of charged battery ⑦ first.

Starting the combustion engine

- ▶ Start the engine of the vehicle with the charged battery and run it at an engine speed slightly above idle speed.
- ▶ Make sure the automatic transmission is in park position **P**.
- ▶ **Starting the jump start process with the SmartKey:** To start the charging process for the high-voltage battery, turn the SmartKey in the starter switch first into starting position **3**.
- ▶ Turn the SmartKey back into ignition position **2**.
- ▶ **Starting the jump start process with KEYLESS-GO:** Depress the brake pedal during the starting procedure.

- ▶ Press the KEYLESS-GO start/stop button once.
- ▶ Remove the foot from the brake pedal. Ignition is switched on automatically. The message **Charging Hybrid Battery Please Wait** appears in the multifunction display. Start the combustion engine when the message **Engine Can Now Be Started** appears in the multifunction display. Depending on the high-voltage battery's discharge, the charging procedure may take up to 60 minutes.
- ▶ After the combustion engine of your vehicle has been started, leave the engines of both vehicles running at idle speed.

Disconnecting the jumper cables

- ▶ Disconnect the jumper cables in reverse order, starting with jump start terminal ④ (> page 34).
- ▶ Close the hood.
- ▶ Drive the vehicle for some time in order to charge the 12-volt battery and the high-voltage battery.

**Vehicle specification ML 450 HYBRID
(164.195)**

The quoted data apply only to the standard vehicle. Contact an authorized Mercedes-Benz Center for the corresponding data of all special bodies and special equipment.

Engine ML 450 HYBRID	
Engine, type	272
Mode of operation	4-stroke engine, gasoline injection
No. of cylinders	6
Bore	3.66 in (92.90 mm)
Stroke	3.39 in (86.00 mm)
Total piston displacement	213.5 cu in (3 498 cm ³)
Compression ratio	11.5:1
Output acc. to SAE J 1349¹	275 hp/6 000 rpm (205 kW/6 000 rpm)
Maximum torque acc. to SAE J 1349	258 lb-ft/ 3 000 - 5 500 (350 Nm/ 3 000 - 5 500 rpm)
Maximum engine speed	6 000 rpm
Firing order	1-4-3-6-2-5
Poly-V-belt	2 398 mm

Hybrid ML 450 HYBRID	
Type	Full hybrid
Concept	Two mode
Output EMA	83 hp (62 kW)

Hybrid ML 450 HYBRID

Output EMB	80 hp (60 kW)
Maximum torque EMA	173 lb-ft (235 Nm)
Maximum torque EMB	192 lb-ft (260 Nm)
System power	335 hp (250 kW) 381 lb-ft (517 Nm)

Electrical system ML 450 HYBRID

High-voltage battery	288 V/45 kW
Battery	12 V/70 Ah
Spark plugs, type	Bosch Y 7 MPP33
Spark plugs, electrode gap	0.031 in (0.8 mm)
Spark plugs, tightening torque	15 - 18 lb-ft (20 - 25 Nm)

Main dimensions ML 450 HYBRID

Overall vehicle length	188.5 in (4 788 mm)
Overall vehicle width²	83.6 in (2 124 mm)
Overall vehicle height	69.8 - 73.0 in (1 774 - 1 854 mm)
Wheelbase	114.8 in (2 915 mm)
Track, front	64.7 in (1 644 mm)
Track, rear	64.8 in (1 647 mm)
Ground clearance	7.3 - 10.3 in (186 - 261 mm)
Turning circle	39.0 ft (11.6 m)

¹ Premium fuel required. Performance may vary with fuel octane rating.

² Exterior rear view mirrors folded out.

Weights ML 450 HYBRID

Roof load	max. 220 lb (100 kg)
------------------	----------------------

Rims and tires

i The ML 450 HYBRID does not have a spare wheel.

Vehicles equipped with 19" wheels come with MOExtended tires. MOExtended tires have run-flat characteristics. The 17" and 18" wheels listed in this section do not have tires with such run-flat characteristics. When replacing factory-equipped 19" wheels with 17" or 18" wheels, retrofitting with TIREFIT is strongly recommended.

For information on MOExtended tires and TIREFIT, refer to the Operator's Manual.

	Model	ML 450 HYBRID
17" wheels	Rims (light alloy)	7.5 J x 17 H2
	Wheel offset	2.21 in (56 mm)
	All-season tires³	235/65 R17 104H M+S
	Winter tires^{3,4}	235/65 R17 104H M+S 

	Model	ML 450 HYBRID
18" wheels	Rims (light alloy)	8 J x 18 H2
	Wheel offset	2.36 in (60 mm)
	All-terrain tires^{3,4}	255/55 R18 105H M+S

	Model	ML 450 HYBRID
19" wheels	Rims (light alloy)	8 J x 19 H2
	Wheel offset	2.36 in (60 mm)
	All-season tires^{3,5}	255/50 R19 107H XL (Extra Load) M+S MOExtended
	Winter tires^{3,4,5}	255/50 R19 107H XL (Extra Load) M+S  MOExtended

³ Radial-ply tires.

⁴ Not available as factory equipment.

⁵ Must be used in conjunction with Advanced Tire Pressure Monitoring System (U.S. vehicles) or tire pressure loss warning system (Canada vehicles) only.

Capacities

Vehicle components and their respective lubricants must match. Therefore only use products tested and approved by Mercedes-Benz.

For information on tested and approved products, contact an authorized Mercedes-Benz Center or visit www.mbusa.com (USA only).

Warning!

Comply with all valid regulations with respect to handling, storing, and disposing of service

fluids. Otherwise you could endanger persons or the environment.

Keep service fluids out of the reach of children.

For health reasons, you should prevent service fluids from coming into direct contact with your skin or clothing.

If a service fluid is swallowed, contact a physician immediately.

Model	Capacity	Fuels, coolants, lubricants, etc.
ML 450 HYBRID		
Engine with oil filter	8.5 US qt (8.0 l)	Approved engine oils
Automatic transmission	13.4 US qt (12.7 l)	MB Automatic Transmission Fluid
Front axle	1.2 US qt (1.1 l)	Hypoid gear oil
Rear axle	1.2 US qt (1.1 l)	Hypoid gear oil
Transfer case	0.53 US qt (0.5 l)	MB Automatic Transmission Fluid
Power steering	approx. 1.3 US qt (1.2 l)	MB Power Steering Fluid or approved Dexron III ATF
Brake system	0.63 US qt (0.6 l)	MB Brake Fluid (DOT 4+)
Cooling system	approx. 10.0 US qt (9.5 l)	MB 325.0 Anticorrosion/ Antifreeze
Low temperature cooling system	approx. 2.0 US qt (1.9 l)	
Fuel tank	23.8 US gal (90.0 l)	Premium unleaded gasoline (Minimum Posted Octane 91 [Avg. of 96 RON/86 MON])
Fuel tank reserve	approx. 3.4 US gal (13.0 l)	

Model ML 450 HYBRID	Capacity	Fuels, coolants, lubricants, etc.
Air conditioning system	—	R134a refrigerant and special PAG lubricant oil (never R 12)
Washer system and headlamp cleaning system	7.6 US qt (7.2 l)	MB Windshield Washer Concentrate ⁶ , see Operator's Manual Washer fluid mixing ratio, see Operator's Manual

Approved engine oils

Use the table below to determine the MB sheet number.

Model ML 450 HYBRID	Engine, type	MB sheet number
	272	229.5

- i** MB sheet numbers are printed on the outside of oil containers.

- i** For more information on approved engine oils, refer to the Operator's Manual.

Coolants

The engine coolant is a mixture of water and anticorrosion/antifreeze.

The cooling system was filled at the factory with a coolant providing freeze protection to approximately -35°F (-37°C) and corrosion protection.

Model ML 450 HYBRID	Approximate freeze protection	
	-35°F (-37°C)	-49°F (-45°C)
Cooling system	5.0 US qt (4.75 l)	5.5 US qt (5.2 l)
Low temperature cooling system	1.0 US qt (0.95 l)	1.1 US qt (1.05 l)

- !** Add premixed coolant solution only. Adding water and MB 325.0 Anticorrosion/Antifreeze separately from each other, could cause engine damage not covered by the Mercedes-Benz Limited Warranty.

- i** For more information on coolants, refer to the Operator's Manual.

⁶ Mixed with water or commercially available premixed washer solvent/antifreeze.

Service and Literature

Your authorized Mercedes-Benz Center has trained technicians and Genuine Mercedes-Benz Parts to service your vehicle properly. For expert advice and quality service, contact an authorized Mercedes-Benz Center.

If you are interested in obtaining service literature for your vehicle, please contact an authorized Mercedes-Benz Center.

We consider this the best way for you to obtain accurate information for your vehicle.

For further information you can find us on the Mercedes-Benz web-site **www.mbusa.com** (USA only) or **www.mercedes-benz.ca** (Canada only).

Warning!

To help avoid personal injury, be extremely careful when performing any service work or repairs. Improper or incomplete service or the use of incorrect or inappropriate parts or materials may damage the vehicle or its equipment, which may in turn result in personal injury.

If you have any questions about carrying out any type of service, turn to the advice of an authorized Mercedes-Benz Center.

We reserve the right to make changes in design and equipment.

Therefore, information, illustrations and descriptions in this Supplemental Operating Instructions might differ from your vehicle.

Reprinting, translation and copying, even of excerpts, is not permitted without our prior authorization in writing.

Press time April 30, 2009

GSP/OIS

Printed in U. S. A.



1645845583

Order no. 6515 4316 13 Part no. 164 584 55 83 Edition A 2010