



Mercedes-Benz

M-Class

Operator's Manual

Symbols

Trademarks®:

- AdBlue® is a registered trademark of the German Association of the Automotive Industry (VDA).
- BabySmart™ is a trademark of Siemens Automotive Corp.
- Bluetooth® is a registered trademark of Bluetooth SIG Inc.
- ESP® and PRE-SAFE® are registered trademarks of Daimler.
- HomeLink® is a registered trademark of Prince, a Johnson Controls Company.
- SIRIUS and related marks are trademarks of SIRIUS XM Radio Inc.

The following symbols are found in this Operator's Manual:

Warning!

Warning notices draw your attention to hazards that may endanger your health or life, or the health or life of others.

 Highlights hazards that may result in damage to your vehicle.

 Helpful hints or further information you may find useful.

▶ This symbol points to instructions for you to follow.

▶ A number of these symbols appearing in succession indicates a multiple-step procedure.

▷ page This symbol tells you where to look for further information on a topic.

▷▷ This continuation symbol marks a warning or procedure which is continued on the next page.

Display Text in displays, such as the control system, are printed in the type shown here.

Our company and staff congratulate you on the purchase of your new Mercedes-Benz.

Your selection of our product is a demonstration of your trust in our company name. Furthermore, it exemplifies your desire to own an automobile that will be as easy as possible to operate and will provide years of service.

Your Mercedes-Benz represents the efforts of many skilled engineers and craftsmen. To help assure your driving pleasure, and also the safety of you and your passengers, we ask you to make a small investment of time:

- Please read this manual carefully, then return it to your vehicle where it will be handy for your reference.
- Please follow the recommendations contained in this manual. They are designed to acquaint you with the operation of your Mercedes-Benz.
- Please pay attention to the warnings and cautions contained in this manual. They are designed to help improve the safety of the vehicle operator and occupants.

We extend our best wishes for many miles of safe, pleasurable driving.

Mercedes-Benz USA, LLC

A Daimler Company

Index	4	At a glance	25
Introduction	20	Safety and security	35
		Controls in detail	69
		Operation	209
		Practical hints	267
		Technical data	345

- 1, 2, 3 ...
- 115V AC Socket** 198
- 3-zone automatic climate control**
see Climate control system
- 4-ETS**
see ETS/4-ETS
- 4MATIC**
see All-wheel drive (4MATIC)
- A**
- ABS (Antilock Brake System)** 62
Indicator lamp 298
Messages in the multifunction
display 273, 284
- Accessory weight** 239
- Accidents** 107
Air bags 37
Distance warning function 151
Emergency calls (Tele Aid) 200
NECK-PRO active front head
restraints 53
- Active Bi-Xenon headlamps**
Messages in the multifunction
display 293
see Headlamps
- Adaptive Damping System**
see ADS
- AdBlue®** 331, 361
Capacity, AdBlue® tank 358
Refilling 332
- Additives**
Engine oil 359
Gasoline 361
- Address change** 22
- ADS (Adaptive Damping System)** 156
- Advanced Tire Pressure
Monitoring System (Advanced
TPMS)** 223
Messages in the multifunction
display 281, 296
- Air bags** 37
Emergency call upon deployment .. 200
Front, driver and passenger 40
Front passenger front air bag off
indicator lamp (Canada
only) 46, 305
- Front passenger front air bag off
indicator lamp (USA only) 42, 305
Messages in the multifunction
display 275
OCS (Occupant Classification
System) 42
Safety guidelines 39
Side impact 40
Window curtain 41
- Air conditioning refrigerant and
lubricant** 359
- Air distribution** 171, 180
- Air filter** 292
- AIRMATIC/Compass menu** 127
- Air pressure**
see Tire inflation pressure
- Air pressure (tires)** 240
- Air pump (electric)** 328
- Air recirculation mode** 172, 182
- Air suspension program**
Comfortable driving style 156
Introduction 155
Messages in the multifunction
display 285
Sporty driving style 156
Suspension tuning 156
Vehicle level control 156
- Air volume** 171, 181
- Alarm system**
see Anti-theft systems
- Alignment bolt (vehicle tool
kit)** 268, 327
- All-wheel drive (4MATIC)** 159
- Alternator**
Messages in the multifunction
display 280, 290
- Alternator (Technical data)**
see Vehicle specification
- AMG menu** 123
- Anticorrosion/antifreeze** 363
- Antilock Brake System**
see ABS
- Anti-theft systems** 66
Anti-theft alarm system 66
Immobilizer 66
- Aquaplaning**
see Hydroplaning

- Armrest, front**
Storage compartment 193
- Ashtrays** 196
- Aspect ratio (tires)** 240
- Audio/DVD menu** 126
- Auto-dimming rear view mirrors** 90
- Automatic central locking** 74, 135
- Automatic headlamp mode** 93
- Automatic interior lighting control** 97
- Automatic locking when driving** 135
- Automatic shift program** 114
- Automatic transmission** 109
Automatic shift program 114
Emergency operation (limp-home mode) 117
Gear range indicator 114
Gear ranges 113
Gear selector lever 109
Hill-start assist system 152
Kickdown 113
Kickdown (manual shift program) .. 117
Manual shift program 115
One-touch gearshifting 115
Program mode indicator 114
Program mode selector switch (automatic shift program) 114
Program mode selector switch (manual shift program) 116
Shifting procedure 111
Steering wheel gearshift control 115
Towing a trailer 113
Transmission position indicator 112
Transmission positions 112
- AUX socket** 193
- Axle oils** 357
- B**
- BabySmart™**
Air bag deactivation system 46
Self-test 47
- Backrest**
see Seats
- Backup lamps**
Messages in the multifunction display 293
- Bar (air pressure unit)** 240
- BAS (Brake Assist System)** 63
- Batteries, SmartKey**
Checking condition 73
Replacing 309
- Battery, Vehicle** 334
Charging 336
Jump starting 336
Messages in the multifunction display 280, 290
- Bead (tire)** 240
- Beverage holders**
see Cup holders
- Bleeding the fuel system (diesel engine)** 331
- BlueTEC**
AdBlue® tank 331
AdBlue® tank capacity 358
- Brake fluid**
Checking level 217
Messages in the multifunction display 284
- Brake lamps**
Cleaning lenses 263
- Brake pads**
Messages in the multifunction display 283
- Brakes** 245
High-performance brake system 246
Parking brake 107, 247
Warning lamp 299
- Break-in period** 210
- Bug cover (Radiator)** 214
- Bulbs**
see Replacing bulbs
- C**
- CAC (Customer Assistance Center)** ... 23
- California retail buyers and lessees, important notice for** 21
- Calls (phone)** 139
- Can holders**
see Cup holders
- Capacities and recommended fuel/lubricants** 356
- Cargo compartment**
Cargo net 191
Cargo volume, expanding 189
Cover blind 190

- Fuse box 344
- Hooks 189
- Tie-down rings 188
- Cargo compartment cover blind** 190
- Cargo net** 191
- Cargo tie-down rings** 188
- Carpets, cleaning** 265
- Carriers** 187
- Center console**
 - Lower part 32
 - Upper part 31
- Central locking**
 - Automatic 74, 135
 - KEYLESS-GO 71
 - Locking/unlocking from inside 75
 - SmartKey 70
- Central locking/unlocking switch** 75
- Certification label** 346
- Children in the vehicle**
 - Air bags 37
 - BabySmart™ air bag deactivation system 46
 - Child safety locks (rear doors) 60
 - Child seat anchors – LATCH-type 59
 - Indicator lamp, front passenger front air bag off (Canada only) 46
 - Indicator lamp, front passenger front air bag off (USA only) 42
 - Infant and child restraint systems ... 56
 - OCS (Occupant Classification System) 42
 - Override switch 60
 - Safety notes 55
 - Tether anchorage points 58
 - Top tether 58
- Child safety**
 - see Children in the vehicle
- Child seat anchors – LATCH-type**
 - see Children in the vehicle
- Chrome-plated exhaust tip, cleaning** 266
- Cigarette lighter** 196
- Climate control system** 165
 - 3-zone automatic climate control .. 173
 - Air conditioning 169, 178
 - Air conditioning refrigerant 359
 - Air distribution 171, 180
 - Air recirculation mode 172, 182
 - Air volume 171, 181
 - Automatic mode 170, 179
 - Climate control 167
 - Deactivating system 169, 178
 - Front defroster 171, 181
 - Residual heat and ventilation 172, 183
 - Temperature 170, 179
- Clock** 28, 132
- Cockpit** 27
- Cold tire inflation pressure** 240
- Collapsible tire (spare wheel)** 356
- Collapsible wheel chock** 270
- COMAND system**
 - see separate COMAND system operating instructions
- Combination switch** 95
- Comfort submenu**
 - Easy-entry/exit feature 136
 - Fold-in function for exterior rear view mirrors 137
 - Seat belt adjustment feature 136
- Compass**
 - Calling up 207
- Control system** 119
 - Multifunction display 121
 - Multifunction steering wheel 119
 - Resetting to factory settings 129
- Control system menus** 121
 - AIRMATIC/Compass 127
 - AMG 123
 - Audio/DVD 126
 - Distronic 128
 - Navigation 127
 - Off-road Mode 125
 - Settings 129
 - Standard display 122
 - Telephone 139
 - Trip computer 138
 - Vehicle configuration 137
 - Vehicle status message memory ... 128
- Control system submenus**
 - Comfort 135
 - Instrument cluster 130
 - Lighting 133
 - Time/Date 132
 - Vehicle 135

- Coolant**
- Anticorrosion/antifreeze 363
 - Capacities 358
 - Checking level 216
 - Messages in the multifunction display 288
- Corner-illuminating front fog lamps** 96
- Cruise control** 141
- Activating 142
 - Canceling 142
 - Changing the set speed 143
 - Last stored speed 143
 - Lever 142
 - Messages in the multifunction display 278
 - Resume function 143
 - Setting current speed 142
- Cup holders** 194
- Curb weight** 240
- Customer Assistance Center (CAC)** ... 23
- Customer Relations Department** 24
- D**
- Dashboard**
- see Instrument cluster
- Data recording** 24
- Date, Setting** 132
- Daytime running lamp mode** 94
- Switching on or off 133
- Deep water**
- see Standing water
- Defroster**
- Rear window 183
 - Windshield 171, 181
- Delayed shut-off**
- Exterior lamps 134
 - Interior lighting 135
- Department of Transportation**
- see DOT
- Diesel engine**
- Preglow indicator lamp 29
- Diesel fuel**
- see Fuel
- Difficulties**
- While driving 106
 - With starting 105
- Digital clock**
- see Clock
- Digital speedometer** 123
- Dimensions (vehicle)**
- see Vehicle specification
- Direction of rotation (tires)** 231
- Displays**
- Digital speedometer 123
 - Distronic 146
 - Maintenance service indicator 258
 - Messages in the multifunction display 272
 - Multifunction display 121
 - Outside temperature 123, 131
 - Symbol messages 283
 - Text messages 273
 - Trip computer 138
 - Vehicle status message memory ... 128
 - Vehicle system settings 129
- Distronic** 144
- Cleaning system sensor cover 263
 - Control system 128
 - Distance warning function 151
 - Distance warning lamp 146, 302
 - Driving with 150
 - Menu 147
 - Messages in the multifunction display 278
 - Resume function 149
 - Sensor cover 263
 - Speed settings 148
- Door control panel** 33
- Door handles** 33
- Doors**
- Child safety locks 60
 - Locking/unlocking (KEYLESS-GO) ... 71
 - Locking/unlocking (SmartKey) 70
 - Messages in the multifunction display 286
 - Opening from inside 74
 - Remote door unlock (Tele Aid) 203
 - Unlocking (Mechanical key) 306
- DOT (Department of Transportation)** 240
- Downhill Speed Regulation**
- see DSR
- Drinking and driving** 244

- Driving**
- Abroad 257
 - Hydroplaning 247
 - Instructions 103, 244
 - In winter 243
 - Off-road 248
 - Problems 106
 - Safety systems 61
 - Systems 141
 - Through standing water 247
 - With Distronic 150
- Driving and parking**
- Safety notes 103
- Driving off** 105, 247
- Driving safety systems** 61
- ABS 62
 - BAS 63
 - EBP 63
 - ESP® 63
 - ETS/4-ETS 64
- Driving systems**
- Air suspension program 155
 - All-wheel drive (4MATIC) 159
 - Cruise control 141
 - Distronic 144
 - Downhill Speed Regulation (DSR) .. 152
 - Hill-start assist system 152
 - Off-road driving program 155
 - Parktronic system 160
 - Rear view camera 163
- Driving tips, automatic transmission** 113
- DSR (Downhill Speed Regulation)** 152
- Messages in the multifunction display 286
- E**
- Easy-entry/exit feature** 87, 136
- EBP (Electronic Brake Proportioning)** 63
- Electrical system**
- Improper work on or modifications 23
 - Power outlets 197
- Electrical system (Technical data)**
- see Vehicle specification
- Electronic Stability Program**
- see ESP®
- Electronic Traction System**
- see ETS/4-ETS
- Emergency, in case of**
- First aid kit 268
 - Flat tire 319
 - Hazard warning flasher 96
 - Roadside Assistance 21, 201
 - Towing the vehicle 338
- Emergency calls**
- Tele Aid 200
- Emergency engine shutdown** 344
- Emergency operations**
- Limp-home mode 117
 - Remote door unlock (Tele Aid) 203
- Emergency Tensioning Device**
- see ETD
- Emission control** 258
- Information label 347
 - System warranties 20
- Engine**
- Break-in recommendations 210
 - Cleaning 262
 - Compartment 212
 - Malfunction indicator lamp 29, 303
 - Messages in the multifunction display 288
 - Number 347
 - Starting 103
 - Turning off 108
- Engine (Technical data)**
- see Vehicle specification
- Engine compartment**
- Radiator 214
- Engine coolant**
- see Coolant
- Engine oil**
- Adding 215
 - Additives 359
 - Checking level 214
 - Consumption 214
 - Messages in the multifunction display 291

- Oil dipstick 215
 - Recommended engine oils and oil filter 359
 - ESP® (Electronic Stability Program)** 63
 - ETS/4-ETS 64
 - Messages in the multifunction display 273, 284
 - Off-road ESP® 65
 - Trailer stabilization 66
 - Warning lamp 301
 - ETD (Emergency Tensioning Device)** 52
 - Safety guidelines 39
 - ETS/4-ETS (Electronic Traction System)** 64
 - Express operation**
 - Power windows 100
 - Tilt/sliding sunroof 184
 - Exterior lamp switch** 93
 - Exterior rear view mirrors** 89
 - Fold-in function 91, 137
 - Parking position 90
 - Power-folding 91
 - Exterior view of vehicle** 26
- F**
- Fastening the seat belts** 50
 - First aid kit** 268
 - Flat tire** 319
 - Lowering the vehicle 329
 - Mounting the spare wheel 324
 - Preparing the vehicle 320
 - Spare wheel 319, 356
 - TIREFIT (tire repair kit) 320
 - Floormats** 208
 - Fluids**
 - AdBlue® 358
 - Automatic transmission fluid 357
 - Brake fluid 358
 - Capacities 356
 - Engine coolant 358
 - Engine oil 357
 - Power steering fluid 357
 - Washer and headlamp cleaning system 358
 - Fog lamps** 95
 - Messages in the multifunction display 293, 294
 - Fold-in function for exterior rear view mirrors** 91, 137
 - Four-wheel drive**
 - see All-wheel drive (4MATIC)
 - Front air bags**
 - see Air bags
 - Front axle oil** 357
 - Front lamps**
 - see Headlamps
 - Front passenger front air bag** 40
 - Messages in the multifunction display 275
 - Front passenger front air bag off indicator lamp (Canada only)** 46, 305
 - Front passenger front air bag off indicator lamp (USA only)** 42, 305
 - Front seat head restraints**
 - see Head restraints
 - Fuel** 210
 - Additives 361
 - Capacity, fuel tank 358
 - Diesel fuel 358, 360
 - Drive sensibly-safe fuel 244
 - Fuel consumption statistics 138
 - Fuel filler flap and cap 212
 - Fuel tank reserve warning lamp 29, 303
 - Premium unleaded gasoline ... 358, 360
 - Refueling 210
 - Requirements 360
 - Fuel filler flap** 212
 - Opening manually 308
 - Fuels, coolants, lubricants etc.**
 - Capacities 356
 - Fuel system, bleeding (diesel engine)** 331
 - Fuel tank**
 - Capacity 358
 - Fuel filler flap and cap 212
 - Refueling 210
 - Fuses** 342

G

Garage door opener	32, 204
Gasoline	
see Fuel	
GAWR (Gross Axle Weight Rating) ...	240
Gear range	113
Indicator	114
Limiting	115
Shifting into optimal	115
Gear selector lever	109
Cleaning	265
Gearshift pattern	109
Shifting procedure	111
Transmission position indicator	112
Transmission positions	112
Generator	
see Alternator	
Global locking/unlocking	
see Key, SmartKey	
Glove box	193
Gross Axle Weight Rating	
see GAWR	
Gross Trailer Weight	
see GTW	
Gross Vehicle Weight	
see GVW	
Gross Vehicle Weight Rating	
see GVWR	
GTW (Gross Trailer Weight)	240
GVW (Gross Vehicle Weight)	240
GVWR (Gross Vehicle Weight Rating)	240

H

Halogen headlamps	
see Headlamps	
Hard plastic trim items, cleaning	265
Hazard warning flasher	96
Headlamp cleaning system	96
Headlamps	
Active Bi-Xenon headlamps	92
Adjusting aim	317
Automatic headlamp mode	93
Bi-Xenon	92, 312
Cleaning lenses	263
Cleaning system	96

Daytime running lamp mode	94
Delayed shut-off	134
Halogen	312
High-beam flasher	96
High-beam headlamps	96
Low-beam headlamps	93
Replacing bulbs	311
Switch	93
Headliner, cleaning and care of	265
Head restraints	81
Adjustment	81, 83
Folding back	84
NECK-PRO active front head restraints	53
NECK-PRO active front head restraints, resetting	309
Rear seat head restraints	84
Heated steering wheel	88
Height adjustment	
Seat belt outlet	51
Seats	81
Vehicle level control	156
High-beam flasher	96
High-beam headlamps	96, 312
Indicator lamp	29
High-performance brake system	246
Hill-start assist system	152
Hood	212
Messages in the multifunction display	286
Hooks	189
Horn	27
HVAC	
see Climate control system	
Hydroplaning	247

I

Identification labels	346
Identification number, vehicle (VIN)	347
Ignition	79, 80, 104
Immobilizer	66
Indicator lamps	
see Lamps, indicator and warning	
Infant and child restraint systems	
see Children in the vehicle	

- Inflation pressure**
see Tires, Inflation pressure
- Infrared reflecting windshield** 208
- Inside door handle** 74
- Instrument cluster** 117
Illumination 118
Lamps 297
Multifunction display 121
- Instrument lighting**
see Instrument cluster, Illumination
- Instrument panel**
see Instrument cluster
- Instruments and controls**
see Cockpit
- Interior lighting**
Delayed shut-off 135
Emergency lighting 98
Front 97
Front reading lamps 97
Rear 98
Rear reading lamps 98
- Interior rear view mirror** 89
Auto-dimming rear view mirrors 90
- Interior storage spaces**
see Storage compartments
- Intermittent wiping**
Rain sensor 99
- J**
- Jack** 270
- Jump starting** 336
- K**
- Key, Mechanical**
Loss of 73
Replacing 74
Unlocking/locking manually 306
- Key, SmartKey**
Battery check lamp 73
Checking batteries 73
Factory setting 71, 72
Global locking (KEYLESS-GO) 73
Global locking (SmartKey) 71
Global unlocking (KEYLESS-GO) 72, 73
Global unlocking (SmartKey) 71
Important notes on KEYLESS-GO 72
Locking/unlocking 70
Loss of 73
Messages in the multifunction display 286, 287
Opening and closing the power tilt/sliding sunroof 102
Opening and closing the windows . 102
Remote control 70
Replacing 74
Replacing batteries 309
Restoring to factory setting 71, 73
Selective setting 71, 73
Starter switch positions 79
- KEYLESS-GO**
Starter switch positions 80
- Kickdown** 113
- Kickdown (manual shift program)** ... 117
- Kilopascal (air pressure unit)** 240
- L**
- Labels**
Certification 346
Emission control information 347
Tire and Loading Information placard 227
Tire inflation pressure 220
- Lamps, exterior**
Exterior lamp switch 93
Front 312
Messages in the multifunction display 293
Rear 312
Switching on/off 93
- Lamps, indicator and warning**
ABS 28, 298
Brakes 28, 299
Center console 31
Distance warning lamp 146, 151, 302
Engine malfunction 29, 303
ESP® 28, 301
Fog lamps 95
Front passenger front air bag off (Canada only) 46, 305

Front passenger front air bag off
(USA only) 42, 305

Fuel tank reserve 29, 303

High-beam headlamps 29, 96

Instrument cluster 28, 297

Low-beam headlamps 29, 93

Low tire pressure/TPMS
malfunction telltale 28, 304

Seat belt telltale 29, 51, 300

SRS 29, 36, 301

Turn signals 28

Language, selecting 131

LATCH-type child seat anchors
see Children in the vehicle

License plate lamps
Messages in the multifunction
display 294

Replacing bulbs 313

Light alloy wheels, cleaning 264

Lighter
see Cigarette lighter

Lighting 92

Daytime running lamp mode 94

Exterior 93

Interior 97

Limp-home mode 117

Load index (tires) 236, 240

Loading
see Vehicle loading

Locator lighting 133

Lock button
Outside door handle (KEYLESS-
GO) 73

Locking the vehicle
KEYLESS-GO 71

Manually 307

SmartKey 70

Loss of
Key 73

Service and Warranty Information
booklet 346

Low-beam headlamps 93

Exterior lamp switch 93

Indicator lamp 29

Switching on 93

Lubricants 356

Lumbar support 84

M

Maintenance 21

Maintenance System
Service indicator display 259

Service indicator message 258

Service term exceeded 259

**Manual headlamp mode (Low-
beam headlamps)** 93

Manual shift program 115

Maximum engine speed
see Vehicle specification

Maximum loaded vehicle weight 241

Maximum load rating (tires) 240

**Maximum permissible tire
inflation pressure** 241

Mechanical key 306

Media interface 193

Memory function 92

Menus
see Control system menus

Minispare wheel
see Spare wheel

Mirrors 89

Auto-dimming rear view mirrors 90

Exterior rear view mirror parking
position 90

Exterior rear view mirrors 89

Interior rear view mirror 89

Memory function 92

Power-folding exterior rear view
mirrors 91

Vanity mirror 195

MOExtended system 330

MOExtended tires 330, 352

MON (Motor Octane Number) 360

Motor Octane Number
see MON

Multicontour seat 85

Multifunction display 121

Symbol messages 283

Text messages 273

Vehicle status messages 272

Multifunction display messages
ABS 273, 284

Active headlamps 293

Advanced TPMS 281, 296

Air bags 275

Air filter	292
Air suspension program	285
Alternator	280, 290
Automatic transmission	280
Battery	280, 290
Brake fluid	284
Brake pads	283
Coolant	288
Corner-illuminating front fog lamps	295
Cruise control	278
Distronic	278
Doors	286
Downhill Speed Regulation (DSR) ..	286
EBP	284
Engine oil	291
ESP®	273, 284
Fog lamps	293, 294
Front passenger front air bag	275
Gas cap	292
High-beam lamps	294
Hood	286
License plate lamps	294
Light sensor	294
Low-beam lamps	294
Parking brake	284
Parking lamps	294
PRE-SAFE®	274
Reserve fuel	291
Reverse lamp	293
Side marker lamps	293
SmartKey	286, 287
SmartKey with KEYLESS-GO	286
SRS	285
Tailgate	286
Tail lamps	295
Tele Aid	285
Tire inflation pressure	281, 296
Tire pressure monitor	281
Tires	281, 296
Trailer brake lamps	295
Trailer tail lamps	295
Trailer turn signal lamps	295
Turn signals	296
Washer fluid	288

Multifunction steering wheel

Adjustment	86
Buttons	119
Cleaning	265
Easy-entry/exit feature	87, 136
Gearshift control	115
Heating	88
Memory function	92
Overview	30

N

Navigation menu	127
------------------------------	-----

Navigation system

see Separate operating instructions

NECK-PRO active front head

restraints	53
Resetting	309

Nets, parcel	188
---------------------------	-----

Night security illumination	134
--	-----

Normal occupant weight	241
-------------------------------------	-----

Number, vehicle identification

(VIN)	347
-------------	-----

O

Occupant Classification System

see OCS (Occupant Classification System)

Occupant distribution	241
------------------------------------	-----

Occupant safety

Air bags	37
BabySmart™	46
Children and air bags	37
Children in the vehicle	55
Child seat anchors - LATCH-type	59
Fastening the seat belts	50
Front passenger front air bag off indicator lamp (Canada only)	46, 305
Front passenger front air bag off indicator lamp (USA only)	42, 305
Infant and child restraint systems	56
Introduction	36
OCS (Occupant Classification System)	42
PRE-SAFE®	52
Seat belts	39, 48

- OCS (Occupant Classification System)** 42
 - Self-test 45
 - Odometer** 121
 - Off-road driving** 248
 - Checklist 249, 253
 - Crossing obstacles 252
 - Driving instructions 248
 - Driving on sand 252
 - Driving through water 251
 - Returning 253
 - Ruts 253
 - Steep terrain 250
 - Off-road driving program** 155
 - Off-road Mode menu** 125
 - Oil, oil level**
 - see Engine oil
 - On-board computer**
 - see Control system
 - One-touch gearshifting** 115
 - Operating safety** 23
 - Ornamental moldings, cleaning** 262
 - Outside temperature**
 - see Displays
 - Overhead control panel** 32
- P**
- Paintwork, cleaning** 261
 - Paintwork code** 347
 - Panic alarm** 61
 - Parcel nets** 188
 - Parking** 107
 - Parktronic system 160
 - Parking brake** 107, 247
 - Messages in the multifunction display 284
 - Parking position**
 - Exterior rear view mirrors 90
 - Transmission position 112
 - Parktronic system**
 - Cleaning system sensors 263
 - Malfunction 163
 - Minimum distance 161
 - Sensor range 161
 - Switching on/off 162
 - System sensors 160
 - Warning indicators 27, 161
 - Parts service** 346
 - PASS AIR BAG OFF indicator lamp (Canada only)**
 - see Front passenger front air bag off indicator lamp (Canada only)
 - PASS AIR BAG OFF indicator lamp (USA only)**
 - see Front passenger front air bag off indicator lamp (USA only)
 - Passenger safety**
 - see Occupant safety
 - Pedals** 244
 - Phone**
 - see Telephone
 - Plastic parts, cleaning** 264
 - Power assistance** 244
 - Power outlets** 197
 - Power seats**
 - see Seats
 - Power tailgate**
 - Closing 76
 - Messages in the multifunction display 286
 - Opening 76
 - Power tilt/sliding sunroof**
 - Operation 184
 - Synchronizing 186
 - Power washer** 261
 - Power windows** 100
 - Cleaning 264
 - Operation 100
 - Rear door window, override switch 60
 - Synchronizing 102
 - Practical hints** 268
 - Preglow indicator lamp** 29, 104
 - PRE-SAFE®** 52
 - Messages in the multifunction display 274
 - Problems**
 - While driving 106
 - With vehicle 23
 - With wipers 100
 - Product information** 20
 - Production options weight** 241

Program mode selector switch	
Automatic shift program	114
Manual shift program	116
Proximity key	
see Key, SmartKey	
PSI (air pressure unit)	241

R

RACETIMER	124
Radiator	214, 242
Radio	
Selecting stations	126
Radio transmitters	257
Rain sensor	
see Intermittent wiping	
Rear axle oil	357
Rear center console ashtray	
see Ashtrays	
Rear doors	
Child safety locks	60
Rear door window	
Override switch	60
Rear fog lamp	
see Fog lamps	
Rear lamps	
see Tail lamps	
Rear seat head restraints	
see Head restraints	
Rear view camera	163
Cleaning the camera lens	263
Rear window defroster	183
Rear window wiper/washer	100
Recommended tire inflation	
pressure	219, 241
Refilling	
AdBlue®	332
Refrigerant, air conditioning	359
Refueling	210
Regular checks	212
Reminder, Seat belt	
see Seat belts, Telltale	
Remote control	
see Key, SmartKey	
Remote door unlock (Tele Aid)	203
Replacing	
Key	74
Replacing bulbs	311

Reporting safety defects	24
Research Octane Number	
see RON	
Reserve fuel	
Messages in the multifunction	
display	291
Warning lamp	29
Reset button	28, 118
Reset tool (NECK-PRO active front	
head restraints)	309
Restraint systems	
see Occupant safety	
Rims	241, 352
Roadside Assistance	21, 201
RON (Research Octane Number)	360
Rubber parts, cleaning	264
Run-flat tires	
see MOExtended tires	

S

Safety	
Driving safety systems	61
Occupant safety	36
Reporting defects	24
Safety belts	
see Seat belts	
Seat belt force limiter	52
Seat belts	48
Adjustment function	51
Children in the vehicle	55
Cleaning	265
Fastening	50
Height adjustment	51
Proper use of	48
Safety guidelines	39
Safety notes	48
Telltale	29, 300
Seat heating	86
Seating capacity	228
Seats	81
Adjustment	81
Easy-entry/exit feature	87
Folding (expanding cargo volume) .	189
Heating	86
Memory function	92
Multicontour seat	85
Ventilation	85

- Securing cargo**
Cargo tie-down rings 188
- Selective setting**
see Key, SmartKey
- Selector lever**
see Gear selector lever
- Self-test**
BabySmart™ 47
OCS (Occupant Classification System) 45
Tele Aid 199
- Service**
see Maintenance
- Service, parts** 346
- Service and warranty information** 20
- Service intervals**
see Maintenance System, Service indicator message
- Service life (tires)** 232
- Settings**
Factory setting (KEYLESS-GO) 72
Factory setting (SmartKey) 71
Memory function 92
Menu 129
Selective setting (KEYLESS-GO) 73
Selective setting (SmartKey) 71
- Side impact air bags** 40
- Side marker lamps**
Cleaning lenses 263
Messages in the multifunction display 293
- Sidewall (tires)** 241
- SmartKey**
see Key, SmartKey
- SmartKey with KEYLESS-GO**
see Key, SmartKey
- Snow chains** 243
- Snow tires**
see Winter tires
- Spare wheel** 352
Mounting 324
Storage location 271
- Speedometer** 28, 146
- Speed settings**
Cruise control 142
Distronic 148
Resume function 143, 149
- Sport Utility Vehicle**
see SUV
- SRS**
Indicator lamp 29, 36, 301
Messages in the multifunction display 285
- Standing water, driving through** 247
- Starter switch positions**
KEYLESS-GO 80
SmartKey 79
- Starting difficulties (engine)** 105
- Starting the engine** 103
- Steering column**
see Multifunction steering wheel, Adjustment
- Steering wheel**
see Multifunction steering wheel
- Steering wheel gearshift control** 115
- Stolen Vehicle Recovery Services** 204
- Storage compartments** 192
- Storing tires** 233
- Stranded vehicle** 342
- Sunroof**
see Power tilt/sliding sunroof
- Sun visors** 195
- Suspension tuning**
see Air suspension program
- SUV (Sport Utility Vehicle)** 22

T

- Tachometer** 29, 119
Overspeed range 119
- Tailgate**
Closing 75
Messages in the multifunction display 286
Opening 75
Power tailgate 76
Unlocking manually 307
- Tail lamps** 312
Cleaning lenses 263
Messages in the multifunction display 295
- Tar stains** 261
- Technical data**
Air conditioning refrigerant 359
Brake fluid 359

- Capacities fuels, coolants,
lubricants etc. 356
- Coolant 362
- Engine oil additives 359
- Engine oils 359
- Fuel requirements 360
- Gasoline additives 361
- Identification labels 346
- Premium unleaded gasoline 360
- Rims and tires 352
- Spare wheel 356
- Vehicle specification ML 350 348
- Vehicle specification
ML 350 4MATIC 349
- Vehicle specification
ML 350 BlueTEC 4MATIC 348
- Vehicle specification
ML 550 4MATIC 350
- Vehicle specification ML 63 AMG .. 351
- Washer and headlamp cleaning
system 358, 364
- Technical data (dimensions)**
see Vehicle specification
- Technical data (electrical system)**
see Vehicle specification
- Technical data (engine)**
see Vehicle specification
- Technical data (weights)**
see Vehicle specification
- Tele Aid** 199
 - Emergency calls 200
 - Information button 202
 - Initiating an emergency call
manually 201
 - Messages in the multifunction
display 285
 - Remote door unlock 203
 - Roadside Assistance button 201
 - Search & Send 203
 - SOS button 201
 - Stolen Vehicle Recovery Services .. 204
 - System self-test 199
- Telephone** 30
 - Answering/ending a call 140
 - Hands-free microphone 33
 - Menu 139
 - Operation 139
- Phone book 140
- Redialing 141
- Temperature**
 - Interior temperature 170, 179
 - Outside 123, 131
- Tether anchorage points**
see Children in the vehicle
- Tie-down rings** 188
- Tightening torque**
 - Wheels 330
- Time setting** 132
- TIN (Tire Identification Number)** 241
- Tire and Loading Information placard** 227
- Tire and loading terminology** 239
- TIREFIT** 320
- Tire Identification Number**
see TIN
- Tire inflation pressure**
 - Checking 221
 - Important notes on 220
 - Label on the inside of fuel filler
flap 220
 - Placard on driver's door B-pillar 227
- Tire labeling** 235
- Tire load rating** 240
- Tire ply composition and material used** 241
- Tire pressure loss warning system** . 222
- Tire repair kit**
see TIREFIT
- Tires** 218, 352
 - Advanced Tire Pressure
Monitoring System (Advanced
TPMS) 223
 - Air pressure 219
 - Care and maintenance 232
 - Cleaning 233
 - Direction of rotation, spinning 231
 - Important notes on tire inflation
pressure 220
 - Inflation pressure 221
 - Information placard 227
 - Inspection 232
 - Labeling 235
 - Load index 236, 240
 - Load rating 240

- Messages in the multifunction display 281, 296
 - MOExtended 352
 - Ply composition and material used 241
 - Problems under-/overinflation 221
 - Retreads 218
 - Rims and tires (technical data) 352
 - Rotation 234
 - Service life 232
 - Sizes 352
 - Snow chains 243
 - Speed rating 237, 241
 - Storing 233
 - Temperature 220, 234
 - Terminology 239
 - TIREFIT (tire repair kit) 320
 - Tire Identification Number 241
 - Tire pressure loss warning system . 222
 - TPMS low tire pressure/malfunction telltale 304
 - Traction 233, 241
 - Tread 242
 - Tread depth 232, 242
 - Treadwear 233
 - Treadwear indicators 232, 242
 - Vehicle maximum load on 242
 - Wear pattern 234
 - Winter tires 242, 352
 - Tire speed rating** 237, 241
 - Tongue Weight Rating**
see TWR
 - Top tether**
see Children in the vehicle
 - Total load limit** 241
 - Towing**
 - Towing eye bolt 339
 - Trailer 113, 254
 - Vehicle 338
 - Towing eye bolt** 339
 - Traction** 233, 241
 - Trailer towing** 113, 254
 - Coupling a trailer 255
 - Decoupling 257
 - Electrical connections 254
 - Towing 256
 - Trailer hitch 254
 - Weights and ratings 254
 - Transfer case** 117
 - Transmission**
see Automatic transmission
 - Transmission fluid level** 216
 - Transmission gear selector lever**
see Gear selector lever
 - Transmission positions** 112
 - Traveling abroad** 257
 - Tread (tires)** 242
 - Tread depth (tires)** 232, 242
 - Treadwear** 233
 - Treadwear indicators (tires)** 232, 242
 - Trip computer menu** 138
 - Trip odometer, resetting** 118
 - Turning off the engine** 108
 - Turn signals** 95
 - Cleaning lenses 263
 - Indicator lamps 28
 - Messages in the multifunction display 296
 - TWR (Tongue Weight Rating)** 242
- U**
- Uniform Tire Quality Grading Standards** 233, 242
 - Units**
 - Selecting digital speedometer display mode 131
 - Selecting speedometer/odometer display mode 131
 - Unleaded gasoline, premium** 360
 - Unlocking the vehicle**
 - KEYLESS-GO 71
 - Manually 306
 - SmartKey 70
 - Upholstery, cleaning** 265
 - Useful features** 194
- V**
- Vehicle**
 - Battery 334
 - Care 260
 - Control system 119
 - Identification Number (VIN) 346
 - Locking/unlocking 70
 - Lowering (wheel change) 329

- Modifications and alterations,
 - Operating safety 23
 - Towing 338
 - Unlocking/locking manually 306
 - Vehicle configuration menu** 137
 - Vehicle dimensions**
 - see Vehicle specification
 - Vehicle Identification Number (VIN)** 346
 - Vehicle jack**
 - see Jack
 - Vehicle level control**
 - see Air suspension program
 - Vehicle lighting** 92
 - Vehicle loading**
 - Cargo tie-down rings 188
 - Cargo volume, expanding 189
 - Carriers 187
 - Instructions 186
 - Load limit 228
 - Terminology 239
 - Vehicle maximum load on the tire** ... 242
 - Vehicle specification**
 - ML 350 348
 - ML 350 4MATIC 349
 - ML 350 BlueTEC 4MATIC 348
 - ML 550 4MATIC 350
 - ML 63 AMG 351
 - Vehicle status message memory** 128
 - Vehicle tool kit** 268
 - Vehicle washing**
 - see Vehicle care
 - Vehicle weights**
 - see Vehicle specification
- W**
- Warning lamps**
 - see Lamps, Indicator and warning
 - Warning sounds**
 - Distance warning function 151
 - Distronic 146
 - Driver's or passenger's seat belt 51
 - Parking brake 284
 - Parktronic system 163
 - Seat belt telltale 300
 - Warranty coverage** 346
 - Washer and headlamp cleaning system** 364
 - Washer fluid**
 - Messages in the multifunction display 288
 - Mixing ratio 364
 - Refilling 217
 - Washing the vehicle** 260
 - Wear pattern (tires)** 234
 - Weights (vehicle)**
 - see Vehicle specification
 - Wheel**
 - Changing 319
 - Removing 327
 - Spare 319
 - Tightening torque 330
 - Wheels, sizes** 352
 - Wheels, Tires and** 218
 - Window curtain air bags** 41
 - Windows**
 - see Power windows
 - Windows, cleaning** 264
 - Windshield**
 - Cleaning wiper blades 264
 - Infrared reflecting 208
 - Washer fluid 364
 - Wipers 98
 - Windshield wipers**
 - Replacing wiper blades 318
 - Winter cover** 214, 242
 - Winter driving**
 - Instructions 243
 - Radiator cover 242
 - Snow chains 243
 - Tires 242
 - Winter tires** 242, 352
 - Wood trims, cleaning** 266

Product Information

Please observe the following in your own best interest:

We recommend using Genuine Mercedes-Benz Parts as well as conversion parts and accessories explicitly approved by us for your vehicle model.

We have tested these parts to determine their reliability, safety and special suitability for Mercedes-Benz vehicles.

We are unable to make an assessment for other products and therefore cannot be held responsible for them, even if in individual cases an official approval or authorization by governmental or other agencies should exist. Use of such parts and accessories could adversely affect the safety, performance or reliability of your vehicle. Please do not use them.

Genuine Mercedes-Benz Parts and pre-approved conversion parts and accessories are available at any authorized Mercedes-Benz Center. In addition, you will receive comprehensive information on permissible technical modifications and expert installations.

Operator's Manual

Notes

This Operator's Manual contains a great deal of useful information. We urge you to read it carefully and familiarize yourself with the vehicle before driving.

For your own safety and longer service life of the vehicle, we urge you to follow the instructions and warnings contained in this Operator's Manual. Ignoring them could result in damage to the vehicle or personal injury to you or others. Vehicle damage caused by failure to follow instructions is not covered by the Mercedes-Benz Limited Warranty.

We continuously strive to improve our product and ask for your understanding that we reserve the right to make changes in design and equipment. Therefore, information, illustrations, and descriptions in this Operator's Manual might differ from your vehicle.

Vehicle equipment

Your vehicle may have some or all of the equipment described in this manual.

Therefore, you may find explanations for optional equipment not installed in your vehicle. If you have any questions about operating particular equipment, any authorized Mercedes-Benz Center will be glad to demonstrate the proper procedures.

Optional equipment is also described in this manual, including operating instructions wherever necessary. Since they are special-order items, the descriptions and illustrations herein may vary slightly from the actual equipment of your vehicle.

If there are any equipment details that are not shown or described in this Operator's Manual, any authorized Mercedes-Benz Center will be glad to inform you of correct care and operating procedures. The Operator's Manual and Maintenance Booklet are important documents and should be kept with the vehicle.

Service and warranty information

The Service and Warranty Information booklet contains detailed information about the warranties covering your Mercedes-Benz, including:

- New Vehicle Limited Warranty
- Emission System Warranty
- Emission Performance Warranty
- California, Connecticut, Maine, Massachusetts, New York, Pennsylvania,

Rhode Island, and Vermont Emission Control System Warranty¹

- State Warranty Enforcement Laws (Lemon Laws)

Important notice for California retail buyers and lessees of Mercedes-Benz automobiles

Under California law you may be entitled to a replacement of your vehicle or a refund of the purchase price or lease price, if after a reasonable number of repair attempts Mercedes-Benz USA, LLC and/or its authorized repair or service facilities fail to fix one or more substantial defects or malfunctions in the vehicle that are covered by its express warranty. During the period of 18 months from original delivery of the vehicle or the accumulation of 18 000 miles (approximately 29 000 km) on the odometer of the vehicle, whichever occurs first, a reasonable number of repair attempts is presumed for a retail buyer or lessee if one or more of the following occurs:

- (1) the same substantial defect or malfunction results in a condition that is likely to cause death or serious bodily injury if the vehicle is driven, that defect or malfunction has been subject to repair two or more times, and you have directly notified Mercedes-Benz USA, LLC in writing of the need for its repair,
- (2) the same substantial defect or malfunction of a less serious nature than category (1) has been subject to repair four or more times and you have directly notified us in writing of the need for its repair, or
- (3) the vehicle is out of service by reason of repair of the same or different substantial defects or malfunctions for a cumulative total of more than 30 calendar days.

Written notification should not be sent to a dealer, it should be addressed to Mercedes-Benz USA, LLC Customer Assistance Center One Mercedes Drive Montvale, NJ 07645-0350

Maintenance

The Maintenance Booklet describes all the necessary maintenance work which should be performed at regular intervals.

Always have the Maintenance Booklet with you when you take the vehicle to an authorized Mercedes-Benz Center for service. The service advisor will record each service in the booklet for you.

Roadside Assistance

The Mercedes-Benz Roadside Assistance Program provides factory-trained technical help in the event of a breakdown. Calls to the toll-free Roadside Assistance number

1-800-FOR-MERCedes (in the USA)
1-800-387-0 100 (in Canada)

will be answered by Mercedes-Benz Customer Assistance Representatives 24 hours a day, 365 days a year.

Roadside Assistance will be provided in accordance with standard program guidelines which include providing service to the vehicle up to a reasonable distance from a paved roadway. We will make every effort to assist in a breakdown situation, however, the accessibility of your vehicle will be determined by our authorized Mercedes-Benz Center technician or the tow service provider on a case-by-case basis and may be a factor in our ability to respond.

Additional charges may be applicable for a breakdown location determined not to be a reasonably accessible roadside location as

¹ Applicable to vehicles with gasoline engine only.

determined by our authorized technician and tow service provider.

For additional information refer to the Mercedes-Benz Roadside Assistance Program brochure (in the USA) or the Roadside Assistance section of the Service and Warranty Information Booklet (in Canada) in your vehicle literature portfolio.

Change of address or ownership

If you change your address, be sure to send in the “Change of Address Notice” found in the Service and Warranty Information Booklet, or simply call the Mercedes-Benz Customer Assistance Center (in the USA) at 1-800-FOR-MERCEdes (1-800-367-6372), or Customer Service (in Canada) at 1-800-387-0100. This will assist us in contacting you in a timely manner should the need arise.

If you sell your Mercedes, please leave all literature with the vehicle to make it available to the next operator.

If you bought this vehicle used, be sure to send in the “Notice of Purchase of Used Truck” found in the Service and Warranty Information Booklet, or call the Mercedes-Benz Customer Assistance Center (in the USA) at 1-800-FOR-MERCEdes (1-800-367-6372), or Customer Service (in Canada) at 1-800-387-0100.

Operating your vehicle outside the USA or Canada

If you plan to operate your vehicle in foreign countries, please be aware that:

- Service facilities or replacement parts may not be readily available.
- Unleaded gasoline for vehicles with catalytic converters may not be available;

the use of leaded fuels will damage the catalysts.

- Gasoline may have a considerably lower octane rating, and improper fuel can cause engine damage.

Sport Utility Vehicle

Warning!

This Sport Utility Vehicle is designed for both on-road and off-road use. It can go places and perform tasks for which conventional 2-wheel drive passenger cars are not intended. This vehicle will handle and maneuver differently from conventional passenger cars in driving conditions which may occur on streets, highways and off-road use.

This vehicle has a higher ground clearance and a higher center of gravity than many passenger cars. As with other vehicles of this type, if you make sharp turns at excessive speeds or abrupt maneuvers, the vehicle may roll over or may go out of control and crash. Utility vehicles have a significantly higher rollover rate than other types of vehicles. Failure to operate this vehicle safely may result in an accident, rollover of the vehicle, and severe or fatal injury.

Before you start to drive this vehicle, read the Operator’s Manual. Take time to become familiar with the driving characteristics of this vehicle. Be sure you are familiar with all vehicle controls. Learn how your vehicle handles on different road surfaces. Do not attempt sharp turns at excessive speeds or abrupt maneuvers or other unsafe driving actions that can cause loss of vehicle control. When driving off-road or working the vehicle hard, do not overload it. And, always wear your seat belts at all times. In a rollover crash, an unbelted person is significantly more likely to die than a person wearing a seat belt.

Operating safety

Warning!

Work improperly carried out on electronic components and associated software could cause them to cease functioning. Because the vehicle's electronic components are interconnected, any modifications made may produce an undesired effect on other systems. Electronic malfunctions could seriously impair the operating safety of your vehicle.

Contact an authorized Mercedes-Benz Center for repairs or modifications to electronic components.

Other improper work or modifications on the vehicle could also have a negative impact on the operating safety of the vehicle.

Some safety systems only function while the engine is running. You should therefore never turn off the engine while driving.

Warning!

Heavy blows against the vehicle underbody or tires/wheels may cause serious damage and impair the operating safety of your vehicle. Such blows can be caused, for example, by running over an obstacle, road debris or a pothole. If you feel a sudden significant vibration or ride disturbance, or you suspect that damage to your vehicle as occurred:

- turn on your hazard warning flashers
- slow down carefully
- drive with caution to an area which is a safe distance from the road

Inspect the vehicle underbody and tires/wheels for possible damage. If the vehicle appears unsafe, have it towed to the nearest authorized Mercedes-Benz Center or other qualified maintenance or repair facility for further inspection or repairs.

Proper use of the vehicle

Proper use of the vehicle requires that you are familiar with the following information and rules:

- the safety precautions in this manual
- the “Technical data” section in this manual
- traffic rules and regulations
- motor vehicle laws and safety standards

Warning!

Various warning labels are attached to your vehicle. These warning labels are intended to make you and others aware of various risks. Do not remove any of these warning labels unless explicitly instructed to do so by information on the label itself. Removing warning labels may cause you and others to be unaware of certain risks which may result in an accident and/or personal injury.

Warning!

HYBRID vehicles: It is imperative that you read the HYBRID Supplemental Operating Instructions included in your vehicle literature portfolio. You may otherwise not recognize potential danger.

Problems with your vehicle

If you should experience a problem with your vehicle, particularly one that you believe may affect its safe operation, we urge you to contact an authorized Mercedes-Benz Center immediately to have the problem diagnosed and corrected if required. If the matter is not handled to your satisfaction, please discuss the problem with the Mercedes-Benz Center management or, if necessary, contact us at one of the following addresses:

In the USA:

Customer Assistance Center
Mercedes-Benz USA, LLC
One Mercedes Drive
Montvale, NJ 07645-0350

In Canada:

Customer Relations Department
Mercedes-Benz Canada, Inc.
98 Vanderhoof Avenue
Toronto, Ontario M4G 4C9

Reporting safety defects

For the USA only:

The following text is published as required of manufacturers under Title 49, Code of U.S. Federal Regulations, Part 575 pursuant to the “National Traffic and Motor Vehicle Safety Act of 1966”.

Reporting safety defects

If you believe that your vehicle has a defect which could cause a crash or could cause injury or death, you should immediately inform the National Highway Traffic Safety Administration (NHTSA) in addition to notifying Mercedes-Benz USA, LLC.

If NHTSA receives similar complaints, it may open an investigation, and if it finds that a safety defect exists in a group of vehicles, it may order a recall and remedy campaign. However, NHTSA cannot become involved in individual problems between you, your dealer, or Mercedes-Benz USA, LLC.

To contact NHTSA, you may call the Vehicle Safety Hotline toll-free at 1-888-327-4236 (TTY: 1-800-424-9153); go to

www.safercar.gov; or write to:

Administrator, NHTSA Headquarters,
1200 New Jersey Avenue, SE, West Building,
Washington, DC 20590.

You can also obtain other information about motor vehicle safety from

www.safercar.gov.

Vehicle data recording**Information regarding electronic recording devices**

(Including notice pursuant to California Code § 9951)

Please note that your vehicle is equipped with devices that can record vehicle systems data and, if equipped with the Tele Aid system, may transmit some data in certain accidents.

This information helps, for example, to diagnose vehicle systems after a collision and to continuously improve vehicle safety. Daimler may access the information and share it with others

- for safety research or vehicle diagnosis purposes
- with the consent of the vehicle owner or lessee
- in response to an official request by law enforcement or other government agency
- for use in dispute resolution involving Daimler, its affiliates or sales/service organization and/or
- as otherwise required or permitted by law

Please check the Tele Aid subscription service agreement for details regarding the information that may be recorded or transmitted via that system.

Exterior view	26
Cockpit	27
Instrument cluster	28
Multifunction steering wheel	30
Center console	31
Overhead control panel	32
Door control panel	33



Exterior view

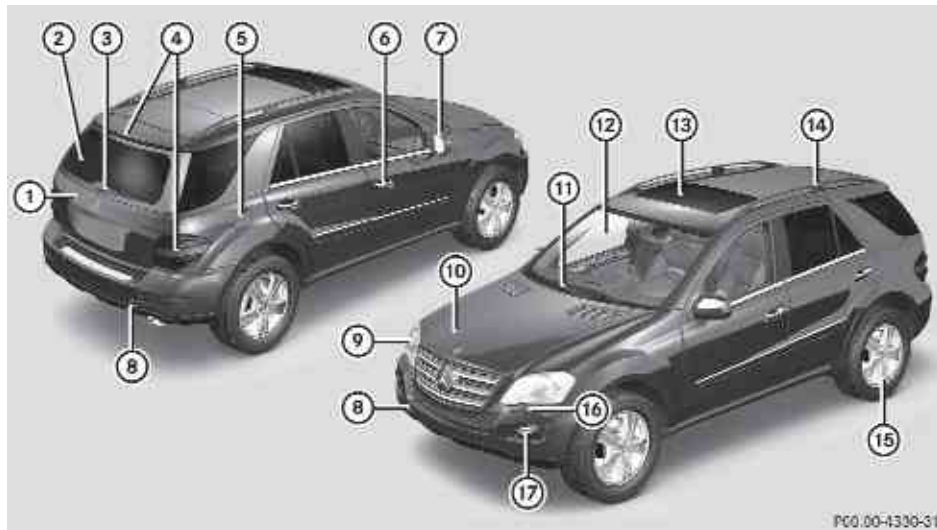

PC0-00-4330-31

i This Operator's Manual describes all features, standard or optional, potentially available for your vehicle at the time of purchase. Please be aware that your vehicle might not be equipped with all features described in this manual.

	Function	Page
①	Tailgate	75
	Power tailgate	76
②	Rear window defroster	183
③	Rear window wiper/washer	100
	Wiper blade, replacing	318
	Wiper blade, cleaning	264
④	Rear lamps	311
⑤	Fuel filler flap	210
⑥	Doors:	
	Locking and unlocking	70, 306
⑦	Exterior rear view mirrors	89
⑧	Towing eyes	339
⑨	Front lamps	311

	Function	Page
⑩	Hood	212
⑪	Wipers	98
	Wiper blades, replacing	318
	Wiper blades, cleaning	264
⑫	Windshield:	
	Wiping with washer fluid Cleaning	99 264
⑬	Power tilt/sliding sunroof	184
⑭	Carriers	187
⑮	Tires and wheels	218
	Rims and tires	352
⑯	Headlamp cleaning system	96
⑰	Front fog lamp	95

Cockpit

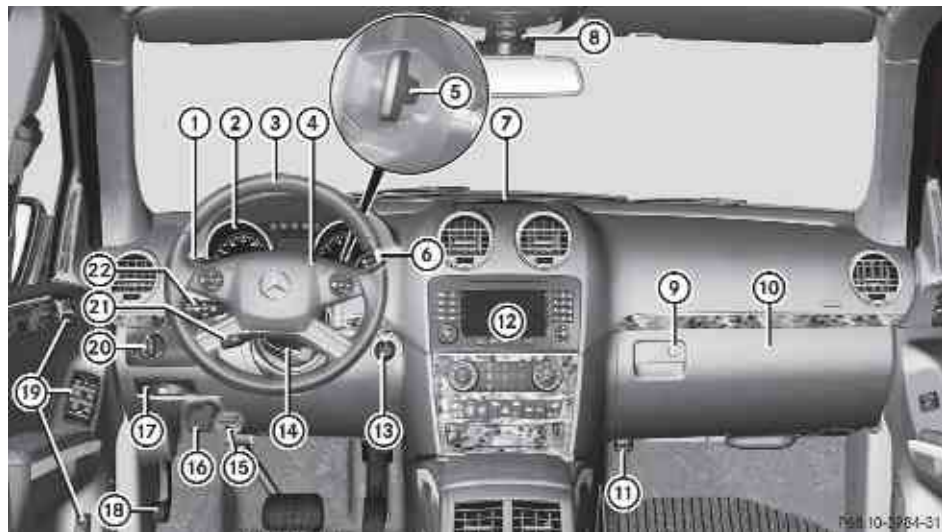







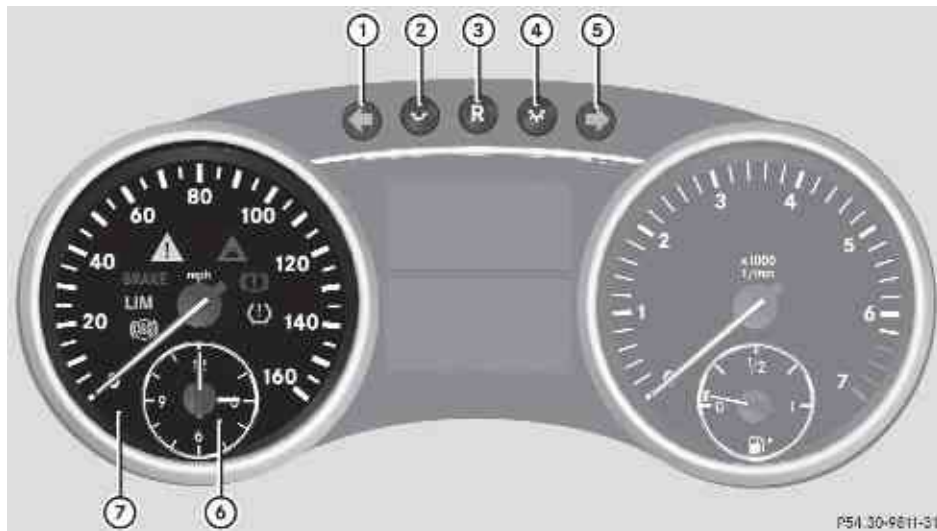

PSM 10-1284-31

Function	Page	Function	Page
① Cruise control lever: Cruise control Distronic	141 144	⑬ Starter switch	79
② Instrument cluster	28, 117	⑭ Steering wheel adjustment, manual	86
③ Multifunction steering wheel	30, 119	⑮ On-board diagnostics (OBD) socket	
④ Horn		⑯ Hood lock release	212
⑤ Steering wheel gearshift control	115	⑰ Parking brake release	107
⑥ Gear selector lever	109	⑱ Parking brake pedal	107
⑦ Front Parktronic warning indicators	161	⑲ Door control panel	33
⑧ Overhead control panel	32	⑳ Exterior lamp switch	93
⑨ Glove box lid release, glove box lock	193	㉑ Steering wheel adjustment, electrical Heated steering wheel	86 88
⑩ Glove box	192	㉒ Combination switch: Turn signals Wipers High beam	95 98 96
⑪ Power outlet	197		
⑫ Center console	31		

Instrument cluster



	Function	Page
①	 Left turn signal indicator lamp	
②	To dim instrument cluster illumination	118
③	Reset button for: Trip odometer	118
	Settings	129
④	To brighten instrument cluster illumination	118
⑤	 Right turn signal indicator lamp	
⑥	Clock	132
⑦	Speedometer with:  Antilock Brake System (ABS) indicator lamp	298
	 Variable speed limiter indicator lamp ²	









	Function	Page
	 Brake warning lamp, USA only	299
	 ESP [®] warning lamp	301
	 Distance warning lamp ³	302
	 Brake warning lamp, Canada only	299
	 Combination low tire pressure/TPMS malfunction telltale, USA only	223, 304

² Lamp without function. It illuminates when the ignition is on. It should go out when the engine is running.

³ Vehicles without Distronic: Warning lamp without function. It illuminates when the ignition is on. It should go out when the engine is running.









P54-00-9947-31





Function	Page	Function	Page
⑧ Multifunction display with: Trip odometer Main odometer	118 121	Fuel gauge with: Fuel tank reserve warning lamp  Fuel filler flap indicator: The fuel filler flap is located on the rear right-hand side.	303
⑨ Tachometer with:  Seat belt telltale  Preglow indicator lamp, diesel engine only or  Recuperative Brake System (RBS) warning lamp, ML 450 HYBRID only ⁴  Supplemental Restraint System (SRS) indicator lamp  Low-beam headlamp indicator lamp  Engine malfunction indicator lamp, Canada only  Engine malfunction indicator lamp, USA only  High-beam headlamp indicator lamp	51, 300 104 36, 301 93 303 303 96	⑩ Multifunction display with: Outside temperature indicator or digital speedometer (depending on selected setting in the control system) Transmission position indicator Gear range indicator Automatic transmission program mode indicator Rear window wiper indicator Downhill Speed Regulator (DSR) indicator Off-road driving program indicator	123, 131 112 114 114 100 153 155

⁴ See separate HYBRID Supplemental Operating Instructions.

Multifunction steering wheel



	Function	Page
①	Multifunction display	121
②	Press button  : to end a call to reject an incoming call Press button  : to answer a call to dial ⁵ to redial ⁵ Press button  or  : to select submenus in the Settings menu to set values to set the volume Press button  to turn the Voice Control System on ⁶ , see separate operating instructions.	139 139 139 139 139 139 130
③	Press button  or  to select next/previous menu.	119

Function	Page
Press button  or  briefly: to move within a menu to select previous or next track, scene or stored station within Audio/DVD menu	126
to switch to the phone book and select a name or number within Telephone menu	139
Press and hold button  or  : to select previous or next track with quick search or to select previous or next station in station list or wave band within Audio/DVD menu to start the quick search in the phone book within Telephone menu	126 139
Press button  to turn the Voice Control System off ⁶ , see separate operating instructions.	

⁵ Function only available in telephone menu.

⁶ Vehicles without Voice Control System: Button without function.

Center console

Upper part



Function	Page
① COMAND system, see separate operating instructions	
② Climate control system	165
Rear window defroster	183
③ Seat heating, front passenger side	86
④ Seat ventilation, front passenger side	85
⑤ Parktronic system deactivation switch	162
ML 450 HYBRID: Fuel filler flap switch ⁷	
⑥ Vehicle level control switch	156
⑦ Front passenger front air bag off indicator lamp (USA only)	42, 305

Function	Page
Front passenger front air bag off indicator lamp (Canada only)	46, 305
⑧ Storage compartment	192
⑨ Alarm system indicator lamp	67
⑩ Electronic Stability Program (ESP [®]) switch	64
⑪ Adaptive Damping System (ADS) switch	156
⑫ Seat ventilation, driver's side	85
⑬ Seat heating, driver's side	86
⑭ Switch for Downhill Speed Regulation (DSR)	152
ML 450 HYBRID: Parktronic system deactivation switch	160
⑮ Hazard warning flasher switch	96
⑯ Switch for off-road driving program	155
ML 63 AMG: Program mode selector switch for automatic transmission	115
ML 450 HYBRID: Program mode selector switch for automatic transmission ⁷	

⁷ See separate HYBRID Supplemental Operating Instructions.

Lower part

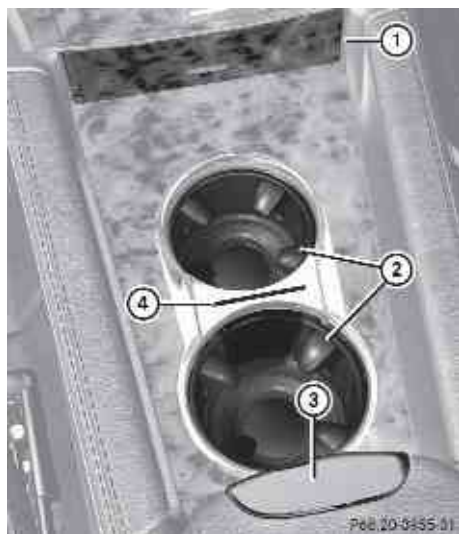

P68 20-5435-01

	Function	Page
①	Ashtray with storage compartment Cigarette lighter	196 196
②	Cup holder	194
③	Front armrest storage compartment	192
④	Removable card/ticket holder	194

Overhead control panel



P68 00-5433-31

	Function	Page
①	Left front reading lamp on/off	97
②	Automatic interior lighting	97
③	Rear interior lighting on/off	97
④	Front interior lighting on/off	97
⑤	Right reading lamp on/off	97
⑥	Front right interior lamp	97
⑦	Power tilt/sliding sunroof switch	184
⑧	SOS button (Tele Aid system)	201
⑨	Interior rear view mirror	89
⑩	Reading lamps	97
⑪	Garage door opener	204

	Function	Page
⑫	Hands-free microphone for Tele Aid (emergency call system), telephone and Voice Control System, see separate operating instructions	
⑬	Front left interior lamp	97

Door control panel



	Function	Page
①	Inside door handle	74
②	Central locking/unlocking switch	75
③	Exterior rear view mirror adjustment	89
④	Selection buttons for exterior rear view mirror adjustment	89
	Power-folding exterior rear view mirrors	91
⑤	Switches for opening/closing front and rear door windows	100
⑥	Rear door window override switch	60
⑦	Remote tailgate switch, power tailgate	78

Vehicle equipment	36
Occupant safety	36
Panic alarm	61
Driving safety systems	61
Anti-theft systems	66



Vehicle equipment

- i** This Operator's Manual describes all features, standard or optional, potentially available for your vehicle at the time of purchase. Please be aware that your vehicle might not be equipped with all features described in this manual.

Occupant safety

Introduction

In this section you will learn the most important facts about the restraint system components of the vehicle.

The restraint systems are:

- Seat belts
- Child restraints
- Lower Anchors and Iethers for Children (LATCH)

Additional protection potential is provided by:

- Supplemental Restraint System (SRS) with
 - Air bags
 - Air bag control unit (with crash sensors)
 - Emergency Tensioning Device (ETD) for seat belts
 - Seat belt force limiter
- NECK-PRO active front head restraints
- Preventive occupant safety (PRE-SAFE®)
- Air bag system components with
 - Front passenger front air bag off indicator lamp
 - USA only: Front passenger seat with Occupant Classification System (OCS)
 - Canada only: Front passenger seat with BabySmart™ air bag deactivation system

Although the systems are independent, their protective functions work in conjunction with each other.

Warning!

Modifications to or work improperly conducted on restraint system components or their wiring, as well as tampering with interconnected electronic systems, can lead to the restraint systems no longer functioning as intended.

Air bags or Emergency Tensioning Devices (ETDs), for example, could deploy inadvertently or fail to deploy in accidents although the deceleration threshold for air bag deployment is exceeded. Therefore, never modify the restraint systems. Do not tamper with electronic components or their software.

- i** See “Children in the vehicle” (▷ page 55) for information on
 - infants and children traveling with you in the vehicle
 - restraint systems for infants and children

SRS indicator lamp

The SRS system conducts a self-test when the ignition is switched on and in regular intervals while the engine is running. This facilitates detection of system malfunctions. The SRS indicator lamp **SRS** in the instrument cluster comes on when the ignition is switched on. It goes out no later than a few seconds after the engine has been started.

The SRS components are in operational readiness when the SRS indicator lamp **SRS** is not lit while the engine is running.

A malfunction in the system has been detected if the SRS indicator lamp **SRS**

- fails to go out after approximately 4 seconds after the engine was started
- does not come on at all
- comes on after the engine was started or while driving

⚠ Warning!

The SRS self-check has detected a malfunction when the SRS indicator lamp

SRS:

- does not come on at all
- does not go out after 4 seconds after the engine was started
- comes on while driving

For your safety, we strongly recommend that you contact an authorized Mercedes-Benz Center immediately to have the system checked. Otherwise the SRS may not be activated when needed in an accident, which could result in serious or fatal injury. The SRS might also deploy unexpectedly and unnecessarily which could also result in injury as well.

In addition, improper work on the SRS creates a risk of rendering the SRS inoperative or causing unintended air bag deployment. Work on the SRS must therefore only be performed by qualified technicians. Contact an authorized Mercedes-Benz Center.

If it is necessary to modify an air bag system to accommodate a person with disabilities, contact an authorized Mercedes-Benz Center. USA only: Call our Customer Assistance Center at 1-800-FOR-MERCEdes (1-800-367-6372) for details.

Air bags**⚠ Warning!**

Air bags are designed to reduce the potential of injury and fatality in certain

- frontal impacts (front air bags)
- side impacts (side impact air bags and window curtain air bags)
- rollovers (window curtain air bags)

However, no system available today can completely eliminate injuries and fatalities.

Deployment of the air bags temporarily releases a small amount of dust from the air bags. This dust, however, is neither harmful to your health, nor does it indicate a fire in the vehicle. The dust might cause some temporary breathing difficulty for people with asthma or other breathing trouble. To avoid this, you may wish to get out of the vehicle as soon as it is safe to do so. If you have any breathing difficulty but cannot get out of the vehicle after the air bag inflates, then get fresh air by opening a window or door.

⚠ Warning!

To reduce the risk of injury when the front air bags inflate, it is very important for the driver and front passenger to always be in a properly seated position and to wear their respective seat belt.

For maximum protection in the event of a collision always be in normal seated position with your back against the seat backrest. Fasten your seat belt and make sure it is properly positioned on your body.

Since the air bag inflates with considerable speed and force, a proper seating position and correct positioning of the hands on the steering wheel will help to keep you at a safe distance from the air bag. Occupants who are not wearing their seat belt, are not seated properly or are too close to the air bag can be seriously injured or killed by an air bag as it inflates with great force instantaneously:

- Sit with the seat belt properly fastened in a position that is as upright as possible with your back against the seat backrest.
- Move the driver's seat as far back as possible, still permitting proper operation of vehicle controls. The distance from the center of the driver's chest to the center of the air bag cover on the steering wheel must be at least 10 inches (25 cm) or more. You should be able to accomplish this by adjusting the seat and steering wheel. If

you have any difficulties, please contact an authorized Mercedes-Benz Center.

- Do not lean your head or chest close to the steering wheel or dashboard.
- Keep hands on the outside of the steering wheel rim. Placing hands and arms inside the rim can increase the risk and potential severity of hand/arm injury when the driver front air bag inflates.
- Adjust the front passenger seat as far as possible rearward from the dashboard when the seat is occupied.
- Occupants, especially children, should never place their bodies or lean their heads in the area of the door where the side impact air bag inflates. This could result in serious injuries or death should the side impact air bag be deployed. Always sit as upright as possible, wear the seat belt properly and use an appropriately sized infant restraint, toddler restraint, or booster seat recommended for the size and weight of the child.
- Canada only: Children 12 years old and under must never ride in the front seat, except in a Mercedes-Benz authorized BabySmart™ compatible child seat, which operates with the BabySmart™ air bag deactivation system installed in the vehicle to deactivate the front passenger front air bag when it is installed properly. Otherwise they will be struck by the air bag when it inflates in a crash. If this happens, serious or fatal injury will result.

Failure to follow these instructions can result in severe injuries to you or other occupants.

If you sell your vehicle, it is important that you make the buyer aware of this safety information. Be sure to give the buyer this Operator's Manual.

Warning!

Accident research shows that the safest place for children in an automobile is in a rear seat.

There is a possibility for a side impact air bag-related injury if occupants, especially children, are not properly seated or restrained when next to a side impact air bag which needs to deploy rapidly in a side impact in order to do its job.

To help avoid the possibility of injury, please follow these guidelines:

- (1) Always sit as upright as possible, wear the seat belt properly, and for children 12 years old and under, use an appropriately sized infant restraint, toddler restraint, or booster seat recommended for the size and weight of the child.
- (2) Always wear seat belts properly.

Air bags are designed to deploy only in certain

- frontal impacts (front air bags)
- side impacts (side impact and window curtain air bags) if the system determines the need for air bag deployment
- rollovers (window curtain air bags)

Only in the event of such a situation will they provide their supplemental protection.

The driver and passengers should always wear their seat belts. Otherwise it is not possible for the air bags to provide their supplemental protection.

In case of other types of impacts and impacts below air bag deployment thresholds, air bags will not deploy. The driver and passengers will then be protected to the extent possible by a properly fastened seat belt. A properly fastened seat belt is also needed to provide the best possible protection in a rollover.

Air bags are not a substitute for seat belts. Always wear your seat belt, regardless of whether or not your vehicle is equipped with air bags.

It is important to your safety and that of your passengers to have deployed air bags replaced and to have any malfunctioning air

bags repaired. This will help to make sure the air bags will continue to provide supplemental crash protection for occupants.

Safety guidelines for the seat belt, Emergency Tensioning Device (ETD) and air bag

Warning!

- Damaged seat belts or seat belts that have been subjected to stress in an accident must be replaced. Their anchoring points must also be checked. Only use seat belts installed or supplied by an authorized Mercedes-Benz Center.
- Air bags and pyrotechnic Emergency Tensioning Devices (ETDs) contain perchlorate material, which may require special handling and regard for the environment. Check with your local government's disposal guidelines. California residents, see www.dtsc.ca.gov/HazardousWaste/Perchlorate/index.cfm.
- Air bags and ETDs are designed to function on a one-time-only basis. An air bag or ETD that has deployed must be replaced. PRE-SAFE® has electrically operated reversible pre-tensioners in addition to the pyrotechnic ETDs.
- Do not pass seat belts over sharp edges. They could tear.
- Do not make any modification that could change the effectiveness of the seat belts.
- Do not bleach or dye seat belts as this may severely weaken them. In a crash they may not be able to provide adequate protection.
- No modifications of any kind may be made to any components or wiring of the SRS.
- Do no change or remove any component or part of the SRS.
- Do not install additional trim material, seat covers, badges, etc. over the steering wheel hub, front passenger front air bag cover, outboard sides of the seat backrests, door trim panels, or door frame trims.
- Do not install additional electrical/ electronic equipment on or near SRS components and wiring.
- Keep area between air bags and occupants free of objects (e.g. packages, purses, umbrellas, etc.).
- Do not hang items such as coat hangers from the coat hooks or handles over the door. These items may be thrown around in the vehicle and cause head and other injuries when the window curtain air bag is deployed.
- Air bag system components will be hot after an air bag has inflated. Do not touch them.
- Never place your feet on the instrument panel, dashboard, or on the seat. Always keep both feet on the floor in front of the seat.
- Improper repair work on the SRS creates a risk of rendering the SRS inoperative or causing unintended air bag deployment. Work on the SRS must therefore only be performed by qualified technicians. Contact an authorized Mercedes-Benz Center.
- For your protection and the protection of others, when scrapping the air bag unit or ETD, our safety instructions must be followed. These instructions are available from any authorized Mercedes-Benz Center.
- Given the considerable deployment speed, required inflation volume, and the material of the air bags, there is the possibility of abrasions or other, potentially more serious injuries resulting from air bag deployment.

If you sell your vehicle, we strongly recommend that you inform the subsequent owner that the vehicle is equipped with SRS. Also refer them to the applicable section in the Operator's Manual.

Front air bags

 **Observe Safety notes, see page 37.**

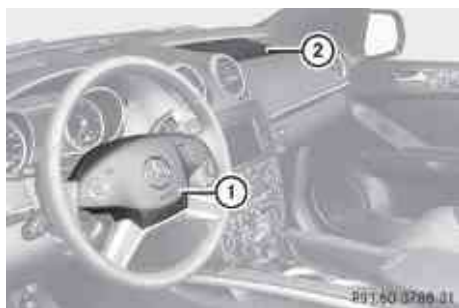

Driver's front air bag ① and front passenger front air bag ② are designed to provide increased protection for the driver and front passenger against the risk of injuries to the head and thorax.

Driver and front passenger front air bags are deployed

- in the event of certain frontal impacts
- if the system determines that air bag deployment can offer additional protection to that provided by the seat belt
- depending on whether the respective seat belt is in use
- independently of the side impact air bags and/or the window curtain air bags

The front air bags in this vehicle have been designed to inflate in two stages. This allows the air bags to have different rates of inflation. The rate of inflation is based on the vehicle deceleration rate as assessed by the air bag control unit.

Vehicles with OCS, USA only: The front passenger front air bag deployment is additionally influenced by the passenger's weight category as identified by the Occupant Classification System (OCS) (> page 42).

Vehicles with OCS, USA only: The lighter the front passenger-side occupant, the higher the vehicle deceleration rate required for second stage inflation of the front passenger front air bag.

The air bags will not deploy in impacts which do not exceed the system's preset deployment thresholds. You will then be protected by the fastened seat belts.

The front air bags will not deploy in the event of a rollover unless the vehicle's rate of longitudinal deceleration or acceleration exceeds the preset deployment threshold for the front air bags.

The front passenger front air bag will only be deployed if

- vehicles with OCS, USA only: the system, based on OCS weight sensor readings, detects that the front passenger seat is occupied
- the  **PASS AIR BAG OFF** indicator lamp in the center console is not lit (USA only: (> page 42), Canada only: (> page 46))
- the impact exceeds a preset deployment threshold

 Vehicles with BabySmart™ air bag deactivation system (Canada only): Do not place objects heavier than 20 lb (9 kg) on the front passenger seat. This could cause the front or side impact air bag on the front passenger side to deploy in a crash which exceeds the system's deployment threshold.

Side impact air bags

 **Observe Safety notes, see page 37.**

Warning!

The pressure sensors for side impact air bag control are located in the doors. Do not modify any components of the doors or door trim panels including, for example, the addition of door speakers.

Improper repair work on the doors or the modification or addition of components to the doors create a risk of rendering the side impact air bags inoperative or causing unintended air bag deployment. Work on the

doors must therefore only be performed by qualified technicians. Contact an authorized Mercedes-Benz Center.



Front side impact air bags ① and rear side impact air bags ② are designed to provide increased protection for the thorax but not the head, neck and arms.

The side impact air bags are deployed

- on the impacted side of the vehicle
- in instances with a high rate of lateral vehicle deceleration or acceleration
- regardless of whether the seat belts on the impacted side of the vehicle are in use
- independently of the front air bags
- independently of the ETDs

Vehicles with OCS (USA only): The front passenger side impact air bag will not deploy if the OCS senses that the front passenger seat is empty and the front passenger seat belt is not fastened. With the front passenger seat empty and the seat belt fastened, the front passenger side impact air bag will deploy independently of the empty seat. Whether a seat belt is recognized as fastened depends on whether or not the latch plate is properly inserted into the buckle.

The side impact air bags are not deployed in side impacts which do not exceed the system's deployment threshold.

The side impact air bags will not deploy in the event of a rollover unless the vehicle's rate of lateral deceleration or acceleration exceeds

the preset deployment threshold for the side impact air bags.

! Vehicles with BabySmart™ air bag deactivation system (Canada only): Do not place objects heavier than 20 lb (9 kg) on the front passenger seat. This could cause the front or side impact air bag on the front passenger side to deploy in a crash which exceeds the system's deployment threshold.

⚠ Warning!

Only use seat covers which have been tested and approved by Mercedes-Benz for your vehicle model. Using other seat covers may interfere with or prevent the deployment of the side impact air bags. Contact an authorized Mercedes-Benz Center for availability.

Window curtain air bags

⚠ Observe Safety notes, see page 37.



Window curtain air bags ① are designed to provide increased protection for the head but not the chest or arms.

Window curtain air bags ① are deployed

- on the impacted side of the vehicle
- in instances with a high rate of lateral vehicle deceleration or acceleration
- independently of the front air bags

- regardless of whether the front passenger seat is occupied
- in certain vehicle rollovers, if the system determines that air bag deployment can offer additional protection to that provided by the seat belt

Window curtain air bags ① are not deployed in impacts which do not exceed the system's deployment threshold.

Window curtain air bags ① deploy in the area indicated by the arrows.

Occupant Classification System

The Occupant Classification System (OCS) is standard equipment in USA.

The OCS activates or deactivates the front passenger front air bag automatically. The respective status is based on the classified occupant weight category determined by weight sensor readings from the front passenger seat.

The system does not deactivate

- the front passenger side impact air bag
- the window curtain air bag
- the Emergency Tensioning Devices (ETDs)

To be classified correctly, the front passenger must sit

- with the seat belt properly fastened
- in a position that is as upright as possible with the back against the seat backrest
- with the feet on the floor

If the occupant's weight is transferred to another object in the vehicle (e.g. by leaning on armrests), the OCS may not be able to properly approximate the occupant's weight category.

Furthermore, the occupant weight may appear to increase or decrease due to the following:

- objects hanging on the seat
- objects lodged underneath the seat
- objects stuffed between the seat and middle console
- objects stuffed between the seat and door
- other passengers pushing on the seat
- objects applying pressure to the back of the seat



Always make sure the seat has clearance in all directions at all times.

If your seat, including the trim cover and cushion, needs to be serviced in any way, take the vehicle to an authorized Mercedes-Benz Center.

Only seat accessories approved by Mercedes-Benz may be used.

Both the driver and the front passenger should always use the  **PASS AIR BAG OFF** indicator lamp as an indication of whether or not the front passenger is properly positioned.

Warning!

If the  **PASS AIR BAG OFF** indicator lamp illuminates when an adult or someone larger than a small individual is in the front passenger seat, have the front passenger reposition himself or herself in the seat until the  **PASS AIR BAG OFF** indicator lamp goes out, or check whether objects are caught under or around the seat.



In the event of a collision, the air bag control unit will not allow front passenger front air bag deployment when the OCS has classified the front passenger seat occupant as weighting as much as or less than a typical 12-month-old child in a standard child restraint or if the front passenger seat is classified as being empty.

When the OCS senses that the front passenger seat occupant is classified as being up to or less than the weight of a typical 12-month-old child in a standard child restraint, the  **PASS AIR BAG OFF** indicator lamp will illuminate when the engine is started and remain illuminated, indicating that the front passenger front air bag is deactivated.

When the OCS senses that the front passenger seat is classified as being empty, the  **PASS AIR BAG OFF** indicator lamp will illuminate when the engine is started and remain illuminated, indicating that the front passenger front air bag is deactivated.

When the OCS senses that the front passenger seat occupant is classified as being heavier than the weight of a typical 12-month-old child seated in a standard child restraint or as being a small individual (such as a young teenager or a small adult), the

 **PASS AIR BAG OFF** indicator lamp will illuminate for approximately 6 seconds when the engine is started and then, depending on occupant weight sensor readings from the seat, remain illuminated or go out. With the

 **PASS AIR BAG OFF** indicator lamp illuminated, the front passenger front air bag is deactivated. With the  **PASS AIR BAG OFF** indicator lamp out, the front passenger front air bag is activated.

When the OCS senses that the front passenger seat occupant is classified as an adult or someone larger than a small individual, the  **PASS AIR BAG OFF** indicator lamp will illuminate for approximately 6 seconds when the engine is started and then goes out, indicating that the front passenger front air bag is activated.

If the  **PASS AIR BAG OFF** indicator lamp is illuminated, the front passenger front air bag is deactivated and will not be deployed.

If the  **PASS AIR BAG OFF** indicator lamp is not illuminated, the front passenger front air bag is activated and will be deployed

- in the event of certain frontal impacts
- if impact exceeds a preset deployment threshold
- independently of the side impact air bags

If the front passenger front air bag is deployed, the rate of inflation will be influenced by

- the rate of relevant vehicle deceleration as assessed by the air bag control unit
- the front passenger's weight category as identified by the OCS

For more information on air bag display messages in the multifunction display, see (> page 275).





Warning!

According to accident statistics, children are safer when properly restrained in the rear seating positions than in the front seating position. Thus, we strongly recommend that children be placed in the rear seats whenever possible. Regardless of seating position, children 12 years old and under must be seated and properly secured in an appropriate infant restraint, toddler restraint, or booster seat recommended for the size and weight of the child.

The infant or child restraint must be properly secured with the vehicle's seat belt, the seat belt and top tether strap, or lower anchors and top tether strap, fully in accordance with the child seat manufacturer's instructions.

Occupants, especially children, should always sit as upright as possible, wear the seat belt properly and use an appropriately sized infant restraint, toddler restraint, or booster seat recommended for the size and weight of the child.

Children can be killed or seriously injured by an inflating air bag. Note the following important information when circumstances require you to place a child in the front passenger seat:

- Your vehicle is equipped with air bag technology designed to deactivate the front passenger front air bag in your vehicle when the system senses the weight of a typical 12-month-old child or less along with the weight of a standard appropriate child restraint on the front passenger seat.
- A child in a rear-facing child restraint on the front passenger seat will be seriously injured or even killed if the front passenger front air bag inflates in a collision which could occur under some circumstances, even with the air bag technology installed in your vehicle. The only means to completely eliminate this risk is to never place a child in a rear-facing child restraint in the front seat. We therefore strongly recommend that you always place a child in a rear-facing child restraint in a backseat.
- If you must install a rear-facing child restraint on the front passenger seat because circumstances require you to do so, make sure the  **PASS AIR BAG OFF** indicator lamp is illuminated, indicating that the front passenger front air bag is deactivated. Should the  **PASS AIR BAG OFF** indicator lamp not illuminate or go out while the restraint is installed, please check installation. Periodically check the  **PASS AIR BAG OFF** indicator lamp while driving to make sure the  **PASS AIR BAG OFF** indicator lamp is illuminated. If the  **PASS AIR BAG OFF** indicator lamp goes out or remains out, do not transport a child on the front passenger seat until the system has been repaired.

A child in a rear-facing child restraint on the front passenger seat will be seriously

injured or even killed if the front passenger front air bag inflates.

- If you have to place a child in a forward-facing child restraint on the front passenger seat, move the seat as far back as possible, use the proper child restraint recommended for the age, size and weight of the child, and secure child restraint with the vehicle's seat belt according to the child seat manufacturer's instructions. For children larger than the typical 12-month-old child, the front passenger front air bag may or may not be activated.

Deployment of the driver front air bag does not mean that the front passenger front air bag also should have deployed.



The OCS may have determined

- that the seat was empty or occupied by the weight up to or less than that of a typical 12-month-old child seated in a standard child restraint – both of which are instances where the system suppresses deployment of the front passenger front air bag even though the impact met the criteria and was of sufficient severity to deploy the driver front air bag
- that the seat was occupied by a small individual (such as a young teenager or a small adult) or a child who weighs more than the weight of a typical 12-month-old child in a standard child restraint – both of which are instances where the system may suppress deployment of the front passenger front air bag even though the impact met the criteria and was of sufficient severity to deploy the driver front air bag



 **PASS AIR BAG OFF** indicator lamp ① will be illuminated, except with the SmartKey removed from the starter switch or with the starter switch in position **0**.

Warning!

If the red SRS indicator lamp  in the instrument cluster and the  **PASS AIR BAG OFF** indicator lamp are lit at the same time, there is a malfunction in the OCS. The front passenger front air bag will be deactivated in this case. Have the system checked by qualified technicians as soon as possible. Contact an authorized Mercedes-Benz Center.



Only have the seat repaired or replaced at an authorized Mercedes-Benz Center.

In order to ensure proper operation of the air bag system and OCS:

- Do not place more than 4.4 lb (2 kg) into the parcel net on the back of the front passenger seat. Otherwise, the OCS may not be able to properly approximate the occupant weight category.
- Do not place objects under and/or around the front passenger seat.
- Do not hang anything from or attach any items to the seats.
- Do not stuff objects such as books between the front passenger seat and the center console or front passenger door.
- Do not move the front passenger seat backwards against stiff objects.

- Sit with the seat belt properly fastened in a position that is as upright as possible with your back against the seat backrest.
- While seated, an occupant should not position him/herself in such a way as to cause the occupant's weight to be lifted from the seat bottom as this may result in the OCS being unable to correctly approximate the occupant's weight category.
- Read and observe all warnings in this chapter.

OCS Self-test

After turning the SmartKey in the starter switch to position **1** or **2** or pressing the KEYLESS-GO start/stop button once or twice, the  **PASS AIR BAG OFF** indicator lamp illuminates. If an adult occupant is properly sitting on the front passenger seat and the system classifies the occupant as an adult, the  **PASS AIR BAG OFF** indicator lamp will illuminate and go out after approximately 6 seconds.

If the seat is not occupied and the system classifies the front passenger seat as being empty, the  **PASS AIR BAG OFF** indicator lamp will illuminate and not go out.

Warning!

If the  **PASS AIR BAG OFF** indicator lamp does not illuminate, the system is not functioning. You must contact an authorized Mercedes-Benz Center before seating any child on the front passenger seat.

For more information, see the “Practical hints” section (▷ page 305).

Warning!

Never place anything between seat cushion and child seat (e.g. pillow), since it reduces the effectiveness of the OCS. The bottom and back of the child seat must make full contact with the passenger seat cushion and backrest.

If necessary, adjust the tilt of the passenger seat backrest.

An incorrectly mounted child seat could cause injuries to the child in case of an accident, instead of increasing protection for the child.

Follow the manufacturer's instructions for installation of child seats.

BabySmart™ air bag deactivation system

The BabySmart™ air bag deactivation system is standard equipment in Canada.

Warning!

According to accident statistics, children are safer when properly restrained in the rear seating positions than in the front seating position. Thus, we strongly recommend that children be placed in the rear seats whenever possible. Regardless of seating position, children 12 years old and under must be seated and properly secured in an appropriate infant restraint, toddler restraint, or booster seat recommended for the size and weight of the child.

The infant or child restraint must be properly secured with the vehicle's seat belt, the seat belt and top tether strap, or lower anchors and top tether strap, fully in accordance with the child seat manufacturer's instructions.

Occupants, especially children, should always sit as upright as possible, wear the seat belt properly and use an appropriately sized infant restraint, toddler restraint, or booster seat recommended for the size and weight of the child.

Children can be killed or seriously injured by an inflating air bag. Note the following important information when circumstances require you to place a child in the front passenger seat:

- Children 12 years old and under must never ride in the front seat, except in a Mercedes-Benz authorized BabySmart™ compatible

child seat, which operates with the BabySmart™ system installed in the vehicle to deactivate the front passenger front air bag when it is installed properly. Otherwise they will be struck by the air bag when it inflates in a crash. If this happens, serious or fatal injury will result.

- A child in a rear-facing child restraint on the front passenger seat will be seriously injured or even killed if the front passenger front air bag inflates in a collision which could occur under some circumstances, even with the air bag technology installed in your vehicle. The only means to completely eliminate this risk is to never place a child in a rear-facing child restraint in the front seat. We therefore strongly recommend that you always place a child in a rear-facing child restraint in a backseat.

- If you must install a BabySmart™ compatible rear-facing child restraint on the front passenger seat because circumstances require you to do so, make sure the  PASS AIR BAG OFF indicator lamp is illuminated, indicating that the front passenger front air bag is deactivated.

Should the  PASS AIR BAG OFF indicator lamp not illuminate or go out while the restraint is installed, please check installation.

Periodically check the  PASS AIR BAG OFF

indicator lamp while driving to make sure

the  PASS AIR BAG OFF indicator lamp is

illuminated. If the  PASS AIR BAG OFF indicator lamp goes out or remains out, do not transport a child on the front passenger seat until the system has been repaired.



A child in a rear-facing child restraint on the front passenger seat will be seriously injured or even killed if the front passenger front air bag inflates.

- If you have to place a child in a forward-facing child restraint on the front passenger seat, move the seat as far back as possible, use the proper child restraint recommended for the age, size and weight

of the child, and secure child restraint with the vehicle's seat belt according to the child seat manufacturer's instructions.

Warning!

When using a BabySmart™ compatible child seat on the front passenger seat, the front passenger front air bag will not deploy only if the  **PASS AIR BAG OFF** indicator lamp remains illuminated.

Please be sure to check the  **PASS AIR BAG OFF** indicator lamp every time you use a BabySmart™ compatible child seat on the front passenger seat. Should the  **PASS AIR BAG OFF** indicator lamp go out while the restraint is installed, please check installation. If the  **PASS AIR BAG OFF** indicator lamp remains out, do not use the BabySmart™ restraint to transport a child on the front passenger seat until the system has been repaired.

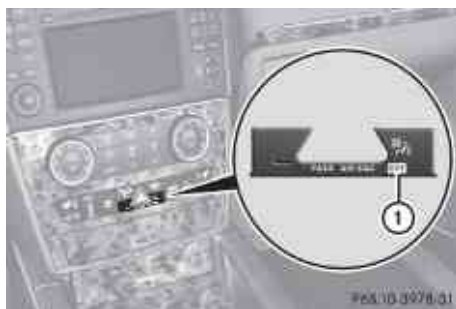



Special BabySmart™ compatible child seats, designed for use with the Mercedes-Benz system, are required for use with the BabySmart™ air bag deactivation system. Please contact an authorized Mercedes-Benz Center for information on availability. With the special child seat installed properly, the front passenger front air bag will not deploy. The  **PASS AIR BAG OFF** indicator lamp ① will be illuminated, except with the SmartKey removed from the starter switch or with the starter switch in position **0**.

The system does not deactivate



- the side impact air bag
- the window curtain air bag
- the Emergency Tensioning Device (ETD)

Self-test BabySmart™ without special child seat installed

After turning the SmartKey in the starter switch to position **1** or **2** or pressing the KEYLESS-GO start/stop button once or twice, the  **PASS AIR BAG OFF** indicator lamp comes on for approximately 6 seconds and then goes out.

If the  **PASS AIR BAG OFF** indicator lamp should not come on or is continuously lit, the system is not functioning. You must see an authorized Mercedes-Benz Center before seating any child on the front passenger seat. More information can be found in the "Practical hints" section (▷ page 305).

Warning!

Do not place powered-on laptops, mobile phones, electronic tags such as those used in ski passes and like electronic devices on the front passenger seat. Signals from such devices may interfere with the BabySmart™ air bag deactivation system. Such signal interference may cause the  **PASS AIR BAG OFF** indicator lamp not to come on during self-test. The SRS indicator lamp **SRS** and/or the  **PASS AIR BAG OFF** indicator lamp could be continuously lit, indicating that the system is not functioning. The front passenger front air bag could deploy inadvertently or fail to deploy in an accident.

Warning!

The BabySmart™ air bag deactivation system will **ONLY** work with a special child seat designed to operate with it. It will not work with child seats which are not BabySmart™ compatible.

Never place anything between seat cushion and child seat (e.g. pillow), since it reduces

the effectiveness off the BabySmart™ air bag deactivation system. The bottom of the child seat must make full contact with the front passenger seat cushion. An incorrectly mounted child seat could cause injuries to the child in case of an accident, instead of protecting the child.

Follow the manufacturer's instructions for installation of special child seats.

Seat belts

Safety notes

The use of seat belts and infant and child restraint systems is required by law in all 50 states, the District of Columbia, the U.S. territories and all Canadian provinces.

Even where this is not the case, all vehicle occupants should have their seat belts fastened whenever the vehicle is in motion.

For information on infants and children traveling with you in the vehicle and restraint systems for infants and children, see "Children in the vehicle" (▷ page 55).

Warning!

Always fasten your seat belt before driving off. Always make sure all of your passengers are properly restrained. You and your passengers should always wear seat belts.

Failure to wear and properly fasten and position your seat belt greatly increases your risk of injuries and their likely severity in an accident.

If you are ever in an accident, your injuries can be considerably more severe without your seat belt properly buckled. Without your seat belt buckled, you are much more likely to hit the interior of the vehicle or be ejected from it. You can be seriously injured or killed.

In the same crash, the possibility of injury or death is lessened if you are properly wearing your seat belt. The air bags can only protect as intended if the occupants are properly wearing their seat belts.

Warning!

Never ride in a moving vehicle with the seat backrest in an excessively reclined position as this can be dangerous. You could slide under the seat belt in a collision. If you slide under it, the seat belt would apply force at the abdomen or neck. That could cause serious or even fatal injuries. The seat backrest and seat belt provide the best restraint when the wearer is in a position that is as upright as possible and the seat belt is properly positioned on the body.

Warning!

Never let more people ride in the vehicle than there are seat belts available. Make sure everyone riding in the vehicle is correctly restrained with a separate seat belt. Never use a seat belt for more than one person at a time.

Warning!

Damaged seat belts or seat belts that have been subjected to stress in an accident must be replaced. Also, the seat belt anchoring points must be checked.

Only use seat belts which have been approved by Mercedes-Benz.

Do not make any modifications to the seat belts. This can lead to unintended activation of the ETDs or to their failure to activate when necessary.

Do not bleach or dye seat belts as this may severely weaken them. In a crash they may not be able to provide adequate protection.

Have all work carried out only by qualified technicians. Contact an authorized Mercedes-Benz Center.

Proper use of seat belts

Warning!

USE SEAT BELTS PROPERLY

- Seat belts can only protect when used properly. Never wear seat belts in any other

way than as described in this section, as that could result in serious injuries in case of an accident.

- Each occupant should wear their seat belt at all times, because seat belts help reduce the likelihood of and potential severity of injuries in accidents, including rollovers. The integrated restraint system includes SRS (driver front air bag, front passenger front air bag, side impact air bags, window curtain air bags for door windows), Emergency Tensioning Devices (ETDs), seat belt force limiters, and front seat knee bolsters.

The system is designed to enhance the protection offered to properly belted occupants in certain frontal (front air bags and ETDs) and side (side impact air bags, window curtain air bags, and ETDs) impacts which exceed preset deployment thresholds and in certain rollovers (window curtain air bags and ETDs).

- Never wear the shoulder belt under your arm, against your neck or off your shoulder. In a frontal crash, your body would move too far forward. That would increase the chance of head and neck injuries. The seat belt would also apply too much force to the ribs or abdomen, which could severely injure internal organs such as your liver or spleen.

Adjust the seat belt so that the shoulder section is located as close as possible to the middle of the shoulder. It should not touch the neck. Never pass the shoulder portion of the seat belt under your arm. For this purpose, you can adjust the height of the seat belt outlet.

- Position the lap belt as low as possible on your hips and not across the abdomen. If the lap belt is positioned across your abdomen, it could cause serious injuries in a crash.
- Never wear seat belts over rigid or breakable objects in or on your clothing,

such as eyeglasses, pens, keys etc., as these might cause injuries.

- Make sure the seat belt is always fitted snugly. Take special care of this when wearing loose clothing.
- Never use a seat belt for more than one person at a time. Do not fasten a seat belt around a person and another person or other objects at the same time.
- Seat belts should not be worn twisted. In a crash, you would not have the full width of the seat belt to distribute impact forces. The twisted seat belt against your body could cause injuries.
- Pregnant women should also always use a lap/shoulder belt. The lap belt portion should be positioned as low as possible on the hips to avoid any possible pressure on the abdomen.
- Place the seat backrest in a position that is as upright as possible.
- Check your seat belt during travel to make sure it is properly positioned.
- Never place your feet on the instrument panel, dashboard, or on the seat. Always keep both feet on the floor in front of the seat.
- When using a seat belt to secure infant restraints, toddler restraints, or children in booster seats, always follow the child seat manufacturer's instructions.

Warning!

Do not pass seat belts over sharp edges. They could tear.

Do not allow the seat belt to get caught in the door or in the seat adjustment mechanism. This could damage the seat belt.

Never attempt to make modifications to seat belts. This could impair the effectiveness of the seat belts.

Fastening the seat belts

Warning!

According to accident statistics, children are safer when properly restrained in the rear seating positions than in the front seating position. Thus, we strongly recommend that children be placed in the rear seats whenever possible. Regardless of seating position, children 12 years old and under must be seated and properly secured in an appropriately sized infant restraint, toddler restraint, or booster seat recommended for the size and weight of the child. For additional information, see “Children in the vehicle”.

A child’s risk of serious or fatal injuries is significantly increased if the child restraints are not properly secured in the vehicle and/or the child is not properly secured in the child restraint.

Warning!

Vehicles with BabySmart™ air bag deactivation system, Canada only: Children 12 years old and under must never ride in the front seat, except in a Mercedes-Benz authorized BabySmart™ compatible child seat, which operates with the BabySmart™ system installed in the vehicle to deactivate the front passenger front air bag when it is installed properly. Otherwise they will be struck by the air bag when it inflates in a crash. If this happens, serious or fatal injury will result.

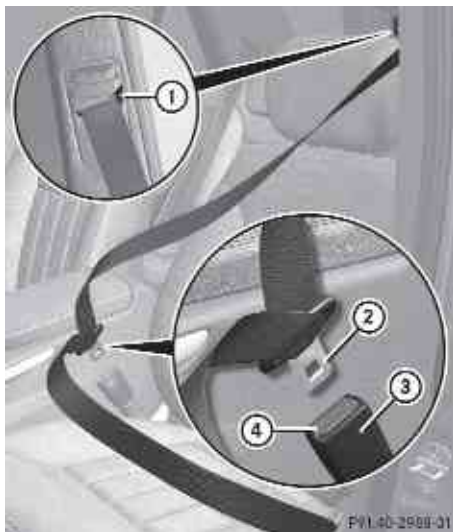

- ▶ With a smooth motion, pull the seat belt out of seat belt outlet ①.
- ▶ Place the shoulder portion of the seat belt across the top of your shoulder and the lap portion across your hips.
- ▶ Push latch plate ② into buckle ③ until it clicks.
Seat belt adjustment function: The seat belts on both front seats adjust to the upper body automatically as necessary (▷ page 51).
- ▶ If necessary, adjust the seat belt to the correct height (▷ page 51).
- ▶ If necessary, tighten the lap portion to a snug fit by pulling shoulder portion up.

All lap/shoulder belts except the driver’s seat belt have special seat belt retractors to secure child restraints properly. For more information on special seat belt retractors, see “Infant and child restraint system” (▷ page 56).

To release the seat belt with seat belt release button ④, see (▷ page 51).

Seat belt outlet height adjustment



- ▶ **Raising:** Slide the seat belt outlet height adjuster upward.
The seat belt outlet height adjuster engages in different positions.
- ▶ **Lowering:** Press and hold release button ①.
- ▶ Slide the seat belt outlet height adjuster downward.
- ▶ Release button ① and make sure the seat belt outlet height adjuster engages into place.

Seat belt adjustment function

The seat belt adjustment function adjusts the seat belts on both front seats to the upper body of the respective vehicle occupant. The seat belt will be pulled slightly tighter for that purpose when

- you engage the latch plate into the buckle and then turn the SmartKey in the starter switch to position **2**
- the SmartKey in the starter switch is in position **2** and you then engage the latch plate in the buckle

The seat belt adjustment function takes place with a certain amount of retracting force when the system senses slack between the vehicle occupant and the seat belt. Do not retain the seat belt during this procedure. You can activate or deactivate the seat belt adjustment function via the control system (▷ page 136).

Releasing the seat belts

- ▶ Press seat belt release button ④ (▷ page 50).
Allow the retractor to completely rewind the seat belt by guiding latch plate ② (▷ page 50).

! Make sure the seat belt retracts completely. Otherwise the seat belt and/or latch plate could get caught or pinched in the door or in the seat mechanism. This can damage the seat belt and impair its effectiveness, and/or cause damage to the door and/or door trim panel. Such damage is not covered by the Mercedes-Benz Limited Warranty.



Damaged seat belts must be replaced. Contact an authorized Mercedes-Benz Center.



Enhanced seat belt reminder system

When the engine is started, the seat belt telltale  will always illuminate for 6 seconds to remind you and your passengers to fasten your seat belts.

If the driver's seat belt is not fastened when the engine is started, an additional warning chime will sound. The warning chime goes out after approximately 6 seconds or once the driver's seat belt is fastened.

If after these 6 seconds the driver's or the front passenger's seat belt (with the front passenger seat occupied) is not fastened with front doors closed,

- the seat belt telltale  remains illuminated for as long as either the driver's or front passenger's seat belt is not fastened.
- and if the vehicle speed once exceeds 15 mph (25 km/h), the seat belt telltale  starts flashing and a warning chime sounds with increasing intensity for a maximum of 60 seconds or until the driver's and front passenger's seat belt are fastened.

If you and/or your passenger release the seat belt during driving, the seat belt telltale  starts flashing and the warning chime sounds as described before. If the driver's or the front passenger's seat belt remains unfastened after 60 seconds, the warning chime stops sounding, the seat belt telltale  stops flashing but continues to be illuminated.

After a vehicle standstill, the warning chime is reactivated and the seat belt telltale  is flashing again if the vehicle speed once exceeds 15 mph (25 km/h).

The seat belt telltale  will only go out if both the driver's and the front passenger's seat belt (with the front passenger seat occupied) are fastened, or the vehicle is standing still and a front door is opened. For more information, see "Practical hints" (▷ page 300).

Emergency Tensioning Device (ETD), seat belt force limiter

The seat belts for the front seats and rear outer seats are equipped with ETDs and seat belt force limiters.

The ETDs are designed to activate in the following cases:

- in frontal or rear-end impacts exceeding the system's preset deployment threshold
- in side impacts exceeding the system's preset deployment threshold on the far side of the impact
- in certain vehicle rollovers
- if the restraint systems are operational and functioning correctly, see "SRS indicator lamp" (▷ page 36)

The ETDs for the front seats will only activate if the front seat belts are fastened (latch plate properly inserted into buckle).

The ETDs for the rear outer seats will activate with or without the respective seat belts fastened.

In an impact, the ETDs remove slack from the seat belts in such a way that the seat belts fit more snugly against the body. Seat belt force limiters, when activated, are employed to help reduce the peak force exerted by the seat belts on occupants during a crash.

- ❗ The ETDs do not correct an incorrect seat position or incorrectly worn seat belts. The ETDs do not pull occupants back toward the seat backrest.

Warning!

Pyrotechnic ETDs that were activated must be replaced.

For your safety, when disposing of the pyrotechnic ETDs always follow our safety instructions. These are available at any authorized Mercedes-Benz Center.

The PRE-SAFE® system has electrically operated reversible pre-tensioners that do not require replacement after activation.

Preventive occupant safety (PRE-SAFE®)

Warning!

The PRE-SAFE® system is intended to reduce the effects of an accident on vehicle occupants who are wearing their seat belt properly. Despite your vehicle being equipped with the PRE-SAFE® system, the possibility of personal injuries occurring as a result of an accident cannot be eliminated. Therefore, always drive carefully and adjust your driving to the prevailing road, weather, and traffic conditions.

The PRE-SAFE® system takes preventive measures to better protect the occupants from the possibility of personal injuries in the following hazardous situations:

- emergency braking maneuvers with the Brake Assist System (BAS) (▷ page 63) activated
- critical dynamic driving situations, e.g. when the vehicle has been caused to understeer or oversteer because it has exceeded its physical limitations or in case of evasive steering maneuvers at speeds above approximately 85 mph (140 km/h)

PRE-SAFE® takes the following measures when it is activated:

- The front seat belts are pre-tensioned automatically.
- Vehicles with front passenger seat memory function: If the passenger seat is in an unfavorable position, the seat will be adjusted to a position that seeks to better protect the occupant.
- If the vehicle is in a critical dynamic driving situation, the door windows close, except for a minimal gap that remains open.
- Vehicles with power tilt/sliding sunroof: If the vehicle is in a critical dynamic driving situation, the tilt/sliding sunroof also closes, except for a minimal gap that remains open.

If the closing procedure of any of these elements is blocked, it will stop and open slightly.

Once the hazardous situation no longer exists and an accident has been avoided, the seat belt pre-tensioning is deactivated. All of the PRE-SAFE® settings can be re-adjusted following the critical driving event.

If the seat belts do not release:

- ▶ Adjust the seat backrest or seat slightly to the rear until the seat belt tension is reduced.
The locking mechanism releases.

- ! When moving the seats, make sure there are no items in the footwell or behind the seats. Otherwise, you could damage the seats and/or the items.

For information on the seat belt adjustment function as an integrated comfort feature of PRE-SAFE®, see (▷ page 51).

NECK-PRO active front head restraints

The NECK-PRO active front head restraints are intended to offer the driver and front passenger increased protection from whiplash-type injuries. In the event of a rear-end collision, the NECK-PRO active front head restraints on the front seats are designed to move forward in the direction of travel. They thus provide the head with increased support earlier on in the collision sequence. The NECK-PRO active front head restraints will move forward whether the seats are occupied or not.

Warning!

Do not attach any objects (e.g. hangers) to the head restraint posts. Otherwise, the NECK-PRO active front head restraints may not be able to function properly or offer the intended degree of protection they were designed for in the event of a rear-end collision.

Warning!

Only use seat or head restraint covers which have been tested and approved by Mercedes-Benz for your vehicle model.

Using other seat or head restraint covers may interfere with or prevent the activation of the NECK-PRO active front head restraints and/or the deployment of the front side impact air bags.

Contact an authorized Mercedes-Benz Center for availability.

When the NECK-PRO active front head restraints have been triggered in an accident, the NECK-PRO active front head restraints

must be reset. Otherwise, the NECK-PRO active front head restraints cannot offer any additional protection in the event of another rear-end collision.

For information on resetting the activated NECK-PRO active front head restraints, see “Resetting activated head restraints” (▷ page 309).

You cannot remove the NECK-PRO active front head restraints.

Warning!

For your protection, drive only with properly positioned head restraints.

Adjust the head restraint so that it is as close to the head as possible and the center of the head restraint supports the back of the head at eye level. This will reduce the potential for injury to the head and neck in the event of an accident or similar situation.

For information on head restraint adjustment, see “Head restraint height” (▷ page 83), or see “Head restraint fore and aft adjustment” (▷ page 83).

Correct driver seat adjustment

Warning!

In order to avoid possible loss of vehicle control the following must be done before the vehicle is put into motion:

- seat adjustment
- head restraint adjustment
- steering wheel adjustment
- rear view mirror adjustment
- fastening of seat belts



Steering wheel

Observe Safety notes, see page 86.

- ▶ Position steering wheel ① properly. See (▷ page 87) for manual adjustment and (▷ page 87) for electrical adjustment.

Make sure:

- You can reach the steering wheel with your arms slightly bent at the elbows.
- You can move your legs freely.
- All displays (including malfunction and indicator lamps) on the instrument cluster are clearly visible.

Seat belt

Observe Safety notes, see page 48.

- ▶ Fasten and position your seat belt ② correctly (▷ page 50).

Make sure:

- The seat belt is always fitted snugly.
- Adjust the seat belt so that the shoulder section is located as close as possible to the middle of the shoulder.
- Place the lap portion of the seat belt as low as possible on your hips.

Seat and head restraint

 **Observe Safety notes, see page 81.**

- ▶ Position seat ③ and head restraint properly. See (▷ page 82) for seat and head restraint adjustment.

Observe the following points:

- Always be in a properly seated position.
- The position should be as far rearward from the front air bag in the steering wheel as possible, while still permitting proper operation of vehicle controls.
- Adjust the seat to a comfortable seating position that still allows you to reach the accelerator/brake pedal safely.
- The seat must be adjusted so that you can correctly fasten and position your seat belt.
- The seat backrest must be in a position that is as nearly upright as possible.
- Adjust the seat cushion so that the front edge of the seat cushion lightly supports your legs.
- Adjust the head restraint so that it is as close to the head as possible and the center of the head restraint supports the back of the head at eye level.
- Never place hands under the seat or near any moving parts while the seat is being adjusted.

Children in the vehicle

Safety notes

If an infant or child is traveling with you in the vehicle:

- ▶ Secure the child using an infant or child restraint appropriate to the age and size of the child.
- ▶ Make sure the infant or child is properly secured at all times while the vehicle is in motion.

Warning!

When leaving the vehicle, always remove the SmartKey from the starter switch. Always take the SmartKey with you and lock the vehicle. Do not leave children unattended in the vehicle, even if they are secured in a child restraint system, or with access to an unlocked vehicle. A child's unsupervised access to a vehicle could result in an accident and/or serious personal injury. The children could

- injure themselves on parts of the vehicle
- be seriously or fatally injured through excessive exposure to extreme heat or cold
- injure themselves or cause an accident with vehicle equipment that can be operated even if the SmartKey is removed from the starter switch or removed from the vehicle, such as seat adjustment, steering wheel adjustment, or the memory function

If children open a door, they could injure other persons or get out of the vehicle and injure themselves or be injured by following traffic.

Do not expose the child restraint system to direct sunlight. The child restraint system's metal parts, for example, could become very hot, and the child could be burned by these parts.

Warning!

Do not carry heavy or hard objects in the passenger or cargo compartment unless they are firmly secured in place.

Unsecured or improperly positioned cargo increases a child's risk of injury in the event of

- strong braking maneuvers
- sudden changes of direction
- an accident

Infant and child restraint systems

 **Observe Safety notes, see page 55.**

We recommend all infants and children be properly restrained at all times while the vehicle is in motion.

Canada only:

Only use a BabySmart™ compatible child restraint for the front passenger seat in this vehicle.

All lap/shoulder belts except the driver's seat belt have special seat belt retractors for secure fastening of child restraints.

To fasten a child restraint, follow the child restraint manufacturer's instructions for mounting.

To activate the special seat belt retractor:

- ▶ Pull the shoulder belt out completely and let it retract.
During seat belt retraction, a ratcheting sound can be heard to indicate that the special seat belt retractor is activated. The seat belt is now locked.
- ▶ Push down on child restraint to take up any slack.

To deactivate the special seat belt retractor:

- ▶ Release the seat belt buckle and let the seat belt retract completely.
The seat belt can then again be used in the usual manner.

To deactivate the special seat belt retractor for the front passenger seat, the front passenger seat must be in the most backward position.

Warning!

Never release the seat belt buckle while the vehicle is in motion, since the special seat belt retractor will be deactivated.

- i** Information on child seats with mounting fittings for tether anchorages (▷ page 58).

For information on LATCH-type child seat anchors (▷ page 59).

The use of infant or child restraints is required by law in all 50 states, the District of Columbia, the U.S. territories and all Canadian provinces.

Infants and small children should be seated in an appropriate infant or child restraint system. They must be properly secured in accordance with the manufacturer's instructions for the child restraint. All infant or child restraint systems must comply with U.S. Federal Motor Vehicle Safety Standards 213 and 225 and Canadian Motor Vehicle Safety Standards 213 and 210.2.

A statement by the child restraint manufacturer of compliance with these standards can be found on the instruction label on the restraint and in the instruction manual provided with the restraint.

When using any infant restraint, toddler restraint, or booster seat, make sure to carefully read and follow all manufacturer's instructions for installation and use.

Please read and observe warning labels affixed to the inside of the vehicle and to infant or child restraints.

Warning!

According to accident statistics, children are safer when properly restrained in the rear seating positions than in the front seating position. Thus, we strongly recommend that children be placed in the rear seats whenever possible. Regardless of seating position, children 12 years old and under must be seated and properly secured in an appropriate

infant restraint, toddler restraint, or booster seat recommended for the size and weight of the child.





The infant or child restraint must be properly secured with the vehicle's seat belt, the seat belt and top tether strap, or lower anchors and top tether strap, fully in accordance with the child seat manufacturer's instructions.

Occupants, especially children, should always sit as upright as possible, wear the seat belt properly and use an appropriately sized infant restraint, toddler restraint, or booster seat recommended for the size and weight of the child.

Children can be killed or seriously injured by an inflating air bag. Note the following important information when circumstances require you to place a child in the front passenger seat:

- USA only: Your vehicle is equipped with air bag technology designed to deactivate the front passenger front air bag in your vehicle when the system senses the weight of a typical 12-month-old child or less along with the weight of a standard appropriate child restraint on the front passenger seat.
- USA only: For children larger than the typical 12-month-old child, the front passenger front air bag may or may not be activated. Always make sure the  **PASS AIR BAG OFF** indicator lamp is illuminated, indicating that the front passenger front air bag is deactivated.
- Canada only: Children 12 years old and under must never ride in the front seat, except in a Mercedes-Benz authorized BabySmart™ compatible child seat, which operates with the BabySmart™ system installed in the vehicle to deactivate the front passenger front air bag when it is installed properly. Otherwise they will be struck by the air bag when it inflates in a crash. If this happens, serious or fatal injury will result.

- A child in a rear-facing child restraint on the front passenger seat will be seriously injured or even killed if the front passenger front air bag inflates in a collision which could occur under some circumstances, even with the air bag technology installed in your vehicle. The only means to completely eliminate this risk is to never place a child in a rear-facing child restraint in the front seat. We therefore strongly recommend that you always place a child in a rear-facing child restraint in a backseat.

- If you must install a rear-facing child restraint on the front passenger seat because circumstances require you to do so, make sure the  **PASS AIR BAG OFF** indicator lamp is illuminated, indicating that the front passenger front air bag is deactivated. Should the  **PASS AIR BAG OFF** indicator lamp not illuminate or go out while the restraint is installed, please check installation. Periodically check the  **PASS AIR BAG OFF** indicator lamp while driving to make sure the  **PASS AIR BAG OFF** indicator lamp is illuminated. If the  **PASS AIR BAG OFF** indicator lamp goes out or remains out, do not transport a child on the front passenger seat until the system has been repaired.

A child in a rear-facing child restraint on the front passenger seat will be seriously injured or even killed if the front passenger front air bag inflates.

- If you have to place a child in a forward-facing child restraint on the front passenger seat, move the seat as far back as possible, use the proper child restraint recommended for the age, size and weight of the child, and secure child restraint with the vehicle's seat belt according to the child seat manufacturer's instructions.

Warning!

Infants and small children should never share a seat belt with another occupant. During an

accident, they could be crushed between the occupant and seat belt.

A child's risk of serious or fatal injuries is significantly increased if the child restraints are not properly secured in the vehicle and/or the child is not properly secured in the child restraint.

Children too big for a toddler restraint must ride in seats using regular seat belts. Position shoulder belt across chest and shoulder, not face or neck. A booster seat may be necessary to achieve proper seat belt positioning for children over 41 lb (18 kg) until they reach a height where a lap/shoulder belt fits properly without a booster.

When the child restraint is not in use, remove it from the vehicle or secure it with the seat belt to prevent the child restraint from becoming a projectile in the event of an accident.

Installation of infant and child restraint systems

 **Observe Safety notes, see page 55.**

Warning!

Always lock the seat backrests in their upright position when the rear seats are occupied by passengers. Lock the seat backrests in their upright position after installing top tether straps or when the extended cargo compartment is not in use. Make sure that seat backrests are secured properly by pushing and pulling on the seat backrests. If a seat backrest is not locked properly, the seat backrest could fold. The child seat would no longer be supported properly or positioned to provide its intended benefit. That could cause serious or even fatal injuries.

This vehicle is equipped with tether anchorages for a top tether strap at each of the rear seating positions.

Top tether straps enable an additional connection to be made between child restraint systems secured with LATCH-type

anchors and rear seats. This can further reduce the risk of injury.

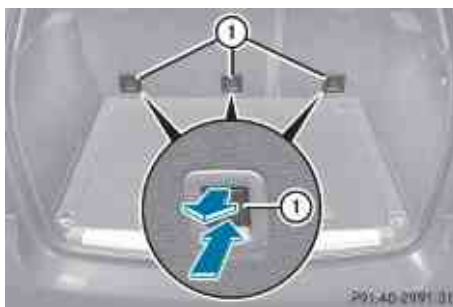

- ▶ Press in lower part of anchorage ring cover ① on the seat backrest on which a child seat is to be installed.
- ▶ Pull on upper part of anchorage ring cover ① to remove cover.
- ▶ Store anchorage ring cover ① in a convenient place (e.g. glove box).

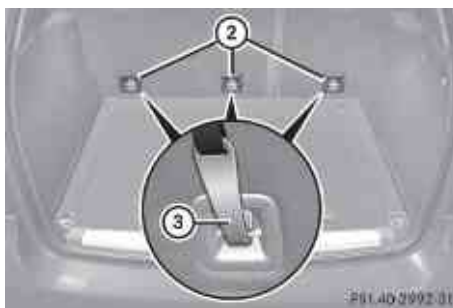

- ▶ Move the respective head restraint to its uppermost position (▷ page 84).



- ▶ Guide top tether strap ④ between the head restraint and top of the seat backrest.
- ▶ Securely fasten hook ③, which is part of top tether strap ④, to anchorage ring ②.

Make sure

- hook ③ is attached to anchorage ring ② beyond the safety catch, as illustrated
 - top tether strap ④ is not twisted
 - the head restraint is installed and positioned such that top tether strap ④ can pass freely between the head restraint and top of the seat backrest
 - top tether strap ④ is positioned between the seat backrest and the cargo compartment cover blind (if installed)
 - top tether strap ④ is positioned between the seat backrest and the cargo net (if installed)
- ▶ Lower the head restraint if necessary (▷ page 84).
Make sure the top tether strap can pass freely between the head restraint and top of the seat backrest.
 - ▶ Install the child restraint system and tighten the top tether strap according to the child restraint manufacturer's instructions.

After removing the child restraint system and top tether strap ④:

- ▶ Reinstall anchorage ring cover ①.

Child seat anchors – LATCH-type

⚠ **Observe Safety notes, see page 55.**

⚠ **Warning!**

Children too big for a toddler restraint must ride in seats using regular seat belts. Position shoulder belt across chest and shoulder, not face or neck.

A booster seat may be necessary to achieve proper seat belt positioning for children over

41 lb (18 kg) until they reach a height where a lap/shoulder belt fits properly without a booster.

Install child seat according to manufacturer's instructions.

The child seat must be firmly attached to both anchors.

An incorrectly mounted child seat may come loose during an accident which could result in serious injury or death to the child.

Damaged or impact damaged child seats or child seat mounting fittings must be replaced.

Each rear outer seat has two LATCH-type anchors for the installation of a LATCH-type child seat with matching mounting fittings. Non-LATCH-type child seats may also be used and can be installed using the vehicle's seat belt system. Install child seat according to the manufacturer's instructions.

The LATCH-type anchors are blended with covers.



- ▶ Remove anchorage ring covers ① from anchors ② of the seat on which a child seat is to be installed.



- ▶ Install a LATCH-type child seat according to the manufacturer's instructions. A rigid connection between the child seat and the body of the vehicle is established.
- ▶ Make sure that the seat belt for the rear center seat can operate freely with a child seat installed.

Child safety

Child safety locks

 **Observe Safety notes, see page 55.**

 **Warning!**

Children could open a rear door from the inside. This may cause serious personal injury or an accident. Therefore, secure the rear doors with the child safety locks whenever children are riding in the back seats of the vehicle.

The child safety locks on the rear doors enable you to secure each rear door individually. You cannot open a secured rear door from the inside. You can open the rear door from the outside when the vehicle is unlocked.



- ▶ **Securing:** Press the lever down in direction of arrow ②.
- ▶ Check to make sure the child safety locks are working properly.
- ▶ **Releasing:** Press the lever up in direction of arrow ①.

Override switch

 **Observe Safety notes, see page 55.**

With the override switch you can disable the rear door window switches in the rear door panels. This can be useful, for instance, when you have children riding in the rear passenger compartment.

 **Warning!**

Activate the override switch when children are riding in the back seats of the vehicle. The children may otherwise injure themselves, e.g. by becoming trapped in the rear door window opening.



- ▶ **Activating:** Press override switch ①. The switch engages in recessed position.

The rear door windows can no longer be operated using the respective switch located in the rear doors.

You can still operate the rear door windows using the switches located on the door control panel of the driver's door.

► **Deactivating:** Press override switch ① again.

The switch disengages from its recessed position back to its original position.

The rear door windows can be operated again using the respective switch located in the rear doors.

For more information on power windows, see the "Controls in detail" section (▷ page 100).

Panic alarm



Example illustration: SmartKey with KEYLESS-GO

► **Activating:** Press and hold **PANIC** button ① for at least 1 second.

An audible alarm and flashing exterior lamps will operate briefly.

► **Deactivating:** Press **PANIC** button ① again.

or

► Insert the SmartKey into the starter switch.
or

► Press the KEYLESS-GO start/stop button.
The SmartKey with KEYLESS-GO must be inside the vehicle.

① USA only:

This device complies with Part 15 of the FCC Rules. Operation is subject to the following two conditions:

1. This device may not cause harmful interference, and
2. this device must accept any interference received, including interference that may cause undesired operation.

Any unauthorized modification to this device could void the user's authority to operate the equipment.

① Canada only:

This device complies with RSS-210 of Industry Canada. Operation is subject to the following two conditions:

1. This device may not cause interference, and
2. this device must accept any interference received, including interference that may cause undesired operation of the device.

Any unauthorized modification to this device could void the user's authority to operate the equipment.

Driving safety systems

Introduction

This section contains information about the following driving safety systems:

- ABS (Antilock Brake System)
- BAS (Brake Assist System)
- EBP (Electronic Brake Proportioning)
- ESP® (Electronic Stability Program)

① In winter operation, the maximum effectiveness of most of the driving systems described in this section is only

achieved with winter tires, or snow chains as required.

Safety notes

Warning!

The following factors increase the risk of accidents:

- Excessive speed, especially in turns
- Wet and slippery road surfaces
- Following another vehicle too closely

The driving safety systems described in this section cannot reduce these risks or prevent the natural laws of physics from acting on the vehicle. They cannot increase braking or steering efficiency beyond that afforded by the condition of the vehicle brakes and tires or the traction afforded.

Only a safe, attentive, and skillful driver can prevent accidents.

The capabilities of a vehicle equipped with the driving safety systems described in this section must never be exploited in a reckless or dangerous manner which could jeopardize the user's safety or the safety of others.

Always adjust your driving style to the prevailing road and weather conditions and keep a safe distance to other road users and objects on the street.

If a driving system malfunctions, other driving safety systems may also switch off. Observe indicator and warning lamps that may come on as well as messages in the multifunction display that may appear.

Warning!

HYBRID vehicles: It is imperative that you read the HYBRID Supplemental Operating Instructions included in your vehicle literature portfolio. You may otherwise not recognize potential danger.

ABS

 **Observe Safety notes, see page 62.**

Warning!

Do not pump the brake pedal. Use firm, steady brake pedal pressure instead. Pumping the brake pedal defeats the purpose of the ABS and significantly reduces braking effectiveness.

The Antilock Brake System (ABS) regulates the brake pressure so that the wheels do not lock during braking. This allows you to maintain the ability to steer your vehicle.

The ABS is functional above a speed of approximately 5 mph (8 km/h) independent of road surface conditions.

On slippery road surfaces, the ABS will respond even to light brake pressure.

The ABS indicator lamp  indicator lamp in the instrument cluster comes on when you switch on the ignition. It goes out when the engine is running.

Braking

At the instant one of the wheels is about to lock up, a slight pulsation can be felt in the brake pedal. The pulsation indicates that the ABS is in the regulating mode.

- Keep firm and steady pressure on the brake pedal while you feel the pulsation.

Continuous, steady brake pedal pressure yields the advantages provided by the ABS, namely braking power and the ability to steer the vehicle.

The pulsating brake pedal can be an indication of hazardous road conditions and functions as a reminder to take extra care while driving.

Emergency brake maneuver

- Keep continuous full pressure on the brake pedal.

⚠ Warning!

If the ABS malfunctions, other driving safety systems such as the BAS or the ESP® are also switched off. Observe indicator and warning lamps that may come on as well as messages in the multifunction display that may appear. If the ABS malfunctions, the wheels may lock during hard braking, reducing steering capability and extending the braking distance.

Off-road ABS (vehicles with 4MATIC)

Vehicles with 4MATIC have a special ABS off-road feature. With the off-road driving program switched on (▷ page 155), the ABS designed for off-road driving is activated automatically.

When applying the brakes at speeds below 18 mph (30 km/h), the front wheels are locked cyclically to shorten the braking distance (dig-in effect). This will restrict steering the vehicle.

BAS**⚠ Observe Safety notes, see page 62.**

The Brake Assist System (BAS) operates in emergency situations. If you apply the brakes very quickly, the BAS provides full brake boost automatically, thereby potentially reducing the braking distance.

- ▶ Apply continuous full braking pressure until the emergency braking situation is over. The ABS will prevent the wheels from locking.

When you release the brake pedal, the brakes function again as normal. The BAS is then deactivated.

⚠ Warning!

If the BAS malfunctions, the brake system still functions, but without the additional brake boost available that the BAS would normally provide in an emergency braking maneuver. Therefore, the braking distance may increase.

EBP**⚠ Observe Safety notes, see page 62.**

The Electronic Brake Proportioning (EBP) enhances braking effectiveness by allowing the rear brakes to supply a greater proportion of the braking effort in straight-line braking without a loss of vehicle stability.

⚠ Warning!

If the EBP malfunctions, the brake system will still function with full brake boost. However, the rear wheels could lock up during emergency braking situations, for example. You could lose control of the vehicle and cause an accident.

Adapt your driving style to the changed driving characteristics.

ESP®**⚠ Observe Safety notes, see page 62.**

The Electronic Stability Program (ESP®) is operational as soon as the engine is running. It monitors the vehicle's traction (force of adhesive friction between the tires and the road surface) and handling.

The ESP® recognizes that the vehicle deviates from the direction of travel as intended by the driver. By applying brakes to individual wheels and by limiting the engine output, the ESP® works to stabilize the vehicle. The ESP® is especially useful while driving off and on wet or slippery road surfaces. The ESP® also stabilizes the vehicle during braking and steering maneuvers.

The ESP® warning lamp  in the instrument cluster comes on when you switch on the ignition. It goes out when the engine is running.

The ESP® warning lamp  in the instrument cluster flashes when the ESP® is engaged.

Warning!

Never switch off the ESP® when you see the ESP® warning lamp  flashing in the instrument cluster. In this case proceed as follows:

- When driving off, apply as little throttle as possible.
- While driving, ease up on the accelerator pedal.
- Adapt your speed and driving style to the prevailing road conditions.

Failure to observe these guidelines could cause the vehicle to skid. The ESP® cannot prevent accidents resulting from excessive speed.

! Vehicles with 4MATIC:

Only conduct operational or performance tests on a two-axle dynamometer. If such tests are necessary, contact an authorized Mercedes-Benz Center. You could otherwise seriously damage the brake system or the transfer case which is not covered by the Mercedes-Benz Limited Warranty.

! Vehicles without 4MATIC:

Because the ESP® operates automatically, the engine and ignition must be shut off (SmartKey in starter switch position **0** or **1** or KEYLESS-GO start/stop button in position **0** or **1**) when the parking brake is being tested on a brake test dynamometer or the vehicle is being towed with one axle raised.

Active braking action through the ESP® may otherwise seriously damage the brake system which is not covered by the Mercedes-Benz Limited Warranty.

! Vehicles with 4MATIC:

Because the ESP® operates automatically, the engine and ignition must be shut off (SmartKey in starter switch position **0** or **1** or KEYLESS-GO start/stop button in

position **0** or **1**) when the parking brake is being tested on a brake test dynamometer. Such testing should be no longer than 10 seconds.

Active braking action through the ESP® may otherwise seriously damage the brake system which is not covered by the Mercedes-Benz Limited Warranty.

! The ESP® will only function properly if you use wheels of the recommended tire size as specified in the “Technical data” section of this Operator’s Manual.

i The cruise control switches off automatically when the ESP® engages.

Electronic Traction System (ETS/4-ETS)

Observe Safety notes, see page 62.

The ETS (Electronic Traction System) and 4-ETS (four-wheel Electronic Traction System, vehicles with 4MATIC only) are components of the ESP®. The ETS/4-ETS improves the vehicle’s ability to utilize available traction, especially under slippery road conditions by applying the brakes to a spinning wheel. Vehicles with 4MATIC also transfer more power to the wheel(s) with traction.

When you switch off the ESP®, the ETS/4-ETS is still enabled.

► If conditions require, switch on the off-road driving program (▷ page 155).

Off-road 4-ETS (vehicles with 4MATIC)

With the off-road driving program switched on (▷ page 155), the 4-ETS designed for off-road use is activated automatically.

Switching off the ESP®

Warning!

The ESP® should not be switched off during normal driving other than in the

circumstances described below. Disabling the system will reduce vehicle stability in driving maneuvers.

Do not switch off the ESP® when a spare wheel is mounted.

To improve the vehicle's traction, switch off the ESP®. This allows the drive wheels to spin and thus cut into surfaces for better grip, for example

- when driving with snow chains
- in deep snow
- in sand or gravel

Warning!



Switch on the ESP® immediately if the aforementioned circumstances do not apply anymore. Otherwise the ESP® will not stabilize the vehicle when it is starting to skid or a wheel is spinning.

When you switch off the ESP®,

- the ESP® does not stabilize the vehicle
- the engine output is not limited, which allows the drive wheels to spin and thus cut into surfaces for better grip
- the ETS/4-ETS will still apply the brakes to a spinning wheel
- the ESP® continues to operate when you are braking
- the cruise control cannot be activated
- the cruise control or the DISTRONIC system switch off if activated

i When the ESP® is switched off and one or more drive wheels are spinning, the ESP® warning lamp  in the instrument cluster flashes. However, the ESP® will then not stabilize the vehicle.



- ▶ With the engine running, press ESP® switch  until the ESP® warning lamp  in the instrument cluster comes on. The ESP® is switched off.



Warning!

When the ESP® warning lamp  is illuminated continuously, the ESP® is switched off or is not operational due to a malfunction. Vehicle stability in standard driving maneuvers is reduced.

Adapt your speed and driving to the prevailing road conditions and to the non-operating status of the ESP®.

- !** Avoid spinning of a drive wheel for an extended period with the ESP® switched off. This may cause serious damage to the drivetrain which is not covered by the Mercedes-Benz Limited Warranty.

Switching on the ESP®

- ▶ Press ESP® switch  until the ESP® warning lamp  in the instrument cluster goes out. You are now again in normal driving mode with the ESP® switched on.

Off-road ESP® (vehicles with 4MATIC)

With the off-road driving program switched on (> page 155), the ESP® designed for off-road use is activated automatically. At speeds below 27 mph (45 km/h), the ESP® assists in

over-/understeering, thus improving vehicle traction.

ESP® trailer stabilization

If the trailer you are towing should begin to sway, the rig can only be stabilized by immediately applying the brakes hard. Steering during this maneuver will not help to stabilize the rig.

The ESP® will assist you in such situations. The ESP® recognizes when the trailer starts swaying and will apply the brakes to reduce the vehicle speed to a non-critical speed that allows the vehicle-trailer combination to stabilize.

The ESP® trailer stabilization is functional at vehicle speeds above approximately 40 mph (65 km/h) when the ESP® is switched on.

Warning!

The system will not be able to assist when the trailer jackknives

- if the ESP® has switched off due to a malfunction
- on wet or icy roads
- on roads with slippery surface
- in sand or gravel

Trailers with a high center of gravity may tip over before the system recognizes swaying of the trailer.

Anti-theft systems

Immobilizer

The immobilizer prevents unauthorized persons from starting your vehicle.

When leaving the vehicle, always take the SmartKey with you and lock the vehicle. The engine can be started by anyone with a valid SmartKey that is left inside the vehicle.

Activating

- ▶ **With SmartKey:** Remove the SmartKey from the starter switch.
- ▶ **With KEYLESS-GO:** Turn off the engine and open the driver's door.

Deactivating

- ▶ Switch on the ignition.
- i** Starting the engine will also deactivate the immobilizer.

In the event that the engine cannot be started (yet the vehicle's battery is charged), the system is not operational. Contact an authorized Mercedes-Benz Center or call 1-800-FOR-MERCEdes (in the USA) or 1-800-387-0100 (in Canada).

Anti-theft alarm system

Once the alarm system has been armed, a visual and audible alarm is triggered when someone opens

- a door
- the tailgate
- the hood

The alarm will stay on even if the activating element, a door, for example, is closed immediately.

The alarm system will also be triggered when

- the vehicle is opened with the mechanical key
- a door is opened from the inside

To cancel the alarm after it has been triggered, see "Canceling the alarm" (▷ page 67).

i If the alarm stays on for more than 30 seconds, the Tele Aid system initiates a call to the Response Center automatically. The Tele Aid system will initiate the call provided that

- you have subscribed to the Tele Aid service
- the Tele Aid service has been activated properly
- the necessary mobile phone, power supply and GPS coverage are available

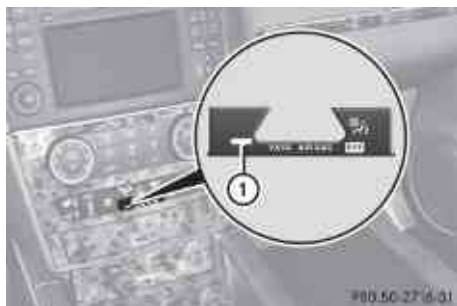

► **Arming:** Lock the vehicle with the SmartKey or with KEYLESS-GO. The turn signal lamps flash three times to indicate that the vehicle is locked. Indicator lamp ① flashes to indicate that the alarm system is armed.

i If the turn signal lamps do not flash three times, a door or the tailgate may not be properly closed. Close the respective element.



► **Disarming:** Unlock the vehicle with the SmartKey or with KEYLESS-GO. The turn signal lamps flash once to indicate that the alarm system is disarmed.

i Unless you open a door or the tailgate within approximately 40 seconds after unlocking the vehicle:

- The vehicle will be locked again.
- The anti-theft alarm system will be rearmed.

Canceling the alarm

To cancel the alarm, do one of the following:

- Insert the SmartKey into the starter switch.
- Press button  or  on the SmartKey.

In vehicles with KEYLESS-GO:

- Grasp an outside door handle. The SmartKey must be within 3 ft (1 m) of the vehicle.
- Press the KEYLESS-GO start/stop button. The SmartKey must be inside the vehicle.

Vehicle equipment	70
Locking and unlocking	70
Starter switch positions	79
Seats	81
Multifunction steering wheel	86
Mirrors	89
Memory function	92
Lighting	92
Wipers	98
Power windows	100
Driving and parking	103
Automatic transmission	109
Transfer case	117
Instrument cluster	117
Control system	119
Driving systems	141
Overview of climate control system functions and air vents	165
Climate control	167
3-zone automatic climate control ...	173
Rear window defroster	183
Power tilt/sliding sunroof	184
Loading and storing	186
Useful features	194



Vehicle equipment

- i** This Operator's Manual describes all features, standard or optional, potentially available for your vehicle at the time of purchase. Please be aware that your vehicle might not be equipped with all features described in this manual.

Locking and unlocking

Notes

- ⚠ Observe Safety notes, see page 55.**

When unlocking the vehicle, all turn signal lamps flash once. The locking knobs in the doors move up. The anti-theft alarm system is disarmed.

When locking the vehicle, all turn signal lamps flash three times. The locking knobs in the doors move down. The anti-theft alarm system is armed.

All doors and the tailgate must be closed.

If you cannot lock or unlock the vehicle with the SmartKey, the batteries in the SmartKey are discharged, the SmartKey is malfunctioning, or the vehicle battery is drained.

- ▶ Check the batteries in the SmartKey (▷ page 73) and replace them if necessary.
- ▶ Use the mechanical key to unlock the driver's door (▷ page 306).
- ▶ Use the mechanical key to lock the vehicle (▷ page 307).
- ▶ Have the vehicle battery and the vehicle battery connections checked at an authorized Mercedes-Benz Center.

If the SmartKey is malfunctioning, contact Roadside Assistance or an authorized Mercedes-Benz Center.

SmartKey



Your vehicle comes supplied with two SmartKeys, each with remote control and a removable mechanical key.

The SmartKey centrally locks and unlocks:

- the doors
- the tailgate
- the fuel filler flap



Example illustration: SmartKey with KEYLESS-GO

- ①  Lock button
- ②  Unlock button for tailgate
- ③  Unlock button

i USA only:

This device complies with Part 15 of the FCC Rules. Operation is subject to the following two conditions:

1. This device may not cause harmful interference, and
2. this device must accept any interference received, including interference that may cause undesired operation.

Any unauthorized modification to this device could void the user's authority to operate the equipment.

i Canada only:

This device complies with RSS-210 of Industry Canada. Operation is subject to the following two conditions:

1. This device may not cause interference, and
2. this device must accept any interference received, including interference that may cause undesired operation of the device.

Any unauthorized modification to this device could void the user's authority to operate the equipment.

Factory setting

► **Global unlocking:** Press button .



Unless you open a door or the tailgate within approximately 40 seconds after unlocking the vehicle:

- The vehicle will be locked again.
- The antitheft alarm system will be rearmed.

► **Global locking:** Press button .

Selective setting

If you frequently travel alone, you may wish to reprogramm the SmartKey. Pressing button  will then only unlock the driver's door and the fuel filler flap.

► **Switching on/off:** Press and hold buttons  and  simultaneously for approximately 6 seconds until the battery check lamp (► page 73) flashes twice.

The SmartKey will then function as follows:

► **Unlocking driver's door and fuel filler flap:** Press button  once.

► **Global unlocking:** Press button  twice.

► **Global locking:** Press button .

KEYLESS-GO

Vehicles equipped with KEYLESS-GO come with two SmartKeys with KEYLESS-GO, each with remote control and a removable mechanical key.

The KEYLESS-GO function is integrated into the SmartKey. The validity of the SmartKey is checked every time you grasp an outside door handle.

When the SmartKey is valid, your vehicle unlocks

- the doors
- the fuel filler flap
- the tailgate

i USA only:

This device complies with Part 15 of the FCC Rules. Operation is subject to the following two conditions:

1. This device may not cause harmful interference, and
2. this device must accept any interference received, including interference that may cause undesired operation.

Any unauthorized modification to this device could void the user's authority to operate the equipment.

i Canada only:

This device complies with RSS-210 of Industry Canada. Operation is subject to the following two conditions:

1. This device may not cause interference, and
2. this device must accept any interference received, including interference that may cause undesired operation of the device.

Any unauthorized modification to this device could void the user's authority to operate the equipment.

Important notes on using KEYLESS-GO

- You can also use the SmartKey with KEYLESS-GO like a normal SmartKey (> page 70).
- You can combine KEYLESS-GO functions with normal SmartKey functions (e.g. unlocking with KEYLESS-GO and locking with button ).
- Always carry the SmartKey with you.
- Never store the SmartKey together with:
 - Electronic items such as a mobile phone or another SmartKey
 - Metallic objects such as coins or metal foil
 Doing so could impair the function of the KEYLESS-GO system.
- To lock or unlock the vehicle, the SmartKey must be located outside the vehicle within approximately 3 ft (1 m) of a door or the tailgate.
- When the vehicle has been parked for more than 72 hours, the KEYLESS-GO function is deactivated. Pull an outside door handle and switch on the ignition once to activate the KEYLESS-GO function.
- If the SmartKey is positioned farther away from the vehicle, the system may no longer recognize the SmartKey. The vehicle cannot be locked or the engine started via the KEYLESS-GO system.
- If the SmartKey is removed from the vehicle (e.g. if a passenger exits the vehicle with the SmartKey)
 - when pressing the KEYLESS-GO start/stop button or trying to lock the vehicle with the lock button on an outside door handle the message Key Not Detected appears in the multifunction display
 - with the engine running, the red message Key Not Detected appears in the multifunction display while driving off

Find the SmartKey or change its present location immediately (e.g. place it on the front passenger seat or insert it in shirt pocket).

- If you have started the engine with the KEYLESS-GO start/stop button, you can turn it off again by
 - pressing the KEYLESS-GO start/stop button
 - inserting the SmartKey into the starter switch when the vehicle is at a standstill and the automatic transmission is in park position **P**
- The vehicle could be inadvertently unlocked if the SmartKey is within 3 ft (1 m) of the vehicle and
 - an outside door handle is splashed with water
 - or
 - you attempt to clean an outside door handle
- Remember that the engine can be started by anyone with a SmartKey that is left inside the vehicle.

Possibility 1 (One SmartKey in the vehicle, one SmartKey outside the vehicle):

If you leave the SmartKey behind when exiting and locking the vehicle, no message appears in the multifunction display.

Possibility 2 (One SmartKey in the vehicle, no SmartKey outside the vehicle):

When exiting and trying to lock the vehicle, the message Key Detected In Vehicle appears in the multifunction display. The vehicle will not be locked.

Factory setting

- **Global unlocking:** Grasp an outside door handle.

Unless you open a door or the tailgate within approximately 40 seconds after unlocking the vehicle:

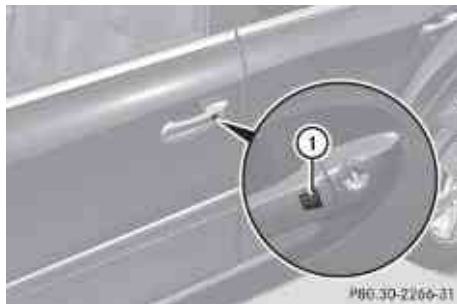

- The vehicle will be locked again.
- The antitheft alarm system will be rearmed.



- ▶ **Global locking:** Press lock button ① on an outside door handle.

Selective setting

If you frequently travel alone, you may wish to reprogram the SmartKey. Grasping the driver's outside door handle will then only unlock the driver's door and the fuel filler flap.

- ▶ **Switching on/off:** Press and hold buttons  and  simultaneously for approximately 6 seconds until the battery check lamp (▷ page 73) flashes twice.



The SmartKey will then function as follows:

- ▶ **Unlocking driver's door and fuel filler flap:** Grasp the driver's outside door handle.
- ▶ **Global unlocking:** Grasp any outside door handle other than the driver's outside door handle.
- ▶ **Global locking:** Press lock button ① on an outside door handle.

Checking SmartKey batteries





Example illustration: SmartKey with KEYLESS-GO

- ▶ Press button  or  on the SmartKey. Battery check lamp ① comes on briefly to indicate that the SmartKey batteries are in order.

If the battery check lamp does not come on briefly during check, the SmartKey batteries are discharged.

- ▶ Replace the batteries (▷ page 309).

i You can obtain the required batteries at any authorized Mercedes-Benz Center.

i If the batteries are checked within signal range of the vehicle, pressing button  or  will lock or unlock the vehicle accordingly.

Loss of the SmartKey

If you lose your SmartKey or mechanical key, you should do the following:

- ▶ Have the SmartKey deactivated by an authorized Mercedes-Benz Center.
- ▶ Report the loss of the SmartKey or the mechanical key to your car insurance company immediately.
- ▶ Have the mechanical lock replaced if necessary.

Any authorized Mercedes-Benz Center will be glad to supply you with a replacement. For

information on replacing the SmartKey, see “Replacing the SmartKey” (▷ page 74).

Replacing the SmartKey

Only you, or someone authorized by you can order a replacement key from any Mercedes-Benz Center. In order to do so, the Mercedes-Benz Center will require proof of identity and vehicle ownership with original documents, including the following:

If you are the current owner of the vehicle:

- the vehicle’s current state registration
- a current identity card, passport, or drivers license

If you are an authorized person:

- the vehicle’s current state registration
- a current identity card, passport, or drivers license for the authorized individual
- signed and dated authorization from the owner of the vehicle for which the key is being requested

i Duplicated or photocopied documentation will not be accepted.

Activating the key

Once you, or an authorized person, has provided the appropriate documents, the Mercedes-Benz Center will need to synchronize the key to your vehicle before it can be used. In order to do so, the Mercedes-Benz Center need access to your vehicle.

Opening the doors from the inside

You can open a door from the inside even when it is locked unless it is secured with the child safety lock (▷ page 60).

Open door only when conditions are safe to do so.



Example illustration driver’s door

If the vehicle has previously been locked with the SmartKey or with KEYLESS-GO, opening a door from the inside will trigger the anti-theft alarm system.

To cancel the alarm, see (▷ page 67).

► **Front doors:** Pull on inside door handle ② on the respective front door. If the door was locked, locking knob ① will move up.

► **Rear doors:** Pull up locking knob on the respective rear door to unlock door.

► Pull on the inside door handle on the respective rear door.

Automatic central locking

The doors and the tailgate lock automatically when the vehicle is set into motion.

You can open a locked front door from the inside. Open door only when conditions are safe to do so.

The doors are designed to unlock automatically after an accident if the force of the impact exceeds a preset threshold.

The vehicle locks automatically when the ignition is switched on and the wheels are turning at vehicle speeds of above 9 mph (15 km/h). You could therefore lock yourself out when the vehicle is pushed or towed or is on a test stand.

i You can also activate or deactivate the automatic central locking using the control system (▷ page 135).

Locking and unlocking from the inside

⚠ Observe Safety notes, see page 55.

You can lock or unlock the vehicle from the inside using the central locking switches. This can be useful, for example, if you want to lock the vehicle before starting to drive.

The central locking switches do not lock or unlock the fuel filler flap.

The switches are located in each front door.

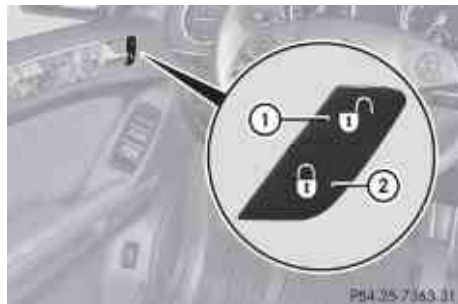

- ▶ **Locking:** Press central locking switch ②. When all doors and the tailgate are closed, the vehicle locks.
- ▶ **Unlocking:** Press central unlocking switch ①.

You can open a locked front door from the inside at any time. Open door only when conditions are safe to do so.

If the vehicle was previously locked with the central locking switch

- and the SmartKey is set to factory settings, the complete vehicle is unlocked when a front door is opened from the inside
- and the SmartKey is set to selective settings, only the front door opened from the inside is unlocked

If the vehicle has been locked centrally with the SmartKey or with KEYLESS-GO, it will not unlock using the central unlocking switch.

Tailgate

⚠ Warning!

Make sure the tailgate is closed when the engine is running and while driving. Among other dangers, deadly carbon monoxide (CO) gases may enter vehicle interior resulting in unconsciousness and death.

A minimum height clearance of 7.20 ft (2.20 m) is required to open the tailgate.

Opening the tailgate from the outside



- ▶ Pull on handle ①. In vehicles without KEYLESS-GO: The vehicle must be unlocked.
- ▶ Pull tailgate upwards to open.

Closing the tailgate from the outside

⚠ Observe Safety notes, see page 55.

⚠ Warning!

To prevent possible personal injury, always keep hands and fingers away from the cargo compartment opening when closing the tailgate. Be especially careful when small children are around.



- ▶ Lower tailgate by pulling firmly on handles ①.
- ▶ Close tailgate with hands placed flat on it. Once the tailgate touches the latch, the tailgate will pull itself shut automatically.

Power tailgate

Warning!

Make sure the tailgate is closed when the engine is running and while driving. Among other dangers, deadly carbon monoxide (CO) gases may enter vehicle interior resulting in unconsciousness and death.

! The tailgate swings open upwards automatically. Always make sure there is sufficient overhead clearance.

A minimum height clearance of 7.20 ft (2.20 m) is required to open the tailgate.

In vehicles with power tailgate, you can

- open and close the tailgate from the inside and the outside electrically
- limit the opening height of the tailgate
- interrupt the opening/closing procedure at any time by
 - pressing or pulling the door-mounted remote tailgate opening/closing switch
 - pulling the outside handle on the tailgate
 - pressing the tailgate closing switch
 - pressing the KEYLESS-GO locking/closing switch

Notes for operating the tailgate with the SmartKey:

You can also open, close, and stop the tailgate by pressing button  on the SmartKey.

The prerequisites for this are:

- No SmartKey is inserted in the starter switch.
- **KEYLESS-GO:** The vehicle's on-board electronics must have status **0** (▷ page 80).

Opening the tailgate from the outside

You can unlock and open the tailgate simultaneously from the outside when the vehicle is stationary.

- ▶ Press and hold button  on the SmartKey until the tailgate unlocks and begins to open. While the tailgate is opening, an acoustic warning sounds.

or

- ▶ Vehicles with KEYLESS-GO: Pull on the handle (▷ page 75).

Closing the tailgate from the outside

 **Observe Safety notes, see page 55.**

Warning!

Monitor the closing procedure carefully to make sure no one is in danger of being injured. To prevent possible personal injury, always keep hands and fingers away from the cargo compartment opening when closing the tailgate. Be especially careful when small children are around. To stop the closing procedure, do one of the following:

- Press or pull the remote tailgate opening/closing switch on the driver's door.
- Press the tailgate closing switch.
- Press the KEYLESS-GO locking/closing switch.

- Pull outside handle on the tailgate.
- When no SmartKey is inserted in the starter switch (vehicles with KEYLESS-GO: Make sure the vehicle's on-board electronics have status **0**): Press button  on the SmartKey.

Do not leave the SmartKey in the vehicle. You may lock yourself out.

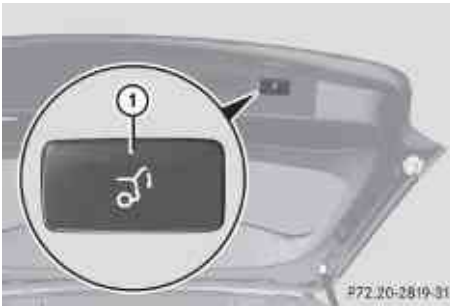

If the vehicle was previously centrally locked with the SmartKey or KEYLESS-GO, the tailgate will lock automatically when it is closed. The turn signal lamps flash three times to confirm locking.

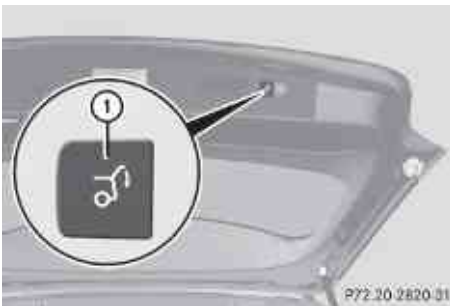

Vehicles without KEYLESS-GO



Vehicles with KEYLESS-GO

- ▶ Press tailgate closing switch  or press and hold button  on the SmartKey until the tailgate begins to close.

If the tailgate comes into contact with an object while closing, the closing procedure is stopped and the tailgate reopens. This may happen if luggage has been piled too high, for example.

Closing the tailgate and locking the vehicle from the outside (vehicles with KEYLESS-GO)

 **Observe Safety notes, see page 55.**

Warning!

Monitor the closing procedure carefully to make sure no one is in danger of being injured. To prevent possible personal injury, always keep hands and fingers away from the cargo compartment opening when closing the tailgate. Be especially careful when small children are around. To stop the closing procedure, do one of the following:

- Press or pull the remote tailgate opening/closing switch on the driver's door.
- Press the tailgate closing switch.
- Press the KEYLESS-GO locking/closing switch.
- Pull outside handle on the tailgate.
- When no SmartKey is inserted in the starter switch (vehicles with KEYLESS-GO: Make sure the vehicle's on-board electronics have status **0**): Press button  on the SmartKey.

You can close the tailgate and lock the vehicle simultaneously from the outside using the KEYLESS-GO locking/closing switch.



- ▶ Make sure you have the SmartKey with you.
- ▶ Press KEYLESS-GO locking/closing switch  briefly. The tailgate closes. Once the tailgate and all doors are closed:

- The vehicle locks.
- The turn signals flash three times to confirm locking.
- The locking knobs in the doors move down.
- The anti-theft alarm system is armed.

If the tailgate comes into contact with an object while closing, the closing procedure is stopped and the tailgate reopens. This may happen if luggage has been piled too high, for example.

The closing process is stopped if the system cannot recognize a SmartKey with KEYLESS-GO anymore. Make sure the SmartKey with KEYLESS-GO is within approximately 3 ft (1 m) of the tailgate. Repeat the closing procedure if necessary.

The tailgate remains unlocked when a SmartKey with KEYLESS-GO is recognized inside the vehicle to prevent a possible inadvertent lockout. In this case, the turn signals will not flash and the anti-theft alarm will be triggered when the tailgate is opened.

Opening/closing the tailgate from the inside

Opening

 **Observe Safety notes, see page 76.**

Warning!

Maintain sight of the area around the rear of the vehicle while operating the tailgate with the door-mounted remote tailgate switch. Monitor the opening procedure carefully to make sure no one is in danger of being injured.

To interrupt the opening procedure, press or pull the door-mounted remote tailgate switch. When the SmartKey is not inserted in the starter switch (vehicles with KEYLESS-GO: Make sure the vehicle's on-board electronics have status 0): Press button  on the SmartKey.

You can unlock and open the tailgate simultaneously from the driver's seat when the vehicle is stationary.



- ▶ Pull remote tailgate opening/closing switch  until the tailgate begins to open. While the tailgate is opening, an acoustic warning sounds.

Closing



 **Observe Safety notes, see page 55.**

Warning!

Maintain sight of the area around the rear of the vehicle while operating the tailgate with the door-mounted remote tailgate switch. Monitor the closing procedure carefully to make sure no one is in danger of being injured.

To interrupt the closing procedure, press or pull the door-mounted remote tailgate switch.

If the tailgate comes into contact with an object while closing, the closing procedure is stopped and the tailgate reopens. This may happen if luggage has been piled too high, for example.

- ▶ Turn the SmartKey in the starter switch to position **1** or **2**.
- ▶ Press remote tailgate opening/closing switch  until the tailgate begins to close. While the tailgate is closing an acoustic warning sounds.
- ▶ **Interrupting the closing procedure:** Press or pull remote tailgate opening/closing switch .

Limiting opening height of tailgate

You can limit the opening height of the tailgate in the upper opening range. This can be useful, for example, when the space above the tailgate is not sufficient.

Activating

- ▶ **Open the tailgate:** Pull on handle (▷ page 75) or press and hold button  on the SmartKey until the tailgate opens.
- ▶ **Stop opening procedure:** When the tailgate is in the desired position, press tailgate closing switch (▷ page 77) or pull on handle once more.
- ▶ You can also press or pull the remote tailgate opening/closing switch (▷ page 78) to stop the opening procedure.
- ▶ Press and hold the tailgate closing switch in the tailgate (▷ page 77) until you hear a short acoustic signal.
The opening height of the tailgate is limited. The tailgate will now stop at the stored position when opened.

Deactivating

- ▶ Press and hold the tailgate closing switch in the tailgate (▷ page 77) until you hear two short, consecutive acoustic signals.

Starter switch positions

SmartKey

 **Observe Safety notes, see page 55.**



Starter switch

- 0** For removing SmartKey
- 1** Power supply for some electrical consumers, e.g. radio
- 2** Ignition (power supply for all electrical consumers) and driving position
- 3** Starting position

When you switch on the ignition, all lamps (except low-beam headlamp indicator lamp, high-beam headlamp indicator lamp, and turn signal indicator lamps unless activated) in the instrument cluster come on. If a lamp in the instrument cluster fails to come on when the ignition is switched on, have it checked and replaced if necessary. If a lamp in the instrument cluster remains on after starting the engine or comes on while driving, refer to “Lamps in instrument cluster” (▷ page 297).

- ▶ Always remove the SmartKey from the starter switch when the engine is not in operation.
This will help to prevent accelerated vehicle battery discharge or a completely discharged vehicle battery.

If the SmartKey cannot be turned in the starter switch, the vehicle battery may not be sufficiently charged.

- ▶ Check the vehicle battery and charge it if necessary.

or

► Get a jump start.

i If the SmartKey does not belong to the vehicle, the SmartKey can be turned in the starter switch. However, the ignition does not switch on and the engine does not start.

KEYLESS-GO

⚠ Observe Safety notes, see page 55.

Vehicles equipped with the KEYLESS-GO feature are supplied with a SmartKey with integrated KEYLESS-GO function and a removable KEYLESS-GO start/stop button. The KEYLESS-GO start/stop button must be inserted in the starter switch and the SmartKey present in the vehicle.

Pressing the KEYLESS-GO start/stop button without depressing the brake pedal corresponds to the various starter switch positions (► page 79).

Pressing the KEYLESS-GO start/stop button with the brake pedal firmly depressed will start the engine (► page 103).

The KEYLESS-GO start/stop button can be pulled out of the starter switch easily. You can then insert the SmartKey into the starter switch.

i The KEYLESS-GO start/stop button does not need to be removed from the starter switch when you leave the vehicle. However, always take the SmartKey with you when you leave the vehicle. As long as the SmartKey is in the vehicle, the vehicle's electrical systems can be switched on or the engine can be started using the KEYLESS-GO start/stop button.



- ① KEYLESS-GO start/stop button
- ② Starter switch

- Insert the KEYLESS-GO start/stop button into the starter switch (if not inserted already).
- Make sure the automatic transmission is in park position **P**.
- Do not depress the brake pedal.



KEYLESS-GO start/stop button

- ③ USA only
- ④ Canada only

Position 0

Before you press the KEYLESS-GO start/stop button, the vehicle's on-board electronics have status **0** (as with SmartKey removed).

Position 1

- Press the KEYLESS-GO start/stop button once.
This supplies power for some electrical consumers, such as radio functions.

- i** If you now press the KEYLESS-GO start/stop button
- once more, the ignition (position **2**) is switched on
 - twice more the power supply is again switched off

Ignition (or position 2)

- Press the KEYLESS-GO start/stop button twice.
This supplies power for all electrical consumers.
- All lamps (except low-beam headlamp indicator lamp, high-beam headlamp indicator lamp, and turn signal indicator lamps unless activated) in the instrument cluster come on. If a lamp in the instrument cluster fails to come on when the ignition is switched on, have it checked and replaced if necessary. If a lamp in the instrument cluster remains on after starting the engine or comes on while driving, refer to “Lamps in instrument cluster” (► page 297).
- i** If you now press the KEYLESS-GO start/stop button once, the power supply is again switched off.

Seats

Safety notes

Warning!

In order to avoid possible loss of vehicle control the following must be done before the vehicle is put into motion:

- seat adjustment
- head restraint adjustment
- steering wheel adjustment
- rear view mirror adjustment
- fastening of seat belts

Warning!

Do not adjust the driver's seat while driving. Adjusting the seat while driving could cause the driver to lose control of the vehicle.

Never ride in a moving vehicle with the seat backrest in an excessively reclined position as this can be dangerous. You could slide under the seat belt in a collision. If you slide under it, the seat belt would apply force at the abdomen or neck. That could cause serious or fatal injuries. The seat backrest and seat belts provide the best restraint when the wearer is in a position that is as upright as possible and seat belts are properly positioned on the body.

Warning!

Your seat must be adjusted so that you can correctly fasten your seat belt.

Observe the following points:

- Adjust the seat backrest until your arms are slightly angled when holding the steering wheel.
- Adjust the seat to a comfortable seating position that still allows you to reach the accelerator/brake pedal safely. The position should be as far back as possible with the driver still able to operate the controls properly.
- Adjust the head restraint so that it is as close to the head as possible. The center of the head restraint must support the back of the head at eye level.
- Never place hands under the seat or near any moving parts while a seat is being adjusted.

Failure to do so could result in an accident and/or serious personal injury.

Warning!

The power seats can be operated at any time. Therefore, do not leave children unattended in the vehicle, or with access to an unlocked vehicle. A child's unsupervised access to a

vehicle could result in an accident and/or serious personal injury.

Warning!

According to accident statistics, children are safer when properly restrained in the rear seating positions than in the front seating position. Thus, we strongly recommend that children be placed in the rear seats whenever possible. Regardless of seating position, children 12 years old and under must be seated and properly secured in an appropriately sized infant restraint, toddler restraint, or booster seat recommended for the size and weight of the child. For additional information, see “Children in the vehicle”.

A child’s risk of serious or fatal injuries is significantly increased if the child restraints are not properly secured in the vehicle and/or the child is not properly secured in the child restraint.

Warning!

For your protection, drive only with properly positioned head restraints.

Adjust the head restraint so that it is as close to the head as possible and the center of the head restraint supports the back of the head at eye level. This will reduce the potential for injury to the head and neck in the event of an accident or similar situation.

Do not drive the vehicle without the seat head restraints. Head restraints are intended to help reduce injuries during an accident.

Seat adjustment

-  When moving the seats, make sure there are no items in the footwell or behind the seats. Otherwise, you could damage the seats and/or the items.

Power seats

-  When the rear seats are folded forward, e.g. for cargo volume expansion, the front

seats may not be moved to the rearmost position. Otherwise you could damage the front and rear seats.

-  When adjusting the seat backrest tilt and head restraint height, make sure the sun visor is folded up. If the head restraint is in the uppermost position, it could hit and damage the sun visor.

-  Vehicles without memory function:
The seats can be adjusted within 5 minutes after either front door has been opened. The counter resets each time

- you open or close a front door
- you insert the SmartKey into the starter switch
- you remove the SmartKey from the starter switch
- you switch the ignition on or off

Just like in vehicles with memory function, the power seats can be operated at any time when the ignition is switched on.

-  The memory function (▷ page 92) lets you store the settings for the seat position together with the settings for the steering wheel (electrical) and exterior rear view mirrors.



- ▶ **Seat fore and aft adjustment:** Press the switch forward or backward in direction of arrow ⑤.
- ▶ **Seat backrest tilt:** Press the switch forward or backward in direction of arrow ④.
- ▶ **Seat height:** Press the switch up or down in direction of arrow ③.
- ▶ **Seat cushion tilt:** Press the switch up or down in direction of arrow ② until your upper legs are lightly supported.
- ▶ **Head restraint height (vehicles with memory function):** Press the switch up or down in direction of arrow ①.

Head restraint height adjustment, manual

This feature is only available in vehicles without memory function.

⚠ Warning!

For your protection, drive only with properly positioned head restraints.

Adjust the head restraint so that it is as close to the head as possible and the center of the head restraint supports the back of the head at eye level. This will reduce the potential for injury to the head and neck in the event of an accident or similar situation.

Do not drive the vehicle without the seat head restraints. Head restraints are intended to help reduce injuries during an accident.

With a rear seat occupied, make sure to move the respective head restraint up from the lowest non-use position and have the occupant adjust the head restraint properly.

! Do not attempt to remove front seat head restraints. They can only be removed by qualified technicians. We recommend that you have this work carried out by an authorized Mercedes-Benz Center.

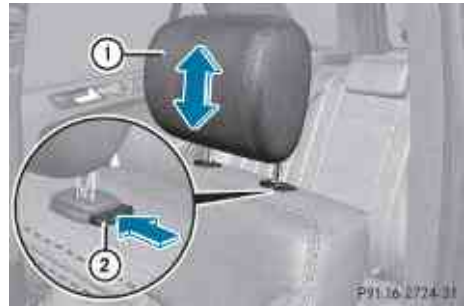

- ▶ **Raising:** Adjust the height of head restraint ① by pulling it upward. If head restraint ① is fully retracted, press release button ② in direction of arrow and pull head restraint ① upward.
- ▶ **Lowering:** Press release button ② in direction of arrow and press down on head restraint ①.

Head restraint fore and aft adjustment

⚠ Warning!

Vehicles with Rear Seat Entertainment System: When adjusting the head restraint, make sure your fingers do not become caught between the head restraint cushion and the monitor. Failing to do so may lead to injury.



- ▶ While seated, reach behind you with both hands and find lower edge of the head restraint.
- ▶ Push or pull on the lower edge of the head restraint cushion to the desired position.

Lumbar support

You can adjust the contour of the driver's seat lumbar support to help enhance support to your spine.

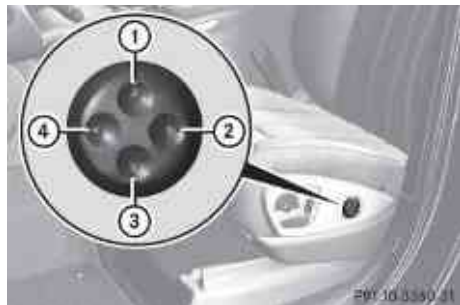

- ▶ **Curvature position:** Use button ① to move the curvature up and button ③ to move it down.
- ▶ **Degree of curvature:** Use button ② to lessen the curvature and button ④ to increase it.

Rear seat head restraints

Warning!

For your protection, drive only with properly positioned head restraints.

Adjust the head restraint in such a way that it is as close to the head as possible and the center of the head restraint supports the back of the head at eye level. This will reduce the potential for injury to the head and neck in the event of an accident or similar situation.

With a rear seat occupied, make sure to move the respective head restraint up from the lowest non-use position and have the occupant adjust the head restraint properly.

Do not drive the vehicle without the seat head restraints installed when the rear seats are occupied. Head restraints are intended to help reduce injuries during an accident.

Warning!

Make sure the rear seat head restraints engage when placing them upright manually. Otherwise their protective function cannot be ensured.

The back of the head will not be supported in the event of a collision. That could cause serious or even fatal injuries. Rear seat occupants can be seriously injured or killed.

Rear seat head restraint height adjustment

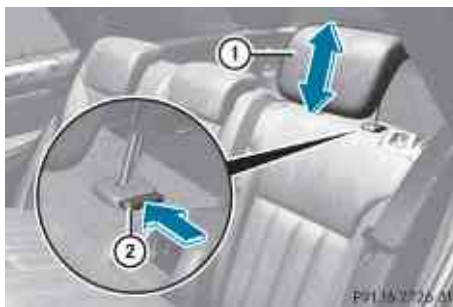

- ▶ **Raising:** Pull head restraint ① upward to the desired position.
- ▶ **Lowering:** Press release button ② and push down on head restraint ①.

Rear seat head restraint fore and aft adjustment



- ▶ While seated, reach behind you with both hands and find lower edge of the head restraint.
- ▶ Adjust the head restraint to the desired position by pushing or pulling on the lower edge of the head restraint cushion.

Rear seat head restraints, removing and installing

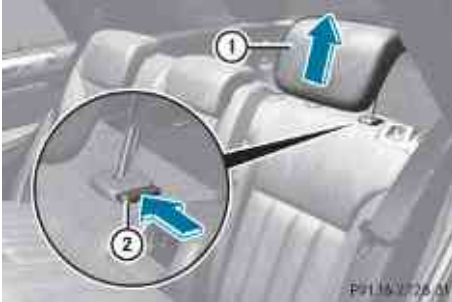

- ▶ **Removing:** Pull head restraint ① to its uppermost position.
- ▶ Press release button ② and pull out head restraint.
- ▶ **Installing:** Insert head restraint ① into openings on the seat backrest.
- ▶ Push head restraint ① down until it audibly engages.
- ▶ Press release button ② and adjust head restraint ① to the desired position.

Multicontour seats

The multicontour seat has a movable seat cushion and inflatable air cushions built into the seat backrest to provide additional lumbar and side support.

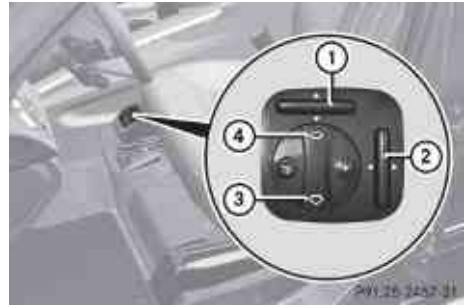

- ▶ Switch on the ignition.
- ▶ **Seat cushion depth:** Adjust the seat cushion depth to the length of your upper leg using switch ①.
- ▶ **Seat backrest contour:** Adjust the contour of the seat backrest to the desired position using + or -.
- ▶ Move the seat backrest support cushion to the bottom with button ④ or to the center with button ③.
- ▶ **Seat backrest side bolsters:** Adjust the side bolsters so that they provide good lateral support using switch ②.

Seat ventilation



The blue indicator lamps ② in seat ventilation switch ① come on to show which ventilation level you have selected.

- ▶ **i** The seat ventilation for the driver's seat can be activated using the summer opening feature (▶ page 102).

- ▶ Switch on the ignition.
- ▶ **Switching on:** Press respective seat ventilation switch ①.
Three blue indicator lamps ② in seat ventilation switch ① come on.
- ▶ Press seat ventilation switch ① repeatedly until the desired ventilation level is set.
- ▶ **Switching off:** Press seat ventilation switch ① repeatedly until all indicator lamps ② go out.

If there is insufficient voltage the seat ventilating switches off automatically.

Seat heating

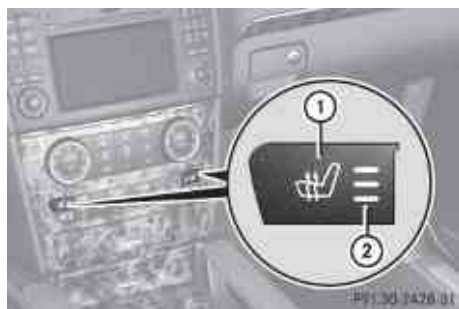

Front seat heating switches

The switches for the outboard rear seat heating are located in the rear center console.



Rear seat heating switches

The red indicator lamps ② in front or rear seat heating switch ① come on to show which heating level you have selected.

The seat heating switches from level **3** (high) to level **2** after approximately 5 minutes. The seat heating switches from level **2** to level **1** (low) after approximately 10 minutes. After approximately 20 minutes in level **1**, the seat heating switches off automatically.

- ▶ Switch on the ignition.
- ▶ **Switching on:** Press respective seat heating switch ①.
Three red indicator lamps ② in the respective seat heating switch ① come on.
- ▶ Continue pressing respective seat heating switch ① until desired seat heating level is reached.
- ▶ **Switching off:** Press respective seat heating switch ① repeatedly until all indicator lamps ② go out.

If one or more of indicator lamps ② in respective seat heating switch ① are flashing, there is insufficient voltage available since too many electrical consumers are turned on. The seat heating switches off automatically.

The seat heating will switch back on again automatically as soon as sufficient voltage is available.

Multifunction steering wheel

Safety notes

Warning!

Do not adjust the steering wheel while driving. Adjusting the steering wheel while driving, or driving without the steering wheel adjustment feature locked could cause the driver to lose control of the vehicle.

The electrical steering wheel adjustment feature can be operated at any time. Therefore, do not leave children unattended in the vehicle, or with access to an unlocked vehicle. A child's unsupervised access to a vehicle could result in an accident and/or serious personal injury.

Make sure

- you can reach the steering wheel with your arms slightly bent at the elbows
- you can move your legs freely
- all displays (including malfunction and indicator lamps) on the instrument cluster are clearly visible

Steering wheel adjustment, manual



- ▶ **Unlocking:** Pull release handle ① out to its stop limit.
- ▶ Move steering wheel to the desired position.
- ▶ **Locking:** Push release handle ① back to its original position.
- ▶ Make sure the steering wheel is securely locked by trying to move it up and down as well as in and out before driving off.

Steering wheel adjustment, electrical

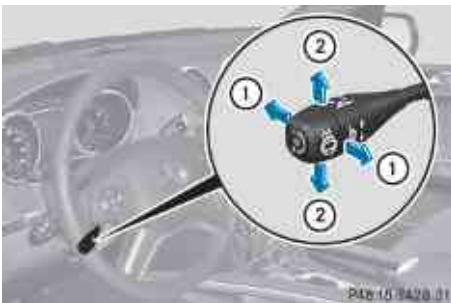

- ▶ **Adjusting steering wheel in or out:** Move stalk in direction of arrows ①.
- ▶ **Adjusting steering wheel up or down:** Move stalk in direction of arrows ②.

❗ You can store the settings for the steering wheel with the memory function (▷ page 92).

Easy-entry/exit feature

This feature allows the driver an easier entry into and exit from the vehicle. When entering and exiting the vehicle, the steering wheel is in its uppermost position.

The easy-entry/exit feature can be activated or deactivated in the **Comfort** submenu of the control system (▷ page 135).

⚠ Warning!

You must make sure no one can become trapped or injured by the moving steering wheel when the easy-entry/exit feature is activated.

To stop steering wheel movement do one of the following:

- Move steering wheel adjustment stalk.
- Press one of the memory position buttons.
- Press memory button **M**.

Do not leave children unattended in the vehicle, or with access to an unlocked vehicle. Children could open the driver's door and unintentionally activate the easy-entry/exit feature, which could result in an accident and/or serious personal injury.

With the easy-entry/exit feature activated, the steering wheel will return to its last set position when you close the driver's door with the ignition switched on. The steering wheel will also return to its last set position when you insert the SmartKey into the starter switch or press the KEYLESS-GO start/stop button once with the driver's door closed.

- i** The last set steering wheel position is stored when the ignition is switched off or the position is stored in memory (> page 92).

With the easy-entry/exit feature activated, the steering wheel tilts upwards when you remove the SmartKey from the starter switch. The steering wheel also tilts upwards when you open the driver's door with the SmartKey in starter switch position **0** or **1** or the KEYLESS-GO start/stop button in position **1**.

- i** When the current position for the steering wheel is in the uppermost tilt position, the steering wheel will no longer be able to move upward when the easy-entry/exit feature is activated.

The adjustment procedure is briefly interrupted when the engine is started.

Warning!

Let the system complete the adjustment procedure before setting the vehicle in motion. All steering wheel adjustment must be completed before setting the vehicle in motion. Driving off with the steering wheel still adjusting could cause the driver to lose control of the vehicle.

Crash-responsive exit aid

When you open the driver's door after an accident has occurred, the steering column moves up. The position of the SmartKey in the starter switch is insignificant. This function facilitates exiting as well as rescue of vehicle occupants.

The crash-responsive exit aid can only be triggered when the easy-entry/exit feature is activated via the control system.

Heated steering wheel

The steering wheel heating warms up the leather area of the steering wheel.



- ▶ Switch on the ignition.
- ▶ **Switching on:** Turn switch at the tip of the stalk in direction of arrow ①. Indicator lamp ③ comes on.

- i** The steering wheel heating may be suspended temporarily. However, indicator lamp ③ remains on. The steering wheel heating is suspended when the temperature of the vehicle interior is above 86°F (30°C). It is also suspended when the temperature of the steering wheel is above 95°F (35°C).

When these conditions do not apply anymore, steering wheel heating continues.

- ▶ **Switching off:** Turn switch at the tip of stalk in direction of arrow ②. Indicator lamp ③ goes out.

- i** Indicator lamp ③ flashes or goes out in case of power surge or undervoltage or if the steering wheel heating malfunctions.

- i** The steering wheel heating switches off automatically when you remove the SmartKey from the starter switch or, on vehicles with KEYLESS-GO, when you switch off the ignition and open the driver's door.

For more information on the steering wheel, see "Multifunction steering wheel" (> page 119).

Mirrors

Notes

Adjust the interior and exterior rear view mirrors before driving so that you have a good view of the road and traffic conditions.

Interior rear view mirror

- ▶ Adjust the interior rear view mirror manually.

Interior rear view mirror, antiglare position



- ▶ Tilt the mirror to the antiglare position by moving lever ① towards the windshield. The interior rear view mirror is dimmed.

Exterior rear view mirrors

⚠ Warning!

Exercise care when using the passenger-side exterior rear view mirror. The mirror surface is convex (outwardly curved surface for a wider field of view). Objects in mirror are closer than they appear. Check your interior rear view mirror and glance over your shoulder before changing lanes.

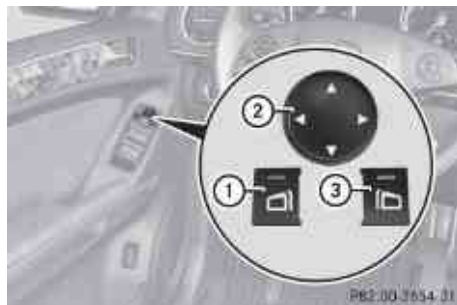

- ▶ Switch on the ignition.
- ▶ Press button ① for the driver's side exterior rear view mirror or button ③ for the passenger-side exterior rear view mirror. The indicator lamp in the respective button comes on for approximately 15 seconds. If you do not make adjustments to the selected exterior rear view mirror within 15 seconds, the indicator lamp goes out. You will then have to select the desired exterior rear view mirror again before adjustments can be made. Adjustments can only be made with the indicator lamp for the respective exterior rear view mirror button illuminated.
- ▶ Press adjustment button ② up, down, left or right according to the desired setting.

❗ If an exterior rear view mirror was forcibly hit from the front, manually snap it back into place.

❗ Vehicle with power-folding exterior rear view mirrors:

If an exterior rear view mirror housing is forcibly pushed forward (hit from the rear) or forcibly pushed rearward (hit from front), press fold button to fold mirrors in, then press fold button again to fold mirrors out. Do not force mirrors by hand as this may damage the adjustment mechanism.

The mirror housing is then properly positioned and you can adjust the mirror in the usual manner.

- At low ambient temperatures, the exterior rear view mirrors will be heated automatically.

Auto-dimming rear view mirrors

The exterior rear view mirror on the driver's side and the interior rear view mirror will respond automatically to glare when the ignition is switched on and incoming light from headlamps falls on the sensor in the interior rear view mirror.

The rear view mirrors will not react if the automatic transmission is set to reverse gear **R** or the interior lighting is switched on.

Warning!

The auto-dimming function does not react if incoming light is not aimed directly at sensors in the interior rear view mirror.

The interior rear view mirror and the exterior rear view mirror on the driver's side do not react, for example, when transporting cargo which covers the rear window.

Light hitting the mirror(s) at certain angles (incident light) could blind you. As a result, you may not be able to observe traffic conditions and could cause an accident.

Exterior rear view mirror parking position

For more convenient parking, you can set the passenger-side exterior rear view mirror so that you can see the rear wheel and the road curb.

Setting and storing the parking position

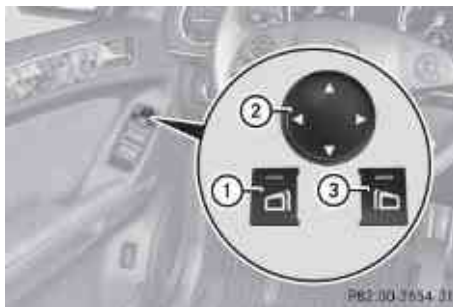

- Switch on the ignition.
- Press button ③, to select the passenger-side exterior rear view mirror.
- Shift the automatic transmission into reverse gear **R**.
The passenger-side exterior rear view mirror moves to the preset parking position.
- Adjust the passenger-side exterior rear view mirror with adjustment button ② so that you see the rear wheel and the road curb.
The exterior rear view mirror parking position is stored.

Calling up the parking position

- Switch on the ignition.
- Press button ③, to select the passenger-side exterior rear view mirror.
- Shift the automatic transmission into reverse gear **R**.
The passenger-side exterior rear view mirror moves to the stored parking position.

The passenger-side exterior rear view mirror returns to its previously stored driving position

- 10 seconds after you have put the gear selector lever out of reverse gear **R**
- immediately once your vehicle exceeds a speed of approximately 6 mph (10 km/h)
- immediately when you press button ① to select the driver's side exterior rear view mirror

Power-folding exterior rear view mirrors

! Before you drive the vehicle through an automatic car wash, fold in the exterior rear view mirrors. Otherwise they may get damaged.

Folding in and out automatically

The function must be activated in the Convenience submenu (▷ page 137).

The exterior rear view mirrors fold in automatically as soon as the vehicle is locked from the outside.

The exterior rear view mirrors fold out automatically as soon as the vehicle is unlocked and the driver's or front passenger door is subsequently opened.

Synchronizing

The power-folding rear view mirrors may have to be synchronized after the vehicle battery has been disconnected or discharged. If the exterior rear view mirrors do not fold properly upon locking or unlocking the vehicle, do the following:

- ▶ Make sure the power-folding function in the control system is activated (▷ page 137).
- ▶ **When the power-folding function is activated and the exterior rear view mirrors still do not fold properly:** Fold

each exterior rear view mirror in completely (▷ page 91).

- ▶ Fold each exterior rear view mirror out completely (▷ page 91).

When the exterior rear view mirrors fold properly upon locking the vehicle, the exterior mirrors are synchronized. Otherwise repeat the above steps.

Folding in and out manually

The exterior rear view mirrors can vibrate if they are not folded out completely.



- ▶ Switch on the ignition.
- ▶ **Folding in:** Briefly press button ①. Both exterior rear view mirrors fold in.
- i** At speeds above approximately 30 mph (47 km/h), you will not be able to fold the exterior mirrors in.
- ▶ **Folding out:** Briefly press button ①. Both exterior rear view mirrors fold out.
- !** If an exterior rear view mirror housing is forcibly pushed forward (hit from the rear) or forcibly pushed rearward (hit from the front), press button ① to fold mirrors in. Then press button ① again to fold mirrors out. Do not force mirrors by hand as this may damage the adjustment mechanism. The mirror housing is then properly positioned and you can adjust the mirror in the usual manner. Make sure both rear view mirrors are folded out before driving off.

Memory function

Notes

With the memory function you can store up to three different configurations per front seat.

Each memory position button on the driver's side can store all of the following settings:

- Seat position
- Steering wheel position
- Exterior rear view mirrors' position

Warning!

Do not activate the memory function while driving. Activating the memory function while driving could cause the driver to lose control of the vehicle.

Each memory position button on the front passenger side can store the setting of the seat position.



Storing positions into memory

- ▶ Adjust the seats.
- ▶ On the driver's side, also adjust the steering wheel and exterior rear view mirrors to the desired positions.
- ▶ Press memory button **M** once and within 3 seconds press memory position button **1**, **2** or **3**.

When the settings are stored to the selected position, an acknowledgement signal sounds.

Recalling positions from memory

- ▶ Press and hold desired memory position button **1**, **2** or **3** until the seat has moved to the stored position completely. On the driver's side, also wait for the steering wheel and exterior rear view mirrors to move to the stored position.
- i** Releasing the memory position button stops movement to the stored positions immediately.

Lighting

Notes

- i** If you drive in countries with left-hand driving, you must have the headlamps modified for symmetrical low beams. Relevant information can be obtained at any authorized Mercedes-Benz Center.
- i** Vehicles equipped with active Bi-Xenon headlamps:

The active Bi-Xenon headlamps increase usable illumination over conventional headlamps because they follow the curvature of the road ahead. The beams of the active Bi-Xenon headlamps shift to either side according to the vehicle's steering angle and speed.

Exterior lamp switch



- 1 Standing lamps, left
- 2 Standing lamps, right
- 3 Off
Daytime running lamp mode
- 4 Automatic headlamp mode
Daytime running lamp mode
- 5 Parking lamps (also tail lamps, license plate lamps, side marker lamps and instrument panel lamps)
- 6 Low-beam headlamps or high-beam headlamps
- 7 Front fog lamps
- 8 Rear fog lamp

i The exterior lamps (except standing lamps or parking lamps) go out automatically when you remove the SmartKey from the starter switch or open the driver's door with the ignition switched off.

When the parking lamps or the rear fog lamp are switched on and you remove the SmartKey from the starter switch and open the driver's door, an acoustic signal sounds.

In addition the message **Switch Off Lights** appears in the multifunction display.

Switch off the parking lamps or the rear fog lamp manually.

! Failure to switch off the parking lamps when leaving the vehicle may result in a discharged battery.

Low-beam headlamps

The low-beam headlamps can be switched on and off with the exterior lamp switch.

- ▶ Switch on the ignition.
- ▶ **Switching on:** Turn the exterior lamp switch to position .

The following lamps come on:

- Low-beam headlamps
- Tail lamps
- Parking lamps
- License plate lamps
- Side marker lamps
- Instrument panel lamps
- Green indicator lamp in the instrument cluster

- ▶ **Switching off:** Turn the exterior lamp switch to position .

Automatic headlamp mode

The following lamps come on and go out automatically depending on the brightness of the ambient light:



- Low-beam headlamps
- Tail lamps
- Parking lamps
- License plate lamps
- Side marker lamps

Warning!

If the exterior lamp switch is set to **AUTO**, the headlamps will not automatically come on under foggy conditions.

To minimize risk to you and to others, activate headlamps by turning exterior lamp switch to when driving or when traffic and/or

ambient lighting conditions require you to do so.

In low ambient lighting conditions, only switch from position **AUTO** to  with the vehicle at a standstill in a safe location. Switching from **AUTO** to  will briefly switch off the headlamps. Doing so while driving in low ambient lighting conditions may result in an accident.

The automatic headlamp feature is only an aid to the driver. The driver is responsible for the operation of the vehicle's lights at all times.

- **Switching on:** Turn the exterior lamp switch to position **AUTO**.

The following lamps come on and go out depending on the brightness of the ambient light with the SmartKey in starter switch position **1** or the KEYLESS-GO start/stop button pressed once:

- tail lamps
- parking lamps
- license plate lamps
- side marker lamps

When the engine is running, the low-beam headlamps will also come on and turn off automatically.

Canada only: High-beam headlamps are only available with the exterior lamp switch in position .

Daytime running lamp mode

In Canada, the daytime running lamp mode is mandatory and therefore in a constant mode.

In the USA, the daytime running lamp mode is deactivated by default.

- Activate the daytime running lamp mode using the control system, see "Switching

daytime running lamp mode on or off (USA only)" (▷ page 133).

- Turn the exterior lamp switch to position **0** or **AUTO**.

When the engine is running, the low-beam headlamps come on.

In low ambient lighting conditions, the following lamps will come on additionally:

- Tail lamps
- Parking lamps
- License plate lamps
- Side marker lamps

With the daytime running lamp mode activated and the engine running, you cannot switch off the low-beam headlamps manually.



Canada only

With the exterior lamp switch in position **0** or **AUTO**, you cannot switch on the high-beam headlamps.

The high-beam flasher is available at all times.

- For nighttime driving turn the exterior lamp switch to position  to permit activation of the high-beam headlamps.

When the engine is running, and you



- shift from a driving position to park position **P** with the vehicle at a standstill or the parking brake is engaged, the low-beam headlamps will go out with a delay of 3 minutes
- turn the exterior lamp switch to position , the low-beam headlamps, the tail and parking lamps, the license plate lamps and the side marker lamps come on
- turn the exterior lamp switch to position , the manual headlamp mode has priority over the daytime running lamp mode

The corresponding exterior lamps come on (▷ page 93).

USA only

You can only switch on the high-beam headlamps in low ambient lighting conditions. The high-beam flasher is available at all times.

- ▶ For nighttime driving turn the exterior lamp switch to position  or **AUTO** to permit activation of the high-beam headlamps.

When the engine is running, and you turn the exterior lamp switch to position  or , the manual headlamp mode has priority over the daytime running lamp mode.

The corresponding exterior lamps come on (▷ page 93).

Fog lamps



Fog lamps cannot be switched on with the exterior lamp switch in position **AUTO**.

Warning!

In low ambient lighting or foggy conditions, only switch from position **AUTO** to  with the vehicle at a standstill in a safe location.

Switching from **AUTO** to  will briefly switch off the headlamps. Doing so while driving in low ambient lighting conditions may result in an accident.

Fog lamps will operate with the parking lamps and/or the low-beam headlamps on. Fog lamps should only be used in conjunction with low-beam headlamps. Consult your State or Province Motor Vehicle Regulations regarding permissible lamp operation.

- ▶ Switch on the ignition.
- ▶ Turn the exterior lamp switch to position  or  (▷ page 93).
- ▶ **Switching on front fog lamps:** Pull out the exterior lamp switch to first stop. The green indicator lamp  in the exterior lamp switch comes on.

- ▶ **Switching on rear fog lamp:** Pull out the exterior lamp switch to second stop. The rear fog lamp, the front fog lamps, the green and the yellow indicator lamp  in the exterior lamp switch come on.
- ▶ **Switching off front fog lamps/rear fog lamp:** Push in the exterior lamp switch to its stop.





Locator lighting and night security illumination

Locator lighting and night security illumination are described in the “Control system” section, see “Switching locator lighting on or off” (▷ page 133) and “Switching night security illumination (Headlamps delayed shut-off feature) on or off” (▷ page 134).

Combination switch



Turn signals



- ▶ Press the combination switch in direction of arrow  or .
- The corresponding turn signal indicator lamp  or  in the instrument cluster flashes.

The combination switch resets automatically after major steering wheel movements.

- i** To signal minor directional changes such as changing lanes, press the combination switch only to point of resistance and

release. The corresponding turn signal lamps will flash three times.

High beam

- ▶ Turn the exterior lamp switch to position  (▷ page 93).
 - ▶ **Switching on:** Push the combination switch in direction of arrow ①. The high-beam headlamp indicator lamp  in the instrument cluster comes on.
 - ▶ **Switching off:** Pull the combination switch in direction of arrow ③ to its original position.
- i** Also note the information on high-beam headlamps with activated automatic headlamp mode (▷ page 93) or the daytime running lamp mode (▷ page 94).

High-beam flasher

- ▶ **Switching on:** Pull the combination switch briefly in direction of arrow ③.

Hazard warning flasher

The hazard warning flasher can be switched on at all times, even with the SmartKey removed from the starter switch.

The hazard warning flasher comes on automatically when an air bag deploys.

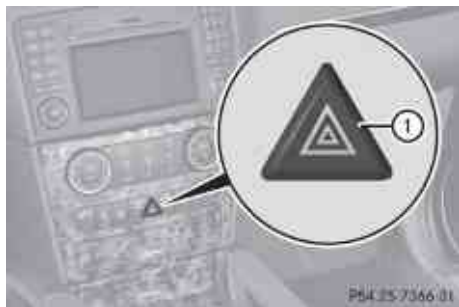

- ▶ **Switching on:** Press hazard warning flasher switch ①. All turn signal lamps are flashing.

i With the hazard warning flasher activated and the combination switch set for either left or right turn, only the respective left or right turn signals will operate when the ignition is switched on.

- ▶ **Switching off:** Press hazard warning flasher switch ① again.

i If the hazard warning flasher has been activated automatically, press hazard warning flasher switch ① to switch it off.

Headlamp cleaning system

The headlamps will be cleaned with a high-pressure water jet automatically when the engine is running and you have

- switched on the headlamps and
- the windshield wipers have wiped the windshield with washer fluid five times

The counter resets when you switch off the headlamps.

For information on filling up the washer reservoir, see “Washer system and headlamp cleaning system” (▷ page 217).

Corner-illuminating front fog lamps

The corner-illuminating front fog lamps improve illumination of the area in the direction into which you are turning.

The corner-illuminating front fog lamps will only operate

- in low ambient lighting conditions
- at vehicle speeds below 25 mph (40 km/h)

- with the front fog lamps switched off
- when the engine is running

Switching on

- ▶ Turn the exterior lamp switch to position  or **AUTO**.

or

- ▶ Activate the daytime running lamp mode (▷ page 94).
- ▶ Switch on the left or right turn signal, depending on whether you are turning left or right.

The respective front fog lamp comes on. If you have switched on the turn signal for one side but turn the steering wheel in the other direction, the corner-illuminating front fog lamp on the side of the turn signal comes on.

or

- ▶ Turn the steering wheel in the desired direction.
 Driving forward: The front fog lamp on the side of your steering direction comes on.
 Driving in reverse: The front fog lamp opposite to your steering direction comes on.

The corner-illuminating front fog lamps will come on automatically depending on the steering angle, even if you did not switch on either turn signal. If the corner-illuminating front fog lamps came on automatically, they will also go out automatically depending on the steering angle and vehicle speed.

The corner-illuminating front fog lamps temporarily come on on both sides of the vehicle if you turn the steering wheel in one direction and then again in the other direction shortly thereafter.

The corner-illuminating front fog lamp remains lit for a short time only. It then goes out automatically.





Switching off

- ▶ Switch off the left or right turn signal.
- or
- ▶ Steer straight ahead.

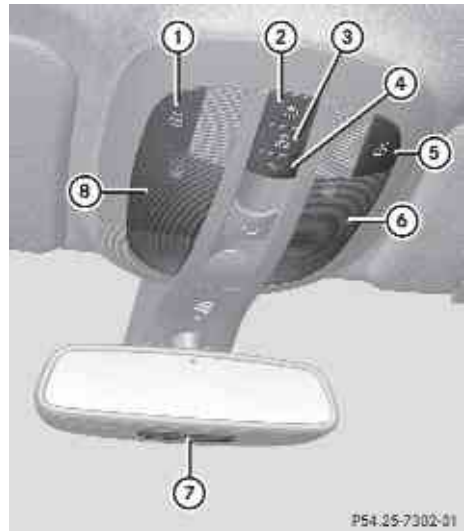

i There may be a brief delay before the corner-illuminating front fog lamps go out.

Interior lighting in the front



- ①  Left front reading lamp on/off
- ②  Rear interior lighting on/off
- ③  Automatic control on/off
- ④  Front interior lighting on/off
- ⑤  Right front reading lamp on/off
- ⑥ Front interior lighting
- ⑦ Front reading lamps
- ⑧ Front interior lighting



Automatic control

- ▶ **Activating:** Press button .
 Button  disengages and sits flush with the other buttons.
 The interior lighting comes on when you

- unlock the vehicle
- remove the SmartKey from the starter switch (Interior Lighting Delayed Shut-off must be switched on (▷ page 135))
- open a door
- open the tailgate



The interior lighting goes out after a short time.

i If a door remains open, the interior lamps go out automatically after approximately 5 minutes when the SmartKey is removed or in starter switch position **0**.

▶ **Deactivating:** Press button . Button  engages.

Manual control

! An interior lamp switched on manually does not go out automatically. Leaving an interior lamp switched on for an extended period of time with the engine turned off could result in a discharged battery.

- ▶ **Switching front interior lighting on/off:** Press switch .
- ▶ **Switching rear interior lighting on/off:** Press switch .
- ▶ **Switching front reading lamps on/off:** Press respective switch .

Emergency lighting

The interior lighting comes on automatically if the vehicle is involved in an accident.

Switching off:

- ▶ Press button .
- or
- ▶ Press hazard warning flasher switch (▷ page 96).
- or
- ▶ Unlock the vehicle with the SmartKey.

Interior lighting in the rear

! An interior lamp switched on manually does not go out automatically.

Leaving an interior lamp switched on for an extended period of time with the engine turned off could result in a discharged battery.



- ▶ **Switching rear reading lamps on/off:** Press reading lamp **1** where indicated by the arrow.

Wipers

Notes

! Do not operate the wipers when the windshield/rear window is dry. Dust that accumulates on a windshield/rear window might scratch the glass and/or damage the wiper blades when wiping occurs on a dry windshield/rear window. If it is necessary to operate the wipers in dry weather conditions, always operate the wipers with washer fluid.

Windshield wipers

- ▶ Observe notes on page (▷ page 98).

Switching on/off



Combination switch

- 1 0 Windshield wipers off
- 2 ... Slow intermittent wiping⁸
- 3 Fast intermittent wiping⁹
- 4 — Slow continuous wiping
- 5 = Fast continuous wiping
- 6 Single wipe/ Wiping with washer fluid

- ▶ Switch on the ignition.
- ▶ Turn the combination switch to the desired position, depending on the intensity of the rain.

Intermittent wiping

Only switch on intermittent wiping under wet weather conditions or in the presence of precipitation.

When you select intermittent wiping, the rain sensor is activated. The rain sensor sets a suitable wiping interval depending on the wetness of the sensor surface automatically.

! Do not leave windshield wipers on an intermittent setting when the vehicle is taken to an automatic car wash or during windshield cleaning. Windshield wipers will operate in the presence of water sprayed on the windshield, and windshield wipers may be damaged as a result.

⁸ Rain sensor operation with low sensitivity.

⁹ Rain sensor operation with high sensitivity.

! If you have set intermittent wiping, dirt on the surface of the rain sensor or optical effects may cause the windshield wipers to wipe in an undesired fashion. This could then damage the windshield wiper blades or scratch the windshield. You should therefore switch off the windshield wipers when weather conditions are dry.

- ▶ Turn the combination switch to position ... or After the initial wipe, pauses between wipes are controlled by the rain sensor automatically.

Intermittent wiping is interrupted when the vehicle is at a standstill and a front door is opened. This protects persons getting into or out of the vehicle from being sprayed.

Intermittent wiping will be continued when all doors are closed and

- the automatic transmission is in drive position **D** or reverse gear **R** or
- the wiper setting is changed using the combination switch

Single wipe

- ▶ Press the combination switch briefly in direction of arrow ⑥ to the resistance point. The windshield wipers wipe one time without washer fluid.

Wiping with washer fluid

- ▶ Press the combination switch in direction of arrow ⑥ past the resistance point. The windshield wipers operate with washer fluid.

i To prevent smears on the windshield or noisy/chattering wiper blades, wipe with washer fluid every now and then even when it is raining.

For information on filling up the washer reservoir, see “Washer system and headlamp cleaning system” (▷ page 217).

For information on cleaning the headlamps with washer fluid, see “Headlamp cleaning system” (▷ page 96).

Rear window wiper indicator  appears in the lower multifunction display when the rear window wiper is activated.

For information on filling up the washer reservoir, see “Washer system and headlamp cleaning system” (▷ page 217).



Rear window wiper/washer

► Observe notes on page (▷ page 98).

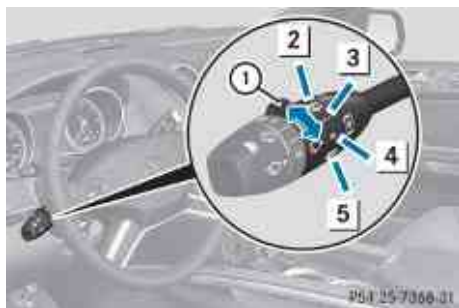
The rear window wiper engages automatically when the automatic transmission is shifted into reverse gear **R** with the windshield wipers switched on.



Combination switch

- ①  Rear window wiper switch
- ②  Wiping rear window with washer fluid
- ③ **I** Intermittent wiping
- ④ **0** Rear window wiper off
- ⑤  Wiping rear window with washer fluid

► Switch on the ignition.



► Turn rear window wiper switch  to the desired position.



Problems with wipers

I If anything blocks the wipers (leaves, snow, etc.), switch them off immediately. For safety reasons, do the following before attempting to remove any blockage:

- Stop the vehicle in a safe location.
- Remove the SmartKey from the starter switch.
- or
- Turn off the engine by pressing the KEYLESS-GO start/stop button and open the driver's door (with the driver's door open, starter switch is in position **0**, same as with SmartKey removed from starter switch).
- Engage the parking brake.
- Remove blockage.
- Turn the wipers on again.

If the windshield wipers fail to function at all with the combination switch in position  or ,

- set the combination switch to the next higher wiper speed
- have the windshield wipers checked at the nearest authorized Mercedes-Benz Center

Power windows

Opening and closing

The door windows are opened and closed electrically. The switches for all door windows are located on the driver's door control panel. The switches for the respective door windows

are located on the front passenger door and on the rear doors.

- i** Operating the rear door windows from the rear is not possible when you activate the override switch (▷ page 60).

⚠ Observe Safety notes, see page 55.

⚠ Warning!

When opening or closing the door windows, make sure there is no danger of anyone being harmed by the opening/closing procedure.

The door windows are equipped with the express operation and automatic reversal function. If in express operation mode a door window encounters an obstruction that blocks its path, the automatic reversal function will stop the door window and open it slightly.

The door windows operate differently when the switch is pulled and held. See the “Closing when a door window is blocked” section in this chapter for details.

The closing of the door windows can be immediately halted by releasing the switch or, if the switch was pulled past the resistance point and released, by either pressing or pulling the respective switch.

If a door window encounters an obstruction that blocks its path in a circumstance where you are closing the door windows by pressing and holding button  on the SmartKey or by pressing and holding the lock button (vehicles with KEYLESS-GO) on an outside door handle, the automatic reversal function will not operate.

Activate the override switch when children are riding in the back seats of the vehicle. The children may otherwise injure themselves, e.g. by becoming trapped in the door window opening.

⚠ Warning!

Do not keep any part of your body up against the window pane when opening a window. The downward motion of the pane may pull that

part of your body down between the window pane and the door frame and trap it there. If there is a risk of entrapment, release the switch and pull it to close the window.

- i** You can also open or close the door windows using the SmartKey, see “Summer opening feature” (▷ page 102) and “Convenience closing feature” (▷ page 102).
- i** After switching off the ignition or removing the SmartKey from the starter switch, you can operate the door windows until you open the driver’s or front passenger door. If no door was opened you can operate the door windows for up to 5 minutes.



- ▶ Switch on the ignition.
- ▶ **Opening/closing:** Press or pull and hold switch **①** to **④** to the resistance point. The corresponding door window moves downward or upward until you release the switch.
- ▶ **Express operation:** Press or pull switch **①** to **④** past the resistance point and release. The corresponding door window opens or closes completely.
- ▶ **Stopping during express operation:** Press or pull the respective switch again.

Closing when a door window is blocked

Warning!

Make sure that nobody can become trapped and be seriously or even fatally injured when closing a door window with greater force or without automatic reversal function.

If the upward movement of a door window is blocked during the closing procedure, the door window will stop and open slightly.

- ▶ Immediately after the door window has stopped because it was blocked, pull and hold the respective switch upward until the door window is fully closed. The door window closes with greater force.

If the door window is blocked again and opens slightly:

- ▶ Immediately after the door window was blocked, pull and hold the respective switch upward until the door window is fully closed. The door window closes without automatic reversal function.

Warning!

Pulling and holding the switch to close the door window immediately after it had been blocked two times will cause the door window to close without any reversal function for as long as you hold the switch.

Synchronizing door windows

The door windows must be synchronized after the battery has been disconnected or if the door windows cannot be fully closed (express operation).

Each door window must be synchronized separately.

- ▶ Close all doors.
- ▶ Switch on the ignition.



- ▶ Pull and hold switch ①, ②, ③ or ④ (▷ page 101) until the respective door window is closed. The door window opens again slightly.
- ▶ Pull and hold the respective switch once more immediately until the door window is closed completely.
- ▶ Hold the respective switch for approximately 1 second. The door window is synchronized.

Summer opening feature

When the weather is warm, you can ventilate the vehicle before driving off by simultaneously

- opening the door windows
- opening the tilt/sliding sunroof
- switching on the seat ventilation for the driver's seat (Canada only)

The summer opening feature can only be activated via the remote control of the SmartKey. The SmartKey must be in close proximity to the driver's outside door handle.

- ▶ Aim the transmitter eye of the SmartKey at the driver's outside door handle.
- ▶ Press and hold button  on the SmartKey until the door windows and the tilt/sliding sunroof have reached the desired position. The vehicle unlocks.
- ▶ Release button  on the SmartKey to interrupt the opening procedure.

Convenience closing feature



When locking the vehicle, you can simultaneously close the door windows and the tilt/sliding sunroof.

Warning!

When closing the door windows and the tilt/sliding sunroof, make sure there is no danger

of anyone being harmed by the closing procedure.

If potential danger exists, proceed as follows:



- Release button  to stop the closing procedure. To open, press and hold button . To continue the closing procedure after making sure that there is no danger of anyone being harmed by the closing procedure, press and hold button .

Vehicles with KEYLESS-GO:

- Release the lock button on the outside door handle to stop the closing procedure.
- Immediately pull on the same outside door handle and hold firmly. The door windows and the tilt/sliding sunroof will open for as long as the door handle is held but the door not opened.

With SmartKey

The SmartKey must be in close proximity to the driver's outside door handle.

- ▶ Aim transmitter eye of the SmartKey at the driver's outside door handle.
- ▶ Press and hold button  on the SmartKey until the door windows and the tilt/sliding sunroof are closed completely.
- ▶ Release button  on the SmartKey to interrupt the closing procedure.

With KEYLESS-GO

The SmartKey with KEYLESS-GO must be located outside the vehicle within approximately 3 ft (1 m) of a door.

- ▶ Close all doors.
- ▶ Press and hold the lock button on an outside door handle (▶ page 73) until the door windows and the tilt/sliding sunroof are closed completely.
- ▶ Release the lock button on the outside door handle to interrupt the closing procedure.

Driving and parking

Safety notes

Warning!

Make sure absolutely no objects are obstructing the pedals' range of movement. Keep the driver's footwell clear of all obstacles. If there are any floor mats or carpets in the footwell, make sure the pedals still have sufficient clearance.

During sudden driving or braking maneuvers the objects could get caught between the pedals. You could then no longer brake or accelerate. This could lead to accidents and injury.

Warning!

With the engine not running, there is no power assistance for the brake and steering systems. In this case, it is important to keep in mind that a considerably higher degree of effort is necessary to brake and steer the vehicle. Adapt your driving accordingly.

Warning!

HYBRID vehicles: It is imperative that you read the HYBRID Supplemental Operating Instructions included in your vehicle literature portfolio. You may otherwise not recognize potential danger.

Starting the engine

Warning!

Inhalation of exhaust gas is hazardous to your health. All exhaust gas contains carbon monoxide (CO), and inhaling it can cause unconsciousness and possible death.

Do not run the engine in confined areas (such as a garage) which are not properly ventilated. If you think that exhaust gas fumes are entering the vehicle while driving, have the cause determined and corrected immediately. If you must drive under these

conditions, drive only with at least one window fully open at all times.

Automatic transmission



Gearshift pattern for automatic transmission

① Button for selecting park position **P**

P Park position

R Reverse gear

N Neutral position

D Drive position

For more information on how to operate the gear selector lever, see “Automatic transmission” (▷ page 109).

▶ Make sure the automatic transmission is in park position **P**.

The transmission position indicator in the multifunction display should be on **P** (▷ page 112).

With SmartKey

▶ Do not depress the accelerator pedal.

▶ **Gasoline engine:** Turn the SmartKey in the starter switch to position **3** (▷ page 79) and release it.

The engine starts automatically.

▶ **Diesel engine:** Turn the SmartKey in the starter switch to position **2** (▷ page 79). Preglow indicator lamp  in the instrument cluster comes on.

▶ As soon as preglow indicator lamp  goes out, turn the SmartKey in the starter switch to position **3** and release it. The engine starts automatically.

i If the engine is at operating temperature, preglow indicator lamp  may not stay on and you can start the engine without preglowing.

With KEYLESS-GO

Warning!

As long as the SmartKey is in your vehicle, the vehicle can be started. Therefore, never leave children unattended in the vehicle, as they could otherwise accidentally start the engine.

When leaving the vehicle, always take the SmartKey with you and lock the vehicle. Do not leave children unattended in the vehicle, or with access to an unlocked vehicle. A child's unsupervised access to a vehicle could result in an accident and/or serious personal injury.

You can start your vehicle without the SmartKey in the starter switch using the KEYLESS-GO start/stop button.

The SmartKey must be located in the vehicle.



KEYLESS-GO start/stop button

① USA only

② Canada only

- ▶ Make sure the KEYLESS-GO start/stop button is inserted in the starter switch (▷ page 80).
- i** To start the engine with the SmartKey instead of the KEYLESS-GO function, remove the KEYLESS-GO start/stop button from the starter switch. Proceed as described in “With SmartKey” (▷ page 104).
- ▶ Depress the brake pedal during the starting procedure.
- ▶ Do not depress the accelerator pedal.
- ▶ **Gasoline engine:** Press the KEYLESS-GO start/stop button once. The engine starts automatically.
- ▶ **Diesel engine:** Press the KEYLESS-GO start/stop button once. The engine preglows and starts automatically.
- i** If the engine is at operating temperature, the time the engine needs to preglow is reduced.

Starting difficulties

- !** Remember that extended starting attempts can drain the battery.

The engine does not start. You can hear the starter.

There could be a malfunction in the engine electronics or in the fuel supply system.

Carry out the following steps:

- ▶ If you are starting the engine with the SmartKey: Turn the SmartKey in the starter switch to position **0** and repeat the starting procedure.
 - ▶ If you are starting the engine with KEYLESS-GO: Close any doors that may be open to allow for better detection of the SmartKey.
- or
- ▶ Remove the KEYLESS-GO start/stop button from the starter switch.

- ▶ Start the engine with the SmartKey as radio signals from another source may be interfering with the KEYLESS-GO function.
- ▶ Repeat the starting procedure.

If the engine does not start after several starting attempts:

- ▶ Contact an authorized Mercedes-Benz Center or call Roadside Assistance.

The engine does not start. You cannot hear the starter.

The battery may not be charged sufficiently.

- ▶ Get a jump start (▷ page 336).

If the engine will not start despite a jump start:

- ▶ Contact an authorized Mercedes-Benz Center or call Roadside Assistance.

The starter has been exposed to excessive temperatures.

- ▶ Let the starter cool for about 2 minutes.
- ▶ Repeat the starting procedure.

If the engine does not start after several starting attempts:

- ▶ Contact an authorized Mercedes-Benz Center or call Roadside Assistance.

Driving off

Warning!

On slippery road surfaces, never downshift in order to obtain braking action. This could result in drive wheel slip and reduced vehicle control. Your vehicle's ABS will not prevent this type of loss of control.

- !** Do not run a cold engine at high engine speeds. Running a cold engine at high engine speeds may shorten the service life of the engine. This is not covered by the Mercedes-Benz Limited Warranty.

ML 63 AMG: At engine temperatures below 68°F (20°C), the engine's maximum speed

is restricted in order to protect it from damage. Avoid driving your vehicle at full speed when the engine is cold to prevent premature engine wear and/or diminished comfort.

! If an acoustic warning sounds and the message Release Parking Brake appears in the multifunction display when driving off, you have forgotten to release the parking brake.

Release the parking brake.

! Avoid spinning of a drive wheel. This may cause serious damage to the drivetrain which is not covered by the Mercedes-Benz Limited Warranty.

! Simultaneously depressing the accelerator pedal and applying the brakes reduces engine performance and causes premature brake and drivetrain wear which is not covered by the Mercedes-Benz Limited Warranty.

i Once the vehicle is in motion, the automatic central locking function engages and the locking knobs in the doors move down.

The automatic central locking function can be switched off (▷ page 135).

Automatic transmission

Warning!

It is dangerous to shift the automatic transmission out of park position **P** or neutral position **N** if the engine speed is higher than idle speed. If your foot is not firmly on the brake pedal, the vehicle could accelerate quickly forward or in reverse. You could lose control of the vehicle and hit someone or something. Only shift into gear when the engine is idling normally and when your right foot is firmly on the brake pedal.

! Only shift the automatic transmission into reverse gear **R** or park position **P** when the vehicle is stopped. Otherwise the automatic transmission could be damaged.

- ▶ Depress the brake pedal. The gear selector lever can now be used.
- ▶ Shift the automatic transmission into drive position **D** or reverse gear **R**.

i Shifting the automatic transmission out of park position **P** is only possible with the brake pedal depressed.

Without the brake pedal depressed, the gear selector lever can be moved up or down. However, the parking pawl remains engaged, not allowing shifting to occur.

- ▶ Wait for the gear selection process to complete before setting the vehicle in motion.
- ▶ If engaged, release the parking brake.
- ▶ Release the brake pedal.
- ▶ Carefully depress the accelerator pedal.

After a cold start, the automatic transmission shifts at a higher engine speed. This allows the catalytic converter (gasoline engine) or the oxidation catalyst (diesel engine) to reach its operating temperature earlier.

For more information on driving, see “Driving instructions” (▷ page 244).

For information on off-road driving, see “Off-road driving” (▷ page 248).

Problems while driving

The engine runs erratically and misfires

- Gasoline engine: An ignition cable may be damaged.
- The engine electronics may not be operating properly.
- Gasoline engine: Unburned gasoline may have entered the catalytic converter and damaged it.

- ▶ Give very little gas.
- ▶ Have the problem checked at an authorized Mercedes-Benz Center as soon as possible.

The coolant temperature is above 248°F (120°C)

The coolant is too hot and is no longer cooling the engine.

- ▶ Stop the vehicle in a safe location as soon as possible.
- ▶ Turn off the engine immediately.
- ▶ Allow the engine and coolant to cool off.
- ▶ Check the coolant level and add coolant if necessary (▶ page 216).

In case of accident

If the vehicle is leaking fuel:

- ▶ Do not start the engine under any circumstances.
- ▶ Exit the vehicle at a safe distance from the roadway.
- ▶ Notify local fire and/or police authorities.

If the extent of the damage cannot be determined:

- ▶ Contact an authorized Mercedes-Benz Center or call Roadside Assistance.

If no damage on major assemblies, fuel system, and engine mount can be determined:

- ▶ Start the engine in the usual manner.

Parking

Warning!

Do not park this vehicle in areas where combustible materials such as grass, hay or leaves can come into contact with the hot exhaust system. These materials could be ignited and cause a vehicle fire.

Vehicle movement may result in serious personal injury or damage to the vehicle or vehicle drivetrain. Therefore, always do the following before turning off the engine and leaving the vehicle:

- Keep right foot on the brake pedal.
- Engage the parking brake.
- Shift the automatic transmission into park position **P**.
- Slowly release the brake pedal.
- When parked on an incline, always turn the front wheels towards the road curb.
- Turn the SmartKey in the starter switch to position **0** and remove the SmartKey from the starter switch, or press the KEYLESS-GO start/stop button.
- Take the SmartKey with you and lock the vehicle when leaving.

Parking brake

Warning!

Engaging the parking brake while the vehicle is in motion can cause the rear wheels to lock up. You could lose control of the vehicle and cause an accident. In addition, the vehicle's brake lights do not light up when the parking brake is engaged.

Warning!

When leaving the vehicle, always remove the SmartKey from the starter switch, take it with you, and lock the vehicle. Do not leave children unattended in the vehicle, or with access to an unlocked vehicle. Children could release the parking brake and/or shift the automatic transmission out of park position **P**, either of which could result in an accident and/or serious personal injury.



- ▶ **Releasing:** Pull on release handle ①. When the ignition is switched on or the engine is running, the brake warning lamp **BRAKE** (USA only) or **(D)** (Canada only) in the instrument cluster goes out.
- ▶ **Engaging:** Step on parking brake pedal ② firmly. When the engine is running, the brake warning lamp **BRAKE** (USA only) or **(D)** (Canada only) in the instrument cluster comes on.

Turning off the engine

Warning!

Do not turn off the engine before the vehicle has come to a complete stop. With the engine not running, there is no power assistance for the brake and steering systems. In this case, it is important to keep in mind that a considerably higher degree of effort is necessary to brake and steer the vehicle.

- ▶ **i** If the engine cannot be turned off as described, see “Emergency engine shutdown” (▷ page 344).
- ▶ Shift the automatic transmission into park position **P**.
- ▶ Engage the parking brake.
- ▶ **i** Always engage the parking brake in addition to shifting the automatic transmission into park position **P**.

- ▶ **i** Observe instructions if you want the automatic transmission to remain in neutral position **N**, see “Remaining in neutral position **N**” (▷ page 111).

With SmartKey

- ▶ Turn the SmartKey in the starter switch to position **0**.
- ▶ Remove the SmartKey from the starter switch.

When you turn off the engine using the SmartKey, and remove the SmartKey from the starter switch or open a front door, the automatic transmission will shift into park position **P** automatically.

Warning!

Keep in mind that turning off the engine alone only will shift the automatic transmission into neutral position **N** automatically.

Always shift the automatic transmission into park position **P** before turning off the engine. Otherwise the vehicle could roll away which could result in an accident and/or serious personal injury.

With KEYLESS-GO

- ▶ Press the KEYLESS-GO start/stop button. With the driver’s door closed, the starter switch is now in position **1**. With the driver’s door opened, the starter switch is set to position **0**, same as the SmartKey removed from the starter switch (▷ page 79).

When you turn off the engine using the KEYLESS-GO start/stop button and open a front door, the automatic transmission will shift into park position **P** automatically.

Warning!

Keep in mind that turning off the engine alone only will shift the automatic transmission into neutral position **N** automatically.

Always shift the automatic transmission into park position **P** before turning off the engine.

Otherwise the vehicle could roll away which could result in an accident and/or serious personal injury.

- i** In an emergency you can turn off the engine while driving by pressing and holding the KEYLESS-GO start/stop button for approximately 3 seconds.

If you have started the engine with the KEYLESS-GO start/stop button and cannot turn it off as described above:

- ▶ Remove the KEYLESS-GO start/stop button from the starter switch.
- ▶ Insert the SmartKey into the starter switch. The engine turns off. The starter switch is in position **0** (▶ page 79).

Automatic transmission

Introduction

For information on driving with an automatic transmission, see “Driving and parking” (▶ page 103).

⚠ Warning!

Make sure absolutely no objects are obstructing the pedals’ range of movement. Keep the driver’s footwell clear of all obstacles. If there are any floor mats or carpets in the footwell, make sure the pedals still have sufficient clearance.

During sudden driving or braking maneuvers the objects could get caught between the pedals. You could then no longer brake or accelerate. This could lead to accidents and injury.

⚠ Warning!

HYBRID vehicles: It is imperative that you read the HYBRID Supplemental Operating Instructions included in your vehicle literature portfolio. You may otherwise not recognize potential danger.

- !** Allow the engine to warm up under low load use. Do not place full load on the engine until the operating temperature has been reached.

Avoid spinning of a drive wheel for an extended period when driving off on slippery road surfaces.

This may cause serious damage to the engine and the drivetrain which is not covered by the Mercedes-Benz Limited Warranty.

- i** During the brief warm-up, transmission upshifting is delayed. This allows the catalytic converter (gasoline engine) or oxidation catalyst (diesel engine) to heat up more quickly to operating temperature.

Gear selector lever



Gearshift pattern for automatic transmission

- ① Button for selecting park position **P**
- P** Park position
- R** Reverse gear
- N** Neutral position
- D** Drive position

⚠ Warning!

It is dangerous to shift the automatic transmission out of park position **P** or neutral position **N** if the engine speed is higher than idle speed. If your foot is not firmly on the brake pedal, the vehicle could accelerate quickly forward or in reverse. You could lose control of the vehicle and hit someone or

something. Only shift into gear when the engine is idling normally and when your right foot is firmly on the brake pedal.

! The vehicle must be stopped when you shift the automatic transmission

- directly between drive position **D** and reverse gear **R**
- directly between reverse gear **R** and drive position **D**
- directly into park position **P**

Otherwise the automatic transmission could be damaged.

When trying to free a vehicle stuck in mud or snow, see “Rocking the vehicle” (▷ page 113).

i Shifting the automatic transmission out of park position **P** is only possible with the brake pedal depressed.

Without the brake pedal depressed, the gear selector lever can be moved up or down, but the parking pawl remains engaged, not allowing shifting to occur.

i Depending on vehicle production date: The automatic transmission will shift into park position **P** automatically when

- you open the driver’s door while driving at low speed, and
- the automatic transmission is in drive position **D** or reverse gear **R**

After the vehicle has engaged park position **P** automatically, you can engage drive position **D** or reverse gear **R** again to override this locking feature purposely.

i The gear selector lever always returns to its original position.

The current transmission position **P**, **R**, **N**, or **D** appears in the multifunction display (▷ page 112).

Shifting into park position P

- ▶ With the vehicle at a standstill, press button **①** on the gear selector lever.

SmartKey: When you turn off the engine using the SmartKey, and remove the SmartKey from the starter switch or open a front door, the automatic transmission will shift into park position **P** automatically.

KEYLESS-GO: When you turn off the engine using the KEYLESS-GO start/stop button and open a front door, the automatic transmission will shift into park position **P** automatically.

Warning!

Keep in mind that turning off the engine alone only will shift the automatic transmission into neutral position **N** automatically.

Always shift the automatic transmission into park position **P** before turning off the engine. Otherwise the vehicle could roll away which could result in an accident and/or serious personal injury.

- i** Moving the gear selector lever up or down shifts the automatic transmission out of park position **P**.

Shifting into neutral position N

- ▶ With the vehicle at a standstill, depress the brake pedal.
- ▶ Move the gear selector lever up or down to the resistance point to select neutral position **N**.

When you turn off the engine, the automatic transmission will shift into neutral position **N** automatically.

SmartKey: Removing the SmartKey from the starter switch or opening a front door after turning off the engine will shift the automatic transmission into park position **P** automatically.

KEYLESS-GO: Opening a front door after turning off the engine will shift the automatic

transmission into park position **P** automatically.

Remaining in neutral position **N**

If you want the automatic transmission to remain in neutral position **N**, e.g. when taking the vehicle through an automatic conveyor-type car wash, observe the following instructions.

Warning!

When leaving the SmartKey in the starter switch, do not leave children unattended in the vehicle. It is possible for children to switch on the ignition which could result in unsupervised use of vehicle equipment. Unsupervised use of vehicle equipment could result in an accident and/or serious personal injury.

With SmartKey:

- ▶ Make sure the ignition is switched on.
- ▶ With the vehicle at a standstill, depress the brake pedal and keep it pressed.
- ▶ Shift the automatic transmission into neutral position **N**.
- ▶ Release the brake pedal.
- ▶ If engaged, release the parking brake.
- ▶ Switch off the ignition and leave the SmartKey in the starter switch.

With KEYLESS-GO:

- ▶ Make sure the ignition is switched on.
- ▶ With the vehicle at a standstill, depress the brake pedal and keep it pressed.
- ▶ Shift the automatic transmission into park position **P**.
- ▶ Release the brake pedal.
- ▶ Remove the KEYLESS-GO start/stop button from the starter switch.
- ▶ Insert the SmartKey into the starter switch.
- ▶ Switch on the ignition.
- ▶ Depress the brake pedal and keep it pressed.

- ▶ Shift the automatic transmission into neutral position **N**.
- ▶ Release the brake pedal.
- ▶ If engaged, release the parking brake.
- ▶ Switch off the ignition and leave the SmartKey in the starter switch.

Shifting into reverse gear **R**

- ▶ With the vehicle at a standstill, depress the brake pedal.
- ▶ Move the gear selector lever up past the resistance point.

Shifting into drive position **D**

- ▶ With the vehicle at a standstill, depress the brake pedal.
- ▶ Move the gear selector lever down past the resistance point.

Shifting procedure

The automatic transmission selects individual gears automatically, depending on

- the selected gear range (▷ page 113)
- the selected program mode:
 - C/S** (ML 63 AMG only) (▷ page 114)
 - or
 - M** (ML 63 AMG only) (▷ page 115)
- the position of the accelerator pedal
- the vehicle speed

With drive position **D** selected, you can influence transmission shifting by

- limiting the gear range
- extending the gear range
- changing the gears manually (ML 63 AMG only)

Transmission positions

The current transmission position appears in the multifunction display.



① Transmission position indicator

If the current transmission position does not appear in the multifunction display due to a malfunction, for example, make sure that the automatic transmission is in the desired position.

- ▶ Shift the automatic transmission into drive position **D**.
- ▶ Select automatic program mode **C** (ML 63 AMG only).
- ▶ Do not limit the gear range.
- ▶ Drive off carefully.

Effect

P

Park position

Shift the automatic transmission into park position **P** only when the vehicle is stopped. The park position is not intended to serve as a brake when the vehicle is parked. Rather, the driver should always engage the parking brake in addition to shifting the automatic transmission into park position **P** to secure the vehicle.

If the vehicle's electrical system is malfunctioning, the automatic transmission could remain locked in park position **P**.

- ▶ Have the vehicle's electrical system checked at an authorized Mercedes-Benz Center as soon as possible.

R

Reverse gear

Shift the automatic transmission into reverse gear **R** only when the vehicle is stopped.

Effect**N Neutral position**

No power is transmitted from the engine to the drive axle. When the brakes are released, the vehicle can be moved freely (pushed or towed).

To avoid damage to the transmission, never shift the automatic transmission into neutral position **N** while driving.

Exception: If the ESP[®] is switched off or malfunctioning, shift the automatic transmission into neutral position **N** if the vehicle is in danger of skidding.

! Coasting the vehicle, or driving for any other reason with the automatic transmission in neutral position **N** can result in transmission damage that is not covered by the Mercedes-Benz Limited Warranty.

D Drive position

The automatic transmission shifts automatically. All forward gears are available.

Driving tips**Kickdown**

Use the kickdown when you want maximum acceleration.

► U.S. vehicles except AMG vehicles:

Fully depress the accelerator pedal. Depending on the engine speed the automatic transmission shifts into a lower gear.

► Canada vehicles and AMG vehicles:

Depress the accelerator pedal past the point of resistance. Depending on the engine speed the automatic transmission shifts into a lower gear.

Rocking the vehicle

Rocking the vehicle by shifting the automatic transmission directly between drive position **D** and reverse gear **R** can help free a vehicle stuck in mud or snow. The engine control system of this vehicle electronically limits directly shifting the automatic transmission between drive position **D** and reverse gear **R** to very low speeds, i.e. approximately 5 mph (9 km/h). To shift the automatic transmission directly between drive position **D** and reverse gear **R**, move the gear selector lever up or down past the resistance point.

Working on the vehicle**⚠ Warning!**

When working on the vehicle, engage the parking brake and shift the automatic transmission into park position **P**. Otherwise the vehicle could roll away which could result in an accident and/or serious personal injury.

Towing a trailer

► When you tow a trailer, shift into a lower gear range manually if the automatic transmission hunts between gears on inclines.

A lower gear range and reduction of speed reduces the potential to overload or to overheat the engine.

For more information on trailer towing, see "Trailer towing" (> page 254).

Gear ranges

With the automatic transmission in drive position **D**, you can limit or extend the gear range, see "One-touch gearshifting" (> page 115).

ML 63 AMG: You only can limit or extend the gear range when driving in automatic program mode **C** or **S**.

The current gear range appears in the multifunction display.



① Gear range indicator

	Effect
③	With this selection you can use the braking effect of the engine.
②	Allows the use of the engine's braking effect when driving <ul style="list-style-type: none"> • on steep downgrades • in mountainous regions • under extreme operating conditions
①	For maximum use of the engine's braking effect on very steep or lengthy downgrades.

Automatic shift program

The automatic shift program is available on ML 63 AMG only.



Program mode selector switch

C Comfort	For standard driving (▷ page 114)
S Sport	For sporty driving (▷ page 114)
M Manual	For manual gearshifting (▷ page 115)

The current program mode appears in the multifunction display.



① Program mode indicator

You should only change the program mode when the automatic transmission is in park position **P**.

The last selected automatic program mode (**C** or **S**) is active when the engine is restarted.

► Press the program mode selector switch repeatedly until the letter of the desired program mode appears in the multifunction display.

Selecting program mode **C** means:

- The vehicle starts out more gentle, both forward and reverse, except when driving off with full throttle.
- Traction and driving stability are improved on icy roads.
- Upshifts occur earlier even when you give more gas. The engine then operates at lower revolutions and the wheels are less likely to spin.

Selecting program mode **S** means that upshifts occur later.

One-touch gearshifting

With the automatic transmission in drive position **D**, you can limit or extend the gear range using the steering wheel gearshift control.

ML 63 AMG: You only can limit or extend the gear range when driving in automatic program mode **C** or **S**. For information on using the steering wheel gearshift control in manual program mode **M**, see “Manual shift program” (▷ page 115).



Steering wheel gearshift control (example illustration)

- i** You cannot shift with the steering wheel gearshift control when the automatic transmission is in park position **P**, neutral position **N**, or reverse gear **R**.

Limiting gear range

Warning!

On slippery road surfaces, never downshift in order to obtain braking action. This could result in drive wheel slip and reduced vehicle control. Your vehicle's ABS will not prevent this type of loss of control.

- ▶ Briefly pull left gearshift control ①.
The automatic transmission will shift into the next lower gear as permitted by the shift program. This action simultaneously limits the gear range of the automatic transmission.

- i** To avoid overrevving the engine when downshifting, the automatic transmission will not shift into a lower gear if the engine's maximum speed would be exceeded.

Extending gear range

- ▶ Briefly pull right gearshift control ②.
The automatic transmission will shift into the next higher gear as permitted by the shift program. This action simultaneously extends the gear range of the automatic transmission.

- i** If you press on the accelerator pedal when the engine has reached the revolution limit of the current gear range, the automatic transmission will upshift beyond any gear range limit selected.

Canceling gear range limit

- ▶ Pull and hold right gearshift control ② until the gear range indicator disappears from the multifunction display.
The automatic transmission will shift from the current gear range directly into drive position **D**.

Shifting into optimal gear range

- ▶ Pull and hold left gearshift control ①.
The automatic transmission will select the gear range suited for optimal acceleration and deceleration automatically. This will involve shifting down one or more gears.

Manual shift program

The manual shift program is available on ML 63 AMG only.

Manual program mode **M** differs with regard to spontaneity, response time, and shifting smoothness from automatic program mode **S**.

In manual program mode **M**, system-controlled automatic gearshifting is switched off. You need to change the gears by manually

upshifting or downshifting using the steering wheel gearshift control.



Program mode selector switch

C Comfort	For standard driving
S Sport	For sporty driving
M Manual	For manual gearshifting

The current program mode appears in the multifunction display (▷ page 114).

For information on automatic program mode (**C** or **S**), see “Automatic shift program” (▷ page 114) and “One-touch gearshifting” (▷ page 115).

Activating manual shift program

- ▶ Press the program mode selector switch repeatedly until **M** appears in the multifunction display.

The automatic transmission switches to manual program mode **M**. Automatic shifting is switched off. The gear range is not limited.

You can change the gears manually with drive position **D** selected. You can upshift or downshift through the gears in succession.

- i** Manual program mode **M** will not be stored. When the engine is turned off with manual program mode **M** selected, the automatic transmission will go to automatic program mode (**C** or **S**) when the engine is restarted.

Upshifting

i In manual program mode **M**, the automatic transmission will not upshift, even if the engine has reached its overrevving range. Shift up into the next gear before the engine has reached its overrevving range. Make absolutely certain that the engine speed does not reach the red marking on the tachometer. Otherwise the engine could be damaged which is not covered by the Mercedes-Benz Limited Warranty.

- ▶ Briefly pull right gearshift control ② (▷ page 115).
The automatic transmission shifts into the next higher gear.

Upshift indicator

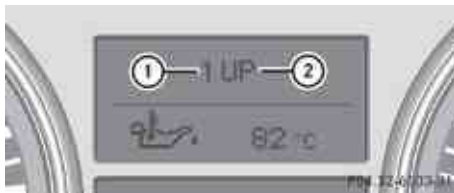

In manual program mode **M**, upshift indicator ② in the multifunction display advises you to upshift before the engine reaches the overspeed range. Thus you can drive at the maximum engine speed for each gear without overrevving the engine.

- ▶ Shift the automatic transmission from current gear ① into the next higher gear.
The fuel supply will otherwise be interrupted to prevent the engine from overrevving.

Downshifting

⚠ Warning!

On slippery road surfaces, never downshift in order to obtain braking action. This could result in drive wheel slip and reduced vehicle control. Your vehicle's ABS will not prevent this type of loss of control.

- ▶ Briefly pull left gearshift control ① (▷ page 115).
The automatic transmission shifts into the next lower gear.
- i** For maximum acceleration, pull and hold the left gearshift control. Depending on the engine speed the automatic transmission selects the optimal gear for maximum acceleration.
- i** When you brake or stop, the automatic transmission shifts down into a gear from which you can easily accelerate or take off.

Kickdown

Using the kickdown while driving in manual program mode **M** is not possible.

Deactivating manual shift program

- ▶ Press the program mode selector switch repeatedly until **C** or **S** appears in the multifunction display.

or

- ▶ Restart the engine.
The automatic transmission will go to automatic program mode (**C** or **S**).

Manual program mode **M** is not stored.

Emergency operation (limp-home mode)

If vehicle acceleration becomes less responsive or sluggish or the automatic transmission no longer shifts, the automatic transmission is most likely operating in limp-home (emergency operation) mode. In this mode only second gear and reverse gear **R** can be selected.

- ▶ Stop the vehicle in a safe location.
- ▶ Shift the automatic transmission into park position **P**.
- ▶ Turn off the engine.
- ▶ Wait at least 10 seconds before restarting.
- ▶ Restart the engine.

- ▶ Shift the automatic transmission into drive position **D** (for second gear) or reverse gear **R**.
- ▶ Have the automatic transmission checked at an authorized Mercedes-Benz Center as soon as possible.

Transfer case

This section applies to vehicles equipped with all-wheel drive (4MATIC) only. Both the front and rear axles are powered at all times when the vehicle is being operated.

- !** Only conduct operational or performance tests on a two-axle dynamometer. If such tests are necessary, contact an authorized Mercedes-Benz Center. You could otherwise seriously damage the brake system or the transfer case which is not covered by the Mercedes-Benz Limited Warranty.

- !** Because the ESP® operates automatically, the engine and ignition must be shut off (SmartKey in starter switch position **0** or **1** or KEYLESS-GO start/stop button in position **0** or **1**) when the parking brake is being tested on a brake test dynamometer. Such testing should be no longer than 10 seconds.

Active braking action through the ESP® may otherwise seriously damage the brake system which is not covered by the Mercedes-Benz Limited Warranty.

Instrument cluster

Introduction

For a full view illustration of the instrument cluster, see “Instrument cluster” (▷ page 28).

⚠ Warning!

No messages will be displayed if either the instrument cluster or the multifunction display is inoperative.

As a result, you will not be able to see information about your driving conditions, such as

- speed
- outside temperature
- warning/indicator lamps
- malfunction/warning messages
- failure of any systems

Driving characteristics may be impaired.

If you must continue to drive, do so with added caution. Contact an authorized Mercedes-Benz Center as soon as possible.

⚠ Warning!

HYBRID vehicles: It is imperative that you read the HYBRID Supplemental Operating Instructions included in your vehicle literature portfolio. You may otherwise not recognize potential danger.



- ① To dim instrument cluster illumination
- ② Reset button
- ③ To brighten instrument cluster illumination

For information on changing the instrument cluster settings, e.g. the language, see (▷ page 130).

Activating the instrument cluster

The instrument cluster is activated when you

- open the driver's door
- switch on the ignition
- press button ①, ② or ③

i Opening the driver's door or pressing button ①, ② or ③ without switching on the ignition activates the instrument cluster illumination only for 30 seconds.

Adjusting the instrument cluster illumination

► **To brighten illumination:** Press and hold button ③ until the desired level of illumination is reached.

► **To dim illumination:** Press and hold button ① until the desired level of illumination is reached.

i The instrument cluster illumination is dimmed or brightened automatically to suit ambient light conditions.

The instrument cluster illumination will also be adjusted automatically when you switch on the vehicle's exterior lamps.

i With the exterior lighting switched on, the brightness of the switches in the center console will also be adjusted when using button ① or ③.

Resetting trip odometer

- Make sure you are viewing the standard display (▷ page 122) in the multifunction display.
- Press and hold the reset button in the instrument cluster (▷ page 117) until the trip odometer is reset.

Tachometer

The red marking on the tachometer (▷ page 29) denotes excessive engine speed.

- ! Avoid driving at excessive engine speeds, as it may result in serious engine damage that is not covered by the Mercedes-Benz Limited Warranty.

To help protect the engine, the fuel supply is interrupted if the engine is operated within the red marking.

Control system

Introduction

The control system is activated as soon as the starter switch is in position **1** (▷ page 79).

The control system enables you to call up information about your vehicle and to change vehicle settings.

For example, you can use the control system to find out when your vehicle is next due for maintenance service, to set the language for messages in the instrument cluster display, and much more.

Warning!

A driver's attention to the road and traffic conditions must always be his/her primary focus when driving.

For your safety and the safety of others, selecting features through the multifunction steering wheel should only be done by the driver when traffic and road conditions permit it to be done safely.

Bear in mind that at a speed of just 30 mph (approximately 50 km/h), your vehicle is covering a distance of 44 feet (approximately 14 m) every second.

Warning!





HYBRID vehicles: It is imperative that you read the HYBRID Supplemental Operating Instructions included in your vehicle literature portfolio. You may otherwise not recognize potential danger.

The control system relays information to the multifunction display.

Multifunction steering wheel

The displays in the multifunction display and the settings in the control system are controlled by using the buttons on the multifunction steering wheel.



- | | |
|---|--|
| ① | Multifunction display |
| ② | Press button |
| |  to end a call |
| |  to reject an incoming call |
| |  to answer a call |
| |  to dial ¹⁰ |
| |  to redial ¹⁰ |

¹⁰ Function only available in telephone menu.

Press button



to select submenus in the Settings menu to set values to operate the RACETIMER¹¹ to set the volume

Press button



to turn Voice Control System on¹², see separate operating instructions

③ Press button



to select next or previous menu

Press button briefly



to move within a menu
Within **Audio/DVD** menu to select previous or next track, scene or stored station
Within **Telephone** menu to switch to the phone book and select a name or number

Press and hold button



Within **Audio/DVD** menu to select previous or next track with quick search or to select previous or next station in station list or wave band
Within **Telephone** menu to start the quick search in the phone book

Press button



to turn Voice Control System off¹², see separate operating instructions

wheel will alter what appears in the multifunction display.

The information available in the multifunction display is arranged in menus and accompanying functions and submenus.

The individual functions are then found within the relevant menu (radio or CD operations under **Audio/DVD** menu, for example). These functions serve to call up relevant information or to customize the settings for your vehicle.

It is helpful to think of the menus, and the functions within each menu, as being arranged in a circular pattern.

- ▶ Press button or repeatedly to pass through each menu one after the other.
- ▶ Press button or repeatedly to pass through each function display, one after the other, in the current menu.

In the Settings menu, instead of functions, you will find a number of submenus for calling up and changing settings. For instructions on using these submenus, see “Settings menu” (▷ page 129).

The number of menus available in the system depends on which optional equipment is installed in your vehicle.

Depending on the selected menu, pressing the buttons on the multifunction steering

¹¹ AMG vehicles only.

¹² Vehicles without Voice Control System: Button without function.

Multifunction display

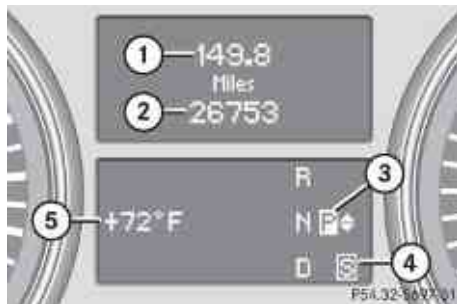

- ① Trip odometer
- ② Main odometer

- ③ Transmission position/gear range indicator
- ④ Automatic transmission program mode indicator¹³
- ⑤ Outside temperature or digital speedometer

For more information on menus displayed in the multifunction display, see “Menus and submenus” (▷ page 121).

Menus and submenus

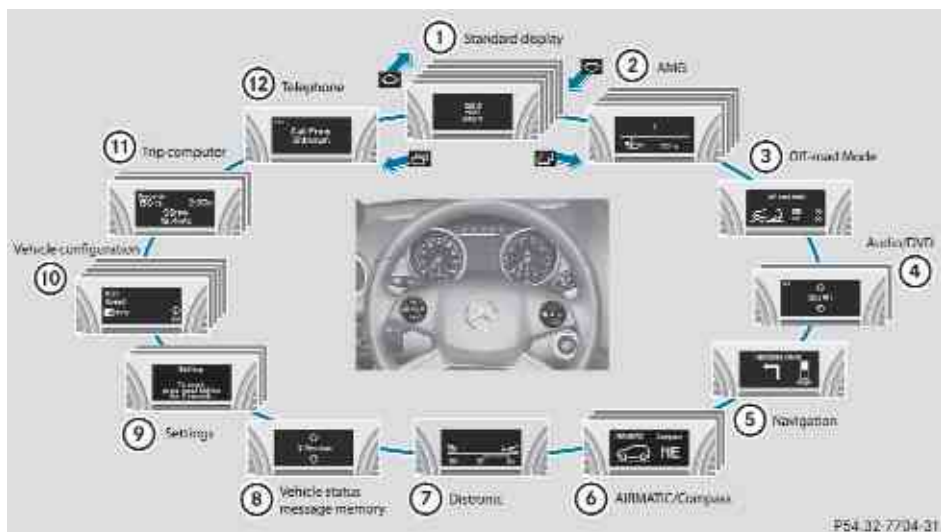

- ① The headings used in the menu table are designed to facilitate navigation within the system and are not necessarily identical to those shown in the multifunction display. The first function displayed in each menu will automatically show you which part of the system you are in.

	Function
①	Standard display menu (▷ page 122)
②	AMG ¹⁴ menu (▷ page 123)
③	Off-road Mode ¹⁴ menu (▷ page 125)

¹³ AMG vehicles only.

¹⁴ AMG vehicles only.





	Function
④	Audio/DVD menu (▷ page 126)
⑤	Navigation menu (▷ page 127)
⑥	AIRMATIC/Compass menu (▷ page 127)
⑦	Distronic menu (▷ page 128)
⑧	Vehicle status message memory ¹⁵ menu (▷ page 128)
⑨	Settings menu (▷ page 129)
⑩	Vehicle configuration menu (▷ page 137)
⑪	Trip computer menu (▷ page 138)
⑫	Telephone menu (▷ page 139)

Standard display menu



Standard display

In the standard display, trip odometer ① and main odometer ② appear in the multifunction display.

- ▶ If you see another display, press button  or  repeatedly until the standard display appears.
- ▶ Press button  or  to select the functions in the **Standard display** menu.

The following functions are available:

- Restarting the tire pressure loss warning system (▷ page 223) (Canada only)
- Checking tire inflation pressure with the Advanced TPMS (▷ page 223) (USA only)
- Checking coolant temperature (▷ page 122)
- Calling up digital speedometer or outside temperature (▷ page 123)
- Calling up maintenance service indicator display (▷ page 259)



Checking coolant temperature

Warning!

Driving when your engine is overheated can cause some fluids which may have leaked into the engine compartment to catch fire. You could be seriously burned.

Steam from an overheated engine can cause serious burns which can occur just by opening the engine hood. Stay away from the engine if you see or hear steam coming from it.

Stop the vehicle in a safe location away from other traffic. Turn off the engine, get out of the vehicle and do not stand near the vehicle until the engine has cooled down.

- ▶ Press button  or  repeatedly until the coolant temperature appears in the multifunction display.

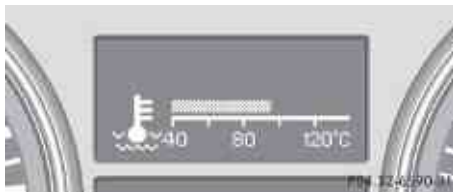

During severe operating conditions, e.g. stop-and-go traffic, the coolant temperature may rise close to 248°F (120°C).

- ! Excessive coolant temperature triggers a warning in the multifunction display.

¹⁵ The vehicle status message memory menu is only displayed if there is a message stored.

The engine should not be operated with a coolant temperature above 248°F (120°C). Doing so may cause serious engine damage which is not covered by the Mercedes-Benz Limited Warranty.



Calling up digital speedometer or outside temperature

You can select whether the digital speedometer or the outside temperature appears in the multifunction display (▷ page 131).

Warning!

The outside temperature indicator is not designed to serve as an ice-warning device and is therefore unsuitable for that purpose.

Indicated temperatures just above the freezing point do not guarantee that the road surface is free of ice. The road may still be icy, especially in wooded areas or on bridges.

- ▶ Press button  or  repeatedly until the digital speedometer or the outside temperature appears in the multifunction display.





Digital speedometer



Outside temperature

AMG menu

This function is only available in AMG vehicles.

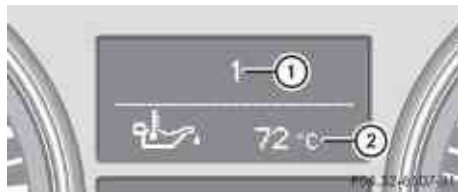

- ▶ Press button  or  repeatedly until the **AMG** menu appears in the multifunction display.



The main screen of the **AMG** menu shows you the gear currently engaged ① as well as the engine oil temperature ②.



The engine oil temperature flashes if the engine oil temperature has not yet reached 80°C. During this time, avoid driving at full engine speed.

If the engine reaches the overspeed range in the manual shift program, the menu will be shown in red. In addition, you will see UP next to gear indicator ① as a reminder to upshift.

Use buttons  or  to select the following functions in the **AMG** menu:

- Vehicle supply voltage (▷ page 123)
- RACETIMER (▷ page 124)
- Overall analysis (▷ page 125)
- Lap analysis (▷ page 125)

Vehicle supply voltage

- ▶ Press button  or  repeatedly until the **AMG** menu appears in the multifunction display.
- ▶ Press button  repeatedly until the vehicle supply voltage appears in the multifunction display.



- ① Vehicle supply voltage indicator

RACETIMER

⚠ Warning!

The RACETIMER feature is only for use on roads and in conditions where high speed driving is permitted. Racing on public roads is prohibited under all circumstances. The driver is and must always remain responsible for following posted speed limits.

The RACETIMER allows you to time and save driving stretches.

- ▶ Press button or repeatedly until the **AMG** menu appears in the multifunction display.
- ▶ Press button repeatedly until the RACETIMER appears in the multifunction display.



- ① RACETIMER
② Lap number

You can start the RACETIMER when the engine is running or the starter switch is in position **2** (▷ page 79).

While the RACETIMER is being displayed, you cannot adjust the audio volume using buttons or .

- ▶ **Starting:** Press button .
- ▶ **Displaying intermediate time:** Press button while the timer is running. The intermediate time is shown for 5 seconds.
- ▶ **Stopping:** Press button .

When you stop the vehicle and turn the SmartKey to position **1** (▷ page 79) or, in vehicles with KEYLESS-GO, turn off the engine and do not open the driver's door, the RACETIMER stops timing. Timing is resumed when you press button after switching the ignition back on or restarting the engine.

Saving lap time and starting a new lap

You can save up to nine laps.

- ▶ Press button while the timer is running. The intermediate time will be shown for 5 seconds.
- ▶ Press button within 5 seconds. The intermediate time shown will be saved as a lap time. The RACETIMER begins timing the new lap. The new lap begins to be timed as soon as the intermediate time is called up.





- ① RACETIMER
② Best lap time
③ Lap number

Resetting current lap

- ▶ Press button while the timer is running. The timer stops.
- ▶ Press button . The lap time is reset to "0".



Deleting all laps

It is not possible to delete a single saved lap. When you turn off the engine, the RACETIMER will be reset to "0" after 30 seconds. All laps are deleted.

- ▶ Press button  while the timer is running.
The timer stops.
 - ▶ Press the reset button in the instrument cluster twice (▷ page 118).
 - ▶ Press button .
- The timer starts. The saved laps are deleted.

Overall analysis

This function is only available if you have saved at least one lap and have stopped the RACETIMER.



- ▶ Press button  or  repeatedly until the **AMG** menu appears in the multifunction display.
- ▶ Press button  repeatedly until the overall analysis appears in the multifunction display.



- ① Overall analysis of RACETIMER
- ② Overall driving time
- ③ Maximum speed
- ④ Overall distance driven
- ⑤ Average speed



Lap analysis

This function is only available if you have saved at least two laps and have stopped the RACETIMER.

- ▶ Press button  or  repeatedly until the **AMG** menu appears in the multifunction display.
- ▶ Press button  repeatedly until the lap analysis appears in the multifunction display.

Each lap is shown in its own submenu. The fastest lap is indicated by flashing symbol ①.





- ① Lap number
 - ② Lap time
 - ③ Maximum speed during lap
 - ④ Lap length
 - ⑤ Average speed during lap
- ▶ Press button  or  to see other lap analyses.



Off-road Mode menu

This function is only available in AMG vehicles.

Use this function to switch the off-road driving program (▷ page 155) On or Off.

- ▶ Press button  or  repeatedly until the Off-road Mode menu appears in the multifunction display.



- ▶ Press button  or  to switch the off-road driving program On or Off. The symbol  appears in the lower multifunction display.



The setting is stored when you turn off the engine.

Audio/DVD menu

The functions in the **Audio/DVD** menu operate the audio or video equipment which you have currently switched on.

The following functions are available:

- Selecting radio station (▶ page 126)
- Operating audio devices/audio media (▶ page 127)
- Operating video DVD (▶ page 127)



If no audio equipment is currently switched on, the message **AUDIO Off** appears in the multifunction display.

Selecting radio station

The HD Radio with SIRIUS Satellite Radio is treated as a radio application.

For more information on HD Radio with SIRIUS Satellite Radio, refer to separate COMAND system operating instructions.







Additional optional satellite radio equipment and a subscription to a satellite radio service provider are required for satellite radio operation. Contact an authorized Mercedes-Benz Center for details and availability for your vehicle.

- ▶ Switch on the COMAND system and select radio. Refer to separate COMAND system operating instructions.
- ▶ Press button  or  repeatedly until the currently tuned station appears in the multifunction display.



Example illustration



- ① Wave band setting and stored memory position
- ② Station frequency

- ▶ **Selecting next or previous stored station:** Press button  or  briefly to select a stored station.
- ▶ **Selecting next or previous station in the station list:** Press and hold button  or  to select a station.
- ▶ **Selecting next or previous station in wave band** (Only if no station list is available): Press and hold button  or  to select a station.

You can only store new stations using the corresponding feature on the radio. Refer to separate COMAND system operating instructions.

You can also operate the radio in the usual manner.





Operating audio devices/audio media

- ▶ Switch on the COMAND system and select the audio device or audio media. Refer to separate COMAND system operating instructions.
- ▶ Press button  or  repeatedly until the **Audio/DVD** menu appears in the multifunction display.





Example illustration

- ① Disc number
- ② Current track

- ▶ **Selecting next or previous track:** Press button  or  briefly.
- ▶ **Selecting a track from the track list (quick search):** Press and hold button  or .

The current track does not appear during Audio AUX mode operation.

Operating video DVD

- ▶ Switch on the COMAND system and select DVD-Video. Refer to separate COMAND system operating instructions.
- ▶ Press button  or  repeatedly until the **Audio/DVD** menu appears in the multifunction display.





- ① Disc number
- ② Current scene

- ▶ Press button  or  to select a scene.

Navigation menu



The **Navigation** menu contains the functions needed to operate your navigation system.

- ▶ Press button  or  repeatedly until the **Navigation** menu appears in the multifunction display. The message shown in the multifunction display depends on the status of the navigation system:
 - With the COMAND system switched off, the message NAVI Off appears in the multifunction display.
 - With the COMAND system switched on but route guidance not activated, the direction of travel and, if applicable, the name of the street currently traveled on appear in the multifunction display.
 - With the COMAND system switched on and route guidance activated, the direction of travel and maneuver instructions appear in the multifunction display.

Please refer to separate COMAND system operating instructions for instructions on how to activate the route guidance system.

AIRMATIC/Compass menu

The AIRMATIC/Compass menu displays the messages for air suspension and the direction into which you are currently driving.

- ▶ Press button  or  repeatedly until one of the following messages appears in the multifunction display.

Vehicles with steel suspension:



Vehicles with air suspension or ML 63 AMG:



For information on air suspension, see “Air suspension program” (▷ page 155).

For information on the compass, see “Compass” (▷ page 207).

Distronic menu

Use the **Distronic** menu to display the current settings for your DISTRONIC system. The information shown in the multifunction display depends on whether the DISTRONIC system is activated or deactivated.

Please refer to the “Driving systems” section of this manual (▷ page 144) for instructions on how to activate DISTRONIC.

Vehicle status message memory menu

Use the **Vehicle status message memory** menu to scan malfunction and warning messages that may be stored in the memory. Such messages appear in the multifunction display and are based on conditions or system status the vehicle's system has recorded.



The **Vehicle status message memory** menu only appears if messages have been stored.

⚠ Warning!



Malfunction and warning messages are only indicated for certain systems and are intentionally not very detailed. The malfunction and warning messages are simply a reminder with respect to the operation of certain systems. They do not replace the owner's and/or driver's responsibility to maintain the vehicle's operating safety. Have all required maintenance and safety checks performed on the vehicle. Bring the vehicle to an authorized Mercedes-Benz Center to address the malfunction and warning messages.

⚠ Warning!

HYBRID vehicles: It is imperative that you read the HYBRID Supplemental Operating Instructions included in your vehicle literature portfolio. You may otherwise not recognize potential danger.

- ▶ Press button  or  repeatedly until the **Vehicle status message memory** menu appears in the multifunction display. If conditions have occurred causing status messages to be recorded, the number of messages appears in the multifunction display.



- ▶ Press button  or .
- The stored messages will now be displayed in the order in which they have occurred. For malfunction and warning messages, see “Vehicle status messages in the multifunction display” (▷ page 272).

- ⓘ After you have scrolled through all recorded status messages, the first recorded message appears again.

Should the vehicle's system record any conditions while driving, the number of messages will reappear in the multifunction display when the SmartKey in the starter switch is turned to position **0** or removed from the starter switch. With KEYLESS-GO, the number of messages will reappear when you turn off the engine by pressing the KEYLESS-GO start/stop button and open the driver's door.

Except for high-priority messages, the vehicle status message memory will be cleared when you switch off the ignition.

Settings menu

Introduction

In the Settings menu there are two functions: The function **To reset**, press reset button for 3 seconds, with which you can reset all the settings to the original factory settings and a collection of submenus with which you can make individual settings for your vehicle.

The following settings and submenus are available in the Settings menu:

- Resetting to factory settings (▷ page 129)
- Submenus in the Settings menu (▷ page 130)
- Instrument cluster submenu (▷ page 130)
- Time/Date submenu (▷ page 132)
- Lighting submenu (▷ page 133)
- Vehicle submenu (▷ page 135)
- Comfort submenu (▷ page 135)



Resetting to factory settings

You can reset the settings of all submenus to the factory settings.

For safety reasons, the function **Lamp Circuit Headlamp** in the **Lighting** submenu cannot be reset while driving.

The following message appears in the multifunction display:

Settings
Cannot be
completely reset
to factory settings
when engine is running.

- ▶ Press button  or  repeatedly until the Settings menu appears in the multifunction display.



- ▶ Press the reset button in the instrument cluster (▷ page 117) for approximately 3 seconds.



The request to press the reset button once more to confirm appears in the multifunction display.



- ▶ Press the reset button once more.

The settings you have changed will not be reset unless you confirm the action by pressing the reset button a second time. After approximately 5 seconds, the Settings menu reappears in the multifunction display.

Submenus in the Settings menu

▶ Press button  or  repeatedly until the Settings menu appears in the multifunction display.



▶ Press button .

The collection of the submenus appears in the multifunction display. There are more submenus than can be displayed simultaneously.







▶ Press button .

The selection marker moves to the next submenu.

▶ Scroll down with button , scroll up with button .

▶ With the selection marker on the desired submenu, use button  to access the individual functions within that submenu.

▶ Once within the submenu, use button  to move to the next function or button  to move to the previous function within that submenu.

▶ Use button  or  to change the settings of the respective function.

The following lists show what settings can be changed within the various menus. Detailed instructions on making individual settings can be found on the following pages.

Instrument cluster submenu

- Selecting speedometer/odometer display mode (▷ page 131) (Canada only)
- Selecting digital speedometer display mode (▷ page 131)

- Selecting language (▷ page 131)
- Selecting display (digital speedometer or outside temperature) for status indicator (▷ page 131)

Time/Date submenu

- Setting the time (▷ page 132)
- Setting the date (▷ page 132)

Lighting submenu

- Switching daytime running lamp mode on or off (USA only) (▷ page 133)
- Switching locator lighting on or off (▷ page 133)
- Switching night security illumination (Headlamps delayed shut-off feature) on or off (▷ page 134)
- Switching interior lighting delayed shut-off on or off (▷ page 135)

Vehicle submenu

- Switching automatic central locking on or off (▷ page 135)

Comfort submenu

- Activating easy-entry/exit feature (▷ page 136)
- Activating/deactivating seat belt adjustment feature (▷ page 136)
- Switching fold-in function for exterior rear view mirrors on or off (▷ page 137)

Instrument cluster submenu







Access the Instrument Cluster submenu via the Settings menu. Use the Instrument Cluster submenu to change the instrument cluster display settings.

The following functions are available:



- Selecting speedometer/odometer display mode (▷ page 131) (Canada only)
- Selecting digital speedometer display mode (▷ page 131)

- Selecting language (▷ page 131)
- Selecting display (digital speedometer or outside temperature) for status indicator (▷ page 131)







Selecting speedometer/odometer display mode (Canada only)

- ▶ Press button  or  repeatedly until the Settings menu appears in the multifunction display.
- ▶ Press button .
- ▶ Move the selection marker with button  or  to the Instrument Cluster submenu.
- ▶ Press button  or  repeatedly until the message Display Unit Speedometer/Odometer appears in the multifunction display. The selection marker is on the current setting.





- ▶ Press button  or  to set speedometer/odometer unit to Km or Miles.

Selecting digital speedometer display mode







- ▶ Press button  or  repeatedly until the Settings menu appears in the multifunction display.
- ▶ Press button .
- ▶ Move the selection marker with button  or  to the Instrument Cluster submenu.
- ▶ Press button  or  repeatedly until the message Display Unit Digital

Speedometer appears in the multifunction display. The selection marker is on the current setting.





- ▶ Press button  or  to set digital speedometer unit to Km or Miles.

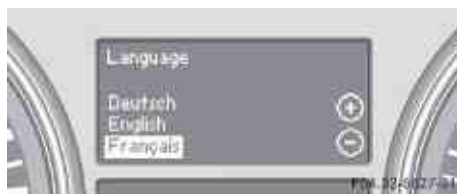

Selecting language





- ▶ Press button  or  repeatedly until the Settings menu appears in the multifunction display.
- ▶ Press button .
- ▶ Move the selection marker with button  or  to the Instrument Cluster submenu.
- ▶ Press button  or  repeatedly until the message Language appears in the multifunction display. The selection marker is on the current setting.





- ▶ Press button  or  to select the language to be used for the multifunction display messages.

Selecting display (digital speedometer or outside temperature) for status indicator

- ▶ Press button  or  repeatedly until the Settings menu appears in the multifunction display.
- ▶ Press button .

- ▶ Move the selection marker with button  or  to the Instrument Cluster submenu.
- ▶ Press button  or  repeatedly until the message Status Line Display appears in the multifunction display. The selection marker is on the current setting.



- ▶ Press button  or  to select the desired setting. The selected display is then shown continuously in the status indicator (lower display). The other display now appears in the **Standard display** menu (▷ page 122).

Time/Date submenu

Access the Time/Date submenu via the Settings menu. Use the Time/Date submenu to change the time and date display settings.







The following functions are available:

- Setting the time (▷ page 132)
- Setting the date (▷ page 132)

If your vehicle is equipped with the COMAND system and navigation module, see separate COMAND system operating instructions for information on how to set the time and date.



Setting the time

This function is not available if your vehicle is equipped with the COMAND system and navigation module.

- ▶ Press button  or  repeatedly until the Settings menu appears in the multifunction display.
- ▶ Press button .
- ▶ Move the selection marker with button  or  to the Time/Date submenu.
- ▶ Press button  or  repeatedly until the message Clock Set Hour or Clock Set Minute(s) appears in the multifunction display. The selection marker is on the current setting.









Example illustration for setting the hour

- ▶ Press button  or  to set the hours or minute(s).

Setting the date

This function is not available if your vehicle is equipped with the COMAND system and navigation module.

- ▶ Press button  or  repeatedly until the Settings menu appears in the multifunction display.
- ▶ Press button .
- ▶ Move the selection marker with button  or  to the Time/Date submenu.
- ▶ Press button  or  repeatedly until the message Date Set Month, Date Set Day, or Date Set Year appears in the multifunction display. The selection marker is on the current setting.



Example illustration for setting the month

- ▶ Press button or to set the month, day, or year.

Lighting submenu

Access the Lighting submenu via the Settings menu. Use the Lighting submenu to change the lamp and lighting settings on your vehicle.

The following functions are available:

- Switching daytime running lamp mode on or off (USA only) (▷ page 133)
- Switching locator lighting on or off (▷ page 133)
- Switching night security illumination on or off (▷ page 134)
- Switching interior lighting delayed shut-off on or off (▷ page 135)

Switching daytime running lamp mode on or off (USA only)

- ▶ Press button or repeatedly until the Settings menu appears in the multifunction display.
- ▶ Press button .
- ▶ Move the selection marker with button or to the Lighting submenu.
- ▶ Press button or repeatedly until the message Daytime Running Lamps appears in the multifunction display. The selection marker is on the current setting.



- ▶ Press button or to switch the daytime running lamp mode On or Off.

With daytime running lamp mode switched on and the exterior lamp switch in position or **AUTO**, the low-beam headlamps are switched on when the engine is running.

In low ambient light conditions the following lamps will come on additionally:

- Parking lamps
- Tail lamps
- License plate lamps
- Side marker lamps

For more information on the daytime running lamp mode, see (▷ page 94).

For safety reasons, changing the setting for the daytime running lamp mode is not possible while the vehicle is in motion.

The following message appears in the multifunction display:

Settings can only be made with engine off.

For safety reasons, resetting all the functions of all submenus to the factory settings while driving (▷ page 129) will not deactivate the daytime running lamp mode.

Switching locator lighting on or off

With the locator lighting feature activated, the exterior lamp switch in position **AUTO** and the interior lighting in automatic mode, the following lamps will come on during darkness when the vehicle is unlocked using button







on the SmartKey:

- Parking lamps
- Tail lamps



- License plate lamps
- Side marker lamps
- Front fog lamps

The locator lighting goes out when the driver's door is opened.

If you do not open the driver's door after unlocking the vehicle with the SmartKey, the lamps will go out automatically after approximately 40 seconds.

- ▶ Press button  or  repeatedly until the Settings menu appears in the multifunction display.
- ▶ Press button .
- ▶ Move the selection marker with button  or  to the Lighting submenu.
- ▶ Press button  or  repeatedly until the message Surround Lighting Function appears in the multifunction display. The selection marker is on the current setting.



- ▶ Press button  or  to switch the locator lighting function On or Off.
- ▶ Turn the exterior lamp switch to position **AUTO** when exiting the vehicle. The locator lighting feature is activated.







Switching night security illumination (Headlamps delayed shut-off feature) on or off

Use this function to set whether you would like the exterior lamps to remain on for 15 seconds during darkness after exiting the vehicle and closing all doors.



With the headlamps delayed shut-off feature activated and the exterior lamp switch in position **AUTO** before the engine is turned off, the following lamps will come on when the engine is turned off:

- Parking lamps
- Tail lamps
- License plate lamps
- Side marker lamps
- Front fog lamps

If, after turning off the engine, you do not open a door or do not close an opened door, the lamps will automatically go out after 60 seconds.

- ▶ Press button  or  repeatedly until the Settings menu appears in the multifunction display.
- ▶ Press button .
- ▶ Move the selection marker with button  or  to the Lighting submenu.
- ▶ Press button  or  repeatedly until the message Headlamp Delayed Shut-off appears in the multifunction display. The selection marker is on the current setting.









- ▶ Press button  or  to switch the headlamps delayed shut-off feature On or Off.
- ▶ Turn the exterior lamp switch to position **AUTO** before turning off the engine. The headlamps delayed shut-off feature is activated.

You can temporarily deactivate the headlamps delayed shut-off feature:



- ▶ Before exiting the vehicle, turn the SmartKey in the starter switch to position **0**.
- ▶ Then turn it to position **2** and back to position **0**.
The headlamps delayed shut-off feature is deactivated. It will reactivate as soon as you start the engine.

Switching interior lighting delayed shut-off on or off

Use this function to set whether you would like the interior lighting to remain on for 10 seconds during darkness after you have removed the SmartKey from the starter switch.

- ▶ Press button  or  repeatedly until the Settings menu appears in the multifunction display.
- ▶ Press button .
- ▶ Move the selection marker with button  or  to the Lighting submenu.
- ▶ Press button  or  repeatedly until the message Interior Lighting Delayed Shut-off appears in the multifunction display.
The selection marker is on the current setting.









- ▶ Press button  or  to switch the interior lighting delayed shut-off feature On or Off.

Vehicle submenu



Access the Vehicle submenu via the Settings menu. Use the Vehicle submenu to set the automatic central locking.

Switching automatic central locking on or off

Use this function to switch the automatic central locking on or off. With the automatic central locking activated, the vehicle is locked centrally at a vehicle speed of approximately 9 mph (15 km/h).

- ▶ Press button  or  repeatedly until the Settings menu appears in the multifunction display.
- ▶ Press button .
- ▶ Move the selection marker with button  or  to the Vehicle submenu.
- ▶ Press button  or  repeatedly until the message Automatic Door Locking appears in the multifunction display.
The selection marker is on the current setting.



- ▶ Press button  or  to switch the automatic central locking On or Off.

Comfort submenu

Access the Comfort submenu via the Settings menu.

The following functions are available:

- Activating easy-entry/exit feature (▷ page 136)
- Activating/deactivating the seat belt adjustment feature (▷ page 136)
- Switching fold-in function for exterior rear view mirrors on or off (▷ page 137)

Activating easy-entry/exit feature

Use this function to activate and deactivate the easy-entry/exit feature (▷ page 87).







Warning!

You must make sure no one can become trapped or injured by the moving steering wheel when the easy-entry/exit feature is activated.



To stop steering wheel movement do one of the following:

- Move steering wheel adjustment stalk.
- Press one of the memory position buttons.
- Press memory button **M**.

Do not leave children unattended in the vehicle, or with access to an unlocked vehicle. Children could open the driver's door and unintentionally activate the easy-entry/exit feature, which could result in an accident and/or serious personal injury.

- ▶ Press button  or  repeatedly until the Settings menu appears in the multifunction display.
- ▶ Press button .
- ▶ Move the selection marker with button  or  to the Comfort submenu.
- ▶ Press button  or  repeatedly until the message Easy-entry Function appears in the multifunction display. The selection marker is on the current setting.









- ▶ Press button  or  to activate (On) or deactivate (Off) the easy-entry/exit feature.



Activating/deactivating seat belt adjustment feature

Use this feature to set the seat belts to be adjusted automatically with the driver's or front passenger seat belt fastened and the starter switch in position **2**.

For more information on the seat belt adjustment feature, see (▷ page 51).

- ▶ Press button  or  repeatedly until the Settings menu appears in the multifunction display.
- ▶ Press button .
- ▶ Move the selection marker with button  or  to the Comfort submenu.
- ▶ Press button  or  repeatedly until the message Belt Adjustment appears in the multifunction display. The selection marker is on the current setting.









- ▶ Press button  or  to activate (On) or deactivate (Off) the seat belt adjustment feature.

Switching fold-in function for exterior rear view mirrors on or off

Use this function to set the exterior rear view mirrors to be folded in automatically when you lock your vehicle.



With this function set to **On** and the exterior rear view mirrors folded in using the button on the door control panel (▷ page 91), the exterior rear view mirrors will not fold out when you switch on the ignition. You will then have to fold out the exterior rear view mirrors using the button on the door control panel (▷ page 91).

Make sure both exterior rear view mirrors are folded out completely before driving off.

- ▶ Press button  or  repeatedly until the **Settings** menu appears in the multifunction display.
- ▶ Press button .
- ▶ Move the selection marker with button  or  to the **Comfort** submenu.
- ▶ Press button  or  repeatedly until the message **Fold In Mirrors When Locking** appears in the multifunction display.

The selection marker is on the current setting.







- ▶ Press button  or  to switch the function **On** or **Off**.

Vehicle configuration menu



Use the **Vehicle configuration** menu to activate/deactivate the Distance warning function (▷ page 137) or to set the DSR speed (▷ page 138).

Distance warning function

In vehicles equipped with DISTRONIC, you can determine whether the distance warning function is to be enabled or disabled. With this function set to **On**, the system will alert you when recognizing a stationary obstacle or a slower vehicle moving in your vehicle's path and the danger of a collision exists, even when the DISTRONIC is switched off.



- ▶ Press button  or  repeatedly until the **vehicle configuration** menu appears in the multifunction display.
- ▶ Press button  or  repeatedly until the message **Distance Warning** appears in the multifunction display. The selection marker is on the current setting.



- ▶ Press button  or  to switch the distance warning function **On** or **Off**.







- ① Symbol for activated distance warning function



If the distance warning function is switched on you will see the symbol  in the Standard display. When the distance warning function is switched off the symbol  will not appear.

DSR (Downhill Speed Regulation) programmed default speed

Use this function to program the default speed the DSR is set to when it is activated. You can program the default speed between 3 - 10 mph (Canada: 4- 18 km/h). The set value is increased in 1 mph (Canada: 2 km/h) increments.

- ▶ Press button  or  repeatedly until the **Vehicle configuration** menu appears in the multifunction display.
- ▶ Press button  or  repeatedly until the message DSR Speed appears in the multifunction display. The selection marker is on the current setting.



- ▶ Press button  or  repeatedly until the desired speed is shown in the multifunction display. When DSR is switched on, DSR will use the programmed default speed to regulate the vehicle's speed.
- Once DSR is switched on, you can adjust the set speed using the cruise control lever (▷ page 154).

Trip computer menu

Use the **Trip computer** menu to call up statistical data on your vehicle.

The following information is available:

- Fuel consumption statistics since start (▷ page 138)
- Fuel consumption statistics since last reset (▷ page 138)

- Resetting fuel consumption statistics (▷ page 139)
- Distance to empty (▷ page 139)
- Current fuel consumption (▷ page 139)

When you enter the **Trip computer** menu, you will always see the fuel consumption statistics since start first.

Fuel consumption statistics since start



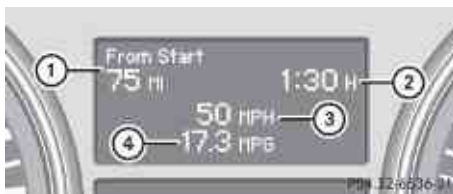

- ▶ Press button  or  repeatedly until the message From Start appears in the multifunction display.



- ① Distance driven since start
- ② Time elapsed since start
- ③ Average speed since start
- ④ Average fuel consumption since start

All statistics stored since the last engine start will be reset approximately 4 hours after the SmartKey in the starter switch is turned to position **0** or removed from the starter switch. Resetting will not occur if you turn the SmartKey back to position **1** or **2** within this time period.

Fuel consumption statistics since last reset

- ▶ Press button  or  repeatedly until the message From Start appears in the multifunction display.
- ▶ Press button  or  repeatedly until the message From Reset appears in the multifunction display.



- ① Distance driven since last reset
- ② Time elapsed since last reset
- ③ Average speed since last reset
- ④ Average fuel consumption since last reset

Resetting fuel consumption statistics

- ▶ Press button or repeatedly until the message **From Start** appears in the multifunction display.
- ▶ Press button or repeatedly until the reading that you want to reset appears in the multifunction display.
- ▶ Press and hold the reset button in the instrument cluster until the respective values are reset to 0.

The fuel consumption statistics reset automatically to 0 after 99 999 miles or 9 999 hours, whichever occurs first.

Distance to empty

- ▶ Press button or repeatedly until the message **From Start** appears in the multifunction display.
- ▶ Press button or repeatedly until the message **Range:** appears in the multifunction display. The calculated remaining driving range based on the current fuel tank level appears in the multifunction display. If only very little fuel is left in the tank, a vehicle at the fuel pump appears instead of the remaining driving range.



Current fuel consumption

- ▶ Press button or repeatedly until the message **From Start** appears in the multifunction display.
- ▶ Press button or repeatedly until the message **Consumption** appears in the multifunction display. The current fuel consumption appears in the multifunction display.

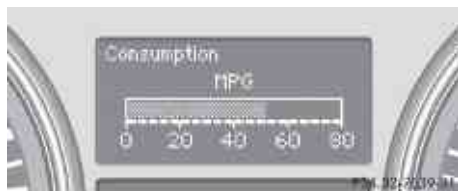



Telephone menu

Warning!

A driver's attention to the road must always be his/her primary focus when driving. For your safety and the safety of others, we recommend that you pull over to a safe location and stop before placing or taking a telephone call. If you choose to use the telephone while driving, please use the hands-free device and only use the telephone when weather, road and traffic conditions permit. Some jurisdictions prohibit the driver from using a mobile phone while driving a vehicle. Bear in mind that at a speed of just 30 mph (approximately 50 km/h), your vehicle is covering a distance of 44 feet (approximately 14 m) every second.

You can connect your telephone to the COMAND system via Bluetooth®, see

separate COMAND system operating instructions.

- ▶ Switch on the COMAND system.
Refer to separate COMAND system operating instructions.
- ▶ Press button  or  repeatedly until the message TEL appears in the multifunction display.
One of the following messages will appear in the multifunction display:
 - No Service: No network is available.
 - Bluetooth Ready: The telephone has not been connected to the COMAND system via Bluetooth® yet.
 - ▶ Connect the telephone to the COMAND system via Bluetooth®.
 - Ready or name of the network provider (if available): The telephone has found a network and is ready for use. You can operate it using the control system.

Answering a call

When your telephone is ready to receive calls, you can answer a call at any time. In the multifunction display you will then see the following message, or if available, the caller ID (number or name):







- ▶ Press button .
You have answered the call.



Ending a call or rejecting an incoming call

- ▶ Press button .

Dialing a number from the phone book

When your telephone is ready to receive calls, you may select and dial a number from the phone book at any time.

- ▶ Press button  or  repeatedly until the message TEL appears in the multifunction display.
- ▶ Press button  or  repeatedly until the desired name appears in the multifunction display.

If you press and hold button  or  for longer than 1 second, the system scrolls rapidly through the list of names until you release the button again. The stored names are displayed in alphabetical order.



- ① Selected name from the phone book

- ▶ Press button .
The control system dials the selected phone number.
If the connection is successful and this feature is supported by your network provider, the name of the party (if stored in your phone book) you are calling will appear in the multifunction display. The control system stores the dialed number in the redial memory.



or



- ▶ Press button  if you do not want to make the call.



Redialing

The control system stores the most recently dialed phone numbers. This eliminates the need to search through your entire phone book.

- ▶ Press button  or  repeatedly until the message TEL appears in the multifunction display.
- ▶ Press button .

The first number in the redial memory appears in the multifunction display.
- ▶ Press button  or  repeatedly until the desired number or name appears in the multifunction display.
- ▶ Press button .

The control system dials the selected phone number.

Driving systems

Introduction

This section describes the following driving systems of your vehicle:

- Cruise control
- DISTRONIC
- Distance warning function (only available with DISTRONIC)
- Hill-start assist system
- Downhill Speed Regulation (DSR)
- Off-road driving program
- Air suspension program (Adaptive Damping System (ADS) and vehicle level control)
- All-wheel drive (4MATIC)
- Parktronic system
- Rear view camera

The driving safety systems ABS, BAS, EBP, ESP® and 4-ETS are described in the “Safety and security” section (▷ page 61).

Cruise control

The cruise control maintains the speed you set for your vehicle automatically.

The use of the cruise control is recommended for driving at a constant speed for extended periods of time.

The currently set speed or last set speed (“Resume” function) appears in the status indicator of the multifunction display:

- USA only: e.g. Cruise 55 Miles
- Canada only: e.g.  90 Km/h

- ❗ The cruise control should not be activated during off-road driving.

Warning!

The cruise control is a convenience system designed to assist the driver during vehicle operation. The driver is and must always remain responsible for the vehicle’s speed and for safe brake operation.

Only use the cruise control if the road, traffic, and weather conditions make it advisable to travel at a constant speed.

- The use of the cruise control can be dangerous on winding roads or in heavy traffic because conditions do not allow safe driving at a constant speed.
- The use of the cruise control can be dangerous on slippery roads. Rapid changes in tire traction can result in wheel spin and loss of control.
- Deactivate the cruise control when driving in fog.

The “Resume” function should only be operated if the driver is fully aware of the previously set speed and wishes to resume this particular preset speed.

⚠ Warning!

When the cruise control is braking, the brake pedal is retracted (i.e. depressed automatically). The pedals' range of motion must not be impeded by any obstacles:

- Do not place any objects in the footwell.
- Make sure that the floor mats and carpets are securely in place.
- Do not rest your foot underneath the brake pedal, as it could otherwise be trapped.

You could otherwise cause an accident and injure yourself and/or others.

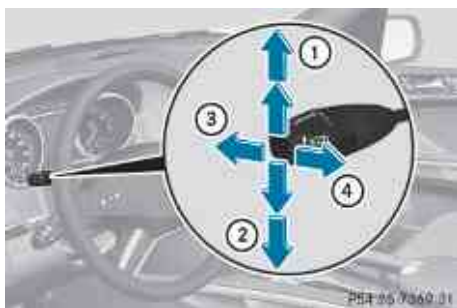

- ① Setting current or higher speed
- ② Setting current or lower speed
- ③ Canceling the cruise control
- ④ Activating the cruise control or resuming to last set speed

Activating cruise control

You can activate the cruise control at a vehicle speed above 20 mph (30 km/h).

You cannot activate the cruise control

- when you brake
- when you have engaged the parking brake
- when the automatic transmission is in park position **P**, reverse gear **R**, or neutral position **N**
- the ESP® is switched off or has switched off due to a malfunction

The vehicle speed displayed in the speedometer can briefly vary from the speed setting for the cruise control system.

Setting current speed

- ▶ Accelerate or decelerate to the desired speed.
- ▶ Briefly lift the cruise control lever in direction of arrow ① or press in direction of arrow ②.
- ▶ Remove your foot from the accelerator pedal.

i On uphill grades, the cruise control may not be able to maintain the set speed. Once the grade eases, the set speed will be resumed.

On downhill grades, the cruise control maintains the set speed by braking with the vehicle's brake system. In addition, on longer downhill grades the automatic transmission will downshift automatically.

Canceling cruise control

- ▶ Depress the brake pedal.
- or
- ▶ Briefly push the cruise control lever in direction of arrow ③.

The last set speed is stored for later use.

The last stored speed is deleted from memory when the engine is turned off.

The cruise control switches off automatically when you depress the brake pedal or you engage the parking brake.

The cruise control switches off automatically and an acoustic warning will sound when

- the vehicle speed falls below 20 mph (30 km/h)
- the ESP® is in operation
- the ESP® is switched off with the ESP® switch

- the ESP® has switched off due to a malfunction
- you shift the automatic transmission into neutral position **N** while driving

Observe additional messages in the multifunction display that may appear.

Depressing the accelerator pedal does not deactivate the cruise control. After a brief acceleration (e.g. for passing), the cruise control will resume the last set speed.

Changing the set speed

Warning!

Keep in mind that it may take a brief moment until the vehicle has made the necessary adjustments.

Increase or decrease the set vehicle speed to a value that the prevailing road conditions and legal speed limits permit. Otherwise, sudden and unexpected acceleration or deceleration of the vehicle could cause an accident and/or serious injury to you and others.

You can increase or decrease the set speed in 1 mph (Canada: 1 km/h) increments or in 5 mph (Canada: 10 km/h) increments.

When you use the cruise control lever to decelerate, the brake system will brake the vehicle automatically if the engine's braking power does not brake the vehicle sufficiently.

Adjustment in 1 mph (Canada: 1 km/h) increments

- i** The set speed value is increased or decreased in 1 mph (Canada: 1 km/h) increments each time you lift or press the cruise control lever up or down to the resistance point.

- ▶ **Increasing:** Briefly lift the cruise control lever up to the resistance point in direction of arrow ①.
- ▶ **Decreasing:** Briefly press the cruise control lever down to the resistance point in direction of arrow ②.
- ▶ Release the cruise control lever. The new speed is set and the vehicle will accelerate or decelerate.

Adjustment in 5 mph (Canada: 10 km/h) increments

- i** The set speed value is increased or decreased in 5 mph (Canada: 10 km/h) increments each time you lift or press the cruise control lever up or down past the resistance point.
- ▶ **Increasing:** Briefly lift the cruise control lever up past the resistance point in direction of arrow ①.
- ▶ **Decreasing:** Briefly press the cruise control lever down past the resistance point in direction of arrow ②.
- ▶ Release the cruise control lever. The new speed is set and the vehicle will accelerate or decelerate. Keep in mind that it may take a brief moment until the vehicle has reached the set speed.

Setting stored speed (Resume function)

Warning!

The set speed stored in memory should only be set again if prevailing road conditions and legal speed limits permit. Possible acceleration or deceleration differences arising from returning to the preset speed could cause an accident and/or serious injury to you and others.

- ▶ Briefly pull the cruise control lever in direction of arrow ④.
If no speed is stored, the current speed is set and stored.
- ▶ Remove your foot from the accelerator pedal.

The last stored speed is deleted from memory when the engine is turned off.

Distronic

Safety notes

When activated, the Distronic adaptive cruise control increases the driving convenience afforded by the cruise control while traveling on expressways and other major roadways.

- If the Distronic distance sensor detects a slower moving vehicle directly ahead, your vehicle speed will be reduced so that you follow that vehicle at your preset following distance.
- If there is no vehicle directly ahead of you, the Distronic will function in the same way as standard cruise control (> page 141).

Warning!

The Distronic requires familiarity with its operational characteristics. We strongly recommend that you review the following information carefully before operating the system.

Warning!

HYBRID vehicles: It is imperative that you read the HYBRID Supplemental Operating Instructions included in your vehicle literature portfolio. You may otherwise not recognize potential danger.

Warning!

When the Distronic is braking, the brake pedal is retracted (i.e. depressed automatically). The pedals' range of motion must not be impeded by any obstacles:

- Do not place any objects in the footwell.
- Make sure that the floormats and carpets are securely in place.
- Do not rest your foot underneath the brake pedal, as it could otherwise be trapped.

You could otherwise cause an accident and injure yourself and/or others.

Warning!

The Distronic is a convenience system. Its speed adjustment reduction capability is intended to make cruise control more effective and usable when traffic speeds vary. It is not however, intended to, nor does it, replace the need for extreme care.

The responsibility for the vehicle's speed, distance to the preceding vehicle and, most importantly, brake operation to ensure a safe stopping distance, always remains with the driver.

The Distronic cannot take street and traffic conditions into account. Complex driving situations are not always fully recognized by the Distronic. This could result in wrong or missing distance warnings.

Warning!

The Distronic adaptive cruise control is not a substitute for active driving involvement. It does not react to pedestrians or on stationary objects, nor does it recognize or predict the lane curvature or the movement of preceding vehicles.

The Distronic can only apply 20% of the maximum braking power of the vehicle.

It is the driver's responsibility at all times to be attentive to the road, weather and traffic conditions. Additionally, the driver must provide the steering, braking and other driving

inputs necessary to remain in control of the vehicle.

High-frequency sources such as toll stations, speed measuring systems etc. can cause the Distronic system to malfunction.

 **Warning!**

The Distronic cannot take road and traffic conditions into account. Only use the Distronic if the road, weather and traffic conditions make it advisable to travel at a constant speed.

 **Warning!**

Use of the Distronic can be dangerous on slippery roads. Rapid changes in tire traction can result in wheel spin and loss of control.

The Distronic does not function in adverse sight and distance conditions. Do not use the Distronic during conditions of fog, heavy rain, snow or sleet.

 **Warning!**

The Distronic cannot take weather conditions into account. Switch off the Distronic or do not switch it on if:

- roads are slippery or covered with snow or ice. The wheels could lose traction while braking or accelerating, and the vehicle could skid.
- the Distronic system sensor cover is dirty or visibility is diminished due to snow, rain or fog, for example. The distance control system functionality could be impaired.

Always pay attention to surrounding traffic conditions even while the Distronic is switched on. Otherwise, you may not be able to recognize dangerous situations until it is too late. This could cause an accident in which you and/or others could be injured.

 **Warning!**

The “Resume” function should only be operated if the driver is fully aware of the

previously set speed and wishes to resume this particular preset speed.

 **Warning!**

Close attention to road and traffic conditions is imperative at all times, regardless of whether or not the Distronic is activated.

Use of the Distronic can be dangerous on winding roads or in heavy traffic because conditions do not allow safe driving at a constant speed.

The Distronic will not react to stationary objects in the roadway (e.g. a stopped vehicle in a traffic jam or a disabled vehicle). The Distronic will also not respond to oncoming vehicles.

Switch off the Distronic:

- when changing from the left to the right lane if vehicles are moving more slowly in the left lane
- when entering a turn lane or highway off ramp
- in complex driving situations, such as in highway construction zones

In these situations, the Distronic will continue to maintain the set speed unless deactivated.

The Distronic is designed and intended only to maintain a set speed and keep a set distance from moving objects in front of it.

 This device has been approved by the FCC as a “Vehicular Radar System”. The radar sensor is intended for use in an automotive radar system only. Removal, tampering, or altering of the device will void any warranties, and is not permitted by the FCC. Do not tamper with, alter, or use in any non-approved way.

Any unauthorized modification to this device could void the user’s authority to operate the equipment.

Distronic displays in the speedometer



When the DISTRONIC is activated, one or two cruise control speed segments come on around set speed ①.

The vehicle speed displayed on the speedometer can briefly vary from the speed setting on the DISTRONIC system.



When the DISTRONIC detects a vehicle directly ahead, the cruise control speed segments ② appear in the speedometer. These segments represent the difference between the set speed of your vehicle ① and the speed of the preceding vehicle ③.

If the DISTRONIC calculates that there is a danger of collision, the distance warning lamp  in the instrument cluster comes on and an intermittent warning sounds.

- ▶ Immediately apply the brakes to avoid a collision.
Under no circumstances should the driver await the intermittent warning sound before braking.

The intermittent warning sound ceases and the distance warning lamp  goes out when the necessary distance to the vehicle ahead is established again.

Warning!

An intermittent warning sounds and the distance warning lamp  in the instrument cluster is illuminated if the DISTRONIC system calculates that the distance to the vehicle ahead and your vehicle's current speed indicate that the DISTRONIC will not be capable of slowing the vehicle sufficiently to maintain the preset following distance, which creates a danger of a collision.

Immediately brake the vehicle to increase your distance to the preceding vehicle. The warning sound is intended as a final caution in which you should intercede with your own braking inputs to avoid a potentially dangerous situation. Do not wait for the operation of the warning signal to intercede with your own braking. This will result in potentially dangerous emergency braking which will not always result in an impact being avoided.

Tailgating increases the risk of an accident.

Warning!

The DISTRONIC brakes your vehicle with a maximum deceleration of 6.5 ft/s² (2 m/s²). This corresponds to approximately 20% of the maximum deceleration of your vehicle.

You must also apply the brakes yourself to avoid a collision. The DISTRONIC brakes the vehicle in an effort to restore the preset distance or to maintain the set speed. The brake pedal is automatically applied as this happens which results in the brake pedal moving

Keep driver's foot area clear at all times, including the area under the brake pedal. Objects stored in this area may impair pedal movement which could interfere with the braking ability of the DISTRONIC system.



Do not place your foot under the brake pedal – your foot could become caught.

Distronic menu in the control system

Use the DISTRONIC menu to display the current settings for your DISTRONIC system. The information shown in the multifunction display depends on whether the DISTRONIC system and/or the distance warning function are activated or deactivated.

- ① To activate or deactivate the DISTRONIC system, see (▷ page 147) or see (▷ page 149).

To activate or deactivate the Distance warning function, see (▷ page 137).

- ▶ Press button  or  repeatedly until one of the following two displays appears in the multifunction display.

Distronic deactivated

When the DISTRONIC is deactivated, you will see the standard DISTRONIC display in the multifunction display.

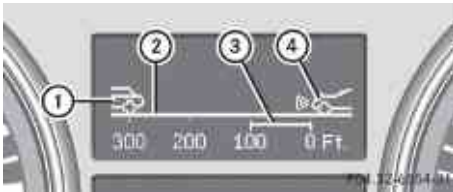

- ① Preceding vehicle, if detected
- ② Actual distance to the preceding vehicle
- ③ Preset distance threshold to the preceding vehicle
- ④ Your vehicle

Distronic activated

When the DISTRONIC is activated ①, you will see the set speed ② in the multifunction display for approximately 5 seconds. The following display appears in the multifunction display.



After approximately 5 seconds the currently set speed ② appears in the status indicator of the multifunction display:
DTR XXX Miles

Cruise control lever

The DISTRONIC system is operated by means of the cruise control lever.

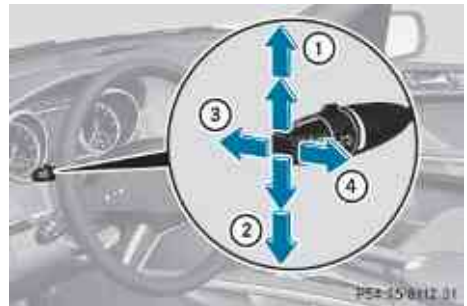

- ① Setting current or higher speed
- ② Setting current or lower speed
- ③ Deactivating the DISTRONIC
- ④ Activating the DISTRONIC or resuming to the last set speed

Activating DISTRONIC

You can activate the DISTRONIC when the vehicle speed is between 20 mph (30 km/h) and 110 mph (180 km/h).

When the DISTRONIC is activated, one or two cruise control speed segments around the set speed in the speedometer dial are illuminated. The multifunction display will show a message such as
DISTRONIC 55 MPH
(Canada: DISTRONIC 90 km/h).

After approximately 5 seconds the currently set speed appears in the status indicator of the multifunction display:

- USA only: e.g. DTR 55 Miles
- Canada only: e.g. DTR 90 km/h

If the Distronic is not activated after the cruise control lever is pulled in direction of arrow ④ (▷ page 147), you will see the message **DISTRONIC Off** in the multifunction display.

In the following cases you cannot activate the Distronic:

- up to 2 minutes after starting the engine
- when you brake
- when you have engaged the parking brake
- when the automatic transmission is in park position **P**, reverse gear **R**, or neutral position **N**
- when the ESP® is switched off or has switched off due to a malfunction

The vehicle speed displayed on the speedometer can briefly vary from the speed setting on the Distronic system.

Setting the current speed

- ▶ Accelerate or decelerate to the desired speed.
- ▶ Briefly lift the cruise control lever in direction of arrow ① or depress in direction of arrow ② (▷ page 147).
- ▶ Remove your foot from the accelerator pedal.

i If you do not take your foot off of the accelerator pedal and continue to accelerate past the set speed, the following message will appear in the multifunction display:

DISTRONIC Override

The distance to a slower moving vehicle in front of you will not be set. Your vehicle speed will then be determined only by the accelerator pedal position.

Changing the set speed

⚠ Warning!

Keep in mind that it may take a brief moment until the vehicle has made the necessary adjustments.

Increase or decrease the set vehicle speed to a value that the prevailing road conditions and legal speed limits permit. Otherwise, sudden and unexpected acceleration or deceleration of the vehicle could cause an accident and/or serious injury to you and others.

You can increase or decrease the set speed in 1 mph (Canada: 1 km/h) increments or in 5 mph (Canada: 10 km/h) increments.

When you use the cruise control lever to decelerate, the brake system will brake the vehicle automatically if the engine's braking power does not brake the vehicle sufficiently.

Adjustment in 1 mph (Canada: 1 km/h) increments

i The set speed value is increased or decreased in 1 mph (Canada: 1 km/h) increments each time you lift or press the cruise control lever up or down to the resistance point.

- ▶ **Increasing:** Briefly lift the cruise control lever up to the resistance point in direction of arrow ① (▷ page 147).
- ▶ **Decreasing:** Briefly press the cruise control lever down to the resistance point in direction of arrow ② (▷ page 147).
- ▶ Release the cruise control lever. The new speed is set and the vehicle will accelerate or decelerate.

Adjustment in 5 mph (Canada: 10 km/h) increments

i The set speed value is increased or decreased in 5 mph (Canada: 10 km/h) increments each time you lift or press the cruise control lever up or down past the resistance point.

- ▶ **Increasing:** Briefly lift the cruise control lever up past the resistance point in direction of arrow ① (▷ page 147).
- ▶ **Decreasing:** Briefly press the cruise control lever down past the resistance point in direction of arrow ② (▷ page 147).
- ▶ Release the cruise control lever. The new speed is set and the vehicle will accelerate or decelerate. Keep in mind that it may take a brief moment until the vehicle has reached the set speed.

Setting stored speed (Resume function)

Warning!

The set speed stored in memory should only be set again if prevailing road conditions and legal speed limits permit. Possible acceleration or deceleration differences arising from returning to the preset speed could cause an accident and/or serious injury to you and others.

- ▶ Briefly pull the cruise control lever in direction of arrow ④ (▷ page 147). If no speed is stored, the current speed is set and stored.
- ▶ Remove your foot from the accelerator pedal.

Deactivating Distronic

- ▶ Depress the brake pedal.

or

- ▶ Briefly push the cruise control lever in direction of arrow ③ (▷ page 147). The cruise control speed segments in the speedometer dial will go out and the following message appears briefly in the multifunction display: **DISTRONIC Off**. The last set speed is stored for later use.

The last stored speed is deleted from memory when the engine is turned off.

The Distronic switches off automatically when you depress the brake pedal or you

engage the parking brake. In this case, the cruise control speed segments in the speedometer dial will go out.

The Distronic also switches off automatically when

- the vehicle speed falls below 20 mph (30 km/h)
- the ESP® is in operation
- the ESP® is switched off with the ESP® switch
- the ESP® has switched off due to a malfunction
- you shift the automatic transmission into neutral position **N** while driving

The cruise control speed segments in the speedometer dial goes out and an acoustic warning will sound. Observe additional messages in the multifunction display that may appear.

Warning!

Distronic switches off and releases the brakes when the vehicle decelerates below the minimum speed of 20 mph (30 km/h) by operation of the system. At that time the driver must apply the brakes in order to reduce vehicle speed further or bring it to a stop.

Depressing the accelerator pedal does not deactivate the Distronic. After a brief acceleration (e.g. for passing), the Distronic will resume the last set speed.

Setting the following distance in Distronic

You can set the specified following distance for Distronic by varying the time setting between 1.0 and 2.0 seconds. Using this time setting and the current speed of your vehicle, Distronic calculates and sets the required following distance to the preceding vehicle. The set distance will be shown in the multifunction display.

Warning!

It is up to the driver to exercise discretion to select the appropriate setting given road conditions, traffic, driver's preferred driving style and applicable laws and driving recommendations for safe following distance.



- ▶ **Increasing distance:** Turn distance setting switch ① in direction of arrow ③.

Increasing the distance setting tells DISTRONIC to maintain a greater following distance to the preceding vehicle.

- ▶ **Decreasing distance:** Turn distance setting switch ① in direction of arrow ②.

Decreasing the distance setting tells DISTRONIC to maintain a shorter following distance to the preceding vehicle.

Driving with DISTRONIC

This section describes a number of driving situations where special precaution is required on the part of the driver. Be prepared to brake in such situations. Braking will deactivate the DISTRONIC system.

Warning!

The DISTRONIC works to maintain the speed selected by the driver unless a moving obstacle proceeding directly ahead of it in the same travel direction is detected (e.g. following another vehicle ahead of you at your set distance).

This means that:

- Your vehicle can pass another vehicle after you have changed lanes.
- While in a sharp turn or if the preceding vehicle is in a sharp turn, the DISTRONIC could lose sight of the preceding vehicle. Your vehicle could then accelerate to the previously selected speed.

The DISTRONIC regulates only the distance between your vehicle and those directly ahead of it, but does not register stationary objects in the road, e.g.:

- a stopped vehicle in a traffic jam
- a disabled vehicle
- an oncoming vehicle

The driver must always be alert, observe all traffic and intercede as required by means of steering or braking the vehicle.

Warning!

The DISTRONIC should not be used in snowy or icy road conditions.

The most likely cause for a malfunctioning system is a dirty DISTRONIC system sensor cover (located in the hood grille), especially at times of snow and ice or heavy rain.

In such a case, the DISTRONIC will switch off, and the message DISTRONIC Currently Unavailable - See Operator's Manual appears in the multifunction display.

For cleaning and care of the DISTRONIC system sensor cover, see (▷ page 263).

- ❗ If the message DISTRONIC Available Again appears during driving, the dirt (e.g. slush) has dissolved; the DISTRONIC works again, if you reactivate it (▷ page 147).

Turns and bends

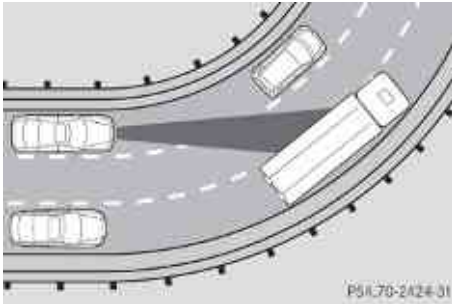

In turns or bends, the DISTRONIC may not detect a moving vehicle in front, or it may detect one too soon. This may cause your vehicle to brake late or unexpectedly.

Offset driving

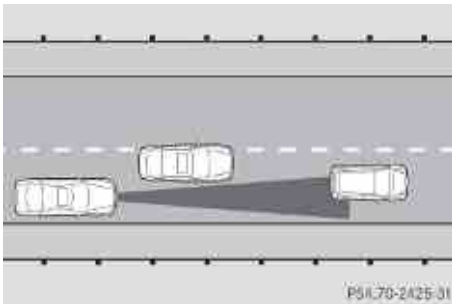

A vehicle traveling in your lane but offset from your direct line of travel may not be detected by the DISTRONIC. There will be insufficient distance to the preceding vehicle.

Lane changing

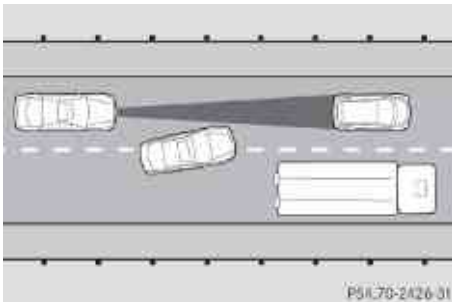

The DISTRONIC has not yet detected the vehicle changing lanes. There will be insufficient distance to the lane-changing vehicle.

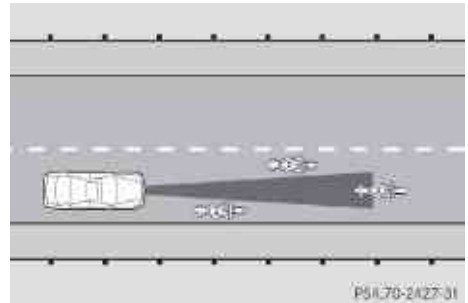

Narrow vehicles



Because of their narrow profile, the vehicles traveling near the outer edges of the lane have not yet been detected by the DISTRONIC. There will be insufficient distance to the preceding vehicles.

Distance warning function

This function warns you at a vehicle speed of above approximately 20 mph (30 km/h) in the following cases:

- At the current speed, the distance between your vehicle and the preceding vehicle is too low for several seconds. The distance warning lamp  in the instrument cluster comes on.
- You are gaining on a preceding vehicle rapidly. An intermittent warning sounds and the distance warning lamp  in the instrument cluster comes on.

If these warnings are issued, you must apply the brakes to maintain a safe distance and avoid a collision with the preceding vehicle.

When depressing the brake pedal, the warning sound will also cease when the distance to the preceding vehicle is sufficient again without applying the brakes. In this case, the distance warning lamp  will also go out.

⚠ Warning!

If the distance warning lamp  in the instrument cluster comes on while driving and/or an intermittent warning sounds, immediate attention on the part of the driver is required. As required by the traffic situation, apply the brakes and navigate around a possible obstacle. However, do not drive by relying on the distance warning function, as this will result in an emergency braking application. This will not always enable you to avoid a collision, especially when traveling on varying road surface conditions and with varying driver reaction. Complex driving situations are not always fully recognized by the distance warning function. This could result in wrong or missing distance warnings.

- ▶ **Activating/deactivating:** Activate or deactivate the distance warning function in the control system (▷ page 137). When activated, the distance warning function indicator  appears in the multifunction display.

Hill-start assist system**⚠ Warning!**

The hill-start assist system is not designed to function as a parking brake. It does not prevent the vehicle from moving when parked on an incline.

Always engage the parking brake in addition to shifting the automatic transmission into park position **P**.

On uphill grades, the hill-start assist system maintains the pressure in the brake system for approximately 1 second after you have released the brake pedal. Therefore, you can start off smoothly without the vehicle moving immediately after releasing the brake pedal.

- ▶ Depress the brake pedal.
- ▶ Shift the automatic transmission into drive position **D** or reverse gear **R**.

- ▶ Release the brake pedal.
 - ▶ Carefully depress the accelerator pedal.
- The hill-start assist system is inactive

- when starting off on a level road or downhill grades
- with the automatic transmission in neutral position **N**
- with the parking brake engaged
- if the ESP® has switched off due to a malfunction

Downhill Speed Regulation (DSR)

For information on off-road driving, see “Off-road driving” (▷ page 248).

The DSR is an aid for driving downhill. The DSR regulates your vehicle’s speed when driving downhill to the value set in the control system (▷ page 138). The steeper the downhill gradient is, the greater the brake application. On flat road surfaces, the DSR brakes only slightly or not at all.

⚠ Warning!

The Downhill Speed Regulation (DSR) is a convenience system designed to assist the driver during vehicle operation. The system must be set to be appropriate for the topographical and weather conditions encountered which can change quickly. The driver is and must remain at all times responsible for the vehicle speed and for safe brake operation.

Depending on the programmed speed, actual vehicle speed and gradient, switching on the DSR while driving can cause the vehicle to slow down rapidly and you may hear a sound which is caused by the activation of the vehicle’s brake system through the DSR. Sudden and unexpected deceleration can result in loss of vehicle control, causing an accident and/or serious personal injury to you and others. Do not switch on the DSR in

a circumstance where rapid deceleration could result in a loss of vehicle control.

The DSR regulates the vehicle's speed in automatic transmission positions **D**, or **R**.

- i** In addition, make use of the engine's braking effect by shifting the automatic transmission into a lower gear.

You can drive slower or faster than the set speed at any time by braking the vehicle or depressing the accelerator pedal.

- i** Whenever the DSR is switched on, the DSR will use the programmed default speed to regulate the vehicle's speed. The default speed programmed at the factory is 4 mph (Canada: 6 km/h). The default speed can be reprogrammed using the control system (▷ page 138). The next time the DSR is switched on, the DSR will use the newly programmed default speed to regulate the vehicle's speed.

Once the DSR is switched on, you can adjust the set speed using the cruise control lever (▷ page 142). Keep in mind that adjusting the set speed using the cruise control lever with the DSR switched on will not change the programmed default speed. If the DSR is switched off and then switched on again, the DSR will use the programmed default speed.

Depending on the road surface and level of downhill grade, the DSR may not be able to maintain the set speed. To maintain the set speed, apply the brakes if necessary.

Switching the DSR on/off

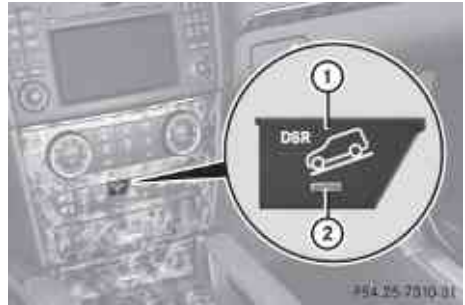

⚠ Warning!

If the accelerator pedal is depressed while the Downhill Speed Regulation (DSR) is activated, the vehicle can drive faster than the programmed set speed. You should therefore drive downhill with particular caution as it could otherwise lead to an accident and/or serious injury to you or others. Keep in mind that as soon as you remove your foot from the accelerator pedal with the DSR switched on, the DSR will start regulating the vehicle's speed including use of brakes if required. Depending on the programmed set speed, actual vehicle speed and gradient, the DSR can cause the vehicle to slow down rapidly. Sudden and unexpected deceleration can result in loss of vehicle control, causing an accident and/or serious personal injury to you and others.

Switching on the DSR

The DSR can only be switched on if the vehicle speed is below 20 mph (Canada: 30 km/h).

- ▶ Press DSR switch ①.

Indicator lamp ② comes on.

The message DSR and the set speed appear in the multifunction display.



- i** If the DSR is switched on at a speed above 20 mph (Canada: 30 km/h), the message DSR Max. Speed 20 MPH (Canada: 30 km/h) appears in the multifunction display.

For information on how to program the set speed while driving, see “Adjusting the DSR speed” (▷ page 154).

Switching off the DSR

- ▶ Press DSR switch ①. Indicator lamp ② goes out. The message DSR Off appears in the multifunction display.
- i** At a speed above approximately 21 mph (Canada approximately: 35 km/h), the DSR is automatically switched off. The message DSR Off appears in the multifunction display and an acoustic signal sounds. For information on how to switch the DSR on again, see “Switching on the DSR” (▷ page 153).

Adjusting the DSR speed

With the DSR switched on (▷ page 153), the speed setting can be changed using the cruise control lever.

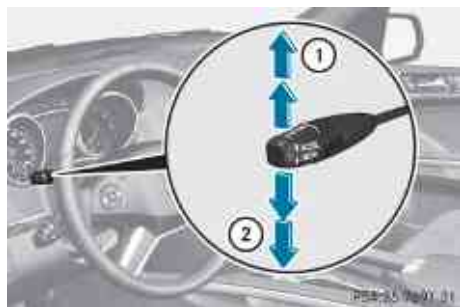

Cruise control lever

You can change the set speed between 3-10 mph (Canada: 4-18 km/h).

You can increase or reduce the set speed in two ways.

Adjustment in 1 mph (Canada: 1 km/h) increments

- i** The set value is increased or decreased in 1 mph (Canada: 1 km/h) increments each time you lift or depress the cruise control lever to the resistance point.

Increase set speed:

- ▶ Briefly lift the cruise control lever up to the resistance point in direction of arrow ①.
- ▶ Release the cruise control lever. The vehicle speed increases in increments of 1 mph (Canada: 1 km/h).

Reduce set speed:

- ▶ Briefly press the cruise control lever down to the resistance point in direction of arrow ②.
- ▶ Release the cruise control lever. The vehicle speed decreases in increments of 1 mph (Canada: 1 km/h). Each time the set speed is changed, DSR will appear in the multifunction display and the changed set speed is shown.

The set speed is canceled when the DSR is switched off. If the DSR is switched on again, the DSR will use the programmed default speed (▷ page 138).

Adjustment in 5 mph (Canada: 10 km/h) increments

- i** The set value is increased or decreased in 5 mph (Canada: 10 km/h) increments each time you lift or depress the cruise control lever past the resistance point.

Increase set speed:

- ▶ Briefly lift the cruise control lever up past the resistance point in direction of arrow ①.
- ▶ Release the cruise control lever. The vehicle speed increases in increments of 5 mph (Canada: 10 km/h).

Reduce set speed:

- ▶ Briefly press the cruise control lever down past the resistance point in direction of arrow ②.
- ▶ Release the cruise control lever.
The vehicle speed decreases in increments of 5 mph (Canada: 10 km/h).
Each time the set speed is changed, DSR will appear in the multifunction display and the changed set speed is shown.

The new speed is set and the vehicle will accelerate or decelerate. Keep in mind that it may take a brief moment until the vehicle has reached the new set speed.

The set speed is canceled when the DSR is switched off. If the DSR is switched on again, the DSR will use the programmed default speed (▷ page 138).

Off-road driving program

The off-road driving program is designed to assist the driver when driving off-road in terrain and crossing water. The off-road driving program adjusts the engine power and shifting of the automatic transmission to be more suitable for the off-road use of the vehicle. In addition, the ABS, ESP®, and 4-ETS designed for off-road use are automatically activated.

In the following situations you should switch to the off-road driving program:

- during off-road driving
- when crossing water (▷ page 251)
- when towing up or down on steep gradients

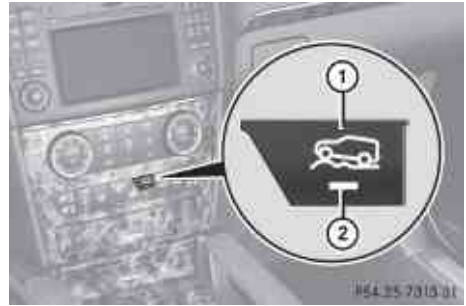

Example illustration: All models, except ML 63 AMG

- ❗ In AMG vehicles you can switch the Off-road driving program on or off via the control system (▷ page 125).

- ▶ **Switching on:** Press switch ①. Indicator lamp ② comes on. The symbol  appears in the lower multifunction display.



- ▶ **Switching off:** Press switch ① again. Indicator lamp ② goes out. The symbol  disappears.

Air suspension program

The system lets you select the chassis and suspension setup. The chassis and suspension setup adjusts the damping behavior and the ride height for your vehicle. The system consists of two components. The Adaptive Damping System (ADS) (▷ page 156) and the vehicle level control (▷ page 156).

ML 63 AMG

The air suspension program is part of the ML 63 AMG standard equipment range.

Due to the vehicle's sportier suspension tuning, in comparison with standard vehicles, the level positions in the ADS settings as well as the speed thresholds for raising and lowering the vehicle have been modified.

From the highway/high-speed level, the vehicle is lowered to the ADS SPORT level approximately 20 seconds after it is locked. From the raised level, the vehicle is not lowered after it is locked. When the engine is started, the previously selected setting, e.g. ADS COMF, is selected again.

! Be sure to observe this vehicle's differing values for ground clearance and vehicle height in comparison to standard vehicles. You could otherwise damage the vehicle. Observe the values for

- opening the tailgate
- driving off-road
- the vehicle's main dimensions in the "Technical data" section

Adaptive Damping System (ADS)

The Ads Damping System (ADS) is controlled electronically and operates continuously. It adjusts the damping characteristics to the current operating and driving conditions. The damping is adjusted individually for each wheel. Driving safety and tire comfort are increased.

The fine tuning of the damping is dependent on:

- your driving style
- road surface conditions
- your personal settings

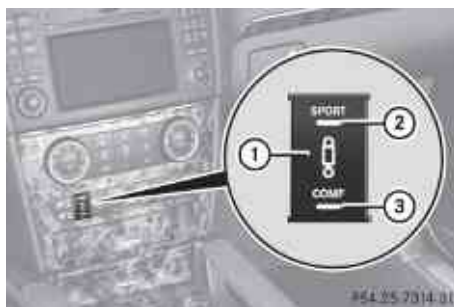

The following settings are available:

- **AUTO** (for normal driving situations)
Indicator lamps ② and ③ are off.

- **SPORT** (for sporty driving)
Indicator lamp ② comes on.

With the ADS **SPORT** setting, the vehicle is lowered approximately 0.6 in (15 mm).

ML63 AMG:

With the ADS **SPORT** setting, the vehicle is lowered approximately 0.3 in (8 mm).

- **COMF** (for comfort driving)
Indicator lamp ③ comes on.

ML63 AMG:

The vehicle is raised approximately 0.28 in (7 mm).

► Start the engine.

► Press ADS switch ① repeatedly until the desired suspension tuning is reached.

The setting remains stored when you turn off the engine.

Vehicle level control

Your vehicle automatically adjusts its ride height to increase vehicle safety and to reduce fuel consumption.

Changes to the vehicle level should be made while the vehicle is moving. The vehicle will then reach the set level as fast as possible.

When you park the vehicle and the ambient temperature changes, the vehicle level may change visibly. When the temperature drops,

the vehicle lowers. When the temperature rises, the vehicle raises.

The vehicle automatically regulates its ride height based on the set vehicle height and the current speed:

- As your driving speed increases, the vehicle is lowered by increments until it reaches highspeed level.
- Vehicles with ADS: If you are driving with the ADS setting **COMF** or **AUTO**, the vehicle is raised back to highway level as your driving speed decreases.
- Vehicles with ADS: You can select the highspeed level via the ADS setting **SPORT**. In ADS **SPORT**, the vehicle is lowered directly to highspeed level as your driving speed increases.

The vehicle begins adjusting to the set vehicle level as soon as the doors or tailgate are unlocked or opened or closed with the vehicle unlocked.

In order to operate the vehicle level control switch (▷ page 157), however, the engine must be running.

Warning!

Make sure no one is near the wheel housing or under the vehicle when you lower the vehicle while it is standing still. Limbs could become wedged into or under the vehicle.

For safety reasons, the vehicle can only be lowered with all doors and the tailgate closed. Lowering is interrupted if a door or the tailgate is opened and will continue after the door is closed again.

Warning!

Please be aware that by raising the vehicle level, the center of gravity also rises. Therefore, always ensure that the vehicle level is as low as possible. With higher ride height the ESP® may activate earlier in certain situations.

Adapt your speed and driving to possible changed driving behavior of the vehicle after

changing the vehicle level. The ESP® cannot prevent accidents, including those resulting from excessive speed. The ESP® cannot prevent the natural laws of physics from acting on the vehicle.

- ❗ Keep in mind that in rough or uneven terrain, adjusting the vehicle to a lower level may cause the vehicle underbody to come in contact with the ground and result in damage to the vehicle underbody. Always make sure the vehicle has sufficient ground clearance before adjusting it to a lower level.
- ❗ Before jacking up the vehicle with equipment that lifts one or more of the wheels completely off of the ground, remove the SmartKey from the starter switch.

For information on off-road driving, see “Off-road driving” (▷ page 248).

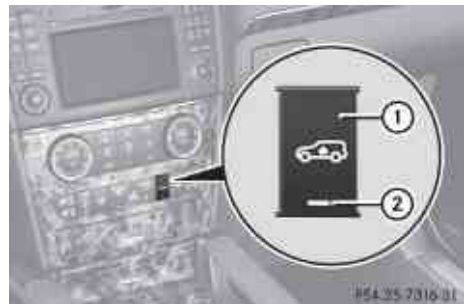

Basic settings (except ML 63 AMG)

The following vehicle chassis ride heights can be selected using vehicle level control switch ① in the center console:

Level	Driving situation
Raised level	For off-road driving or driving in rough terrain. Indicator lamp ② is on.
Highway level	For driving on paved roads in fair or better condition. Indicator lamp ② is off.

- i** The third available level is the highspeed level that is set automatically.

The following is the approximate change in ride height for each of the level settings:

Level	Ride height
Raised level	+2.3 in (60 mm)
Highway level ¹⁶	+/-0 in (0 mm)
Highspeed level	-0.6 in (-15 mm)

- i** Vehicles with ADS:

Depending on the ADS setting (> page 156), the vehicle will be lowered to the highspeed level when traveling at higher speeds. At speeds below 40 mph (64 km/h) at the latest, it will be returned to the highway level.

- i** The highspeed level is not available when towing a trailer. For more information on towing a trailer, see “Trailer towing” (> page 254).

Basic settings (ML 63 AMG)

The following vehicle chassis ride heights can be selected using vehicle level control switch ① in the center console:

Level	Driving situation
Raised level	For off-road driving or driving in rough terrain. Indicator lamp ② is on.
Highway level	For driving on paved roads in fair or better condition. Indicator lamp ② is off.

- i** The third available level is the highspeed level that is set automatically.

How much the vehicle is lowered or raised depends on the ADS setting selected. At the raised level, the vehicle is 2.9 in (73 mm) higher than at the highway level with ADS **AUTO**.

Raised level

Only select the raised level if appropriate for the driving situation encountered. Otherwise the fuel consumption may increase and/or the handling characteristics of the vehicle may be unfavorable.

- i** You can select the raised level at speeds up to 40 mph (64 km/h). At higher speeds, the message  Level Selection Not Permitted appears in the multifunction display.

▶ Start the engine.





When indicator lamp ② is off:

- ▶ Press vehicle level control switch ①. Indicator lamp ② flashes. The vehicle adjusts to the raised level.

The following message appears in the multifunction display while the level is being set:

¹⁶ Ground clearance: 7.9 in (201 mm)



- i** The message can be cleared by pressing the , ,  or  button on the multifunction steering wheel.

When the raised level is reached, indicator lamp ② comes on continuously and the following message appears in the multifunction display for approximately 5 seconds:



Highway level





- !** Keep in mind that on rough or uneven roads, adjusting the vehicle to a lower level may cause the vehicle underbody to come in contact with the road and result in damage to the vehicle underbody. Always make sure the vehicle has sufficient ground clearance before adjusting it to a lower level.

- ▶ Start the engine.

When indicator lamp ② is on:

- ▶ Press vehicle level control switch ①. Indicator lamp ② flashes. The vehicle adjusts to the highway level. The following message appears in the multifunction display while the level is being set:



- i** The message can be cleared by pressing the , ,  or  button on the multifunction steering wheel.

When the highway level is reached, indicator lamp ② goes out and the following message appears in the multifunction display for approximately 5 seconds:



The vehicle is lowered to the highway level automatically if the vehicle speed is above 55 mph (88 km/h) or if the vehicle speed stays between 40 mph (64 km/h) and 55 mph (88 km/h) for approximately 20 seconds.

All-wheel drive (4MATIC)

In vehicles with all-wheel drive (4MATIC), both axles are powered at all times when the vehicle is being operated. The 4MATIC improves traction in conjunction with the ESP® (▷ page 63) and the Electronic Traction System (ETS/4-ETS) (▷ page 64).

⚠ Warning!

If a drive wheel is spinning due to insufficient traction:

- While driving off, apply as little throttle as possible.
- While driving, ease up on the accelerator pedal.
- Adapt your speed and driving style to the prevailing road conditions.

Failure to observe these guidelines could cause the vehicle to skid.

The 4MATIC cannot prevent accidents resulting from excessive speed.

! Do not tow with one axle raised. Doing so could damage the transfer case, which is not covered by the Mercedes-Benz Limited Warranty. All wheels must be on or off the ground. Observe instructions for towing the vehicle with all wheels on the ground.

! Only conduct operational or performance tests on a two-axle dynamometer. If such tests are necessary, contact an authorized Mercedes-Benz Center. You could otherwise seriously damage the brake system and/or the transfer case which is not covered by the Mercedes-Benz Limited Warranty.

i In winter operation, the maximum effectiveness of the 4MATIC is only achieved with winter tires (▷ page 242) or snow chains as required.

Parktronic system

The Parktronic system is an electronic parking aid with ultrasonic sensors designed to assist the driver during parking maneuvers. The Parktronic system indicates the relative distance between the vehicle and an obstacle visually and audibly.

The Parktronic system is activated automatically when

- you switch on the ignition and
- you release the parking brake and
- the automatic transmission is in drive position **D**, reverse gear **R**, or neutral position **N**

The Parktronic system deactivates at speeds above approximately 11 mph (18 km/h). At lower speeds, the Parktronic system activates again.

The Parktronic system also deactivates when you shift the automatic transmission into park position **P** or engage the parking brake.

The Parktronic system monitors the surroundings of your vehicle with six sensors in the front bumper and four sensors in the rear bumper.



To function properly, sensors ① must be free of dirt, ice, snow and slush. Clean sensors ① regularly. Be careful not to scratch or damage sensors ①, see “Cleaning the driving systems sensors” (▷ page 263).

⚠ Warning!

The Parktronic is a supplemental system. It is not intended to, nor does it replace, the need for extreme care. The responsibility during parking and other critical maneuvers always remains with the driver.

Warning!

Make sure no persons or animals are in or near the area in which you are parking/maneuvering. Otherwise, they could be injured.

- Special attention must be paid to objects with smooth surfaces or low silhouettes (e.g. trailer couplings, painted posts, elevated crossbars or road curbs). Such objects may not be detected by the system and can damage the vehicle.

During parking maneuvers, pay special attention to objects located above or below the height of the sensors (e.g. street curbs, painted posts, or trailer hitches etc.). The Parktronic system will not detect such objects at close range and damage to your vehicle or the object may result.

- Ultrasonic signals from outside sources (e.g. truck air brakes, car wash, or jackhammers) may impair the operation of the Parktronic system.

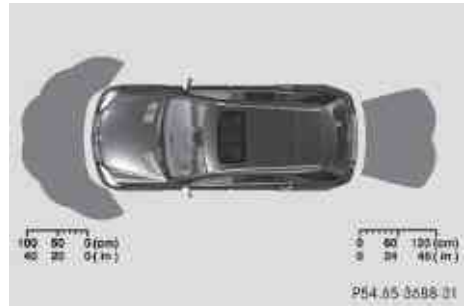
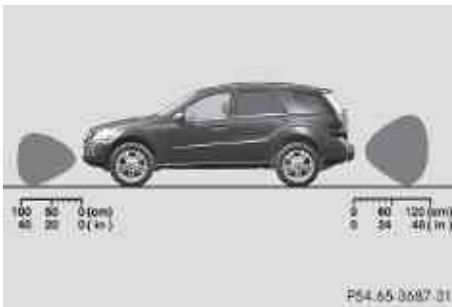
Range of the sensors**Front sensors**

Center	approx. 40 in (100 cm)
Corners	approx. 24 in (60 cm)

Rear sensors

Center	approx. 48 in (120 cm)
Corners	approx. 32 in (80 cm)

Minimum distance

Center	approx. 8 in (20 cm)
Corners	approx. 6 in (15 cm)

If the Parktronic system detects an obstacle in this range, all the distance warning segments illuminate and you hear a warning signal. If the obstacle is closer than the minimum distance, the actual distance may no longer be indicated by the Parktronic system.

Warning indicators

Visual signals indicate the relative distance between the sensors and an obstacle.

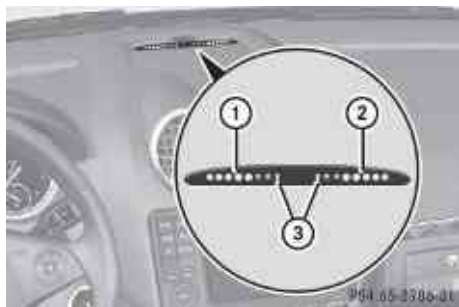

Front area warning indicators

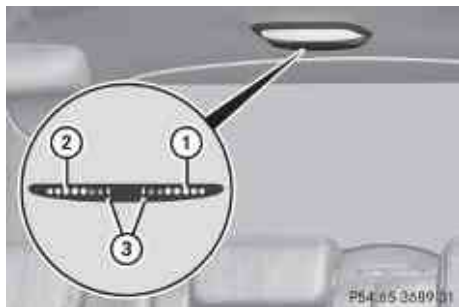

Rear area warning indicators

Each warning indicator is divided into five yellow and two red distance segments for left side ① and right side ② of the vehicle. The Parktronic system is ready to measure when the yellow readiness indicators ③ are illuminated.

The current transmission position determines which warning indicator will be activated.

Current transmission position	Warning indicator
D	Front area activated
R or N	Front and rear area activated

As your vehicle approaches an object, one or more distance segments will illuminate, depending on the distance. When the seventh distance segment illuminates, you have reached the minimum distance.

- **Front area:** An intermittent acoustic warning lasting a maximum of 2 seconds will sound as the first red distance segment illuminates. A constant acoustic warning lasting a maximum of 2 seconds will sound for the second red distance segment. The signal is canceled when the automatic transmission is shifted into park position **P** or the parking brake is engaged.
- **Rear area:** An intermittent acoustic warning lasting a maximum of 2 seconds will sound as the first red distance segment illuminates. A constant acoustic warning lasting a maximum of 2 seconds will sound for the second red distance segment. The signal is canceled when the automatic transmission is shifted into drive position **D**, or park position **P**, or the parking brake is engaged.

Switching the Parktronic system on/off

The Parktronic system switches on automatically when the ignition is switched on.

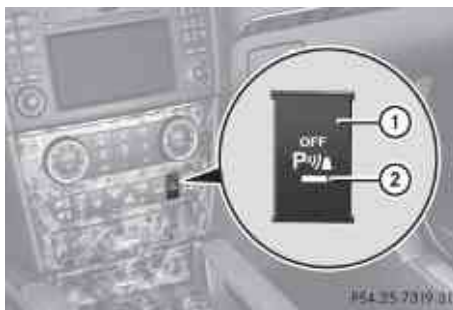

Example illustration: All models, except ML 450 HYBRID

- **Switching off:** Press Parktronic switch ①. Indicator lamp ② comes on.
- **Switching on:** Press Parktronic switch ① again.

Trailer towing

The rear Parktronic sensors will be deactivated when you have established the electrical connection between your vehicle and the trailer you are about to tow.

- ❗ The distance between the sensors in the bumpers and an obstacle is referred to as the minimum range of the Parktronic. A trailer hitch will reduce the distance to an obstacle. Keep this in mind to avoid any damage.

Parktronic system malfunction

There is a malfunction in the Parktronic system, if only the red distance segments illuminate and an acoustic warning sounds. The Parktronic system will switch off automatically after 20 seconds and indicator lamp ② in Parktronic switch ① comes on.

- ▶ Have the Parktronic system checked at an authorized Mercedes-Benz Center as soon as possible.

If only the red distance segments illuminate and no acoustic warning sounds, the Parktronic system sensors are dirty (e.g. dirt, ice, snow and slush). Another cause could be interference from other radio or ultrasonic signals (e.g. truck air brakes, car wash, or jackhammers). The Parktronic system will switch off automatically after 20 seconds and indicator lamp ② in Parktronic switch ① comes on.

- ▶ Switch off the ignition.
- ▶ Clean the Parktronic system sensors (▷ page 263).
- ▶ Switch on the ignition.
or
- ▶ Check the Parktronic system operation at another location to rule out interference from outside radio or ultrasonic signals.

Rear view camera

The rear view camera is an optical parking aid.

The area behind the vehicle appears in the COMAND system display as a mirror image, like in the rear view mirror.

In addition, the rear view camera contains guidelines to help you with driving in reverse.

⚠ Warning!

Make sure no persons or animals are in or near the area in which you are parking/maneuvering. Otherwise, they could be injured.

⚠ Warning!

The rear view camera is only an aid and may display obstacles

- from a distorted perspective
- inaccurately
- may not display obstacles at all

The rear view camera does not relieve you of the responsibility to be cautious. Take care and pay careful attention. The rear view camera may not show objects which are

- very close to the rear bumper
- under the rear bumper
- above the tailgate handle

You are responsible for safety at all times and must continue to pay attention to the immediate surroundings when parking and maneuvering. This includes the area behind, in front of, and beside the vehicle. Otherwise you could endanger yourself and/or others.

⚠ Warning!

The rear view camera either will not function or will not function to its full capability if

- the tailgate is open
- it is raining very hard, snowing or foggy
- it is night or you are parking/maneuvering your vehicle in an area where it is very dark
- the camera is exposed to a very bright white light

- the immediate surroundings are illuminated with fluorescent light (the display may flicker)
- there is a sudden change in temperature, e.g. if you drive into a heated garage from the cold (lens condensation)
- the camera lens is dirty or covered
- the rear of your vehicle is damaged

In this case, have the position and setting of the camera checked by a qualified specialist workshop. Mercedes-Benz recommends that you contact a Mercedes-Benz Center for this purpose.

Do not use the rear view camera in these situations. Otherwise you could injure yourself or others and/or damage property including your vehicle while parking/maneuvering.

Warning!

Use of rear view camera can be dangerous if you are color-blind or have impaired color vision.

Only use rear view camera if you can see and distinguish all colored guidelines shown by rear view camera on the COMAND system display.



Camera lens ① must be free of dirt, ice, snow, and slush to function properly. Clean the camera lens regularly. Being careful not to scratch or damage the camera lens, see “Cleaning the rear view camera lens” (▷ page 263).

Switching on/off

- ▶ **Switching on:** Switch on the ignition.
- ▶ Switch on the COMAND system.
- ▶ Shift the automatic transmission to reverse gear **R**.

The COMAND system display will show the area behind the vehicle with guidelines.

Warning!

Please note that objects which do not touch the ground may appear to be further away than they actually are, for example:

- the bumper of a vehicle parked behind you
- a trailer hitch
- the back of a truck

In such cases, you should not use the guidelines to judge the distance. You may misjudge the distance which increases the risk of impacting the objects.

Even when the object you approach is directly on the ground do not approach the object any closer than the red guideline.

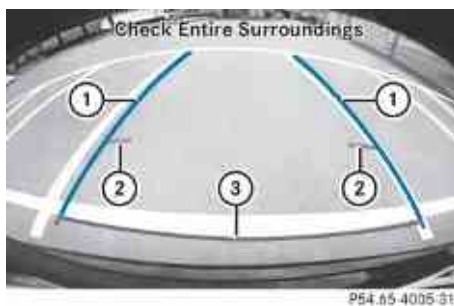

Red guideline ③ indicates an approximate distance of 10 in (0.25 m) from the rear of the vehicle. Yellow guidelines ② indicate an approximate distance of 3 ft (1 m) from the rear of the vehicle. Blue guidelines ① indicate the approximate width required for the vehicle.

i The image from the rear view camera will no longer be displayed if you select another function on the COMAND system while

reverse gear **R** is engaged. To display the image again, disengage and reengage reverse gear **R**.

► **Switching off:** Shift the automatic transmission into park position **P**, neutral position **N**, or drive position **D**.

Overview of climate control system functions and air vents

Your vehicle is equipped with either of the following climate control systems:

Climate control (▷ page 167)



3-zone automatic climate control



USA only (▷ page 173)



Canada only (▷ page 175)

The climate control combines an automatic heating and ventilation system with a cooling system. You can adjust the automatic climate control separately for the driver's and passenger side.

The 3-zone automatic climate control combines an automatic heating and ventilation system with a cooling system. You can adjust the 3-zone automatic climate control separately for each zone in the vehicle.

Rear automatic climate control (► page 177)



P83.40-4165.01

The rear automatic climate control allows separate climate settings for the rear compartment.

Air vents

⚠ Warning!

When operating the climate control, the air that enters the passenger compartment through the air vents can be very hot or very cold (depending on the set temperature). This may cause burns or frostbite to unprotected skin in the immediate area of the air vents.

Always keep sufficient distance between unprotected parts of the body and the air vents. If necessary, use the air distribution adjustment to direct the air to air vents in the vehicle interior that are not in the immediate area of unprotected skin.

For best possible performance of the climate control:

- Keep the air intake grille in front of the windshield free of snow, leaves, sticks, and any other debris.
- Always keep all air vents and grilles in the passenger compartment free from obstruction.

- ⓘ For draft-free ventilation, move the adjustable center and side air vents to the middle position.

Center air vents

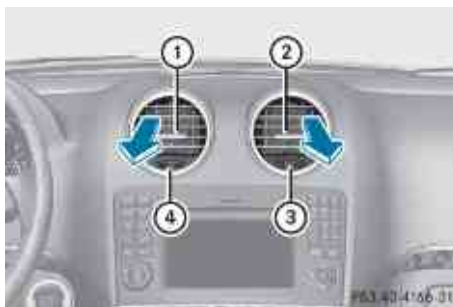

- ① Left center air vent, adjustable
- ② Right center air vent, adjustable
- ③ Thumbwheel for air volume control for adjustable right center air vent
- ④ Thumbwheel for air volume control for adjustable left center air vent

- **Opening/closing:** Turn thumbwheels ③ and ④ in the required direction.

Side air vents



Example illustration driver's side

- ① Left side defroster air vent, fixed
- ② Left side air vent, adjustable
- ③ Thumbwheel for air volume control for adjustable left side air vent

- **Opening/closing:** Turn thumbwheel ③ in the required direction.

Rear center console air vents

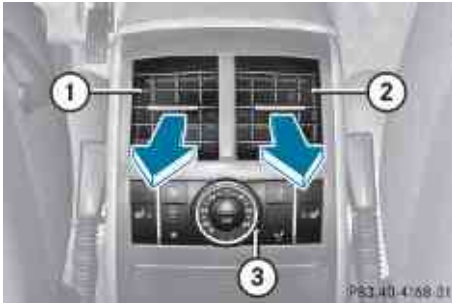

- ① Left rear center air vent, adjustable
- ② Right rear center air vent, adjustable
- ③ Rear climate control panel

When the front climate control panel is switched on or off, the air supply through the rear center air vents is also switched on or off.

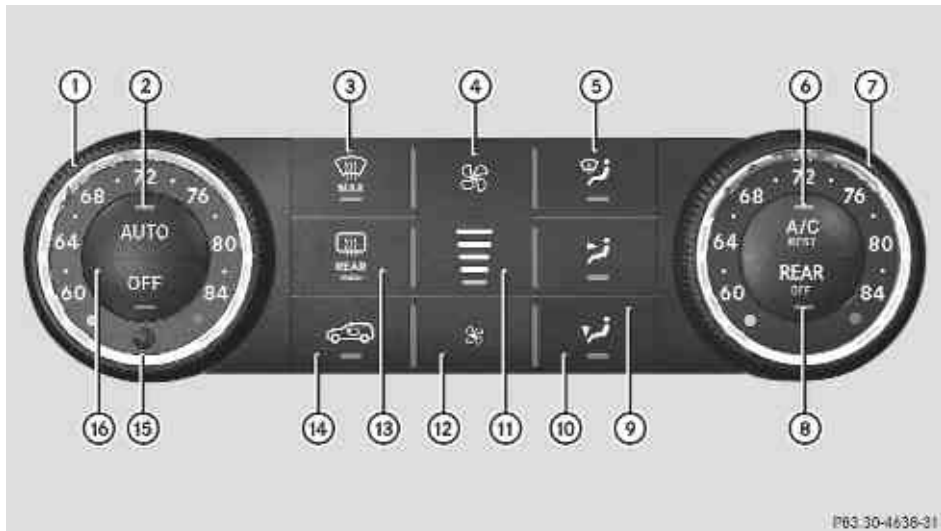

Climate control

Control panel



[P63-30-1636-31]

Function	Recommendation/Notes
① Temperature control, driver's side	① Set the temperature to 72°F (22°C). (> page 170)
② Air distribution and air volume (automatic mode)	① Switches on the automatic mode. The indicator lamp in button AUTO comes on. (> page 170)

Function	Recommendation/Notes	
③ Front defroster	i Keep this setting selected only until the windshield or the side windows are clear again.	(▷ page 171)
④ Increasing air volume		(▷ page 171)
⑤ Air distribution (directs air through the windshield and side air vents)		(▷ page 171)
⑥ AC cooling on/off	i Switches on the air conditioning. The indicator lamp in button  comes on.	(▷ page 169)
Residual heat/ventilation	i With the engine turned off, it is possible to continue to heat or ventilate the interior.	(▷ page 172)
⑦ Temperature control, passenger side	i Set the temperature to 72°F (22°C).	(▷ page 170)
⑧  Rear climate control on/off or air supply for rear passenger compartment on/off (USA only)		
 Rear climate control on/off or air supply for rear passenger compartment on/off (Canada only)		
⑨ Air distribution (directs air through center and side air vents)		(▷ page 171)
⑩ Air distribution (directs air through the footwells and side air vents)		(▷ page 171)
⑪ Air volume display		
⑫ Decreasing air volume		(▷ page 171)
⑬ Rear window defroster		(▷ page 183)
⑭ Air recirculation	i Only use this function for a short time, e.g. in a tunnel. Otherwise, the windows can fog up due to lack of fresh air.	(▷ page 172)

	Function	Recommendation/Notes
⑮	Interior temperature sensor	
⑯	Climate control on/off	<p>i Switches on the climate control system. The indicator lamp in button OFF goes out. (▷ page 169)</p>

Notes on climate control

The climate control is operational whenever the engine is running. You can operate the climate control system in either the automatic or manual mode. The system cools or heats the interior depending on the selected interior temperature and the current outside temperature.

Nearly all dust particles, pollutants and odors are filtered out before outside air enters the passenger compartment through the air distribution system.

Warning!

Severe conditions (e.g. strong air pollution) may require replacement of the filter before its scheduled replacement interval. A clogged filter will reduce the air volume to the interior and the windows could fog up, impairing visibility and endangering you and others. Have a clogged filter replaced as soon as possible at an authorized Mercedes-Benz Center.

The air conditioning will not engage (no cooling) if the **A/C** mode is deactivated (▷ page 169).

Warning!

Follow the recommended settings for heating and cooling given on the following pages. Otherwise the windows could fog up, impairing visibility and endangering you and others.

Keep the air intake grille in front of the windshield free of snow and debris.

- i** If the vehicle interior is hot, ventilate the interior before driving off, see “Summer

opening feature” (▷ page 102). The climate control will then adjust the interior temperature to the set value much faster.

Deactivating the climate control system

Warning!

When the climate control system is switched off, the outside air supply and circulation are also switched off. Only choose this setting for a short time. Otherwise the windows could fog up, impairing visibility and endangering you and others.

- ▶ **Deactivating:** Press button **OFF**.
The indicator lamp in the button comes on.
- ▶ **Reactivating:** Press button **AUTO**.
- i** You can also press button **OFF** on the climate control panel.
If you press button  to reactivate the climate control system, the defrosting mode is activated.

Deactivating the rear climate control from the front

- ▶ **Deactivating:** Press button **REAR OFF**.
The indicator lamp in the button comes on.
- ▶ **Reactivating:** Press button **REAR OFF**.
The indicator lamp in the button goes out.

Air conditioning

The air conditioning is operational while the engine is running and cools the interior air to

the temperature set by the operator. In addition, the air conditioning dehumidifies the interior air and helps prevent window fogging.

Warning!

If you switch off the air conditioning, the vehicle will not be cooled when weather conditions are warm. The windows can fog up more quickly. Window fogging may impair visibility and endanger you and others.

- i** Condensation may drip out from underneath the vehicle. This is normal and not an indication of a malfunction.

Deactivating

It is possible to deactivate the air conditioning. The interior air will then no longer be cooled or dehumidified.

- ▶ Press button . The indicator lamp in the button goes out. The cooling function switches off after a short delay.

Activating

Moist air can fog up the windows. You can dehumidify the interior air with the air conditioning.

- ▶ Press button  again. The indicator lamp in the button comes on.

The air conditioning uses the refrigerant R134a. This refrigerant is free of CFCs which are harmful to the ozone layer.

- !** If the air conditioning cannot be activated again, this indicates that the air conditioning is losing refrigerant. The compressor has turned off.

Have the air conditioning checked at the nearest authorized Mercedes-Benz Center.

Automatic mode





When operating the climate control system in automatic mode, the interior air temperature, air volume and air distribution are adjusted automatically.

In automatic mode, cooling with dehumidification is switched on. This function can be switched off if necessary.





Warning!

If you switch off the air conditioning, the vehicle will not be cooled when weather conditions are warm. The windows can fog up more quickly. Window fogging may impair visibility and endanger you and others.

- ▶ Set the desired temperature (▷ page 170).
- ▶ **Activating:** Press button . The indicator lamp in the button comes on. The air volume and air distribution are adjusted automatically.
- i** The settings for the passenger side are also used for the rear passenger compartment.

- ▶ **Deactivating:** Press button  or . The indicator lamp in button  goes out. The automatic operation of air volume switches off. The selected blower speed is shown in air volume display  (▷ page 167).

or

- ▶ Press air distribution button , , or . The indicator lamp in button  goes out. The automatic operation of air distribution switches off.

Setting the temperature



You can adjust the air temperature on each side of the passenger compartment. You should raise or lower the temperature setting



in small increments, preferably starting at 72°F (22°C).

- **Increasing/decreasing:** Turn temperature control ① and/or ⑦ (▷ page 167) slightly clockwise or counterclockwise.



Adjusting air distribution

The air distribution can be adjusted manually. The symbols on the buttons represent the following functions:

Symbol	Function
	Directs air to the windshield and side air vents
	Directs air through the center and side air vents
	Directs air to the footwells and side air vents

- Press the desired air distribution button , , or . The indicator lamp in button **AUTO** goes out. The automatic mode is switched off. Air distribution is controlled according to the desired button.

Adjusting air volume

- **Decreasing/increasing:** Press button  or . The automatic mode is switched off. The selected blower speed is shown in air volume display ⑪ (▷ page 167).

When using the Voice Control System, the blower speed reduces automatically. When the Voice Control System is not used anymore, the blower speed increases to the previously selected level.

Front defroster

You can use this setting to defrost the windshield, for example if it is iced up.

You can also defog the windshield and the side windows.



- ❗ Keep this setting selected only until the windshield or the side windows are clear again.



Activating

- Press button . The indicator lamp in the button comes on. The climate control switches to the following functions automatically:
 - most efficient blower speed and heating power, depending on outside temperature
 - air flows onto the windshield and the front door windows (side air vents must be open)
 - the air conditioning compressor switches on at outside temperatures above approximately 41°F (5°C) for air-drying

Adjustments



You can adjust the air volume and the temperature when the front defroster is switched on. The air flow will remain on the windshield and front door windows.

- Press button  to decrease or button  to increase air volume to the desired level. The air volume decreases/increases to the next lower/higher blower speed and heating switches to the temperature that was set before the front defroster was switched on.

The indicator lamp in button  goes out.
The indicator lamp in button  comes on.



or

- ▶ Turn temperature control ① and/or ⑦ (▷ page 167) slightly in any direction.
Heating switches to the temperature that was set before the front defroster was switched on.



The indicator lamp in button  goes out.
The indicator lamp in button  comes on.

- i** The air conditioning compressor remains on even if the indicator lamp in button  goes out. This helps to prevent the windshield from fogging.

Deactivating

- ▶ Press button  again.
The indicator lamp in the button goes out.
Defrosting is turned off.
The previous settings are once again in effect. The air conditioning compressor remains switched on.
- i** To deactivate, you can also press button  or .

Windshield fogged on the outside

- ▶ Switch the windshield wipers on (▷ page 98).
- ▶ Press air distribution button  or .

Air recirculation mode

Switch to air recirculation mode to prevent unpleasant odors from entering the vehicle from the outside (e.g. before driving through a tunnel). This setting cuts off the intake of outside air and recirculates the air in the passenger compartment.

Warning!

Fogged windows impair visibility, endangering you and others. If the windows begin to fog on the inside, switching off the air recirculation mode immediately should clear interior window fogging. If interior window fogging persists, make sure the air conditioning is activated, or press button .

- ▶ **Activating:** Press button .
The indicator lamp in the button comes on.

- i** The air recirculation mode is activated automatically at high outside temperatures.
The indicator lamp in button  is not lit when the air recirculation mode is switched on automatically.

A quantity of outside air is added after approximately 30 minutes.

If you have turned off the air conditioning or the outside temperature is below 41°F (5°C), the air recirculation mode will not switch on automatically.

- ▶ **Deactivating:** Press button .
The indicator lamp in the button goes out.



- i** The manually selected air recirculation mode is deactivated automatically:
 - after 5 minutes if the outside temperature is below approximately 41°F (5°C)
 - after 5 minutes if the air conditioning and air-drying are turned off
 - after 30 minutes if the outside temperature is above approximately 41°F (5°C)

Residual heat and ventilation

With the engine switched off, it is possible to continue to heat or ventilate the interior for up to 30 minutes. This feature makes use of the residual heat produced by the engine.

- i** How long the system will provide heating depends on the coolant temperature and the battery voltage.

Regardless of the temperature and air volume set on the climate control panel, an interior temperature is aimed at by 72°F (22°C) and the blower runs on low speed to protect the vehicle battery.

- ▶ **Activating:** Switch off the ignition.
- ▶ Press button . The indicator lamp in the button comes on.
- ▶ **Deactivating:** Press button  again. The indicator lamp in the button goes out.

The residual heat is deactivated automatically

- when the ignition is switched on
- after approximately 30 minutes
- if the battery voltage drops
- if the coolant temperature is too low

3-zone automatic climate control

Control panels

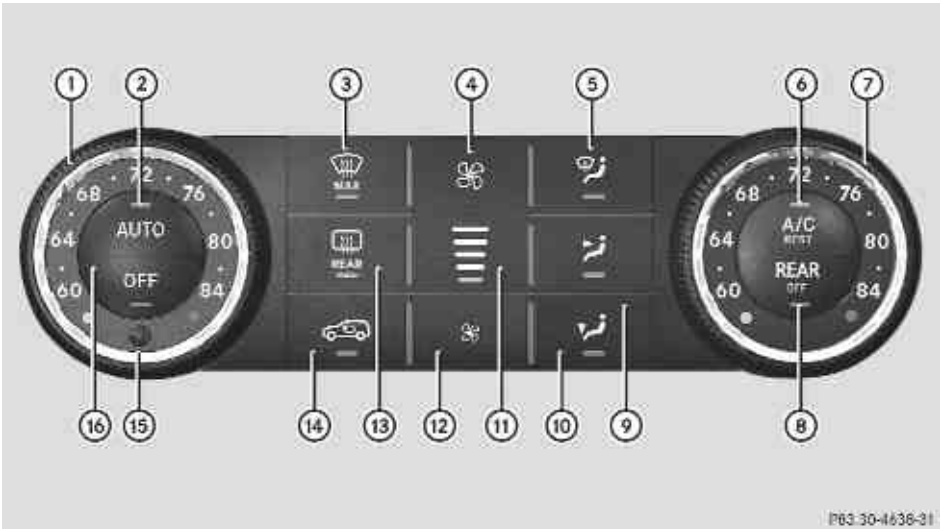

P03-30-1638-31

USA only

Function	Recommendation/Notes	
① Temperature control, driver's side	i Set the temperature to 72°F (22°C).	(▷ page 179)
② Air distribution and air volume (automatic mode)	i Switches on the automatic mode. The indicator lamp in button AUTO comes on.	(▷ page 179)
③ Front defroster	i Keep this setting selected only until the windshield or the side windows are clear again.	(▷ page 181)
④ Increasing air volume		(▷ page 181)
⑤ Air distribution (directs air through the windshield and side air vents)		(▷ page 180)
⑥ AC cooling on/off	i Switches on the air conditioning. The indicator lamp in button A/C comes on.	(▷ page 178)
Residual heat/ventilation	i With the engine turned off, it is possible to continue to heat or ventilate the interior.	(▷ page 183)
⑦ Temperature control, passenger side	i Set the temperature to 72°F (22°C).	(▷ page 179)
⑧ Operating the rear climate control from the front		(▷ page 178)
⑨ Air distribution (directs air through center and side air vents)		(▷ page 180)
⑩ Air distribution (directs air through the footwells and side air vents)		(▷ page 180)
⑪ Air volume display		
⑫ Decreasing air volume		(▷ page 181)
⑬ Rear window defroster		(▷ page 183)
⑭ Air recirculation	i Only use this function for a short time, e.g. in a tunnel. Otherwise, the windows can fog up due to lack of fresh air.	(▷ page 182)

	Function	Recommendation/Notes	
15	Interior temperature sensor		
16	Climate control on/off	i Switches on the climate control system. The indicator lamp in button OFF goes out.	(▷ page 178)

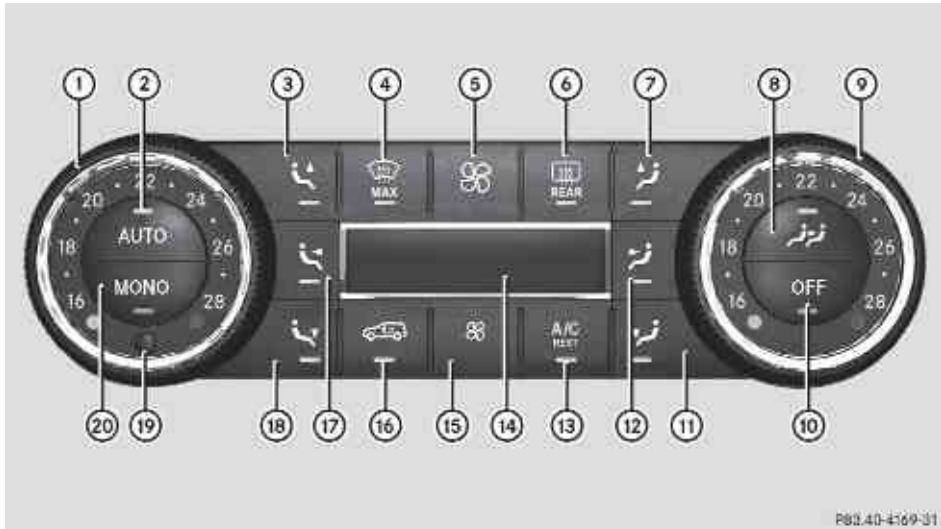

P83.40-4169-31

Canada only

	Function	Recommendation/Notes	
1	Temperature control, driver's side	i Set the temperature to 72°F (22°C).	(▷ page 179)
2	Air distribution and air volume (automatic mode)	i Switches on the automatic mode. The indicator lamp in button AUTO comes on.	(▷ page 179)
3	Air distribution, driver's side (directs air through the windshield and side air vents)		(▷ page 180)
4	Front defroster	i Keep this setting selected only until the windshield or the side windows are clear again.	(▷ page 181)
5	Increasing air volume		(▷ page 181)
6	Rear window defroster		(▷ page 183)

Function	Recommendation/Notes	
⑦ Air distribution, passenger side (directs air through the windshield and side air vents)		(▷ page 180)
⑧ Operating the rear climate control from the front		(▷ page 178)
⑨ Temperature control, passenger side	i Set the temperature to 72°F (22°C).	(▷ page 179)
⑩ Automatic climate control on/off	i Switches on the climate control system. The indicator lamp in button OFF goes out.	(▷ page 178)
⑪ Air distribution, passenger side (directs air through the footwells and side air vents)		(▷ page 180)
⑫ Air distribution, passenger side (directs air through center and side air vents)		(▷ page 180)
⑬ AC cooling on/off	i Switches on the air conditioning. The indicator lamp in button A/C REST comes on.	(▷ page 178)
Residual heat ventilation	i With the engine turned off, it is possible to continue to heat or ventilate the interior.	(▷ page 183)
⑭ Display		
⑮ Decreasing air volume		(▷ page 181)
⑯ Air recirculation	i Only use this function for a short time, e.g. in a tunnel. Otherwise, the windows can fog up due to lack of fresh air.	(▷ page 182)
⑰ Air distribution, driver's side (directs air through center and side air vents)		(▷ page 180)
⑱ Air distribution, driver's side (directs air through the footwells and side air vents)		(▷ page 180)

	Function	Recommendation/Notes
⑰	Interior temperature sensor	
⑳	Adopting driver's side settings for all zones	(> page 183)

Rear automatic climate control



- ① Increasing air volume
- ② Temperature control
- ③ Air distribution and air volume (automatic mode)
- ④ Air distribution (directs air through the side air vents)
- ⑤ Air distribution (directs air through the footwells and side air vents)
- ⑥ Rear automatic climate control on/off
- ⑦ Decreasing air volume

Notes on 3-zone automatic climate control

With the help of a sun sensor, the automatic climate control determines the relation of the sun to the vehicle and automatically adjusts the inside temperature for every individual zone.

The automatic climate control is operational whenever the engine is running. It cools the vehicle's interior according to the angle and intensity of the sun's rays, the outside temperature and the selected temperature. You can operate the automatic climate control in either the automatic or manual mode.

Nearly all dust particles, pollutants and odors are filtered out before outside air enters the passenger compartment through the air distribution system.

⚠ Warning!

Severe conditions (e.g. strong air pollution) may require replacement of the filter before its scheduled replacement interval. A clogged filter will reduce the air volume to the interior and the windows could fog up, impairing visibility and endangering you and others. Have a clogged filter replaced as soon as possible at an authorized Mercedes-Benz Center.

The air conditioning will not engage (no cooling) if the **A/C** mode is deactivated (> page 178).

⚠ Warning!

Follow the recommended settings for heating and cooling given on the following pages. Otherwise the windows could fog up, impairing visibility and endangering you and others.

Keep the air intake grille in front of the windshield free of snow and debris.

- ❗ If the vehicle interior is hot, ventilate the interior before driving off, see "Summer opening feature" (> page 102). The climate control will then adjust the interior temperature to the set value much faster.

Deactivating the climate control system

Warning!

When the climate control system is switched off, the outside air supply and circulation are also switched off. Only choose this setting for a short time. Otherwise the windows could fog up, impairing visibility and endangering you and others.

Deactivating the front climate control

► **Deactivating:** Press button . The indicator lamp in the button comes on. Canada only: Display ⑭ (▷ page 175) is cleared.

► **Reactivating:** Press button .

i You can also press button  on the climate control panel.

If you press button  to reactivate the climate control system, the defrosting mode is activated.



Deactivating the rear climate control from the front

USA only

► **Deactivating:** Press button . The indicator lamp in the button comes on.

► **Reactivating:** Press button . The indicator lamp in the button goes out.

Canada only



► **Deactivating:** Press button . The indicator lamp in the button comes on. In display ⑭ (▷ page 175), you will see the  symbol followed by MODE for approximately 3 seconds.

► Within these 3 seconds press button .

In display ⑭, you will see the  symbol followed by OFF.

The rear climate control is switched off.

► **Reactivating:** Press button .

The indicator lamp in the button comes on. In display ⑭, you will see the  symbol followed by ON and MODE. The MODE display is cleared and the indicator lamp in button  goes out after approximately 3 seconds.

The rear climate control switches on.

Deactivating the rear climate control from the rear

► **Deactivating:** Press button .

The indicator lamp in the button comes on.

► **Reactivating:** Press button .

The indicator lamp in the button comes on.

Air conditioning

The air conditioning is operational while the engine is running and cools the interior air to the temperature set by the operator. In addition, the air conditioning dehumidifies the interior air and helps prevent window fogging.

Warning!

If you switch off the air conditioning, the vehicle will not be cooled when weather conditions are warm. The windows can fog up more quickly. Window fogging may impair visibility and endanger you and others.

i Condensation may drip out from underneath the vehicle. This is normal and not an indication of a malfunction.

Deactivating

It is possible to deactivate the cooling function of the climate control system. The interior air will then no longer be cooled or dehumidified.

► Press button .

The indicator lamp in the button goes out.

The cooling function switches off after a short delay.

Activating

Moist air can fog up the windows. You can dehumidify the interior air with the air conditioning.

- ▶ Press button  again.

The indicator lamp in the button comes on.

The air conditioning uses the refrigerant R134a. This refrigerant is free of CFCs which are harmful to the ozone layer.

! If the air conditioning cannot be activated again, this indicates that the air conditioning is losing refrigerant. The compressor has turned off.

Have the air conditioning checked at the nearest authorized Mercedes-Benz Center.

Automatic mode

You can switch the climate control system on and off for each zone of the passenger compartment as desired.

When operating the climate control system in automatic mode, the interior air temperature, air volume and air distribution are adjusted automatically.



In automatic mode, cooling with dehumidification is switched on. This function can be switched off if necessary.

Warning!

If you switch off the air conditioning, the vehicle will not be cooled when weather conditions are warm. The windows can fog up more quickly. Window fogging may impair visibility and endanger you and others.





- ▶ Set the desired temperature (▷ page 179).
- ▶ **Activating:** Press button . The indicator lamp in the button comes on.

i The settings for the passenger side are also used for the rear passenger compartment.

- ▶ **Deactivating:** Press button  or . The indicator lamp in button  goes out.

The automatic air volume is switched off and is controlled according to the desired setting. The automatic air distribution remains switched on.



or

- ▶ Press an air distribution button ¹⁷, ¹⁷, ¹⁷, ¹⁸, ¹⁷ or ¹⁷.



The indicator lamp in button  goes out. The automatic air distribution is switched off and is controlled according to the desired position. The automatic air volume remains switched on.

Automatic mode with rear climate control panel

- ▶ **Activating:** Press button . The indicator lamp in the button comes on. The temperature, air volume and air distribution are adjusted automatically.

- ▶ **Deactivating:** Press button  or . The automatic air volume is switched off and is controlled according to the desired setting. The automatic air distribution remains switched on.

or

- ▶ Press button  or . The automatic air distribution is switched off and is controlled according to the desired position. The automatic air volume remains switched on.

Setting the temperature

You can set the air temperature for each of the 3 zones separately. You should raise or lower the temperature setting in small

¹⁷ Canada only

¹⁸ USA only

increments, preferably starting at 72°F (22°C).



Front temperature with front climate control panel

USA only

- **Increasing/decreasing:** Turn temperature control ① and/or ⑦ (▷ page 173) slightly clockwise or counterclockwise.

Canada only



- **Increasing/decreasing:** Turn temperature control ① and/or ⑨ (▷ page 175) slightly clockwise or counterclockwise.

Rear temperature with front climate control panel

USA only

- Press button .
- **Increasing/decreasing:** Turn temperature control ⑦ (▷ page 173) slightly clockwise or counterclockwise.

Canada only

- Press button . In display ⑭ (▷ page 175) you will see the  symbol.
- **Increasing/decreasing:** Turn temperature control ⑨ (▷ page 175) slightly clockwise or counterclockwise.



Rear temperature with rear climate control panel



- **Increasing/decreasing:** Turn temperature control ② (▷ page 177) slightly clockwise or counterclockwise.

Adjusting air distribution

USA only

The air distribution can be adjusted manually. The symbols on the buttons represent the following functions:

Symbol	Function
	Directs air to the windshield and side air vents
	Directs air through the center and side air vents
	Directs air to the footwells and side air vents

- Press the desired air distribution button , , or .
- The automatic mode is switched off. The indicator lamp in the desired button comes on.

Canada only

The air distribution can be adjusted separately on each side of the passenger compartment.

The symbols on the buttons represent the following functions:

Symbol Driver's side	Symbol Passenger side	Function
		Directs air to the windshield and side air vents
		Directs air through the center, side and rear passenger compartment air vents
		Directs air to the footwells and side air vents

- Press the desired air distribution button , , or for the driver's side, or , , or for the passenger side.
- The automatic mode is switched off. The indicator lamp in the desired button comes on.

Adjusting air volume

USA only

- **Decrease/increase:** Press button or .

The automatic mode is switched off. The selected blower speed is shown in air volume display ⑪ (> page 173).

Canada only

- **Decrease/increase:** Press button or .

The automatic mode is switched off. The selected blower speed appears in display ⑭ (> page 175).

When using the Voice Control System, the blower speed reduces automatically. When the Voice Control System is not used anymore, the blower speed increases to the previously selected level.

Front defroster

You can use this setting to defrost the windshield, for example if it is iced up. You can also defog the windshield and the side windows.

- i** Keep this setting selected only until the windshield or the side windows are clear again.

Activating

- Press button

The indicator lamp in the button comes on.

The climate control switches to the following functions automatically:

- most efficient blower speed and heating power, depending on outside temperature
- air flows onto the windshield and the front door windows (side air vents must be open)
- the air conditioning compressor switches on at outside temperatures above approximately 41°F (5°C) for air-drying



Adjustments

You can adjust the air volume and the temperature when the front defroster is switched on. The air flow will remain on the windshield and front door windows.

- Press button to decrease or button to increase air volume to the desired level.

The air volume decreases/increases to the next lower/higher blower speed and heating switches to the temperature that



was set before the front defroster was switched on.

The indicator lamp in button  goes out. The indicator lamp in button  comes on.

or



- ▶ Turn temperature control ① and/or ⑦ (USA only) (▶ page 173) or ① and/or ⑨ (Canada only) (▶ page 175) slightly in any direction.

Heating switches to the temperature that was set before the front defroster was switched on.

The indicator lamp in button  goes out. The indicator lamp in button  comes on.

- i** The air conditioning compressor remains on even if the indicator lamp in button  goes out. This helps to prevent the windshield from fogging.



Deactivating

- ▶ Press button  once more. The indicator lamp in the button goes out. Defrosting is turned off. The previous settings are once again in effect. The air conditioning compressor remains switched on.
- i** To deactivate, you can also press button  or .

Windshield fogged on the outside

- ▶ Switch the windshield wipers on (▶ page 98).
- ▶ Press button . The indicator lamp in the button goes out. Air volume and air distribution are controlled separately for each zone.

If the automatic air volume and air distribution are switched off:

- ▶ Press buttons  / ¹⁹ and  / ¹⁹.

Air recirculation mode

Switch to air recirculation mode to prevent unpleasant odors from entering the vehicle from the outside (e.g. before driving through a tunnel). This setting cuts off the intake of outside air and recirculates the air in the passenger compartment.

Warning!

Fogged windows impair visibility, endangering you and others. If the windows begin to fog on the inside, switching off the air recirculation mode immediately should clear interior window fogging. If interior window fogging persists, make sure the air conditioning is activated, or press button



- ▶ **Activating:** Press button . The indicator lamp in the button comes on.

- i** The air recirculation mode is activated automatically at high outside temperatures. The indicator lamp in button  is not lit when the air recirculation mode is switched on automatically.

A quantity of outside air is added after approximately 30 minutes.

If you have turned off the air conditioning or the outside temperature is below 41 °F (5°C), the air recirculation mode will not switch on automatically.

- ▶ **Deactivating:** Press button . The indicator lamp in the button goes out.

- i** The manually selected air recirculation mode is deactivated automatically:
- after 5 minutes if the outside temperature is below approximately 41°F (5°C)
 - after 5 minutes if the air conditioning and air-drying are turned off
 - after 30 minutes if the outside temperature is above approximately 41°F (5°C)



At outside temperatures above 79°F (26°C) the system will not automatically switch back to outside air. A quantity of outside air is added after approximately 30 minutes.

Residual heat and ventilation

With the engine switched off, it is possible to continue to heat or ventilate the interior for up to 30 minutes. This feature makes use of the residual heat produced by the engine.

- i** How long the system will provide heating depends on the coolant temperature and the battery voltage.

Regardless of the temperature and air volume set on the climate control panel, an interior temperature is aimed at by 72°F (22°C) and the blower runs on low speed to protect the vehicle battery.

- ▶ **Activating:** Switch off the ignition.
- ▶ Press button  .
The indicator lamp in the button comes on.
- ▶ **Deactivating:** Press button  again.
The indicator lamp in the button goes out.

The residual heat is deactivated automatically:

- when the ignition is switched on
- after approximately 30 minutes
- if the battery voltage drops
- if the coolant temperature is too low

Using driver-side settings for all temperature zones

This feature is only available in Canada vehicles.

You can use the settings of the driver's side, such as temperature, air volume and air distribution, for all temperature zones. These settings only need to be made once and the climate control system will automatically regulate the settings for all temperature zones quickly and comfortably.

- ▶ **Activating:** Adjust the air temperature, air volume and air distribution.

- ▶ Press button  .

The indicator lamp in the button comes on.

The driver-side settings are used for all temperature zones.

- ▶ **Deactivating:** Press button  again.

The indicator lamp in the button goes out.



- i** If you manually set the temperature, air volume or air distribution for the passenger side or the rear passenger compartment when the **MONO** setting is active, the **MONO** setting will be switched off.

Rear window defroster

Warning!

Any accumulation of snow and ice should be removed from the rear window before driving. Visibility could otherwise be impaired, endangering you and others.

The rear window defroster uses a large amount of power. To keep the battery drain to a minimum, switch off the defroster as soon as the rear window is clear. The defroster is switched off automatically after some time of operation depending on the outside temperature.

- ▶ Switch on the ignition.
- ▶ **Switching on:** Press button  on the respective climate control panel. The indicator lamp in the button comes on.
- ▶ **Switching off:** Press button  again. The rear window defroster switches off when the battery voltage is too low. The indicator lamp in button  flashes. Too many electrical consumers may be operating simultaneously.
- ▶ Switch off consumers that are currently not needed if required.

Power tilt/sliding sunroof

Opening and closing

 **Observe Safety notes, see page 55.**

Warning!

When opening or closing the tilt/sliding sunroof, make sure there is no danger of anyone being harmed by the opening/closing procedure.

The tilt/sliding sunroof is equipped with the express operation and automatic reversal function. If the movement of the tilt/sliding sunroof is blocked during the closing procedure, the tilt/sliding sunroof will stop and open slightly.

The tilt/sliding sunroof operates differently when the sunroof switch is pressed and held. See the “Closing when the tilt/sliding sunroof is blocked” section for details.

The opening/closing procedure of the tilt/sliding sunroof can be immediately halted by releasing the sunroof switch or, if the sunroof switch was moved past the resistance point and released, by moving the sunroof switch in any direction.

Warning!

The tilt/sliding sunroof is made out of glass. In the event of an accident, the glass may

shatter. This may result in an opening in the roof.

In a vehicle rollover, occupants not wearing their seat belts or not wearing them properly may be thrown out of the opening. Such an opening also presents a potential for injury for occupants wearing their seat belts properly as entire body parts or portions of them may protrude from the passenger compartment.

 To avoid damaging the seals, do not transport any objects with sharp edges which can stick out of the tilt/sliding sunroof.

Do not open the tilt/sliding sunroof if there is snow or ice on the roof, as this could result in malfunctions.

If you cannot open or close the tilt/sliding sunroof due to a malfunction contact Roadside Assistance or an authorized Mercedes-Benz Center.

 Please keep in mind that weather conditions can sometimes change rapidly. Make sure to close the tilt/sliding sunroof when leaving the vehicle. If water enters the vehicle interior, vehicle electronics could be damaged which is not covered by the Mercedes-Benz Limited Warranty.

 You can also open or close the tilt/sliding sunroof using the SmartKey or the KEYLESS-GO function, see “Summer opening feature” (▶ page 102) and “Convenience closing feature” (▶ page 102).

 After switching off the ignition or removing the SmartKey from the starter switch, you can operate the tilt/sliding sunroof until you open the driver’s or front passenger door. If no door was opened you can operate the tilt/sliding sunroof for up to 5 minutes.



Sunroof switch

With the sunroof closed or raised, you can slide the sunroof screen forward and back.



Sunroof screen

- ▶ Switch on the ignition.

Opening

- ▶ **Opening manually:** Press and hold the sunroof switch to the resistance point in direction of arrow ①.
- ▶ Release the sunroof switch when the desired position is reached.
- ▶ **Express operation:** To open the tilt/sliding sunroof completely, press the sunroof switch past the resistance point in direction of arrow ② and release.
- ▶ **Stopping during express operation:** Move the sunroof switch in any direction.

- ▶ **Express opening is not available when the tilt/sliding sunroof is raised. The tilt/sliding sunroof must be closed first.**

- ▶ **Express raising is not available when the tilt/sliding sunroof is open. The tilt/sliding sunroof must be closed first.**

Raising

- ▶ **Raising manually:** Press and hold the sunroof switch to the resistance point in direction of arrow ①.
- ▶ Release the sunroof switch when the desired position is reached.
- ▶ **Express operation:** To raise the tilt/sliding sunroof completely, press the sunroof switch past the resistance point in direction of arrow ① and release.
- ▶ **Stopping during express operation:** Move the sunroof switch in any direction.

- ▶ **Express raising is not available when the tilt/sliding sunroof is open. The tilt/sliding sunroof must be closed first.**

Closing

- ▶ **Closing manually:** Pull and hold the sunroof switch to the resistance point in direction of arrow ③.
- ▶ Release the sunroof switch when the desired position is reached.
- ▶ **Express operation:** To close the tilt/sliding sunroof completely, pull the sunroof switch past the resistance point in direction of arrow ③ and release.
- ▶ **Stopping during express operation:** Move the sunroof switch in any direction.

Closing when the tilt/sliding sunroof is blocked

Warning!

Make sure that nobody can become trapped and be seriously or even fatally injured when

closing the tilt/sliding sunroof with greater force or without automatic reversal function.

If the movement of the tilt/sliding sunroof is blocked during the closing procedure (e.g. by ice or pollution), the tilt/sliding sunroof will stop and open slightly.

- ▶ Immediately after the tilt/sliding sunroof has stopped and opened because it was blocked, pull and hold the sunroof switch in direction of arrow ③ until the tilt/sliding sunroof is fully closed. The tilt/sliding sunroof closes with greater force.

If the tilt/sliding sunroof is blocked again and opens slightly:

- ▶ Immediately after the tilt/sliding sunroof was blocked and has opened, pull and hold the sunroof switch in direction of arrow ③ until the tilt/sliding sunroof is fully closed. The tilt/sliding sunroof closes without automatic reversal function.

Warning!

Pulling and holding the sunroof switch to close the tilt/sliding sunroof immediately after it had been blocked two times will cause the tilt/sliding sunroof to close without any reversal function for as long as you hold the sunroof switch.

Synchronizing

The tilt/sliding sunroof must be synchronized

- after the battery has been disconnected or discharged
- after a malfunction
- if the tilt/sliding sunroof does not open smoothly

- ❗ If the tilt/sliding sunroof cannot be closed or synchronized, contact an authorized Mercedes-Benz Center or call Roadside Assistance.

- ▶ Vehicles with SmartKey: Switch off the ignition and remove the SmartKey from the starter switch.
- ▶ Vehicles with KEYLESS-GO: Switch off the ignition and open the driver's door. This puts the starter switch in position **0**, same as with the SmartKey removed from the starter switch. The driver's door then can be closed again.
- ▶ Remove the fuse for the tilt/sliding sunroof from the fuse box (▷ page 342).
- ▶ Reinsert the fuse in the fuse box.
- ▶ Switch on the ignition.
- ▶ Press and hold the sunroof switch in direction of arrow ① (▷ page 185) until the tilt/sliding sunroof is fully raised at the rear.
- ▶ Keep holding the sunroof switch in direction of arrow ① for approximately 1 second.
- ▶ Check the express operation feature (▷ page 185). If the tilt/sliding sunroof opens and closes completely, the roof is synchronized. Otherwise repeat the above steps.

Loading and storing

Loading instructions

Warning!

Always fasten items being carried as securely as possible. Use cargo tie-down rings and fastening materials appropriate for the weight and size of the load.

In an accident, during hard braking or sudden maneuvers, loose items will be thrown around inside the vehicle. This can cause injury to vehicle occupants unless the items are securely fastened in the vehicle.

To help avoid personal injury during a collision or sudden maneuver, exercise care when transporting cargo. Do not pile luggage or cargo higher than the seat backrests.

The cargo compartment is the preferred place to carry objects. Always use cargo tie-down rings, and if so equipped, always use the cargo net when transporting cargo.

Never drive a vehicle with the tailgate open. Deadly carbon monoxide (CO) gases may enter vehicle interior resulting in unconsciousness and death.

Load distribution

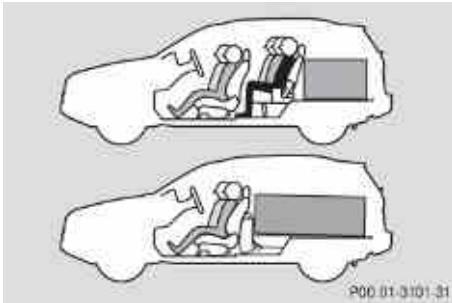

The Gross Vehicle Weight (GVW) is the weight of the vehicle including:

- fuel
- tools
- spare wheel
- installed accessories
- passengers
- luggage/cargo

It must never exceed the load limit and the Gross Vehicle Weight Rating (GVWR) for your vehicle. The load limit and the GVWR are specified on the placard located on the driver's door B-pillar (▷ page 227).

In addition, the load must be distributed so that the weight on each axle never exceeds the Gross Axle Weight Rating (GAWR) for the front and rear axle. The GVWR and GAWR for your vehicle are indicated on the certification label located on the driver's door B-pillar (▷ page 227).

For more information, see "Tire and Loading Information" (▷ page 227).

The handling characteristics of a fully loaded vehicle depend greatly on the load distribution. It is therefore recommended to load the vehicle according to the illustration shown. The heaviest items are to be placed towards the front of the vehicle.

- ❗ The cargo compartment is the preferred place to carry objects. The expanded cargo volume (▷ page 189) should only be used for items which do not fit in the cargo compartment alone.

Please pay attention to and comply with the following instructions when loading the vehicle and transporting cargo:

- Always place items being carried against front or rear seat backrests, and fasten them as securely as possible.
- The heaviest portion of the cargo should always be kept as low as possible against front or rear seat backrests.



For additional safety when transporting cargo while the rear seats are unoccupied, fasten the outer seat belts crosswise into the opposite side buckles.

Carriers

For information about further carriers, contact an authorized Mercedes-Benz Center.

⚠ Warning!

Only use carriers when the basic carrier bars have been completely mounted. The left and right roof rails are only stabilized by means of the basic carrier bars mounted.

Follow the manufacturer's installation instructions. Otherwise, an improperly attached carrier or its load could become detached from the vehicle.

Do not exceed the maximum roof load of 220 lb (100 kg).

Take into consideration that when the roof is loaded, the handling characteristics are different from those when operating the vehicle without the roof loaded.

Make sure

- you can raise the tilt/sliding sunroof at the rear completely
- you can open the tailgate completely



① Roof rails

Parcel nets**⚠ Warning!**

Vehicles with Occupant Classification System (OCS)

Do not place objects with a combined weight of more than 4.4 lbs (2 kg) into the parcel net on the back of the front passenger seat.

Otherwise, the OCS may not be able to properly approximate the occupant weight category.

⚠ Warning!

Parcel nets are intended for storing light-weight items only, such as road maps, mail, etc.

Heavy objects, objects with sharp edges, or fragile objects may not be transported in the parcel nets. In an accident, during hard braking, or sudden maneuvers, they could be thrown around inside the vehicle and cause injury to vehicle occupants.

Parcel nets cannot protect transported goods in the event of an accident.

Parcel nets are located in the front passenger footwell and on each of the front seat backrests.

Cargo tie-down rings

Your vehicle is equipped with six cargo tie-down rings.

Always follow loading instructions (▷ page 186).

Carefully secure cargo by applying even load on all the cargo tie-down rings with a rope of sufficient strength to hold down the cargo.



Cargo tie down rings, cargo compartment



Cargo tie down rings, second-row footwell

Hooks

Four hooks are located on the rear compartment trim panels, two on each side. Use the hooks to secure light-weight items only. The maximum permissible weight per hook is 9 lbs (4 kg).



Expanding cargo volume

You can separately fold the left and right rear seat backrests to expand the cargo volume.

Warning!

When expanding the cargo volume, always fully fold the corresponding seats and, if so equipped, always use the cargo net when transporting cargo.

Unless you are transporting cargo, the seat backrests must remain properly locked in the upright position.

In an accident, during hard braking or sudden maneuvers, loose items will be thrown around inside the vehicle. This can cause injury to vehicle occupants unless the items are securely fastened in the vehicle.

Always use the cargo tie-down rings.

Warning!

Never drive a vehicle with the tailgate open. Deadly carbon monoxide (CO) gases may enter vehicle interior resulting in unconsciousness and death.

Folding rear seat backrest forward

 Always release the seat cushion and fold it up before folding the seat backrest forward. The seat backrest may otherwise be damaged.

When the seat backrest is folded forward, the front seats may not be moved to the rearmost position. Otherwise you could damage the front and second-row seats.



- ▶ Pull release loop ①.
- ▶ Fold seat cushion ② forward.

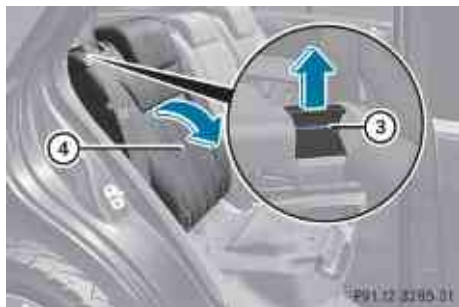

- ▶ Lower the rear seat head restraints completely (▷ page 84).
- ▶ Pull release handle (3).

A red indicator (5) will be visible and seat backrest (4) is released.



- ▶ Fold seat backrest (4) forward.

Returning rear seat backrest to original position



- ! Make sure that the seat belt is not pinched when folding rear seat backrest.

- ▶ Fold seat backrest (1) rearward until it engages. Red indicator (5) should no longer be visible.
- ▶ Fold seat cushion (2) rearward until it locks into position.
- ▶ Check for secure locking by pushing and pulling on seat backrest (1).

Warning!

If a red indicator is visible with the seat backrest up, then the seat backrest is not properly locked into position.

Always lock seat backrest in its upright position when the rear seats are occupied, or the extended cargo compartment is not in use. Check for secure locking by pushing and pulling on the seat backrest.

- ▶ Adjust the rear seat head restraints, if necessary (▷ page 83).

Cargo compartment cover blind

The cargo compartment cover blind can be installed behind the rear seats.

- ! With the cargo compartment cover blind installed, do not pile luggage higher than the lower edges of the rear side windows.



- ▶ **Rolling out:** Pull cargo compartment cover blind on handle ① across the cargo compartment.
- ▶ Guide cargo compartment cover blind into mounts ② and release.
- ▶ **Rolling up:** Disengage cargo compartment cover blind and guide retraction by its handle ①.

Before removing or installing cargo compartment cover blind behind the rear seats, fold the left or right rear seat forward (▷ page 189). Afterwards, return the left or right rear seat into its original position.



- ▶ **Removing:** Roll up cargo compartment cover blind.
- ▶ Push release button ③.
- ▶ Pull cargo compartment cover blind ④ to the left.
- ▶ Remove cargo compartment cover blind.
- ▶ **Installing:** Make sure release button ③ faces up and handle ① is to the rear before inserting the cargo compartment cover blind.
- ▶ Place left side of cargo compartment cover blind in left mount.
- ▶ Position right side of cargo compartment cover blind over right mount.
- ▶ Press release button ③ and guide cargo compartment cover blind into mount.
- ▶ Make sure cargo compartment cover blind is securely fastened.

Cargo net

⚠ Warning!

Make sure the cargo net is properly engaged at top and bottom position and the tightening belts are securely fastened.

Never use a damaged cargo net.

Always use cargo net when transporting cargo. This helps to avoid personal injury from smaller objects being thrown around in the occupant compartment during a collision or sudden maneuver.

The cargo net cannot prevent the movement of large, heavier objects into the passenger compartment in an accident. Such items must be properly secured using the cargo tie-down rings in the cargo compartment floor.

Passenger use of seats behind installed cargo net is restricted because of the footwell being taken up by the net.

Use of the cargo net is a particularly important safety factor when the vehicle is loaded higher than the top of the seat backrests with smaller objects. For your safety, always use the cargo net when transporting cargo.

The cargo net can be installed behind the B-pillar or the C-pillar.



- With the cargo volume expanded (▷ page 189), use holders ① behind B-pillars and the cargo tie-down rings in the second-row footwell (▷ page 189).
- Without the cargo volume expanded, use holders ② behind C-pillars and the cargo

tie-down rings in the cargo compartment (▷ page 188).

- ▶ Open the hook and loop fasteners on the cargo net package.
- ▶ Roll out the cargo net.
- ▶ Unfold the cargo net.
- ▶ Engage the upper cargo net bar. The cargo net bar must engage audibly.

Installing the cargo net

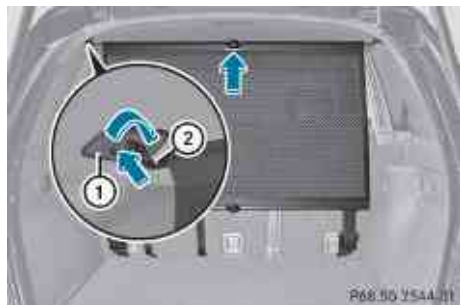

Cargo net installed behind the C-pillar

- ▶ Hang cargo net bar (2) on holder (1) as indicated by the arrow.
- ▶ Push cargo net bar (2) forward into holder (1) in direction of arrow.
- ▶ Engage lower cargo net bar. The cargo net bar must engage audibly.

Pulling the cargo net tight

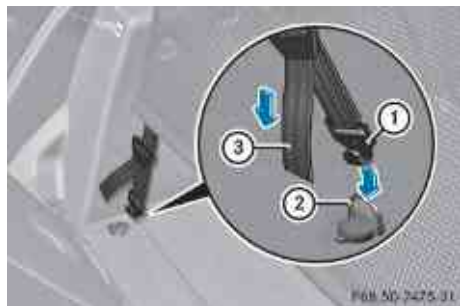

Belt hook attached behind the rear seat backrests

- ▶ Hook belt hook (1) into cargo tie-down ring (2) in direction of arrow.
- ▶ Pull tightening belt (3) by the loose end in direction of arrow until the cargo net is pulled tight.
- ▶ After driving a short distance, make sure the cargo net is still tight and, if necessary, pull it tight again.

Loosening the cargo net

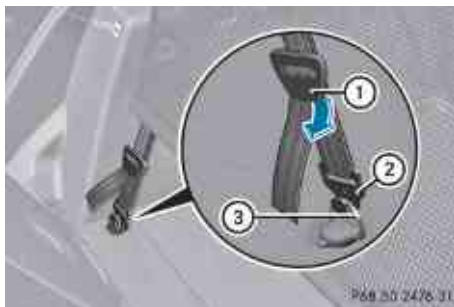

Belt hook attached behind the rear seat backrests

- ▶ Loosen the tightening belt by pulling buckle (1) upward in direction of arrow.
- ▶ Remove belt hook (2) from cargo tie-down ring (3).

Removing and storing the cargo net

- ▶ Take cargo net bar (2) (▷ page 192) out of holder (1) (▷ page 192).
- ▶ Press the red button on the upper and lower cargo net bar.
- ▶ Fold the cargo net.
- ▶ Roll up the cargo net.
- ▶ Close the hook and loop fasteners on the cargo net package.

Front storage compartments

Warning!

To help avoid personal injury during a collision or sudden maneuver, exercise care when

storing objects in the vehicle. Put luggage or cargo in the cargo compartment if possible. Do not pile luggage or cargo higher than the seat backrests.

If so equipped, always use the cargo net when transporting cargo. The cargo net cannot secure hard or heavy objects.

Parcel nets cannot secure hard or heavy objects.

Keep compartment lids closed. This will help to prevent stored objects from being thrown about and injuring vehicle occupants during

- braking
- vehicle maneuvers
- an accident

Glove box

Depending on vehicle equipment, an AUX socket or a media interface is located in the glove box. For information on Audio AUX mode or on media interface, see separate COMAND system operating instructions.



- ▶ **Opening:** Pull glove box lid release ①.
- ▶ **Closing:** Push glove box lid ② upwards until it engages.

You can lock the glove box, e.g. when the vehicle is in the shop for service.

The glove box can only be locked or unlocked with the mechanical key.



- ① Glove box unlocked
- ② Glove box locked

Storage compartment in front center console



- ▶ Press the front of the cover briefly. The cover opens automatically.

Front armrest storage compartment



- ① The Roadside Assistance button  (▷ page 201) and the Information button

 (▷ page 202) are located in the storage compartment.

- ▶ **Opening storage compartment:** Pull button ① and lift up armrest.

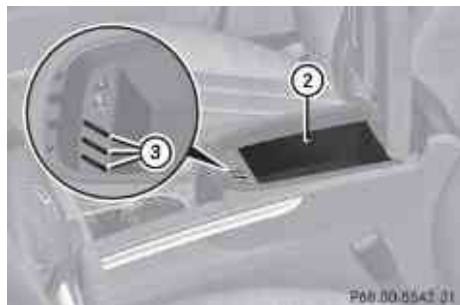

Coin holders ③ are located in front of storage compartment ②.

Rear storage compartments

Depending on vehicle equipment, your vehicle may not be equipped with three storage compartments in the front of the rear seats.

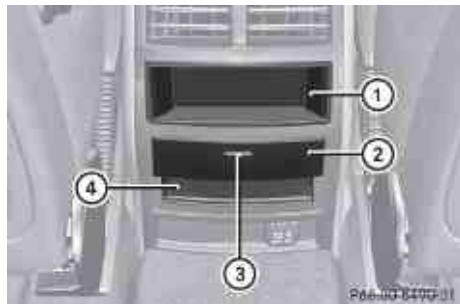

- ① Storage compartment
- ② Storage compartment cover
- ③ Release button
- ④ Storage compartment

- ▶ Briefly press release button ③ on storage compartment cover ②. The storage compartment opens automatically.

Useful features

Cup holders

Warning!

In order to help prevent spilling liquids on vehicle occupants and/or vehicle equipment, only use containers that fit into the cup holder. Use lids on open containers and do not fill containers to a height where the contents, especially hot liquids, could spill during braking, vehicle maneuvers, or in an accident. Liquids spilled on vehicle occupants may cause serious personal injury. Liquids spilled on vehicle equipment may cause damage not covered by the Mercedes-Benz Limited Warranty.

When not in use, keep the cup holder closed. An open cup holder may cause injury to you or others when contacted during braking, vehicle maneuvers, or in an accident.

Keep in mind that objects placed in the cup holder may come loose during braking, vehicle maneuvers, or in an accident and be thrown around in the vehicle interior. Objects thrown around in the vehicle interior may cause an accident and/or serious personal injury.

Cup holder in front center console

A cup holder and a removable card/ticket holder are located in the front center console. The cup holder can be removed for cleaning purposes.

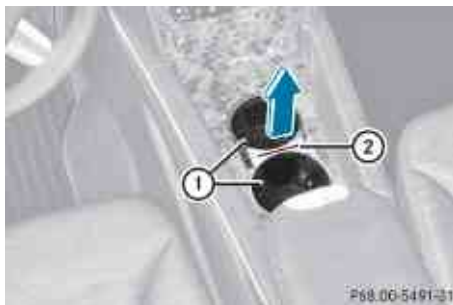

- ▶ **Removing:** Hold cup holder at its bridge ② and pull out bridge in direction of arrow.
- ▶ Pull cup holder ① out in direction of arrow.
- ▶ **Reinstalling:** First, insert cup holder ① and then insert bridge ②.

Cup holder in rear armrest

- ▶ Fold down the rear armrest.



- ▶ **!** Do not sit on or lean your body weight against the armrest when it is folded down, as you could otherwise damage it.

Sun visors

Warning!

Do not use the vanity mirror while driving. Keep the vanity mirrors in the sun visors closed while vehicle is in motion. Reflected glare can endanger you and others.

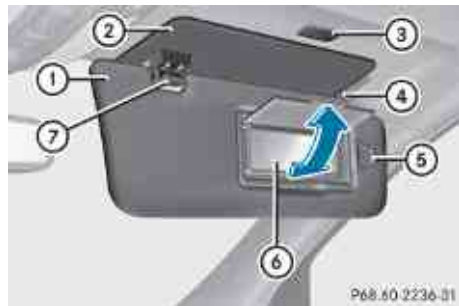

- ① Sun visor
- ② Additional sun visor
- ③ Vanity mirror lamp
- ④ Vanity mirror cover
- ⑤ Holder, e.g. for gas cards
- ⑥ Vanity mirror
- ⑦ Mounting

Glare through the windshield

- ▶ Flip sun visor ① down when you experience glare.

Glare through a door window

- ▶ Close vanity mirror cover ④ if opened.
- ▶ Disengage sun visor ① from mounting ⑦.
- ▶ Pivot sun visor ① to the side.

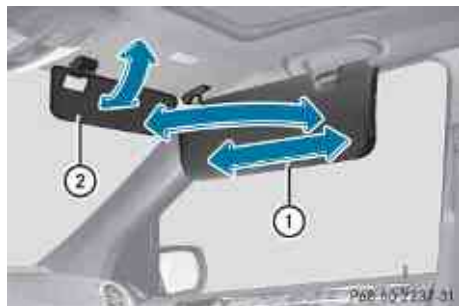

- ▶ Adjust sun visor ① by pushing or pulling in direction of arrows.
- ▶ Flip down additional sun visor ② when you experience additional glare through the windshield.

Vanity mirror

Vanity mirror lamp ③ only functions when sun visor ① is engaged in mounting ⑦.

- ▶ Flip sun visor down.
- ▶ Lift up vanity mirror cover ④.
Vanity mirror lamp ③ comes on.



Ashtrays

Center console ashtray

i A storage compartment is located under the ashtray insert.

! The storage compartment is not heat-proof. Therefore, do not stub cigarettes in the storage compartment.



- ▶ **Opening:** Press cover ② briefly.
- ▶ **Removing ashtray insert:** Grab ashtray insert ① on the sides and pull it out upwards.
- ▶ **Reinstalling ashtray insert:** Install ashtray insert ①.
- ▶ **Closing:** Push cover ②.

Rear center console ashtray

! Close the ashtray when not in use and before folding the rear seats. Otherwise you could damage the ashtray.

- ▶ **Opening:** Press cover ② briefly.
- ▶ **Removing ashtray insert:** Grab ashtray insert ① on the sides and pull it out upwards.
- ▶ **Reinstalling ashtray insert:** Install ashtray insert ①.
- ▶ **Closing:** Push cover ②.

Cigarette lighter

⚠ Observe Safety notes, see page 55.

⚠ Warning!

Never touch the heating element or sides of the lighter; they are extremely hot. Hold the knob only.

Make sure any children traveling with you do not injure themselves or start a fire with the hot cigarette lighter.

If the engine is off and the cigarette lighter is being used extensively, the vehicle battery may become discharged.

- ▶ Open the ashtray (▷ page 196).



- ▶ Switch on the ignition.
- ▶ Push in cigarette lighter ①.
Cigarette lighter ① will pop out automatically when hot.
- ▶ Take out cigarette lighter ①.
- ▶ Reinsert cigarette lighter ① in its socket after use.

! The lighter socket can be used to accommodate 12V DC electrical accessories (up to a maximum of 180 W) designed for use with the standard “cigarette lighter” plug type. Keep in mind, however, that connecting accessories to the lighter socket (for example extensive connecting and disconnecting, or using plugs that do not fit properly) can damage the lighter socket. With the socket damaged, the lighter may not function properly any longer.

! The cigarette lighter is not designed for use with the electric air pump. Use the power outlet in the second-row footwell for electric air pump operation.

Power outlets

i You can use the power outlets even if the ignition is switched off.

An emergency shut-off feature is designed to prevent the vehicle’s on-board voltage from dropping below a minimum level. If the on-board voltage drops to this

minimum level, the power outlets are automatically switched off, to help preserve engine starting power.

12V Power outlets

! If you use all power outlets in the vehicle, make sure that the maximum current drawn does not exceed 55 A.

! The power outlets in the front passenger footwell and cargo compartment are not designed for use with the electric air pump. Use the power outlet in the second-row footwell for electric air pump operation.

The power outlets can be used to accommodate 12V DC electrical accessories (e.g. mobile phone chargers, auxiliary lamps) up to a maximum of 20 A (240 W).



Front passenger footwell



Second-row footwell



Cargo compartment

115V AC Socket

Warning!

The 115V AC socket operates at high voltage. Use the 115V AC socket in the vehicle with the same caution and prudence that you exercise when using power outlets at home. Keep any fluids away from the 115V AC socket. Do not clean the socket with fluids or tapered objects. Keep the 115V AC socket cover in the closed position, when not in use. Otherwise, you could suffer an electric shock and be seriously or even fatally injured.

Warning!

A device that you connect must have a suitable plug that complies with U.S. standards. Never pull on the cable to unplug a plug from the 115V AC socket. Do not use a damaged connection cable. The 115V AC socket may not be connected to another 115V AC power source. Do not use converters to a grounding plug with the 115V AC socket. This could cause serious personal injury to you and/or others.

Warning!

If the 115V AC socket is damaged or torn out of the trim, do not use or touch the 115V AC socket. Using a 115V AC socket that is damaged or torn out of the trim could cause serious personal injury to you and/or others.

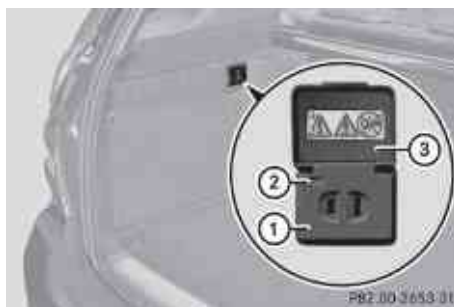

The 115V AC socket ① provides an alternating current of 115 volts, which enables you to connect small electrical devices with a combined received power of 150 W at most. You can connect small devices such as game consoles, mobile phone chargers, laptops, etc.

Prerequisites for operation:

- The 12V power outlets in the second-row footwell and cargo compartment (▷ page 197) are operational.
- The plug of the small device must be inserted fully into 115V AC socket ①.
- The on-board voltage of the vehicle is within the permissible voltage range.
- The specified wattage of the small device is identical or lower than the maximum permissible wattage (150 W) of the 115V AC socket ①.

► **Operation:** Open cover ③.

► Insert the plug of the small device into 115V AC socket ①.
LED ② comes on.

If LED ② does not come on, refer to the section on possible nonoperation causes.

► **Switching off:** Pull the plug out of 115V AC socket ①.

Do not pull on the cable.

► Close cover ③.

Possible nonoperation causes:

- The on-board voltage of the vehicle is not within the permissible voltage range.

- ▶ Start the engine.
- The temperature of the DC/AC inverter is temporarily too high.
 - ▶ Pull the plug of the small device out of 115V AC socket ① and plug it in again after waiting a few minutes.
- Some small devices have a continuous power rating of less than 150 W but a very high switch-on current. Such devices will not operate. When connecting such a device, 115V AC socket ① will not provide power.

If LED ② still does not come on, contact an authorized Mercedes-Benz Center.

Tele Aid

I In order to activate the Tele Aid system, a subscriber agreement must be completed. To ensure your system is activated and operational, please press Information button  to perform the acquaintance call. Failure to complete either of these steps may result in a system that is not activated.

If you have any questions regarding activation, please call the Customer Assistance Center at 1-800-FOR-MERCEdes (1-800-367-6372) (USA only) or 1-888-923-8367 (Canada only).

Shortly after the completion of your Tele Aid acquaintance call, you will receive a user ID and password in the mail. You may use this password to access the Tele Aid section in “Owner’s Online” at www.mbusa.com (USA only). The “My Tele Aid” section will give you access to account information, remote door unlock and more.

The Tele Aid system is available if

- it has been activated and is operational. Activation requires a subscription for

monitoring services, connection and cellular air time

- vehicle battery power is available
 - the relevant cellular phone network and GPS signals are available and pass the information on to the Customer Assistance Center
- i** Location of the vehicle on a map is only possible if the vehicle is able to receive signals from the GPS satellite network and pass the information on to the Customer Assistance Center.

The Tele Aid system

(Telematic Alarm Identification on Demand)

The Tele Aid system consists of three types of response:

- Automatic and manual emergency
- Roadside Assistance
- Information

To adjust the speaker volume during a Tele Aid call do the following:

- ▶ Press button  or  on the multifunction steering wheel.

or

- ▶ Use the adjustment button on your COMAND system.





Be sure to check “Owner’s Online” at www.mbusa.com (USA only) for more information and a description of all available features.

System self-test

The system performs a self-test after you have switched on the ignition.

Warning!

A malfunction in the system has been detected if any or all of the following conditions occur:

- The indicator lamp in the SOS button does not come on during the system self-test.
- The indicator lamp in Roadside Assistance button  does not come on during the system self-test.
- The indicator lamp in Information button  does not come on during the system self-test.
- The indicator lamp in the SOS button, Roadside Assistance button , or Information button  remains illuminated constantly in red after the system self-test.
- The message Tele Aid Inoperative or Tele Aid Not Activated appears in the multifunction display after the system self-test

If a malfunction is indicated as outlined above, the system may not operate as expected. In case of an emergency, help will have to be summoned by other means.

Have the system checked at the nearest Mercedes-Benz Center or contact the Customer Assistance Center at 1-800-FOR-MERCEdes (1-800-367-6372) (USA only) or 1-888-923-8367 (Canada only) as soon as possible.

Emergency calls

! In order to activate the Tele Aid system, a subscriber agreement must be completed. To ensure your system is activated and operational, please press Information button  to perform the acquaintance call. Failure to complete either of these steps may result in a system that is not activated.

If you have any questions regarding activation, please call the Customer Assistance Center at 1-800-FOR-MERCEdes (1-800-367-6372) (USA only) or 1-888-923-8367 (Canada only).

An emergency call is initiated automatically following an accident in which the Emergency Tensioning Devices (ETDs) or air bags have deployed.

i An automatically initiated Tele Aid emergency call cannot be canceled.

An emergency call can also be initiated manually (> page 201).

Once the emergency call is in progress, the indicator lamp in the SOS button will begin to flash. The message **Connecting Call** appears in the multifunction display and the COMAND system is muted. When the connection is established, the message **Call Connected** appears in the multifunction display.

All information relevant to the emergency, such as the location of the vehicle (determined by the GPS satellite location system), vehicle model, identification number and color are generated.

A voice connection between the Customer Assistance Center and the occupants of the vehicle will be established automatically soon after the emergency call has been initiated. The Customer Assistance Center will attempt to determine the nature of the emergency more precisely, provided they can speak to an occupant of the vehicle.

i If no vehicle occupant responds, an ambulance will be sent to the vehicle immediately.

Warning!

If the indicator lamp in the SOS button is flashing continuously and there was no voice connection to the Customer Assistance Center established, then the Tele Aid system could not initiate an emergency call (e.g. the relevant cellular phone network is not available).

The message **Call Failed** appears in the multifunction display for approximately 10 seconds.

Should this occur, assistance must be summoned by other means.

- i** The “911” emergency call system is a public service. Using it without due cause is a criminal offense.

Initiating an emergency call manually

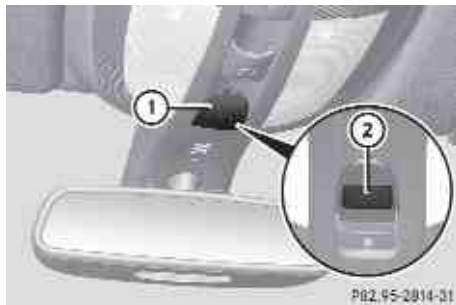

- ▶ Briefly press on cover ① to open.
- ▶ Press SOS button ② briefly. The indicator lamp in SOS button ② will flash until the emergency call is concluded.
- ▶ Wait for a voice connection to the Customer Assistance Center.
- ▶ Close cover ① after the emergency call is concluded.

⚠ Warning!

If you feel at any way in jeopardy when in the vehicle (e.g. smoke or fire in the vehicle, vehicle in a dangerous road location), please do not wait for voice contact after you have pressed the emergency button. Carefully leave the vehicle and move to a safe location. The Customer Assistance Center will automatically contact local emergency officials with the vehicle's approximate location if they receive an automatic SOS signal and cannot make voice contact with the vehicle occupants.

- ▶ **Terminating calls:** Press button  on the multifunction steering wheel.

or

- ▶ Press the respective button for ending a telephone call on the COMAND system.

Roadside Assistance button

- ▶ Open the front armrest storage compartment (▶ page 193).

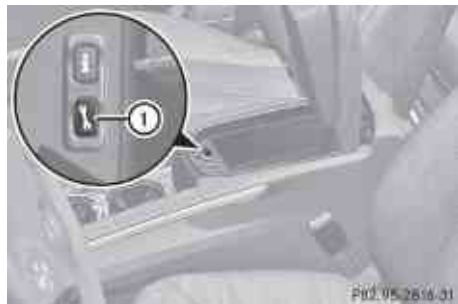

- ▶ Press and hold Roadside Assistance button ① for longer than 2 seconds. A call to a Mercedes-Benz Roadside Assistance dispatcher will be initiated. The indicator lamp in Roadside Assistance button ① will flash while the call is in progress. The message **Connecting Call** will appear in the multifunction display and the COMAND system is muted.

When the connection is established, the message **Call Connected** appears in the multifunction display. The Tele Aid system will transmit data generating the vehicle identification number, model, color and location (subject to availability of cellular and GPS signals).

- i** The COMAND system display indicates that a Tele Aid call is in progress. While the call is connected you can change to the navigation menu by pressing the NAVI button on the COMAND system. Spoken commands are not available.

A voice connection between the Roadside Assistance dispatcher and the occupants of the vehicle will be established.

- ▶ Describe the nature of the need for assistance.

The Mercedes-Benz Roadside Assistance dispatcher will either dispatch a qualified Mercedes-Benz technician or arrange to tow your vehicle to the nearest authorized Mercedes-Benz Center. For services such as labor and/or towing, charges may apply. Refer to the Roadside Assistance manual for more information.

Sign and Drive services (USA only): Services such as a jump start, a few gallons of fuel or the replacement of a flat tire with the vehicle spare wheel are obtainable at no charge.

i If the indicator lamp in Roadside Assistance button ① is flashing continuously and there was no voice connection to the Customer Assistance Center established, then the Tele Aid system could not initiate a Roadside Assistance call (e.g. the relevant cellular phone network is not available). The message *Call Failed* appears in the multifunction display.

- ▶ **Terminating calls:** Press button  on the multifunction steering wheel.

or

- ▶ Press the respective button for ending a telephone call on the COMAND system.

Information button

- ▶ Open the front armrest storage compartment (> page 193).

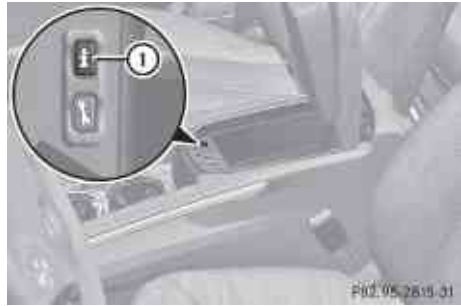

- ▶ Press and hold Information button ① for longer than 2 seconds.

A call to the Customer Assistance Center will be initiated. The indicator lamp in Information button ① will flash while the call is in progress. The message *Connecting Call* will appear in the multifunction display and the COMAND system is muted.

When the connection is established, the message *Call Connected* appears in the multifunction display. The Tele Aid system will transmit data generating the vehicle identification number, model, color and location (subject to availability of cellular and GPS signals).

- i** The COMAND system display indicates that a Tele Aid call is in progress. While the call is connected you can change to the navigation menu by pressing the NAVI button on the COMAND system. Spoken commands are not available.

A voice connection between the Customer Assistance Center representative and the occupants of the vehicle will be established. Information regarding the operation of your vehicle, the nearest authorized Mercedes-Benz Center or Mercedes-Benz USA products and services is available to you.

For more details concerning the Tele Aid system, please visit www.mbusa.com (USA only), log in to “Owner’s Online” and visit the “My Tele Aid” section to learn more.

i If the indicator lamp in Information button  is flashing continuously and there was no voice connection to the Customer Assistance Center established, then the Tele Aid system could not initiate an Information call (e.g. the relevant cellular phone network is not available). The message **Call Failed** appears in the multifunction display.

▶ **Terminating calls:** Press button  on the multifunction steering wheel.

or

▶ Press the respective button for ending a telephone call on the COMAND system.

Call priority

If other service calls such as a Roadside Assistance call or Information call are active, an emergency call is still possible. In this case, the emergency call will take priority and override all other active calls.

The indicator lamp in the respective button flashes until the call is concluded. Automatic initiated emergency calls can only be terminated by a Customer Assistance Center representative. All other calls can be terminated by pressing button  on the multifunction steering wheel or the respective button for ending a telephone call on the COMAND system.

i When a Tele Aid call has been initiated, the COMAND system audio is muted. The mobile phone is no longer connected to the COMAND system. If you must use this phone, we recommend that you use it only with the vehicle at a standstill in a safe location.



Destination Download to the COMAND system

i The components and operating principles of the COMAND system can be found in the separate COMAND system operating instructions.

Destination Download allows you access to a database of over 10 million points of interest (POIs) that can be downloaded to your vehicle's navigation system. If you know the destination, the address can be downloaded, or can be provided with points of interests near your location.

Route guidance

You will be prompted to confirm that route guidance to the entered address is to be started.

▶ Select **Yes** using button  or  on the COMAND system.

▶ Press button  on the COMAND system to confirm.

The system calculates the route and subsequently starts the route guidance to the defined address.

i If you select **No**, you can save the address to your address book.

i The Destination Download feature is available if the relevant mobile phone network is available and data connection is possible.

Search & Send

“Search & Send” is a navigation destination address entry service. For more information on “Search & Send”, refer to separate COMAND system operating instructions.

Remote door unlock

In case you have locked your vehicle unintentionally (e.g. SmartKey inside vehicle), and the reserve SmartKey is not available:

▶ Contact the Customer Assistance Center at 1-800-FOR-MERCEdes (1-800-367-6372) (USA only) or 1-888-923-8367 (Canada only).

You will be asked to provide your password.

▶ Then return to your vehicle at the time arranged and pull the tailgate recessed handle (▷ page 75) for a minimum of

20 seconds until the indicator lamp in the SOS button is flashing.

The message **Connecting Call** appears in the multifunction display.

As an alternative, you may unlock the vehicle via Internet in the “My Tele Aid” section of “Owner’s Online”, using your ID and password (USA only).

- i** The remote door unlock feature is available if the relevant cellular phone network is available.

The SOS button will flash and the message **Call Connected** will appear in the multifunction display to indicate receipt of the door unlock command.

If the tailgate recessed handle was pulled for more than 20 seconds before door unlock authorization was received by the Customer Assistance Center, you must wait 15 minutes before pulling the tailgate recessed handle again.

Stolen Vehicle Recovery Services

In the event your vehicle was stolen:

- ▶ Report the incident to the police.
The police will issue a numbered incident report.
- ▶ Pass this number on to the Customer Assistance Center along with your password.
The Customer Assistance Center will then attempt to covertly contact the vehicle’s Tele Aid system. Once the vehicle is located, the Customer Assistance Center will contact the local law enforcement and you. The vehicle’s location will only be provided to law enforcement.

- i** If the anti-theft alarm stays on for more than 30 seconds, the Tele Aid system will notify the Customer Assistance Center automatically.

Garage door opener

The integrated remote control can operate up to three separately controlled devices compatible with HomeLink® or some other systems.

⚠ Warning!

Before programming the integrated remote control to a garage door opener or gate operator, make sure people and objects are out of the way of the device to prevent potential harm or damage. When programming a garage door opener, the door moves up or down. When programming a gate operator, the gate opens or closes.

Do not use the integrated remote control with any garage door opener that lacks safety stop and reverse features as required by U.S. federal safety standards (this includes any garage door opener model manufactured before April 1, 1982). A garage door that cannot detect an object - signaling the door to stop and reverse - does not meet current U.S. federal safety standards.

When programming a garage door opener, park vehicle outside the garage.

Do not run the engine while programming the integrated remote control. Inhalation of exhaust gas is hazardous to your health. All exhaust gas contains carbon monoxide (CO), and inhaling it can cause unconsciousness and possible death.

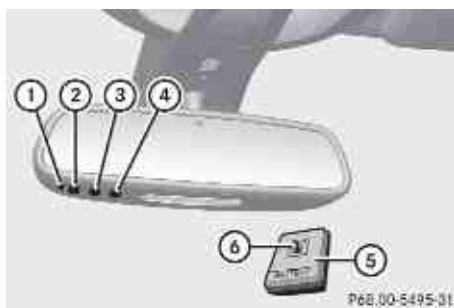

Interior rear view mirror with integrated remote control

Hand-held remote control ⑤ is not part of the vehicle equipment.

Programming the integrated remote control

- ▶ **Step 1:** Switch on the ignition.
- ▶ **Step 2:** If you have previously programmed a signal transmitter button and wish to retain its programming, proceed to step 3.

or

- ▶ If you are programming the integrated remote control for the first time, press and hold the two outer signal transmitter buttons ② and ④ and release them when indicator lamp ① begins to flash after approximately 20 seconds.

Do not hold the buttons for longer than 30 seconds.

This procedure erases any previous settings for all three channels and initializes the memory. If you later wish to program a second and/or third hand-held transmitter to the remaining two signal transmitter buttons, do not repeat this step and begin directly with step 3.

- ▶ **Step 3:** Hold the end of hand-held remote control ⑤ of the device you wish to train approximately 2 to 12 in (5 to 30 cm) away from the signal transmitter button (②, ③ or ④) to be programmed, while keeping indicator lamp ① in view.
- ▶ **Step 4:** Using both hands, simultaneously press hand-held remote control button ⑥ and the desired signal transmitter button (②, ③ or ④). Do not release the buttons until step 5 is completed. Indicator lamp ① will flash, first slowly and then rapidly.

- ❗ Indicator lamp ① flashes immediately the first time the signal transmitter button is programmed. If this button has already been programmed, the indicator lamp will start flashing after 20 seconds.

- ▶ **Step 5:** After indicator lamp ① changes from a slow to a rapidly flashing light, release the hand-held remote control button and the signal transmitter button.
- ▶ **Step 6:** Press and hold the just-trained signal transmitter button (②, ③ or ④) and observe indicator lamp ①. If indicator lamp ① stays on constantly, programming is complete and your device should activate when the respective signal transmitter button (②, ③ or ④) is pressed and released.

- ❗ If indicator lamp ① flashes rapidly for approximately 2 seconds and then turns to a constant light, continue with programming steps 8 through 12 as your garage door opener may be equipped with the “rolling code” feature.

- ▶ **Step 7:** To program the remaining two signal transmitter buttons, repeat the steps above starting with step 3.

Rolling code programming

To train a garage door opener (or other rolling code devices) with the rolling code feature, follow these instructions after completing the “Programming” portion (steps 1 through 6) of this text. For your convenience and to complete the procedure faster, you might want to have someone assist you.

- ▶ **Step 8:** Locate the “training” button on the garage door opener motor head unit.

- ❗ Exact location and color of the button may vary by garage door opener brand. Depending on manufacturer, the “training” button may also be referred to as “learn” or “smart” button. If there is difficulty locating the transmitting button, refer to the garage door opener Operator’s Manual.

- ▶ **Step 9:** Press the “training” button on the garage door opener motor head unit. The “training light” is activated. You have 30 seconds to initiate the following two steps.

- ▶ **Step 10:** Return to the vehicle and firmly press, hold for 2 seconds and release the programmed signal transmitter button (②, ③ or ④).
- ▶ **Step 11:** Press, hold for 2 seconds and release same signal transmitter button a second time to complete the training process.
- ❗ Some garage door openers (or other rolling code equipped devices) may require you to press, hold for 2 seconds and release the same signal transmitter button a third time to complete the training process.
- ▶ **Step 12:** Confirm the garage door operation by pressing the programmed signal transmitter button (②, ③ or ④).
- ▶ **Step 13:** To program the remaining two signal transmitter buttons, repeat the steps above starting with step 3.

Gate operator/Canadian programming

Canadian radio-frequency laws require transmitter signals to “time-out” (or quit) after several seconds of transmission which may not be long enough for the integrated signal transmitter to pick up the signal during programming. Similar to this Canadian law, some U.S. gate operators are designed to “time-out” in the same manner.

If you live in Canada or if you are having difficulties programming a gate operator (regardless of where you live) by using the programming procedures, replace step 4 with the following:

- ▶ **Step 4:** Press and hold the signal transmitter button (②, ③ or ④). Do not release this button until it has been successfully trained.
- ▶ While still holding down the signal transmitter button (②, ③ or ④), “cycle” your hand-held remote control button ⑥ as follows: Press and hold button ⑥ for 2 seconds, then release it for 2 seconds, and again press and hold it for 2 seconds.

Repeat this sequence on the hand-held remote control until the frequency signal has been learned.

Upon successful training, indicator lamp ① will flash slowly and then rapidly after several seconds.

- ▶ Proceed with programming step 5 and step 6 to complete.

- ❗ Upon completion of programming the integrated remote control, make sure you retain the hand-held remote control that came with the garage door opener, gate operator or other device. You may need it for use in other vehicles, for future programming of an integrated remote control, or simply for continued use as a hand-held remote control to operate the respective device in other situations.

Reprogramming a single signal transmitter button

To program a device using a signal transmitter button previously trained, follow these steps:

- ▶ Switch on the ignition.
- ▶ Press and hold the desired signal transmitter button (②, ③ or ④). Do not release the button. Indicator lamp ① will begin to flash after 20 seconds.
- ▶ Without releasing the signal transmitter button, proceed with programming starting with step 3.

Operation of integrated remote control

- ▶ Switch on the ignition.
- ▶ Select and press the appropriate integrated signal transmitter button (②, ③ or ④) to activate the remote controlled device.

The integrated remote control transmitter continues to send the signal as long as the button is pressed – up to 20 seconds.

Erasing the integrated remote control memory

- i** If you sell your vehicle, erase the codes of all three channels.
- ▶ Switch on the ignition.
- ▶ Simultaneously press and hold outer signal transmitter buttons ② and ④, for approximately 20 seconds, until indicator lamp ① flashes rapidly. Do not hold for longer than 30 seconds.
The codes of all three channels are erased.

Programming tips

If you are having difficulty programming the integrated remote control, here are some helpful tips:

- Check the frequency of hand-held remote control ⑤ (typically located on the reverse side of the remote). The integrated remote control is compatible with radio-frequency devices operating between 280-390 MHz.
- Put a new battery in hand-held remote control ⑤. This will increase the likelihood of the hand-held remote control sending a stronger and more accurate signal to the integrated remote control.
- While performing step 3, hold hand-held remote control ⑤ at different lengths and angles from the signal transmitter button (②, ③ or ④) you are programming. Attempt varying angles at the distance of 2 to 12 inches (5 to 30 cm) away or the same angle at varying distances.
- If another hand-held remote control is available for the same device, try the programming steps again using that other hand-held remote control. Make sure new batteries are in the hand-held remote control before beginning the procedure.
- Straighten the antenna wire from the garage door opener assembly. This may help improve transmitting and/or receiving signals.

- i** Certain types of garage door openers are incompatible with the integrated remote control. If you should experience further difficulties with programming the integrated remote control, contact an authorized Mercedes-Benz Center, or call the Mercedes-Benz Customer Assistance Center (USA only) at 1-800-FOR-MERCEdes (1-800-367-6372), or the HomeLink® Hotline (USA only) at 1-800-355-3515, or the Customer Service (Canada only) at 1-800-387-0100.



- i** USA only:
This device complies with Part 15 of the FCC Rules. Operation is subject to the following two conditions:
 1. This device may not cause harmful interference, and
 2. this device must accept any interference received, including interference that may cause undesired operation.

Any unauthorized modification to this device could void the user's authority to operate the equipment.

- i** Canada only:
This device complies with RSS-210 of Industry Canada. Operation is subject to the following two conditions:
 1. This device may not cause interference, and
 2. this device must accept any interference received, including interference that may cause undesired operation of the device.

Any unauthorized modification to this device could void the user's authority to operate the equipment.

Compass

- ▶ **Calling up the compass:** Press button  or  on the multifunction steering

wheel repeatedly until the AIRMATIC/Compass menu appears in the multifunction display.

The compass displays the direction into which the vehicle is currently traveling: N, NE, E, SE, S, SW, W, or NW.



- i** If your vehicle is not equipped with air suspension program, the multifunction display will show the compass only.

Floormats

Warning!

Whenever you are using floormats, make sure there is enough clearance and that the floormats are securely fastened.

Floormats should always be securely fastened using the fastening equipment.

Before driving off, check that the floormats are securely in place and adjust them if necessary. A loose floormat could slip and hinder proper functioning of the pedals.

Do not place several floormats on top of each other as this may impair pedal movement.

- Move the driver's seat or front passenger seat as far to the rear as possible.

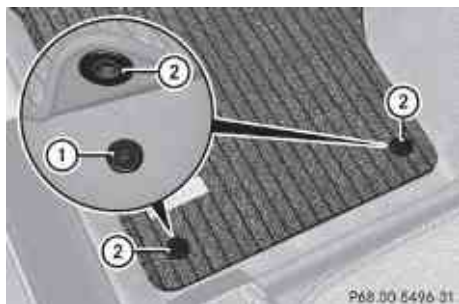

- **Removing:** Pull floormat off of retainer pins ①.

- **Installing:** Press floormat eyelets ② onto retainer pins ①.

Infrared reflecting windshield

Infrared reflecting glass reduces the amount of radiated heat entering the vehicle interior through the windows.

The infrared reflecting glass also prevents the transmission of signals through the glass by in-vehicle electronic devices, e.g. electronic toll collection devices.

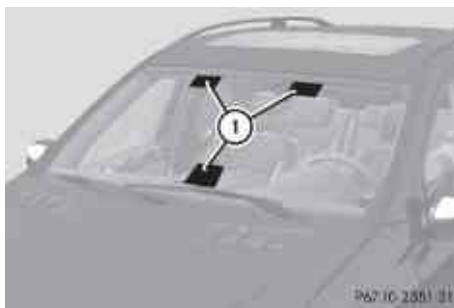

To allow the use of these devices in the vehicle, infrared transparent areas ① are placed in the windshield.

Vehicle equipment	210
The first 1000 miles (1500 km)	210
At the gas station	210
Engine compartment	212
Tires and wheels	218
Winter driving	242
Driving instructions	244
Maintenance	258
Vehicle care	260



Vehicle equipment

- i** This Operator's Manual describes all features, standard or optional, potentially available for your vehicle at the time of purchase. Please be aware that your vehicle might not be equipped with all features described in this manual.

The first 1000 miles (1500 km)

The more cautiously you treat your vehicle during the break-in period, the more satisfied you will be with its performance later on.

- Drive your vehicle during the first 1 000 miles (1 500 km) at varying but moderate vehicle and engine speeds.
- During this period, avoid heavy loads (full throttle driving) and excessive engine speeds (no more than $\frac{2}{3}$ of maximum rpm in each gear).
- Avoid accelerating by kickdown.
- Do not attempt to slow the vehicle down by shifting to a lower gear using the gear selector lever.
- Select gear ranges **3**, **2** or **1** (▷ page 113) only when driving at moderate speeds (for hill driving).

After 1 000 miles (1 500 km) you may gradually increase vehicle and engine speeds to the permissible maximum.

- !** Additional instructions for ML 63 AMG:
 - During the first 1 000 miles (1 500 km), do not exceed a speed of 85 mph (140 km/h).
 - During this period, avoid engine speeds above 4 500 rpm in each gear.
 - Shift gears in a timely manner.
 - Select **C** as the preferred shift program for the first 1 000 miles (1 500 km).

All of the above instructions, as may apply to your vehicle type, also apply when driving the

first 1 000 miles (1 500 km) after the engine, the transfer case, the front differential or the rear differential have been replaced.

- i** Always obey applicable speed limits.

At the gas station

Refueling

Warning!

Gasoline and diesel fuels are highly flammable and poisonous. They burn violently and can cause serious injury.

Never allow sparks, flames or smoking materials near gasoline or diesel fuel!

Turn off the engine before refueling.

Whenever you are around gasoline or diesel fuel, avoid inhaling fumes and any skin or clothing contact. Extinguish all smoking materials.

Direct skin contact with fuels and the inhalation of fuel vapors are damaging your health.

Warning!

Overfilling of the fuel tank may create pressure in the system which could cause a gas discharge. This could cause the gas to spray back out when removing the fuel pump nozzle, which could cause personal injury.

Warning!

Do not fill diesel tanks with gasoline. Do not mix diesel fuel with gasoline. Otherwise the fuel system and engine could be damaged. In addition, the vehicle could catch fire.

Warning!

HYBRID vehicles: It is imperative that you read the HYBRID Supplemental Operating Instructions included in your vehicle literature portfolio. You may otherwise not receive all necessary safety information and warning for the operation of your vehicle.

! Never refuel vehicles with gasoline engine with diesel fuel. Never refuel vehicles with diesel engine with gasoline. Even small amounts of incorrect fuel will damage the fuel system and engine. Damage resulting from the use of non-approved fuels or fuel additives or resulting from mixing gasoline with diesel fuel or vice versa is not covered by the Mercedes-Benz Limited Warranty.

! If you have accidentally filled the tank with incorrect or non-approved fuel, do not switch on the ignition. Otherwise the incorrect or non-approved fuel will get into the fuel lines. The fuel system must be drained completely. Contact an authorized Mercedes-Benz Center to have the fuel system drained completely.

! Gasoline engine:

To prevent damage to the catalytic converters, only use premium unleaded gasoline in this vehicle.

Any noticeable irregularities in engine operation should be repaired promptly. Otherwise, excessive unburned fuel may reach the catalytic converter, causing it to overheat and potentially start a fire.

! Diesel engine:

When filling the diesel fuel tank using fuel containers, place a filling filter, a suede cloth or a clean flannel cloth as a filter. Otherwise, particles from the fuel container could clog the fuel lines and/or the diesel injection system.

! Diesel engine:

The engine is more susceptible to wear and damage if you use

- marine diesel fuel
- heating oil
- additives

The exhaust aftertreatment device will be seriously damaged if you use any other diesel fuel than ULTRA-LOW SULFUR

HIGHWAY DIESEL FUEL (ULSD, 15 ppm SULFUR MAXIMUM).

The use of such non-approved fuels and/or special additives is not covered by the Mercedes-Benz Limited Warranty.

i Gasoline engine:

Only use premium unleaded gasoline with a minimum Posted Octane Rating of 91 (average of 96 RON/86 MON).

Information on gasoline quality can normally be found on the fuel pump. Please contact gas station personnel in case labels on the pump cannot be found.

For more information on gasoline, see “Premium unleaded gasoline (gasoline engine)” (▷ page 360), see “Fuel requirements” (▷ page 360), or contact an authorized Mercedes-Benz Center, or visit www.mbusa.com (USA only).

i Diesel engine:

Only use commercially available vehicular ULTRA-LOW SULFUR HIGHWAY DIESEL FUEL (ULSD, 15 ppm SULFUR MAXIMUM). Information on diesel quality can normally be found on the fuel pump. Please contact gas station personnel in case labels on the pump cannot be found.

For more information on diesel fuels, see “Fuel requirements” (▷ page 360), or contact an authorized Mercedes-Benz Center, or visit www.mbusa.com (USA only).

i Diesel engine:

If you have driven the vehicle until the tank is empty, the fuel system needs to be bled (▷ page 331).

Locking/unlocking the vehicle with the SmartKey or KEYLESS-GO automatically locks/unlocks the fuel filler flap.

i In case the central locking system does not release the fuel filler flap, see “Fuel filler flap” (▷ page 308).

The fuel filler flap is located on the right-hand side of the vehicle towards the rear.

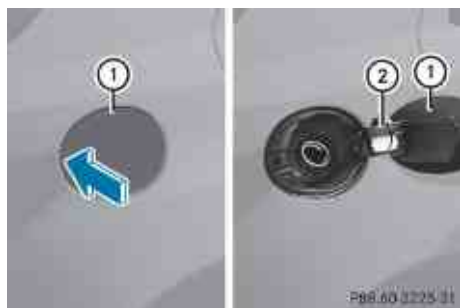

► Turn off the engine.

i Leaving the engine running and the fuel filler cap open can cause the yellow fuel tank reserve warning lamp to flash and the malfunction indicator lamp **CHECK ENGINE** (USA only) or  (Canada only) to illuminate. For more information, see also “Practical hints” (▷ page 303).

► Remove the SmartKey from the starter switch.

KEYLESS-GO: Open the driver’s door. This puts the starter switch in position **0**, same as with the SmartKey removed from the starter switch. The driver’s door then can be closed again.

► **Opening:** Press fuel filler flap ① at the point indicated by the arrow.

► Turn fuel filler cap ② counterclockwise.

► Take off fuel filler cap ②.

! The fuel filler cap is tethered to the fuel filler neck. Do not drop the cap. It could damage the vehicle paint finish.

► Set fuel filler cap ② on fuel filler flap ①.

► Fully insert filler nozzle unit and refuel.

► Only fill your tank until the filler nozzle unit cuts out – **do not top off or overfill.**

► **Closing:** Turn fuel filler cap ② clockwise until it audibly engages.

i Close the fuel filler flap before locking the vehicle. Otherwise the flap locking pin will prevent closing the fuel filler flap.

► Close fuel filler flap ①.

Low outside temperatures (diesel engine)

! Do not fill the tank with gasoline. Do not blend diesel fuel with gasoline or kerosene. The fuel system and engine will otherwise be damaged, which is not covered by the Mercedes-Benz Limited Warranty.

To prevent malfunctions, diesel fuel with improved cold flow characteristics is offered in the winter months. Check with your fuel retailer.

Check regularly and before a long trip

For information on quantities and requirements of operating agents, see “Fuels, coolants, lubricants, etc.” (▷ page 356).

Check the following:

- Engine oil level (▷ page 214)
- Tire inflation pressure (▷ page 221)
- Coolant level (▷ page 216)
- Vehicle lighting (▷ page 311)
- Washer system and headlamp cleaning system (▷ page 217)
- Brake fluid (▷ page 217)

Engine compartment

Hood

Warning!

Do not pull the release lever while the vehicle is in motion. Otherwise the hood could be forced open by passing air flow.

This could cause the hood to come loose and injure you and/or others.

Warning!

HYBRID vehicles: It is imperative that you read the HYBRID Supplemental Operating Instructions included in your vehicle literature portfolio. You may otherwise not receive all necessary safety information and warning for the operation of your vehicle.

Opening

Warning!

Do not open the hood when the engine is overheated. You could be seriously injured. Observe the coolant temperature display to determine whether the engine may be overheated. If you see flames or smoke coming from the engine compartment, move away from the vehicle. Wait until the engine has cooled. If necessary, call the fire department.

Warning!

You could be injured when the hood is open – even when the engine is turned off.

Parts of the engine can become very hot. To prevent burns, let the engine cool completely before touching any components on the vehicle. Comply with all relevant safety precautions.

Warning!

To help prevent personal injury, stay clear of moving parts when the hood is open and the engine is running.

The radiator fan may continue to run for approximately 30 seconds or may even restart after the engine has been turned off. Stay clear of fan blades.

Warning!

Vehicles with gasoline engine:
The engine is equipped with a transistorized ignition system. Because of the high voltage it is dangerous to touch any components (ignition coils, spark plug sockets, diagnostic socket) of the ignition system

- with the engine running
- while starting the engine
- when the ignition is switched on and the engine is turned manually

Warning!

Vehicles with diesel engine:
The engine is equipped with a high-voltage electronic control unit for the injection system. Because of the high voltage it is dangerous to touch any components of the injection system (injectors, electrical wires)

- with the engine running
- while starting the engine
- when the ignition is switched on



- ▶ Pull hood lock release lever ①.
The hood is unlocked.

- ❗ Never open the hood if the wiper arms are folded forward away from the windshield. Otherwise the windshield wipers or the hood could be damaged.



- ▶ Press and hold handle ②.
The hood is unlocked.
- ▶ Pull up on the hood in direction of arrow and then release it.
The hood will be held open at shoulder height by gas-filled struts automatically.

Closing

Warning!

When closing the hood, use extreme caution not to catch hands or fingers. Be careful that you do not close the hood on anyone.

Make sure the hood is securely engaged before driving off. Do not continue driving if the hood can no longer engage after an accident, for example. The hood could otherwise come loose while the vehicle is in motion and injure you and/or others.

- ▶ Let the hood drop from a height of approximately 8 in (20 cm).
- ▶ Check to make sure the hood is fully closed.
If you can raise the hood at a point above the headlamps, then it is not properly closed. Open it again and let it drop with somewhat greater force.

Radiator

-  Vehicles with diesel engine:
Do not cover the radiator, for example with a winter front or bug cover. Otherwise the readings of the on-board diagnostic system

may be inaccurate. Some of these readings are required by law and must be accurate at all times.

Engine oil

Warning!

HYBRID vehicles: It is imperative that you read the HYBRID Supplemental Operating Instructions included in your vehicle literature portfolio. You may otherwise not receive all necessary safety information and warning for the operation of your vehicle.

The amount of oil your engine consumes will depend on a number of factors, including driving style. Increased oil consumption can occur when the vehicle is new or the vehicle is driven frequently at higher engine speeds. Engine oil consumption checks should only be made after the vehicle break-in period.

-  Do not use any special lubricant additives, as these may damage the drive assemblies. Using special additives not approved by Mercedes-Benz may cause damage not covered by the Mercedes-Benz Limited Warranty.

For further information contact an authorized Mercedes-Benz Center.

Notes on checking engine oil level

When checking the oil level the vehicle must be parked on level ground and the vehicle must have been stationary for at least 5 minutes with the engine turned off.

Checking engine oil level

- ▶ Open the hood (▷ page 213).



Example illustration: Gasoline engine

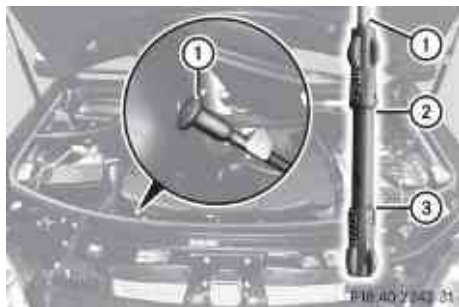

Example illustration: Diesel engine

- ▶ Pull out oil dipstick ①.
- ▶ Wipe oil dipstick ① clean.
- ▶ Slowly insert oil dipstick ① fully into the dipstick guide tube.
- ▶ Pull out oil dipstick ① again after approximately 3 seconds to obtain accurate reading.
The oil level is correct when it is between lower (min) mark ③ and upper (max) mark ② of oil dipstick ①.

- i** All models (except ML 63 AMG):
The filling quantity between the upper and lower marks on the oil dipstick is approximately 2.1 US qt. (2.0 l).

ML 63 AMG:
The filling quantity between the upper and lower marks on the oil dipstick is approximately 1.6 US qt. (1.5 l).

- ▶ If necessary, add engine oil.

For more information on engine oil, see “Fuels, coolants, lubricants etc.”

(▷ page 356).

For information on messages in the multifunction display concerning engine oil, see the “Practical hints” section

(▷ page 291).

Adding engine oil

! Only use approved engine oils and oil filters required for vehicles with Maintenance System. For a listing of approved engine oils and oil filters, contact an authorized Mercedes-Benz Center or visit www.mbusa.com (USA only).

The following will result in engine or emission control system damage not covered by the Mercedes-Benz Limited Warranty:

- Using engine oils and oil filters of specification other than those expressly required for the Maintenance System.
- Changing of oil and oil filter at change intervals longer than those called for by the Maintenance System.
- Using any oil additives.



Example illustration: ML 350 BlueTEC (ML 350, ML 550 similar)



ML 63 AMG

- ▶ Unscrew filler cap ① from filler neck.
- ▶ Add engine oil as required. Be careful not to overfill with oil.

Be careful not to spill any oil when adding. Avoid environmental damage caused by oil entering the ground or water.

! Excess oil must be siphoned or drained off. It could cause damage to the engine and emission control system not covered by the Mercedes-Benz Limited Warranty.

- ▶ Screw filler cap ① back on filler neck.

For more information on engine oil, see the “Technical data” section (▶ page 356) and (▶ page 359).

Transmission fluid level

The transmission fluid level does not need to be checked. If you notice transmission fluid loss or gearshifting malfunctions, have an authorized Mercedes-Benz Center check the transmission.

Coolant level

The engine coolant is a mixture of water and anticorrosion/antifreeze.

When checking the coolant level, the vehicle must be parked on level ground, and the coolant temperature must be below 158°F (70°C).

⚠ Warning!

In order to avoid any potentially serious burns:

- Use extreme caution when opening the hood if there are any signs of steam or coolant leaking from the cooling system, or if the coolant temperature display indicates that the coolant is overheated.
- Do not remove the cap on the coolant expansion tank if the coolant temperature is above 158°F (70°C). Allow the engine to cool down before removing the cap. The coolant expansion tank contains hot fluid and is under pressure.
- Using a rag, slowly open the cap approximately $1/2$ turn to relieve excess pressure. If opened immediately, scalding hot fluid and steam will be blown out under pressure.
- Do not spill antifreeze on hot engine parts. Antifreeze contains ethylene glycol which may burn if it comes into contact with hot engine parts.



- ▶ Using a rag, slowly open cap ② approximately $1/2$ turn to relieve excess pressure.
- ▶ Continue turning cap ② counterclockwise and remove it.

The coolant level is correct if the level

- for cold coolant: reaches marking bar ① in coolant expansion tank ③
- for warm coolant: is approximately 0.6 in (1.5 cm) higher

- ▶ Add coolant as required.
- ▶ Screw cap ② back on and tighten it.

For more information on coolant, see the “Technical data” section (▷ page 358) and (▷ page 362).

Washer system and headlamp cleaning system

Warning!

Washer solvent/antifreeze is highly flammable. Do not spill washer solvent/antifreeze on hot engine parts, because it may ignite and burn. You could be seriously burned.

! Always use washer solvent/antifreeze where temperatures may fall below freezing point. Failure to do so could result in damage to the washer system/fluid reservoir.

! Only use washer fluid which is suitable for plastic lenses. Improper washer fluid can damage the plastic lenses of the headlamps.

! Do not use distilled or deionized water in the washer fluid reservoir. Otherwise, the washer fluid level sensor could be damaged.



Fluid for the washer system, rear window washer system, and the headlamp cleaning system is supplied from the washer fluid reservoir.

During all seasons, use MB Windshield Washer Concentrate “MB SummerFit”. Mix it with water or premixed washer solvent/antifreeze depending on the ambient temperature (▷ page 364).

- ▶ **Opening washer fluid reservoir:** Pull tab of cap ① upwards.
- ▶ Refill the washer fluid reservoir.
- ▶ **Closing washer fluid reservoir:** Press cap ① onto filler hole until it engages.

For more information, see “Washer system and headlamp cleaning system” (▷ page 358).

Brake fluid level

! If you find that the brake fluid in the brake fluid reservoir has fallen to the minimum mark or below, have the brake system checked for brake pad thickness and leaks immediately. Contact an authorized Mercedes-Benz Center immediately. Do not add brake fluid as this will not solve the problem. For more information, see “Practical hints”.

When checking the brake fluid level, the vehicle must be parked on level ground.

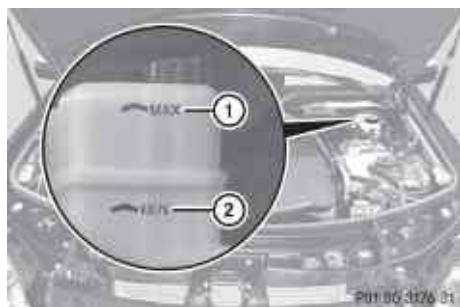

The brake fluid level is correct when it is between lower mark (MIN) ② and upper mark (MAX) ① of the brake fluid reservoir.

Tires and wheels

Safety notes

Contact an authorized Mercedes-Benz Center for information on tested and recommended rims and tires for summer and winter operation. They can also offer advice concerning tire service and purchase.

Warning!

Replace rims or tires with the same designation, manufacturer and type as shown on the original part. For further information contact an authorized Mercedes-Benz Center. If incorrectly sized rims and tires are mounted, the wheel brakes or suspension components can be damaged. Also, the operating clearance of the wheels and the tires may no longer be correct.

Warning!

Worn, old tires can cause accidents. If the tire tread is worn to minimum tread depth, or if the tires have sustained damage, replace them.

When replacing rims, only use genuine Mercedes-Benz wheel bolts specified for the particular rim type. Failure to do so can result in the bolts loosening and possibly an accident.

Retreaded tires are not tested or recommended by Mercedes-Benz, since previous damage cannot always be recognized on retreads. The operating safety of the vehicle cannot be assured when such tires are used.

Warning!

If you feel a sudden significant vibration or ride disturbance, or you suspect that possible damage to your vehicle has occurred, you should turn on the hazard warning flashers, carefully slow down, and drive with caution to an area which is a safe distance from the road.

Inspect the tires and the vehicle underbody for possible damage. If the vehicle or tires appear unsafe, have the vehicle towed to the nearest authorized Mercedes-Benz Center or tire dealer for repairs.

Warning!

Do not drive with a flat tire. A flat tire affects the ability to steer or brake the vehicle. You could lose control of the vehicle. Continued driving with a flat tire or driving at high speed with a flat tire will cause excessive heat build-up and possibly a fire.

Important guidelines

- Only use sets of tires and rims of the same type and make.
- Tires must be of the correct size for the rim.
- Break in new tires for approximately 60 miles (100 km) at moderate speeds.
- Regularly check the tires and rims for damage. Dented or bent rims can cause tire inflation pressure loss and damage to the tire beads.
- If the vehicle is heavily loaded, check tire inflation pressure and correct as required.
- Do not allow your tires to wear down too far. Adhesion properties on wet roads are

sharply reduced at tread depths of less than $\frac{1}{8}$ in (3 mm).

- When replacing individual tires, you should mount new tires on the front wheels first (on vehicles with same-sized wheels all around).

Recommended tire inflation pressure

Warning!

Follow recommended tire inflation pressures.

Do not underinflate tires. Underinflated tires wear excessively and/or unevenly, adversely affect handling and fuel economy, and are more likely to fail from being overheated.

Do not overinflate tires. Overinflated tires can adversely affect handling and ride comfort, wear unevenly, increase stopping distance, and result in sudden deflation (blowout) because they are more likely to become punctured or damaged by road debris, potholes etc.

Do not overload the tires by exceeding the specified load limit as indicated on the Tire and Loading Information placard on the driver's door B-pillar. Overloading the tires can overheat them, possibly causing a blowout. Overloading the tires can also result in handling or steering problems, or brake failure.

Your vehicle is equipped with the Tire and Loading Information placard located on the driver's door B-pillar (> page 227).

The tire inflation pressure should be checked regularly. Only adjust the tire inflation pressure on cold tires. The tires can be considered cold if the vehicle has been parked for at least 3 hours or driven less than 1 mile (1.6 km). Depending on the ambient temperature, the driving speed and the tire load, the tire temperature changes. When the tire temperature changes by 18°F (10°C), the tire inflation pressure will change by approximately 1.5 psi (0.1 bar). Keep this in mind when checking tire inflation pressure on

warm tires and adjust the tire pressure only if the tire inflation pressure is too low for the current operating conditions. If you check the tire inflation pressure when the tires are warm, the reading will be higher than the cold reading. This is normal. Do not let air out to match the specified cold tire inflation pressure. Otherwise, the tire will be underinflated.

Follow recommended cold tire inflation pressures listed on Tire and Loading Information placard on the driver's door B-pillar.

Keeping the tires properly inflated provides the best handling, tread life and riding comfort.

In addition to the Tire and Loading Information placard on the driver's door B-pillar, also consult the tire inflation pressure label on the inside of the filler flap for any additional information pertaining to special driving situations. For more information, see "Important notes on tire inflation pressure" (> page 220).

- i** Data shown on Tire and Loading Information placard example are for illustration purposes only. Tire data are specific to each vehicle and may vary from data shown in the following illustration. Refer to Tire and Loading Information placard on vehicle for actual data specific to your vehicle.

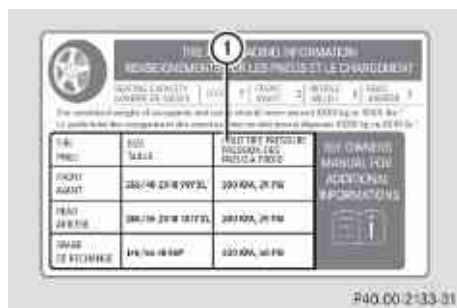

The Tire and Loading Information placard lists the recommended cold tire inflation

pressures ① for maximum loaded vehicle weight. The tire inflation pressures listed apply to the tires installed as original equipment.

Important notes on tire inflation pressure

⚠ Warning!

If the tire inflation pressure drops repeatedly, check the tires for punctures from foreign objects and/or whether air is leaking from the valves or from around the rim.

Tire temperature and tire inflation pressure are also increased while driving, depending on the driving speed and the tire load.

If you will be driving your vehicle at high speeds of 100 mph (160 km/h) or higher, where it is legal and conditions allow, consult the tire inflation pressure label on the inside of the fuel filler flap on how to adjust the cold tire inflation pressure. If you do not adjust the tire inflation pressure, excessive heat can build up and result in sudden tire failure.

If you are not sure about the proper tire inflation pressure, contact an authorized Mercedes-Benz Center.

- ① Driving comfort may be reduced when the tire inflation pressure is adjusted to the value for speeds above 100 mph (160 km/h) as specified on the tire inflation pressure label located on the inside of the fuel filler flap.

Make sure to readjust the tire inflation pressure for normal driving speeds. Supplemental tire inflation pressure information for different loading conditions of the vehicle can be found on the tire inflation pressure label. The tire inflation pressure label is located on the inside of the fuel filler flap.

For the tire inflation pressure for spare wheels such as Minispare wheels or spare wheels with collapsible tire refer to

- the yellow label on the spare wheel rim
- the “Technical data” section of this Operator’s Manual (▷ page 356)
- the Tire and Loading Information placard on the driver’s door B-pillar

Unless specified otherwise, the tire inflation pressures on the tire inflation pressure label are valid for all approved, factory-equipped tires.

- ① Data shown on tire inflation pressure label examples are for illustration purposes only. Tire inflation pressure data are specific to each vehicle and may vary from data shown in the following illustrations. Refer to the tire inflation pressure label on vehicle for actual data specific to your vehicle.

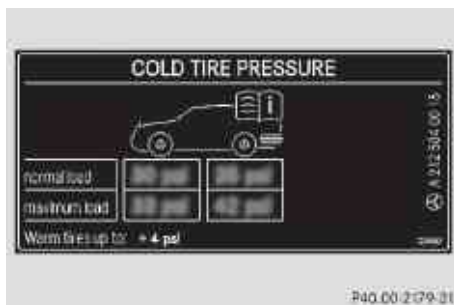

Example illustration: Tire inflation pressures for all approved, factory equipped tires

When a tire size is specified, the tire inflation pressure that follows applies to that particular tire size only.



Example illustration: Tire inflation pressures for particular tire sizes

Some tire inflation pressure labels may only show the rim diameter instead of the entire tire size, e.g. **R 18** or **18"**.

The rim diameter is part of the tire size as specified on the tire sidewall (> page 236).

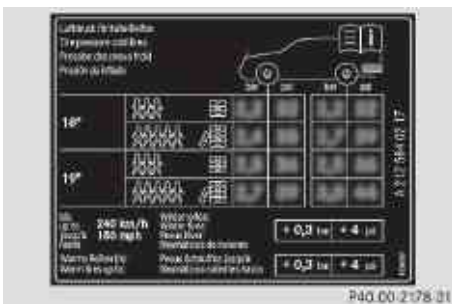

Example illustration: Tire inflation pressures specific to rim diameter

- i** When towing a trailer, inflate the tires to the tire inflation pressure as specified for a fully loaded vehicle.

Potential problems associated with underinflated and overinflated tires

Underinflated tires

Warning!

Follow recommended tire inflation pressures. Do not underinflate tires. Underinflated tires wear excessively and/or unevenly, adversely affect handling and fuel economy, and are more likely to fail from being overheated.

Underinflated tires can

- cause excessive and uneven tire wear
- adversely affect fuel economy
- lead to tire failure from being overheated
- adversely affect handling characteristics

Overinflated tires

Warning!

Follow recommended tire inflation pressures. Do not overinflate tires. Overinflated tires can adversely affect handling and ride comfort, wear unevenly, increase stopping distance, and result in sudden deflation (blowout) because they are more likely to become punctured or damaged by road debris, potholes etc.

Overinflated tires can

- adversely affect handling characteristics
- cause uneven tire wear
- be more prone to damage from road hazards
- adversely affect ride comfort
- increase stopping distance

Checking tire inflation pressure

Safety notes

Warning!

Follow recommended tire inflation pressures. Do not underinflate tires. Underinflated tires wear excessively and/or unevenly, adversely affect handling and fuel economy, and are more likely to fail from being overheated. Do not overinflate tires. Overinflated tires can adversely affect handling and ride comfort, wear unevenly, increase stopping distance, and result in sudden deflation (blowout) because they are more likely to become punctured or damaged by road debris, potholes etc.

Do not overload the tires by exceeding the specified load limit as indicated on the Tire and Loading Information placard on the driver's door B-pillar. Overloading the tires can overheat them, possibly causing a blowout. Overloading the tires can also result in handling or steering problems, or brake failure.

Check the tire inflation pressure at least once a month.

Check and adjust the tire inflation pressure when the tires are cold (▷ page 219).

Checking tire inflation pressure manually

Follow the steps below to achieve correct tire inflation pressure:

- ▶ Remove the cap from the valve on one tire.
- ▶ Firmly press a tire gauge onto the valve.
- ▶ Read the tire inflation pressure on the tire gauge and check against the recommended tire inflation pressure on the Tire and Loading Information placard on the driver's door B-pillar (▷ page 227). If necessary, add air to achieve the recommended tire inflation pressure.
- ▶ If you have overfilled the tire, release tire inflation pressure by pushing the metal stem of the valve with e.g. a tip of a pen. Then recheck the tire inflation pressure with the tire gauge.
- ▶ Install the valve cap.
- ▶ Repeat this procedure for each tire.

Tire pressure loss warning system (Canada only)

While the vehicle is being driven, the tire pressure loss warning system monitors the set tire inflation pressures by evaluating each wheel's rotational speed. This allows the system to detect a significant loss of pressure in a tire. If a wheel's rotational speed changes due to falling tire inflation pressure, you will

see a corresponding warning message in the multifunction display.

The tire pressure loss warning system may function in a restricted manner or with a delay

- when snow chains are mounted to the vehicle
- in the presence of ice and snow
- when you are driving on a loose surface (e.g. sand or gravel)
- when you are driving in a very sporty manner (involving rapid acceleration or high speeds in curves)

Warning!

When the multifunction display shows the message **Tire Pressure Check Tires**, one or more of your tires are significantly underinflated. You should stop and check your tires as soon as possible, and inflate them to the proper tire inflation pressure as indicated on the vehicle's Tire and Loading Information placard or on the tire inflation pressure label.

Driving on a significantly underinflated tire causes the tire to overheat and can lead to tire failure. Underinflation also reduces fuel efficiency and tire tread life, and may affect the vehicle's handling and stopping ability.

Each tire, including the spare, should be checked at least once a month when cold. Inflate the tires to the recommended tire inflation pressure as specified on

- the Tire and Loading Information placard on the driver's door B-pillar
- or
- the tire inflation pressure label located on the inside of the fuel filler flap

i The recommended tire inflation pressures for your vehicle can be found on

- the Tire and Loading Information placard located on the driver's door B-pillar (▷ page 227)
- the tire inflation pressure label on the inside of the fuel filler flap

The tire inflation pressures are not listed in the Operator's Manual.

Warning!

The tire pressure loss warning system does not provide a warning for wrongly selected tire inflation pressures. Always adjust tire inflation pressure according to the Tire and Loading Information placard on the driver's door B-pillar or on the tire inflation pressure label located on the inside of the fuel filler flap.

The tire pressure loss warning system does not replace regular checks of the tire inflation pressures since a gradual pressure loss in more than one tire cannot be detected by the tire pressure loss warning system.

The tire pressure loss warning system is not able to issue a warning due to a sudden dramatic loss of tire inflation pressure (e.g. tire blowout caused by a foreign object). In this case bring the vehicle to a halt by carefully applying the brakes and avoiding abrupt steering maneuvers.

Restarting the tire pressure loss warning system





The tire pressure loss warning system must be restarted in the following situations:

- after you have changed the tire inflation pressure
 - after you have replaced the wheels or tires
 - after you have installed new wheels or tires
- Using the Tire and Loading Information placard on the driver's door B-pillar or, if available, the tire inflation pressure label on the inside of the fuel filler flap, make sure the tire inflation pressure of all four tires is correct.

Warning!

The tire pressure loss warning system can only warn you in a reliable manner if you have set the correct tire inflation pressures for each tire.

If an incorrect tire inflation pressure was set, the system will monitor the pressure according to the incorrect value.

- Switch on the ignition.
- Make sure the standard display appears in the multifunction display (▷ page 122).
- Press button  or  on the multifunction steering wheel repeatedly until the following message appears in the multifunction display:
Run Flat Indicator
Active
Menu: R-Button
- Press the reset button (▷ page 118).
The following message will appear in the multifunction display:
Restart
Run Flat Indicator?
- **If you wish to confirm:** Press button .
The following message will appear in the multifunction display:
Run Flat Indicator
Restarted
After a certain "learning phase", the tire pressure loss warning system checks the set pressure values for all four tires.
- **If you wish to cancel:** Press button .

Advanced Tire Pressure Monitoring System (Advanced TPMS), (USA only)

Your vehicle is equipped with the Advanced Tire Pressure Monitoring System (Advanced TPMS). It measures the tire inflation pressure in the vehicle's tires and issues warnings in case of pressure loss in one or more of the tires.

The TPMS is equipped with a combination low tire pressure/ TPMS malfunction telltale in the instrument cluster. Depending on how the telltale illuminates, it indicates a low tire pressure condition or a malfunction in the TPMS system itself:

- If the telltale illuminates continuously, one or more of your tires is significantly underinflated. There is no malfunction in the TPMS.
- If the telltale flashes for 60 seconds and then stays illuminated, the TPMS system itself is not operating properly.

The TPMS only functions on wheels that are equipped with the proper electronic sensors.

Warning!

The TPMS does not indicate a warning for wrongly selected inflation pressures. Always adjust tire inflation pressure according to the Tire and Loading Information placard or the supplemental tire inflation pressure information on the inside of the fuel filler flap.

The TPMS is not able to issue a warning due to a sudden dramatic loss of pressure (e.g. tire blowout caused by a foreign object). In this case bring the vehicle to a halt by carefully applying the brakes and avoiding abrupt steering maneuvers.

Warning!

Each tire, including the spare (if provided), should be checked at least once a month when cold and inflated to the inflation pressure recommended by the vehicle manufacturer on the Tire and Loading Information placard on the driver's door B-pillar or the tire inflation pressure label on the inside of the fuel filler flap. If your vehicle has tires of a different size than the size indicated on the Tire and Loading Information placard or the tire inflation pressure label, you should determine the proper tire inflation pressure for those tires.

As an added safety feature, your vehicle has been equipped with a tire pressure monitoring

system (TPMS) that illuminates a low tire pressure telltale when one or more of your tires are significantly underinflated. Accordingly, when the low tire pressure telltale illuminates, you should stop and check your tires as soon as possible, and inflate them to the proper pressure. Driving on a significantly underinflated tire causes the tire to overheat and can lead to tire failure.

Underinflation also reduces fuel efficiency and tire tread life, and may affect the vehicle's handling and stopping ability. Please note that the TPMS is not a substitute for proper tire maintenance, and it is the driver's responsibility to maintain correct tire pressure, even if underinflation has not reached the level to trigger illumination of the TPMS low tire pressure telltale.

Your vehicle has also been equipped with a TPMS malfunction indicator to indicate when the system is not operating properly. The TPMS malfunction indicator is combined with the low tire pressure telltale. When the system detects a malfunction, the telltale will flash for approximately 1 minute and then remain continuously illuminated. This sequence will continue upon subsequent vehicle start-ups as long as the malfunction exists. When the malfunction indicator is illuminated, the system may not be able to detect or signal low tire pressure as intended.

TPMS malfunctions may occur for a variety of reasons, including the installation of incompatible replacement or alternate tires or wheels on the vehicle that prevent the TPMS from functioning properly. Always check the TPMS malfunction telltale after replacing one or more tires or wheels on your vehicle to ensure that the replacement or alternate tires and wheels allow the TPMS to continue to function properly.





- i** If a condition causing the TPMS to malfunction develops, it may take up to 10 minutes for the system to signal a

malfunction using the TPMS telltale flashing and illumination sequence.

The telltale extinguishes after a few minutes driving if the malfunction has been corrected.

Tire pressure inquiries are made using the multifunction display. The current tire inflation pressure for each tire appears in the multifunction display after a few minutes of driving.

- ❶ Possible differences between the readings of a tire pressure gauge of an air hose, e.g. gas station equipment, and the vehicle's control system can occur. The tire pressure displayed by the control system apply to sea level. In high-altitude locations, the reading on a tire pressure gauge will be higher than the reading issued by the vehicle's control system. Do not reduce the tire inflation pressure under such circumstances.

- ▶ Switch on the ignition.
- ▶ Press button  or  on the multifunction steering wheel repeatedly until the standard display appears in the multifunction display (▶ page 122).
- ▶ Press button  or  until the current inflation pressure for each tire appears in the multifunction display.



Example illustration

When the vehicle has been parked for longer than 20 minutes, the message Tire pressure displayed after driving for a few minutes. appears in the multifunction display.

The TPMS recognizes new wheels or sensors automatically after the learn-in phase. As long

as the tire inflation pressure values cannot be allocated to the individual wheels, the message Tire Pressure Monitor Active appears. Despite this message, the tire inflation pressure values are monitored already.

- ❶ With a spare wheel mounted, the system may still indicate the tire inflation pressure of the removed road wheel for some minutes. If this happens, keep in mind that the indicated value where the spare wheel is mounted does not reflect the actual spare tire inflation pressure.
- ❶ Operating radio transmission equipment (e.g. wireless headsets, two-way radios) in or near the vehicle could cause the TPMS to malfunction.

- ❶ This device complies with Part 15 of the FCC Rules. Operation is subject to the following two conditions:

1. This device may not cause harmful interference, and
2. this device must accept any interference received, including interference that may cause undesired.

Any unauthorized modification to this device could void the user's authority to operate the equipment.

Tire inflation pressure warnings

If the system detects a significant loss of tire inflation pressure in one or more than one tire, a message appears in the multifunction display. In addition, an acoustic warning sounds and the low tire pressure telltale in the instrument cluster comes on.



Example illustration

The respective tire is indicated by a red rectangle.

Restarting Advanced TPMS





Warning!

It is the driver's responsibility to set the tire inflation pressure to the recommended cold tire inflation pressure. Underinflated tires affect the ability to steer or brake the vehicle. You might lose control over the vehicle.

When you restart the TPMS, the system sets new reference values for each tire.

The TPMS must be restarted when you have adjusted the tire inflation pressure to a new level (e.g. because of different load or driving conditions). The TPMS is then recalibrated to the current tire inflation pressures.

Restart the TPMS after adjusting the tire inflation pressure to the inflation pressure recommended for the vehicle operating condition. Tire pressure should only be adjusted on cold tires. Observe the recommended tire inflation pressure on the Tire and Loading Information placard on the driver's door B-pillar. Some vehicles may have supplemental tire pressure information for driving at high speeds or for vehicle loads less than the maximum loaded vehicle condition. If such information is provided, it can be found on the inside of the fuel filler flap.

- ▶ Using the Tire and Loading Information placard on the driver's door B-pillar (▷ page 227) or the supplemental tire inflation pressure information on the inside of the fuel filler flap, make sure the tire inflation pressure of all four tires is correct.
- ▶ Switch on the ignition.
- ▶ Press button  or  on the multifunction steering wheel repeatedly until the standard display appears in the multifunction display (▷ page 122).
- ▶ Press button  or  repeatedly until you see the current inflation pressures for each tire appear in the display or the following message appears in the multifunction display:

Tire pressure displayed after driving for a few minutes.

- ▶ Press the reset button (▷ page 117). The following message will appear in the multifunction display:
Restart tire pressure monitor?

- ▶ **If you wish to confirm:** Press button .

The following message will appear in the multifunction display:
Tire Pressure Monitor
Restarted

After driving a few minutes the system verifies that the current tire inflation pressures are within the system's specified range. Afterwards the current tire inflation pressures are accepted as reference values and then monitored.

- ▶ **If you wish to cancel:** Press button .

- i** When the wheel positions have been changed, the inflation pressure of a tire may be displayed for the wrong position temporarily. After driving for a few minutes, the inflation pressure will be shown for the correct position.

Maximum tire inflation pressure

Warning!

Never exceed the maximum tire inflation pressure. Follow recommended tire inflation pressures.

Do not underinflate tires. Underinflated tires wear excessively and/or unevenly, adversely affect handling and fuel economy, and are more likely to fail from being overheated.

Do not overinflate tires. Overinflated tires can adversely affect handling and ride comfort, wear unevenly, increase stopping distance, and result in sudden deflation (blowout) because they are more likely to become

punctured or damaged by road debris, potholes etc.



- i** For illustration purposes only. Actual data on tires are specific to each vehicle and may vary from data shown in above illustration.

This is the maximum permissible tire inflation pressure **1** for the tire.

Always follow the recommended tire inflation pressure (▷ page 219) for proper tire inflation.

Loading the vehicle

Two labels on your vehicle show how much weight it may properly carry.

- (1) The Tire and Loading Information placard can be found on the driver's door B-pillar. This placard tells you important information about the number of people that can be in the vehicle and the total weight that can be carried in the vehicle. It also contains information on the proper size and recommended tire inflation pressures for the original equipment tires on your vehicle.
- (2) The certification label, also found on the driver's door B-pillar. It tells you about the gross weight capacity of your vehicle, called the Gross Vehicle Weight Rating (GVWR). The GVWR includes the weight of the vehicle, all occupants, fuel and cargo. The certification label also tells

you about the front and rear axle weight capacity, called the Gross Axle Weight Rating (GAWR).

The GAWR is the total allowable weight that can be carried by a single axle (front or rear). Never exceed the GVWR or GAWR for either the front axle or rear axle.



- 1** Driver's door B-pillar

Following is a discussion on how to work with the information contained on the Tire and Loading Information placard with regards to loading your vehicle.

Tire and Loading Information

⚠ Warning!

Do not overload the tires by exceeding the specified load limit as indicated on the Tire and Loading Information placard on the driver's door B-pillar. Overloading the tires can overheat them, possibly causing a blowout. Overloading the tires can also result in handling or steering problems, or brake failure.

Tire and Loading Information placard

i Data shown on Tire and Loading Information placard example are for illustration purposes only. Load limit data are specific to each vehicle and may vary from data shown in the following illustration. Refer to Tire and Loading Information placard on vehicle for actual data specific to your vehicle.



The Tire and Loading Information placard showing load limit information **1** is located on the driver's door B-pillar (▷ page 227).

► Locate the statement “The combined weight of occupants and cargo should never exceed XXX kilograms or XXX lbs.” on the Tire and Loading Information placard.

The combined weight of all occupants, cargo/luggage and trailer tongue load (if applicable) should never exceed the weight referenced in that statement.

Seating capacity

i Data shown on Tire and Loading Information placard example are for illustration purposes only. Seating capacity data are specific to each vehicle and may vary from data shown in the following illustration. Refer to Tire and Loading Information placard on vehicle for actual data specific to your vehicle.



The seating capacity gives you important information on the number of occupants that can be in the vehicle. Observe front and rear seating capacity. The Tire and Loading Information placard showing seating capacity **1** is located on the driver's door B-pillar (▷ page 227).

Steps for determining correct load limit

The following steps have been developed as required of all manufacturers under Title 49, Code of U.S. Federal Regulations, Part 575 pursuant to the “National Traffic and Motor Vehicle Safety Act of 1966”.

- **Step 1:** Locate the statement “The combined weight of occupants and cargo should never exceed XXX kg or XXX lbs.” on your vehicle's Tire and Loading Information placard.
- **Step 2:** Determine the combined weight of the driver and passengers that will be riding in your vehicle.
- **Step 3:** Subtract the combined weight of the driver and passengers from XXX kilograms or XXX lbs.
- **Step 4:** The resulting figure equals the available amount of cargo and luggage load capacity. For example, if the “XXX” amount equals 1 400 lbs and there will be five 150 lbs passengers in your vehicle, the amount of available cargo and luggage load capacity is 650 lbs (1 400 - 750 (5 x 150) = 650 lbs).

- ▶ **Step 5:** Determine the combined weight of luggage and cargo being loaded on the vehicle. That weight may not safely exceed the available cargo and luggage load capacity calculated in step 4.
- ▶ **Step 6 (if applicable):** If your vehicle will be towing a trailer, load from your trailer will be transferred to your vehicle. Consult this manual to determine how this reduces the available cargo and luggage load capacity of your vehicle (▷ page 231).

The following table shows examples on how to calculate total and cargo load capacities with varying seating configurations and number and size of occupants. The following examples use a load limit of 1 500 lbs. **This is for illustration purposes only.** Make sure you are using the actual load limit for your vehicle stated on the vehicle's Tire and Loading Information placard (▷ page 228).

		Example 1	Example 2	Example 3
Step 1	Combined weight limit of occupants and cargo from Tire and Loading Information placard	1 500 lbs	1 500 lbs	1 500 lbs

		Example 1	Example 2	Example 3
Step 2	Number of occupants (driver and passengers)	5	3	1
	Seating configuration	front: 2 rear: 3	front: 1 rear: 2	front: 1
	Occupants weight	Occupant 1: 150 lbs Occupant 2: 180 lbs Occupant 3: 160 lbs Occupant 4: 140 lbs Occupant 5: 120 lbs	Occupant 1: 200 lbs Occupant 2: 190 lbs Occupant 3: 150 lbs	Occupant 1: 150 lbs
	Combined weight of all occupants	750 lbs	540 lbs	150 lbs

		Example 1	Example 2	Example 3
Step 3	Available cargo/ luggage and trailer tongue weight (total load limit from Tire and Loading Information placard minus combined weight of all occupants)	1 500 lbs - 750 lbs = 750 lbs	1 500 lbs - 540 lbs = 960 lbs	1 500 lbs - 150 lbs = 1 350 lbs

The higher the weight of all occupants, the less cargo and luggage load capacity is available.

For more information, see “Trailer tongue load” (▷ page 231).

Certification label

Even after careful determination of the combined weight of all occupants, cargo and the trailer tongue load (if applicable) (▷ page 231) as to not exceed the permissible load limit, you must make sure your vehicle never exceeds the Gross Vehicle

Weight Rating (GVWR) and the Gross Axle Weight Rating (GAWR) for either the front or rear axle. You can obtain the GVWR and GAWR from the certification label. The certification label can be found on the driver's door B-pillar, see the "Technical data" section (▷ page 346).

Gross Vehicle Weight Rating (GVWR): The total weight of the vehicle, all occupants, all cargo, and the trailer tongue load (if applicable) must never exceed the GVWR.

Gross Axle Weight Rating (GAWR): The total allowable weight that can be carried by a single axle (front or rear).

To assure that your vehicle does not exceed the maximum permissible weight limits (GVWR and GAWR for front and rear axle), have the loaded vehicle (including driver, passengers and all cargo and, if applicable, trailer fully loaded) weighed on a suitable commercial scale.

Trailer tongue load

The tongue load of any trailer is an important weight to measure because it affects the load you can carry in your vehicle. If a trailer is towed, the tongue load must be added to the weight of all occupants riding and any cargo you are carrying in the vehicle. The tongue load typically is between 8% and 15% of the trailer weight and everything loaded in it.

Maximum tire load

Warning!

Do not overload the tires by exceeding the specified load limit as indicated on the Tire and Loading Information placard on the driver's door B-pillar. Overloading the tires can overheat them, possibly causing a blowout. Overloading the tires can also result in handling or steering problems, or brake failure.



i For illustration purposes only. Actual data on tires are specific to each vehicle and may vary from data shown in above illustration.

The maximum tire load rating ① is the maximum weight the tires are designed to support.

For more information on tire load rating, see (▷ page 236).

For information on calculating total and cargo load capacities, see (▷ page 228).

Direction of rotation

Unidirectional tires offer added advantages, such as better hydroplaning performance. To benefit, however, you must make sure the tires rotate in the direction specified.

An arrow on the sidewall indicates the intended direction of rotation of the tire.

Spare wheels may be mounted against the direction of rotation (spinning) even with a unidirectional tire for temporary use only until the regular drive wheel has been repaired or replaced. Always observe and follow applicable temporary use restrictions and speed limitations indicated on the spare wheel.

MOExtended system

The MOExtended system allows you to continue driving your vehicle even if there is a total loss of pressure in one or more tires.

You may only use the MOExtended system in conjunction with the tire pressure loss warning system (▷ page 222) or the Advanced TPMS (▷ page 223).

i Vehicles with MOExtended system are not factory-equipped with a TIREFIT kit. When retrofitting with tires that do not have run-flat characteristics, e.g. winter tires, you should also equip your vehicle with a TIREFIT kit. TIREFIT kits are available at all authorized Mercedes-Benz Center.

For information on driving in case of pressure loss in one or more tires (emergency mode), see the “Practical hints” section (▷ page 330).

Tire care and maintenance

Warning!

Regularly check the tires for damage. Damaged tires can cause tire inflation pressure loss. As a result, you could lose control of your vehicle.

Worn, old tires can cause accidents. If the tire tread is worn to minimum tread depth, or if the tires have sustained damage, replace them.

Check the tire inflation pressure at least once a month. For more information on checking tire inflation pressure, see “Recommended tire inflation pressure” (▷ page 219).

Tire inspection

Every time you check the tire inflation pressure, you should also inspect your tires for the following:

- excessive treadwear (▷ page 232)
- cord or fabric showing through the tire’s rubber
- bumps, bulges, cuts, cracks or splits in the tread or side of the tire

Replace the tire if you find any of the above conditions.

Make sure you also inspect the spare tire periodically for condition and inflation. Spare tires will age and become worn over time even if never used, and thus should be inspected and replaced when necessary.

Life of tire

Warning!

Tires and spare tire should be replaced after 6 years, regardless of the remaining tread.

The service life of a tire is dependent upon varying factors including but not limited to:

- Driving style
- Tire inflation pressure
- Distance driven

Tread depth

Warning!

Although the applicable federal motor vehicle safety laws consider a tire to be worn when the treadwear indicators (TWI) become visible at approximately $\frac{1}{16}$ in (1.6 mm), we recommend that you do not allow your tires to wear down to that level. As tread depth approaches $\frac{1}{8}$ in (3 mm), the adhesion properties on a wet road are sharply reduced. Depending upon the weather and/or road surface (conditions), the tire traction varies widely.

Do not allow your tires to wear down too far. Adhesion properties on wet roads are sharply reduced at tread depths of less than $\frac{1}{8}$ in (3 mm).

Treadwear indicators (TWI) are required by law. These indicators are located in six places on the tread circumference and become visible at a tread depth of approximately $\frac{1}{16}$ in (1.6 mm), at which point the tire is considered worn and should be replaced. The recommended minimum tire tread depth for summer tires is $\frac{1}{8}$ in (3 mm). The

recommended minimum tire tread depth for winter tires is $\frac{1}{6}$ in (4 mm).

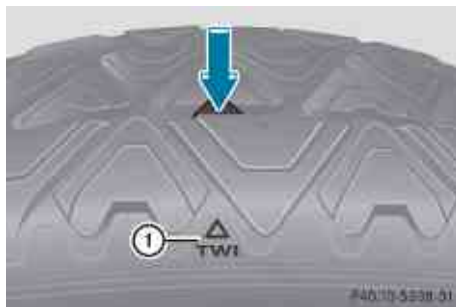

Treadwear indicator ① appears as a solid band across the tread.

Storing tires

- ❗ Keep unmounted tires in a cool, dry place with as little exposure to light as possible. Protect tires from contact with oil, grease and fuels.

Cleaning tires

- ❗ Never use a round nozzle to power wash tires. The intense jet of water can result in damage to the tire. Always replace a damaged tire.

Uniform Tire Quality Grading Standards



The Uniform Tire Quality Grading is a U.S. Government requirement designed to give drivers consistent and reliable information

regarding tire performance. Tire manufacturers are required to grade tires based on three performance factors: treadwear ①, traction ②, and temperature resistance ③. Although not a Government of Canada requirement, all tires made for sale in North America have these grades branded on the sidewall.

- ❗ For illustration purposes only. Actual data on tires are specific to each vehicle and may vary from data shown in above illustration.

Quality grades can be found, where applicable, on the tire sidewall between tread shoulder and maximum section width. For example:

Treadwear	Traction	Temperature
200	AA	A

All passenger car tires must conform to federal safety requirements in addition to these grades.

Treadwear

The treadwear grade is a comparative rating based on the wear rate of the tire when tested under controlled conditions on a specified U.S. Government test course. For example, a tire graded 150 would wear one and one-half ($1\frac{1}{2}$) times as well on the government course as a tire graded 100.

The relative performance of tires depends upon the actual performance of their use, however, and may depart significantly from the norm due to variations in driving habits, service practices and differences in road characteristics and climate.

Traction

⚠ Warning!

The traction grade assigned to this tire is based on straight-ahead braking traction

tests, and does not include acceleration, cornering, hydroplaning, or peak traction characteristics.

The traction grades, from highest to lowest, are AA, A, B, and C. Those grades represent the tire's ability to stop on wet pavement as measured under controlled conditions on specified government test surfaces of asphalt and concrete. A tire marked C may have poor traction performance.

Warning!

If ice has formed on the road, tire traction will be substantially reduced. Under such weather conditions, drive, steer and brake with extreme caution.

The safe speed on a wet, snow covered or icy road is always lower than on a dry road.

You should pay particular attention to the condition of the road whenever the outside temperature is close to the freezing point.

Mercedes-Benz recommends winter tires (> page 242) with a minimum tread depth of approximately $\frac{1}{6}$ in (4 mm) on all four wheels for the winter season to ensure normal balanced handling characteristics. On packed snow, they can reduce your stopping distance compared to summer tires. Stopping distance, however, is still considerably greater than when the road is not covered with snow or ice. Exercise appropriate caution.

! Avoid spinning of a drive wheel. This may cause serious damage to the drivetrain which is not covered by the Mercedes-Benz Limited Warranty.

Temperature

Warning!

The temperature grade for this tire is established for a tire that is properly inflated and not overloaded. Excessive speed, underinflation, or excessive loading, either separately or in combination, can cause

excessive heat build-up and possible tire failure.

The temperature grades are A (the highest), B, and C, representing the tire's resistance to the generation of heat and its ability to dissipate heat when tested under controlled conditions on a specified indoor laboratory test wheel. Sustained high temperature can cause the material of the tire to degenerate and reduce tire life, and excessive temperature can lead to sudden tire failure. The grade C corresponds to a level of performance which all passenger car tires must meet under the Federal Motor Vehicle Safety Standard No. 109. Grades B and A represent higher levels of performance on the laboratory test wheel than the minimum required by law.

Rotating tires

Warning!

Rotate front and rear wheels only if the tires are of the same dimension.

If your vehicle is equipped with mixed-size tires (different tire dimensions front vs. rear), tire rotation is not possible.

Warning!

Have the tightening torque checked after changing a wheel. The wheels could come loose if they are not tightened to a torque of 110 lb-ft (150 Nm).

Only use genuine Mercedes-Benz wheel bolts specified for your vehicle's rims.

Tire rotation can be performed on vehicles with tires of the same dimension all around. If your vehicle is equipped with tires of the same dimension all around, tires can be rotated, observing a front-to-rear rotation pattern that will maintain the intended rotation (spinning) direction of the tire (> page 231).

In some cases, such as when your vehicle is equipped with mixed-size tires (different tire

dimension front vs. rear), tire rotation is not possible.

If applicable to your vehicle's tire configuration, tires can be rotated according to the tire manufacturer's recommended intervals in the tire manufacturer's warranty pamphlet located in your vehicle literature portfolio. If none is available, tires should be rotated every 3 000 to 6 000 miles (5 000 to 10 000 km), or sooner if necessary, according to the degree of tire wear. The same rotation (spinning) direction must be maintained.

Rotate tires before the characteristic tire wear pattern becomes visible (shoulder wear on front tires and tread center wear on rear tires).

Thoroughly clean the mounting face of wheels and brake disks, i.e. the inner side of the wheels/tires, during each rotation. Check for and ensure proper tire inflation pressure.

For information on wheel change, see "Flat tire" (▷ page 319).

Tire labeling

Besides tire name (sales designation) and manufacturer name, a number of markings can be found on a tire.

Following are some explanations for the markings on your vehicle's tires:

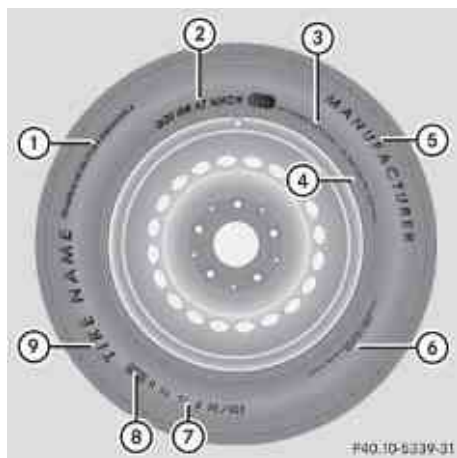

- ① Uniform Tire Quality Grading Standards (▷ page 233)
 - ② DOT, Tire Identification Number (▷ page 238)
 - ③ Maximum tire load (▷ page 231)
 - ④ Maximum tire inflation pressure (▷ page 226)
 - ⑤ Manufacturer
 - ⑥ Tire ply material (▷ page 239)
 - ⑦ Tire size designation, load and speed rating (▷ page 236)
 - ⑧ Load identification (▷ page 238)
 - ⑨ Tire name
- i** For illustration purposes only. Actual data on tires are specific to each vehicle and may vary from data shown in above illustration.
- For more information, see "Rims and tires" (▷ page 352).

Tire size designation, load and speed rating

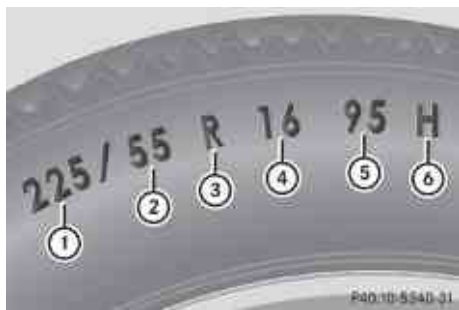

- ① Tire width
- ② Aspect ratio in %
- ③ Radial tire code
- ④ Rim diameter
- ⑤ Load index
- ⑥ Speed symbol

i For illustration purposes only. Actual data on tires are specific to each vehicle and may vary from data shown in above illustration.

General: Depending on the design standards used, the tire size molded into the sidewall may have no letter or a letter preceding the tire size designation.

No letter preceding the size designation (as illustrated above): Passenger car tire based on European design standards.

Letter “P” preceding the size designation: Passenger car tire based on U.S. design standards.

Letter “LT” preceding the size designation: Light Truck tire based on U.S. design standards.

Letter “T” preceding the size designation: Temporary spare tires which are high pressure compact spares designed for temporary emergency use only.

Tire width

Tire width ① indicates the nominal tire width in millimeters.

Aspect ratio

Aspect ratio ② is the dimensional relationship between tire section height and section width and is expressed in percentage. The aspect ratio is arrived at by dividing section height by section width.

Tire code

Tire code ③ indicates the tire construction type. The “R” stands for radial tire type. Letter “D” means diagonal or bias ply construction; letter “B” means belted-bias ply construction.

At the tire manufacturer’s option, any tire with a speed capability above 149 mph (240 km/h) can include a “ZR” in the size designation (for example: 245/40 ZR 18). For additional information, see “Tire speed rating” (▷ page 237).

Rim diameter

Rim diameter ④ is the diameter of the bead seat, not the diameter of the rim edge. The rim diameter is indicated in inches (in).

Load index

⚠ Warning!

The tire load rating must always be at least half of the GAWR of your vehicle. Otherwise, tire failure may be the result which may cause an accident and/or serious injury to you or others.

Always replace rims and tires with the same designation, manufacturer and type as shown on the original part.

⚠ Warning!

Do not overload the tires by exceeding the specified load limit as indicated on the Tire and Loading Information placard on the driver’s door B-pillar. Overloading the tires can overheat them, possibly causing a blowout. Overloading the tires can also result in handling or steering problems, or brake failure.

Load index ⑤ is a numerical code associated with the maximum load a tire can support.

For example, a load rating of 91 corresponds to a maximum load of 1356 lb (615 kg) the tire is designed to support. See also “Maximum tire load” (▷ page 231) where the maximum load associated with the load index is indicated in kilograms and lbs.

For additional information on the load index, see “Load identification” (▷ page 238).

Speed symbol

Warning!

Even when permitted by law, never operate a vehicle at speeds greater than the maximum speed rating of the tires.

Exceeding the maximum speed for which tires are rated can lead to sudden tire failure, causing loss of vehicle control and possibly resulting in an accident and/or serious personal injury and possible death, for you and for others.



Regardless of the tire speed rating, local speed limits should be obeyed. Use prudent driving speeds appropriate to prevailing conditions.

Speed symbol  indicates the approved maximum speed (tire speed rating) for the tire.

Summer tires

Index	Speed rating
Q	up to 100 mph (160 km/h)
R	up to 106 mph (170 km/h)
S	up to 112 mph (180 km/h)
T	up to 118 mph (190 km/h)
H	up to 130 mph (210 km/h)
V	up to 149 mph (240 km/h)
W	up to 168 mph (270 km/h)
Y	up to 186 mph (300 km/h)
ZR...Y	up to 186 mph (300 km/h)

Index	Speed rating
ZR...(..Y)	above 186 mph (300 km/h)
ZR	above 149 mph (240 km/h)

- At the tire manufacturer's option, any tire with a speed capability above 149 mph (240 km/h) can include a “ZR” in the size designation (for example: 245/40 ZR18). To determine the maximum speed capability of the tire, the service description for the tire must be referred to. The service description is comprised of load index  and speed symbol .

If your tire includes “ZR” in the size designation and no service description is given, the tire manufacturer must be consulted for the maximum speed capability.

If a service description is given, the speed capability is limited by the speed symbol in the service description. Example: 245/40 ZR18 97Y. In this example, “97Y” is the service description. The letter “Y” designates the speed rating and the speed capability of the tire is limited to 186 mph (300 km/h).

- Any tire with a speed capability above 186 mph (300 km/h) must include a “ZR” in the size designation AND the service description must be placed in parenthesis. Example: 275/40 ZR 18 (99Y). The “(Y)” speed symbol in parenthesis designates the maximum speed capability of the tire as being above 186 mph (300 km/h). Consult the tire manufacturer for the actual maximum permissible speed of the tire.

All-season and winter tires

Index	Speed rating
Q M+S ²⁰	up to 100 mph (160 km/h)
T M+S ²⁰	up to 118 mph (190 km/h)

Index	Speed rating
H M+S ²⁰	up to 130 mph (210 km/h)
V M+S ²⁰	up to 149 mph (240 km/h)

i Not all M+S rated tires provide special winter performance. Make sure the tires you use show M+S and the mountain/snowflake  marking on the tire sidewall. These tires meet specific snow traction performance requirements of the Rubber Manufacturers Association (RMA) and the Rubber Association of Canada (RAC) and have been designed specifically for use in snow conditions.

An electronic speed limiter prevents your vehicle from exceeding a speed of:

- All models except ML 63 AMG: 130 mph (210 km/h)
- ML 63 AMG: 155 mph (250 km/h)
- ML 63 AMG with increased top speed: 171 mph (275 km/h)

The factory equipped tires on your vehicle may have a tire speed rating above the maximum speed permitted by the electronic speed limiter.

Make sure your tires have the required tire speed rating as specified for your vehicle in the “Technical data” section (▷ page 352), for example when purchasing new tires.

If you are uncertain about the correct reading of the information given on a tire’s sidewall, any authorized Mercedes-Benz Center will be glad to assist you.

Load identification



i For illustration purposes only. Actual data on tires are specific to each vehicle and may vary from data shown in above illustration.

In addition to the load index, special load identification ① may be molded into the tire sidewall following the letter designating the speed symbol ⑥ (▷ page 236).

- No specification given: absence of any text (like in above example) indicates a standard load (SL) tire.
- XL or Extra Load: designates an extra load (or reinforced) tire.
- Light Load: designates a light load tire.
- C, D, E: designates load range associated with the maximum load a tire can carry at a specified pressure.

DOT, Tire Identification Number (TIN)

U.S. tire regulations require each new tire manufacturer or tire retreader to mold a TIN into or onto a sidewall of each tire produced.



The TIN is a unique identifier. The TIN facilitates efforts by tire manufacturers to notify purchasers in recall situations or other safety matters concerning tires. It gives purchasers the means to easily identify such tires.

The TIN is comprised of “Manufacturer’s identification mark” ②, “Tire size” ③, “Tire type code” ④ and “Date of manufacture” ⑤.

i For illustration purposes only. Actual data on tires are specific to each vehicle and may vary from data shown in above illustration.

DOT (Department of Transportation)

Tire branding symbol ① denotes that the tire meets requirements of the U.S. Department of Transportation.

Manufacturer’s identification mark

Manufacturer’s identification mark ② denotes the tire manufacturer.

New tires have a mark with two symbols.

Retreaded tires have a mark with four symbols. For more information on retreaded tires, see (▷ page 218).

Tire size

Code ③ indicates the tire size.

Tire type code

Tire type code ④ may, at the option of the manufacturer, be used as a descriptive code for identifying significant characteristics of the tire.

Date of manufacture

The date of manufacture ⑤ identifies the week and year of manufacture.

The first two figures identify the week, starting with “01” to represent the first full week of the calendar year. The second two figures represent the year.

For example, “3208” represents the 32nd week of 2008.

Tire ply material



i For illustration purposes only. Actual data on tires are specific to each vehicle and may vary from data shown in above illustration.

This marking tells you about the type of cord and number of plies in the sidewall ① and under the tread ②.

Tire and loading terminology

Accessory weight

The combined weight (in excess of those standard items which may be replaced) of automatic transmission, power steering, power brakes, power windows, power seats,

radio, and heater, to the extent that these items are available as factory-installed equipment (whether installed or not).

Air pressure

The amount of air inside the tire pressing outward on each square inch of the tire. Air pressure is expressed in pounds per square inch (psi), kilopascal (kPa), or bar.

Aspect ratio

Dimensional relationship between tire section height and section width expressed in percentage.

Bar

Metric unit for air pressure. There are 14.5038 pounds per square inch (psi) to 1 bar; there are 100 kilopascals (kPa) to 1 bar.

Bead

The tire bead contains steel wires wrapped by steel cords that hold the tire onto the rim.

Cold tire inflation pressure

Tire inflation pressure when your vehicle has been sitting for at least 3 hours or driven no more than 1 mile (1.6 km).

Curb weight

The weight of a motor vehicle with standard equipment including the maximum capacity of fuel, oil, and coolant, and, if so equipped, air conditioning and additional optional equipment, but without passengers and cargo.

DOT (Department of Transportation)

A tire branding symbol which denotes the tire meets requirements of the U.S. Department of Transportation.

GAWR (Gross Axle Weight Rating)

The GAWR is the maximum permissible axle weight. The gross vehicle weight on each axle must never exceed the GAWR for the front and rear axle indicated on the certification label located on the driver's door B-pillar.

GTW (Gross Trailer Weight)

The GTW is the weight of the trailer plus the weight of all cargo, equipment, luggage etc. loaded on the trailer.

GVW (Gross Vehicle Weight)

The GVW comprises the weight of the vehicle including fuel, tools, spare wheel, installed accessories, passengers and cargo and, if applicable, trailer tongue load. The GVW must never exceed the GVWR indicated on the certification label located on the driver's door B-pillar.

GVWR (Gross Vehicle Weight Rating)

This is the maximum permissible vehicle weight of the fully loaded vehicle (weight of the vehicle including all options, passengers, fuel, and cargo and, if applicable, trailer tongue load). It is indicated on the certification label located on the driver's door B-pillar.

Kilopascal (kPa)

Metric unit for air pressure. There are 6.9 kPa to 1 psi; another metric unit for air pressure is bar. There are 100 kilopascals (kPa) to 1 bar.

Load index

Numerical code associated with the maximum load a tire can support.

Maximum load rating

The maximum load in kilograms and pounds that can be carried by the tire.

Maximum loaded vehicle weight

The sum of curb weight, accessory weight, total load limit, and production options weight.

Maximum permissible tire inflation pressure

This number is the greatest amount of air pressure that should ever be put in the tire.

Normal occupant weight

The number of occupants the vehicle is designed to seat, multiplied by 68 kilograms (150 lb).

Occupant distribution

The distribution of occupants in a vehicle at their designated seating positions.

Production options weight

The combined weight of those installed regular production options weighing over 5 lbs (2.3 kilograms) in excess of those standard items which they replace, not previously considered in curb weight or accessory weight, including heavy duty brakes, ride levelers, roof rack, heavy duty battery, and special trim.

PSI (Pounds per square inch)

A standard unit of measure for air pressure.

Recommended tire inflation pressure

The recommended tire inflation pressure for normal driving conditions is listed on the Tire and Loading Information placard located on the driver's door B-pillar. It provides best handling, tread life and riding comfort. Supplemental information pertaining to special driving situations can be found on the tire inflation pressure label on the inside of the fuel filler flap.

Rim

A metal support for a tire or a tire and tube assembly upon which the tire beads are seated.

Sidewall

The portion of a tire between the tread and the bead.

TIN (Tire Identification Number)

Unique identifier which facilitates efforts by tire manufacturers to notify purchasers in recall situations or other safety matters concerning tires and gives purchasers the means to easily identify such tires. The TIN is comprised of "Manufacturer's identification mark", "Tire size", "Tire type code" and "Date of manufacture".

Tire ply composition and material used

This indicates the number of plies or the number of layers of rubber-coated fabric in the tire tread and sidewall. Tire manufacturers also must indicate the ply materials in the tire and sidewall, which include steel, nylon, polyester, and others.

Tire speed rating

Part of tire designation (speed symbol); indicates the speed range for which a tire is approved.

Total load limit

Rated cargo and luggage load plus 68 kilograms (150 lb) times the vehicle's designated seating capacity.

Traction

The adhesive friction of a tire on a surface on which it moves. The amount of grip provided.

Tread

The portion of a tire that comes into contact with the road.

Treadwear indicators

Narrow bands, sometimes called “wear bars” that show across the tread of a tire when only $\frac{1}{16}$ in (1.6 mm) of tread remains.

TWR (Tongue Weight Rating)

Maximum permissible weight on trailer tongue.

Uniform Tire Quality Grading Standards

A tire information system that provides consumers with ratings for a tire’s traction, temperature and treadwear. Ratings are determined by tire manufacturers using U.S. government testing procedures. The ratings are molded into the sidewall of the tire.

Vehicle maximum load on the tire

Load on an individual tire that is determined by distributing to each axle its share of the maximum loaded vehicle weight and dividing it by two.

Winter driving

General information

Have your vehicle winterized at an authorized Mercedes-Benz Center.

i Vehicles with diesel engine:

Do not cover the radiator, for example with a winter front. Otherwise the readings of the on-board diagnostic system may be inaccurate. Some of these readings are required by law and must be accurate at all times.

Winter tires

Warning!

Winter tires with a tread depth of less than $\frac{1}{6}$ in (4 mm) must be replaced. They are no longer suitable for winter operation.

Warning!

If you use your spare wheel when winter tires are fitted on the other wheels, be aware that the difference in tire characteristics may very well impair turning stability and that overall driving stability may be reduced. Adapt your driving style accordingly.

Have the spare wheel replaced by a regular road wheel with a winter tire at the nearest authorized Mercedes-Benz Center.

Always use winter tires at temperatures below 45°F (7°C) and whenever wintry road conditions prevail. Not all M+S rated tires provide special winter performance. Make sure the tires you use show the mountain/snowflake  marking on the tire sidewall.

These tires meet specific snow traction performance requirements of the Rubber Manufacturers Association (RMA) and the Rubber Association of Canada (RAC) and have been designed specifically for use in snow conditions. Use of winter tires is the only way to achieve the maximum effectiveness of your vehicle’s driving safety systems such as the ABS and the ESP® in winter operation.

For safe handling, make sure all mounted winter tires are of the same make and have the same tread design.

For information on winter tires for your vehicle model, see the “Technical data” section (▷ page 352).

Always observe the speed rating of the winter tires installed on your vehicle.

After installing winter tires:

- ▶ Check the tire inflation pressure and adjust it if necessary (▷ page 221).
- ▶ Restart the tire pressure loss warning system (▷ page 222) or the Advanced Tire Pressure Monitoring System (▷ page 223).

Snow chains

! Vehicles with Adaptive Damping System (ADS):
When driving with snow chains, do not select **SPORT** mode as this may result in damage to your vehicle.

! Some tire sizes do not leave adequate clearance for snow chains. To help avoid serious damage to your vehicle or tires, make sure the use of snow chains is permissible as specified in the “Technical data” section of this Operator’s Manual.

Snow chains should only be driven on snow-covered roads at speeds not to exceed 30 mph (50 km/h). Remove chains as soon as possible when driving on roads without snow.

Observe the following guidelines when using snow chains:

- Use of snow chains is not permissible with all wheel/tire combinations (▷ page 352).
- Use snow chains in pairs and on rear wheels only. Follow the manufacturer’s mounting instructions.
- !** If snow chains are mounted to the front wheels, they may scrape against the body or axle components. The tires or the vehicle could be damaged as a result.
- Only use snow chains that are approved by Mercedes-Benz. Any authorized Mercedes-Benz Center will be glad to advise you on this subject.
- Use of snow chains may be prohibited depending on location. Always check local

and state laws before installing snow chains.

- Do not use snow chains on the spare wheel.

i When driving with snow chains, you may wish to switch off the ESP® (▷ page 63) before setting the vehicle in motion. This will improve the vehicle’s traction.

Winter driving instructions

Warning!

If the vehicle becomes stuck in snow, make sure snow is kept clear of the exhaust pipe and from around the vehicle with the engine running. Otherwise, deadly carbon monoxide (CO) gases may enter vehicle interior resulting in unconsciousness and death.

To assure sufficient fresh air ventilation, open a window slightly on the side of the vehicle not facing the wind.

Warning!

The outside temperature indicator is not designed to serve as an ice-warning device and is therefore unsuitable for that purpose.

Indicated temperatures just above the freezing point do not guarantee that the road surface is free of ice. The road may still be icy, especially in wooded areas or on bridges.

Warning!

On slippery road surfaces, never downshift in order to obtain braking action. This could result in drive wheel slip and reduced vehicle control. Your vehicle’s ABS will not prevent this type of loss of control.

The most important rule for slippery or icy roads is to drive sensibly and to avoid abrupt acceleration, braking and steering maneuvers. Do not use the cruise control system under such conditions.

When the vehicle is in danger of skidding, shift the automatic transmission to neutral

position **N**. Try to keep the vehicle under control by corrective steering action.

- i** For information on driving with snow chains, see “Snow chains” (▷ page 243).

Road salts and chemicals can adversely affect braking efficiency. Increased pedal force may become necessary to produce the normal brake effect.

Depressing the brake pedal periodically when traveling at length on salt-strewn roads can bring road-salt-impaired braking efficiency back to normal.

If the vehicle is parked after being driven on salt-treated roads, the braking efficiency should be tested as soon as possible after driving is resumed.

Warning!

Make sure not to endanger any other road users when carrying out these braking maneuvers.

Driving instructions

Drive sensibly – save fuel

To save fuel you should:

- Keep tires at the recommended inflation pressures.
- Remove unnecessary loads.
- Remove carriers when not in use.
- Allow engine to warm up under low load use.
- Avoid frequent acceleration and deceleration.
- Have all maintenance work performed at the intervals specified in the Maintenance Booklet and as required by the Maintenance system. Contact an authorized Mercedes-Benz Center.

Fuel consumption is also increased by driving in cold weather, in stop-and-go traffic, on short trips and in mountainous areas.

Drinking and driving

Warning!

Drinking and driving and/or taking drugs and driving are very dangerous combinations. Even a small amount of alcohol or drugs can affect your reflexes, perceptions and judgment.

The possibility of a serious or even fatal accident are greatly increased when you drink or take drugs and drive.

Do not drink or take drugs and drive or allow anyone to drive who has been drinking or taking drugs.

Pedals

Warning!

Make sure absolutely no objects are obstructing the pedals' range of movement. Keep the driver's footwell clear of all obstacles. If there are any floor mats or carpets in the footwell, make sure that the pedals still have sufficient clearance.

During sudden driving or braking maneuvers, the objects could get caught between the pedals. You could then no longer brake or accelerate. This could lead to accidents and injury.

Power assistance

Warning!

There is no power assistance for the steering and the brake when the engine is not running. Steering and braking requires significantly more effort and you could lose control of the vehicle and cause an accident as a result.

Do not turn off the engine while the vehicle is in motion.

Brakes

Downhill grades

! When driving down long and steep grades, relieve the load on the brakes by shifting into a lower gear to use the engine's braking power. This helps prevent overheating of the brakes and reduces wear.

When using the engine's braking power, a drive wheel may not spin for an extended period of time, e.g. on slippery road surfaces. This may cause serious damage to the drivetrain which is not covered by the Mercedes-Benz Limited Warranty.

Continuous or hard braking

Warning!

Resting your foot on the brake pedal will cause excessive and premature wear of the brake pads.

It can also result in the brakes overheating, thereby significantly reducing their effectiveness. It may not be possible to stop the vehicle in sufficient time to avoid an accident.

After hard braking, it is advisable to drive on for some time, rather than immediately park, so that the air stream will cool down the brakes faster.

Wet roads

Warning!

After driving in heavy rain for some time without applying the brakes or through water deep enough to wet brake components, the first braking action may be somewhat reduced and increased pedal pressure may be necessary to obtain expected brake effect. Maintain a safe distance from vehicles in front.

To help prevent brake disk corrosion after driving on wet or salt-covered roads, it is advisable to brake the vehicle with

considerable force prior to parking. The heat generated serves to dry the brakes.

Salt-covered roads

Warning!

A layer of salt on the brake discs and the brake linings may cause a delay in the braking effect, resulting in a significantly increased braking distance, which could lead to an accident.

To avoid this danger, you should:

- occasionally brake carefully when you are driving on salt-covered roads, so that any layer of salt that may have built up on the brake discs and the brake linings is removed without putting other road users at risk
- maintain a greater distance to the vehicle ahead and drive with particular care
- carefully apply the brakes at the end of a trip and immediately after commencing a new trip, so that salt residues are removed from the brake disc

Brake service

! The brake fluid level in the reservoir may be too low if the brake warning lamp in the instrument cluster comes on and an acoustic warning sounds although the parking brake is released. Observe additional messages in the multifunction display that may appear.

Brake pad wear or a leak in the system may be the reason for low brake fluid in the reservoir.

Have the brake system inspected immediately. Contact an authorized Mercedes-Benz Center.

All checks and service work on the brake system should be carried out by qualified technicians only. Contact an authorized Mercedes-Benz Center.

Only install brake pads and use brake fluid recommended by Mercedes-Benz.

 **Warning!**

If other than recommended brake pads are installed, or other than recommended brake fluid is used, the braking properties of the vehicle can be degraded to an extent that safe braking is substantially impaired. This could result in an accident.

 **Vehicles with 4MATIC:**

Only conduct operational or performance tests on a two-axle dynamometer. If such tests are necessary, contact an authorized Mercedes-Benz Center. You could otherwise seriously damage the brake system or the transfer case which is not covered by the Mercedes-Benz Limited Warranty.

 **Vehicles without 4MATIC:**

Because the ESP® operates automatically, the engine and ignition must be shut off (SmartKey in starter switch position **0** or **1** or KEYLESS-GO start/stop button in position **0** or **1**) when the parking brake is being tested on a brake test dynamometer or the vehicle is being towed with one axle raised.

Active braking action through the ESP® may otherwise seriously damage the brake system which is not covered by the Mercedes-Benz Limited Warranty.

 **Vehicles with 4MATIC:**

Because the ESP® operates automatically, the engine and ignition must be shut off (SmartKey in starter switch position **0** or **1** or KEYLESS-GO start/stop button in position **0** or **1**) when the parking brake is being tested on a brake test dynamometer. Such testing should be no longer than 10 seconds.

Active braking action through the ESP® may otherwise seriously damage the brake

system which is not covered by the Mercedes-Benz Limited Warranty.

If your brake system is only subjected to moderate loads, you should occasionally test the effectiveness of the brakes by applying above-normal braking pressure at higher speeds. This will also enhance the grip of the brake pads.

 **Warning!**

Make sure not to endanger any other road users when carrying out these braking maneuvers.

Refer to the description of the Brake Assist System (BAS) (▷ page 63).

High-performance brake system

The high-performance brake system is only available on ML 63 AMG.

 **Warning!**

New vehicle brake pads and disks, and replacement brake pads and disks may take several hundred miles of driving until they provide optimum braking efficiency. Until that time, you may need to use increased brake pedal pressure while braking. Please be aware of this and adjust your driving and braking accordingly during this break-in period.

Excessive high-demand braking will cause correspondingly high brake wear. Please be attentive to the brake warning lamp in the instrument cluster and brake condition messages in the multifunction display. Especially for high-performance driving, it is important to maintain and have the brake system checked regularly.

The high-performance brake system is designed to operate under the extremely high operating demands required to accommodate the performance capabilities of the vehicle.

The brakes may produce a squeaking-type noise depending on the

- vehicle speed
- brake force applied
- ambient conditions, e.g. temperature and humidity

As with any brake system, the wear of individual brake system components such as brake pads or disks strongly depends on your driving style and the conditions under which you operate the vehicle. Thus, a driving style calling for high-demand braking will cause your vehicle's brakes to wear more quickly.

Parking brake

When driving on wet roads or dirt covered surfaces, road salt and/or dirt can get into the parking brake.

To prevent corrosion and a reduction in the braking power of the parking brake, observe the following:

- ▶ From time to time, lightly engage the parking brake before driving off.
- ▶ Drive a distance of approximately 110 yds (100 m) at a maximum speed of 12 mph (20 km/h).

Warning!

While performing this procedure please assure that the vehicle is stopped before applying the parking brake. Otherwise the rear wheels could lock up. You could lose control of the vehicle and cause an accident. In addition, the vehicle's brake lights do not light up when the parking brake is engaged. Make sure not to endanger any other road users when you engage the parking brake.

Driving off

Warm up the engine smoothly. Do not place full load on the engine until the operating temperature has been reached.

! When driving off on a slippery surface, do not allow a drive wheel to spin for an extended period with the ESP® switched off. Doing so may cause serious damage to the drivetrain which is not covered by the Mercedes-Benz Limited Warranty.

! Simultaneously depressing the accelerator pedal and applying the brakes reduces engine performance and causes premature brake and drivetrain wear which is not covered by the Mercedes-Benz Limited Warranty.

Hydroplaning

Depending on the depth of the water layer on the road, hydroplaning may occur, even at low speeds and with new tires. In heavy rain or when conditions indicate possible hydroplaning:

- ▶ Reduce vehicle speed.
- ▶ Avoid track grooves in the road.
- ▶ Apply brakes cautiously.

Standing water

! Do not drive through flooded areas. Before driving through water, determine its depth.

If you must drive through standing water, drive slowly to prevent water from entering the passenger compartment or the engine compartment. Water in these areas could cause damage to electrical components or wiring of the engine or transmission, or could result in water being ingested by the engine through the air intake causing severe internal engine damage. Any such damage is not covered by the Mercedes-Benz Limited Warranty.

i Vehicles with air suspension program: Select the raised level (▷ page 156) before driving through standing water.

For more information, see “Driving through water” (▷ page 251).

Off-road driving

Warning!

Do not load items on the basic carrier bars. It may cause instability during some maneuvers which could result in an accident.

Drive slowly in unknown terrain. This will make it easier to recognize unexpected obstacles and avoid damage to the vehicle.

To help avoid the vehicle rolling over, never turn it around on steep inclines. If the vehicle cannot complete the attempted climb, back it down in reverse gear.

Do not drive along the side of a slope. The vehicle might otherwise rollover. If in doing so the vehicle begins to show a tendency to roll, immediately steer into a line of gravity (straight up or downhill).

Never let the vehicle roll backwards in idle. You may lose control of the vehicle if you use only the service brake. For information on driving downhill, see “Driving downhill”.

Warning!

Sand, dirt, mud and other material having friction property can cause exceptional wear and tear as well as brake failure.

Have the brakes checked for dirt build-up and cleaned. There is otherwise a risk that full braking power may not be available in an emergency.

Warning!

Vehicles with air suspension program: Please be aware that by raising the vehicle level, the center of gravity also rises. Therefore, always ensure that the vehicle level is as low as possible. With higher ride height the ESP® may activate earlier in certain situations.

Familiarize yourself with the vehicle characteristics and gear changing before you attempt any difficult terrain off-road driving. We recommend that you start out with easy off-road travel.

Special driving features for off-road driving

The following driving features are available for specific kind of operation:

- Off-road ABS (▷ page 63)
- Off-road ESP® (▷ page 65)
- Off-road 4-ETS (▷ page 64)
- Hill-start assist system (▷ page 113)
- Downhill Speed Regulation (DSR) (▷ page 152)
- Off-road driving program (▷ page 155)
- Air suspension program (▷ page 155)

Off-road driving rules

- Engage the off-road driving program (▷ page 155) before driving under off-road conditions.
- Vehicles with air suspension program: Make sure you select a vehicle level (▷ page 156) appropriate to the topographical conditions. Always make sure the vehicle has enough ground clearance.
- Fasten items being carried as securely as possible (▷ page 186).
- Always navigate gradients with the engine on and with the transmission engaged in a gear. Switch on the DSR (▷ page 152) to help maintain a preset speed.

Read this chapter carefully before you begin off-road travel.

! Observe the following during off-road driving:

- Keep doors, tailgate, windows, and tilt/sliding sunroof closed whenever driving off-road.
- Adjust vehicle speed to condition of terrain. The more uneven, rutty and steeper the terrain, the lower the speed should be. Drive through water slowly at an even speed, avoiding a bow wave.
- Be especially careful when driving in unknown territory. It may be necessary to get out of the vehicle and scout the path you intend to take.
- Watch out for obstacles, such as rocks, holes, tree stumps and ruts.
- Before driving through water, determine its depth.
- Do not stop vehicle while immersed in water, and do not shut off the engine.
- In sandy soil, drive at a steady speed as allowed by conditions. This helps overcome the vehicle rolling resistance and reduces the likelihood of the vehicle sinking into the ground.
- Do not initiate jumps with the vehicle. It interrupts the forward momentum of the vehicle.
- Always drive onto slopes with the engine running and the vehicle in gear.
- Do not shift automatic transmission into neutral position **N**.

⚠ Warning!

Do not reduce the tire inflation pressure before driving through sand. However, if you do so, remember to correct the tire inflation pressure before continuing your trip. Driving with reduced tire inflation pressure increases the risk of losing control of the vehicle and rolling over.

Checklist before off-road driving

Engine oil level

- Check the engine oil level (▷ page 214). Only with a proper oil level can the vehicle obtain a trouble-free oil supply, even on steep gradients.

! If the engine oil level warning lamp comes on while driving, stop the vehicle in a safe location or as soon as it is safe to do so. Check the engine oil level.

The engine oil level warnings should not be ignored. Extended driving with the symbol displayed could result in serious engine damage that is not covered by the Mercedes-Benz Limited Warranty.

Tires

- Check the tread depth and maintain specified tire inflation pressure. A placard with the recommended tire inflation pressures is located on the driver's door B-pillar (▷ page 228).
- Check tires for possible damage and remove foreign objects.
- Replace missing valve caps.

Rims

- Dented or bent rims can cause tire inflation pressure loss and damage the tire beads. For this reason, check and, if necessary, change rims before driving off-road.

Vehicle tool kit

- Check if the jack (▷ page 270) is functional.
- Always take the vehicle tool kit, a strong tow rope, a shovel and a small plank (to put under the jack on sandy soil) with you.

Driving in steep terrain



Slope angle

- ① Overhang angle, front
- ② Overhang angle, rear

Vehicles with steel suspension	①	① ²¹	②
	27°	22°	26°

Vehicles with air suspension program	①	① ²¹	②
Raised level	31°	25°	29°
Highway	25°	18°	24°

ML 63 AMG	①	②
Raised level	26°	28°
Highway	21°	24°

- Comply with the warnings (▷ page 248) and rules for off-road driving (▷ page 248).
- Driving on embankments, slopes and other steep inclines should only be done straight up or downhill, i.e. in the line of gravity. Maximum vehicle climbing ability is a 100% grade which is equivalent to a slope angle of 45°. Keep in mind that the

climbing ability of the vehicle depends on terrain conditions.

- Shift automatic transmission into gear range **1** (▷ page 113).
- Drive slowly.
- Avoid excessive engine speeds – drive with moderate engine speeds (max. 3000 rpm).
- Utilize the engine’s braking power when descending a slope, observe the engine speed (do not overrev the engine). Apply the service brake as needed.

i For maximum engine speed, see “Tachometer” (▷ page 119) and see vehicle specification for your vehicle (▷ page 348).

- Check the brakes after a lengthy downgrade drive.

⚠ Warning!

Never turn the vehicle around on steep inclines. The vehicle might roll over. If the vehicle cannot complete the attempted climb, back it down in reverse gear.

i The hill-start assist system supports you when driving uphill.

For more information, see “Hill-start assist system” (▷ page 152).

Traction in steep terrain

The maximum vehicle climbing ability is a 100% grade which is equivalent to a slope angle of 45°. Keep in mind that the climbing ability of the vehicle depends on terrain conditions.

Be easy on the accelerator and watch for continuous wheel traction when driving in steep terrain.

i The 4-ETS helps greatly when starting out on a steep incline when the front wheels have then the tendency to slip due to the weight shifting towards the rear axle.

²¹ Vehicles with AMG Sport-Package

The 4-ETS recognizes the situation and limits the torque for the front wheels by braking them.

Simultaneously the torque for the rear wheels is increased.

Driving across a hilltop

Decelerate just ahead of a hilltop (do not shift automatic transmission into neutral position **N**), to prevent the vehicle from speeding up too much after climbing a hill.

Use the momentum of the vehicle to drive across the hilltop.

After climbing a hill, driving in this manner prevents the vehicle from:

- losing ground contact when cresting hills
- losing its forward momentum
- speeding up too much after climbing the hill

Driving downhill

- Drive slowly.
 - Do not drive at an angle to the incline. Steer into the line of gravity and drive with the front wheels pointing straight downhill. Otherwise, the vehicle may slide sideways off the path and roll over.
 - Shift automatic transmission into gear range **1** (▷ page 113).
 - On steep inclines, use the Downhill Speed Regulation (▷ page 152).
 - Utilize the engine's braking power to reduce vehicle speed.
- If this is insufficient, apply the brakes gently. Make sure the vehicle is moving in the line of gravity.
- Check the brakes after a lengthy downgrade drive.

i The special Off-road ABS (▷ page 63) setting allows for precise and brief (cyclical) blocking of the front wheels, permitting them to dig into loose ground.

Remember that, when stopped, the front wheels slide across a surface and thus lose their ability to steer the vehicle.

Driving through water



① Fording depth

Vehicles with steel suspension or air suspension program (raised level) ①

20 in (50 cm)

- Before driving through water, determine its depth.
- ❗ The water depth must not exceed the respective value listed in the table. The ground under the water might not be firm which could result the water being deeper than expected when driving the vehicle through it. Please note that the water level is correspondingly lower for flowing water.
- Vehicles with air suspension program: Select the highest vehicle level possible (▷ page 156).
- Switch to off-road driving program (▷ page 155) before driving through water.
- Shift automatic transmission into gear range **1** or **2** (▷ page 113).
- Avoid high engine speeds.
- Enter and leave the water only at a shallow spot, driving at walking speed.

! Never accelerate before driving into the water. The bow wave could force water into the engine and auxiliary equipment, thus damaging them.

- Drive through the water slowly and at a constant speed.
- Do not stop vehicle while immersed in water, and do not shut off the engine.

! Do not open any of the vehicle's doors while driving through water. Water could otherwise enter the vehicle interior and damage the vehicle's electronics, as well as the interior equipment.

- There is a very high level of driving resistance in water. The surface is slippery and may not be firm, making pulling away in water difficult and dangerous.
- Make sure that only small bow waves are formed when driving the vehicle through water.
- Clean mud off the tire tread after driving through water.
- To dry the brakes, apply pressure to the brake pedal several times while driving after leaving the water.

Crossing obstacles



! Obstacles can damage the vehicle underbody or suspension components. If possible use the assistance of a second person outside the vehicle to scout the path you intend to take and check for

adequate ground clearance when you cross obstacles with your vehicle. The person assisting you outside the vehicle should always be a safe distance away from the vehicle and positioned so that he or she cannot get hurt in case of any unexpected vehicle movement.

After off-road driving or crossing obstacles, inspect vehicle for any damage, especially vehicle underbody and suspension components. Failure to do so can adversely affect the vehicle's future performance, including increased chance of an accident.

When driving over tree stumps, big rocks and other obstacles, observe the following rules:

- Make sure the off-road driving program (▷ page 155) is switched on.
- Avoid high engine speeds.
- Shift automatic transmission into gear range **1** (▷ page 113).
- Check the vehicle clearance before crossing obstacles.
- Cross obstacles (e.g. tree stumps or big rocks) very slowly by aiming one of the front wheels at the center of the obstacle, and repeat same with the rear wheel.

! Special attention is needed when you cross obstacles on a steep incline.

The vehicle could slide sideways as a result of its possible slanted position which in turn may result in the vehicle tipping or rolling over.

Driving on sand

Warning!

Do not reduce the tire inflation pressure before driving through sand. However, if you do so, remember to correct the tire inflation pressure before continuing your trip. Driving with reduced tire inflation pressure increases the risk of losing control of the vehicle and rolling over.

When driving on sand, observe the following rules:

- Vehicles with air suspension program: Set the raised level (▷ page 156).
- Avoid high engine speeds.
- Shift automatic transmission into a gear range that is appropriate for the terrain.
- In sandy soil, drive at a steady speed as conditions permit. This helps overcome the vehicle rolling resistance and reduce the likelihood of the vehicle sinking into the ground.
- Drive in tracks of other vehicles if they are not too deep and you have sufficient clearance.

Ruts

A number of off-road tracks or other byways have deep ruts which can cause the underbody to come in contact with the ground.

- Make sure the off-road driving program (▷ page 155) is switched on.
 - Vehicles with air suspension program: Set the raised level (▷ page 156).
- !** Check that the ruts are not too deep and your vehicle's clearance is sufficient. Otherwise:
- your vehicle may be damaged
 - the underbody of the vehicle may come in contact with the ground and you may get stuck
- Avoid high engine speeds.
 - Shift automatic transmission into gear range **1** (▷ page 113).
 - Drive next to the ruts rather than through them if at all possible.
 - If the ruts are too deep to drive in, drive with one side of the vehicle on the grassy center strip if the route permits.

Returning from off-road driving

Warning!

If you feel a sudden significant vibration or ride disturbance, or you suspect that possible damage to your vehicle has occurred, you should turn on the hazard warning flashers, carefully slow down, and drive with caution to an area which is a safe distance from the road. Inspect the tires and the vehicle underbody for possible damage. If the vehicle or tires appear unsafe, have the vehicle towed to the nearest authorized Mercedes-Benz Center or tire dealer for repairs.

Off-road driving increases strain on the vehicle.

We recommend that you inspect the vehicle for possible damage after each off-road trip. Recognizing any damage and a subsequent timely repair reduces the chance of a possible breakdown or accident later on.

Proceed as follows:

- Switch off the off-road driving program (▷ page 155).
- Switch off the DSR (▷ page 153).
- Vehicles with air suspension program: Lower the vehicle back to a level suitable for road conditions, e.g. highway/high-speed level (▷ page 156).
- Clean all exterior lamps and check for possible damage.
- Clean the front and rear license plate.
- Remove excessive dirt from tires, wheels, wheel housings, and underbody. For instance, after driving in mud, clean the radiator, chassis, engine, brakes, and wheels from extreme dirt using a strong jet of water.
- Check tires for possible damage.
- Inspect vehicle underbody, oil pan, brake hoses, etc., as well as vehicle underbody for possible damage.

- Check for brush or branches caught in the underbody.

! Brush or branches could increase the possibility of a fire, as well as cut fuel and/or brake lines, puncture rubber bellows of the axles or drive shafts.

- After continued operation in mud, sand, water or other dirty conditions clean the brake discs, wheels, brake pads and check and clean axle joints.
- Conduct a brake test.

Trailer towing

Warning!

Failure to use proper equipment and driving technique can result in a loss of vehicle control when towing a trailer.

Improper towing or failure to follow the instructions in this manual can result in vehicle damage and/or serious personal injury. Follow the guidelines below carefully to assure safe trailer operation.

Contact an authorized Mercedes-Benz Center should you require an explanation of information contained in this manual.

Trailer hitch

- Only install a trailer hitch receiver approved for your vehicle.
For information on availability and installation, contact an authorized Mercedes-Benz Center.
- The bumpers on your vehicle are not designed for use with clamp-type hitches. Do not attach rental hitches or other bumper-type hitches to them.
- To reduce the possibility of damage, remove the hitch ball adapter from the receiver when not in use.

Electrical connections

The vehicle is prewired to accept the seven-wire harness included in the Mercedes-Benz approved trailer hitch receiver kit.

- i** A four-pole conversion plug is available from your authorized Mercedes-Benz Center as a spare part.

For further information, contact an authorized Mercedes-Benz Center.

Vehicle and trailer weights and ratings

The Gross Trailer Weight (GTW) is the weight of the trailer plus the weight of all cargo, equipment, luggage, etc. loaded on the trailer. The maximum permissible GTW to be towed:

- Vehicles with 4MATIC: 7 200 lb (3 265 kg)
- Vehicles without 4MATIC: 4 630 lb (2 100 kg)

Trailer Tongue Weight Rating (TWR) is the maximum permissible weight on the trailer tongue:

- Vehicles with 4MATIC: 576 lb (261 kg) limit for Mercedes-Benz approved hitch receiver
- Vehicles without 4MATIC: 370 lb (168 kg) limit for Mercedes-Benz approved hitch receiver

Loading a trailer

- When loading a trailer, you should observe that neither the permissible GTW, nor the Gross Vehicle Weight Rating (GVWR) are exceeded. The GVWR is indicated on the certification label located on the driver's door B-pillar (▷ page 227).
Maximum permissible values are listed on the safety compliance certification labels for the vehicle and for the trailer to be towed.

The lowest value listed must be selected when determining how the vehicle and trailer are loaded.

- The tongue weight at the hitch ball must be added to the rear axle weight to prevent exceeding the rear Gross Axle Weight Rating (GAWR). The GAWR is indicated on the certification label located on the driver's door B-pillar (▷ page 227).

i Mercedes-Benz recommends loading the trailer in such a manner that it has a tongue weight between 8% and 15% of the GTW.

i The weight of other accessories, passengers and cargo will reduce the maximum trailer weight and tongue weight your vehicle can tow.

Checking weights of vehicle and trailer

- To assure that the towing vehicle and trailer are in compliance with the maximum permissible weight limits, have the loaded rig (towing vehicle including driver, passengers and cargo, trailer fully loaded) weighed on a commercial scale.
- Check the vehicle's front and rear gross axle weight, the Gross Trailer Weight (GTW) and tongue weight.

The values as measured must not exceed the weight limits listed under "Vehicle and trailer weights and ratings" (▷ page 254).

Coupling a trailer

Warning!

Vehicles with air suspension program: While you are coupling or decoupling a trailer, make sure nobody locks or unlocks the vehicle and/or opens or closes doors or the tailgate.

The vehicle's level could change and you could endanger yourself and/or others as a result.

Make sure that you do not operate the ADS switch or the vehicle level control system when coupling/decoupling the trailer.

Observe maximum permitted trailer dimensions (width and length).

Most states and all Canadian provinces require

- safety chains between the towing vehicle and the trailer

The chains should be criss-crossed under the trailer tongue. They must be attached to the hitch receiver, and not to the vehicle's bumper or axle.

Make sure to leave enough slack in the chains to permit turning corners.

- a separate brake system at various trailer weights

- a break-away switch on trailers with a separate brake system.

Check with your local state laws for specific requirements.

The switch activates the trailer brakes in the possible event that the trailer might separate from the tow vehicle.

! Do not connect a trailer brake system (if trailer is so equipped) directly to the vehicle's hydraulic brake system, as your vehicle is equipped with antilock brakes. If you do, neither the vehicle's brakes nor the trailer's brakes will function properly.

i The provided vehicle electrical wiring harness for trailer towing has a brake signal wire for hook-up to a brake controller.

▶ Make sure the automatic transmission is in park position **P** (▷ page 110).

▶ Engage the parking brake for the vehicle (▷ page 107).

▶ Start the engine (▷ page 103).

▶ Vehicles with vehicle level control: Select the highway level (▷ page 156).

▶ Vehicles with Adaptive Damping System (ADS):

Set the ADS to **AUTO** or **COMF** (▷ page 156).

▶ Turn off the engine (▷ page 108).

- ▶ Close all doors and the tailgate.
- ▶ Attach the trailer.
- ▶ Plug in all electrical connectors.

i Vehicles with vehicle level control:

When you are towing a trailer, the vehicle level always remains in the highway setting. The following applies additionally when towing a trailer:

- The vehicle is lowered to the highway level when it reaches a speed of 5 mph (8 km/h) if not set to highway level.
- The highspeed level is not available.

The restrictions that apply to towing also apply when using accessories that are connected to the trailer power socket, such as a bicycle rack.

Towing a trailer

There are many different laws, including speed limit restrictions, having to do with trailer towing. Make sure your rig will be legal, not only for where you reside, but also for where you will be driving. A good source for this information can be the police or local authorities.

Note the following, when driving with a trailer:

- In order to gain skill and an understanding of the vehicle's behavior, you should practice turning, stopping and backing up in an area which is free of traffic.
- Before you start driving check the
 - trailer hitch
 - break-away switch
 - safety chains
 - electrical connections
 - lighting
 - tires
- Adjust the mirrors (▷ page 89) to permit unobstructed view beyond rear of trailer.
- If the trailer has electric brakes, start your vehicle and trailer moving slowly, and then

apply only the trailer brake controller by hand to make sure the brakes are working properly.

- Always secure items in the trailer to prevent load shifts while driving.
- When towing a trailer, check occasionally to make sure the load is secure, and that trailer lighting and brakes (if so equipped) are functioning properly.
- Take into consideration that when towing a trailer, the handling characteristics are different and less stable from those when operating the vehicle without a trailer. It is important to avoid sudden maneuvers.
- The vehicle and trailer combination is heavier, and therefore limited in acceleration and climbing ability, and has a larger braking distance.

It is more prone to reacting to cross wind gusts, and requires more sensitive steering input.

- If possible, do not brake abruptly, but rather engage the brake slightly at first to permit the trailer to activate its brake. Then increase the braking force.

! If the trailer should begin to sway, reduce the vehicle's speed immediately.

Do not attempt to straighten out the tow vehicle and trailer by increasing the speed.

- If the transmission shifts between gears on inclines repeatedly, shift to a lower gear range manually (▷ page 113). Select **4, 3, 2** or **1**.

A lower gear and reduction of speed reduces the chance of engine overloading and/or overheating.

- On very steep inclines, not manageable with automatic transmission in gear range **1**, switch on off-road driving program (▷ page 155).
- When going down an incline, shift into a lower gear and use the engine's braking effect.

Avoid riding the brakes, thus overheating the vehicle and trailer brakes (if so equipped).

- If the engine coolant rises to an extremely high temperature when the air conditioning is on, turn off the air conditioning system. Engine coolant heat can be additionally vented by opening the windows, switching the climate control fan speed to high and setting the temperature control to the maximum.
- During a passing maneuver extreme care must be exercised since your vehicle with a trailer will require additional passing distance ahead than when driving without a trailer.

Because your vehicle and trailer is longer than your vehicle alone, you will also need to go much farther ahead of the passed vehicle before you can return to your lane.

Decoupling a trailer

Warning!

Vehicles with air suspension program: While you are coupling or decoupling a trailer, make sure nobody locks or unlocks the vehicle and/or opens or closes doors or the tailgate.

The vehicle's level could change and you could endanger yourself and/or others as a result.

Make sure that you do not operate the ADS switch or the vehicle level control system when coupling/decoupling the trailer.

- ▶ Make sure the automatic transmission is in park position **P** (▷ page 110).
- ▶ Engage the parking brake for the vehicle (▷ page 107).
- ▶ Start the engine (▷ page 103).
- ▶ Close all doors and the tailgate.
- ▶ Engage the parking brake for the trailer.

Warning!

Vehicles with air suspension program: As soon as you disconnect the electrical connection between the trailer and the vehicle, the vehicle will lower. To help avoid personal injury, make sure no one is near the wheel housing or underneath the vehicle before the electrical connection is disconnected.

When you decouple the trailer, the vehicle is temporarily raised because the springs are relieved of load. Be especially careful during this process, as you could otherwise injure yourself and/or others. Make sure that any persons remaining in the vehicle do not press the switches for vehicle level control or the ADS.

- ▶ Disconnect all electrical plug connectors.
- ▶ Decouple the trailer.
- ▶ Make sure that the trailer coupling is free of load.
- ▶ Turn off the engine (▷ page 108).

Driving abroad

If you plan to drive the vehicle outside the U.S. or Canada, you should request dealer network information for your destination from any authorized Mercedes-Benz Center.

Control and operation of radio transmitter

Safety notes

Warning!

Please do not forget that your primary responsibility is to drive the vehicle. A driver's attention to the road must always be his/her primary focus when driving. For your safety and the safety of others, we recommend that you pull over to a safe location and stop before placing or taking a telephone call.

If you choose to use the telephone²² while driving, please use the hands-free device and only use the telephone when road, weather and traffic conditions permit. Some jurisdictions prohibit the driver from using a mobile telephone while driving a vehicle.

Only operate the COMAND²² (Cockpit Management and Data System) if road, weather and traffic conditions permit. Otherwise, you may not be able to observe traffic conditions and could endanger yourself and others.

Bear in mind that at a speed of just 30 mph (approximately 50 km/h), your vehicle is covering a distance of 44 feet (approximately 14 m) every second.

Emission control

Certain systems of the engine serve to keep the toxic components of the exhaust gases within permissible limits required by law.

These systems will function properly only when maintained strictly according to factory specifications. Any adjustments on the engine should, therefore, be carried out only by qualified Mercedes-Benz Center authorized technicians.

Engine adjustments should not be altered in any way. Moreover, the specified service procedures must be carried out regularly according to Mercedes-Benz servicing requirements. For details refer to the Maintenance Booklet.

Warning!

Inhalation of exhaust gas is hazardous to your health. All exhaust gas contains carbon monoxide (CO), and inhaling it can cause unconsciousness and possible death.

Do not run the engine in confined areas (such as a garage) which are not properly ventilated. If you think that exhaust gas fumes are entering the vehicle while driving, have the

cause determined and corrected immediately. If you must drive under these conditions, drive only with at least one window fully open at all times.

Maintenance

Notes

The Maintenance System in your vehicle tracks the distance driven and the time elapsed since the last maintenance service. It calculates other maintenance service work required, and calls for the next maintenance service accordingly.

We strongly recommend that you have your vehicle serviced at an authorized Mercedes-Benz Center. Have it serviced in accordance with the Maintenance Booklet at the times called for by the maintenance service indicator.

-  Failure to have the vehicle maintained in accordance with the Maintenance Booklet and maintenance service indicator at the designated times/mileage will result in vehicle damage not covered by the Mercedes-Benz Limited Warranty.

Maintenance service indicator message

Information on maintenance work and maintenance intervals are specified in the Maintenance Booklet. Contact an authorized Mercedes-Benz Center, or visit www.mbusa.com (USA only) for additional information.

The maintenance service indicator message will notify you when the next maintenance service is required.

Starting approximately 1 month before the next maintenance service is required, one of the following messages will appear in the multifunction display. The messages will

²² Observe all legal requirements.

appear while you are driving or when you switch on the ignition (example service A):

Service A In XXXXX Miles (km)

Service A In XX Days

Service A In X Day

Service A Due Now

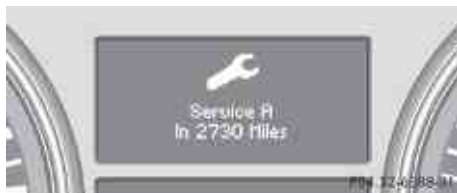

Refer to Maintenance Booklet for a listing of maintenance services and intervals they need to be performed at.

Clearing the maintenance service indicator message

The maintenance service indicator message is cleared automatically

- after approximately 10 seconds when you switch on the ignition
- after approximately 10 seconds when reaching the service threshold while driving
- after approximately 30 seconds, once the suggested maintenance service term has passed



- ▶ **Clearing the maintenance service indicator message manually:** Press reset button ① on the instrument cluster. The standard display appears in the multifunction display.

Maintenance service term exceeded

If you have exceeded the suggested maintenance service term, you will see the following message in the multifunction display:

Service A Exceeded By XXXXX Miles (Km)

Service A Exceeded By XXX Days

Service A Exceeded By X Day

In addition, a signal sounds when the message appears.

Any authorized Mercedes-Benz Center will reset the maintenance service indicator following a completed maintenance service.

Calling up the maintenance service indicator display

- ① The menu overview can be found on (▷ page 121).

You can call up the maintenance service indicator display at any time to check when the next maintenance service is required.

- ▶ Switch on the ignition.
- ▶ Press button or on the multifunction steering wheel repeatedly until the standard display (▷ page 122) appears in the multifunction display.
- ▶ Press button or on the multifunction steering wheel until the maintenance service indicator display with the service symbol and the maintenance service deadline appears in the multifunction display.

- ① If the battery was disconnected, the days of disconnection will not be included in the count shown by the maintenance service indicator. To arrive at the true maintenance service deadline, you will need to subtract these days from the days shown in the maintenance service indicator message or maintenance service indicator display.

Do not confuse the maintenance service indicator with the engine oil level indicator



Resetting the maintenance service indicator

In the event that the maintenance service on your vehicle is not carried out at an authorized Mercedes-Benz Center, you can have the maintenance service indicator reset.

The automotive maintenance facility carrying out the maintenance service will find the information for resetting the maintenance service indicator in the maintenance-relevant literature for your vehicle.

Such literature is available at any authorized Mercedes-Benz Center or directly from Mercedes-Benz.

! If the maintenance service indicator was reset inadvertently, have an authorized Mercedes-Benz Center correct it.

Only reset the maintenance service indicator if the proper maintenance service has been performed. Not following the proper maintenance service as described in the Maintenance Booklet will result in engine damage and/or other vehicle damage not covered by the Mercedes-Benz Limited Warranty.

Vehicle care

Cleaning and care of the vehicle

Notes

Regular and proper care will help to maintain the value of your vehicle.

Warning!

Many cleaning products can be hazardous. Some are poisonous, others are flammable. Always follow the instructions on the particular container. Always open your

vehicle's doors or windows when cleaning the inside.

Never use fluids or solvents that are not designed for cleaning your vehicle.

Always lock away cleaning products and keep them out of reach of children.

! When cleaning the vehicle, do not use scouring agents. Never apply strong force and only use a soft, wet cloth or sponge. Otherwise you may scratch or damage the surface to be cleaned.

While in operation, even while parked, your vehicle is subjected to varying external influences which, if gone unchecked, can attack the paintwork as well as the vehicle underbody and cause lasting damage.

Such damage is caused not only by extreme and varying climatic conditions, but also by:

- Air pollution
- Road salt
- Tar
- Gravel and stone chipping

To avoid paint damage, you should immediately remove:

- Grease and oil
- Fuel
- Coolant
- Brake fluid
- Bird droppings
- Insects
- Tree resins etc.

Frequent washing reduces and/or eliminates the aggressiveness and potency of the above adverse influences.

More frequent washings are necessary to deal with unfavorable conditions:

- near the ocean
- in industrial areas (smoke, exhaust emissions)
- during winter operation

You should check your vehicle from time to time for stone chipping or other damage. Any damage should be repaired as soon as possible to prevent corrosion.

In doing so, do not neglect the underbody of the vehicle. A prerequisite for a thorough check is a washing of the underbody followed by a thorough inspection. Damaged areas need to be re-undercoated.

Your vehicle has been treated at the factory with a wax-base rustproofing in the body cavities which will last for the lifetime of the vehicle. Post-production treatment is neither necessary nor recommended by Mercedes-Benz because of the possibility of incompatibility between materials used in the production process and others applied later. We have selected vehicle-care products and compiled recommendations which are specially matched to our vehicles and which always reflect the latest technology. You can obtain Mercedes-Benz approved vehicle-care products at an authorized Mercedes-Benz Center.

Scratches, corrosive deposits, corrosion or damage due to negligent or incorrect care cannot always be removed or repaired with the vehicle-care products recommended here. In such cases it is best to seek aid at an authorized Mercedes-Benz Center.

The following topics deal with the cleaning and care of your vehicle and give important “how-to” information as well as references to Mercedes-Benz approved vehicle-care products.

Power washer

! Follow the instructions provided by the power washer manufacturer on maintaining a distance between the vehicle and the nozzle of the power washer.

Never use a round nozzle to power-wash tires. The intense jet of water can result in damage to the tire.

Always replace a damaged tire.

Always keep the jet of water moving across the surface. Do not aim directly at electrical parts, electrical connectors, seals, or other rubber parts.

- i** Vehicles with KEYLESS-GO:
If a door handle is hit by a strong jet of water, and a SmartKey is within approximately 3 ft (1 m) of the vehicle, it could be inadvertently locked or unlocked.

Tar stains

Quickly remove tar stains before they dry and become more difficult to remove. A tar remover is recommended.

Paintwork, painted body components

! Affixing stickers, magnets, adhesive tape or similar materials to painted body components may damage the paintwork.

Mercedes-Benz approved Paint Care should be applied when water drops on the paint surface do not “bead up”. This should normally be done every 3 to 5 months, depending on the climate and washing detergent used.

Mercedes-Benz approved Paint Cleaner should be applied if the paint surface shows signs of embedded dirt (i.e. loss of gloss).

Do not apply any of these products or wax if your vehicle is parked in the sun or if the hood is still hot.

- Use the appropriate MB-Touch-Up Stick for quick and provisional repairs of minor paint

damage (i.e. chips from stones, vehicle doors, etc.).

Engine cleaning

Prior to cleaning the engine compartment, make sure to protect electrical components and connectors from contact with water and cleaning agents.

Corrosion protection, such as MB Anticorrosion Wax should be applied to the engine compartment after every engine cleaning. Before applying, all control linkage bushings and joints should be lubricated. The poly-V-belt and all pulleys should be protected from any wax.

Vehicle washing

In the winter, thoroughly remove all traces of road salt as soon as possible.

When washing the vehicle underbody, do not forget to clean the inner sides of the wheels.

- i** Vehicles with KEYLESS-GO:
If a door handle is hit by a strong jet of water, and a SmartKey is within approximately 3 ft (1 m) of the vehicle, it could be inadvertently locked or unlocked.

Hand-wash

- ▶ Do not use hot water or wash your vehicle in direct sunlight.
- ▶ Only use a soft, wet cloth or sponge to clean the vehicle.
- ▶ Only use a mild vehicle wash detergent, such as Mercedes-Benz approved Car Shampoo.
- ▶ Thoroughly spray the vehicle with a diffused jet of water.
- ▶ Do not spray directly towards the ventilation intake.
- ▶ Use plenty of water and rinse the sponge and chamois frequently.
- ▶ Rinse with clean water and dry with a chamois thoroughly.

Do not allow cleaning agents to dry on the finish.

Automatic car wash

You can have your vehicle washed in an automatic car wash from the start. Brushless car washes are preferable.

- ▶ To protect the filter system, activate the air recirculation mode using button  on the climate control panel.

! Do not clean your vehicle in an automatic touchless car wash which uses caustic spray. Caustic spray will damage the paint or ornamental moldings.

If the vehicle is very dirty, prewash it before running it through the automatic car wash.

! Make sure the combination switch is set to wiper setting . Otherwise, the rain sensor could activate and cause the wipers to move unintentionally. This may lead to vehicle damage.

Due to the width of the vehicle, fold in exterior rear view mirrors prior to running the vehicle through an automatic car wash to prevent damage to the mirrors.

- ▶ **When taking the vehicle through an automatic conveyor-type car wash:**
Make sure the automatic transmission remains in neutral position **N**. Observe instructions, see “Remaining in neutral position **N**” (▷ page 111).

When leaving the automatic car wash, make sure the mirrors are folded out.

After running the vehicle through an automatic car wash, wipe any wax off of the windshield and the wiper blade inserts. This will prevent smears and reduce wiping noise which can be caused by residual wax on the windshield.

Ornamental moldings

- ▶ For regular cleaning and care of ornamental moldings, use a damp cloth.

! Do not use chrome cleaner on ornamental moldings. Although ornamental moldings may have chrome appearance, they could be made of anodized aluminum that will be damaged when cleaned with chrome cleaner. Instead, use a damp cloth to clean those ornamental moldings.

For very dirty ornamental moldings of which you are sure are chrome-plated, use a chrome cleaner. If in doubt whether an ornamental molding is chrome-plated, contact an authorized Mercedes-Benz Center.

Headlamps, brake lamps, tail lamps, side markers, turn signal lenses

► Use a mild vehicle wash detergent, such as Mercedes-Benz approved Car Shampoo, with plenty of water.

! Only use window cleaning solutions that are suitable for plastic lamp lenses. Window cleaning solutions which are not suitable may damage the plastic lamp lenses of the headlamps. Therefore, do not use abrasives, solvents or cleaners that contain solvents.

Cleaning the driving systems sensors

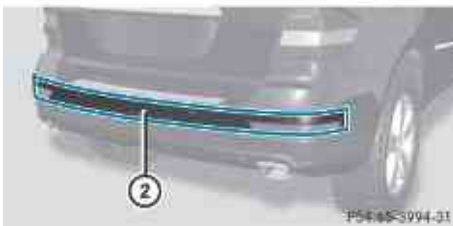
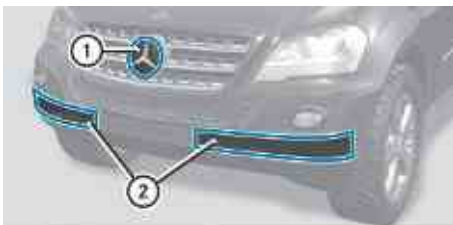

► Switch off the ignition.

► Clean Distronic system sensor cover ① by hand.

To clean Distronic system sensor cover ① and the bumper area near sensors ② observe the following:

- Use a mild vehicle wash detergent, such as Mercedes-Benz approved Car Shampoo, with plenty of water.
- Use a soft, non-scratching cloth.

! If you use a power washer to clean the sensor covers, observe the following:

- Follow the instructions provided by the power washer manufacturer.
- Maintain a distance between the sensor covers and the nozzle of the power washer.

Cleaning the rear view camera lens



► Only use clean water and a soft, non-scratching cloth to clean rear view camera lens ①.

Be careful not to apply wax to rear view camera lens ① when waxing the vehicle. If necessary, remove the wax using the Mercedes-Benz approved Car Shampoo with plenty of water.

- ❗ Do not clean the camera and the area around the camera
 - with a high-pressure cleaner
 - with a dry cloth and strong pressure
 - with aggressive cleaning agents
 You could otherwise damage the camera.

Cleaning the windows and the wiper blades

- ❗ Never open the hood when the wiper arms are folded forward.

Warning!

For safety reasons, switch off wipers and remove SmartKey from starter switch before cleaning the windshield and/or the wiper blades. Vehicles with KEYLESS-GO: Make sure the vehicle's on-board electronics have status **0**. Otherwise, the wiper motor could suddenly turn on and cause injury.

- ❗ Do not pull on the wiper blade inserts. They could tear.
- ▶ Fold the wiper arms forward until they snap into place.
- ▶ Clean the windshield and the wiper blade inserts with a clean cloth and mild detergent solution.
- ▶ Use a soft, clean cloth and a mild window cleaning solution on all outside and inside glass surfaces.
An automotive glass cleaner is recommended.

- ❗ Fold the windshield wiper arms back onto the windshield before turning the SmartKey in the starter switch or pressing the KEYLESS-GO start/stop button.
Hold on to the wiper when folding the wiper arm back. If released, the force of the impact from the tensioning spring could crack the windshield.

- ❗ To clean the window interior, do not use a dry cloth, abrasives, solvents or cleaners

containing solvents. Do not touch the inside of the windows with hard objects such as an ice scraper or ring. Doing so may damage the windows.

Light alloy wheels

If possible, clean wheels once a week.

- ▶ Use Mercedes-Benz approved Wheel Care, a soft bristle brush and a strong spray of water for cleaning the light alloy wheels.

- ❗ Only use acid-free cleaning materials. Acid may cause corrosion or damage the clear coat.

- ❗ The vehicle should not be parked for an extended period of time immediately after it has been cleaned. This applies especially after the wheel rims have been cleaned with wheel rim cleaner. Wheel rim cleaners can lead to increased corrosion of the brake disks and brake pads. Non-approved wheel cleaners may also damage the wheel paint if the vehicle is not driven after cleaning.

Therefore, the vehicle's brake system should always be warmed-up before it is parked after cleaning. Drive your vehicle for several minutes to allow the brakes to dry. When applying Mercedes-Benz approved Tire Care and Mercedes-Benz approved Wheel Care products, take care not to spray them on the brake disks.

Plastic and rubber parts

- ▶ Use a gentle dishwashing detergent or mild detergent for delicate fabrics as a washing solution.
- ▶ Wipe with a cloth moistened in a lukewarm solution.
The surface may temporarily change color. If this is the case, wait for it to dry.

Warning!

Do not use cleaners or cockpit care sprays containing solvents to clean the cockpit or the

steering wheel. Cleaners containing solvents will make the surface porous and vehicle occupants could suffer serious injuries from plastic parts coming loose in the event of air bag deployment.

- ❗ Do not use oil, wax or scouring agents. Otherwise you may scratch or damage the surface.

Hard plastic trim items

- ▶ Use Mercedes-Benz approved Interior Care on a soft, lint-free cloth and apply with light pressure.

COMAND display

- ❗ You must switch off the COMAND display and allow it to cool prior to cleaning.
- ❗ Do not use any liquids or cleaning agents. These can damage or even destroy the COMAND display screen.
- ▶ Use a standard microfiber cloth and apply with light pressure.

Steering wheel

- ▶ Wipe with a damp cloth and dry thoroughly or clean with Mercedes-Benz approved Leather Care.

Carpets

- ▶ Use Mercedes-Benz approved Carpet and Fabric Care for cleaning the carpets.

Headliner

- ▶ Use a soft bristle brush or a dry-shampoo cleaner in case of excessive dirt.

Seat belts

- ▶ Only use clear, lukewarm water and soap.
- ❗ The seat belts must not be treated with chemical cleaning agents. Do not dry the

seat belts at temperatures above 176°F (80°C) or in direct sunlight.

Warning!

Do not bleach or dye seat belts as this may severely weaken them. In a crash they may not be able to provide adequate protection.

Upholstery

Using aftermarket seat covers or wearing clothing that have the tendency to give off coloring (e.g. when wet, etc.) may cause the upholstery to become permanently discolored. By lining the seats with a proper intermediate cover, contact-discoloration will be prevented.

Warning!

Only use seat or head restraint covers which have been tested and approved by Mercedes-Benz for your vehicle model.

Using other seat or head restraint covers may interfere with or prevent

- deployment of the front side impact air bags
- deployment of the rear side impact air bags
- activation of the NECK-PRO active front head restraints

Contact an authorized Mercedes-Benz Center for availability.

Leather upholstery

Please note that leather upholstery is a natural product and is therefore subject to a natural aging process. Leather upholstery may also react to certain ambient influences such as high humidity or high temperature by showing wrinkles for example.

- ▶ Wipe leather upholstery with a damp cloth and dry thoroughly or clean with Mercedes-Benz approved Leather Care.

- ❗ To avoid damage to leather upholstery:
 - Wipe with light pressure only.
 - Do not clean with abrasive cleaning agents such as scouring milk or powder.
 - Do not soak the leather upholstery.
As leather is a natural product, it could otherwise harden or become porous.
 - Exercise particular care when cleaning perforated leather as its underside should not become wet.

MB Tex upholstery

- ▶ Use Mercedes-Benz approved Interior Care onto a soft, lint-free cloth and apply with light pressure for cleaning the upholstery.

Wood trims

- ▶ Only use water and a damp cloth to clean wood trims in your vehicle.
- ❗ Do not use solvents like tar remover or wheel cleaner nor polishes or waxes as these may be abrasive.

Chrome-plated exhaust tip

Regular cleaning and care of chrome-plated exhaust tips will help to maintain their shine and the classy appearance.

- ▶ Use Mercedes-Benz approved Chrome Polishing Paste each time the vehicle has been washed, especially during the winter.
- ❗ Do not use alkaline cleaners such as wheel cleaners as they could cause corrosion.

Vehicle equipment	268
Where will I find ...?	268
Vehicle status messages in the multifunction display	272
What to do if	297
Unlocking/locking manually	306
Resetting activated NECK-PRO active front head restraints	309
Replacing SmartKey batteries	309
Replacing bulbs	311
Replacing wiper blades	318
Flat tire	319
Bleeding the fuel system (diesel engine only)	331
AdBlue® (diesel engine only)	331
Battery	334
Jump starting	336
Towing the vehicle	338
Fuses	342



Vehicle equipment

- i** This Operator's Manual describes all features, standard or optional, potentially available for your vehicle at the time of purchase. Please be aware that your vehicle might not be equipped with all features described in this manual.

Where will I find ...?

First aid kit

- i** Check expiration dates and contents for completeness at least once a year and replace missing/expired items.

The first aid kit is located on the driver's side in the cargo compartment behind the cover.

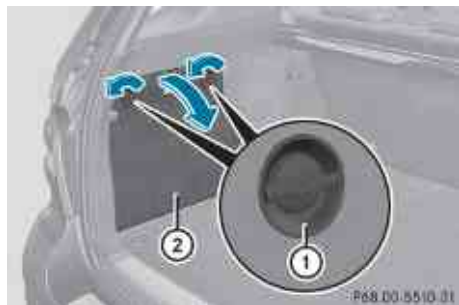

- ▶ Turn lock ① by 90° in direction of the arrow.
 - ▶ Fold down cover ②.
- The first aid kit can be removed.

Vehicle tool kit

The vehicle tool kit is located in the space underneath the cargo compartment floor.

The vehicle tool kit includes:

- Alignment bolt²³
 - Collapsible wheel chock²³
 - Electric air pump²⁴
 - Fuse chart
 - Jack²³
 - Reversible ratchet for jack²³
 - TIREFIT kit²⁵
 - Towing eye bolt
 - Wheel wrench²³
 - Spare wheel bolts²⁶
- ▶ **Removing:** Open the tailgate (▷ page 75).

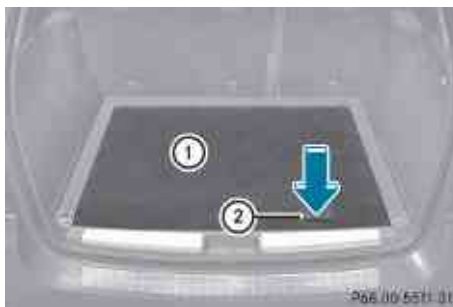

- ▶ Push in floor handle ② as indicated by arrow.
- ▶ Lift cargo compartment floor ① using floor handle ②.

²³ Vehicles with spare wheel only.

²⁴ ML 350 BlueTEC 4MATIC (Canada vehicles) factory equipped with 20" wheels and vehicles with spare wheel with collapsible tire only.

²⁵ ML 350 BlueTEC 4MATIC (Canada vehicles) factory equipped with 20" wheels only.

²⁶ Vehicles with Minispare wheel only.



- ▶ Release securing hook (3) (located below the floor handle) from holder.

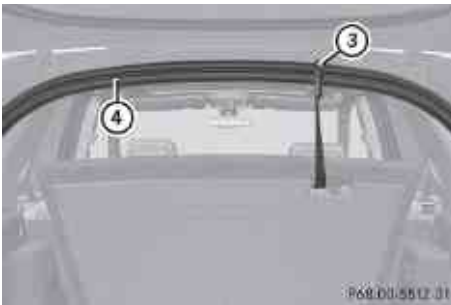

- ▶ Engage securing hook (3) on upper cargo compartment lip (4).

! With the cargo compartment cover blind installed behind the rear seats, disengage cargo compartment cover blind and flip it forward. Otherwise the strap of the securing hook could damage the cargo compartment cover blind.

! To prevent damage, always disengage the securing hook from upper cargo compartment lip and lower the cargo compartment floor before closing the tailgate.

Vehicles without spare wheel

- i** Vehicles without spare wheel are not factory-equipped with the tools required for

a wheel change such as a jack or a wheel wrench. Some tools required for a wheel change are specific to your vehicle. Contact an authorized Mercedes-Benz Center to obtain the tools approved for your vehicle. The illustration shows the vehicle retrofitted with the necessary tools for a wheel change.

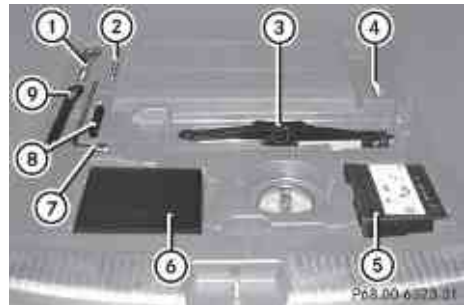

- ① Towing eye bolt
- ② Alignment bolt
- ③ Jack
- ④ Fuse chart
- ⑤ Electric air pump²⁷
- ⑥ TIREFIT kit²⁷
- ⑦ Wheel wrench
- ⑧ Collapsible wheel chock
- ⑨ Reversible ratchet for jack

²⁷ ML 350 BlueTEC 4MATIC (Canada vehicles) factory equipped with 20" wheels only.

Vehicles with spare wheel

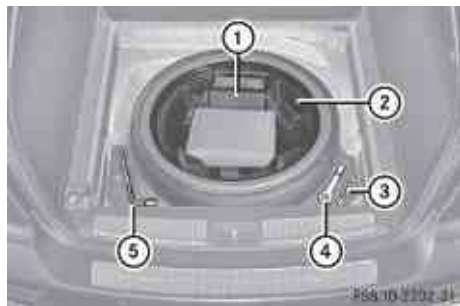

Example illustration

- ① Electric air pump²⁸
- ② Storage well casing
- ③ Alignment bolt
- ④ Towing eye bolt
- ⑤ Wheel wrench

- ▶ **To access remaining tools:** Remove storage well casing ② (if so equipped).
- ▶ Remove the spare wheel (▷ page 271).



Example illustration

- ⑥ Jack
- ⑦ Collapsible wheel chock
- ⑧ Fuse chart
- ⑨ Spare wheel bolts²⁹
- ⑩ Reversible ratchet for jack

Collapsible wheel chock

The collapsible wheel chock serves to secure the vehicle, e.g. while changing a wheel.

- ▶ Take the collapsible wheel chock from the vehicle tool kit (▷ page 268).

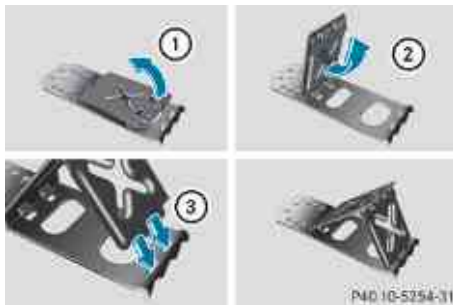

- ▶ **Setting up:** Tilt both plates upward ①.
- ▶ Fold the lower plate outward ②.
- ▶ Guide the tabs of the lower plate all the way into the openings of base plate ③.

For information on where to place wheel chocks when changing a wheel, see “Lifting the vehicle” (▷ page 324).

Jack

⚠ Warning!

Only use the jack supplied with your vehicle to lift the vehicle briefly for wheel changes. If you use the jack for any other purpose, you or others could be injured, as the jack is designed only for the purpose of changing a wheel.

When using the jack, observe the safety notes in the “Mounting the spare wheel” section and the notes on the jack.

- ▶ Take the jack from the vehicle tool kit (▷ page 268).

²⁸ Vehicles with spare wheel with collapsible tire only.

²⁹ Vehicles with Minispare wheel only.



Storage position

- ▶ Take the reversible ratchet from the vehicle tool kit (▷ page 268).

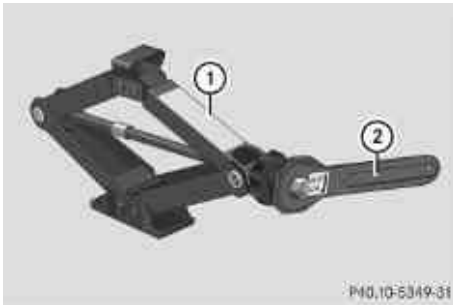

Operational position

- ▶ Attach reversible ratchet ② to jack ① in such a way that the word **UP** can be seen.

Before placing the jack and the reversible ratchet back into the vehicle kit:

- ▶ Fully collapse the jack (storage position).
- ▶ Remove the reversible ratchet.

Spare wheel

 **Observe Safety notes, see page 319.**

- i** USA only:
The ML 350 BlueTEC 4MATIC does not have a spare wheel.
- i** Canada only:
The ML 350 BlueTEC 4MATIC does not have a spare wheel. ML 350 BlueTEC 4MATIC

vehicles that are factory equipped with 20" wheels come with TIREFIT.

The spare wheel is located in the space underneath the cargo compartment floor.

- ▶ **Removing:** Open the tailgate (▷ page 75).
- ▶ Lift the cargo compartment floor and secure it on the upper cargo compartment lip (▷ page 268).

! To prevent damage, always disengage the securing hook from upper cargo compartment lip and lower the cargo compartment floor before closing the tailgate.

- ▶ Remove the storage well casing (if so equipped) (▷ page 270).

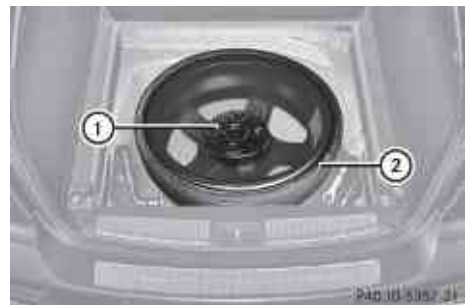

Example illustration

- ▶ Remove retaining screw ① by turning it counterclockwise.
- ▶ Remove spare wheel ②.

For information on mounting the spare wheel, see "Flat tire" (▷ page 319).

Storing the spare wheel after use

- ▶ Place spare wheel ② into the spare wheel well (▷ page 271).
- ▶ Secure spare wheel ② by turning retaining screw ① clockwise (▷ page 271).
- ▶ Place the storage well casing (if so equipped) into the spare wheel (▷ page 270).

Vehicle status messages in the multifunction display

Notes





Warning and malfunction messages appear in the multifunction display located in the instrument cluster.





Certain warning and malfunction messages are accompanied by an audible signal.

Address these messages accordingly and follow the additional instructions given in this Operator's Manual.

Selecting the **Vehicle status message memory** menu in the control system (▷ page 128) displays both cleared and uncleared messages.

High-priority messages appear in the multifunction display in red color.

Certain messages of high priority cannot be cleared from the multifunction display using the reset button (▷ page 118) or button , ,  or  on the multifunction steering wheel.

Other messages of high priority and messages of less immediate priority can be cleared from the multifunction display using the reset button or button , ,  or  on the multifunction steering wheel. They are then stored in the **Vehicle status message memory** menu (▷ page 128). Remember that clearing a message will only make the message disappear. Clearing a message will not correct the condition that caused the message to appear.

Warning!

All categories of messages contain important information which should be taken note of

and, where a malfunction is indicated, addressed as soon as possible at an authorized Mercedes-Benz Center.

Failure to repair the condition noted may cause damage not covered by the Mercedes-Benz Limited Warranty, or result in property damage or personal injury.

Warning!

No messages will be displayed if either the instrument cluster or the multifunction display is inoperative.

As a result, you will not be able to see information about your driving conditions, such as

- speed
- outside temperature
- warning/indicator lamps
- malfunction/warning messages
- failure of any systems

Driving characteristics may be impaired.

If you must continue to drive, do so with added caution. Contact an authorized Mercedes-Benz Center as soon as possible.

Warning!

HYBRID vehicles: It is imperative that you read the HYBRID Supplemental Operating Instructions included in your vehicle literature portfolio. You may otherwise not recognize potential danger.



On the pages that follow, you will find a compilation of the most important warning and malfunction messages that may appear.



For your convenience the messages are divided into text messages (▷ page 273) and symbol messages (▷ page 283).

Text messages

Safety systems

Display messages		Possible causes/consequences and ► Solutions
ABS	ABS, ESP Inoperative See Operator's Manual	<p>The brake system is still functioning normally but due to a malfunction, the ABS, the BAS, the ESP®, and the PRE-SAFE® system are unavailable.</p> <ul style="list-style-type: none"> ► Continue driving with added caution. Wheels may lock during hard braking, reducing steering capability. ► Have the system checked at an authorized Mercedes-Benz Center as soon as possible. <p>Failure to follow these instructions increases the risk of an accident.</p>
ABS	ABS, ESP Unavailable See Operator's Manual	<p>The self-diagnosis may not be completed yet.</p> <p>The display will clear after driving a short distance at a vehicle speed of above 12 mph (20 km/h).</p>
ABS	ABS, ESP Unavailable See Operator's Manual	<p>The brake system still functions normally but due to insufficient power supply, the ABS, the BAS, the ESP®, and the PRE-SAFE® system are unavailable.</p> <p>When the voltage is above the required value again, the ABS, the BAS, the ESP®, and the PRE-SAFE® system are operational again and the message should disappear.</p> <ul style="list-style-type: none"> ► If the message does not disappear: Have the system checked at an authorized Mercedes-Benz Center as soon as possible.
ESP	Inoperative See Operator's Manual	<p>In addition, the yellow ESP® warning lamp  comes on.</p> <p>The brake system is still functioning normally but due to a malfunction the BAS, the ESP®, and the PRE-SAFE® system are unavailable.</p> <p>The ABS may not be operational.</p> <ul style="list-style-type: none"> ► Continue driving with added caution. Wheels may lock during hard braking, reducing steering capability. ► Have the system checked at an authorized Mercedes-Benz Center as soon as possible. <p>Failure to follow these instructions increases the risk of an accident.</p>



Display messages		Possible causes/consequences and ► Solutions
ESP	Unavailable See Operator's Manual	<p>The brake system still functions normally but due to insufficient power supply the ESP[®], the BAS, and the PRE-SAFE[®] system are unavailable.</p> <p>► Continue driving with added caution. Wheels may lock during hard braking, reducing steering capability.</p> <p>When the voltage is above the required value again, the ESP[®], the BAS, and the PRE-SAFE[®] system are operational again and the message in the multifunction display should disappear.</p> <p>If the message in the multifunction display does not disappear:</p> <ul style="list-style-type: none"> ► Have the alternator and the battery checked. ► Have the system checked at an authorized Mercedes-Benz Center as soon as possible.
ESP	Unavailable See Operator's Manual	<p>If the yellow ESP[®] warning lamp  flashes while driving and this message appears, the Electronic Traction System (ETS/4-ETS) has switched off to prevent overheating of the drive wheel brakes.</p> <p>As soon as the brakes have cooled off, the Electronic Traction System (ETS/4-ETS) switches on again.</p> <p>The message in the multifunction display disappears and the ESP[®] warning lamp  goes out.</p>
ESP	Unavailable See Operator's Manual	<p>The self-diagnosis may not be completed yet.</p> <p>The display will clear after driving a short distance at a vehicle speed of above 12 mph (20 km/h).</p>
PRE-SAFE	Inoperative See Operator's Manual	<p>The PRE-SAFE[®] system has failed. All other occupant safety systems, such as the air bags, are still available.</p> <p>► Contact an authorized Mercedes-Benz Center as soon as possible.</p>

Display messages	Possible causes/consequences and ► Solutions
Front Passenger Airbag Enabled See Operator's Manual	<p>USA only:</p> <p>The front passenger front air bag is activated while driving even though a child, small individual, or object below the system's weight threshold is on the front passenger seat, or the front passenger seat is empty. Objects on the seat or forces acting on the seat may make the system sense supplemental weight.</p> <ul style="list-style-type: none"> ► Stop the vehicle in a safe location as soon as possible. ► Engage the parking brake. ► Switch off the ignition. ► Open the front passenger door. ► Remove child and child restraint from front passenger seat and properly secure the child in rear seat employing the child restraint if necessary. ► Remove any other items from on and around the front passenger seat and make sure the parcel net on the back of the front passenger seat is empty. ► Make sure no objects which apply forces to the seat are present (e.g. objects such as books, briefcases etc. lodged behind or around the seat, head restraints pushing against roof etc.). The system may recognize such forces as supplemental weight and sense that an occupant on the front passenger seat is of a greater weight than actually present. ► Keep the seat unoccupied, close the front passenger door and switch on the ignition. <p>Monitor the  PASS AIR BAG OFF indicator lamp in the center console (► page 45) and the multifunction display in the instrument cluster (► page 28) for the following:</p> <p>With the seat unoccupied and the ignition switched on,</p> <ul style="list-style-type: none"> • the  PASS AIR BAG OFF indicator lamp in the center console should illuminate and remain illuminated, indicating that the OCS (► page 42) has deactivated the front passenger front air bag. • the message Front Passenger Airbag Enabled See Operator's Manual or the message Front Passenger Airbag Disabled See Operator's Manual should not appear in the multifunction display at any time the seat is unoccupied. Wait at least 60 seconds for the system to complete the necessary check cycles and to make sure neither message appears in the multifunction display.

Display messages	Possible causes/consequences and ► Solutions
	<p>If above conditions are met, you can occupy the front passenger seat again. Depending on the front passenger classification sensed by the OCS, the  PASS AIR BAG OFF indicator lamp will remain illuminated or go out.</p> <p>If above conditions are not met, the system is not working properly. Have the system checked at an authorized Mercedes-Benz Center as soon as possible.</p>

Warning!

If the  **PASS AIR BAG OFF** indicator lamp remains out even after performing the above corrective steps, do not have any children 12 years old and under and other small individuals use the front passenger seat until the system has been repaired.

Display messages	Possible causes/consequences and ► Solutions
Front Passenger Airbag Disabled See Operator's Manual	<p>USA only:</p> <p>The front passenger front air bag is deactivated while driving even though an adult or someone larger than a small individual is occupying the front passenger seat. Forces acting on the seat may make the system sense a decrease in weight.</p> <ul style="list-style-type: none"> ► Stop the vehicle in a safe location as soon as possible. ► Engage the parking brake. ► Switch off the ignition. ► Have the front passenger vacate the seat and exit the vehicle. ► Adjust the seat height to a higher position (► page 82). ► Make sure no objects which apply forces to the seat are present (e.g. objects such as books, briefcases etc. lodged underneath, behind or around the seat). Such forces may cause the system to sense that an occupant of a lesser weight than actually present is on the front passenger seat. ► Keep the seat unoccupied, close the front passenger door and switch on the ignition. <p>Monitor the  PASS AIR BAG OFF indicator lamp in the center console (► page 45) and the multifunction display in the instrument cluster (► page 28) for the following:</p> <p>With the seat unoccupied and the ignition switched on,</p> <ul style="list-style-type: none"> • the  PASS AIR BAG OFF indicator lamp in the center console should illuminate and remain illuminated, indicating that the OCS (► page 42) has deactivated the front passenger front air bag. • the message Front Passenger Airbag Enabled See Operator's Manual or the message Front Passenger Airbag Disabled See Operator's Manual should not appear in the multifunction display at any time the seat is unoccupied. Wait at least 60 seconds for the system to complete the necessary check cycles and to make sure neither message appears in the multifunction display. <p>If above conditions are met, you can occupy the front passenger seat again. Depending on the front passenger classification sensed by the OCS, the  PASS AIR BAG OFF indicator lamp will remain illuminated or go out.</p> <p>If above conditions are not met, the system is not working properly. Have the system checked at an authorized Mercedes-Benz Center as soon as possible.</p>

 **Warning!**

If the  **PASS AIR BAG OFF** indicator lamp remains illuminated with an adult occupant on the front passenger seat even after performing the above corrective steps, do not have any passenger use the front passenger seat until the system has been repaired.

Driving systems

Display messages		Possible causes/consequences and ► Solutions
Cruise Control	Inoperative	The cruise control is malfunctioning. ► Have the cruise control checked at an authorized Mercedes-Benz Center.
Cruise Control	- - - MPH	One of the activation conditions for cruise control has not been fulfilled. You may have attempted to set a speed below 20 mph (30 km/h). ► Drive faster than 20 mph (30 km/h) if the situation allows and set the speed. ► Check the activation conditions for cruise control (► page 142).
DISTRONIC	- - - Km/h (Canada only)	One of the activation conditions for DISTRONIC has not been fulfilled. You may have attempted to set a speed below 20 mph (30 km/h). ► Drive faster than 20 mph (30 km/h) if the situation allows and set the speed. ► Check the activation conditions for DISTRONIC (► page 147).
DISTRONIC	Inoperative	The DISTRONIC or the display are malfunctioning. ► Contact an authorized Mercedes-Benz Center as soon as possible.
DISTRONIC	Override	You have accelerated. The DISTRONIC has switched off. ► Stop accelerating.
DISTRONIC	Available Again	DISTRONIC had been deactivated and is available again. ► Activate DISTRONIC (► page 147).

Display messages		Possible causes/consequences and ► Solutions
DISTRONIC	Currently Unavailable See Operator's Manual	<p>Distronic is deactivated because:</p> <ul style="list-style-type: none"> • The Distronic cover in the radiator grille is dirty. • The functionality is impaired by heavy precipitation or fog. • The system is overheated. <p>► If necessary, clean the Distronic cover in the area of the radiator grille (▷ page 263).</p> <p>► If necessary, wait until the system has cooled down.</p> <p>► Restart the vehicle.</p> <p>Distronic becomes operational again without the engine being restarted when:</p> <ul style="list-style-type: none"> • dirt on the radiator grille has fallen off while driving (e.g. slush or snow) • the system recognizes full sensor availability (due to lessening rain or the road surface drying) • the message in the multifunction display disappears <p>You can then operate Distronic as usual again.</p>
DISTRONIC	Currently Unavailable See Operator's Manual	<p>Distronic is deactivated because the functionality is impaired by external interferences, e.g. high-frequency sources such as toll stations, speed measuring systems etc.</p> <ul style="list-style-type: none"> ► Leave the area of the external interference. ► Activate Distronic again (▷ page 147) when the message DISTRONIC Available Again appears. <p>Distronic is deactivated because the Distronic sensor has not sensed any other vehicles or objects, e.g. road sign or such, for a long time.</p> <ul style="list-style-type: none"> ► Activate Distronic again (▷ page 147) when the message DISTRONIC Available Again appears.

 **Warning!**

Distronic cannot take weather conditions into account. Switch off Distronic or do not turn it on if the sensor is dirty or visibility is diminished as a result of snow, rain or fog. The distance control may be impaired even before

the system is able to detect a dirty sensor. The message DISTRONIC Currently Unavailable See Operator's Manual will be displayed in the multifunction display and Distronic will be turned off.

Vehicle

Display messages		Possible causes/consequences and ► Solutions
Depress brake to shift out of P.		<p>You have attempted to shift the automatic transmission into drive position D, reverse gear R or neutral position N without depressing the brake pedal.</p> <p>► Depress the brake pedal.</p>
Door Open	Vehicle Not In Park	<p>You have opened the driver's door and the automatic transmission is still in drive position D, reverse gear R or neutral position N.</p> <p>► Before you leave the vehicle, make sure the automatic transmission is in park position P and the parking brake is engaged.</p>
Drive to workshop without shifting gears.		<p>The automatic transmission cannot be shifted out of the current transmission position because of a malfunction.</p> <p>If the automatic transmission is in drive position D:</p> <p>► Without shifting the automatic transmission out of drive position D, drive to an authorized Mercedes-Benz Center.</p> <p>If the automatic transmission is set to neutral position N, reverse gear R or park position P:</p> <p>► Do not drive.</p> <p>► Contact an authorized Mercedes-Benz Center or call Roadside Assistance.</p>
Only shift to P when vehicle is at a standstill.		<p>You have attempted to shift the automatic transmission into park position P although the vehicle was still in motion.</p> <p>► Stop the vehicle.</p>
Shift to P or N to start engine.		<p>You have attempted to start the engine with the KEYLESS-GO start/stop button while the automatic transmission was in reverse gear R or drive position D.</p> <p>► Shift the automatic transmission into park position P or neutral position N. Make sure the brake pedal is depressed.</p>
Auxiliary Battery	Malfunction	<p>The backup battery for the automatic transmission is no longer charging.</p> <p>► Contact an authorized Mercedes-Benz Center.</p>

Tires

Display messages		Possible causes/consequences and ► Solutions
Check tires,	then restart Run Flat Indicator.	<p>There has been a warning message about a loss in the tire inflation pressure and the tire pressure loss warning system was not restarted yet.</p> <ul style="list-style-type: none"> ► Make sure the correct tire inflation pressure is set for each tire. ► Then restart the tire pressure loss warning system (► page 222).
Run Flat Indicator	Inoperative	<p>The tire pressure loss warning system is malfunctioning.</p> <ul style="list-style-type: none"> ► Have the tire pressure loss warning system checked at an authorized Mercedes-Benz Center.
Tire Pressure	Check Tires	<p>The tire pressure loss warning system indicates that the tire inflation pressure is too low in at least one tire.</p> <ul style="list-style-type: none"> ► Carefully bring the vehicle to a halt, avoiding abrupt steering and braking maneuvers. Observe the traffic situation around you. ► Check the tires and, if necessary, change the wheel (► page 319). ► Check and adjust tire inflation pressure as required (► page 221). ► Restart the tire pressure loss warning system after adjusting the tire inflation pressure values (► page 222).
Tire pressure displayed after	driving for a few minutes.	<p>The tire inflation pressure is being checked by the Advanced TPMS.</p> <ul style="list-style-type: none"> ► Drive the vehicle for a few minutes.
Tire Pressure Monitor	Inoperative	<p>The Advanced TPMS is malfunctioning.</p> <ul style="list-style-type: none"> ► Have the Advanced TPMS checked at an authorized Mercedes-Benz Center.
Tire Pressure Monitor	Inoperative No Wheel Sensors	<p>There are wheels without appropriate wheel sensors mounted (e.g. winter tires).</p> <ul style="list-style-type: none"> ► Have the Advanced TPMS checked at an authorized Mercedes-Benz Center. ► Have the appropriate wheel sensors installed at an authorized Mercedes-Benz Center.

Display messages		Possible causes/consequences and ► Solutions
Tire Pressure Monitor	Wheel Sensor Missing	<p>At least one sensor is defect (e.g. battery is empty). The respective tire is indicated by - - instead of the tire inflation pressure in the multifunction display.</p> <ul style="list-style-type: none"> ► Have the Advanced TPMS checked at an authorized Mercedes-Benz Center. ► Have the wheel sensors installed at an authorized Mercedes-Benz Center.
		<p>At least one wheel without appropriate wheel sensors is mounted (e.g. spare tire). The respective tire is indicated by - - instead of the tire inflation pressure in the multifunction display.</p> <ul style="list-style-type: none"> ► Have the Advanced TPMS checked at an authorized Mercedes-Benz Center. ► Have the wheel sensors installed at an authorized Mercedes-Benz Center.
Tire Pressure Monitor	Currently Unavailable	<p>The Advanced TPMS cannot monitor the tire inflation pressure due to a nearby radio interference source or insufficient power supply.</p> <p>As soon as the causes of the malfunction have been rectified, the Advanced TPMS becomes active again automatically after a few minutes of driving.</p>
Tire Pressure(s) Please Correct		<p>The tire inflation pressure is too low in at least one tire. or The tire inflation pressures of the individual tires differ from each other significantly.</p> <p>The tire inflation pressure values are shown in the multifunction display.</p> <ul style="list-style-type: none"> ► Check and correct tire inflation pressure as required (▷ page 221). ► Restart the Advanced TPMS (▷ page 226).
Caution: Tire Defect		<p>At least one tire is deflating. The respective tire is indicated in the multifunction display.</p> <ul style="list-style-type: none"> ► Carefully bring the vehicle to a halt, avoiding abrupt steering and braking maneuvers. ► If necessary, change the wheel (▷ page 319).

Display messages	Possible causes/consequences and ► Solutions
Check Tire(s)	<p>The tire inflation pressure in at least one tire is significantly below the reference value.</p> <p>The respective tire is indicated in the multifunction display.</p> <ul style="list-style-type: none"> ► Carefully bring the vehicle to a halt, avoiding abrupt steering and braking maneuvers. ► Check and adjust tire inflation pressure as required. ► If necessary, change the wheel (► page 319).

 **Warning!**
 Do not drive with a flat tire. A flat tire affects the ability to steer or brake the vehicle. You may lose control of the vehicle. Continued driving with a flat tire will cause excessive heat build-up and possibly a fire.

 **Warning!**
 Follow recommended tire inflation pressures.

Do not underinflate tires. Underinflated tires wear excessively and/or unevenly, adversely affect handling and fuel economy, and are more likely to fail from being overheated.







Do not overinflate tires. Overinflated tires can adversely affect handling and ride comfort, wear unevenly, increase stopping distance, and result in sudden deflation (blowout) because they are more likely to become punctured or damaged by road debris, potholes etc.

Symbol messages

Brake

Display messages	Possible causes/consequences and ► Solutions
 Brake Wear	<p>The brake pads have reached their wear limit.</p> <ul style="list-style-type: none"> ► Have the brake pads replaced as soon as possible.

 Brake pad thickness must be visually inspected by a qualified technician at the intervals specified in the Maintenance Booklet.

Display messages		Possible causes/consequences and ► Solutions
 (USA only)  (Canada only)	EBV, ABS, ESP Inoperative See Operator's Manual	<p>The brake system is still functioning normally but due to a malfunction, the ABS, the BAS, the EBP, the ESP®, and the PRE-SAFE® system are unavailable.</p> <ul style="list-style-type: none"> ► Continue driving with added caution. Wheels may lock during hard braking, reducing steering capability. ► Adjust driving to be consistent with reduced braking responsiveness. ► Have the system checked at an authorized Mercedes-Benz Center as soon as possible.
 (USA only)  (Canada only)	Release Parking Brake	<p>You are driving with the parking brake engaged. In addition an acoustic warning sounds.</p> <ul style="list-style-type: none"> ► Release the parking brake.
 (USA only)  (Canada only)	Check Brake Fluid Level	<p>There is insufficient brake fluid in the reservoir. Risk of accident!</p> <ul style="list-style-type: none"> ► Stop the vehicle in a safe location or as soon as it is safe to do so. ► Engage the parking brake ► Do not drive any further. ► Contact an authorized Mercedes-Benz Center or call Roadside Assistance. <p>Do not add brake fluid! This will not solve the problem.</p>



Warning!

Driving with the message Check Brake Fluid Level displayed can result in an accident. Have your brake system checked immediately.

Do not add brake fluid before checking the brake system. Overfilling the brake fluid reservoir can result in spilling brake fluid on hot engine parts and the brake fluid catching fire. You can be seriously burned.

! If you find that the brake fluid in the brake fluid reservoir has fallen to the minimum mark or below, have the brake system checked for brake pad thickness and leaks.

Safety systems

Display messages	Possible causes/consequences and ► Solutions
 <p>Tele Aid Inoperative</p>	<p>One or more main functions of the Tele Aid system are malfunctioning.</p> <ul style="list-style-type: none"> ► Have the Tele Aid system checked at an authorized Mercedes-Benz Center.
 <p>Restraint Sys. Malfunction Service Required</p>	<p>The system is malfunctioning.</p> <ul style="list-style-type: none"> ► Drive with added caution to the nearest authorized Mercedes-Benz Center and have the system checked immediately.

Warning!



In the event a malfunction of the SRS is indicated as outlined above, the SRS may not be operational.



For your safety, we strongly recommend that you contact an authorized Mercedes-Benz

Center immediately to have the system checked. Otherwise the SRS may not be activated when needed in an accident, which could result in serious or fatal injury, or it might deploy unexpectedly and unnecessarily which could also result in injury.





Practical hints









Driving systems



Display messages	Possible causes/consequences and ► Solutions
 <p>Level Selection Not Permitted</p>	<p>The selected vehicle level cannot be adjusted, because</p> <ul style="list-style-type: none"> • you are driving too fast for the desired vehicle level • you are towing a trailer • you are using accessories that are connected to the trailer power socket, e.g. a bicycle rack <ul style="list-style-type: none"> ► Reduce vehicle speed and set the desired vehicle level again (► page 156). ► Observe the notes on trailer towing (► page 254).
 <p>Malfunction</p>	<p>The air suspension is malfunctioning.</p> <ul style="list-style-type: none"> ► Do not drive faster than 50 mph (80 km/h). ► Have the system checked at an authorized Mercedes-Benz Center.

Display messages	Possible causes/consequences and ► Solutions
 <p>Compressor Cooling Down</p>	<p>You have selected a higher vehicle level. Due to frequent level changes within a short period, the compressor must cool down first.</p> <p>! When the message Compressor Cooling Down appears in the multifunction display, driving is still possible. Keep in mind that the ride height of the vehicle is not yet reached, so you can damage the underbody of the vehicle.</p> <p>► Let the compressor cool down until the message disappears. The selected level will be set once the compressor has cooled down.</p>
 <p>Inoperative</p>	<p>Downhill Speed Regulation is malfunctioning.</p> <p>► Have the Downhill Speed Regulation checked at an authorized Mercedes-Benz Center.</p>

Vehicle

Display messages	Possible causes/consequences and ► Solutions
	<p>You are driving with the hood or the tailgate open.</p> <p>► Stop the vehicle in a safe location as soon as it is safe to do so.</p> <p>► Close the hood (► page 214) or the tailgate (► page 75). There is otherwise danger of an accident.</p> <p>You are trying to lock the vehicle with the KEYLESS-GO function with a door or the tailgate open.</p> <p>► Close all doors and/or the tailgate (► page 75).</p>
	<p>You are driving with at least one door open.</p> <p>► Close all doors.</p>
 <p>Key Detected In Vehicle</p>	<p>A SmartKey with KEYLESS-GO left in the vehicle was recognized while trying to lock the vehicle from the outside.</p> <p>► Take the SmartKey out of the vehicle.</p>
 <p>Don't Forget Your Key</p>	<p>This message appears for a maximum of 60 seconds if the driver's door is opened with the engine turned off and no SmartKey in the starter switch. This message is only a reminder.</p> <p>► Take the SmartKey with you when leaving the vehicle.</p>

Display messages	Possible causes/consequences and ► Solutions	
	Remove Key	You have forgotten to remove the SmartKey. ► Remove the SmartKey from the starter switch.
	You need a new key.	The SmartKey is malfunctioning. ► Contact an authorized Mercedes-Benz Center.
	Key Does Not Belong to Vehicle	The SmartKey in the starter switch does not belong to the vehicle. ► Find the SmartKey that belongs to the vehicle to operate the vehicle.
	Change Key Batteries	The batteries in the SmartKey with KEYLESS-GO are discharged. ► Replace the batteries (► page 309).
	Key Not Detected (message appears in red)	The SmartKey with KEYLESS-GO is not detected while the engine is running because the SmartKey is not in the vehicle. ► Stop the vehicle as soon as it is safe to do so. ► Engage the parking brake. ► Search for the SmartKey. The vehicle cannot be locked centrally nor can the engine be started again after the engine is stopped.
	Key Not Detected (message appears in red)	The SmartKey with KEYLESS-GO is not detected while the engine is running because there is strong radio-frequency interference. ► Stop the vehicle as soon as it is safe to do so. ► Engage the parking brake. ► Remove the KEYLESS-GO button from the starter switch (► page 80). ► Operate the vehicle with the SmartKey in the starter switch.
	Key Not Detected (message appears in white)	The SmartKey with KEYLESS-GO is momentarily not detected. ► Change the position of the SmartKey in the vehicle. ► If necessary, remove the KEYLESS-GO button from the starter switch (► page 80). ► Operate the vehicle with the SmartKey in the starter switch.
	Pull starting button out then insert key.	The SmartKey with KEYLESS-GO is permanently not detected. ► Remove the KEYLESS-GO button from the starter switch (► page 80). ► Operate the vehicle with the SmartKey in the starter switch. ► Contact an authorized Mercedes-Benz Center.

Display messages	Possible causes/consequences and ► Solutions
 Bluetooth Ready	<p>The telephone has not yet been connected to the COMAND system via Bluetooth®.</p> <p>► Connect the telephone to the COMAND system via Bluetooth®.</p>
 Top Up Washer Fluid	<p>The fluid level has dropped to approximately $\frac{1}{3}$ of total reservoir capacity.</p> <p>► Add washer fluid (► page 217).</p>

Engine

Display messages	Possible causes/consequences and ► Solutions
 Top Up Coolant See Operator's Manual	<p>The coolant level is too low.</p> <p>► Add coolant (► page 216).</p> <p>► If you have to add coolant frequently, have the cooling system checked at an authorized Mercedes-Benz Center.</p>

Warning!

Do not spill antifreeze on hot engine parts. Antifreeze contains ethylene glycol which may burn if it comes into contact with hot engine parts. You could be seriously burned.

! Do not ignore the low engine coolant level warning. Extended driving with the message and symbol displayed may cause serious engine damage not covered by the Mercedes-Benz Limited Warranty.

Do not drive without sufficient amount of coolant in the cooling system. The engine will overheat causing major engine damage.

Display messages	Possible causes/consequences and ► Solutions
 <p>Coolant Stop car, switch engine off.</p>	<p>The coolant is too hot.</p> <ul style="list-style-type: none"> ► Stop the vehicle immediately as soon as it is safe to do so. ► Turn off the engine immediately. ► Engage the parking brake. ► Only start the engine again after the message disappears. You could otherwise damage the engine. ► Observe the coolant temperature in the multifunction display. ► If the temperature rises again: Contact an authorized Mercedes-Benz Center immediately. <p>During severe operation conditions and stop-and-go city traffic, the coolant temperature may rise close to 248°F (120°C).</p>



 **Warning!**



Driving when your engine is overheated can cause some fluids which may have leaked into the engine compartment to catch fire. You could be seriously burned.

Steam from an overheated engine can cause serious burns which can occur just by opening the engine hood. Stay away from the engine if you see or hear steam coming from it.

Stop the vehicle in a safe location away from other traffic. Turn off the engine, get out of the vehicle and do not stand near the vehicle until the engine has cooled down.

- !** The engine should not be operated with the coolant temperature above 248°F (120°C). Doing so may cause serious damage which is not covered by the Mercedes-Benz Limited Warranty.

Display messages		Possible causes/consequences and ► Solutions
	<p>Coolant Stop car, switch engine off.</p>	<p>The poly-V-belt could be broken.</p> <ul style="list-style-type: none"> ► Stop the vehicle immediately as soon as it is safe to do so. ► Turn off the engine immediately. ► Check the poly-V-belt. ► If it is broken: Do not continue to drive. Otherwise the engine will overheat due to an inoperative water pump which may result in damage to the engine. Contact an authorized Mercedes-Benz Center. ► If it is intact: Do not continue to drive the vehicle with this message displayed. Doing so could result in serious engine damage that is not covered by the Mercedes-Benz Limited Warranty. ► Observe the coolant temperature in the multifunction display. ► Drive to the nearest authorized Mercedes-Benz Center immediately.
		<p>The radiator cooling fan is malfunctioning.</p> <ul style="list-style-type: none"> ► Observe the coolant temperature in the multifunction display. If the coolant temperature is below 248°F (120°C), you may continue driving to an authorized Mercedes-Benz Center. ► Avoid placing heavy loads on the engine (e.g. by driving uphill) as well as stop-and-go traffic. ► Have the fan replaced as soon as possible.
		<p>The battery is no longer charging. Possible causes:</p> <ul style="list-style-type: none"> • alternator malfunctioning • broken poly-V-belt • a malfunction in the electronic system <ul style="list-style-type: none"> ► Stop immediately in a safe location or as soon as it is safe to do so and check the poly-V-belt. ► If it is broken: Do not continue to drive. Otherwise the engine will overheat due to an inoperative water pump which may result in damage to the engine. Contact an authorized Mercedes-Benz Center. ► If it is intact: Drive to the nearest authorized Mercedes-Benz Center immediately. Adjust driving to be consistent with reduced braking responsiveness.

Display messages	Possible causes/consequences and ► Solutions
 <p>Battery/ Alternator Stop Vehicle</p>	<p>The battery is defective.</p> <ul style="list-style-type: none"> ► Stop the vehicle in a safe location or as soon as it is safe to do so. ► Engage the parking brake. ► Do not continue to drive. ► Contact an authorized Mercedes-Benz Center.
 <p>Check engine oil level at next refueling.</p>	<p>The engine oil level is too low.</p> <ul style="list-style-type: none"> ► Check the engine oil level (► page 214) and add engine oil as required (► page 215). ► If you must add engine oil frequently, have the engine checked for possible leaks.



If the message Check engine oil level at next refueling. appears while the engine is running and at operating temperature, the engine oil level has dropped to approximately the minimum level.





The message will be stored in the vehicle status message memory after you have cleared it from the multifunction display.

Visually check for oil leaks. If there are no obvious oil leaks, drive to the nearest service station to refill your engine oil to the required level.

For information on approved engine oils contact an authorized Mercedes-Benz Center or visit www.mbusa.com (USA only).

! Engine oil level warnings should not be ignored. Extended driving with the symbol displayed could result in serious engine damage that is not covered by the Mercedes-Benz Limited Warranty.







Display messages	Possible causes/consequences and ► Solutions
	<p>The fuel level is low.</p> <ul style="list-style-type: none"> ► Refuel at the next gas station.
 <p>Reserve Fuel</p>	<p>The fuel level has dropped below the reserve mark.</p> <ul style="list-style-type: none"> ► Refuel at the next gas station.
 <p>Ultra Low- sulfur Diesel Fuel Only</p>	<p>Vehicles with diesel engine only: The fuel level has dropped below the reserve mark.</p> <ul style="list-style-type: none"> ► Refuel at the next gas station. ► Only use commercially available vehicular ULTRA-LOW SULFUR HIGHWAY DIESEL FUEL (ULSD, 15 ppm SULFUR MAXIMUM).







Display messages	Possible causes/consequences and ► Solutions
 Gas Cap Open	<p>A loss of pressure has been detected in the fuel system. The fuel cap may not be closed properly or the fuel system may be leaking.</p> <ul style="list-style-type: none"> ► Check the fuel cap (▷ page 212). ► If it is not closed properly: Close the fuel cap. ► If it is closed properly: Have the fuel system checked at an authorized Mercedes-Benz Center.
 Replace air filter	<p>The air filter is clogged.</p> <ul style="list-style-type: none"> ► Have the air filter checked at an authorized Mercedes-Benz Center.
 Clean Fuel Filter	<p>There is water in the fuel filter.</p> <ul style="list-style-type: none"> ► Have the water drained at an authorized Mercedes-Benz Center as soon as possible.
 Check Additive See Operator's Manual	<p>The AdBlue[®] supply is almost depleted.</p> <ul style="list-style-type: none"> ► Have the AdBlue[®] tank refilled as soon as possible (▷ page 331). Contact an authorized Mercedes-Benz Center.
 Remaining Starts: 20	<p>The AdBlue[®] supply has dropped to the minimum level.</p> <ul style="list-style-type: none"> ► Have the AdBlue[®] tank refilled immediately (▷ page 331). Contact an authorized Mercedes-Benz Center.







i When the message Remaining Starts: 20 appears in the multifunction display, you can start the engine 20 more times. If you do not add AdBlue[®], the engine cannot be started beyond that point. Therefore, fill the AdBlue[®] tank with



approximately 1 gal (3.79 l) AdBlue[®] (corresponds to approximately 2 refill containers AdBlue[®]) or have the AdBlue[®] tank filled at an authorized Mercedes-Benz Center. After AdBlue[®] was refilled, the engine can be started again.

Lamps



Display messages		Possible causes/consequences and ► Solutions
	Active Headlamps Inoperative	The active Bi-Xenon headlamp system is malfunctioning. ► Contact an authorized Mercedes-Benz Center as soon as possible.
	Reverse Lamp Left or Reverse Lamp Right	The left or right backup lamp is malfunctioning. ► Replace the bulb as soon as possible (▷ page 311).
	Brake Lamp Left or Brake Lamp Right	The left or right brake lamp is malfunctioning. Rear lamps with bulbs: A substitute bulb is being used. Rear lamps with LEDs: This message will only appear if all LEDs have stopped working. ► Rear lamps with bulbs: Replace the bulb as soon as possible (▷ page 311). ► Rear lamps with LEDs: Contact an authorized Mercedes-Benz Center as soon as possible.
	3rd Brake Lamp	The high-mounted brake lamp is malfunctioning. This message will only appear if all LEDs have stopped working. ► Contact an authorized Mercedes-Benz Center as soon as possible.
	Front Foglamp Left or Front Foglamp Right	The left or right front fog lamp is malfunctioning. ► Contact an authorized Mercedes-Benz Center as soon as possible.
	Marker Lamp Front Left or Marker Lamp Front Right	The front left side or right side marker lamp is malfunctioning. ► Replace the bulb as soon as possible (▷ page 311).

Display messages		Possible causes/consequences and ► Solutions
	Parking Lamp Front Left or Parking Lamp Front Right	The left or right front parking lamp is malfunctioning. A substitute bulb is being used. ► Replace the bulb as soon as possible (▷ page 311).
	High Beam Left or High Beam Right	The left or right high-beam lamp is malfunctioning. ► Halogen headlamp: Replace the bulb as soon as possible (▷ page 311). ► Bi-Xenon headlamp: Contact an authorized Mercedes-Benz Center as soon as possible.
	License Plate Lamp Left or License Plate Lamp Right	The left or right license plate lamp is malfunctioning. ► Replace the bulb as soon as possible (▷ page 311).
	AUTO Light Inoperative	The light sensor is malfunctioning. The headlamps come on automatically. ► Contact an authorized Mercedes-Benz Center as soon as possible. To switch off the headlamps (U.S. vehicles only): ► In the control system, set daytime running lamp mode to manual (▷ page 133). ► Switch off the headlamps using the exterior lamp switch (▷ page 93).
	Low Beam Left or Low Beam Right	The left or right low-beam lamp is malfunctioning. ► Halogen headlamp: Replace the bulb as soon as possible (▷ page 311). ► Bi-Xenon headlamp: Contact an authorized Mercedes-Benz Center as soon as possible.
	Foglamp Rear Left	The rear fog lamp is malfunctioning. Rear lamps with LEDs: A substitute bulb is being used. ► Replace the bulb as soon as possible (▷ page 311).

Display messages	Possible causes/consequences and ► Solutions
 <p>Switch Off Lights</p>	<p>You have removed the SmartKey from the starter switch, opened the driver's door and left the headlamps on or removed the SmartKey with KEYLESS-GO from the vehicle and left the headlamps on.</p> <p>► Turn the exterior lamp switch to 0 or AUTO (► page 93).</p> <p>or</p> <p>► With the rear fog lamp switched on: Push in the exterior lamp switch to its stop.</p>
 <p>Tail Lamp Left or Tail Lamp Right</p>	<p>The left or right tail lamp is malfunctioning.</p> <p>Rear lamps with bulbs: A substitute bulb is being used.</p> <p>Rear lamps with LEDs: This message will only appear if all LEDs have stopped working.</p> <p>► Rear lamps with bulbs: Replace the bulb as soon as possible (► page 311).</p> <p>► Rear lamps with LEDs: Contact an authorized Mercedes-Benz Center as soon as possible.</p>
 <p>Cornering Lamp Left or Cornering Lamp Right</p>	<p>The left or right corner-illuminating front fog lamp is malfunctioning.</p> <p>► Contact an authorized Mercedes-Benz Center as soon as possible.</p>
 <p>Trailer Brake Lamp</p>	<p>The left or right trailer brake lamp is malfunctioning.</p> <p>► Replace the bulb as soon as possible.</p>
 <p>Trailer Tail Lamp Left or Trailer Tail Lamp Right</p>	<p>The left or right trailer tail lamp is malfunctioning.</p> <p>► Replace the bulb as soon as possible.</p>
 <p>Trailer Turn Signal Left or Trailer Turn Signal Right</p>	<p>The left or right trailer turn signal lamp is malfunctioning.</p> <p>► Replace the bulb as soon as possible.</p>

Display messages	Possible causes/consequences and ► Solutions
 <p>Turn Signal Rear Left or Turn Signal Rear Right</p>	<p>The left or right rear turn signal lamp is malfunctioning. A substitute bulb is being used.</p> <ul style="list-style-type: none"> ► Rear lamps with bulbs: Replace the bulb as soon as possible (▷ page 311). ► Rear lamps with LEDs: Contact an authorized Mercedes-Benz Center as soon as possible.
 <p>Turn Signal Front Left or Turn Signal Front Right</p>	<p>The left or right front turn signal lamp is malfunctioning. A substitute bulb is being used.</p> <ul style="list-style-type: none"> ► Replace the bulb as soon as possible (▷ page 311).
 <p>Turn Signal Left Mirror or Turn Signal Right Mirror</p>	<p>The turn signal in the left or right exterior rear view mirror is malfunctioning. This message will only appear if all LEDs have stopped working.</p> <ul style="list-style-type: none"> ► Contact an authorized Mercedes-Benz Center as soon as possible.

Tires

Display messages	Possible causes/consequences and ► Solutions
 <p>Tire pressure(s)) Please Correct</p>	<p>The tire inflation pressure is too low in at least one tire. or The tire inflation pressure of the individual tires differ from each other significantly.</p> <ul style="list-style-type: none"> ► Check and correct tire inflation pressure as required (▷ page 221).
 <p>Tire Pressure Caution: Tire Defect</p>	<p>At least one tire is deflating.</p> <ul style="list-style-type: none"> ► Carefully bring the vehicle to a halt, avoiding abrupt steering and braking maneuvers. ► If necessary, change the wheel (▷ page 319).

Display messages	Possible causes/consequences and ► Solutions
 <p>Tire Pressure Check Tires</p>	<p>The tire inflation pressure in at least one tire is significantly below the reference value.</p> <ul style="list-style-type: none"> ► Carefully bring the vehicle to a halt, avoiding abrupt steering and braking maneuvers. ► Check and adjust tire inflation pressure as required. ► If necessary, change the wheel (► page 319).

Warning!

Do not drive with a flat tire. A flat tire affects the ability to steer or brake the vehicle. You may lose control of the vehicle. Continued driving with a flat tire will cause excessive heat build-up and possibly a fire.

Warning!

Follow recommended tire inflation pressures.

Do not underinflate tires. Underinflated tires wear excessively and/or unevenly, adversely affect handling and fuel economy, and are more likely to fail from being overheated.

Do not overinflate tires. Overinflated tires can adversely affect handling and ride comfort, wear unevenly, increase stopping distance, and result in sudden deflation (blowout) because they are more likely to become punctured or damaged by road debris, potholes etc.

What to do if ...



Lamps in instrument cluster









Notes

If any of the following lamps in the instrument cluster fails to come on during the bulb self-check when switching on the ignition, have the respective bulb checked and replaced if necessary.

When you switch on the ignition, all lamps (except low-beam headlamp indicator lamp, high-beam headlamp indicator lamp, and turn signal indicator lamps unless activated) in the instrument cluster come on. If a lamp in the instrument cluster fails to come on when the ignition is switched on, have it checked and replaced if necessary.

Brake

Problem	Possible causes/consequences and ► Solutions
 The yellow ABS indicator lamp comes on while the engine is running.	<p>The ABS has detected a malfunction and switched off. The BAS, the ESP[®] and the PRE-SAFE[®] are also switched off.</p> <p>The brake system is still functioning normally but without the systems specified above available.</p> <p>If the ABS control unit is malfunctioning, other systems such as the navigation system or the automatic transmission may also be malfunctioning.</p> <ul style="list-style-type: none"> ► Continue driving with added caution. Wheels may lock during hard braking, reducing steering capability. ► Read and observe messages that may appear in the multifunction display (▷ page 272). ► Have the system checked at an authorized Mercedes-Benz Center as soon as possible. <p>Failure to follow these instructions increases the risk of an accident.</p>
 The yellow ABS indicator lamp comes on while the engine is running.	<p>The ABS has switched off due to insufficient power supply. The battery might not be charged sufficiently.</p> <p>When the voltage is above the required value again, the ABS is operational again. The ABS indicator lamp should go out.</p> <ul style="list-style-type: none"> ► If the ABS indicator lamp does not go out: Have the alternator and the battery checked.
 The yellow ABS indicator lamp comes on while the engine is running.	<p>The self-diagnosis has not been completed yet.</p> <p>The indicator lamp will go out after driving a short distance at a vehicle speed of above 12 mph (20 km/h).</p>

Problem	Possible causes/consequences and ► Solutions
<p>  (USA only)  (Canada only)    </p> <p>The red brake warning lamp comes on while driving. In addition, the yellow ABS malfunction indicator lamp, and the yellow ESP[®] warning lamp come on and an acoustic warning sounds.</p>	<p>The Electronic Brake Proportioning (EBP) switched off due to a malfunction.</p> <p>The ABS, the BAS, the ESP[®] and PRE-SAFE[®] are also switched off.</p> <p>► Have the system checked at an authorized Mercedes-Benz Center as soon as possible.</p> <p>Failure to follow these instructions increases the risk of an accident.</p>
<p>  (USA only)  (Canada only) </p> <p>The red brake warning lamp comes on while driving and an acoustic warning sounds.</p>	<p>You are driving with the parking brake engaged.</p> <p>► Release the parking brake.</p>
<p>  (USA only)  (Canada only) </p> <p>The red brake warning lamp comes on while the engine is running and an acoustic warning sounds.</p>	<p>There is insufficient brake fluid in the reservoir. Risk of accident!</p> <p>► Do not drive any further. Stop the vehicle in a safe location as soon as it is safe to do so.</p> <p>► Engage the parking brake.</p> <p>► Read and observe messages that may appear in the multifunction display (► page 272).</p> <p>► Contact an authorized Mercedes-Benz Center.</p> <p>Do not add brake fluid! This will not solve the problem.</p>





Warning!

Driving with the brake warning lamp illuminated can result in an accident. Have your brake system checked immediately if the brake warning lamp stays on. Do not add brake fluid before checking the brake system. Overfilling the brake fluid reservoir can result in spilling brake fluid on hot engine parts and

the brake fluid catching fire. You can be seriously burned.

! If you find that the brake fluid in the brake fluid reservoir has fallen to the minimum mark or below, have the brake system checked for brake pad thickness and leaks.

Safety systems

Problem	Possible causes/consequences and ► Solutions
 The red seat belt telltale comes on for a maximum of 6 seconds after starting the engine.	<p>The seat belt telltale reminds you and your passengers to fasten your seat belts before driving off.</p> <p>► Fasten your seat belts.</p> <p>Regardless of whether the seat belts are fastened or not, the seat belt telltale always comes on and remains lit for 6 seconds after starting the engine.</p>
 The red seat belt telltale comes on. In addition you hear a warning chime for a maximum of 6 seconds after starting the engine.	<p>You have forgotten to fasten your seat belt.</p> <p>► Fasten your seat belt. The warning chime stops sounding.</p>
 The red seat belt telltale comes on while the vehicle is standing still and the engine is running or while driving.	<p>You and/or your front passenger have forgotten to fasten your seat belts.</p> <p>► Fasten your seat belts. The seat belt telltale goes out.</p> <p>There are items placed on the front passenger seat and therefore the system senses the front passenger seat as being occupied.</p> <p>► Remove the items from the front passenger seat and put them in a safe place. The seat belt telltale goes out.</p>
 The red seat belt telltale flashes while driving. In addition, an intermittent warning chime sounds with increasing intensity.	<p>The vehicle's speed once exceeded 15 mph (25 km/h) and you and/or your front passenger have forgotten to fasten your seat belts.</p> <p>► Fasten your seat belts. The seat belt telltale goes out and the warning chime stops sounding.</p> <p>There are items placed on the front passenger seat and therefore the system senses the front passenger seat as being occupied.</p> <p>► Remove the items from the front passenger seat and put them in a safe place. The seat belt telltale goes out and the warning chime stops sounding.</p>

i After 60 seconds with an unfastened seat belt the warning chime stops sounding and the seat belt telltale illuminates continuously. The seat belt telltale will only go out if both, the driver and front passenger's seat belt are fastened, or the vehicle is standing still and a front door is opened.



Problem	Possible causes/consequences and ► Solutions
SRS The red SRS indicator lamp comes on while driving.	<p>There is a malfunction in the restraint systems. The air bags or Emergency Tensioning Devices (ETDs) could deploy unexpectedly or fail to activate in an accident.</p> <ul style="list-style-type: none"> ► Drive with added caution to the nearest authorized Mercedes-Benz Center.

⚠ Warning!



In the event a malfunction of the SRS is indicated as outlined above, the SRS may not be operational.
 For your safety, we strongly recommend that you contact an authorized Mercedes-Benz

Center immediately to have the system checked. Otherwise the SRS may not be activated when needed in an accident, which could result in serious or fatal injury, or it might deploy unexpectedly and unnecessarily which could also result in injury.

Problem	Possible causes/consequences and ► Solutions
⚠ The yellow ESP® warning lamp comes on while the engine is running.	<p>The ESP® has been switched off. Risk of accident! When the ESP® is switched off it will not stabilize the vehicle if the system recognizes that the vehicle starts to skid or that a wheel is spinning.</p> <ul style="list-style-type: none"> ► Switch the ESP® back on. Exceptions: (▷ page 64). ► If leaving the ESP® switched off, adapt your speed and driving to the prevailing road and weather conditions. ► If the ESP® cannot be switched back on: Have the system checked at an authorized Mercedes-Benz Center as soon as possible.
⚠ The yellow ESP® warning lamp comes on while the engine is running.	<p>The ESP® is not operational due to a malfunction. Risk of accident!</p> <ul style="list-style-type: none"> ► Read and observe additional messages that may appear in the multifunction display. ► Continue driving with added caution. ► Adapt your speed and driving to the prevailing road and weather conditions. ► Have the system checked at an authorized Mercedes-Benz Center as soon as possible.

Problem	Possible causes/consequences and ► Solutions
<p> The yellow ESP[®] warning lamp flashes while driving.</p>	<p>The ESP[®] or the ETS/4-ETS has come into operation because of detected traction loss in at least one tire. The cruise control is deactivated.</p> <ul style="list-style-type: none"> ► When driving off, apply as little throttle as possible. ► While driving, ease up on the accelerator pedal. ► Adapt your speed and driving to the prevailing road and weather conditions. ► Do not deactivate the ESP[®]. Exceptions: (► page 64). <p>Failure to follow these instructions increases the risk of an accident.</p> <p>At least one wheel is spinning and the Electronic Traction System (ETS/4-ETS) has switched off to prevent overheating of the drive wheel brakes.</p> <ul style="list-style-type: none"> ► Read and observe additional messages that may appear in the multifunction display. <p>As soon as the brakes have cooled off, the Electronic Traction System (ETS/4-ETS) switches on again. The message in the multifunction display disappears and the ESP[®] warning lamp  goes out.</p>





Driving systems

Problem	Possible causes/consequences and ► Solutions
<p> The red distance warning lamp comes on while driving.</p>	<p>You are too close to the vehicle in front of you to maintain selected speed.</p> <ul style="list-style-type: none"> ► Apply the brakes immediately to increase the following distance.
<p> The red distance warning lamp comes on while driving and an acoustic warning sounds.</p>	<p>You are gaining too rapidly on the vehicle ahead of you or the distance warning system has recognized a stationary obstacle on your probable line of travel.</p> <ul style="list-style-type: none"> ► Apply the brakes immediately. ► Carefully observe the traffic situation. You may need to brake or maneuver to avoid hitting an obstacle.



Vehicle

Problem	Possible causes/consequences and ► Solutions
The yellow fuel tank reserve warning lamp in the fuel gauge comes on while driving.	The fuel level has gone below the reserve mark. ► Refuel at the next gas station.

Engine

Problem	Possible causes/consequences and ► Solutions
 (USA only)  (Canada only) The yellow engine malfunction indicator lamp comes on when the engine is running.	There may be a malfunction in <ul style="list-style-type: none"> • the fuel management system • the ignition system • the emission control system • systems which affect emissions Such malfunctions may result in excessive emissions values and may switch the engine to limp-home (emergency operation) mode. ► Have the vehicle checked as soon as possible at an authorized Mercedes-Benz Center. i Some states may by law require you to visit a workshop as soon as the engine malfunction indicator lamp comes on. Check local requirements.
 (USA only)  (Canada only) The yellow engine malfunction indicator lamp comes on when the engine is running.	A loss of pressure has been detected in the fuel system. The fuel cap may not be closed properly or the fuel system may be leaky. ► Check the fuel cap (> page 210). ► If it is not closed properly: Close the fuel cap. ► If it is closed properly: Have the fuel system checked by an authorized Mercedes-Benz Center.
	Diesel engine: Your fuel tank was driven empty. ► After refueling, start, turn off and restart the engine three or four times in succession. The limp-home mode is canceled. You do not need to have your vehicle checked.

Tires

Problem	Possible causes/consequences and ► Solutions
 USA only: Combination low tire pressure telltale/TPMS malfunction telltale for the Advanced TPMS illuminates continuously.	<p>The Advanced TPMS detects a loss of pressure in at least one tire.</p> <ul style="list-style-type: none"> ► Carefully bring the vehicle to a halt, avoiding abrupt steering and braking maneuvers. Observe the traffic situation around you. ► Read and observe messages in the multifunction display (▷ page 272). <p>If the tire inflation pressure in the respective tire(s) has (have) been corrected, the combination low tire pressure/TPMS malfunction telltale goes out after a few minutes of driving.</p>
 USA only: Combination low tire pressure telltale/TPMS malfunction telltale for the Advanced TPMS flashes 60 seconds and then stays illuminated.	<p>There is a malfunction in the Advanced TPMS.</p> <ul style="list-style-type: none"> ► Read and observe messages in the multifunction display (▷ page 272). ► Have the Advanced TPMS checked at an authorized Mercedes-Benz Center. <p>After the malfunction has been remedied, the combination low tire pressure/TPMS malfunction telltale goes out after a few minutes of driving.</p>

 **Warning!**

Each tire, including the spare (if provided), should be checked at least once a month when cold and inflated to the inflation pressure recommended by the vehicle manufacturer on the Tire and Loading Information placard on the driver's door B-pillar or the tire inflation pressure label on the inside of the fuel filler flap. If your vehicle has tires of a different size than the size indicated on the Tire and Loading Information placard or the tire inflation pressure label, you should determine the proper tire inflation pressure for those tires.

As an added safety feature, your vehicle has been equipped with a tire pressure monitoring system (TPMS) that illuminates a low tire pressure telltale when one or more of your tires are significantly underinflated. Accordingly, when the low tire pressure telltale illuminates, you should stop and check

your tires as soon as possible, and inflate them to the proper pressure. Driving on a significantly underinflated tire causes the tire to overheat and can lead to tire failure.

Underinflation also reduces fuel efficiency and tire tread life, and may affect the vehicle's handling and stopping ability. Please note that the TPMS is not a substitute for proper tire maintenance, and it is the driver's responsibility to maintain correct tire pressure, even if underinflation has not reached the level to trigger illumination of the TPMS low tire pressure telltale.

Your vehicle has also been equipped with a TPMS malfunction indicator to indicate when the system is not operating properly. The TPMS malfunction indicator is combined with the low tire pressure telltale. When the system detects a malfunction, the telltale will flash for approximately 1 minute and then remain continuously illuminated. This

sequence will continue upon subsequent vehicle start-ups as long as the malfunction exists. When the malfunction indicator is illuminated, the system may not be able to detect or signal low tire pressure as intended. TPMS malfunctions may occur for a variety of reasons, including the installation of incompatible replacement or alternate tires

or wheels on the vehicle that prevent the TPMS from functioning properly. Always check the TPMS malfunction telltale after replacing one or more tires or wheels on your vehicle to ensure that the replacement or alternate tires and wheels allow the TPMS to continue to function properly.

Lamp in center console

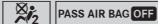
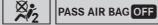
Problem	Possible causes/consequences and ► Solutions
Canada only:  The front passenger front air bag off indicator lamp illuminates and remains illuminated (> page 47).	A BabySmart™ child seat is installed on the front passenger seat. Therefore the front passenger front air bag is switched off. The system is malfunctioning when there is no BabySmart™ child seat installed on the front passenger seat. ► Have the system checked as soon as possible at an authorized Mercedes-Benz Center.
Canada only:  The front passenger front air bag off indicator lamp does not illuminate or does not remain illuminated with a BabySmart™ child seat properly installed on the passenger seat.	The system is malfunctioning. ► Make sure there is nothing between seat cushion and child seat. ► Check installation of the child seat (> page 58). If the front passenger front air bag off indicator lamp remains out: ► Have the system checked as soon as possible at an authorized Mercedes-Benz Center. Do not use the BabySmart™ restraint to transport children on the front passenger seat until the system has been repaired.
USA only:  The front passenger front air bag off indicator lamp illuminates and remains illuminated with the weight of a typical adult or someone larger than a small individual on the front passenger seat.	The system is malfunctioning. ► Have the system checked as soon as possible at an authorized Mercedes-Benz Center. ► Read and observe messages in the multifunction display and follow corrective steps (> page 272).

Warning!

If the  **PASS AIR BAG OFF** indicator lamp illuminates and remains illuminated with the weight of a typical adult or someone larger

than a small individual on the front passenger seat, do not have any passenger use the front passenger seat until the system has been repaired.

Problem	Possible causes/consequences and ► Solutions
<p>USA only:</p> <p> PASS AIR BAG OFF</p> <p>The front passenger front air bag off indicator lamp does not illuminate and/or does not remain illuminated with the weight of a typical 12-month-old child in a standard child restraint or less on the front passenger seat.</p>	<p>The system is malfunctioning.</p> <ul style="list-style-type: none"> ► Make sure there is nothing between seat cushion and child seat and check installation of the child seat. ► Make sure no objects applying supplemental weight onto the seat are present. ► Make sure no objects which apply forces to the seat are present (e.g. objects such as books, briefcases etc. lodged behind or around the seat, head restraints pushing against roof etc.). The system may recognize such forces as supplemental weight. ► If the front passenger front air bag off indicator lamp remains out, have the system checked as soon as possible at an authorized Mercedes-Benz Center. Do not transport a child on the front passenger seat until the system has been repaired. ► Read and observe messages in the multifunction display and follow corrective steps (► page 272).

Warning!

If the  **PASS AIR BAG OFF** indicator lamp does not illuminate or remains out with the weight of a typical 12-month-old child in a standard child restraint or less on the front passenger seat, do not transport a child on the front passenger seat until the system has been repaired.

and

- open the driver's door

To cancel the alarm, insert the SmartKey into the starter switch.

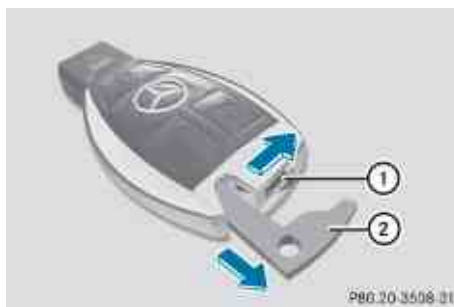
Removing the mechanical key

SmartKey

Unlocking/locking manually**Unlocking the vehicle**

If you cannot unlock the vehicle with the SmartKey or with KEYLESS-GO, unlock the driver's door using the mechanical key.

The anti-theft alarm system will trigger when you

- unlocking the driver's door with the mechanical key

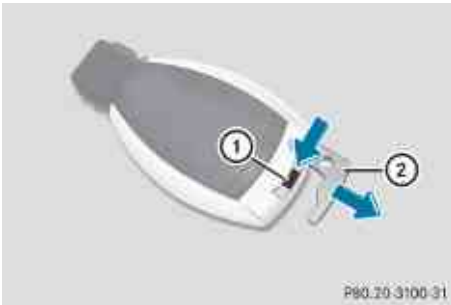

SmartKey with KEYLESS-GO

- ▶ Move locking tab ① in the direction of arrow.
- ▶ Slide mechanical key ② out of the housing.

Unlocking the driver's door



- ▶ Insert mechanical key ② into the driver's door lock.
- ▶ Turn mechanical key ② counterclockwise to position 1.
- ▶ Pull the door handle past the resistance point until the locking knob moves up. The driver's door is unlocked.
- ▶ Pull the door handle once more to open the driver's door.
- ▶ Turn mechanical key ② back and remove it from the driver's door lock.

Locking the vehicle

If you cannot lock the vehicle with the SmartKey or with KEYLESS-GO, lock it as follows:

- ▶ Close the front passenger door, the right rear door, and the tailgate.
- ▶ Open the driver's door and the rear left door.
- ▶ Press the central locking switch (▷ page 75). The locking knobs of the front passenger door and the rear doors move down.
- ▶ **If the vehicle battery is disconnected or drained:** Press down the locking knobs on the front passenger door and the rear doors.
- ▶ Exit the vehicle.
- ▶ Close the driver's door.
- ▶ Enter the vehicle through the rear left door.
- ▶ Press down the locking knob of the driver's door.

! To prevent inadvertent lockout, make sure to have the SmartKey with you before proceeding with the next step. The next step will lock the vehicle.

- ▶ Exit the vehicle.
- ▶ Close the rear left door. The vehicle is locked.

i This procedure does not arm the anti-theft alarm system, nor does it lock the fuel filler flap.

Unlocking and opening the tailgate

If the tailgate can no longer be unlocked and opened using button  on the SmartKey or the KEYLESS-GO function, use the emergency release lever to unlock and open the tailgate.

The emergency release lever is located on the inside of the tailgate.

A minimum height clearance of 7.2 ft (2.20 m) is required to open the tailgate.

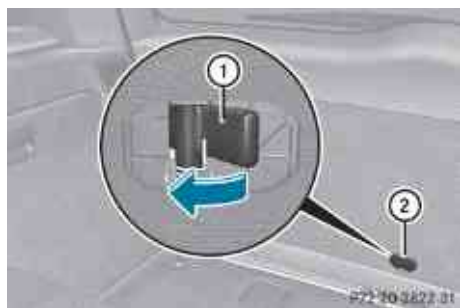



- ▶ Remove cover ② from the trim on the tailgate.
- ▶ Push emergency release lever ① all the way to the left.

! The tailgate swings open upwards automatically. Always make sure there is sufficient overhead clearance.

- ▶ Open the tailgate.

i If the vehicle has previously been locked from the outside using the SmartKey or KEYLESS-GO, opening the tailgate from the inside using the emergency release lever will trigger the anti-theft alarm system.

To cancel the alarm, do one of the following:

- Insert the SmartKey into the starter switch.
- Press button  or  on the SmartKey.

In vehicles with KEYLESS-GO:

- Pull an outside door handle.
The SmartKey must be within 3 ft (1 m) of the vehicle.
- Press the KEYLESS-GO start/stop button.
The SmartKey must be inside the vehicle.

- ▶ Reinstall cover ②.

Fuel filler flap

Warning!

HYBRID vehicles: It is imperative that you read the HYBRID Supplemental Operating Instructions included in your vehicle literature portfolio. You may otherwise not recognize potential danger.

Warning!

Avoid contact with the vehicle walls as they may contain sharp edges. Otherwise, you could injure yourself while releasing the fuel filler flap.

In case the central locking system does not release the fuel filler flap, you can open it manually.

The fuel filler flap release is located on the passenger side in the cargo compartment behind the cover.

- ▶ Open the tailgate (▷ page 75).
- ▶ Open the cover on the passenger-side trim panel (▷ page 316).



- ▶ Pull yellow fuel filler flap release ① in direction of arrow.
The fuel filler flap is unlocked.
- ▶ Open the fuel filler flap (▷ page 210).
- ▶ Close the cover.
- ▶ Close the tailgate.

Resetting activated NECK-PRO active front head restraints

If the NECK-PRO active front head restraints have been triggered in a rear-end collision, they must be reset.

You can tell that the NECK-PRO active front head restraints have been triggered when they have been moved forward and cannot be adjusted.

⚠ Warning!

For safety reasons, have the NECK-PRO active front head restraints checked at an authorized Mercedes-Benz Center after a rear-end collision.

⚠ Warning!

When pushing back the head restraint cushion, make sure your fingers do not become caught between the head restraint cushion and the cover. Failing to do so may lead to injury.

- ❗ Pressing the head restraint cushion back requires high force. If you encounter difficulties when pushing the head restraint back, please have the procedure performed at an authorized Mercedes-Benz Center.

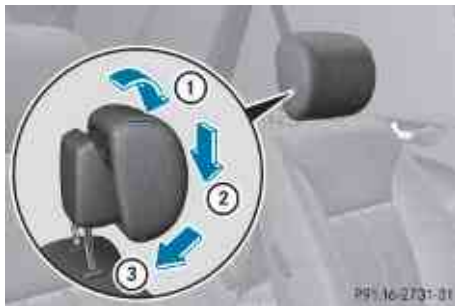

- ▶ Pull the top of the head restraint cushion in direction of arrow ① as far as it will go.
- ▶ Adjust the head restraint cushion downward in direction of arrow ② as far as it will go.

- ▶ Firmly press the top of the head restraint cushion towards the head restraint cover in direction of arrow ③ until it engages.
- ▶ Repeat this procedure on the NECK-PRO active front head restraint for the second front seat.

For information on NECK-PRO active front head restraints, see “NECK-PRO active front head restraints” (▷ page 53).

Replacing SmartKey batteries

If the batteries in the SmartKey are discharged, the vehicle can no longer be locked or unlocked. It is recommended to have the batteries replaced at an authorized Mercedes-Benz Center.

⚠ Warning!

Batteries contain poisonous and corrosive substances. Therefore, keep the batteries out of reach of children.

If a battery is swallowed, seek medical help immediately.

⚠ Warning!

SmartKey batteries contain perchlorate material, which may require special handling and regard for the environment. Check with your local government’s disposal guidelines. California residents, see www.dtsc.ca.gov/HazardousWaste/Perchlorate/index.cfm.

Batteries contain materials that can harm the environment if disposed of improperly. Recycling of batteries is the preferred method of disposal. Many states (USA only) or provinces (Canada only) require sellers of batteries to accept old batteries for recycling. When inserting the batteries, make sure they are clean and free of lint. When replacing batteries, always replace both batteries.

- i** The required replacement batteries are available at any authorized Mercedes-Benz Center.

Replacement batteries: Lithium, type CR 2025 or equivalent.

- ▶ Remove the mechanical key from the SmartKey (> page 306).

SmartKey

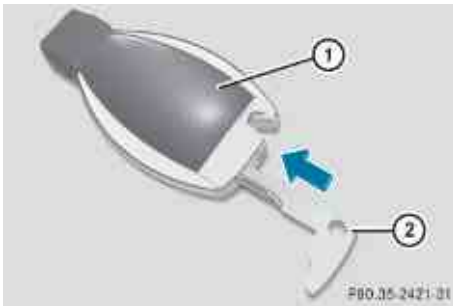

- ▶ Press mechanical key ② into the SmartKey opening until battery compartment cover ① opens. Do not keep the cover shut.

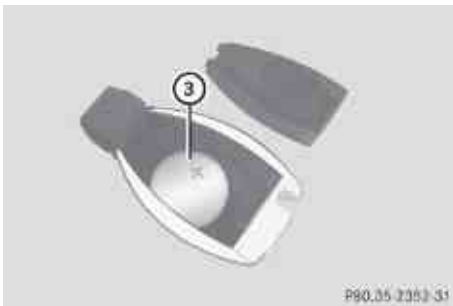

- ▶ Remove the battery compartment cover.
- ▶ Pat the SmartKey against the palm of your hand until battery ③ falls out.
- ▶ Insert the new battery with the positive terminal (+) facing up. Use a lint-free cloth.
- ▶ Insert the tabs of the battery compartment cover into the housing and press the cover closed.

- ▶ Slide mechanical key ① back into the SmartKey.
- ▶ Check the operation of the SmartKey.

SmartKey with KEYLESS-GO

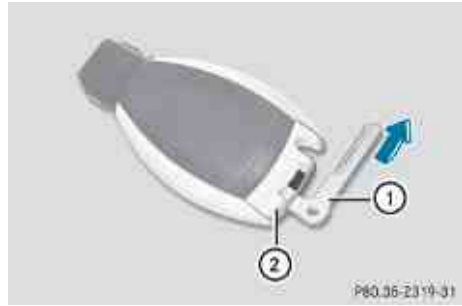

- ▶ Insert mechanical key ① into opening.
- ▶ Press mechanical key ① in direction of arrow. Battery compartment ② is unlatched.
- ▶ Pull battery compartment ② out of the SmartKey housing.

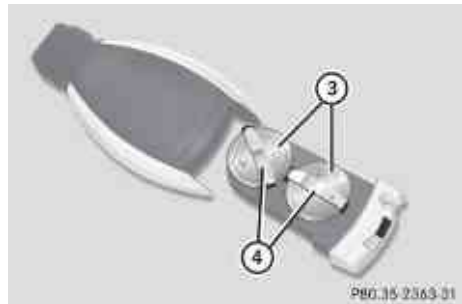

- ▶ Pull out batteries ③.
- ▶ Insert new batteries ③ under contact springs ④ with the positive terminal (+) side facing up.
- ▶ Return battery compartment ② into SmartKey housing until it locks into place.
- ▶ Slide mechanical key ① back into the SmartKey.
- ▶ Check the operation of the SmartKey as well as the KEYLESS-GO function.

Replacing bulbs

Safety notes

Safe vehicle operation depends on proper exterior lighting and signaling to a large degree.

Correct headlamp adjustment is extremely important. Have headlamps checked and readjusted at regular intervals and when a bulb has been replaced. Contact an authorized Mercedes-Benz Center for headlamp adjustment.

Warning!

Bulbs and bulb sockets can be very hot. Allow the lamp to cool down before changing a bulb.

Keep bulbs out of reach of children.

Halogen lamps contain pressurized gas. A bulb can explode if you

- touch or move it when hot
- drop the bulb
- scratch the bulb

Wear eye and hand protection.

Because of high voltage in Xenon lamps, it is dangerous to replace the bulb or repair the lamp and its components. We recommend that you have such work done by a qualified technician.

- i** Since replacing bulbs is a technically highly demanding process, we recommend to have them replaced at an authorized Mercedes-Benz Center.
- i** If the headlamps or front fog lamps are fogged up on the inside as a result of high humidity, driving the vehicle a distance with the lights on should clear up the fogging.

Bulbs

You can replace the following bulbs yourself:

Halogen headlamps



Type

- ① Low-beam lamp: H7 55 W
- ② High-beam lamp/High-beam flasher lamp: H7 55 W
- ③ Parking and standing lamp: W 5 W
- ④ Turn signal lamp: 3457A
- ⑤ Side marker lamp: WY 5 W

Bi-Xenon headlamps



Type

- ① High-beam flasher lamp/High-beam flasher spot lamp: H7 55 W
- ② Parking and standing lamp: W 5 W
- ③ Turn signal lamp: 3457A
- ④ Side marker lamp: WY 5 W

Standard rear lamps

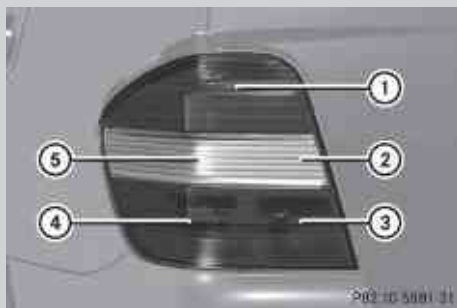

Type

- ① Brake lamp: P 21 W
- ② Backup lamp: P 21 W
- ③ Tail lamp, parking and standing lamp, rear foglamp (driver's side only): P 21 W
- ④ Side marker lamp: P 21 W
- ⑤ Turn signal lamp: PY 21 W

LED rear lamps



Type

- ① Backup lamp: W 16 W
- ② Rear foglamp (driver's side only): W 16 W
- ③ Rear foglamp (driver's side only): W 16 W

License plate lamps

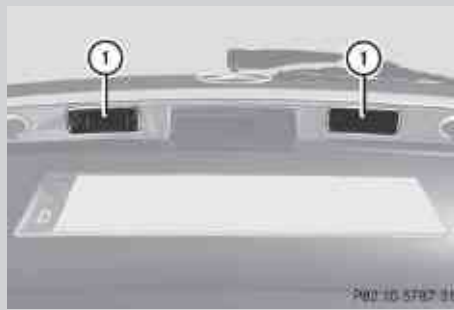

Type

- ① License plate lamps: C 5 W

Notes on bulb replacement

! Do not replace LEDs or bulbs not described in this section. You could otherwise damage the LEDs, the bulbs or parts of the vehicle. Only have the LEDs and bulbs replaced at an authorized Mercedes-Benz Center.

- Only use 12-volt bulbs of the same type and with the specified watt rating.
- Switch the lights off before changing a bulb to prevent short circuits.
- Always use a clean lint-free cloth when handling bulbs.
- Your hands should be dry and free of oil and grease.
- If the newly installed bulb does not come on, contact an authorized Mercedes-Benz Center.

- i** Mercedes-Benz recommends using Longlife (LL) bulbs.

Replacing bulbs for front lamps

Before you start to replace a bulb for a front lamp, do the following:

- ▶ Switch off the ignition.
- ▶ Turn the exterior lamp switch to position 0.
- ▶ Open the hood (▷ page 212).

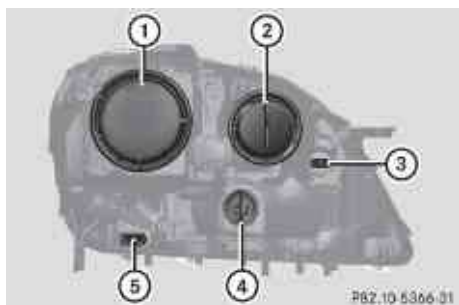

Example illustration: Driver's side headlamp

- ① Housing cover for low-beam halogen or Bi-Xenon headlamp
- ② Housing cover for high-beam halogen bulb (high beam and high-beam flasher)
- ③ Bulb socket for parking and standing lamp bulb
- ④ Bulb socket for front turn signal lamp bulb
- ⑤ Bulb socket for side marker lamp bulb

Warning!

Do not remove the cover for the Bi-Xenon headlamp. Because of high voltage in Xenon lamps, it is dangerous to replace the bulb or repair the lamp and its components. It is recommended to have such work done by a qualified technician.

Low-beam bulb (halogen headlamps only)

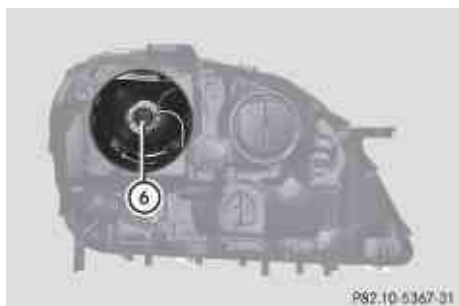

- ⑥ Bulb socket for low-beam headlamp

- ▶ Turn housing cover ① counterclockwise and remove it.
- ▶ Turn bulb socket ⑥ with the bulb counterclockwise and remove it.

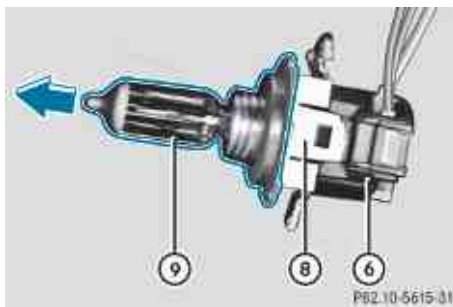

- ▶ Pull bulb ⑨ out of bulb socket ⑥.
- i** Do not remove clip ⑧ from bulb socket ⑥.
- ▶ Gently press the new bulb into bulb socket ⑥.
- ▶ Place bulb socket ⑥ back into the housing and turn it clockwise until it engages.
- ▶ Align housing cover ① and turn it clockwise until it engages.

High-beam and high-beam flasher bulb (halogen headlamps only)/high-beam flasher bulb (Bi-Xenon headlamps only)

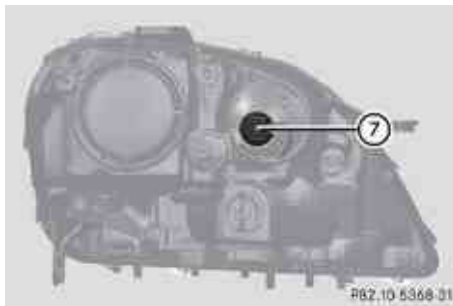

- ⑦ Bulb socket for high-beam headlamp

- ▶ Turn housing cover ② counterclockwise and remove it.
- ▶ Turn bulb socket ⑦ with the bulb counterclockwise and remove it.
- ▶ Pull the bulb out of bulb socket ⑦.
- ▶ Gently press the new bulb into bulb socket ⑦.
- ▶ Place bulb socket ⑦ back into the housing and turn it clockwise until it engages.
- ▶ Align housing cover ② and turn it clockwise until it engages.

Parking and standing lamp bulb, front turn signal lamp bulb, side marker lamp bulb

- ▶ Turn respective bulb socket ③, ④ or ⑤ (▷ page 314) with the bulb counterclockwise and remove it.
- ▶ Pull the bulb out of the bulb socket.
- ▶ Gently press the new bulb into the bulb socket.
- ▶ Place bulb socket ③, ④ or ⑤ back into the housing and turn it clockwise until it engages.

Replacing bulbs for rear lamps

Before you start to replace a bulb for a rear lamp, do the following:

- ▶ Switch off the ignition.
- ▶ Turn the exterior lamp switch to position **0**.

Tail lamp unit

To access the tail lamp units, you first have to remove the cover in the corresponding side trim panel of the cargo compartment.

- ▶ Open the tailgate.

Opening the driver's side trim panel



- ▶ Turn lock ① counterclockwise by 90°.
- ▶ Remove cover ②.

Removing storage compartment

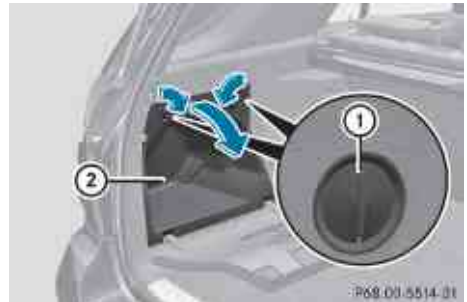

Example illustration: Storage compartment without sound system

- ▶ Remove everything from storage compartment ②.
- ▶ Insert a suitable object such as a coin into the slot of lock ①.
- ▶ Turn lock ① by 90° in direction of the arrow.
- ▶ Remove storage compartment ②.

Opening the passenger-side trim panel



- ▶ Insert a suitable object such as a coin into the slot of lock ①.
- ▶ Turn lock ① by 90° in direction of the arrow.
- ▶ Remove cover ②.

Replacing bulbs

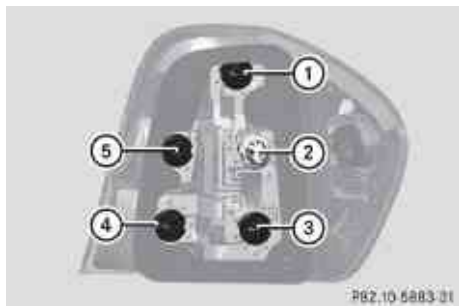

Example illustration: Standard rear lamp driver's side

- ① Brake lamp bulb socket
- ② Rear turn signal lamp bulb socket
- ③ Side marker lamp bulb socket
- ④ Tail lamp, parking and standing lamp and rear fog lamp (driver's side only) bulb socket
- ⑤ Backup lamp bulb socket

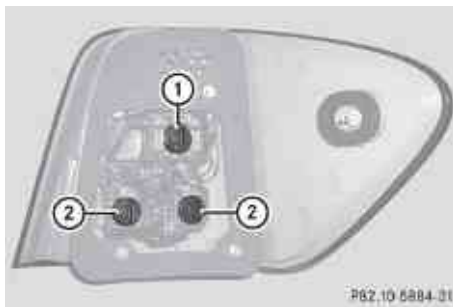

Example illustration: LED rear lamp driver's side

- ① Backup lamp bulb socket
 - ② Rear fog lamp bulb sockets (driver's side only)
- ▶ Depending on which bulb needs to be replaced, turn the respective bulb socket counterclockwise.
 - ▶ Pull the bulb socket out of the housing.
 - ▶ Standard rear lamp: Gently press onto the bulb and turn it counterclockwise out of its bulb socket.
LED rear lamp: Pull the bulb out of its bulb socket.
 - ▶ Standard rear lamp: Gently press the new bulb into its bulb socket and turn it clockwise until it engages.
LED rear lamp: Gently press the new bulb into its bulb socket.
 - ▶ Align the bulb socket and turn it clockwise.
 - ▶ Make sure the bulb socket is attached properly.
 - ▶ Close the respective cover in the cargo compartment.
 - ▶ Close the tailgate.

License plate lamps

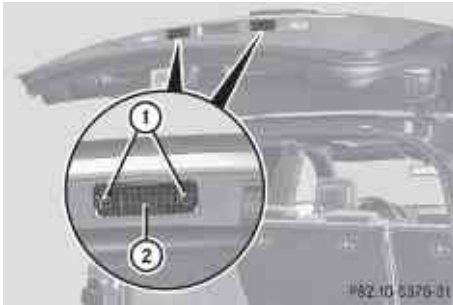

- ▶ Loosen screws ① of lamp cover to be removed.
- ▶ Remove lamp cover ②.
- ▶ Replace the bulb.
- ▶ Reinstall lamp cover ②.
- ▶ Retighten screws ①.

Adjusting headlamp aim

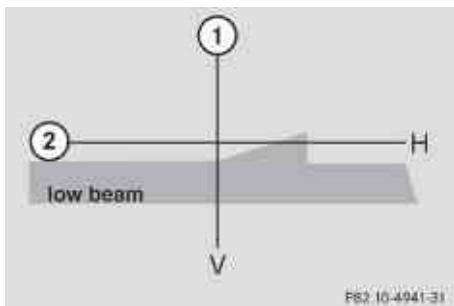

- ① **V** Vertical centerline
- ② **H** Horizontal mounting height, measured from the center

Correct headlamp adjustment is extremely important. High beam adjustments simultaneously aim the low beam. To check and readjust a headlamp, follow the steps described:

- ▶ Park the vehicle on a level surface 25 feet (7.6 m) from a vertical test screen or wall.
- ▶ Make sure the vehicle has a normal tailgate load.
- ▶ Switch on the low beam headlamps .

If the beam does not show a beam pattern as indicated in the figure left, then follow the steps below:

- ▶ Open the hood (▷ page 212).



The adjustment screws are located under the cover panel.

- ▶ Insert a suitable tool into the openings in the panel cover. The direction of arrows ③ and ④ indicate the angle in which the tool has to be inserted in order to access the adjustment screws.
- ▶ Always turn the adjustment screws equally for vertical adjustment until the headlamp is adjusted as shown in ①. Turn clockwise for upward movement and counterclockwise for downward movement.

Graduations:

- Screw at arrow ③: 0.67° pitch
- Screw at arrow ④: 0.50° pitch

The left and right headlamps must be adjusted individually.

- i** If it is not possible to obtain a proper headlamp adjustment, have the system checked at an authorized Mercedes-Benz Center.

Replacing wiper blades

Safety notes

Warning!

For safety reasons, switch off the wipers and remove the SmartKey from the starter switch (vehicles with KEYLESS-GO: Make sure the vehicle's on-board electronics have status **0**) before replacing a wiper blade. Otherwise, the wiper motor could suddenly turn on and cause injury.

Warning!

Wiper blades are components that are subject to wear and tear. Replace the wiper blades twice a year, preferably in the spring and fall. Otherwise the windows will not be wiped properly. As a result, you may not be able to observe surrounding traffic conditions and could cause an accident.

- !** Never open the hood when a front wiper arm is folded forward.

Hold on to the wiper when folding a wiper arm back. If released, the force of the impact from the tensioning spring could crack the windshield or the rear window.

Do not allow a wiper arm to contact the windshield glass or the rear window without a wiper blade inserted.

Mercedes-Benz recommends that you have this work carried out at an authorized Mercedes-Benz Center.

- ▶ Remove the SmartKey from the starter switch.

Vehicles with KEYLESS-GO:

- ▶ Make sure the vehicle's on-board electronics have status **0** (▷ page 80).

Removing wiper blades

Front wiper blades

- !** Do not pull on the wiper blade inserts. They could tear.
- ▶ Fold the wiper arms forward until they engage.

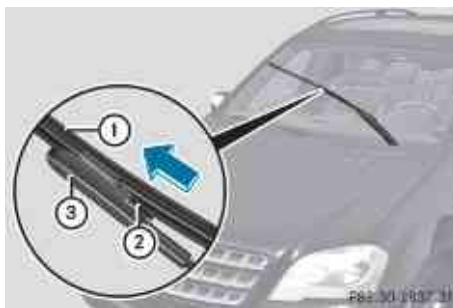

- ▶ Press tabs ② together.
- ▶ Tilt wiper blade ① away from wiper arm ③.
- ▶ Take off wiper blade ① in direction of arrow.

Rear wiper blade

- !** Do not pull on the wiper blade insert. It could tear.

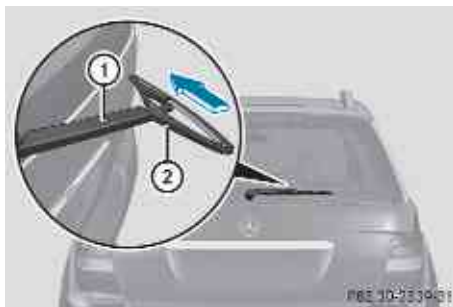

- ▶ Fold wiper arm ① away from the rear window until it engages.
- ▶ Turn wiper blade ② as far as it will go.

- ▶ Hold wiper arm ① and disengage wiper blade ② by carefully sliding it in direction of arrow.
- ▶ Remove wiper blade ②.

Installing wiper blades

Front wiper blades

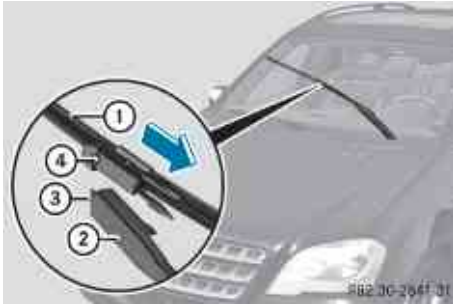

- ▶ With guide tab ③ sliding into opening ④, place wiper blade ① onto wiper arm in direction of arrow.
 - ▶ Fold wiper blade ① towards wiper arm. Tabs ② (▷ page 318) must engage into both recesses of attachment ②.
 - ▶ Check whether the wiper blade is securely fastened.
 - ▶ Fold the wiper arm backward to rest on the windshield. Make sure you hold on to the wiper arm when folding it back.
- !** Make sure the wiper blades are installed properly. Improperly installed wiper blades may cause windshield damage.

Rear wiper blade

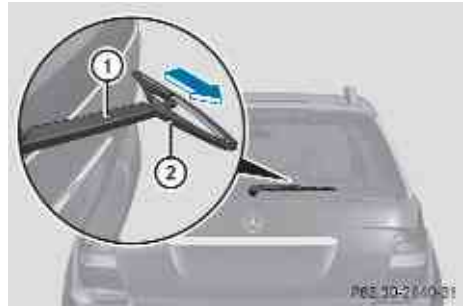

- ▶ Insert wiper blade ② into wiper arm ①.
 - ▶ Hold wiper arm ① and engage wiper blade ② by pushing it in direction of arrow until it locks into place.
 - ▶ Check whether the wiper blade is securely fastened.
 - ▶ Fold wiper arm ① to rest on the rear window. Make sure to hold on to the wiper when folding the wiper arm back.
- !** Make sure the wiper blade is installed properly. An improperly installed wiper blade may cause rear window damage.

Flat tire

Safety notes

Your vehicle may be equipped with:

- a Minispare wheel
- a spare wheel with collapsible tire
- an MOExtended system (your vehicle does not have a spare wheel or a TIREFIT kit)
- a TIREFIT kit³⁰ (your vehicle does not have a spare wheel)

For information on your vehicle's equipment, see "Rims and tires" (▷ page 352).

³⁰ Canada only.

 **Warning!**

The dimensions of the spare wheel are different from those of the road wheels. As a result, the vehicle handling characteristics change when driving with a spare wheel mounted. Adapt your driving style accordingly.

The spare wheel is for temporary use only. When driving with a spare wheel mounted, ensure proper tire inflation pressure and do not exceed a vehicle speed of 50 mph (80 km/h).

Contact the nearest authorized Mercedes-Benz Center as soon as possible to have the spare wheel replaced with a regular road wheel.

Never operate the vehicle with more than one spare wheel mounted.

Do not switch off the ESP® when a spare wheel is mounted.

 **Warning!**

Vehicles with air suspension program:

Do not open or close any doors or the tailgate while mounting a spare wheel. The vehicle could rise or lower to a previously selected level. You or others could be injured as a result.

Preparing the vehicle

- ▶ Vehicles with air suspension program: Make sure the vehicle level is set to highway level (▷ page 155).
- ▶ Whenever possible, park the vehicle in a safe distance from moving traffic on a hard, flat surface.
- ▶ Turn on the hazard warning flasher.
- ▶ Turn the steering wheel so that the front wheels are in a straight-ahead position.
- ▶ Engage the parking brake.
- ▶ Shift the automatic transmission into park position **P**.
- ▶ Turn off the engine.

- ▶ Remove the SmartKey from the starter switch.

or

- ▶ Vehicles with KEYLESS-GO: Open the driver's door (this puts the starter switch in position **0**, same as with the SmartKey removed from the starter switch). The driver's door can then be closed again. Open doors only when conditions are safe to do so.
- ▶ Vehicles with KEYLESS-GO: Remove the KEYLESS-GO start/stop button from the starter switch.
- ▶ Have any passenger exit the vehicle at a safe distance from the roadway. Open doors only when conditions are safe to do so.

-  Vehicles with spare wheel with collapsible tire or TIREFIT:

Only use the power outlet in the second-row footwell for electric air pump operation.

You can use the power outlet even when the ignition is switched off, e.g. in order to inflate the collapsible tire.

An emergency shut-off feature is designed to prevent the vehicle's on-board voltage from dropping below a minimum level. If the on-board voltage drops to this minimum level, the power outlets are switched off automatically to help preserve engine starting power.

Sealing tires with TIREFIT

Small tire punctures, particularly those in the tread, can be sealed with TIREFIT.

TIREFIT can be used in ambient temperatures down to -4°F (-20°C).

 **Warning!**

TIREFIT is a limited repair device. TIREFIT cannot be used for cuts or punctures larger than approximately 0.16 in (4 mm) and tire

damage caused by driving with extremely low tire inflation pressure, or on a flat tire, or a damaged wheel.

Do not drive the vehicle under such circumstances.

Contact the nearest authorized Mercedes-Benz Center for assistance or call Roadside Assistance.

- ▶ Foreign objects (e.g. screws or nails) should not be removed from the tire.
- ▶ Take the TIREFIT kit, the sticker, and the electric air pump out of the cargo compartment (▷ page 268).

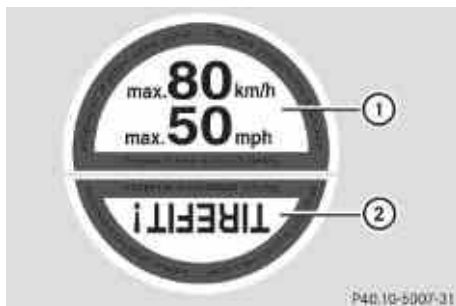

Two-part sticker

- ▶ Attach upper part ① of the sticker where it will be easily seen by the driver on the instrument cluster.
- ▶ Attach lower part ② of the sticker to the damaged tire (close to the tire valve).

Warning!

Take care not to allow the contents of TIREFIT to come in contact with hair, eyes or clothing. TIREFIT is harmful if inhaled, swallowed or absorbed through the skin - causes skin, eye and respiratory irritation.

Any contact with eyes or skin should be flushed immediately with plenty of water.

If clothing comes in contact with TIREFIT, change clothing as soon as possible.

In case of allergic reaction or rash, consult a physician immediately.

Warning!

Keep TIREFIT out of reach of children. If swallowed, rinse mouth immediately with plenty of water and drink plenty of water.

Do not induce vomiting!

Consult a physician immediately.

- ❗ If sealant has leaked out, let it dry. You can then peel it off.

If clothing has come in contact with TIREFIT, have it dry-cleaned with perchloroethylene as soon as possible.

Warning!

Observe safety instructions on air pump label.

Your vehicle may be equipped with either of two versions of the electric air pump:

- **Version 1:** The air hose with pressure gauge and the electrical plug are located behind a flap.
- **Version 2:** The pressure gauge is located in the pump housing. The air hose and electrical plug are located at the bottom of the pump housing.

The following description applies to both versions. Differences in usage are expressly declared.



Version 1

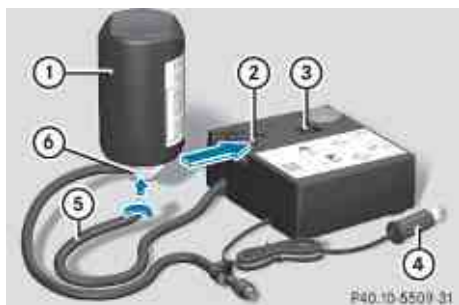

Version 2

- ▶ **Version 1 only:** Open flap (7) on the electric air pump.
- ▶ Pull plug (4) and air hose (5) out of the pump housing.
- ▶ Screw the air pump's air hose (5) onto flange (6) of TIREFIT container (1).
- ▶ Stick TIREFIT container (1) upside down into notch (2) of the electric air pump.

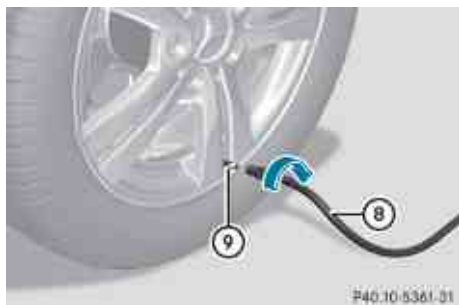

Example illustration

- ▶ Unscrew the valve cap of the damaged tire from tire valve (9).



Version 1

- ▶ **Version 1 only:** Close vent screw (10) on pressure gauge (11).
- ▶ Screw filler hose (8) onto tire valve (9).
- ▶ Insert electrical plug (4) into the power outlet in the second-row footwell (▷ page 197).

I The cigarette lighter as well as the power outlets in the passenger footwell and cargo compartment are not designed for use with the electric air pump. Use the power outlet in the second-row footwell for electric air pump operation.

- ▶ Turn the SmartKey in the starter switch to position 1.

or

- ▶ Vehicles with KEYLESS-GO: Press the KEYLESS-GO start/stop button once. Do not depress the brake pedal.
- ▶ Press I on electric air pump switch (3). The electric air pump is switched on and inflates the tire.

i First, the sealing is pumped into the tire. The pressure may briefly rise to up to 73 psi (5 bar). This is normal and not an indication of a malfunction. **Do not switch off the electric air pump.**

- ▶ Let the electric air pump inflate the tire for approximately 5 minutes. The pressure gauge must display at least 26 psi (1.8 bar).

⚠ Warning!

The air hose can become hot during inflation. Please exercise appropriate caution.

- ❗ Do not operate the electric air pump longer than 8 minutes without interruption. Otherwise it may overheat.

You may operate the air pump again after it has cooled off.

If the tire inflation pressure of at least 26 psi (1.8 bar) is not attained:

- ▶ Turn off the electric air pump by pressing **0** on electric air pump switch ③.
- ▶ Detach filler hose ⑧ from tire valve ⑨.
- ▶ Drive vehicle back or forth very slowly approximately 30 ft (10 m).
This serves to better distribute the TIREFIT sealant material inside the tire.
- ▶ Inflate the tire again.

⚠ Warning!

If a tire inflation pressure of 26 psi (1.8 bar) is not attained, the tire is too severely damaged for TIREFIT to provide a reliable tire repair.

In this case, TIREFIT cannot properly seal the tire.

Do not drive the vehicle.

Contact the nearest Mercedes-Benz Center or call Roadside Assistance.

After attaining a tire inflation pressure of at least 26 psi (1.8 bar):

- ▶ Press **0** on electric air pump switch ③.
The electric air pump is switched off.
- ▶ Detach the TIREFIT kit from the tire valve.

⚠ Warning!

The air hose may still be hot. Exercise proper caution to avoid burning yourself when detaching the electric air pump.

- ❗ Remaining TIREFIT sealant could escape from the filler hose after it has been

detached from the tire valve. TIREFIT sealant may cause stains.

Therefore, cover the filler hose, e.g. by inserting it into the plastic bag the TIREFIT kit was packed in.

▶ Drive off immediately.**⚠ Warning!**

Do not exceed a vehicle speed of 50 mph (80 km/h). A TIREFIT repair is not designed to operate at higher speeds.

The sticker must be attached on the instrument cluster where it will be easily seen by the driver.

Vehicle handling characteristics of a TIREFIT repaired tire may change. Adapt your driving accordingly.

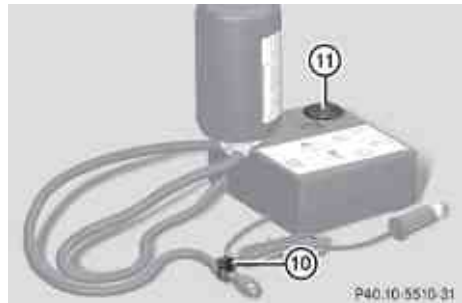

Version 2

- ▶ After driving the vehicle for an initial 10 minutes, check the tire inflation pressure using pressure gauge ⑪ on the air pump.

⚠ Warning!

If tire inflation pressure has fallen below 20 psi (1.3 bar) do not continue to drive the vehicle.

Park your vehicle safely away from the roadway and contact the nearest authorized Mercedes-Benz Center or Roadside Assistance.

Have the damaged tire replaced.

If the tire inflation pressure is at least 20 psi (1.3 bar), inflate or deflate the tire to the correct tire inflation pressure (see Tire and Loading Information placard on the driver's door B-pillar):

- ▶ **To increase tire inflation pressure:**
Switch on the electric air pump.
- ▶ **To decrease tire inflation pressure:**
Version 1: Open vent screw (10) on pressure gauge (11) (▷ page 322).
Version 2: Press deflate button (10) located at the end of the filler hose.
- ▶ Drive to the nearest qualified workshop, e.g. an authorized Mercedes-Benz Center, to have the damaged tire replaced.
- ▶ Recommended duration of use: A maximum of 300 miles (500 km) at 50 mph (80 km/h) or below with the recommended tire inflation pressure.
- ▶ Contact an authorized Mercedes-Benz Center as soon as possible to obtain a new TIREFIT kit.
- ▶ Bring used TIREFIT materials to an authorized Mercedes-Benz Center for proper disposal.
- ▶ Replace your TIREFIT container every 4 years. Replacement containers are available at any authorized Mercedes-Benz Center.

Mounting the spare wheel

Introduction

- ▶ Prepare the vehicle as described (▷ page 320).
- ▶ Take the following out of the vehicle:
 - spare wheel
 - jack
 - wheel wrench
 - collapsible wheel chock

- alignment bolt
- electric air pump (required for vehicles with spare wheel with collapsible tire only)

For information on where to find the respective items, see “Where will I find ...?” (▷ page 268) and (▷ page 271).

- ❗ Vehicles without spare wheel are not factory-equipped with the tools required for a wheel change such as a jack or a wheel wrench. Some tools required for a wheel change are specific to your vehicle. Contact an authorized Mercedes-Benz Center to obtain the tools approved for your vehicle. This section describes the wheel change using the tools approved and recommended for your vehicle.

Lifting the vehicle

Warning!

When jacking up the vehicle, only use the jack which has been specifically approved by Mercedes-Benz for your vehicle.

The jack is designed exclusively for jacking up the vehicle at the jack take-up brackets built into both sides of the vehicle. Make sure the jack arm is fully seated in the jack take-up bracket. The jack must always be vertical when in use, especially on inclines or declines.

The jack is intended only for lifting the vehicle briefly for wheel changes. It is not suited for performing maintenance work under the vehicle. To help avoid personal injury, use the jack only to lift the vehicle during a wheel change.

Never get beneath the vehicle while it is supported by the jack. Keep hands and feet away from the area under the lifted vehicle. Always lower the vehicle onto sufficient capacity jackstands before working under the vehicle.

Always engage the parking brake firmly and block the wheels with wheel chocks or other

sizeable objects before raising the vehicle with the jack. Do not disengage the parking brake while the vehicle is raised.

Make sure that the ground on which the vehicle is standing and where you place the jack is solid, level and not slippery. If necessary, use a large underlay. On slippery surfaces, such as tiled floors, you should use a non-slip underlay, for example a rubber mat.

Do not use wooden blocks or similar objects to support the jack. Otherwise the jack may not be able to achieve its load-bearing capacity if it is not at its full height.

Never start the engine when the vehicle is raised.

Also observe the notes on the jack.

- ▶ Prevent the vehicle from rolling away by blocking wheels with wheel chocks or other sizeable objects.

When your vehicle is equipped with a wheel chock, it is included with the vehicle tool kit (▷ page 268). For information on setting up the collapsible wheel chock, see (▷ page 270).

Warning!

Only jack up the vehicle on level ground or on slight inclines/declines. Otherwise, the vehicle could fall off the jack and injure you or others.

Changing a wheel on a level surface

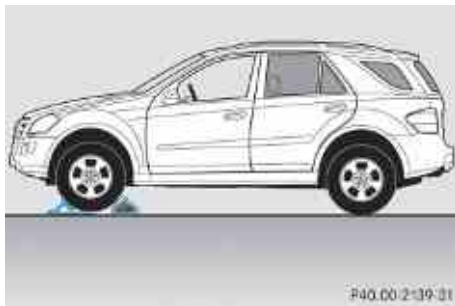

Changing rear wheel on passenger side (example illustration)

- ▶ Place a wheel chock or other sizeable object in front of and another wheel chock or other sizeable object behind the wheel that is diagonally opposite to the wheel being changed.

Changing a wheel on a slight decline

Always try lifting the vehicle using the jack on a level surface. However, should circumstances require you to do so on a slight decline:

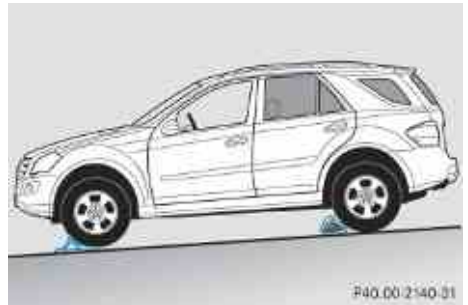

Changing wheel on passenger side (example illustration)

- ▶ Place wheel chocks or other sizeable objects on the downhill side in front of both wheels on the side opposite to the side on which the wheel is to be changed.

Changing a wheel on a slight incline

Always try lifting the vehicle using the jack on a level surface. However, should circumstances require you to do so on a slight incline:



Changing wheel on passenger side (example illustration)

- ▶ Place wheel chocks or other sizeable objects on the downhill side in front of both wheels on the side opposite to the side on which the wheel is to be changed.



- ▶ On the wheel to be changed, loosen but do not yet remove the wheel bolts (approximately one full turn with wheel wrench ①).
- ▶ Assemble the jack (▷ page 270).



The jack take-up brackets are located directly behind the front wheel housings and in front of the rear wheel housings.

Warning!

The jack is designed exclusively for jacking up the vehicle at the jack take-up brackets. Make sure the jack arm is fully seated in the jack take-up bracket.

If you do not position the jack correctly in the jack take-up bracket, the vehicle can fall off the jack and seriously or fatally injure you or others.

- ❗ Do not position the jack on the body of the vehicle, as this may cause damage to the vehicle.

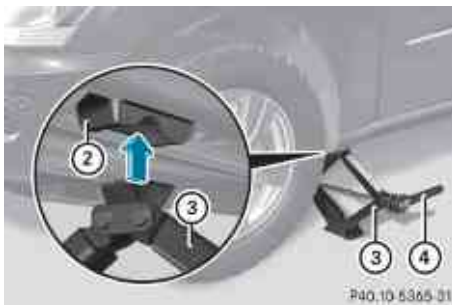

- ▶ Attach reversible ratchet ④ to jack ③ in such a way that the word **UP** can be seen.
- ▶ Place jack ③ on firm ground.
- ▶ Position jack ③ under take-up bracket ② so that it is always vertical as seen from the side, even if the vehicle is parked on an incline.

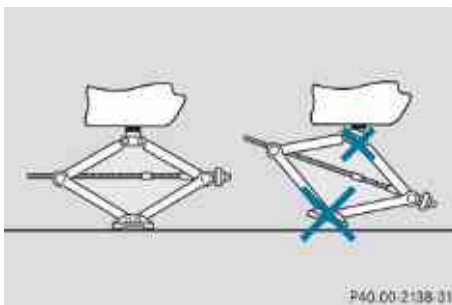

- ▶ Turn ratchet ④ up and down until jack ③ is fully seated in take-up bracket ② and the jack base evenly meets the ground.
- ▶ Jack up the vehicle until the wheel is a maximum of 1.2 in (3 cm) from the ground.

Removing the wheel



- ▶ Unscrew the uppermost wheel bolt and remove it.
 - ▶ Replace this wheel bolt with alignment bolt ①.
 - ▶ Remove the remaining bolts.
- !** Do not place wheel bolts in sand or dirt. This could result in damage to the wheel bolts and wheel hub threads.
- ▶ Remove the wheel.

Attaching the spare wheel

⚠ Warning!

Vehicles with spare wheel with collapsible tire only: Inflate collapsible tire only after the wheel is properly attached.

Inflate the collapsible tire using the electric air pump before lowering the vehicle.

⚠ Warning!

Always replace wheel bolts that are damaged or rusted.

Never apply oil or grease to wheel bolts.

Damaged wheel hub threads should be repaired immediately. Do not continue to drive under these circumstances! Contact an authorized Mercedes-Benz Center or call Roadside Assistance.

Incorrect wheel bolts or improperly tightened wheel bolts can cause the wheel to come off.

This could cause an accident. Make sure to use the correct wheel bolts.

⚠ Warning!

Only use genuine Mercedes-Benz wheel bolts. Other wheel bolts may come loose.

Do not tighten the wheel bolts when the vehicle is raised. Otherwise the vehicle could fall off the jack.

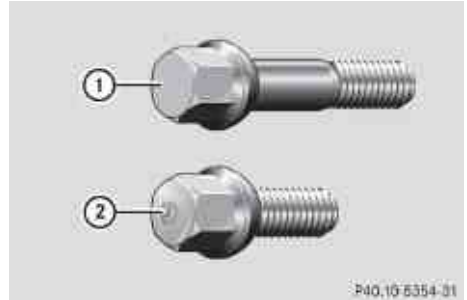

Wheel bolt ① must be used for 18", 19", 20" and 21" light alloy wheels as well as the spare wheel with collapsible tire. Wheel bolt ② must be used for the Minispare wheel. The wheel bolts for the Minispare wheel are located in vehicle tool kit.

- !** Wheel bolts ② must be used when mounting the Minispare wheel. The use of any wheel bolts other than wheel bolts ② for the Minispare wheel will damage the vehicle's brakes.

⚠ Warning!

Make sure to use the original length wheel bolts when remounting the original wheel after it has been repaired.

- ▶ Clean contact surfaces of wheel and wheel hub.
- !** To avoid paint damage, place wheel flat against hub and hold it there while installing first wheel bolt.



- ▶ Guide the spare wheel onto the alignment bolt and push it on.
- ▶ Insert the wheel bolts and tighten them slightly.
- ▶ Unscrew the alignment bolt.
- ▶ Install the last wheel bolt and tighten it slightly.
- ▶ **Vehicles with spare wheel with collapsible tire:** Continue the procedure by following the instructions under “Inflating the collapsible tire” (> page 328) and then “Lowering the vehicle” (> page 329).

or

- ▶ **Vehicles with Minispare wheel:** Continue the procedure by following the instructions under “Lowering the vehicle” (> page 329).

Inflating the collapsible tire

Warning!

Inflate collapsible tire only after the wheel is properly attached.

Inflate the collapsible tire using the electric air pump before lowering the vehicle.

Warning!

Observe safety instructions on air pump label.

- !** Do not lower the vehicle before inflating the collapsible tire. Otherwise the rim may be damaged.

Your vehicle may be equipped with either of two versions of the electric air pump:

- **Version 1:** The air hose with pressure gauge and the electrical plug are located behind a flap.
- **Version 2:** The pressure gauge is located in the pump housing. The air hose and electrical plug are located at the bottom of the pump housing.

The following description applies to both versions. Differences in usage are expressly declared.

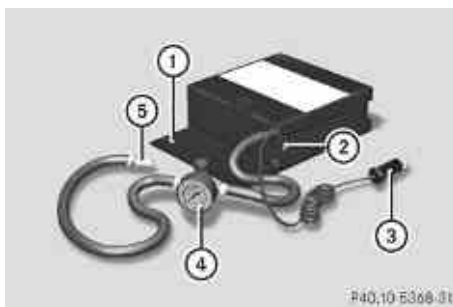

Version 1

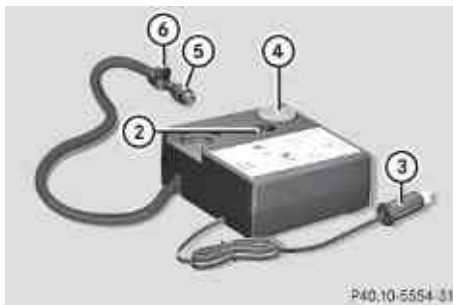

Version 2

- ▶ **Version 1 only:** Open flap ① on electric air pump.
- ▶ **Version 1 only:** Pull out electrical plug ③ and air hose with pressure gauge and vent screw ④.
- ▶ **Version 2 only:** Pull electrical plug ③ and the air hose out of the pump housing bottom.

- ▶ **Version 1 only:** Close vent screw on air hose ④.
- ▶ Remove the valve cap from the collapsible tire valve.
- ▶ Screw union nut ⑤ onto the collapsible tire valve.
- ▶ Make sure air pump switch ② is set to **0**.
- ▶ Insert electrical plug ③ into the power outlet in the second-row footwell (▷ page 197).

! The cigarette lighter as well as the power outlets in the passenger footwell and cargo compartment are not designed for use with the electric air pump. Use the power outlet in the second-row footwell for electric air pump operation.

- ▶ Turn the SmartKey in the starter switch to position **1**.

or

- ▶ Vehicles with KEYLESS-GO: Press the KEYLESS-GO start/stop button once. Do not depress the brake pedal.
- ▶ Press **I** on electric air pump switch ②. The electric air pump switches on and inflates the collapsible tire.
- ▶ Inflate the collapsible tire to the recommended tire inflation pressure as specified for your vehicle (▷ page 356). This should take approximately 5 minutes.

Warning!

The air hose and the union nut can become hot during inflation. Exercise proper caution to avoid burning yourself when using the equipment.

- !** Do not operate the electric air pump longer than 8 minutes without interruption. Otherwise it may overheat.

You may operate the air pump again after it has cooled off.

- !** Compare the recommended tire inflation pressure for your vehicle with the tire

inflation pressure on the yellow label located on the spare wheel rim.

If the tire inflation pressure on the yellow label on the spare wheel rim differs from the values given in this Operator's Manual, inflate the tire to the recommended tire inflation pressure given on the yellow label on the spare wheel rim.

- ▶ Press **0** on electric air pump switch ②.
 - ▶ Turn the SmartKey in the starter switch to position **0**.
- or
- ▶ Vehicles with KEYLESS-GO: Press the KEYLESS-GO start/stop button twice. Do not depress the brake pedal.
 - ▶ **Version 1 only:** If the tire inflation pressure is above the recommended tire inflation pressure as specified for your vehicle (▷ page 356), decrease tire pressure using the vent screw on air hose ④.
 - ▶ **Version 2 only:** If the tire inflation pressure is above the recommended tire inflation pressure as specified for your vehicle (▷ page 356), decrease tire pressure using deflate button ⑥.

Observe Safety notes, see page 221.

- ▶ Detach the electric air pump.
- ▶ Reinstall collapsible tire valve cap.
- ▶ **Version 1 only:** Store electrical plug ③ and air hose ④ behind flap ①.
- ▶ **Version 2 only:** Store electrical plug ③ and the air hose back into the pump housing bottom.
- ▶ Place the electric air pump back in its designated storage space.
- ▶ Lower the vehicle.

Lowering the vehicle

Warning!

Vehicles with spare wheel with collapsible tire only: Inflate collapsible tire only after the wheel is properly attached.

Inflate the collapsible tire using the electric air pump before lowering the vehicle.

- ▶ Attach ratchet to vehicle jack so that the word **DOWN** can be seen.

Lower the vehicle until the vehicle is resting fully on its own weight:

- ▶ Turn ratchet in direction **DOWN**.
- ▶ Remove the jack.



- ▶ Tighten the five wheel bolts evenly, following the diagonal sequence illustrated (① to ⑤), until all bolts are tight. Observe a tightening torque of 110 lb-ft (150 Nm).

Warning!

Have the tightening torque checked after changing a wheel. The wheels could come loose if they are not tightened to a torque of 110 lb-ft (150 Nm).

- ▶ Fully collapse the jack to storage position, see (▷ page 270).
- ▶ Store the jack and the other vehicle tools in the designated storage space.

For information on storing the spare wheel after it has been replaced by a regular road wheel, see (▷ page 271).

- i** The damaged road wheel cannot be stored in the spare wheel well under the cargo compartment floor. It should be transported in the cargo compartment wrapped in a protective wrap.

- i** USA only:

Do not restart the tire inflation pressure monitor until a full size wheel/tire with functioning sensor has been placed back into service on the vehicle.

MOExtended system

The MOExtended system allows you to continue driving your vehicle even if there is a total loss of pressure in one or more tires. You may only use the MOExtended system in conjunction with the tire pressure loss warning system (▷ page 222) or the Advanced TPMS (▷ page 223).

The maximum distance in emergency mode depends on the vehicle's load. It is 50 miles (80 km) if the vehicle is partially loaded and 18 miles (30 km) if the vehicle is fully loaded. The point at which the maximum driving distance in emergency mode begins is when the warning message appears in the multifunction display indicating that there is a loss of tire inflation pressure.

- ▶ Do not exceed the maximum speed of 50 mph (80 km/h).

Warning!

In emergency mode, your vehicle's driving characteristics are diminished in such situations as:

- driving around curves
- while braking
- while accelerating rapidly

Therefore, your driving style must be adapted accordingly. Avoid abrupt steering and driving maneuvers, as well as driving over obstacles (road curbs, potholes, or off-road areas). This is especially important if the vehicle is heavily loaded.

The emergency driving distance that can be achieved greatly depends on the demands placed on the vehicle. Depending on speed, load, driving maneuvers, road conditions, outside temperature, etc., the distance can be

significantly shorter or, if the vehicle is driven cautiously, somewhat longer.



Do not continue driving in emergency mode if

- you notice knocking sounds
- the vehicle starts to shake
- smoke develops and you smell rubber
- ESP® is intervening continuously
- you notice tears on the tire sidewalls

After driving in emergency mode, you must have the rims inspected by an authorized Mercedes-Benz Center to check if they are suitable for further use. The failed tire must be replaced in any case.

When replacing individual or all tires on the vehicle, make sure only tires marked with “MOExtended” are mounted in the size specified for your vehicle (▷ page 352).

Bleeding the fuel system (diesel engine only)

Driving the vehicle until the fuel tank is empty is not recommended. Otherwise, air may be sucked into the fuel system. If this happens, the malfunction indicator lamp  (USA only) or  (Canada only) comes on and the engine may not start immediately after refueling the vehicle.

After refueling:



- ▶ Make sure the automatic transmission is in park position **P**.
The transmission position indicator in the multifunction display should be on **P**.
- ▶ Do not depress the accelerator.
- ▶ If necessary, remove the KEYLESS-GO start/stop button from the starter switch.
- ▶ Turn the SmartKey in the starter switch to position **2** for at least 10 seconds.
- ▶ Return the SmartKey in the starter switch to position **0**.
- ▶ Turn the SmartKey in the starter switch to position **3** and hold it there for a maximum

of 10 seconds or until the engine runs surge-free.

If the engine does not start:

- ▶ Turn the SmartKey in the starter switch once more to position **2** for at least 10 seconds.
 - ▶ Return the SmartKey in the starter switch to position **0**.
 - ▶ Turn the SmartKey in the starter switch once more to position **3** and hold it there for a maximum of 10 seconds or until the engine runs surge-free.
 - ▶ If necessary, repeat the above steps.
- If the engine still does not start after 3 attempts:

Do not make any further attempts to start the engine. Contact an authorized Mercedes-Benz Center or call Roadside Assistance (▷ page 201).

- i** When the malfunction indicator lamp  (USA only) or  (Canada only) in the instrument cluster has been illuminated for the above condition, it will remain illuminated until the engine was cycled on and off four times in a row.

AdBlue® (diesel engine only)

The BlueTEC exhaust gas aftertreatment system requires a reducing agent (AdBlue®) in order to function properly. Refilling with AdBlue® is part of the regular maintenance service work. A tankful of AdBlue® should suffice until the next maintenance service under normal driving conditions.

When the AdBlue® tank is low, the message Check Additive See Operator's Manual appears in the multifunction display.

When the AdBlue® level drops to the minimum level, the message Remaining Starts: 20 appears in the multifunction display.

i When the message Remaining Starts: 20 appears in the multifunction display, you can start the engine 20 more times. If you do not add AdBlue®, the engine cannot be started beyond that point. Fill the AdBlue® tank with approximately 1 gal (3.79 l) AdBlue® (corresponds to approximately 2 AdBlue® refill containers) or have the AdBlue® tank filled by an authorized Mercedes-Benz Center.

i For refilling outside the maintenance service intervals, refill the AdBlue® tank with approximately 1 gal (3.79 l) AdBlue® (corresponds to approximately 2 AdBlue® refill containers).

Always use the particular AdBlue® refill containers for refilling outside the maintenance service interval. Contact an authorized Mercedes-Benz Center or call Roadside Assistance if necessary (▷ page 201).

Additional information on BlueTEC exhaust gas aftertreatment and AdBlue® is available at any authorized Mercedes-Benz Center.

Refilling with AdBlue®

Warning!

Make sure

- AdBlue® does not come into contact with skin, eyes, or clothing
- to keep AdBlue® out of the reach of children

If you and/or others have come into contact with AdBlue®:

- If AdBlue® has gotten into contact with eyes, flush with plenty of water immediately and seek medical help.
- Clean affected skin immediately with plenty of water.
- If AdBlue® was swallowed, rinse mouth immediately with plenty of water and drink plenty of water. Consult a physician.

Warning!

When opening the filler cap of the AdBlue® tank ammonia gas vapors may escape. Refill AdBlue® in a well ventilated area only.

Ammonia gas vapors have a pungent odor and are particularly irritating for your skin, mucous membranes, and eyes. Inhaling ammonia gas vapors will cause burning eyes, nose, and throat, as well as coughing and watering eyes.

! Only use AdBlue® complying with ISO 22241. Do not add additives to AdBlue® and do not dilute AdBlue® with water. Otherwise, the BlueTEC exhaust gas aftertreatment system could be damaged.

Damage caused by using additives or diluting with water are not covered by the Mercedes-Benz Limited Warranty.

! Rinse surfaces that have come into contact with AdBlue®, or remove AdBlue® with a moist cloth and cold water immediately. If AdBlue® has crystallized already, use cold water and a sponge. AdBlue® residues will crystallize and soil the affected surfaces.

! AdBlue® is not a fuel additive and must not be added to the diesel fuel tank. If AdBlue® reaches the diesel fuel tank, the engine could be damaged which is not covered by the Mercedes-Benz Limited Warranty.

For more information on AdBlue®, see (▷ page 361).

The AdBlue® filler neck is located under the cargo compartment floor.

- ▶ Switch off the ignition.
- ▶ Open the tailgate (▷ page 75).
- ▶ Lift the cargo compartment floor (▷ page 268).

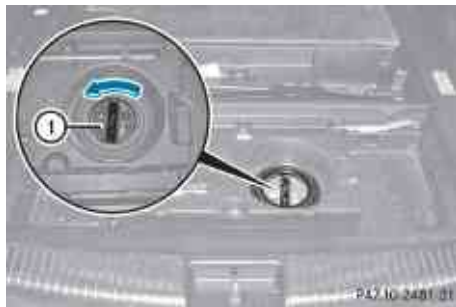

- ▶ Turn AdBlue® filler cap cover (1) counterclockwise and remove it.

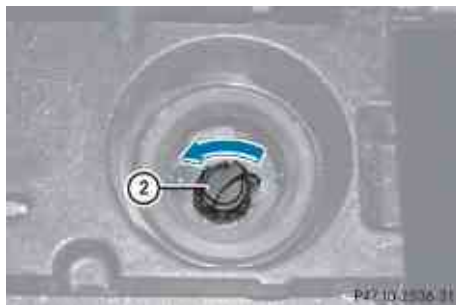

- ▶ Turn AdBlue® filler cap (2) counterclockwise and open it. Filler cap (2) is tethered with a plastic strap.



- ▶ Pull dust cap off of AdBlue® refill container (3).
- ▶ Place AdBlue® refill container (3) on the filler neck as illustrated and tighten it moderately (hand-tight) by turning it clockwise.
- ! Make sure to tighten the AdBlue® refill container only moderately, i.e. hand-tight, as you could otherwise damage it.
- ▶ Push AdBlue® refill container (3) down. The AdBlue® tank is filled. This may take up to 1 minute.

i When you stop pushing the AdBlue® refill container down, the filling process is stopped and you can remove the refill container.

- ▶ Release AdBlue® refill container (3).
- ▶ Turn AdBlue® refill container (3) counterclockwise and remove it.
- ▶ Place AdBlue® filler cap (2) (▷ page 332) on filler neck and turn it clockwise.

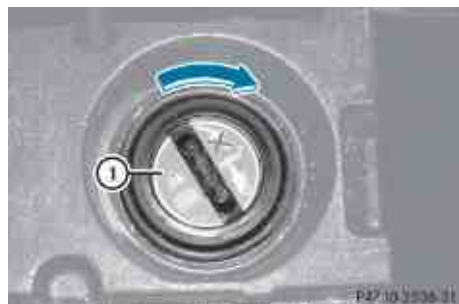

- ▶ Place AdBlue® filler cap cover ① as illustrated and turn it clockwise to its stop.
- ▶ Lower cargo compartment floor.
- ▶ Close the tailgate.
- ▶ Drive the vehicle at a speed of at least 10 mph (16 km/h).
The message Check Additive See Operator's Manual disappears after approximately 1 minute.

i If the message Check Additive See Operator's Manual still appears in the multifunction display, refill with one more container of AdBlue®.

i Have the AdBlue® level checked and, if necessary, filled completely afterward at an authorized Mercedes-Benz Center.

Battery

Safety notes

A battery should always be sufficiently charged in order to achieve its rated service life. Refer to Maintenance Booklet for battery maintenance intervals.

If you use your vehicle mostly for short-distance trips, you will need to have the battery charge checked more frequently.

When replacing a battery, always use a battery approved by Mercedes-Benz.

If you do not intend to operate your vehicle for an extended period of time, contact an authorized Mercedes-Benz Center about steps you need to observe.

Warning!

HYBRID vehicles: It is imperative that you read the HYBRID Supplemental Operating Instructions included in your vehicle literature portfolio. You may otherwise not recognize potential danger.

Warning!

Observe all safety instructions and precautions when handling automotive batteries.

Risk of explosion.



Fire, open flames and smoking are prohibited when handling batteries. Avoid creating sparks.



Battery acid is caustic. Do not allow it to come into contact with skin, eyes or clothing.



Wear suitable protective clothing, especially gloves, apron and faceguard.

Wear eye protection.



Rinse any acid spills immediately with clear water. Contact a physician if necessary.

Keep children away.



Follow the instructions in this Operator's Manual.



A battery contains materials that can harm the environment if disposed of improperly. A large 12 V storage battery contains lead. Recycling of the battery is the preferred method of disposal. Many states (USA only) or provinces (Canada only) require sellers of batteries to accept the old battery for recycling.

Warning!

Failure to follow these instructions can result in severe injury or death.

Never lean over batteries while connecting. You might get injured.

Battery fluid contains sulfuric acid. Do not allow this fluid to come in contact with eyes, skin or clothing. In case it does, immediately flush affected area with water and seek medical help if necessary.

A battery will also produce hydrogen gas, which is flammable and explosive. Keep flames or sparks away from battery, avoid improper connection of jumper cables, smoking etc.

Warning!

Do not place metal objects on the battery as this could result in a short circuit.

Use leak-proof batteries only to avoid the risk of acid burns in the event of an accident.

Take care that you do not become statically charged, e.g. by wearing synthetic clothing or rubbing against textiles. For this reason, you also should not pull or push the battery over carpets or other synthetic materials.

Never touch the battery first. First touch the outside body of the vehicle in order to release any possible electrostatic charges.

Do not rub the battery with rags or cloths. The battery could explode if touched due to electrostatic charge or due to spark formation.

! The battery is a Valve-Regulated Lead Acid (VRLA) battery, also referred to as “fleece” battery.

Such batteries do not require topping-up of the electrolyte level. VRLA batteries therefore do not have cell caps and the battery cover is non-removable. Do not attempt to open the battery as otherwise the battery will be damaged.

VRLA batteries do not require topping-up of the electrolyte level. They cannot be opened to check the electrolyte level. However, the battery condition must be checked periodically by performing a battery conductance test. Refer to Maintenance Booklet for battery condition testing intervals.

The factory-equipped battery may only be replaced with a battery that

- has the same security features
- is of identical size
- is of identical voltage
- is of identical capacity

! As any other battery, the battery may discharge if you do not operate the vehicle for an extended period of time. Have the battery disconnected at a qualified workshop or an authorized Mercedes-Benz Center in such a case. You may also connect an accessory battery charge unit expressly approved by Mercedes-Benz for your vehicle model to maintain the battery charge. Contact an authorized Mercedes-Benz Center for further information.

The battery, the battery ventilation hose and the lateral plug must always be securely installed when the vehicle is in operation.

! Never loosen or detach battery terminal clamps while the engine is running or the SmartKey is in the starter switch or KEYLESS-GO button is in position 1. Otherwise the alternator and other electronic components could be severely damaged.

Have the battery checked regularly at an authorized Mercedes-Benz Center.

Refer to Maintenance Booklet for maintenance intervals or contact an authorized Mercedes-Benz Center for further information.

i After battery power was interrupted, do the following:

- Set the clock (▷ page 132).
Vehicles with COMAND system with navigation module: Time and date are set automatically.
- Synchronize the door windows (▷ page 102).

- Synchronize the power tilt/sliding sunroof (▷ page 186).
- Synchronize the exterior rear view mirrors (▷ page 91).

Charging the battery

Warning!

Never charge a battery while still installed in the vehicle unless the accessory battery charge unit approved by Mercedes-Benz is being used. Gases may escape during charging and could cause an explosion that may result in personal injury, paint damage or corrosion.

An accessory battery charge unit specially adapted for Mercedes-Benz vehicles and tested and approved by Mercedes-Benz is available. It permits the charging of the battery in its installed position. Contact an authorized Mercedes-Benz Center for information and availability.

Charge battery in accordance with the separate instructions for the accessory battery charger.

Have the battery charged at an authorized Mercedes-Benz Center. If you charge the battery yourself, follow the operating instructions for your charging device.

Only use a battery charge unit with a maximum charging voltage of 14.8 V.

- ▶ Charge battery in accordance with the instructions of the battery charger manufacturer.

Jump starting

Warning!

Failure to follow these directions will cause damage to the electronic components, and

can lead to a battery explosion and severe injury or death.

Never lean over batteries while connecting or jump starting. You might get injured.

Battery fluid contains sulfuric acid. Do not allow this fluid to come in contact with eyes, skin or clothing. In case it does, immediately flush affected area with water, and seek medical help if necessary.

A battery will also produce hydrogen gas, which is flammable and explosive. Keep flames or sparks away from battery, avoid improper connection of jumper cables, smoking, etc.

Attempting to jump start a frozen battery can result in it exploding, causing personal injury. Read all instructions before proceeding.

Warning!

HYBRID vehicles: It is imperative that you read the HYBRID Supplemental Operating Instructions included in your vehicle literature portfolio. You may otherwise not recognize potential danger.

- ❗ Do not tow-start the vehicle. You could otherwise seriously damage the automatic transmission which is not covered by the Mercedes-Benz Limited Warranty.

- ❗ Jump starting should only be performed using the jump-start terminals located in the engine compartment.

Avoid repeated and lengthy starting attempts.

Do not attempt to start the engine using a battery quick-charge unit.

If the engine does not run after several unsuccessful starting attempts, have it checked at the nearest authorized Mercedes-Benz Center.

Excessive unburned fuel generated by repeated failed starting attempts may

damage the catalytic converter³¹ and may present a fire risk.

Make sure the jumper cables do not have loose or missing insulation.

Make sure the cable clamps do not touch any other metal part while the other end is still attached to a battery.

If the battery is discharged, the engine can be started with jumper cables and the fully charged battery of another vehicle or an equivalent starter pack. Observe the following:

- Access to the battery is not possible on all vehicles. If you cannot access the battery of the other vehicle, provide jump start power by an external battery or starter pack.
- Jump starting should only be performed when the engine and catalytic converter³² are cold.
- Do not start the engine if the battery is frozen. Let the battery thaw out first.
- Only jump start from batteries with the same voltage rating (12 V). Jump starting

with a more powerful battery could damage the vehicle's electrical system. Such damage will not be covered by the Mercedes-Benz Limited Warranty.

- Only use jumper cables with sufficient cross-section and insulated terminal clamps.
- Always make sure the jumper cables are not on or near pulleys, fans or other parts that move when an engine is started or running.
- Should the battery be drained completely, let the donating power source charge the vehicle for several minutes before reattempting the starting process.

The jump-start contacts are located in the engine compartment on the passenger side.

- ▶ Make sure the two vehicles do not touch.
- ▶ Switch off all electrical consumers.
- ▶ Engage the parking brake.
- ▶ Make sure the automatic transmission is in park position **P**.
- ▶ Open the hood (> page 213).

³¹ Vehicles with gasoline engine only.

³² Vehicles with gasoline engine only.

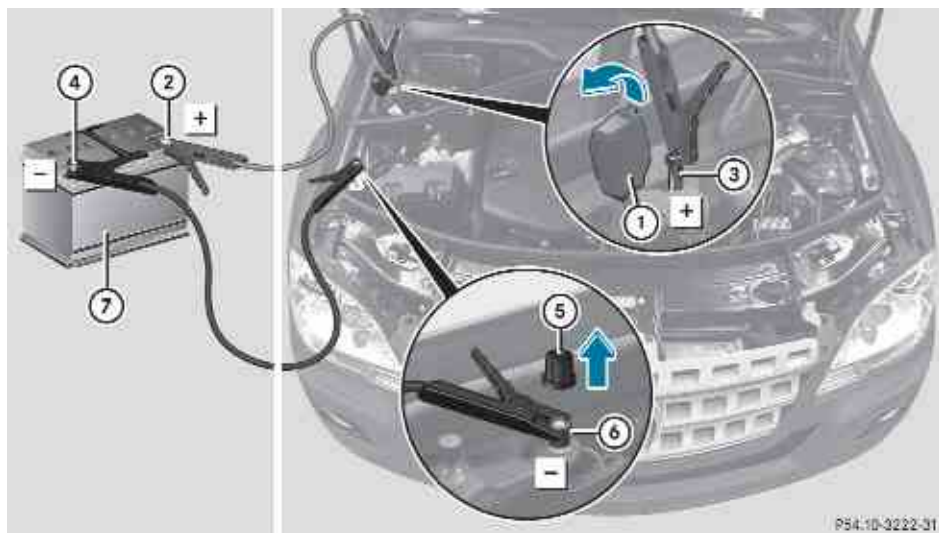

P54.10-3222-31

Position ⑦ represents the charged battery of another vehicle or an equivalent starter pack.

- ▶ Flip up cover ① of positive terminal ③ in direction of arrow.

! Never invert the terminal connections!

- ▶ Connect positive terminal ② of charged battery ⑦ with positive terminal ③ with a jumper cable. Clamp the cable to positive terminal ② of charged battery ⑦ first.
- ▶ Start engine of the vehicle with charged battery ⑦ and run at idle speed.
- ▶ Slide cover ⑤ from negative terminal ⑥ in direction of arrow.
- ▶ Connect negative terminal ④ of charged battery ⑦ with negative terminal ⑥ with a jumper cable. Clamp the cable to negative terminal ④ of charged battery ⑦ first.
- ▶ Start engine of the vehicle with the discharged battery and run at idle speed. You can now turn on the electrical consumers. Do not switch on the headlamps under any circumstances.

- ▶ Remove the jumper cables from negative terminals ④ and ⑥ first.
- ▶ Remove the jumper cables from positive terminals ② and ③. You can now switch on the headlamps.
- ▶ Close cover ① of positive terminal ③.
- ▶ Slide cover ⑤ back onto negative terminal ⑥.
- ▶ Have the battery checked at the nearest authorized Mercedes-Benz Center.

Towing the vehicle

Safety notes

Mercedes-Benz recommends that the vehicle be transported with all wheels off the ground using flatbed or appropriate wheel lift/dolly equipment. This method is preferable to other types of towing.

⚠ Warning!

HYBRID vehicles: It is imperative that you read the HYBRID Supplemental Operating Instructions included in your vehicle literature

portfolio. You may otherwise not recognize potential danger.

- ❗ To prevent damage during transport, do not tie down vehicle by its chassis or suspension parts.

If circumstances do not permit the recommended towing methods, the vehicle may be towed with all wheels on the ground only so far as necessary to have the vehicle moved to a safe location where the recommended towing methods can be employed.

- ❗ Before towing the vehicle observe the following instructions:

- Do not tow-start the vehicle. You could otherwise seriously damage the automatic transmission which is not covered by the Mercedes-Benz Limited Warranty.
- Do not tow with sling-type equipment. Towing with sling-type equipment over bumpy roads will damage radiator and supports.
- Towing of the vehicle should only be done using the properly installed towing eye bolt. Never attach a tow cable, tow rope or tow rod to the vehicle chassis, frame or suspension parts.

Warning!

With the engine not running, there is no power assistance for the brake and steering systems. In this case, it is important to keep in mind that a considerably higher degree of effort is necessary to brake and steer the vehicle. Adapt your driving accordingly.

- ❗ Avoid pulling the vehicle abruptly or diagonally, since it could result in damage to the chassis alignment.

- ❗ Do not use the towing eye bolt for recovery, as this could damage the vehicle. In doubt, recover the vehicle with a crane.

- ❗ If the battery is disconnected or discharged

- the SmartKey will not turn in the starter switch
- the automatic transmission will remain in park position **P**

For more information see “Battery”
(▷ page 334) or “Jump starting”
(▷ page 336).

Installing towing eye bolt

Depending on whether you are towing a vehicle or you are being towed, the towing eye bolt can be screwed into threaded holes which are located behind covers on each bumper.

The towing eye bolt is supplied with the vehicle tool kit, located in the cargo compartment underneath the cargo compartment floor (▷ page 268).

- ▶ Take the towing eye bolt out of the space underneath the cargo compartment floor.

Removing cover in front bumper



P88_20_3219-31



Vehicles with AMG Sport Package

- ▶ Press mark on cover ① as indicated by the arrow.
- ▶ Lift cover ① off to reveal the threaded hole for the towing eye bolt.

Removing cover in rear bumper

Warning!

In order to avoid possible serious burns or injury, use extreme caution when removing the rear cover, because the rear exhaust pipe is extremely hot.



Vehicles with Sport Package

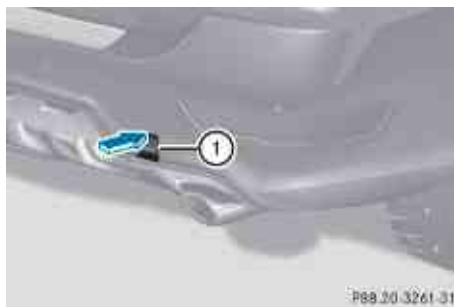

Vehicles with AMG Sport Package

- ▶ Press mark on cover ① as indicated by the arrow.
- ▶ Vehicles with Sport Package: Pry cover ① with a flat, blunt object as a lever.
- ▶ Vehicles with AMG Sport Package: Press mark on cover ① as indicated by the arrow.
- ▶ Lift cover ① off to reveal the threaded hole for the towing eye bolt.

Fixing towing eye bolt



Example illustration front bumper

- ▶ Take the towing eye bolt and, if so equipped, the wheel wrench from the vehicle tool kit.
- ▶ Screw towing eye bolt ② clockwise into threaded hole to its stop.
- ▶ Insert wheel wrench into towing eye and tighten towing eye bolt ② by turning it clockwise.

or

- ▶ If your vehicle is not equipped with a wheel wrench, use a suitable object to turn the towing eye bolt.

Removing towing eye bolt

- ▶ Loosen towing eye bolt ② by turning it counterclockwise.
- ▶ Unscrew towing eye bolt ②.
- ▶ **Reinstalling cover:** Engage cover ① (▷ page 339) at top and press at bottom.
- ▶ Store the towing eye bolt ② and wheel wrench back into the vehicle tool kit.

Towing with one axle raised

- ❗ The vehicle may be towed only for distances up to 30 miles (50 km) and at a speed not to exceed 30 mph (50 km/h).
- ❗ Vehicles with 4MATIC: Do not tow with one axle raised. Doing so could damage the

transfer case, which is not covered by the Mercedes-Benz Limited Warranty.

All wheels must be on or off the ground. Observe instructions for towing the vehicle with all wheels on the ground.

When towing the vehicle with one axle raised, the wheels on the ground have to move freely. Therefore follow the respective steps below, after the front or the rear axle being raised:

Towing with the front axle raised

- ▶ Switch off the automatic central locking (▷ page 135).
- ▶ Switch on the hazard warning flasher (▷ page 96).
- ▶ Make sure the automatic transmission remains in neutral position **N**. Observe instructions, see “Remaining in neutral position **N**” (▷ page 111).

❗ Because the ESP® operates automatically, the engine and ignition must be shut off (SmartKey in starter switch position **0** or **1** or KEYLESS-GO start/stop button in position **0** or **1**) when the vehicle is being towed with one axle raised.

Active braking action through the ESP® may otherwise seriously damage the brake system which is not covered by the Mercedes-Benz Limited Warranty.

❗ Keep in mind that it is important for the SmartKey to be left in starter switch with the ignition switched off. As soon as the SmartKey is removed from the starter switch the automatic transmission will shift to park position **P**.

Towing with the rear axle raised

- ▶ Switch off the ignition and remove the SmartKey from the starter switch.
- ▶ Switch on the hazard warning flasher (▷ page 96).
- ▶ Take the SmartKey or SmartKey with KEYLESS-GO with you when leaving the vehicle.

Towing with all wheels on the ground

Warning!

If circumstances require towing the vehicle with all wheels on the ground, always tow with a tow bar if:

- the engine will not run
- there is a malfunction in the brake system
- there is a malfunction in the power supply or in the vehicle's electrical system

This is necessary to adequately control the towed vehicle.

Prior to towing the vehicle with all wheels on the ground, make sure the SmartKey is in starter switch position **2**.

Warning!

With the engine not running, there is no power assistance for the brake and steering systems. In this case, it is important to keep in mind that a considerably higher degree of effort is necessary to brake and steer the vehicle. Adapt your driving accordingly.

- ▶ Make sure the ignition is switched on.
- ▶ With the vehicle at a standstill, depress the brake pedal and keep it pressed.
- ▶ Shift the automatic transmission into neutral position **N**.
- ▶ Release the brake pedal.
- ▶ If engaged, release the parking brake.
- ▶ Switch on the hazard warning flasher (▷ page 96).

 Keep in mind that it is important to have the ignition switched on. Removing the SmartKey from the starter switch or opening a front door with the ignition switched off will automatically shift the automatic transmission into park position **P**.

 The vehicle may be towed only for distances up to 30 miles (50 km) and at a speed not to exceed 30 mph (50 km/h).

 While being towed with the hazard warning flasher in use, use the combination switch in the usual manner to signal turns. Only the selected turn signal will operate. Upon canceling the turn signal, the hazard warning flasher will operate again.

Stranded vehicle

Freeing a stranded vehicle, on which the wheels are dug into sand or mud, should be done with the greatest of care, especially if the vehicle is heavily loaded.

Note the following when freeing a stranded vehicle:

- Avoid pulling the vehicle abruptly or diagonally, since it could result in damage to the chassis alignment.
- Never try to free a vehicle that is still coupled to a trailer.
- If possible, a vehicle equipped with a trailer hitch receiver should be pulled backward in its own previously made tracks.

Fuses

Introduction

The electrical fuses in your vehicle serve to switch off malfunctioning power circuits.

If a fuse is blown, the components and systems secured by that fuse will stop operating.

⚠ Warning!

Only use fuses approved by Mercedes-Benz with the specified amperage for the system in question and do not attempt to repair or bridge a blown fuse. Using other than approved fuses or using repaired or bridged fuses may cause an overload leading to a fire, and/or cause damage to electrical components and/or systems. Have the cause determined and remedied by an authorized Mercedes-Benz Center.

A blown fuse must be replaced by an appropriate spare fuse (recognizable by its color or the fuse rating given on the fuse) of the amperage recommended in the fuse chart. Any Mercedes-Benz Center will be glad to advise you on this subject.

- ❶ In case of a blown fuse contact Roadside Assistance or an authorized Mercedes-Benz Center.

If a newly inserted fuse blows again, have the cause determined and rectified by an authorized Mercedes-Benz Center.

The fuse chart is located in the cargo compartment with the vehicle tool kit (▷ page 268). The fuse chart explains the fuse allocation and fuse amperages.

Before replacing fuses

- ▶ Engage the parking brake.
- ▶ Make sure the automatic transmission is in park position **P**.
The transmission position indicator in the multifunction display should be on **P**.
- ▶ Switch off all electrical consumers.
- ▶ Turn off the engine.
- ▶ Remove the SmartKey from the starter switch.
- ▶ Vehicles with KEYLESS-GO: Open the driver's door (this puts the starter switch in position **0**, same as with the SmartKey removed from the starter switch). The driver's door then can be closed again.

Fuse box in passenger compartment

- ❗ Do not use sharp objects such as a screwdriver to open the fuse box cover in the dashboard. You could damage the fuse box cover or the dashboard.

The fuse box is located behind a cover in the dashboard on the front passenger side.



- ▶ Open the front passenger door.
- ▶ **Opening:** Open the glove box.
- ▶ **Opening:** Insert flat, blunt object as a lever into the edge of fuse box cover ❶ at the position indicated by the arrow.
- ▶ Loosen fuse box cover ❶ from the dashboard using the lever.
- ▶ Using your hands, pull fuse box cover ❶ out and remove.
- ▶ **Closing:** Hook fuse box cover ❶ into holders on the front of the dashboard.
- ▶ Press fuse box cover ❶ back on until it engages.

- ❗ The fuse box cover must be properly positioned as described. Otherwise, moisture or dirt could enter the fuse box and possibly impair fuse operation.

Fuse box in engine compartment

- ▶ Open the hood.

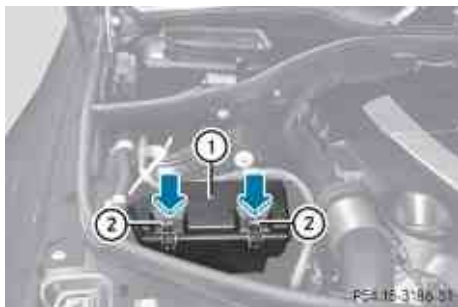

Example illustration fuse box ML 350 (ML 350 BlueTEC, ML 550, ML 63 AMG similar)

- ▶ With a dry cloth, remove any moisture from fuse box cover ①.
- ▶ **Opening:** Pull clamps ② in direction of arrow.
- ▶ Lift fuse box cover ① up.
- ▶ **Closing:** Make sure the sealing rubber is positioned properly.
- ▶ Press fuse box cover ① down and secure with clamps ②.

! The fuse box cover must be properly positioned as described. Otherwise, moisture or dirt could enter the fuse box and possibly impair fuse operation.

- ▶ Close the hood after checking or replacing fuses.

- ▶ **Opening:** Open the cargo compartment.
- ▶ Insert a suitable object such as a coin into the slot of lock ①.
- ▶ Turn lock ① by 90° in direction of arrow.
- ▶ Remove cover ②.
- ▶ **Closing:** Install everything in reverse order.

Emergency engine shutdown

If the engine cannot be turned off as described (▷ page 108), you may use the following emergency procedure.

- ▶ Take the fuse chart from the vehicle tool kit (▷ page 268).
- ▶ Open the fuse box in engine compartment.
- ▶ Remove fuse 120.
- ▶ Find its location in the fuse chart.

Fuse box in cargo compartment



Vehicle equipment	346
Parts service	346
Warranty coverage	346
Identification labels	346
Vehicle specification ML 350 Blue- TEC 4MATIC (164.125)	348
Vehicle specification ML 350 (164.156)	348
Vehicle specification ML 350 4MATIC (164.186)	349
Vehicle specification ML 550 4MATIC (164.172)	350
Vehicle specification ML 63 AMG (164.177)	351
Rims and tires	352
Fuels, coolants, lubricants, etc.	356



Vehicle equipment

i This Operator's Manual describes all features, standard or optional, potentially available for your vehicle at the time of purchase. Please be aware that your vehicle might not be equipped with all features described in this manual.

Parts service

All authorized Mercedes-Benz Centers maintain a stock of Genuine Mercedes-Benz Parts required for maintenance and repair work. In addition, strategically located parts distribution centers provide quick and reliable parts service.

More than 300 000 different parts for Mercedes-Benz models are available.

Genuine Mercedes-Benz Parts are subjected to stringent quality inspections. Each part has been specifically developed, manufactured or selected for and adapted to Mercedes-Benz vehicles.

Therefore, Genuine Mercedes-Benz Parts should be installed.

! Do not use non-genuine Mercedes-Benz parts and accessories not authorized by Mercedes-Benz. Doing so could damage the vehicle, which is not covered by the Mercedes-Benz Limited Warranty. Also, it could compromise the vehicle's durability or safety.

Warranty coverage

Your vehicle is covered under the terms of the warranties printed in the Service and Warranty Information booklet.

Your authorized Mercedes-Benz Center will exchange or repair any defective parts originally installed in the vehicle in

accordance with the terms of the following warranties:

- New Vehicle Limited Warranty
- Emission System Warranty
- Emission Performance Warranty
- California, Connecticut, Maine, Massachusetts, New York, Pennsylvania, Rhode Island, and Vermont Emission Control Systems Warranty³³
- State Warranty Enforcement Laws (Lemon Laws)

Replacement parts and accessories are covered by the Mercedes-Benz Parts and Accessories warranties, copies of which are available at any authorized Mercedes-Benz Center.

Loss of Service and Warranty Information booklet

Should you lose your Service and Warranty Information booklet, have an authorized Mercedes-Benz Center arrange for a replacement. It will be mailed to you.

Identification labels

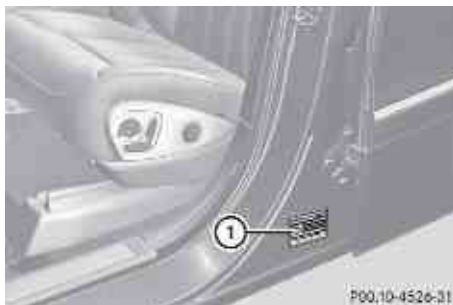

³³ Applicable to vehicles with gasoline engine only.

The Vehicle Identification Number (VIN) can be found

- on certification label ① on the driver’s door B-pillar
- on passenger side underneath the rear seat (▷ page 347)
- on the lower edge of the windshield (▷ page 347)

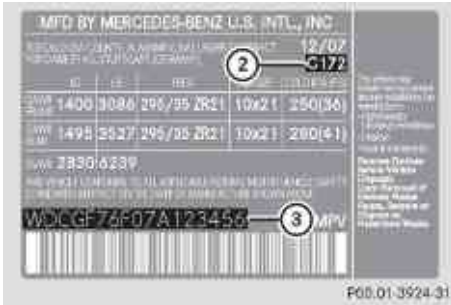

Example certification label (U.S. vehicles)

- ② Paintwork code
- ③ VIN



Example certification label (Canada vehicles)

- ② Paintwork code
- ③ VIN

i Data shown on certification label are for illustration purposes only. These data are specific to each vehicle and may vary from

data shown in the illustration. Refer to certification label on vehicle for actual data specific to your vehicle.

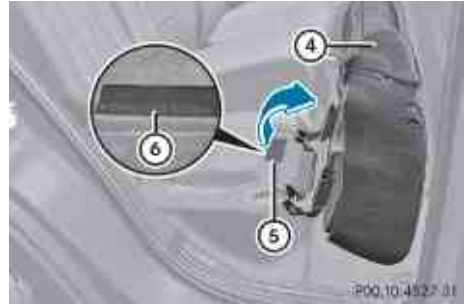

Passenger-side rear seat

- ▶ Fold seat cushion ④ forward (▷ page 189).
- ▶ Fold carpet ⑤ forward in direction of arrow. VIN ⑥ is now visible.

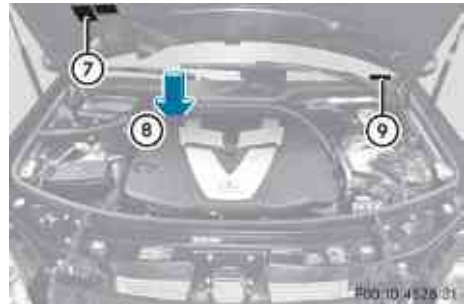

- ⑦ Emission control information label, includes both federal and California certification exhaust emission standards
- ⑧ Engine number (engraved on engine)
- ⑨ VIN (on lower edge of windshield)

i When ordering parts, please specify vehicle identification and engine number.

Vehicle specification ML 350 BlueTEC 4MATIC (164.125)

The quoted data apply only to the standard vehicle. Contact an authorized Mercedes-Benz Center for the corresponding data of all special bodies and special equipment.

Engine ML 350 BlueTEC 4MATIC	
Engine, type	642
Mode of operation	Diesel 4-stroke engine
No. of cylinders	6
Bore	3.27 in (83.00 mm)
Stroke	3.62 in (92.00 mm)
Total piston displacement	182.3 cu in (2 987 cm ³)
Compression ratio	16.5:1
Output acc. to SAE J 1349	210 hp/3 400 rpm (157 kW/3 400 rpm)
Maximum torque acc. to SAE J 1349	400 lb-ft/ 1 600 - 2 400 rpm (543 Nm/ 1 600 - 2 400 rpm)
Maximum engine speed	4 500 rpm
Firing order	1-4-2-5-3-6
Poly-V-belt	2 035 mm

Electrical system ML 350 BlueTEC 4MATIC	
Alternator	14 V/220 A
Starter motor	12 V/2.0 kW
Battery	12 V/95 Ah

Main dimensions ML 350 BlueTEC 4MATIC

Overall vehicle length	188.5 in (4 788 mm)
Overall vehicle width ³⁴	83.6 in (2 124 mm)
Overall vehicle height	71.5 in (1 815 mm) ³⁵ 69.8 - 73.0 in (1 774 - 1 854 mm) ³⁶
Wheelbase	114.8 in (2 915 mm)
Track, front	63.7 in (1 619 mm)
Track, rear	63.8 in (1 621 mm)
Ground clearance	8.3 in (210 mm) ³⁵ 7.3 - 10.3 in (186 - 261 mm) ³⁶
Turning circle	39.0 ft (11.6 m)

Weights ML 350 BlueTEC 4MATIC

Roof load	max. 220 lb (100 kg)
-----------	----------------------

Vehicle specification ML 350 (164.156)

The quoted data apply only to the standard vehicle. Contact an authorized Mercedes-Benz Center for the corresponding data of all special bodies and special equipment.

Engine ML 350

Engine, type	272
Mode of operation	4-stroke engine, gasoline injection
No. of cylinders	6

³⁴ Exterior rear view mirrors folded out.

³⁵ Vehicles with steel suspension.

³⁶ Depending on the set vehicle level (vehicles with air suspension program).

Engine ML 350	
Bore	3.66 in (92.90 mm)
Stroke	3.39 in (86.00 mm)
Total piston displacement	213.5 cu in (3 498 cm ³)
Compression ratio	10.7:1
Output acc. to SAE J 1349³⁷	268 hp/6 000 rpm (200 kW/6 000 rpm)
Maximum torque acc. to SAE J 1349	258 lb-ft/ 2 400 - 5 000 rpm (350 Nm/ 2 400 - 5 000 rpm)
Maximum engine speed	6 500 rpm
Firing order	1-4-3-6-2-5
Poly-V-belt	2 398 mm

Electrical system ML 350	
Alternator	14 V/180 A
Starter motor	12 V/1.4 kW
Battery	12 V/70 Ah
Spark plugs, type	Bosch Y 7 MPP33
Spark plugs, electrode gap	0.031 in (0.8 mm)
Spark plugs, tightening torque	15 - 18 lb-ft (20 - 25 Nm)

Main dimensions ML 350	
Overall vehicle length	188.5 in (4 788 mm)
Overall vehicle width³⁸	83.6 in (2 124 mm)
Overall vehicle height	71.5 in (1 815 mm)
Wheelbase	114.8 in (2 915 mm)
Track, front	64.0 in (1 627 mm)
Track, rear	64.1 in (1 629 mm)
Ground clearance	8.3 in (210 mm)
Turning circle	39.0 ft (11.6 m)

Weights ML 350	
Roof load	max. 220 lb (100 kg)

Vehicle specification ML 350 4MATIC (164.186)

The quoted data apply only to the standard vehicle. Contact an authorized Mercedes-Benz Center for the corresponding data of all special bodies and special equipment.

Engine ML 350 4MATIC	
Engine, type	272
Mode of operation	4-stroke engine, gasoline injection
No. of cylinders	6
Bore	3.66 in (92.90 mm)
Stroke	3.39 in (86.00 mm)
Total piston displacement	213.5 cu in (3 498 cm ³)

³⁷ Premium fuel required. Performance may vary with fuel octane rating.

³⁸ Exterior rear view mirrors folded out.

Engine ML 350 4MATIC

Compression ratio	10.7:1
Output acc. to SAE J 1349³⁹	268 hp/6 000 rpm (200 kW/6 000 rpm)
Maximum torque acc. to SAE J 1349	258 lb-ft/ 2 400 - 5 000 rpm (350 Nm/ 2 400 - 5 000 rpm)
Maximum engine speed	6 500 rpm
Firing order	1-4-3-6-2-5
Poly-V-belt	2 398 mm

Electrical system ML 350 4MATIC

Alternator	14 V/180 A
Starter motor	12 V/1.4 kW
Battery	12 V/70 Ah
Spark plugs, type	Bosch Y 7 MPP33
Spark plugs, electrode gap	0.031 in (0.8 mm)
Spark plugs, tightening torque	15 - 18 lb-ft (20 - 25 Nm)

Main dimensions ML 350 4MATIC

Overall vehicle length	188.5 in (4 788 mm)
Overall vehicle width⁴⁰	83.6 in (2 124 mm)
Overall vehicle height	71.5 in (1 815 mm) ⁴¹ 69.8 - 73.0 in (1 774 - 1 854 mm) ⁴²

Main dimensions ML 350 4MATIC

Wheelbase	114.8 in (2 915 mm)
Track, front	64.0 in (1 627 mm)
Track, rear	64.1 in (1 629 mm)
Ground clearance	8.3 in (210 mm) ⁴¹ 7.3 - 10.3 in (186 - 261 mm) ⁴²
Turning circle	39.0 ft (11.6 m)

Weights ML 350 4MATIC

Roof load	max. 220 lb (100 kg)
------------------	----------------------

Vehicle specification ML 550 4MATIC (164.172)

The quoted data apply only to the standard vehicle. Contact an authorized Mercedes-Benz Center for the corresponding data of all special bodies and special equipment.

Engine ML 550 4MATIC

Engine, type	273
Mode of operation	4-stroke engine, gasoline injection
No. of cylinders	8
Bore	3.86 in (98.00 mm)
Stroke	3.56 in (90.50 mm)
Total piston displacement	333.2 cu in (5 461 cm ³)
Compression ratio	10.7:1

³⁹ Premium fuel required. Performance may vary with fuel octane rating.

⁴⁰ Exterior rear view mirrors folded out.

⁴¹ Vehicles with steel suspension.

⁴² Depending on the set vehicle level (vehicles with air suspension program).

Engine ML 550 4MATIC

Output acc. to SAE J 1349⁴³	382 hp/6 000 rpm (285 kW/6 000 rpm)
Maximum torque acc. to SAE J 1349	391 lb-ft/ 2 800 - 4 800 rpm (530 Nm/ 2 800 - 4 800 rpm)
Maximum engine speed	6 500 rpm
Firing order	1-5-4-2-6-3-7-8
Poly-V-belt	2 398 mm

Electrical system ML 550 4MATIC

Alternator	14 V/180 A
Starter motor	12 V/1.4 kW
Battery	12 V/95 Ah
Spark plugs, type	NGK PLKR 7A
Spark plugs, electrode gap	0.031 in (0.8 mm)
Spark plugs, tightening torque	15 - 18 lb-ft (20 - 25 Nm)

Main dimensions ML 550 4MATIC

Overall vehicle length	188.5 in (4 788 mm)
Overall vehicle width⁴⁴	83.6 in (2 124 mm)
Overall vehicle height	71.5 in (1 815 mm) ⁴⁵ 69.8 - 73.0 in (1 774 - 1 854 mm) ⁴⁶
Wheelbase	114.8 in (2 915 mm)

Main dimensions ML 550 4MATIC

Track, front	63.7 in (1 619 mm)
Track, rear	63.8 in (1 621 mm)
Ground clearance	8.3 in (210 mm) ⁴⁵ 7.3 - 10.3 in (186 - 261 mm) ⁴⁶
Turning circle	39.0 ft (11.6 m)

Weights ML 550 4MATIC

Roof load	max. 220 lb (100 kg)
------------------	----------------------

Vehicle specification ML 63 AMG (164.177)

The quoted data apply only to the standard vehicle. Contact an authorized Mercedes-Benz Center for the corresponding data of all special bodies and special equipment.

Engine ML 63 AMG

Engine, type	156
Mode of operation	4-stroke engine, gasoline injection
No. of cylinders	8
Bore	4.02 in (102.20 mm)
Stroke	3.72 in (94.60 mm)
Total piston displacement	378.8 cu in (6 208 cm ³)
Compression ratio	11.3:1
Output acc. to SAE J 1349⁴⁷	503 hp/6 800 rpm (375 kW/6 800 rpm)

⁴³ Premium fuel required. Performance may vary with fuel octane rating.

⁴⁴ Exterior rear view mirrors folded out.

⁴⁵ Vehicles with steel suspension.

⁴⁶ Depending on the set vehicle level (vehicles with air suspension program).

⁴⁷ Premium fuel required. Performance may vary with fuel octane rating.

Engine ML 63 AMG

Maximum torque acc. to SAE J 1349	465 lb-ft/5 200 rpm (630 Nm/5 200 rpm)
Maximum engine speed	7 200 rpm
Firing order	1-5-4-2-6-3-7-8
Poly-V-belt	2 360 mm

Electrical system ML 63 AMG

Alternator	14 V/180 A
Starter motor	12 V/2.1 kW
Battery	12 V/95 Ah
Spark plugs, type	NGK ILZKAR 7A10
Spark plugs, electrode gap	0.039 in (1.0 mm)
Spark plugs, tightening torque	15 - 18 lb-ft (20 - 25 Nm)

Main dimensions ML 63 AMG

Overall vehicle length	189.7 in (4 818 mm)
Overall vehicle width ⁴⁸	83.6 in (2 124 mm)
Overall vehicle height	69.5 - 72.6 in (1 765 - 1 845 mm) ⁴⁹
Wheelbase	114.8 in (2 915 mm)
Track, front	65.5 in (1 664 mm)
Track, rear	65.6 in (1 667 mm)
Ground clearance	7.0 - 10.1 in (177 - 257 mm) ⁴⁹
Turning circle	39.0 ft (11.6 m)

Weights ML 63 AMG

Roof load	max. 220 lb (100 kg)
-----------	----------------------

Rims and tires

Notes

! Only use tires which have been tested and approved by Mercedes-Benz. Tires approved by Mercedes-Benz are developed to provide best possible performance in conjunction with the driving safety systems on your vehicle such as the ABS or the ESP®. Tires specially developed for your vehicle and tested and approved by Mercedes-Benz can be identified by finding the following on the tire's sidewall:

- MO = Mercedes-Benz Original equipment tires
- MOE = Mercedes-Benz Original Extended (tires with limited run-flat characteristics) original equipment tires

Using tires other than those approved by Mercedes-Benz may result in damage that is not covered by the Mercedes-Benz Limited Warranty.

For information on driving with MOExtended tires, see the "Practical hints" section (▷ page 330).

i Vehicles with MOExtended system are not factory-equipped with a TIREFIT kit. When retrofitting with tires that do not have run-flat characteristics, you should also equip your vehicle with a TIREFIT kit. TIREFIT kits are available at any authorized Mercedes-Benz Center.

! Using tires other than those approved by Mercedes-Benz can have detrimental effects, such as

⁴⁸ Exterior rear view mirrors folded out.

⁴⁹ Depending on the set vehicle level.

- poor handling characteristics
- increased noise
- increased fuel consumption

Moreover, tires and rims not approved by Mercedes-Benz may, under load, exhibit dimensional variations and different tire deformation characteristics that could cause them to come into contact with the vehicle body or axle parts. Damage to the tires or the vehicle may be the result.

- i** Further information on tires and rims is available at any authorized Mercedes-Benz Center. The Tire and Loading Information placard with the recommended tire inflation pressures for cold tires is located on the driver's door B-pillar. Supplemental tire inflation pressure information for driving at high speeds or for vehicle loads less than the maximum loaded vehicle condition can be found on the tire inflation pressure label. The tire inflation pressure label is located on the inside of the fuel filler flap. The tire inflation pressure should be checked regularly and should only be adjusted on cold tires. Follow tire manufacturer's maintenance recommendation included with the vehicle.

For information on recommended tire inflation pressure and supplemental tire inflation pressure information for special driving situations, see (▷ page 219).

- i** Please keep in mind that the vehicle must be equipped
- with wheels of identical dimensions on each axle (left and right)
 - with tires of identical characteristics all around, i.e. summer tires, winter tires, all-season tires, or MOExtended tires etc.
- i** The following pages also list the approved rim and tire sizes for equipping your vehicle with winter tires. Winter tires are not available as standard or optional factory

equipment, but can be purchased from an authorized Mercedes-Benz Center.

Equipping your vehicle with winter tires approved for your vehicle model may require the purchase of rims of the recommended size for use with these winter tires. This depends on vehicle model and the standard or optional factory-equipped wheel rim/tire configuration on your vehicle. For more information contact an authorized Mercedes-Benz Center.

Same size tires

	Model	ML 350 BlueTEC 4MATIC ML 350 4MATIC ML 350 4MATIC (Sport Package) ML 550 4MATIC
18" wheels	Rims (light alloy)	8 J x 18 H2
	Wheel offset	2.36 in (60 mm)
	Winter tires ^{50,51,52}	255/55 R18 105H M+S 
	All-terrain tires ^{50,51,52}	255/55 R18 105H M+S

	Model	ML 350 ML 350 4MATIC ML 350 BlueTEC 4MATIC ⁵³
19" wheels	Rims (light alloy)	8 J x 19 H2
	Wheel offset	2.36 in (60 mm)
	All-season tires ⁵⁰	255/50 R19 107H XL (Extra Load) M+S
	Winter tires ^{50,51}	255/50 R19 107H XL (Extra Load) M+S 

	Model	ML 350 BlueTEC 4MATIC ⁵³
19" wheels	Rims (light alloy)	8 J x 19 H2
	Wheel offset	2.36 in (60 mm)
	All-season tires ⁵⁰	255/50 R19 107H XL (Extra Load) M+S MOExtended ⁵⁴
	Winter tires ^{50,51}	255/50 R19 107H XL (Extra Load) M+S  MOExtended ⁵⁴

⁵⁰ Radial-ply tires.

⁵¹ Not available as factory equipment.

⁵² ML 350 BlueTEC 4MATIC: Standard tire without run-flat characteristics. Equipping the vehicle with TIREFIT is strongly recommended.

⁵³ ML 350 BlueTEC: Availability in Canada depending on vehicle production date.

⁵⁴ Must be used in conjunction with Advanced Tire Pressure Monitoring System (U.S. vehicles) or tire pressure loss warning system (Canada vehicles) only.

	Model	ML 550 4MATIC (Sport Package)
19" wheels	AMG rims (light alloy)	8.5 J x 19 H2
	Wheel offset	2.28 in (58 mm)
	All-season tires ⁵⁵	255/50 R19 107H XL (Extra Load) M+S
	Winter tires ^{55,56}	255/50 R19 107H XL (Extra Load) M+S 

	Model	ML 63 AMG
19" wheels	AMG rims (light alloy)	9.5 J x 19 H2
	Wheel offset	1.81 in (46 mm)
	Winter tires ^{55,56}	285/45 R19 107H M+S 

	Model	ML 350 (Appearance Package) ML 350 4MATIC (Appearance Package)
20" wheels	Rims (light alloy)	8.5 J x 20 H2
	Wheel offset	2.17 in (55 mm)
	All-season tires ⁵⁵	265/45 R20 108H XL (Extra Load) M+S

	Model	ML 550 4MATIC (Sport Package)
20" wheels	AMG rims (light alloy)	8.5 J x 20 H2
	Wheel offset	2.36 in (60 mm)
	All-season tires ^{55,57}	265/45 R20 108H XL (Extra Load) M+S

	Model	ML 63 AMG
20" wheels	AMG rims (light alloy)	10 J x 20 H2
	Wheel offset	1.81 in (46 mm)
	Summer tires ^{55,57}	295/40 ZR20 106Y

	Model	ML 63 AMG
21" wheels	AMG rims (light alloy)	10 J x 21 H2
	Wheel offset	1.81 in (46 mm)
	Summer tires ^{55,57}	295/35 ZR21 107Y XL (Extra Load)

⁵⁵ Radial-ply tires.

⁵⁶ Not available as factory equipment.

⁵⁷ Must not be used with snow chains.

Spare wheel

! Compare the recommended tire inflation pressure for your vehicle with the tire inflation pressure on the yellow label located on the spare wheel rim.

If the tire inflation pressure on the yellow label on the spare wheel rim differs from the values given in this Operator's Manual, inflate the tire to the recommended tire inflation pressure given on the yellow label on the spare wheel rim.

i Please note that the tire inflation pressure of the spare wheel differs from the tire inflation pressure of the road tires.

i The ML 350 BlueTEC 4MATIC does not have a spare wheel.

Model	ML 350 (all models) ML 550 (all models)	ML 63 AMG
Rim	4.0 B x 18 H2	5.5 B x 19 H2
Wheel offset	1.58 in (40 mm)	0.51 in (13 mm)
Minispare tire ⁵⁸	T 155/90 D18 113M or T 155/90 R18 113M	—
Collapsible tire ⁵⁸	—	185/85-19 104P
Recommended tire inflation pressure	61 psi (4.2 bar)	51 psi (3.5 bar)

Fuels, coolants, lubricants, etc.

Capacities

Vehicle components and their respective lubricants must match. Therefore only use products tested and approved by Mercedes-Benz.

For information on tested and approved products, contact an authorized Mercedes-Benz Center or visit www.mbusa.com (USA only).

Warning!

Comply with all valid regulations with respect to handling, storing, and disposing of service

fluids. Otherwise you could endanger persons or the environment.

Keep service fluids out of the reach of children.

For health reasons, you should prevent service fluids from coming into direct contact with your skin or clothing.

If a service fluid is swallowed, contact a physician immediately.

⁵⁸ Must not be used with snow chains.

	Model	Capacity	Fuels, coolants, lubricants, etc.
Engine with oil filter	ML 350 BlueTEC 4MATIC	9.0 US qt (8.5 l)	Approved engine oils
	ML 350 4MATIC ML 350	8.5 US qt (8.0 l)	
	ML 550 4MATIC	9.5 US qt (9.0 l)	
	ML 63 AMG ⁵⁹	10.3 US qt (9.7 l)	
Automatic transmission	All models, except ML 63 AMG	9.5 US qt (9.0 l)	MB Automatic Transmission Fluid
	ML 63 AMG ⁶⁰	9.7 US qt (9.2 l)	
Front axle	ML 350 BlueTEC 4MATIC ML 350 4MATIC ML 550 4MATIC	1.2 US qt (1.1 l)	Hypoid gear oil
	ML 63 AMG		Fuchs Titan EG 5010 D
Rear axle	ML 350 BlueTEC 4MATIC ML 350 4MATIC ML 550 4MATIC	1.2 US qt (1.1 l)	Hypoid gear oil
	ML 350	1.5 US qt (1.4 l)	
	ML 63 AMG	1.2 US qt (1.1 l)	Fuchs Titan EG 5010 D
Transfer case	ML 350 BlueTEC 4MATIC ML 350 4MATIC ML 550 4MATIC ML 63 AMG	0.53 US qt (0.5 l)	MB Automatic Transmission Fluid
Power steering	ML 350	approx. 1.3 US qt (1.2 l)	MB Power Steering Fluid or approved Dexron III ATF
	ML 350 BlueTEC 4MATIC ML 350 4MATIC ML 550 4MATIC	approx. 1.05 US qt (1.0 l)	
	ML 63 AMG	approx. 1.3 US qt (1.2 l)	MB Power Steering Fluid

⁵⁹ Engine with oil cooler.

⁶⁰ Automatic transmission with oil cooler.

	Model	Capacity	Fuels, coolants, lubricants, etc.
Brake system	All models	0.63 US qt (0.6 l)	MB Brake Fluid (DOT 4+)
Cooling system	ML 350 BlueTEC 4MATIC ML 350 4MATIC ML 350	approx. 10.0 US qt (9.5 l)	MB 325.0 Anticorrosion/ Antifreeze
	ML 550 4MATIC	approx. 12.7 US qt (12.0 l)	
	ML 63 AMG	approx. 12.2 US qt (11.5 l)	
Fuel tank	All models	25.1 US gal (95.0 l)	Gasoline engine: Premium unleaded gasoline (Minimum Posted Octane 91 [Avg. of 96 RON/86 MON]) Diesel engine: ULTRA-LOW SULFUR HIGHWAY DIESEL FUEL (ULSD, 15 ppm SULFUR MAXIMUM)
Fuel tank reserve	All models, except ML 63 AMG	approx. 3.4 US gal (13.0 l)	
	ML 63 AMG	approx. 4.0 US gal (15.0 l)	
AdBlue® tank	ML 350 BlueTEC 4MATIC	7.0 US gal (26.6 l)	AdBlue® complying with ISO 22241
Air conditioning system	All models	—	R134a refrigerant and special PAG lubricant oil (never R 12)
Washer system and headlamp cleaning system	All models	7.6 US qt (7.2 l)	MB Windshield Washer Concentrate ⁶¹ (▷ page 364) Washer fluid mixing ratio (▷ page 364)

⁶¹ Mixed with water or commercially available premixed washer solvent/antifreeze.

Approved engine oils

Engine oils are specifically tested for their suitability in our engines and durability for our service intervals. Therefore, only use approved engine oils and oil filters required for vehicles with the Maintenance System.

For a listing of approved engine oils and oil filters, contact an authorized Mercedes-Benz Center or visit www.mbusa.com (USA only).

! Using engine oils and oil filters of a specification other than those expressly required for the Maintenance System, or changing of oil and oil filter at change intervals longer than those called for by the Maintenance System will result in engine or emission control system damage not covered by the Mercedes-Benz Limited Warranty.

Please follow Maintenance System recommendations for scheduled oil changes. Failure to do so will result in engine or emission control system damage not covered by the Mercedes-Benz Limited Warranty.

Mercedes-Benz recommends MOBIL OIL.

Use the table below to determine the MB sheet number.

Model	Engine, type	MB sheet number
ML 350 BlueTEC 4MATIC	642	229.51
ML 350 4MATIC	272	229.5
ML 350	272	229.3/ 229.5
ML 550 4MATIC	273	229.5
ML 63 AMG	156	229.5 ⁶²

i MB sheet numbers are printed on the outside of oil containers.

Viscosity grades for engine oils

Using the chart below, select oil viscosity according to the lowest air temperature expected before the next oil change.

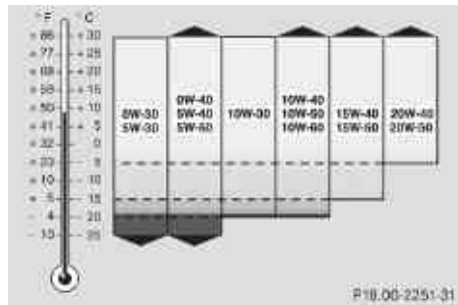

Engine oil additives

! Do not blend oil additives with engine oil. They may damage the engine. Damage or malfunctions resulting from blending oil additives are not covered by the Mercedes-Benz Limited Warranty.

Air conditioning refrigerant

R134a (HFC) refrigerant and special PAG lubricating oil are used in the air conditioning system.

! Never use R 12 (CFC) or mineral-based lubricating oil. Otherwise damage to the system will occur.

Brake fluid

⚠ Warning!

During vehicle operation, the boiling point of the brake fluid is continuously reduced through the absorption of moisture from the atmosphere.

Under extremely strenuous operating conditions, this moisture content can lead to

⁶² Restriction: Only SAE 0W-40/SAE 5W-40 engine oils may be used.

the formation of bubbles in the system, thus reducing the system's efficiency.

Therefore, the brake fluid must be replaced regularly. Refer to your vehicle's Maintenance Booklet for replacement interval.

Only brake fluid approved by Mercedes-Benz is recommended. Any authorized Mercedes-Benz Center will provide you with additional information.

Premium unleaded gasoline (gasoline engine)

Warning!

Gasoline is highly flammable and poisonous. It burns violently and can cause serious personal injury.

Never allow sparks, flames or smoking materials near gasoline!

Turn off the engine before refueling.

Whenever you are around gasoline, avoid inhaling fumes and any skin or clothing contact. Extinguish all smoking materials.

Direct skin contact with fuels and the inhalation of fuel vapors are damaging your health.

! To maintain the engine's durability and performance, premium unleaded gasoline must be used.

If premium unleaded gasoline is not available and low octane gasoline is used, follow these precautions:

- Have the fuel tank only partially filled with unleaded regular gasoline and fill up with premium unleaded gasoline as soon as possible.
- Avoid full throttle driving and abrupt acceleration.
- Do not exceed an engine speed of 3 000 rpm if the vehicle is loaded with a

light load such as two persons and no luggage.

- Do not exceed $\frac{2}{3}$ of maximum accelerator pedal position if the vehicle is fully loaded or operating in mountainous terrain.

Fuel requirements

Gasoline engine

Only use premium unleaded gasoline. The octane number (posted at the pump) must be 91 min. It is an average of both the Research Octane Number (RON) and the Motor Octane Number (MON): $(RON+MON)/2$. This is also known as the ANTI-KNOCK INDEX.

Reformulated gasolines (RFG) and/or unleaded gasoline containing oxygenates such as ethanol, TAME, ETBE, IPA, IBA, and TBA can be used provided the ratio of any one of these oxygenates to gasoline does not exceed 10%; MTBE must not exceed 15%.

The ratio of methanol to gasoline must not exceed 3% plus additional cosolvents.

Using mixtures of ethanol and methanol is not allowed. Gasohol, which contains 10% ethanol and 90% unleaded gasoline, can be used.

These blends must also meet all other fuel requirements, such as resistance to spark knock, boiling range, vapor pressure, etc.

Diesel engine

Only use commercially available vehicular ULTRA-LOW SULFUR HIGHWAY DIESEL FUEL (ULSD, 15 ppm SULFUR MAXIMUM) that meets the ASTM D975 standard. Failure to use ULTRA-LOW SULFUR HIGHWAY DIESEL FUEL (ULSD) can severely damage the vehicle's exhaust after-treatment device.

To prevent malfunctions, diesel fuel with improved cold flow characteristics is offered in the winter months. Check with your fuel retailer.

! Do not fill the tank with gasoline. Do not blend diesel fuel with gasoline or kerosene. The fuel system and engine will otherwise be damaged, which is not covered by the Mercedes-Benz Limited Warranty.

For further information on diesel fuel pump labeling, contact an authorized Mercedes-Benz Center or visit www.mbusa.com (USA only).

Biodiesel (FAME = Fatty Acid Methyl Ester) containing fuels

Mercedes-Benz USA approves the use of B5 (standard ULSD which may contain a maximum of 5% biodiesel) in all Common-rail injection (CDI) and BlueTEC diesel engines.

Diesel fuels containing a higher percentage of biodiesel, e.g. B20, as well as straight biodiesel may cause severe damage to your engine/fuel system and are not approved.

Please ask your service station personnel for further information. If the B5 biodiesel blend is not sufficiently labeled to clearly indicate that it meets the ULSD standard, please do not use it.

The Mercedes-Benz Limited Warranty does not cover damages caused by the use of fuels not meeting Mercedes-Benz approved fuel standards.

Gasoline additives (gasoline engine)

A major concern among engine manufacturers is carbon build-up caused by gasoline. Mercedes-Benz recommends only the use of quality gasoline containing additives that prevent the build-up of carbon deposits.

After an extended period of using fuels without such additives carbon deposits can build up, especially on the intake valves and in the combustion area, leading to engine performance problems such as:

- Warm-up hesitation
- Unstable idle

- Knocking/pinging
- Misfire
- Power loss

In areas where carbon deposits may be encountered due to lack of availability of gasoline which contains these additives, the use of Mercedes-Benz approved additives is recommended.

Contact an authorized Mercedes-Benz Center or visit www.mbusa.com (USA only) for a listing of approved products. Follow directions on the product label.

Do not blend other fuel additives with fuel. This only results in unnecessary cost and may be harmful to the engine operation.

! Damage or malfunction resulting from poor fuel quality or from blending additional fuel additives other than those tested and approved by us for use on Mercedes-Benz vehicles are not covered by the Mercedes-Benz Limited Warranty or by any pre-owned or Extended Limited Warranties.

AdBlue®

AdBlue® is a non-flammable, non-toxic, colorless and odorless, water-soluble liquid.

! Only use AdBlue® complying with ISO 22241. Do not blend with additives.

! Rinse surfaces that have come into contact with AdBlue®, or remove AdBlue® with a moist cloth and cold water immediately. If AdBlue® has crystallized already, use cold water and a sponge. AdBlue® residues will crystallize and soil the affected surfaces.

High ambient temperatures

If AdBlue® in the reservoir heats up to above 122°F (50°C) for a long period of time, for example due to direct sunlight, ammonia gas

vapors may escape when opening the AdBlue® tank.

Warning!

When opening the filler cap of the AdBlue® tank ammonia gas vapors may escape. Refill AdBlue® in a well ventilated area only. Ammonia gas vapors have a pungent odor and are particularly irritating for your skin, mucous membranes, and eyes. Inhaling ammonia gas vapors will cause burning eyes, nose, and throat, as well as coughing and watering eyes.

Low ambient temperatures

AdBlue® freezes at a temperature of approximately 12°F (-11°C). Your vehicle is factory equipped with an AdBlue® preheating system. The vehicle can thus be operated at temperatures below 12°F (-11°C).

Special additives

! Only use AdBlue® complying with ISO 22241. Do not add additives to AdBlue® and do not dilute AdBlue® with water. Otherwise, the BlueTEC exhaust gas aftertreatment system could be damaged. Damage caused by using additives or diluting with water are not covered by the Mercedes-Benz Limited Warranty.

Purity

The purity of AdBlue® is of particular importance for avoiding malfunctions in the exhaust gas aftertreatment.

If AdBlue® is pumped out of the tank, e.g. during repair work, the same liquid must not be used to refill the tank as its purity is no longer guaranteed.

! Impurities caused for example by other service products, cleaning agents, and dust result in increased emissions, malfunctions, catalyst damage, or engine damage.

Coolants

The engine coolant is a mixture of water and anticorrosion/antifreeze, which provides:

- Corrosion protection
- Freeze protection
- Boiling protection (by increasing the boiling point)

The cooling system was filled at the factory with a coolant providing freeze protection to approximately -35°F (-37°C) and corrosion protection.

! Add premixed coolant solution only. Adding water and MB 325.0 Anticorrosion/Antifreeze separately from each other, could cause engine damage not covered by the Mercedes-Benz Limited Warranty.

If the antifreeze mixture is effective to -35°F (-37°C), the boiling point of the coolant in the pressurized cooling system is reached at approximately 266°F (130°C).

The coolant solution must be used year round to provide the necessary corrosion protection and increase boil-over protection. Refer to the Maintenance Booklet for replacement interval.

Coolant system design and coolant used determine the replacement interval. The replacement interval published in the Maintenance Booklet is only applicable if MB 325.0 Anticorrosion/Antifreeze solution or other Mercedes-Benz approved products of equal specification are used to renew the coolant concentration or bring it back up to the proper level.

For information on other Mercedes-Benz approved products of equal specification, contact an authorized Mercedes-Benz Center or visit **www.mbusa.com** (USA only).

To provide important corrosion protection, the solution must be at least 50% anticorrosion/antifreeze (equivalent to freeze protection to approximately -35°F [-37°C]).

If you use a solution that is more than 55% anticorrosion/antifreeze (freeze protection to approximately -49°F [-45°C]), the engine temperature will increase due to the lower heat transfer capability of the solution.

Therefore, do not use more than this amount of anticorrosion/antifreeze.

If the coolant level is low, water and MB 325.0 Anticorrosion/Antifreeze should be used to bring it up to the proper level (have cooling system checked for signs of leakage). Please make sure the mixture is in accordance with label instructions.

The water in the cooling system must meet minimum requirements, which are usually satisfied by normal drinking water.

If you are not sure about the water quality, contact an authorized Mercedes-Benz Center.

Anticorrosion/antifreeze

Your vehicle contains a number of aluminum parts. The use of aluminum components in motor vehicle engines necessitates that anticorrosion/antifreeze coolant used in such engines be specifically formulated to protect the aluminum parts. Failure to use such anticorrosion/antifreeze coolant will result in a significantly shortened service life.

Therefore, the following product is strongly recommended for use in your vehicle:

MB 325.0 Anticorrosion/Antifreeze agent.

Before the start of the winter season (or once a year in hot southern regions), you should have the anticorrosion/antifreeze concentration checked.

The coolant is also regularly checked each time you bring your vehicle to an authorized Mercedes-Benz Center for service.

	Model	Approximate freeze protection	
		-35°F (-37°C)	-49°F (-45°C)
Cooling system	ML 350 BlueTEC 4MATIC	5.0 US qt (4.75 l)	5.5 US qt (5.2 l)
	ML 350		
	ML 350 4MATIC		
	ML 550 4MATIC	6.3 US qt (6.0 l)	7.0 US qt (6.6 l)
	ML 63 AMG	6.1 US qt (5.8 l)	6.8 US qt (6.4 l)

Washer system and headlamp cleaning system

Warning!

Washer solvent/antifreeze is highly flammable. Do not spill washer solvent/antifreeze on hot engine parts, because it may ignite and burn. You could be seriously burned.

- ▶ Use MB Windshield Washer Concentrate “MB SummerFit”.
- ▶ Mix with water for temperatures above freezing point.
- ▶ Mix with commercially available premixed washer solvent/antifreeze for temperatures below freezing point.

Washer fluid mixing ratio

For temperatures above the freezing point:
1 part “MB SummerFit” to 100 parts water
(1.34 fl oz [40 ml] “MB SummerFit” to 1 gal [4.0 l] water)

For temperatures below freezing point:
1 part “MB SummerFit” to 100 parts solvent
(1.34 fl oz [40 ml] “MB SummerFit” to 1 gal [4.0 l] solvent)

Service and Literature

Your authorized Mercedes-Benz Center has trained technicians and Genuine Mercedes-Benz Parts to service your vehicle properly. For expert advice and quality service, contact an authorized Mercedes-Benz Center.

If you are interested in obtaining service literature for your vehicle, please contact an authorized Mercedes-Benz Center.

We consider this the best way for you to obtain accurate information for your vehicle. For further information you can find us on the Mercedes-Benz web site **www.mbusa.com** (USA only) or **www.mercedes-benz.ca** (Canada only).

Warning!

To help avoid personal injury, be extremely careful when performing any service work or repairs. Improper or incomplete service or the use of incorrect or inappropriate parts or materials may damage the vehicle or its equipment, which may in turn result in personal injury.

If you have any questions about carrying out any type of service, turn to the advice of an authorized Mercedes-Benz Center.

We reserve the right to make changes in design and equipment. Therefore, information, illustrations and descriptions in this Operator's Manual might differ from your vehicle. Reprinting, translation and copying, even of excerpts, is not permitted without our prior authorization in writing.

Press time September 11, 2009

GSP/OIS

Printed in U. S. A.



1645841383

Order no. 6515 4317 13 Part no. 164 584 13 83 Edition B 2010