

Mercedes-Benz

# G-Class

## Operator's Manual

## Symbols

Trademarks®:

- BabySmart™ is a trademark of Siemens Automotive Corp.
- Bluetooth® is a registered trademark of Bluetooth SIG Inc.
- ESP® is a registered trademark of Daimler.
- HomeLink® is a registered trademark of Prince, a Johnson Controls Company.
- SIRIUS and related marks are trademarks of SIRIUS XM Radio Inc.

The following symbols are found in this Operator's Manual:

### **Warning!**

Warning notices draw your attention to hazards that may endanger your health or life, or the health or life of others.

 Highlights hazards that may result in damage to your vehicle.

 Helpful hints or further information you may find useful.

▶ This symbol points to instructions for you to follow.

▶ A number of these symbols appearing in succession indicates a multiple-step procedure.

▷ page This symbol tells you where to look for further information on a topic.

▷▷ This continuation symbol marks a warning or procedure which is continued on the next page.

Display Text in displays, such as the control system, are printed in the type shown here.

Our company and staff congratulate you on the purchase of your new Mercedes-Benz.

Your selection of our product is a demonstration of your trust in our company name. Furthermore, it exemplifies your desire to own an automobile that will be as easy as possible to operate and provide years of service.

Your Mercedes-Benz represents the efforts of many skilled engineers and craftsmen. To help assure your driving pleasure, and also the safety of you and your passengers, we ask you to make a small investment of time:

- Please read this manual carefully, then return it to your vehicle where it will be handy for your reference.
- Please follow the recommendations contained in this manual. They are designed to acquaint you with the operation of your Mercedes-Benz.
- Please pay attention to the warnings and cautions contained in this manual. They are designed to help improve the safety of the vehicle operator and occupants.

We extend our best wishes for many miles of safe, pleasurable driving.

Mercedes-Benz USA, LLC

A Daimler Company



**Index..... 4**

**Introduction..... 18**

**At a glance..... 23**

**Safety and security..... 31**

**Controls in detail..... 57**

**Operation..... 145**

**Practical hints..... 193**

**Technical data..... 245**

## 1, 2, 3 ...

**4-ETS (Electronic Traction System)...** 53  
**4MATIC**  
 see All-wheel drive (4MATIC)

## A

**ABS (Antilock Brake System).....** 51  
 Indicator lamp..... 214  
 Messages in the multifunction display..... 198  
**Accessory weight**..... 172  
**Accidents**..... 85  
 Air bag deployment..... 33  
 Emergency calls (Tele Aid)..... 136  
**Additives**  
 Engine oil..... 254  
 Gasoline..... 255  
**Address change**..... 20  
**Advanced Tire Pressure Monitoring System (Advanced TPMS)**..... 157  
 Messages in the multifunction display..... 200, 212  
**Air bags**..... 33  
 Children..... 33  
 Emergency call upon deployment... 136  
 Front, driver and passenger..... 35  
 Front passenger front air bag off indicator lamp..... 29, 36, 220  
 Safety guidelines..... 34  
 Window curtain..... 36  
**Air conditioning refrigerant and lubricant**..... 254  
**Air distribution**..... 123  
**Air pressure**  
 see Tire inflation pressure  
**Air pressure (tires)**..... 172  
**Air recirculation mode**..... 124  
**Air volume**..... 123  
**Alarm system**  
 see Anti-theft systems  
**All-wheel drive (4MATIC)**..... 114  
**Alternator**  
 Messages in the multifunction display..... 206

**Alternator (Technical data)**

see Vehicle specification

**Anticorrosion/antifreeze**..... 256

**Antilock Brake System**

see ABS

**Anti-theft systems**..... 54

Anti-theft alarm system..... 54

Immobilizer..... 54

Tow-away alarm..... 55

**Aquaplaning**

see Hydroplaning

**Ashtrays**..... 133

**Aspect ratio (tires)**..... 172

**Audio/DVD menu**..... 100

**Auto-dimming rear view mirrors**..... 70

**Automatic central locking**..... 60, 108

**Automatic headlamp mode**..... 73

**Automatic interior lighting control**..... 77

**Automatic locking when driving**..... 108

**Automatic transmission**..... 87

Emergency operation (limp-home mode)..... 90

Gear range indicator..... 89

Gear ranges..... 89

Gear selector lever..... 87

Gearshifting malfunctions (limp-home mode)..... 90

Hill start assist system..... 114

Kickdown..... 89

One-touch gearshifting..... 90

Shifting procedure..... 88

Transmission position indicator..... 88

Transmission positions..... 88

**Axle oils**..... 252

## B

**BabySmart™**

Air bag deactivation system..... 36

Self-test..... 38

**Backrest**

see Seats

**Backup lamps**

Messages in the multifunction

display..... 209

Replacing bulbs..... 226

**Bar (air pressure unit)**..... 172

**BAS (Brake Assist System)**..... 51

- Batteries, SmartKey**
    - Checking condition..... 59
    - Replacing..... 225
  - Battery, Vehicle**..... 236
    - Charging..... 237
    - Jump starting..... 237
    - Messages in the multifunction display..... 206
  - Bead (tire)**..... 172
  - Beverage holders**
    - see Cup holders
  - Brake fluid**
    - Checking level..... 152
    - Messages in the multifunction display..... 202
  - Brake lamps**
    - Cleaning lenses..... 190
    - High-mounted brake lamp..... 226
    - Replacing bulbs..... 226
  - Brake pads**
    - Messages in the multifunction display..... 202
  - Brakes**..... 177
    - Parking brake..... 86
    - Warning lamp..... 215
  - Break-in period**..... 146
  - Brush guard**..... 224
  - Bulbs**
    - see Replacing bulbs
- C**
- CAC (Customer Assistance Center)**.... 21
  - California retail buyers and lessees, important notice for**..... 19
  - Calls (phone)**..... 110
  - Can holders**
    - see Cup holders
  - Capacities and recommended fuel/lubricants**..... 252
  - Cargo compartment**
    - Cargo volume, expanding..... 128
    - Cover blind..... 129
    - Tie-down rings..... 128
  - Cargo compartment cover blind**..... 129
  - Cargo tie-down rings**..... 128
  - Carpets, cleaning**..... 192
  - Central locking**
    - Automatic..... 60, 108
    - Locking/unlocking from inside..... 60
  - Central locking/unlocking switch**..... 60
  - Certification label**..... 246
  - Children in the vehicle**
    - Air bags..... 33
    - BabySmart™ air bag deactivation system..... 36
    - Blocking of rear window operation... 49
    - Child safety locks (rear doors)..... 48
    - Child seat anchors – LATCH-type.... 48
    - Indicator lamp, front passenger front air bag off..... 36
    - Infant and child restraint systems.... 45
    - Safety notes..... 44
    - Tether anchorage points..... 47
    - Top tether..... 44, 47
  - Child safety**
    - see Children in the vehicle
  - Child seat anchors – LATCH-type**
    - see Children in the vehicle
  - Chrome-plated exhaust tip, cleaning**..... 192
  - Cigarette lighter**..... 134
  - Climate control system**
    - Air conditioning, cooling..... 121
    - Air conditioning refrigerant..... 254
    - Air distribution..... 123
    - Air recirculation mode..... 124
    - Air volume..... 123
    - Automatic mode..... 121
    - Deactivating system..... 121
    - Front defroster..... 123
    - Residual engine heat (REST)..... 124
    - Temperature..... 121
  - Cockpit**..... 25
  - Cold tire inflation pressure**..... 172
  - COMAND system**
    - see separate COMAND system operating instructions
  - Combination switch**..... 74
  - Control system**..... 97
    - Multifunction display..... 98
    - Multifunction steering wheel..... 97
    - Resetting to factory settings..... 103

<b>Control system menus</b> .....	99	<b>Delayed shut-off</b>	
Audio/DVD.....	100	Exterior lamps.....	107
Navigation.....	102	Interior lighting.....	108
Settings.....	103	<b>Department of Transportation</b>	
Standard display.....	99	see DOT	
Telephone.....	110	<b>Differential locks</b> .....	93
Trip computer.....	109	A few words about.....	93
Vehicle status message memory....	102	<b>Difficulties</b>	
<b>Control system submenus</b>		While driving.....	85
Convenience.....	108	With starting.....	83
Instrument cluster.....	104	<b>Digital speedometer</b> .....	100
Lighting.....	106	<b>Dimensions (vehicle)</b>	
Vehicle.....	108	see Vehicle specification	
<b>Convenience submenu</b>		<b>Direction of rotation (tires)</b> .....	164
Easy-entry/exit feature.....	109	<b>Displays</b>	
<b>Coolant</b>		Digital speedometer.....	100
Anticorrosion/antifreeze.....	256	Maintenance service indicator.....	186
Capacities.....	253	Messages in the multifunction	
Checking level.....	152	display.....	196
Messages in the multifunction		Multifunction display.....	98
display.....	204	Outside temperature.....	100, 105
Temperature gauge.....	96	Symbol messages.....	202
<b>Coolant temperature gauge</b> .....	26	Text messages.....	198
<b>Corner-illuminating front fog lamps</b> ...	76	Trip computer.....	109
<b>Cruise control</b> .....	112	Vehicle status message memory....	102
Last stored speed.....	114	Vehicle system settings.....	103
Messages in the multifunction		<b>Door control panel</b> .....	30
display.....	199	<b>Door handles</b> .....	30
Resume function.....	114	<b>Doors</b>	
<b>Cup holders</b> .....	131	Child safety locks.....	48
<b>Curb weight</b> .....	172	Locking/unlocking (SmartKey).....	58
<b>Customer Assistance Center (CAC)</b> ....	21	Locking/unlocking from outside.....	58
		Messages in the multifunction	
		display.....	204
		Opening from inside.....	59
		Remote door unlock (Tele Aid).....	139
		Unlocking (Mechanical key).....	221
		<b>DOT (Department of</b>	
		<b>Transportation)</b> .....	173
		<b>Drinking and driving</b> .....	177
		<b>Driving</b>	
		Abroad.....	185
		Hydroplaning.....	179
		Instructions.....	83, 176
		In winter.....	176
		Off-road.....	179
		Problems.....	85
		Safety systems.....	50
<b>D</b>			
<b>Dashboard</b>			
see Instrument cluster			
<b>Data recording</b> .....	22		
<b>Daytime running lamp mode</b> .....	73		
Setting.....	106		
<b>Deep water</b>			
see Standing water			
<b>Defogging (windshield)</b> .....	124		
<b>Defroster</b>			
Front (Climate control system).....	123		
Rear window.....	125		
Windshield.....	124		



Systems.....	112	Remote door unlock.....	139
Through standing water.....	179	Tailgate, unlocking and opening....	221
<b>Driving and parking</b>		<b>Emergency Tensioning Device</b>	
Safety notes.....	82	see ETD	
<b>Driving off</b> .....	84, 179	<b>Emission control</b> .....	185
<b>Driving safety systems</b> .....	50	Information label.....	247
4-ETS.....	53	System warranties.....	18
ABS.....	51	<b>Engine</b>	
BAS.....	51	Break-in recommendations.....	146
EBB.....	52	Cleaning.....	189
ESP®.....	52	Compartment.....	148
<b>Driving systems</b>		Malfunction indicator lamp	
All-wheel drive (4MATIC).....	114	.....	26, 218
Cruise control.....	112	Messages in the multifunction	
Hill start assist.....	114	display.....	204
Rear Parking Assist system.....	115	Number.....	247
Rear view camera.....	117	Starting.....	83
<b>Driving tips, automatic</b>		Turning off.....	86
<b>transmission</b> .....	89	<b>Engine (Technical data)</b>	
		see Vehicle specification	
		<b>Engine coolant</b>	
		see Coolant	
		<b>Engine oil</b>	
		Adding.....	151
		Additives.....	254
		Checking level.....	149
		Consumption.....	149
		Messages in the multifunction	
		display.....	207
		Oil dipstick.....	150
		Recommended engine oils and oil	
		filter.....	253
		<b>ESP® (Electronic Stability Program)</b> ...	52
		4-ETS.....	53
		Messages in the multifunction	
		display.....	198
		Warning lamp.....	217
		<b>ETD (Emergency Tensioning</b>	
		<b>Device)</b> .....	43
		Safety guidelines.....	34
		<b>Express operation</b>	
		Power windows.....	81
		Tilt/sliding sunroof.....	125
		<b>Exterior lamp switch</b> .....	72
		<b>Exterior rear view mirrors</b> .....	69
		Parking position.....	70, 71
		<b>Exterior view of vehicle</b> .....	24

## E

**Easy-entry/exit feature**..... 68, 109

**EBB (Electronic Brake Booster)**..... 52

**Electrical system**

Improper work on or modifications... 21

Power outlets..... 134

**Electrical system (Technical data)**

see Vehicle specification

**Electronic Stability Program**

see ESP®

**Electronic Traction System**

see 4-ETS

**Emergency, in case of**

Battery, jump starting..... 237

First aid kit..... 194

Flat tire..... 232

Hazard warning flasher..... 75

Roadside Assistance..... 19

Towing the vehicle..... 239

**Emergency calls**

Tele Aid..... 136

**Emergency operations**

Gear selector lever, unlocking..... 222

Limp-home mode..... 90

Locking/unlocking the vehicle..... 221

Power tilt/sliding sunroof..... 223

**F**

<b>Fastening the seat belts</b> .....	40
<b>First aid kit</b> .....	194
<b>Flat tire</b> .....	232
Lowering the vehicle.....	235
Mounting the spare wheel.....	233
Preparing the vehicle.....	233
Spare wheel.....	232, 251
<b>Floormats</b> .....	144
<b>Fluids</b>	
Automatic transmission fluid.....	252
Brake fluid.....	252
Capacities.....	252
Engine coolant.....	253
Engine oil.....	252
Power steering fluid.....	252
Washer and headlamp cleaning system.....	253
<b>Fog lamps</b> .....	74
Messages in the multifunction display.....	209, 211
Replacing bulbs.....	226
<b>Four-wheel drive</b>	
see All-wheel drive (4MATIC)	
<b>Front air bags</b>	
see Air bags	
<b>Front axle oil</b> .....	252
<b>Front lamps</b>	
see Headlamps	
<b>Front passenger front air bag indicator lamp</b> .....	35
<b>Front passenger front air bag off indicator lamp</b> .....	29, 36, 220
<b>Fuel</b> .....	147
Additives.....	255
Capacity, fuel tank.....	253
Drive sensibly-safe fuel.....	176
Fuel consumption statistics.....	109
Fuel filler flap and cap.....	147
Fuel tank reserve warning lamp.....	26, 218
Premium unleaded gasoline.....	147, 253, 254
Refueling.....	146
Requirements.....	255
<b>Fuel filler flap</b> .....	147
Opening manually.....	223
<b>Fuel gauge</b> .....	26

**Fuels, coolants, lubricants etc.**

Capacities.....	252
-----------------	-----

**Fuel tank**

Capacity.....	253
Fuel filler flap and cap.....	147
Refueling.....	146

**Fuses**..... 242**G****Garage door opener**..... 140**Gasoline**

see Fuel

**GAWR (Gross Axle Weight Rating)**.... 173**Gear range**..... 89

Indicator.....	89
Limiting.....	90
Shifting into optimal.....	90
Transfer case.....	91

**Gear selector lever**..... 87

Cleaning.....	192
Gearshift pattern.....	87
Lock.....	83, 87
Shifting procedure.....	88
Transmission position indicator.....	88
Transmission positions.....	88
Unlocking in an emergency.....	222

**Generator**

see Alternator

**Global locking/unlocking**

see Key, SmartKey

**Glove box**..... 130**Gross Axle Weight Rating**

see GAWR

**Gross Trailer Weight**

see GTW

**Gross Vehicle Weight**

see GVW

**Gross Vehicle Weight Rating**

see GVWR

**GTW**..... 173**GVW (Gross Vehicle Weight)**..... 173**GVWR (Gross Vehicle Weight Rating)**..... 173

**H**

<b>Hard plastic trim items, cleaning</b> .....	191
<b>Hazard warning flasher</b> .....	75
<b>Headlamp cleaning system</b> .....	75
<b>Headlamps</b>	
Automatic headlamp mode.....	73
Bi-Xenon.....	226
Cleaning lenses.....	190
Cleaning system.....	75
Daytime running lamp mode.....	73
Delayed shut-off.....	107
High-beam flasher.....	75
High-beam headlamps.....	75
Low-beam headlamps.....	72
Replacing bulbs.....	226
Switch.....	72
<b>Headliner, cleaning and care of</b> .....	192
<b>Head restraints</b> .....	62
Folding back.....	64
Rear seat, removing and installing....	64
<b>Heated seats</b> .....	66
<b>Heated steering wheel</b> .....	69
<b>Height adjustment</b>	
Seat belt outlet.....	42
Seats.....	63
<b>High-beam flasher</b> .....	75
<b>High-beam headlamps</b> .....	75, 226
Replacing bulbs.....	226
<b>High-mounted brake lamp</b> .....	226
Replacing bulbs.....	226
<b>Hill start assist system</b> .....	114
<b>Hood</b> .....	148
Messages in the multifunction display.....	204
<b>Horn</b> .....	25
<b>Hydroplaning</b> .....	179

**I**

<b>Identification labels</b> .....	246
<b>Identification number, vehicle (VIN)</b> .....	247
<b>Ignition</b> .....	62, 83
<b>Immobilizer</b> .....	54
<b>Infant and child restraint systems</b> see Children in the vehicle	

**Inflation pressure**

    see Tires, Inflation pressure

<b>Inside door handle</b> .....	59
<b>Instrument cluster</b> .....	26, 95
Illumination.....	96
Lamps.....	213
Multifunction display.....	98

**Instrument lighting**

    see Instrument cluster, Illumination

**Instrument panel**

    see Instrument cluster

**Instruments and controls**

    see Cockpit

**Interior lighting**

Cargo compartment lamps.....	78
Delayed shut-off.....	108
Front.....	77
Front reading lamps.....	77
Rear.....	77
Rear reading lamps.....	77

**Interior rear view mirror**..... 69

    Auto-dimming rear view mirrors..... 70

**Interior storage spaces**

    see Storage compartments

**Intermittent wiping**

Windshield wipers.....	80
------------------------	----

**J**

<b>Jack</b> .....	195
<b>Jump starting</b> .....	237

**K**

<b>Key, Mechanical</b> .....	221
Loss of.....	59
<b>Key, SmartKey</b>	
Battery check lamp.....	58
Checking batteries.....	59
Factory setting.....	59
Global locking (SmartKey).....	59
Global unlocking (SmartKey).....	59
Locking/unlocking.....	58
Loss of.....	59
Messages in the multifunction display.....	204
Opening and closing the power tilt/sliding sunroof.....	82

- Opening and closing the windows..... 82
  - Remote control..... 58
  - Replacing batteries..... 225
  - Restoring to factory setting..... 59
  - Selective setting..... 59
  - Starter switch positions..... 62
  - Kickdown**..... 89
  - Kilopascal (air pressure unit)**..... 173
- L**
- Labels**
    - Certification..... 246
    - Emission control information..... 247
  - Lamps, exterior**
    - Exterior lamp switch..... 72
    - Front..... 226
    - Messages in the multifunction display..... 209
    - Rear..... 226
    - Switching on/off..... 72
  - Lamps, indicator and warning**
    - ABS..... 26, 214
    - Battery (SmartKey)..... 58
    - Brakes..... 215
    - Engine malfunction..... 26, 218
    - ESP®..... 26, 217
    - Fog lamps..... 74
    - Front passenger front air bag off..... 29, 36, 220
    - Fuel tank reserve..... 26, 218
    - High-beam headlamps..... 75
    - Instrument cluster..... 213
    - Low-beam headlamps..... 72
    - Low tire pressure/TPMS malfunction telltale..... 219
    - Seat belt telltale..... 43, 216
    - SRS..... 26, 32, 216
    - Turn signals..... 26
  - Language, selecting**..... 105
  - LATCH-type child seat anchors**
    - see Children in the vehicle
  - License plate lamps**..... 226
    - Messages in the multifunction display..... 210
    - Replacing bulbs..... 226
  - Light alloy wheels, cleaning**..... 191
  - Lighter**
    - see Cigarette lighter
  - Lighting**..... 72
    - Daytime running lamp mode..... 73
    - Exterior..... 72
    - Interior..... 77
  - Limp-home mode**..... 90
  - Loading**
    - see Vehicle loading
  - Locator lighting**..... 106
  - Locking the vehicle**..... 58
    - Manually..... 222
  - Loss of**
    - Key..... 59
    - Service and Warranty Information booklet..... 246
  - Low-beam headlamps**..... 72
    - Exterior lamp switch..... 72
    - Replacing bulbs..... 226
    - Switching on..... 72
  - Lubricants**..... 252
- M**
- Maintenance**..... 19
  - Maintenance System**..... 185
    - Service indicator..... 186
    - Service indicator, resetting ..... 187
    - Service indicator display..... 186
    - Service indicator message..... 186
    - Service indicator message, clearing..... 186
    - Service term exceeded..... 186
  - Manual headlamp mode (Low-beam headlamps)**..... 72
  - Maximum engine speed**
    - see Vehicle specification
  - Maximum loaded vehicle weight**..... 173
  - Maximum load rating (tires)**..... 173
  - Maximum permissible tire inflation pressure**..... 173
  - Mechanical key**..... 221
  - Media interface**..... 130
  - Memory function**..... 70
  - Menus**
    - see Control system menus

**Mirrors**

- Auto-dimming rear view mirrors..... 70
- Exterior rear view mirror parking positions..... 70, 71
- Exterior rear view mirrors..... 69
- Interior rear view mirror..... 69
- Memory function..... 70

**MON (Motor Octane Number)**..... 255**Motor Octane Number**

see MON

**Multicontour seats**..... 65**Multifunction display**..... 98

- Symbol messages..... 202
- Text messages..... 198
- Vehicle status messages..... 196

**Multifunction display messages**

- ABS..... 198
- Advanced TPMS..... 200, 212
- Alternator..... 206
- Battery..... 206
- Brake fluid..... 202
- Brake pads..... 202
- Coolant..... 204
- Cruise control..... 199
- Display malfunction..... 196
- Doors..... 204
- Engine oil..... 207
- ESP®..... 198
- Fog lamps..... 209, 211
- Gas cap..... 208
- High-beam lamps..... 210
- Hood..... 204
- License plate lamps..... 210
- Light sensor..... 210
- Low-beam lamps..... 210
- Parking brake..... 202
- Parking lamps..... 210
- Reserve fuel..... 208
- Reverse lamp..... 209
- Side marker lamps..... 209
- SmartKey..... 204
- SRS..... 199
- Tailgate..... 204
- Tail lamps..... 211
- Tele Aid..... 203
- Tire pressure..... 200, 212
- Tire pressure monitor..... 200
- Tires..... 200, 212

Transfer case..... 203

Turn signals..... 212

Washer fluid..... 204

**Multifunction steering wheel**

- Adjusting..... 67
- Buttons..... 97
- Cleaning..... 192
- Easy-entry/exit feature..... 68, 109
- Heating..... 69
- Memory function..... 70
- Overview..... 27

**N****Navigation menu**..... 102**Net, parcel**..... 128**Night security illumination**..... 74, 107**Normal occupant weight**..... 173**Number, vehicle identification (VIN)**..... 247**O****Occupant distribution**..... 173**Occupant safety**..... 32

Air bags..... 33

BabySmart™..... 36

Children and air bags..... 33

Children in the vehicle..... 44

Child seat anchors – LATCH-type.... 48

Fastening the seat belts..... 40

Front passenger front air bag off indicator lamp..... 36, 220

Infant and child restraint systems.... 45

Seat belts..... 34, 38

**Odometer**..... 98**Off-road driving**..... 179

Checklist..... 180, 184

Crossing obstacles..... 183

Driving instructions..... 179

Driving on sand..... 183

Driving through water..... 182

Returning..... 184

Ruts..... 184

Steep terrain..... 181

**Oil**

see Engine oil

<b>Oil level</b>	
see Engine oil, Checking level	
<b>On-board computer</b>	
see Control system	
<b>One-touch gearshifting</b> .....	90
<b>Operating safety</b> .....	21
<b>Ornamental moldings, cleaning</b> .....	189
<b>Outside temperature</b>	
see Displays	
<b>Overhead control panel</b> .....	30
<b>P</b>	
<b>Paintwork, cleaning</b> .....	188
<b>Paintwork code</b> .....	247
<b>Panic alarm</b> .....	49
<b>Parcel net</b> .....	128
<b>Parking</b> .....	85
Rear Parking Assist system.....	115
<b>Parking Assist</b>	
see Rear Parking Assist system	
<b>Parking brake</b> .....	86
Messages in the multifunction display.....	202
<b>Parking position</b>	
Exterior rear view mirrors.....	70, 71
Transmission position.....	88
<b>Parts service</b> .....	246
<b>PASS AIR BAG OFF indicator lamp</b>	
see Front passenger front air bag off indicator lamp	
<b>Passenger safety</b>	
see Occupant safety	
<b>Pedals</b> .....	177
<b>Phone</b>	
see Telephone	
<b>Plastic parts, cleaning</b> .....	191
<b>Power assistance</b> .....	177
<b>Power outlets</b> .....	134
<b>Power seats</b>	
see Seats	
<b>Power tilt/sliding sunroof</b>	
Opening/closing in an emergency..	223
Operation.....	125
<b>Power washer</b> .....	188
<b>Power windows</b> .....	81
Cleaning.....	190
Operation.....	81
Rear door window, blocking operation.....	49
<b>Practical hints</b> .....	194
<b>Problems</b>	
While driving.....	85
With vehicle.....	21
<b>Product information</b> .....	18
<b>Production options weight</b> .....	173
<b>Proximity key</b>	
see Key, SmartKey	
<b>PSI (air pressure unit)</b> .....	173
<b>Push-start</b>	
see Tow-start	
<b>R</b>	
<b>Radio</b>	
Selecting stations.....	100
<b>Radio transmitters</b> .....	185
<b>Rain sensor</b> .....	80
<b>Rear axle oil</b> .....	252
<b>Rear door ashtray</b>	
see Ashtrays	
<b>Rear doors</b>	
Child safety locks.....	48
<b>Rear door window</b>	
Blocking operation.....	49
<b>Rear fog lamp</b>	
see Fog lamps	
<b>Rear lamps</b>	
see Tail lamps	
<b>Rear Parking Assist system</b> .....	115
Cleaning system sensors.....	190
Malfunctions.....	117
Minimum distance.....	116
Range.....	116
Sensors.....	115
Warning indicators.....	116
<b>Rear seat head restraints</b>	
see Head restraints	
<b>Rear view camera</b> .....	117
Cleaning the lens.....	190
<b>Rear window defroster</b> .....	125
<b>Rear window wiper/washer</b> .....	80
<b>Recommended tire inflation pressure</b> .....	154, 173

<b>Recovery services, Stolen vehicle (Tele Aid)</b> .....	140	<b>Seating capacity</b> .....	162
<b>Refrigerant, air conditioning</b> .....	254	<b>Seats</b> .....	62
<b>Refueling</b> .....	146	Adjusting.....	63
<b>Regular checks</b> .....	148	Easy-entry/exit feature.....	68
<b>Reminder, Seat belt</b>		Folding (expanding cargo volume) .	128
see Seat belts, Telltale		Heating.....	66
<b>Remote control</b>		Memory function.....	70
see Key, SmartKey		Multicontour seat.....	65
<b>Remote door unlock (Tele Aid)</b> .....	139	Ventilation.....	66
<b>Replacing bulbs</b> .....	226	<b>Securing cargo</b>	
<b>Reporting safety defects</b> .....	22	Cargo tie-down rings.....	128
<b>Research Octane Number</b>		<b>Selective setting</b>	
see RON		see Key, SmartKey	
<b>Reserve fuel</b>		<b>Selector lever</b>	
Messages in the multifunction		see Gear selector lever	
display.....	208	<b>Self-test</b>	
Warning lamp.....	26	BabySmart™.....	38
<b>Reset button</b> .....	27, 95	Tele Aid.....	136
<b>Restraint systems</b>		<b>Service</b>	
see Occupant safety		see Maintenance	
<b>Rims</b> .....	174, 250	<b>Service, parts</b> .....	246
<b>Roadside Assistance</b> .....	19, 137	<b>Service and warranty information</b> .....	18
<b>RON (Research Octane Number)</b> .....	255	<b>Service intervals</b>	
<b>Roof rack</b> .....	128	see Maintenance System, Service	
<b>Route guidance</b>		indicator	
see Navigation system		<b>Service life (tires)</b> .....	165
<b>Rubber parts, cleaning</b> .....	191	<b>Settings</b>	
		Factory setting (SmartKey).....	59
		Individual (vehicle).....	103
		Memory function.....	70
		Menu.....	103
		Selective setting (SmartKey).....	59
		<b>Side marker lamps</b>	
		Cleaning lenses.....	190
		Messages in the multifunction	
		display.....	209
		Replacing bulbs.....	226
		<b>Sidewall (tires)</b> .....	174
		<b>SmartKey</b>	
		see Key, SmartKey	
		<b>Snow chains</b> .....	175
		<b>Snow tires</b>	
		see Winter tires	
		<b>Spare wheel</b> .....	195, 250
		Mounting.....	233
		<b>Sport Utility Vehicle</b>	
		see SUV	

## S

**Safety**

Driving safety systems.....	50
Occupant safety.....	32
Reporting defects.....	22

**Safety belts**

  see Seat belts

**Seat belt force limiter**..... 43**Seat belts**..... 38

Children in the vehicle.....	44
Cleaning.....	192
Fastening.....	40
Height adjustment.....	42
Proper use of.....	39
Safety guidelines.....	34
Safety notes.....	38
Telltale.....	216
Warning lamp.....	216

- SRS**..... 32
    - Indicator lamp..... 32, 216
    - Messages in the multifunction display..... 199
  - Standing water, driving through**..... 179
  - Starter switch positions**..... 62
  - Starting difficulties (engine)**..... 83
  - Starting the engine**..... 83
  - Steering column**
    - see Multifunction steering wheel, Adjusting
  - Steering wheel**
    - see Multifunction steering wheel
  - Stolen Vehicle Recovery services**..... 140
  - Storage compartments**..... 130
  - Storing tires**..... 166
  - Stranded vehicle**..... 242
  - Sunroof**
    - see Power tilt/sliding sunroof
  - Sun visors**..... 132
  - SUV (Sport Utility Vehicle)**..... 20
- T**
- Tachometer**..... 26, 96
    - Overspeed range..... 96
  - Tailgate**
    - Closing..... 61
    - Messages in the multifunction display..... 204
    - Opening..... 61
  - Tail lamps**..... 226
    - Cleaning lenses..... 190
    - Messages in the multifunction display..... 211
    - Replacing bulbs..... 226
  - Tar stains**..... 188
  - Technical data**
    - Air conditioning refrigerant..... 254
    - Brake fluid..... 254
    - Capacities fuels, coolants, lubricants etc..... 252
    - Coolant..... 255
    - Engine oil additives..... 254
    - Engine oils..... 253
    - Fuel requirements..... 255
    - Gasoline additives..... 255
    - Identification labels..... 246
    - Premium unleaded gasoline..... 254
    - Rims and tires..... 250
    - Spare wheel..... 251
    - Vehicle specification G 550..... 248
    - Vehicle specification G 55 AMG..... 249
    - Washer and headlamp cleaning system..... 253, 257
  - Technical data (dimensions)**
    - see Vehicle specification
  - Technical data (electrical system)**
    - see Vehicle specification
  - Technical data (engine)**
    - see Vehicle specification
  - Technical data (weights)**
    - see Vehicle specification
  - Tele Aid**..... 135
    - Emergency calls..... 136
    - Information button..... 138
    - Initiating an emergency call manually..... 137
    - Messages in the multifunction display..... 203
    - Remote door unlock..... 139
    - Roadside Assistance button..... 137
    - Search and send..... 139
    - SOS button..... 137
    - Stolen Vehicle Recovery services... 140
    - System self-test..... 136
  - Telephone**..... 27
    - Answering/ending a call..... 111
    - Hands-free microphone..... 30
    - Menu..... 110
    - Operation..... 110
    - Phone book..... 111
    - Redialing..... 112
  - Temperature**
    - Coolant..... 96
    - Interior temperature..... 121
    - Outside..... 100, 105
  - Tether anchorage points**
    - see Children in the vehicle
  - Tie-down rings**..... 128
  - Tightening torque**
    - Wheels..... 235
  - TIN (Tire Identification Number)**..... 174
  - Tire and Loading Information placard**..... 161
  - Tire and loading terminology**..... 172



- Tire Identification Number**
  - see TIN
- Tire inflation pressure**
  - Checking..... 156
  - Important notes on..... 155
  - Placard on driver's door B-pillar..... 161
- Tire labeling**..... 168
- Tire load rating**..... 174
- Tire ply composition and material used**..... 174
- Tires**..... 154, 250
  - Advanced Tire Pressure Monitoring System (Advanced TPMS)..... 157
  - Advanced TPMS low tire pressure/malfunction telltale (USA only)..... 219
  - Advanced TPMS low tire pressure telltale (Canada only)..... 219
  - Air pressure..... 154
  - Care and maintenance..... 165
  - Cleaning..... 166
  - Direction of rotation, spinning..... 164
  - Important notes on tire inflation pressure..... 155
  - Inflation pressure..... 156, 157
  - Information placard..... 161
  - Inspection..... 165
  - Labeling..... 168
  - Load rating..... 174
  - Messages in the multifunction display..... 200, 212
  - Ply composition and material used. 174
  - Problems under-/overinflation..... 156
  - Retreads..... 154
  - Rims and tires (technical data)..... 250
  - Rotation..... 167
  - Service life..... 165
  - Sizes..... 250
  - Snow chains..... 175
  - Speed rating..... 169, 174
  - Storing..... 166
  - Temperature..... 155, 167
  - Terminology..... 172
  - Tire Identification Number..... 174
  - Traction..... 166, 174
  - Tread..... 174
  - Tread depth..... 165, 175
  - Treadwear indicators..... 165, 174
  - Vehicle maximum load on..... 174
  - Wear pattern..... 167
  - Winter tires..... 175, 250
- Tire speed rating**..... 169, 174
- Tongue Weight Rating**
  - see TWR
- Top tether**
  - see Children in the vehicle
- Total load limit**..... 174
- Tow-away alarm**..... 55
- Towing**
  - Vehicle..... 239
- Tow-start**..... 237, 239
- Traction**..... 174
- Transfer case**..... 91
  - Gear ranges..... 91
  - Messages in the multifunction display..... 203
  - Switching..... 91
- Transmission**
  - see Automatic transmission
- Transmission fluid level**..... 153
- Transmission gear selector lever**
  - see Gear selector lever
- Transmission positions**..... 88
- Traveling abroad**..... 185
- Tread (tires)**..... 174
- Tread depth (tires)**..... 165, 175
- Treadwear indicators (tires)**..... 165, 174
- Trip computer menu**..... 109
- Trip odometer, resetting**..... 96
- Turning off the engine**..... 86
- Turn signals**..... 75
  - Additional in mirrors..... 226
  - Bulbs..... 226
  - Cleaning lenses..... 190
  - Indicator lamps..... 26
  - Messages in the multifunction display..... 212
  - Replacing bulbs..... 226
- TWR (Tongue Weight Rating)**..... 174

**U**

<b>Uniform Tire Quality Grading Standards</b> .....	166, 174
<b>Units, Settings</b>	
Speedometer.....	105
<b>Unleaded gasoline, premium</b> .....	254
<b>Unlocking the vehicle</b> .....	58
Manually.....	221
<b>Upholstery, cleaning</b> .....	192
<b>Useful features</b> .....	131

**V**

<b>Vehicle</b>	
Battery.....	236
Care.....	187
Control system.....	97
Identification Number (VIN).....	246
Individual settings.....	103
Locking/unlocking.....	58
Locking/unlocking manually.....	221
Lowering (wheel change).....	235
Modifications and alterations,	
Operating safety.....	21
Towing.....	239
<b>Vehicle dimensions</b>	
see Vehicle specification	
<b>Vehicle Identification Number (VIN)</b> .....	246
<b>Vehicle jack</b>	
see Jack	
<b>Vehicle lighting</b> .....	72
<b>Vehicle loading</b>	
Cargo tie-down rings.....	128
Cargo volume, expanding.....	128
Instructions.....	126
Load limit.....	162
Roof rack.....	128
Terminology.....	172
<b>Vehicle maximum load on the tire</b> ....	174
<b>Vehicle Recovery services, Stolen (Tele Aid)</b> .....	140
<b>Vehicle specification</b>	
G 550.....	248
G 55 AMG.....	249
<b>Vehicle status message memory</b> .....	102
<b>Vehicle tool kit</b> .....	194

**Vehicle washing**

see Vehicle care

**Vehicle weights**

see Vehicle specification

**W****Warning sounds**

Driver's or passenger's seat belt.....	43
Parking brake.....	202
Rear Parking Assist system.....	117
Seat belt telltale.....	216
<b>Warranty coverage</b> .....	246

**Washer and headlamp cleaning system**.....

257

**Washer fluid**

Messages in the multifunction display.....	204
Mixing ratio.....	257
Refilling.....	153
Wiping.....	80

**Washing the vehicle**.....

187

**Wear pattern (tires)**.....

167

**Weights (vehicle)**

see Vehicle specification

**Wheel**

Changing.....	232
Removing.....	234
Spare.....	232
Tightening torque.....	235

**Wheels, sizes**.....

250

**Wheels, Tires and**.....

154

**Window curtain air bags**.....

36

**Windows**

see Power windows

**Windows, cleaning**.....

190

**Windshield**

Cleaning wiper blades.....	190
Defogging.....	124
Washer fluid.....	80, 257
Wipers.....	79

**Windshield defroster**.....

124

**Windshield wipers**

Rain sensor.....	80
Replacing wiper blades.....	231

**Winter driving**

Snow chains.....	175
Tires.....	175

<b>Winter driving instructions.....</b>	176
<b>Winter tires.....</b>	175, 250
<b>Wood trims, cleaning.....</b>	192

### Product Information

Please observe the following in your own best interest:

We recommend using Genuine Mercedes-Benz Parts as well as conversion parts and accessories explicitly approved by us for your vehicle model.

We have tested these parts to determine their reliability, safety and special suitability for Mercedes-Benz vehicles.

We are unable to make an assessment for other products and therefore cannot be held responsible for them, even if in individual cases an official approval or authorization by governmental or other agencies should exist. Use of such parts and accessories could adversely affect the safety, performance or reliability of your vehicle. Please do not use them.

Genuine Mercedes-Benz Parts and pre-approved conversion parts and accessories are available at any authorized Mercedes-Benz Center. In addition, you will receive comprehensive information on permissible technical modifications and expert installations.

### Operator's Manual

#### Notes

This Operator's Manual contains a great deal of useful information. We urge you to read it carefully and familiarize yourself with the vehicle before driving.

For your own safety and longer service life of the vehicle, we urge you to follow the instructions and warnings contained in this Operator's Manual. Ignoring them could result in damage to the vehicle or personal injury to you or others. Vehicle damage caused by failure to follow instructions is not covered by the Mercedes-Benz Limited Warranty.

We continuously strive to improve our product, and ask for your understanding that we reserve the right to make changes in design and equipment. Therefore, information, illustrations, and descriptions in this Operator's Manual might differ from your vehicle.

### Vehicle equipment

Your vehicle may have some or all of the equipment described in this manual.

Therefore, you may find explanations for optional equipment not installed in your vehicle. If you have any questions about operating any equipment, any authorized Mercedes-Benz Center will be glad to demonstrate the proper procedures.

Optional equipment is also described in this manual, including operating instructions wherever necessary. Since they are special-order items, the descriptions and illustrations herein may vary slightly from the actual equipment of your vehicle.

If there are any equipment details that are not shown or described in this Operator's Manual, any authorized Mercedes-Benz Center will be glad to inform you of correct care and operating procedures. The Operator's Manual and Maintenance Booklet are important documents and should be kept with the vehicle.

### Service and warranty information

The Service and Warranty Information booklet contains detailed information about the warranties covering your Mercedes-Benz, including:

- New Vehicle Limited Warranty
- Emission System Warranty
- Emission Performance Warranty
- California, Connecticut, Maine, Massachusetts, New York, Pennsylvania,

Rhode Island, and Vermont Emission Control System Warranty

- State Warranty Enforcement Laws (Lemon Laws)

Mercedes-Benz USA, LLC  
Customer Assistance Center  
One Mercedes Drive  
Montvale, NJ 07645-0350

### Important notice for California retail buyers and lessees of Mercedes-Benz automobiles

Under California law you may be entitled to a replacement of your vehicle or a refund of the purchase price or lease price, if after a reasonable number of repair attempts Mercedes-Benz USA, LLC and/or its authorized repair or service facilities fail to fix one or more substantial defects or malfunctions in the vehicle that are covered by its express warranty. During the period of 18 months from original delivery of the vehicle or the accumulation of 18 000 miles (approximately 29 000 km) on the odometer of the vehicle, whichever occurs first, a reasonable number of repair attempts is presumed for a retail buyer or lessee if one or more of the following occurs:

- (1) the same substantial defect or malfunction results in a condition that is likely to cause death or serious bodily injury if the vehicle is driven, that defect or malfunction has been subject to repair two or more times, and you have directly notified Mercedes-Benz USA, LLC in writing of the need for its repair,
- (2) the same substantial defect or malfunction of a less serious nature than category (1) has been subject to repair four or more times and you have directly notified us in writing of the need for its repair, or
- (3) the vehicle is out of service by reason of repair of the same or different substantial defects or malfunctions for a cumulative total of more than 30 calendar days.

Written notification should not be sent to a dealer, it should be addressed to

### Maintenance

The Maintenance Booklet describes all the necessary maintenance work which should be performed at regular intervals.

Always have the Maintenance Booklet with you when you take the vehicle to an authorized Mercedes-Benz Center for service. The service advisor will record each service in the booklet for you.

### Roadside Assistance

The Mercedes-Benz Roadside Assistance Program provides factory-trained technical help in the event of a breakdown. Calls to the toll-free Roadside Assistance number

**1-800-FOR-MERCEdes (in the USA)**  
**1-800-387-0100 (in Canada)**

will be answered by Mercedes-Benz Customer Assistance Representatives 24 hours a day, 365 days a year.

Roadside Assistance will be provided in accordance with standard program guidelines which include providing service to the vehicle up to a reasonable distance from a paved roadway. We will make every effort to assist in a breakdown situation, however, the accessibility of your vehicle will be determined by our authorized Mercedes-Benz Center technician or the tow service provider on a case-by-case basis and may be a factor in our ability to respond.

Additional charges may be applicable for a breakdown location determined not to be a reasonably accessible roadside location as determined by our authorized technician and tow service provider.

For additional information refer to the Mercedes-Benz Roadside Assistance

Program brochure (in the USA) or the Roadside Assistance section of the Service and Warranty Information Booklet (in Canada) in your vehicle literature portfolio.

### Change of address or ownership

If you change your address, be sure to send in the “Change of Address Notice” found in the Service and Warranty Information Booklet, or simply call the Mercedes-Benz Customer Assistance Center (in the USA) at 1-800-FOR-MERcedes, or Customer Service (in Canada) at 1-800-387-0100. This will assist us in contacting you in a timely manner should the need arise.

If you sell your Mercedes, please leave all literature with the vehicle to make it available to the next operator.

If you bought this vehicle used, be sure to send in the “Notice of Purchase of Used Truck” found in the Service and Warranty Information Booklet, or call the Mercedes-Benz Customer Assistance Center (in the USA) at 1-800-FOR-MERcedes, or Customer Service (in Canada) at 1-800-387-0100.

### Operating your vehicle outside the USA or Canada

If you plan to operate your vehicle in foreign countries, please be aware that:

- service facilities or replacement parts may not be readily available,
- unleaded gasoline for vehicles with catalytic converters may not be available; the use of leaded fuels will damage the catalysts,
- gasoline may have a considerably lower octane rating, and improper fuel can cause engine damage.

Certain Mercedes-Benz models are available for delivery in Europe under our European Delivery Program. For details, consult an authorized Mercedes-Benz Center or write to:

### In the USA:

Mercedes-Benz USA, LLC  
European Delivery Department  
One Mercedes Drive  
Montvale, NJ 07645-0350

### In Canada:

Mercedes-Benz Canada, Inc.  
European Delivery Department  
98 Vanderhoof Avenue  
Toronto, Ontario M4G 4C9

### Sport Utility Vehicle

#### Warning!

This Sport Utility Vehicle is designed for both on-road and off-road use. It can go places and perform tasks for which conventional 2-wheel drive passenger cars are not intended. This vehicle will handle and maneuver differently from conventional passenger cars in driving conditions which may occur on streets, highways and off-road use.

This vehicle has a higher ground clearance and a higher center of gravity than many passenger cars. As with other vehicles of this type, if you make sharp turns at excessive speeds or abrupt maneuvers, the vehicle may roll over or may go out of control and crash. Utility vehicles have a significantly higher rollover rate than other types of vehicles. Failure to operate this vehicle safely may result in an accident, rollover of the vehicle, and severe or fatal injury.

Before you start to drive this vehicle, read the Operator’s Manual. Take time to become familiar with the driving characteristics of this vehicle. Be sure you are familiar with all vehicle controls. Learn how your vehicle handles on different road surfaces. Do not attempt sharp turns at excessive speeds or abrupt maneuvers or other unsafe driving actions that can cause loss of vehicle control. When driving off-road or working the vehicle hard, do not overload it. And, always wear your seat belts at all times. In a rollover crash,

an unbelted person is significantly more likely to die than a person wearing a seat belt.

qualified maintenance or repair facility for further inspection or repairs.

## Operating safety

### **Warning!**

Work improperly carried out on electronic components and associated software could cause them to cease functioning. Because the vehicle's electronic components are interconnected, any modifications made may produce an undesired effect on other systems. Electronic malfunctions could seriously impair the operating safety of your vehicle.

Contact an authorized Mercedes-Benz Center for repairs or modifications to electronic components.

Other improper work or modifications on the vehicle could also have a negative impact on the operating safety of the vehicle.

Some safety systems only function while the engine is running. You should therefore never turn off the engine while driving.

### **Warning!**

Heavy blows against the vehicle underbody or tires/wheels may cause serious damage and impair the operating safety of your vehicle. Such blows can be caused, for example, by running over an obstacle, road debris or a pothole. If you feel a sudden significant vibration or ride disturbance, or you suspect that damage to your vehicle as occurred:

- turn on your hazard warning flashers
- slow down carefully
- drive with caution to an area which is a safe distance from the road

Inspect the vehicle underbody and tires/wheels for possible damage. If the vehicle appears unsafe, have it towed to the nearest authorized Mercedes-Benz Center or other

## Proper use of the vehicle

Proper use of the vehicle requires that you are familiar with the following information and rules:

- the safety precautions in this manual
- the "Technical data" section in this manual
- traffic rules and regulations
- motor vehicle laws and safety standards

### **Warning!**

Various warning labels are attached to your vehicle. These warning labels are intended to make you and others aware of various risks. Do not remove any of these warning labels unless explicitly instructed to do so by information on the label itself. Removing warning labels may cause you and others to be unaware of certain risks which may result in an accident and/or personal injury.

## Problems with your vehicle

If you should experience a problem with your vehicle, particularly one that you believe may affect its safe operation, we urge you to contact an authorized Mercedes-Benz Center immediately to have the problem diagnosed and corrected if required. If the matter is not handled to your satisfaction, please discuss the problem with the Mercedes-Benz Center management or, if necessary, contact us at one of the following addresses:

### **In the USA:**

Customer Assistance Center  
Mercedes-Benz USA, LLC  
One Mercedes Drive  
Montvale, NJ 07645-0350

### **In Canada:**

Customer Relations Department  
Mercedes-Benz Canada, Inc.

98 Vanderhoof Avenue  
Toronto, Ontario M4G 4C9

### Reporting safety defects

For the USA only:

The following text is published as required of manufacturers under Title 49, Code of U.S. Federal Regulations, Part 575 pursuant to the "National Traffic and Motor Vehicle Safety Act of 1966".

### Reporting safety defects

If you believe that your vehicle has a defect which could cause a crash or could cause injury or death, you should immediately inform the National Highway Traffic Safety Administration (NHTSA) in addition to notifying Mercedes-Benz USA, LLC.

If NHTSA receives similar complaints, it may open an investigation, and if it finds that a safety defect exists in a group of vehicles, it may order a recall and remedy campaign. However, NHTSA cannot become involved in individual problems between you, your dealer, or Mercedes-Benz USA, LLC.

To contact NHTSA, you may call the Vehicle Safety Hotline toll-free at 1-888-327-4236 (TTY: 1-800-424-9153); go to

**[www.safercar.gov](http://www.safercar.gov)**; or write to:

Administrator, NHTSA Headquarters,  
1200 New Jersey Avenue, SE, West Building,  
Washington, DC 20590.

You can also obtain other information about motor vehicle safety from

**[www.safercar.gov](http://www.safercar.gov)**.

### Vehicle data recording

#### Information regarding electronic recording devices

(Including notice pursuant to California Code § 9951)

Please note that your vehicle is equipped with devices that can record vehicle systems data and, if equipped with the Tele Aid system, may transmit some data in certain accidents.

This information helps, for example, to diagnose vehicle systems after a collision and to continuously improve vehicle safety.

Daimler may access the information and share it with others

- for safety research or vehicle diagnosis purposes
- with the consent of the vehicle owner or lessee
- in response to an official request by law enforcement or other government agency
- for use in dispute resolution involving Daimler, its affiliates or sales/service organization and/or
- as otherwise required or permitted by law.

Please check the Tele Aid subscription service agreement for details regarding the information that may be recorded or transmitted via that system.



<b>Exterior view</b> .....	24
<b>Cockpit</b> .....	25
<b>Instrument cluster</b> .....	26
<b>Multifunction steering wheel</b> .....	27
<b>Center console</b> .....	28
<b>Overhead control panel</b> .....	30
<b>Door control panel</b> .....	30



## Exterior view

At a glance

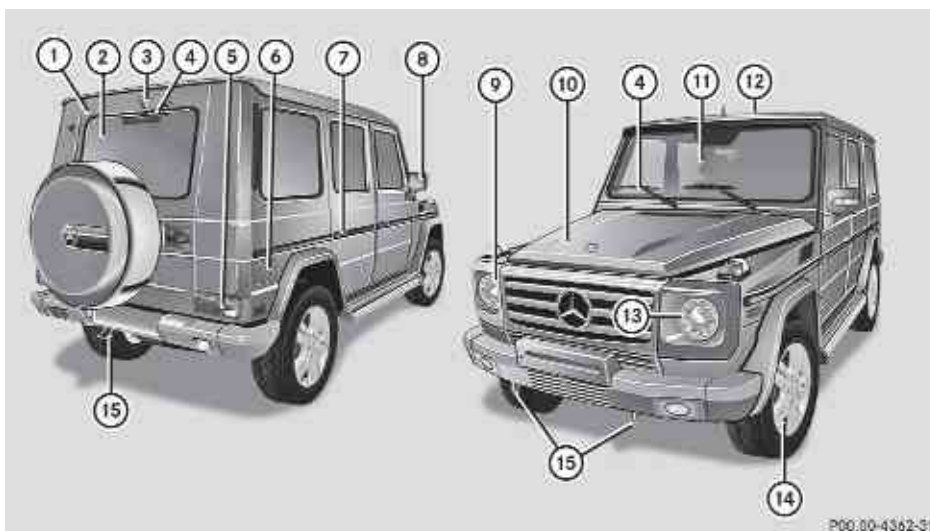

P00:00-4362-31

**i** This Operator's Manual describes all features, standard or optional, potentially available for your vehicle at the time of purchase. Please be aware that your vehicle might not be equipped with all features described in this manual.

	Function	Page
①	Tailgate: Opening and closing Unlocking manually	61 221
②	Rear window defroster	125
③	Rear view camera	117
④	Wipers Wiper blades, replacing Wiper blades, cleaning	79 231 190
⑤	Rear lamps	226
⑥	Fuel filler flap	146
⑦	Doors: Locking and unlocking Opening Locking and unlocking manually	58 59 221

	Function	Page
⑧	Exterior rear view mirrors	69
⑨	Front lamps	226
⑩	Hood	148
⑪	Windshield: Wiping with washer fluid Cleaning Windshield defroster	80 190 124
⑫	Power tilt/sliding sunroof	125
⑬	Headlamp cleaning system	75
⑭	Tires and wheels Rims and tires	154 250
⑮	Towing eyes	239

Cockpit

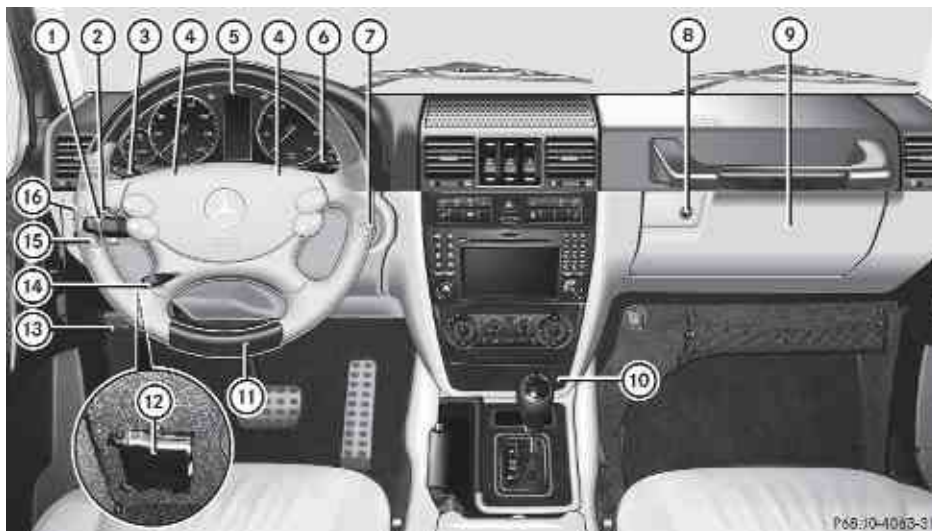

At a glance

	Function	Page
①	Combination switch: • Turn signals • Wipers • High beam	75 79 75
②	Headlamp cleaning button	75
③	Cruise control lever	112
④	Horn	
⑤	Instrument cluster	26, 95
⑥	Lever for Voice Control System, see separate operating instructions	
⑦	Starter switch	62
⑧	Glove box lock	130







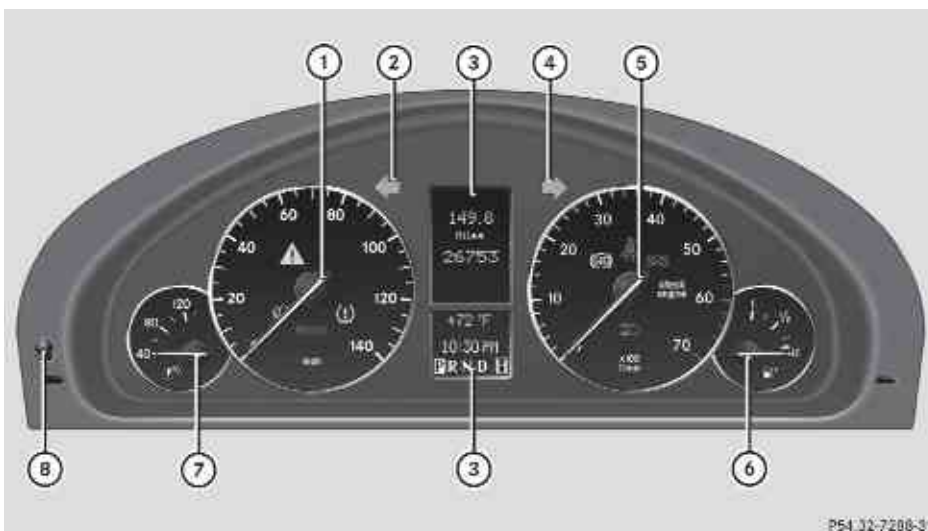

	Function	Page
⑨	Glove box	130
⑩	Center console	28
⑪	Multifunction steering wheel	27, 97
⑫	On-board diagnostics (OBD) socket	
⑬	Hood lock release lever	148
⑭	Steering wheel adjustment Heated steering wheel	67 69
⑮	Exterior lamp switch	72
⑯	Exterior rear view mirror adjustment	69







## Instrument cluster

At a glance



P54.32-7208-31

	Function	Page
①	<b>Speedometer with:</b>  Low-beam headlamp indicator lamp  Electronic Stability Program (ESP®) warning lamp  Combination low tire pressure/TPMS malfunction telltale, USA only  Low tire pressure telltale, Canada only  Brake warning lamp, USA only  Brake warning lamp, Canada only	72 217 157, 219 157, 219 215 215
②	 Left turn signal indicator lamp	75
③	Multifunction display	98
④	 Right turn signal indicator lamp	75

	Function	Page
⑤	<b>Tachometer with:</b>  Antilock Brake System (ABS) indicator lamp  Seat belt telltale  Supplemental Restraint System (SRS) indicator lamp  Engine malfunction indicator lamp, USA only  Engine malfunction indicator lamp, Canada only  High-beam headlamp indicator lamp	214 43, 216 32, 216 218 218 75
⑥	<b>Fuel gauge with:</b>  Fuel tank reserve warning lamp ( the arrow indicates that the fuel filler flap is on the right-hand side)	218
⑦	Coolant temperature gauge	96

	Function	Page
⑧	<b>Reset button for:</b> Trip odometer Settings Adjusting instrument cluster illumination	96 103 96





Multifunction steering wheel



At a glance

	Function	Page
①	Multifunction display	98
②	Press button  or <ul style="list-style-type: none"> <li>to select submenus in the Settings menu</li> <li>to set values</li> <li>to set the volume</li> </ul>	104
③	Press button <ul style="list-style-type: none"> <li>to answer a call</li> <li>to dial<sup>1</sup></li> <li>to redial<sup>1</sup></li> </ul> Press button <ul style="list-style-type: none"> <li>to end a call</li> <li>to reject an incoming call</li> </ul>	110 110 110 110 110
④	Press button  or to select next or previous menu	97

<sup>1</sup> Function only available in telephone menu.

	Function	Page
⑤	Press button  or  briefly <ul style="list-style-type: none"> <li>to move within a menu</li> <li>to select previous or next track, or stored station within <b>Audio/DVD</b> menu</li> <li>to switch to the phone book and select a name or number within <b>Telephone</b> menu</li> </ul>	100
	Press and hold button  or  <ul style="list-style-type: none"> <li>to select previous or next track with quick search, or to select previous or next station in station list or wave band within <b>Audio/DVD</b> menu</li> <li>to start the quick search in the phone book within <b>Telephone</b> menu</li> </ul>	110

**i** Canada vehicles: The steering wheel in this vehicle may vary from steering wheel shown. However, multifunction steering wheel symbols and feature description apply to Canada vehicles as well.

**i** G 55 AMG: The steering wheel in this vehicle may vary from steering wheel shown. However, multifunction steering wheel symbols and feature description apply to AMG vehicles as well.

Center console

Upper part

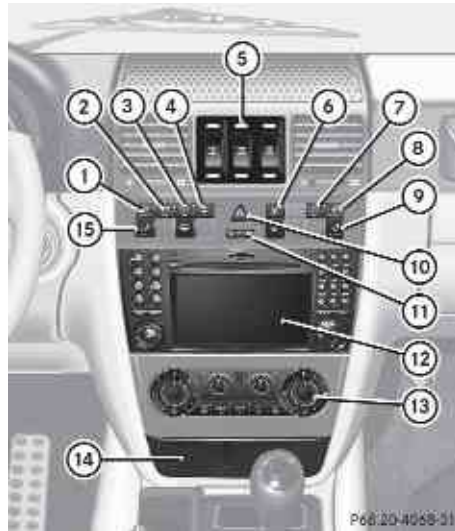

	Function	Page
①	Seat heating switch, driver's side	66
②	Windshield defroster switch	124
③	Rear window wiper/washer switch	80
④	Electronic Stability Program (ESP®) switch	52
⑤	Differential lock switches	93
⑥	Central unlocking switch Central locking switch	60 60
⑦	Alarm system indicator lamp Tow-away alarm off switch	54 55
⑧	Seat heating switch, front passenger side	66
⑨	Seat ventilation switch, front passenger side	66

	Function	Page
⑩	Hazard warning flasher switch	75
⑪	Front passenger front air bag off indicator lamp	36
⑫	COMAND system, see separate operating instructions	
⑬	Climate control	119
⑭	Ashtray Cigarette lighter	133 134
⑮	Seat ventilation switch, driver's side	66

Lower part



At a glance

	Function	Page
①	Storage compartment	130
②	Gear selector lever	87
③	Transfer case switch	91
④	Parking brake lever	86

Overhead control panel



	Function	Page
①	Tele Aid (emergency call system) button	137
②	Cargo compartment lamps on/off	78
③	Right reading lamp on/off	77
④	Power tilt/sliding sunroof switch	125
⑤	Automatic interior lighting	77
⑥	Interior rear view mirror	69
⑦	Garage door opener	140
⑧	Hands-free microphone for Tele Aid (emergency call system) and telephone	
⑨	Left reading lamp on/off	77

Door control panel



	Function	Page
①	Switches for opening/closing front and rear door windows	81
	Override switch	49
②	Seat adjustment	63
③	Inside door handle	59
④	Memory function (for storing seat, exterior rear view mirrors, and steering wheel settings)	70



<b>Vehicle equipment .....</b>	<b>32</b>
<b>Occupant safety .....</b>	<b>32</b>
<b>Panic alarm .....</b>	<b>49</b>
<b>Driving safety systems .....</b>	<b>50</b>
<b>Anti-theft systems .....</b>	<b>54</b>



## Vehicle equipment

- i** This Operator's Manual describes all features, standard or optional, potentially available for your vehicle at the time of purchase. Please be aware that your vehicle might not be equipped with all features described in this manual.

## Occupant safety

### Introduction

In this section you will learn the most important facts about the restraint system components of the vehicle.

The restraint systems are:

- Seat belts
- Child restraints
- Lower Anchors and Iethers for Children (LATCH)

Additional protection potential is provided by:

- Supplemental Restraint System (SRS) with
  - Air bags
  - Air bag control unit (with crash sensors)
  - Emergency Tensioning Device (ETD) for front and rear outer seat belts
  - Seat belt force limiter
- Air bag system components with
  - Front passenger front air bag off indicator lamp
  - Front passenger seat with BabySmart™ air bag deactivation system

Although the systems are independent, their protective functions work in conjunction with each other.

### **Warning!**

Modifications to or work improperly conducted on restraint system components or their wiring, as well as tampering with interconnected electronic systems, can lead

to the restraint systems no longer functioning as intended.

Air bags or Emergency Tensioning Devices (ETDs), for example, could deploy inadvertently or fail to deploy in accidents although the deceleration threshold for air bag deployment is exceeded. Therefore, never modify the restraint systems. Do not tamper with electronic components or their software.

- i** For information on infants and children traveling with you in the vehicle and restraint systems for infants and children, see "Children in the vehicle" (▷ page 44).

### SRS indicator lamp

The SRS system conducts a self-test when the ignition is switched on and in regular intervals while the engine is running. This facilitates detection of system malfunctions.

The **SRS** indicator lamp in the instrument cluster comes on when the ignition is switched on and goes out no later than a few seconds after the engine has been started.

The SRS components are in operational readiness if the **SRS** indicator lamp is not lit when the engine is running.

A malfunction in the system has been detected if the **SRS** indicator lamp

- fails to go out after approximately 4 seconds after the engine is started
- does not come on at all
- comes on after the engine was started or while driving

### **Warning!**

In the event that the **SRS** indicator lamp comes on while driving or does not come on at all, the SRS self-check has detected a malfunction. For your safety, we strongly recommend that you contact an authorized Mercedes-Benz Center immediately to have

the system checked; otherwise the SRS may not deploy when needed in an accident, which could result in serious or fatal injury, or it might deploy unexpectedly and unnecessarily which could also result in injury.

In addition, improper work on the SRS creates a risk of rendering the SRS inoperative or causing unintended air bag deployment. Work on the SRS must therefore only be performed by qualified technicians. Contact an authorized Mercedes-Benz Center.

If it is necessary to modify an air bag system to accommodate a person with disabilities, contact an authorized Mercedes-Benz Center or call our Customer Assistance Center at 1-800-FOR-MERCEDES (1-800-367-6372) for details.

### Air bags

#### **Warning!**

Air bags are designed to reduce the potential of injury and fatality in certain frontal impacts (front air bags), or side impacts (window curtain air bags). However, no system available today can completely eliminate injuries and fatalities.

The deployment of the air bags temporarily releases a small amount of dust from the air bags. This dust, however, is neither injurious to your health, nor does it indicate a fire in the vehicle. The dust might cause some temporary breathing difficulty for people with asthma or other breathing trouble. To avoid this, you may wish to get out of the vehicle as soon as it is safe to do so. If you have any breathing difficulty but cannot get out of the vehicle after the air bag inflates, then get fresh air by opening a window or door.

#### **Warning!**

To reduce the risk of injury when the front air bags inflate, it is very important for the driver and front passenger to always be in a properly

seated position and to wear their respective seat belt.

For maximum protection in the event of a collision always be in normal seated position with your back against the seat backrest.

Fasten your seat belt and make sure it is properly positioned on your body.

Since the air bag inflates with considerable speed and force, a proper seating position and correct positioning of the hands on the steering wheel will help to keep you at a safe distance from the air bag. Occupants who are not wearing their seat belt, are not seated properly or are too close to the air bag can be seriously injured or killed by an air bag as it inflates with great force instantaneously:

- Sit with the seat belt properly fastened in a position that is as upright as possible with your back against the seat backrest.
- Move the driver seat as far back as possible, still permitting proper operation of vehicle controls. The distance from the center of the driver's chest to the center of the air bag cover on the steering wheel must be at least 10 inches (25 cm) or more. You should be able to accomplish this by adjusting the seat and steering wheel. If you have any difficulties, please contact an authorized Mercedes-Benz Center.
- Do not lean your head or chest close to the steering wheel or dashboard.
- Keep hands on the outside of the steering wheel rim. Placing hands and arms inside the rim can increase the risk and potential severity of hand/arm injury when the driver front air bag inflates.
- Adjust the front passenger seat as far as possible rearward from the dashboard when the seat is occupied.
- Occupants, especially children, should never place their bodies or lean their heads in the area of the door where the window curtain air bag inflates. This could result in serious injuries or death should the window

curtain air bag be deployed. Always sit as upright as possible, wear the seat belt properly and use an appropriately sized infant restraint, toddler restraint, or booster seat recommended for the size and weight of the child.

- Children 12 years old and under must never ride in the front seat, except in a Mercedes-Benz authorized BabySmart™ compatible child seat, which operates with the BabySmart™ air bag deactivation system installed in the vehicle to deactivate the front passenger front air bag when it is installed properly. Otherwise they will be struck by the air bag when it inflates in a crash. If this happens, serious or fatal injury will result.

Failure to follow these instructions can result in severe injuries to you or other occupants.

If you sell your vehicle, it is important that you make the buyer aware of this safety information. Be sure to give the buyer this Operator's Manual.

#### **Warning!**

Accident research shows that the safest place for children in an automobile is in the rear seat. Should you choose to place a child 12 years old or under in the front passenger seat of your vehicle, you must properly use a BabySmart™ child restraint which will turn off the front passenger front air bag.

To help avoid the possibility of injury, please follow these guidelines:

- (1) Always sit as upright as possible, properly use the seat belts, and for children 12 years old and under, use an appropriately sized infant restraint, toddler restraint, or booster seat recommended for the size and weight of the child.
- (2) Always wear seat belts properly.

Air bags are designed to deploy only in certain frontal impacts (front air bags) and in side impacts (window curtain air bags) which

exceed preset deployment thresholds. Only in the event of such a situation will they provide their supplemental protection.

The driver and passengers should always wear their seat belts. Otherwise it is not possible for the air bags to provide their supplemental protection.

In case of other types of impacts and impacts below air bag deployment thresholds, air bags will not deploy. The driver and passengers will then be protected to the extent possible by a properly fastened seat belt. A properly fastened seat belt is also needed to provide the best possible protection in a rollover.

Air bags are not a substitute for seat belts. Always wear your seat belt, regardless of whether or not your vehicle is equipped with air bags.

It is important to your safety and that of your passengers that you replace deployed air bags and repair any malfunctioning air bags to make sure the vehicle will continue to provide supplemental crash protection for occupants.

#### **Safety guidelines for the seat belt, Emergency Tensioning Device (ETD) and air bag**

##### **Warning!**

- Damaged seat belts or seat belts that have been subjected to stress in an accident must be replaced and their anchoring points must also be checked. Only use seat belts installed or supplied by an authorized Mercedes-Benz Center.
- Air bags and pyrotechnic Emergency Tensioning Devices (ETDs) contain perchlorate material, which may require special handling and regard for the environment. Check with your local government's disposal guidelines. California residents, see

**[www.dtsc.ca.gov/HazardousWaste/Perchlorate/index.cfm](http://www.dtsc.ca.gov/HazardousWaste/Perchlorate/index.cfm).**

- Air bags and ETDs are designed to function on a one-time-only basis. An air bag or ETD that is deployed must be replaced.
- Do not pass seat belts over sharp edges. They could tear.
- Do not make any modification that could change the effectiveness of the seat belts.
- Do not bleach or dye seat belts as this may severely weaken them. In a crash they may not be able to provide adequate protection.
- No modifications of any kind may be made to any components or wiring of the SRS. This includes changing or removing any component or part of the SRS, the installation of additional trim material, seat covers, badges, etc. over the steering wheel hub, front passenger front air bag cover, outboard sides of the seat backrests, door trim panels, or door frame trims, and installation of additional electrical/electronic equipment on or near SRS components and wiring. Keep area between air bags and occupants free of objects (e.g. packages, purses, umbrellas, etc.).
- Do not hang items such as coat hangers from the coat hooks or handles over the door. These items may be thrown around in the vehicle and cause head and other injuries when the window curtain air bag is deployed.
- Air bag system components will be hot after an air bag has inflated. Do not touch them.
- Never place your feet on the instrument panel, dashboard, or on the seat. Always keep both feet on the floor in front of the seat.
- In addition, improper repair work on the SRS creates a risk of rendering the SRS inoperative or causing unintended air bag deployment. Work on the SRS must

therefore only be performed by qualified technicians. Contact an authorized Mercedes-Benz Center.

- For your protection and the protection of others, when scrapping the air bag unit or ETD, our safety instructions must be followed. These instructions are available from any authorized Mercedes-Benz Center.
- Given the considerable deployment speed, required inflation volume, and the material of the air bags, there is the possibility of abrasions or other, potentially more serious injuries resulting from air bag deployment.

If you sell your vehicle, we strongly recommend that you inform the subsequent owner that the vehicle is equipped with SRS and refer them to the applicable section in the Operator's Manual.

### Front air bags

 **Observe Safety notes, see page 33.**



Driver's front air bag ① and front passenger front air bag ② are designed to provide increased protection for the driver and front passenger against the risk of injuries to the head and thorax.

Driver and front passenger front air bags are deployed

- in the event of certain frontal impacts
- if impact exceeds a preset deployment threshold

- if the system determines that air bag deployment can offer additional protection to that provided by the seat belt
- depending on whether the seat belt is in use
- independently of the window curtain air bags

The air bags will not deploy in impacts which do not exceed the system's preset deployment thresholds. You will then be protected by the fastened seat belts.

The front air bags will not deploy in the event of a rollover unless the vehicle's rate of longitudinal deceleration or acceleration exceeds the preset deployment threshold for the front air bags.

The front passenger front air bag will only be deployed if

- the front passenger seat is occupied
- the  indicator lamp in the center console is not lit (▷ page 36)
- the impact exceeds a preset deployment threshold

**!** Do not place objects heavier than 20 lb (9 kg) on the front passenger seat. This could cause the front air bag on the front passenger side to deploy in a crash which exceeds the system's deployment threshold.

### Window curtain air bags

 **Observe Safety notes, see page 33.**

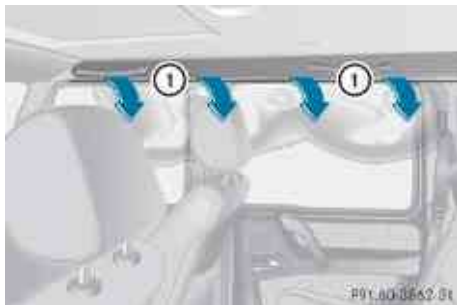

When deployed, window curtain air bags ① are designed to provide increased protection for the head (but not the chest or arms) of the occupants on the side of the vehicle on which the impact occurs.

Window curtain air bags ① are deployed

- on the impacted side of the vehicle
- in side impacts exceeding a preset deployment threshold
- independently of the front air bags
- regardless of whether the front passenger seat is occupied
- regardless of whether the seat belt is in use
- in certain vehicle rollovers, if the system determines that air bag deployment can offer additional protection to that provided by the seat belt

Window curtain air bags ① are not deployed in impacts which do not exceed the system's deployment threshold.

Window curtain air bags ① deploy in the area indicated by the arrows.

### BabySmart™ air bag deactivation system

Your vehicle is equipped with the BabySmart™ air bag deactivation system.

#### **Warning!**



According to accident statistics, children are safer when properly restrained in the rear seating positions than in the front seating position. Thus, we strongly recommend that children be placed in the rear seats whenever possible. Regardless of seating position, children 12 years old and under must be seated and properly secured in an appropriate infant restraint, toddler restraint, or booster seat recommended for the size and weight of the child.

The infant or child restraint must be properly secured with the vehicle's seat belt, the seat

belt and top tether strap, or lower anchors and top tether strap, fully in accordance with the child seat manufacturer's instructions.



Occupants, especially children, should always sit as upright as possible, wear the seat belt properly and use an appropriately sized infant restraint, toddler restraint, or booster seat recommended for the size and weight of the child.

Children can be killed or seriously injured by an inflating air bag. Note the following important information when circumstances require you to place a child in the front passenger seat:

- Children 12 years old and under must never ride in the front seat, except in a Mercedes-Benz authorized BabySmart™ compatible child seat, which operates with the BabySmart™ system installed in the vehicle to deactivate the front passenger front air bag when it is installed properly. Otherwise they will be struck by the air bag when it inflates in a crash. If this happens, serious or fatal injury will result.
- A child in a rear-facing child restraint on the front passenger seat will be seriously injured or even killed if the front passenger front air bag inflates in a collision which could occur under some circumstances, even with the air bag technology installed in your vehicle. The only means to completely eliminate this risk is to never place a child in a rear-facing child restraint in the front seat. We therefore strongly recommend that you always place a child in a rear-facing child restraint in a backseat.
- If you must install a BabySmart™ compatible rear-facing child restraint on the front passenger seat because circumstances require you to do so, make sure the  indicator lamp is illuminated, indicating that the front passenger front air bag is deactivated. Should the  indicator lamp not illuminate or go out while the restraint is

installed, please check installation.

Periodically check the  indicator lamp while driving to make sure the



 indicator lamp is illuminated. If the  indicator lamp goes out or remains out, do not transport a child on the front passenger seat until the system has been repaired.

A child in a rear-facing child restraint on the front passenger seat will be seriously injured or even killed if the front passenger front air bag inflates.

- If you have to place a child in a forward-facing child restraint on the front passenger seat, move the seat as far back as possible, use the proper child restraint recommended for the age, size and weight of the child, and secure child restraint with the vehicle's seat belt according to the child seat manufacturer's instructions.

#### **Warning!**

When using a BabySmart™ compatible child seat on the front passenger seat, the front passenger front air bag will not deploy only if the  indicator lamp remains illuminated.

Please be sure to check the  indicator lamp every time you use a BabySmart™ compatible child seat on the front passenger seat. Should the  indicator lamp go out while the restraint is installed, please check installation. If the  indicator lamp remains out, do not use the BabySmart™ restraint to transport a child on the front passenger seat until the system has been repaired.





Special BabySmart™ compatible child seats, designed for use with the Mercedes-Benz system, are required for use with the BabySmart™ air bag deactivation system. Please contact an authorized Mercedes-Benz Center for information on availability. With the special child seat installed properly, the front passenger front air bag will not deploy.

The  indicator lamp ① will be illuminated, except with the SmartKey removed from the starter switch or with the starter switch in position 0.

The system does not deactivate the window curtain air bag and the Emergency Tensioning Device (ETD).

### Self-test BabySmart™ without special child seat installed

After turning the SmartKey in the starter switch to position 1 or 2 the  indicator lamp comes on for approximately 6 seconds and then goes out.

If the  indicator lamp should not come on or is continuously lit, the system is not functioning. You must see an authorized Mercedes-Benz Center before seating any child on the front passenger seat. More information can be found in the “Practical hints” section (▷ page 220).

#### **Warning!**

Do not place powered-on laptops, mobile phones, electronic tags such as those used in ski passes and like electronic devices on the front passenger seat. Signals from such

devices may interfere with the BabySmart™ air bag deactivation system. Such signal interference may cause the  indicator lamp not to come on during self-test or be continuously lit, indicating that the system is not functioning.

#### **Warning!**

The BabySmart™ air bag deactivation system will ONLY work with a special child seat designed to operate with it. It will not work with child seats which are not BabySmart™ compatible.

Never place anything between seat cushion and child seat (e.g. pillow), since it reduces the effectiveness off the BabySmart™ air bag deactivation system. The bottom of the child seat must make full contact with the front passenger seat cushion. An incorrectly mounted child seat could cause injuries to the child in case of an accident, instead of protecting the child.

Follow the manufacturer’s instructions for installation of special child seats.

### Seat belts

#### Safety notes

The use of seat belts and infant and child restraint systems is required by law in all 50 states, the District of Columbia, the U.S. territories and all Canadian provinces.

Even where this is not the case, all vehicle occupants should have their seat belts fastened whenever the vehicle is in motion.

For information on infants and children traveling with you in the vehicle and restraint systems for infants and children, see “Children in the vehicle” (▷ page 44).

#### **Warning!**

Always fasten your seat belt before driving off. Always make sure all of your passengers are



properly restrained. You and your passengers should always wear seat belts.

Failure to wear and properly fasten and position your seat belt greatly increases your risk of injuries and their likely severity in an accident.

If you are ever in an accident, your injuries can be considerably more severe without your seat belt properly buckled. Without your seat belt buckled, you are much more likely to hit the interior of the vehicle or be ejected from it. You can be seriously injured or killed.

In the same crash, the possibility of injury or death is lessened if you are properly wearing your seat belt. The air bags can only protect as intended if the occupants are properly wearing their seat belts.

 **Warning!**

Never ride in a moving vehicle with the seat backrest in an excessively reclined position as this can be dangerous. You could slide under the seat belt in a collision. If you slide under it, the seat belt would apply force at the abdomen or neck. That could cause serious or even fatal injuries. The seat backrest and seat belt provide the best restraint when the wearer is in a position that is as upright as possible and the seat belt is properly positioned on the body.

 **Warning!**

Never let more people ride in the vehicle than there are seat belts available. Make sure everyone riding in the vehicle is correctly restrained with a separate seat belt. Never use a seat belt for more than one person at a time.

 **Warning!**

Damaged seat belts or seat belts that have been subjected to stress in an accident must be replaced and their anchoring points must also be checked.

Only use seat belts which have been approved by Mercedes-Benz.

Do not make any modifications to the seat belts. This can lead to unintended activation of the ETDs or to their failure to activate when necessary.

Do not bleach or dye seat belts as this may severely weaken them. In a crash they may not be able to provide adequate protection.

Have all work carried out only by qualified technicians. Contact an authorized Mercedes-Benz Center.

**Proper use of seat belts**

 **Warning!**

**USE SEAT BELTS PROPERLY**

- Seat belts can only work when used properly. Never wear seat belts in any other way than as described in this section, as that could result in serious injuries in case of an accident.
- Each occupant should wear their seat belt at all times, because seat belts help reduce the likelihood of and potential severity of injuries in accidents, including rollovers. The integrated restraint system includes SRS (driver front air bag, front passenger front air bag, window curtain air bags for door windows), Emergency Tensioning Devices (ETDs) and seat belt force limiters. The system is designed to enhance the protection offered to properly belted occupants in certain frontal (front air bags and ETDs) and side (window curtain air bags and ETDs) impacts which exceed preset deployment thresholds.
- Never wear the shoulder belt under your arm, against your neck or off your shoulder. In a frontal crash, your body would move too far forward. That would increase the chance of head and neck injuries. The seat belt would also apply too much force to the ribs or abdomen, which could severely injure internal organs such as your liver or spleen.

Adjust the seat belt so that the shoulder section is located as close as possible to the middle of the shoulder (it should not touch the neck). Never pass the shoulder portion of the seat belt under your arm. For this purpose, you can adjust the height of the seat belt outlet.

- Position the lap belt as low as possible on your hips and not across the abdomen. If the lap belt is positioned across your abdomen, it could cause serious injuries in a crash.
- Never wear seat belts over rigid or breakable objects in or on your clothing, such as eyeglasses, pens, keys etc., as these might cause injuries.
- Make sure the seat belt is always fitted snugly. Take special care of this when wearing loose clothing.
- Never use a seat belt for more than one person at a time. Do not fasten a seat belt around a person and another person or other objects at the same time.
- Seat belts should not be worn twisted. In a crash, you would not have the full width of the seat belt to distribute impact forces. The twisted seat belt against your body could cause injuries.
- Pregnant women should also always use a lap/shoulder belt. The lap belt portion should be positioned as low as possible on the hips to avoid any possible pressure on the abdomen.
- Place the seat backrest in a position that is as upright as possible.
- Check your seat belt during travel to make sure it is properly positioned.
- Never place your feet on the instrument panel, dashboard, or on the seat. Always keep both feet on the floor in front of the seat.
- When using a seat belt to secure infant restraints, toddler restraints, or children in

booster seats, always follow the child seat manufacturer's instructions.

#### **Warning!**

Do not pass seat belts over sharp edges. They could tear.

Do not allow the seat belt to get caught in the door or in the seat adjustment mechanism. This could damage the seat belt.

Never attempt to make modifications to seat belts. This could impair the effectiveness of the seat belts.

### Fastening the seat belts

#### **Warning!**

According to accident statistics, children are safer when properly restrained in the rear seating positions than in the front seating position. Thus, we strongly recommend that children be placed in the rear seats whenever possible. Regardless of seating position, children 12 years old and under must be seated and properly secured in an appropriately sized infant restraint, toddler restraint, or booster seat recommended for the size and weight of the child. For additional information, see "Children in the vehicle".

A child's risk of serious or fatal injuries is significantly increased if the child restraints are not properly secured in the vehicle and/or the child is not properly secured in the child restraint.

#### **Warning!**

Children 12 years old and under must never ride in the front seat, except in a Mercedes-Benz authorized BabySmart™ compatible child seat, which operates with the BabySmart™ system installed in the vehicle to deactivate the front passenger front air bag when it is installed properly. Otherwise they will be struck by the air bag when it inflates in a crash. If this happens, serious or fatal injury will result.

**Front seat belts and rear outer seat belts**



- ▶ With a smooth motion, pull the seat belt out of seat belt outlet ①.
  - ▶ Place the shoulder portion of the seat belt across the top of your shoulder and the lap portion across your hips.
  - ▶ Push latch plate ② into buckle ③ until it clicks.
  - ▶ If necessary, adjust the seat belt to the correct height (▷ page 42).
  - ▶ If necessary, tighten the lap portion to a snug fit by pulling shoulder portion up.
- To release the seat belt with seat belt release button ④, see (▷ page 43).

**Rear center seat belt**



Overview

- ① Attachment for latch plates
- ② Buckle for fixed latch plate
- ③ Release button for fixed latch plate
- ④ Fixed latch plate
- ⑤ Buckle for free-sliding latch plate
- ⑥ Release button for free-sliding latch plate
- ⑦ Free-sliding latch plate



- ▶ Pull both latch plates ④ and ⑦ out of attachment ①.
- The seat belt has two latch plates: Latch plate ④ is fixed at the end of the seat belt.

Latch plate ⑦ is free-sliding across the seat belt.



**i** To release buckle ② from fixed latch plate ④, press release button ③ using a suitable object, e.g. a screwdriver or a coin.

- ▶ With a smooth motion, pull the seat belt out of attachment ①.
- ▶ Push fixed latch plate ④ into buckle ② until it clicks.



- ▶ Guide the seat belt at free-sliding latch plate ⑦ across your body. Place the shoulder portion of the seat belt across the top of your shoulder and the lap portion across your hips.
- ▶ Push free-sliding latch plate ⑦ into buckle ⑤ until it clicks.
- ▶ If necessary, tighten the lap portion to a snug fit by pulling shoulder portion up.

### Seat belt outlet height adjustment

You can adjust the height of the seat belt outlet for the following seats:

- Driver's seat
- Front passenger seat
- Rear outer seats



- ▶ **Raising:** Slide the seat belt outlet height adjuster upward. The seat belt outlet height adjuster engages in different positions.
- ▶ **Lowering:** Press and hold release button ①.
- ▶ Slide the seat belt outlet height adjuster downward.
- ▶ Release button ① and make sure the seat belt outlet height adjuster engages into place.

## Releasing the seat belts

- ▶ **Releasing front seat belts and rear outer seat belts:** Press seat belt release button ④ (▷ page 41).

Allow the retractor to completely rewind the seat belt by guiding latch plate ② (▷ page 41).

- ⚠ **Make sure the seat belt retracts fully** so that the seat belt and/or latch plate cannot get caught or pinched in the door or in the seat mechanism. This can damage the seat belt and impair its effectiveness, and/or cause damage to the door and/or door trim panel. Such damage is not covered by the Mercedes-Benz Limited Warranty.

Damaged seat belts must be replaced. Contact an authorized Mercedes-Benz Center.

- ▶ **Releasing rear center seat belt:** Press release button ⑥ on buckle ⑤ for free-sliding latch plate ⑦ (▷ page 41).
- ▶ Press release button ③ on buckle ② for fixed latch plate ④ (▷ page 41).
- ▶ Allow the retractor to completely rewind the rear center seat belt by guiding fixed latch plate ④ (▷ page 41).
- ▶ Guide both latch plates ④ and ⑦ one after the other into attachment ① (▷ page 41).

### **Warning!**

To help prevent the possibility of injury, always store the rear center seat belt latch plates in the attachment when the rear center seat belt is not in use.

## Seat belt reminder system

When the engine is started, the seat belt telltale  will always illuminate to remind you and your passengers to fasten your seat belts.

If the driver's seat belt is not fastened when the engine is started, an additional warning chime will also sound for a maximum of

6 seconds or until the driver's seat belt is fastened.

The seat belt telltale  and the warning chime will go out if the driver's seat belt is fastened.

For more information, see "Practical hints" (▷ page 216).

## Emergency Tensioning Device (ETD), seat belt force limiter

The seat belts for the front seats and rear outer seats are equipped with ETDs and seat belt force limiters.

The ETDs are designed to activate in the following cases:

- in frontal or rear-end impacts exceeding the system's preset deployment threshold
- if the restraint systems are operational and functioning correctly, see "SRS indicator lamp" (▷ page 32)

The ETDs for the front seats will only activate if the front seat belts are fastened (latch plate properly inserted into buckle).

The ETDs for the rear outer seats will activate with or without the respective seat belts fastened.

In an impact, the ETDs remove slack from the seat belts in such a way that the seat belts fit more snugly against the body. Seat belt force limiters, when activated, are employed to help reduce the peak force exerted by the seat belts on occupants during a crash.

- ⓘ The ETDs do not correct an incorrect seat position or incorrectly worn seat belts.

The ETDs do not pull occupants back toward the seat backrest.

### **Warning!**

Pyrotechnic ETDs that were activated must be replaced.

For your safety, when disposing of the pyrotechnic ETDs always follow our safety

instructions. These are available at any authorized Mercedes-Benz Center.

### Correct driver seat adjustment

#### Warning!

In order to avoid possible loss of vehicle control, all seat, head restraint, steering wheel, and rear view mirror adjustments, as well as fastening of seat belts, must be done before the vehicle is put into motion.

### Steering wheel

#### Observe Safety notes, see page 67.

- Position the steering wheel properly (▷ page 68).

Make sure:

- You can reach the steering wheel with your arms slightly bent at the elbows.
- You can move your legs freely.
- All displays (including malfunction and indicator lamps) on the instrument cluster are clearly visible.

### Seat belt

#### Observe Safety notes, see page 38.

- Fasten and position your seat belt correctly (▷ page 40).

Make sure:

- The seat belt is always fitted snugly.
- Adjust the seat belt so that the shoulder section is located as close as possible to the middle of the shoulder.
- Place the lap portion of the seat belt as low as possible on your hips.

### Seat and head restraint

#### Observe Safety notes, see page 62.

- Position the seat and head restraint properly. See (▷ page 63) for seat and head restraint adjustment.

Observe the following points:

- Always be in a properly seated position.
- The position should be as far rearward from the front air bag in the steering wheel as possible, while still permitting proper operation of vehicle controls.
- Adjust the seat to a comfortable seating position that still allows you to reach the accelerator/brake pedal safely.
- The seat must be adjusted so that you can correctly fasten and position your seat belt.
- The seat backrest must be in a position that is as nearly upright as possible.
- Adjust the seat cushion so that the front edge of the seat cushion lightly supports your legs.
- Adjust the head restraint so that it is as close to the head as possible and the center of the head restraint supports the back of the head at eye level.
- Never place hands under the seat or near any moving parts while the seat is being adjusted.

### Children in the vehicle

#### Safety notes

If an infant or child is traveling with you in the vehicle:

- Secure the child using an infant or child restraint appropriate to the age and size of the child.
- Make sure the infant or child is properly secured at all times while the vehicle is in motion.

 **Warning!**

When leaving the vehicle, always remove the SmartKey from the starter switch. Always take the SmartKey with you and lock the vehicle. Do not leave children unattended in the vehicle, even if they are secured in a child restraint system, or with access to an unlocked vehicle. A child's unsupervised access to a vehicle could result in an accident and/or serious personal injury. The children could

- injure themselves on parts of the vehicle
- be seriously or fatally injured through excessive exposure to extreme heat or cold
- injure themselves or cause an accident with vehicle equipment that can be operated even if the SmartKey is removed from the starter switch or removed from the vehicle, such as seat adjustment, steering wheel adjustment, or the memory function.

If children open a door, they could injure other persons or get out of the vehicle and injure themselves or be injured by following traffic.

Do not expose the child restraint system to direct sunlight. The child restraint system's metal parts, for example, could become very hot, and the child could be burned on these parts.

 **Warning!**

Do not carry heavy or hard objects in the passenger or cargo compartment unless they are firmly secured in place.

Unsecured or improperly positioned cargo increases a child's risk of injury in the event of

- strong braking maneuvers
- sudden changes of direction
- an accident

For more information on loading, see (▷ page 126).

**Infant and child restraint systems** **Observe Safety notes, see page 44.**

We recommend all infants and children be properly restrained at all times while the vehicle is in motion.

Only use a BabySmart™ compatible child restraint for the front passenger seat in this vehicle.

All lap/shoulder belts except the driver's seat belt have special seat belt retractors for secure fastening of child restraints.

To fasten a child restraint, follow child restraint instructions for mounting. Then pull the shoulder belt out completely and let it retract. During seat belt retraction, a ratcheting sound can be heard to indicate that the special seat belt retractor is activated. The seat belt is now locked. Push down on child restraint to take up any slack. To deactivate, release the seat belt buckle and let the seat belt retract completely. The seat belt can then again be used in the usual manner.

 **Warning!**

Never release the seat belt buckle while the vehicle is in motion, since the special seat belt retractor will be deactivated.

- i** Information on child seats with mounting fittings for tether anchorages (▷ page 47).

For information on LATCH-type child seat anchors (▷ page 48).

The use of infant or child restraints is required by law in all 50 states, the District of Columbia, the U.S. territories and all Canadian provinces.

Infants and small children should be seated in an appropriate infant or child restraint system, properly secured in accordance with the manufacturer's instructions for the child restraint, that complies with U.S. Federal Motor Vehicle Safety Standards 213 and 225

and Canadian Motor Vehicle Safety Standards 213 and 210.2.

A statement by the child restraint manufacturer of compliance with these standards can be found on the instruction label on the restraint and in the instruction manual provided with the restraint.

When using any infant restraint, toddler restraint, or booster seat, make sure to carefully read and follow all manufacturer's instructions for installation and use.

Please read and observe warning labels affixed to the inside of the vehicle and to infant or child restraints.

#### **Warning!**

According to accident statistics, children are safer when properly restrained in the rear seating positions than in the front seating position. Thus, we strongly recommend that children be placed in the rear seats whenever possible. Regardless of seating position, children 12 years old and under must be seated and properly secured in an appropriate infant restraint, toddler restraint, or booster seat recommended for the size and weight of the child.





The infant or child restraint must be properly secured with the vehicle's seat belt, the seat belt and top tether strap, or lower anchors and top tether strap, fully in accordance with the child seat manufacturer's instructions.

Occupants, especially children, should always sit as upright as possible, wear the seat belt properly and use an appropriately sized infant restraint, toddler restraint, or booster seat recommended for the size and weight of the child.

Children can be killed or seriously injured by an inflating air bag. Note the following important information when circumstances require you to place a child in the front passenger seat:

- Children 12 years old and under must never ride in the front seat, except in a Mercedes-

Benz authorized BabySmart™ compatible child seat, which operates with the BabySmart™ system installed in the vehicle to deactivate the front passenger front air bag when it is installed properly. Otherwise they will be struck by the air bag when it inflates in a crash. If this happens, serious or fatal injury will result.

- A child in a rear-facing child restraint on the front passenger seat will be seriously injured or even killed if the front passenger front air bag inflates in a collision which could occur under some circumstances, even with the air bag technology installed in your vehicle. The only means to completely eliminate this risk is to never place a child in a rear-facing child restraint in the front seat. We therefore strongly recommend that you always place a child in a rear-facing child restraint in a backseat.
  - If you must install a rear-facing child restraint on the front passenger seat because circumstances require you to do so, make sure the  indicator lamp is illuminated, indicating that the front passenger front air bag is deactivated. Should the  indicator lamp not illuminate or go out while the restraint is installed, please check installation. Periodically check the  indicator lamp while driving to make sure the  indicator lamp is illuminated. If the  indicator lamp goes out or remains out, do not transport a child on the front passenger seat until the system has been repaired.
- A child in a rear-facing child restraint on the front passenger seat will be seriously injured or even killed if the front passenger front air bag inflates.
- If you have to place a child in a forward-facing child restraint on the front passenger seat, move the seat as far back as possible, use the proper child restraint recommended for the age, size and weight



of the child, and secure child restraint with the vehicle's seat belt according to the child seat manufacturer's instructions.

### **Warning!**

Infants and small children should never share a seat belt with another occupant. During an accident, they could be crushed between the occupant and seat belt.

A child's risk of serious or fatal injuries is significantly increased if the child restraints are not properly secured in the vehicle and/or the child is not properly secured in the child restraint.

Children too big for a toddler restraint must ride in seats using regular seat belts. Position shoulder belt across chest and shoulder, not face or neck. A booster seat may be necessary to achieve proper seat belt positioning for children over 41 lb (18 kg) until they reach a height where a lap/shoulder belt fits properly without a booster.

When the child restraint is not in use, remove it from the vehicle or secure it with the seat belt to prevent the child restraint from becoming a projectile in the event of an accident.

## Installation of infant and child restraint systems

 **Observe Safety notes, see page 44.**

### **Warning!**

Always lock the seat backrests in their upright position when the rear seats are occupied by passengers, before installing top tether straps, or the extended cargo compartment is not in use. Make sure that seat backrests are secured properly by pushing and pulling on the seat backrests. If a seat backrest is not locked properly, the seat backrest could fold. The child seat would no longer be supported properly or positioned to provide its intended benefit. That could cause serious or even fatal injuries.

This vehicle is equipped with tether anchorages for a top tether strap at each of the rear seating positions. The anchorage rings are located on the floor behind each rear seat.

Top tether straps enable an additional connection to be made between child restraint systems secured with LATCH-type anchors and rear seats. This can further reduce the risk of injury.

- ▶ Remove the cargo compartment cover blind, if installed (> page 129).
- ▶ Guide the top tether strap between head restraint and top of the seat backrest.

The head restraint must be installed and positioned such that the top tether strap can pass freely between the head restraint and top of the seat backrest.

- ▶ Make sure the top tether strap is not twisted.

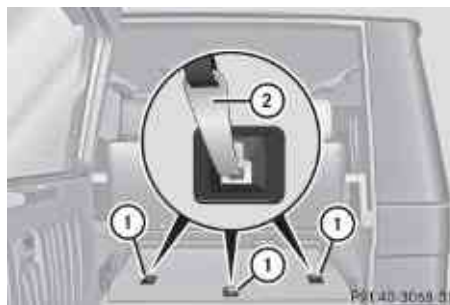

- ▶ Fold up anchorage ring ①.
- ▶ Securely fasten hook ②, which is part of top tether strap, to anchorage ring ①.

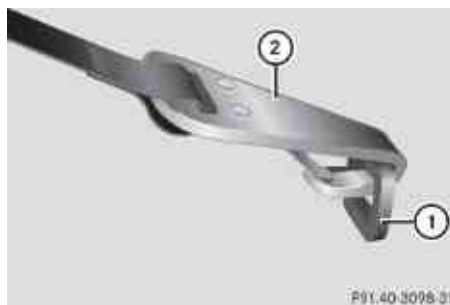

- For safety, make sure hook ② is attached to anchorage ring ① beyond the safety catch, as illustrated.

Once hook ② is attached, the child restraint itself can be secured.

- Install the child restraint system and tighten the top tether strap according to the child restraint manufacturer's instructions.

#### **Warning!**

Only use the described top tether anchorage rings for the respective child seat. Other lashing eyelets could tear in case of an accident. Make sure the top tether straps are not crossed or twisted and the hook is attached and closed properly.

### Child seat anchors – LATCH-type

#### **Observe Safety notes, see page 44.**

#### **Warning!**

Children too big for a toddler restraint must ride in seats using regular seat belts. Position shoulder belt across chest and shoulder, not face or neck.

A booster seat may be necessary to achieve proper seat belt positioning for children over 41 lb (18 kg) until they reach a height where a lap/shoulder belt fits properly without a booster.

Install child seat according to manufacturer's instructions.

The child seat must be firmly attached to the right and left side anchors.

An incorrectly mounted child seat may come loose during an accident which could result in serious injury or death to the child.

Damaged or impact damaged child seats or child seat mounting fittings must be replaced.

This vehicle is equipped with two LATCH-type anchors (at each of the rear outer seats) for the installation of a LATCH-type child seat with matching mounting fittings.

Non-LATCH-type child seats may also be used and can be installed using the vehicle's seat belt system. Install child seat according to the manufacturer's instructions.



LATCH-type anchors ① are located between the seat cushion and the backrest.

- Install a LATCH-type child seat according to the manufacturer's instructions. A rigid connection between the child seat and the body of the vehicle is established.
- Make sure the seat belt for the rear center seat can operate freely with a child seat installed.

### Child safety

#### Child safety locks

#### **Observe Safety notes, see page 44.**

#### **Warning!**

Children could open a rear door from the inside. This may cause serious personal injury or an accident. Therefore, secure the rear doors with the child safety locks whenever children are riding in the back seats of the vehicle.

The child safety locks on the rear doors enable you to secure each rear door individually. You cannot open a secured rear door from the inside. You can open the rear door from the outside when the vehicle is unlocked.



- ▶ **Securing:** Press the lever up in direction of arrow ①.
- ▶ Check to make sure the child safety locks are working properly.
- ▶ **Releasing:** Press the lever down in direction of arrow ②.

#### Override switch

 **Observe Safety notes, see page 44.**

With the override switch you can disable the rear door window switches in the rear door panels.

 **Warning!**

Activate the override switch when children are riding in the back seats of the vehicle. The children may otherwise injure themselves, e.g. by becoming trapped in the rear door window opening.



- ▶ **Activating:** Slide override switch ① to the right.  
Symbol ● becomes visible.

The rear door windows can no longer be operated using the respective switch located in the rear doors.

It is still possible to operate the rear door windows using the switches located on the door control panel of the driver's door.

- ▶ **Deactivating:** Slide override switch ① to the left.

The rear door windows can again be operated using the respective switch located in the rear doors.

For more information on power windows, see the "Controls in detail" section (▶ page 81).

#### Panic alarm

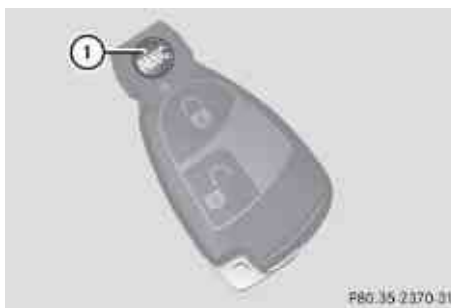

- ▶ **Activating:** Press and hold **PANIC** button ① for at least 1 second.  
An audible alarm and flashing turn signal lamps will operate briefly.
  - ▶ **Deactivating:** Press **PANIC** button ① again.
- or
- ▶ Insert the SmartKey in the starter switch.

 **USA only:**

This device complies with Part 15 of the FCC Rules. Operation is subject to the following two conditions:

1. This device may not cause harmful interference, and
2. this device must accept any interference received, including

interference that may cause undesired operation.

Any unauthorized modification to this device could void the user's authority to operate the equipment.

**i** Canada only:

This device complies with RSS-210 of Industry Canada. Operation is subject to the following two conditions:

1. This device may not cause interference, and
2. this device must accept any interference received, including interference that may cause undesired operation of the device.

Any unauthorized modification to this device could void the user's authority to operate the equipment.

## Driving safety systems

### Introduction

This section contains information about the following driving safety systems:

- ABS (Antilock Brake System)
- BAS (Brake Assist System)
- EBB (Electronic Brake Booster)
- ESP® (Electronic Stability Program)

- i** In winter operation, the maximum effectiveness of most of the driving systems described in this section is only achieved with winter tires, or snow chains as required.

## Safety notes

### Warning!

The following factors increase the risk of accidents:

- Excessive speed, especially in turns
- Wet and slippery road surfaces
- Following another vehicle too closely

The driving safety systems described in this section cannot reduce these risks or prevent the natural laws of physics from acting on the vehicle. They cannot increase braking or steering efficiency beyond that afforded by the condition of the vehicle brakes and tires or the traction afforded.

Only a safe, attentive, and skillful driver can prevent accidents.

The capabilities of a vehicle equipped with the driving safety systems described in this section must never be exploited in a reckless or dangerous manner which could jeopardize the user's safety or the safety of others.

Always adjust your driving style to the prevailing road and weather conditions and keep a safe distance to other road users and objects on the street.

If a driving system malfunctions, other driving safety systems may also switch off. Observe indicator and warning lamps that may come on as well as messages in the multifunction display that may appear.

### Warning!

The ABS, the BAS, and the ESP® switch off when the differential locks are switched on. When the ABS, the BAS, and the ESP® are switched off

- wheels may lock during hard braking
- steering capabilities are reduced
- braking distance is increased
- vehicle stability in standard driving maneuvers is increased

Make sure the differential locks are switched on at all times except when driving off-road for example. Switch on the differential locks immediately when returning from off-road driving.

## ABS

 **Observe Safety notes, see page 50.**

### **Warning!**

Do not pump the brake pedal. Use firm, steady brake pedal pressure instead. Pumping the brake pedal defeats the purpose of the ABS and significantly reduces braking effectiveness.

The Antilock Brake System (ABS) regulates the brake pressure so that the wheels do not lock during braking. This allows you to maintain the ability to steer your vehicle.

The ABS is functional above a speed of approximately 5 mph (8 km/h) independent of road surface conditions, provided the differential locks are not engaged.

On slippery road surfaces, the ABS will respond even to light brake pressure.

The  indicator lamp in the instrument cluster comes on when you switch on the ignition. It goes out when the engine is running.

## Braking

At the instant one of the wheels is about to lock up, a slight pulsation can be felt in the brake pedal, indicating that the ABS is in the regulating mode.

- Keep firm and steady pressure on the brake pedal while you feel the pulsation.

Continuous, steady brake pedal pressure yields the advantages provided by the ABS, namely braking power and the ability to steer the vehicle.

The pulsating brake pedal can be an indication of hazardous road conditions and

functions as a reminder to take extra care while driving.

## Emergency brake maneuver

- Keep continuous full pressure on the brake pedal.

### **Warning!**

If the ABS malfunctions, other driving safety systems such as the BAS or the ESP® are also switched off. Observe indicator and warning lamps that may come on as well as messages in the multifunction display that may appear.

If the ABS malfunctions, the wheels may lock during hard braking, reducing steering capability and extending the braking distance.

## LOW-RANGE ABS

During off-road driving, a special low-range system for the ABS is operational with the transfer case in position LOW (► page 91).

An improved braking action (dig-in effect) is obtained for vehicles speeds of up to 37 mph (60 km/h) through a change in the ABS control function.

## BAS

 **Observe Safety notes, see page 50.**

The Brake Assist System (BAS) operates in emergency situations. If you apply the brakes very quickly, the BAS automatically provides full brake boost, thereby potentially reducing the braking distance.

- Apply continuous full braking pressure until the emergency braking situation is over. The ABS will prevent the wheels from locking.

When you release the brake pedal, the brakes function again as normal. The BAS is then deactivated.

### **Warning!**

If the BAS malfunctions, the brake system still functions, but without the additional brake

boost available that the BAS would normally provide in an emergency braking maneuver. Therefore, the braking distance may increase.

### EBB

 **Observe Safety notes, see page 50.**

The Electronic Brake Booster (EBB) enhances braking effectiveness by allowing the rear brakes to supply a greater proportion of the braking effort in straight-line braking without a loss of vehicle stability.

### Warning!

If the EBB malfunctions, the brake system is still functioning. However, the rear wheels may lock up during hard braking. You may lose control over the vehicle and possibly cause an accident. Adjust your driving style to the non-operating status of the EBB.

### ESP®

 **Observe Safety notes, see page 50.**

The Electronic Stability Program (ESP®) is operational as soon as the engine is running and monitors the vehicle's traction (force of adhesive friction between the tires and the road surface) and handling.

The ESP® recognizes when a wheel is spinning or if the vehicle starts to skid. By applying brakes to individual wheels and by limiting the engine output, the ESP® works to stabilize the vehicle. The ESP® is especially useful while driving off and on wet or slippery road surfaces. The ESP® also stabilizes the vehicle during braking and steering maneuvers.

The ESP® warning lamp  in the instrument cluster comes on when you switch on the ignition. It goes out when the engine is running.

The ESP® warning lamp  in the instrument cluster flashes when the ESP® is engaged.

### Warning!

Never switch off the ESP® when you see the ESP® warning lamp  flashing in the instrument cluster. In this case proceed as follows:

- When driving off, apply as little throttle as possible.
- While driving, ease up on the accelerator pedal.
- Adapt your speed and driving style to the prevailing road conditions.

Failure to observe these guidelines could cause the vehicle to skid. The ESP® cannot prevent accidents resulting from excessive speed.

 Only conduct operational or performance tests on a two-axle dynamometer. If such tests are necessary, contact an authorized Mercedes-Benz Center. You could otherwise seriously damage the brake system or the transfer case which is not covered by the Mercedes-Benz Limited Warranty.

 Because the ESP® operates automatically, the engine and ignition must be shut off (SmartKey in starter switch position **0** or **1**) when the parking brake is being tested on a brake test dynamometer. Such testing should be no longer than 10 seconds.

Active braking action through the ESP® may otherwise seriously damage the brake system which is not covered by the Mercedes-Benz Limited Warranty.

 The ESP® will only function properly if you use wheels of the recommended tire size as specified in the "Technical data" section of this Operator's Manual.

## Electronic Traction System (4-ETS)

### **Observe Safety notes, see page 50.**

The 4-ETS (four-wheel Electronic Traction System) is a component of the ESP®. The 4-ETS improves the vehicle's ability to utilize available traction, especially under slippery road conditions by applying the brakes to a spinning wheel. In addition, more power is transferred to the wheel(s) with traction.

The 4-ETS function is available between vehicle speeds of 0 mph (km/h) and 37 mph (60 km/h).

When you switch off the ESP®, the 4-ETS is still enabled.

## Switching off the ESP®

### **Warning!**

The ESP® should not be switched off during normal driving other than in the circumstances described below. Disabling the system will reduce vehicle stability in driving maneuvers.

To improve the vehicle's traction, switch off the ESP® in driving situations in which it would be advantageous to have the drive wheels spin and thus cut into surfaces for better grip such as:

- when driving with snow chains
- in deep snow
- in sand or gravel
- when driving off-road

### **Warning!**

Switch on the ESP® immediately if the aforementioned circumstances do not apply anymore. Otherwise the ESP® will not stabilize the vehicle when it is starting to skid or a wheel is spinning.

When you switch off the ESP®,

- the ESP® does not stabilize the vehicle
- the engine output is not limited, which allows the drive wheels to spin and thus cut into surfaces for better grip
- the ESP® continues to operate when you are braking
- the 4-ETS will still apply the brakes to a spinning wheel at vehicle speeds up to approximately 37 mph (60 km/h)
- the cruise control cannot be activated
- the cruise control switches off if activated

**i** When the ESP® is switched off and one or more drive wheels are spinning, the ESP® warning lamp  in the instrument cluster flashes. However, the ESP® will then not stabilize the vehicle.

**i** When the ESP® is switched off, it will be switched on again automatically when exceeding a vehicle speed of 37 mph (60 km/h) or exceeding a severity threshold of side acceleration.



- ▶ With the engine running, press ESP switch **1** until the ESP® warning lamp  in the instrument cluster comes on. The ESP® is switched off.

### **Warning!**

When the ESP® warning lamp  is illuminated continuously, the ESP® is

switched off or is not operational due to a malfunction. Vehicle stability in standard driving maneuvers is reduced.

Adapt your speed and driving to the prevailing road conditions and to the non-operating status of the ESP®.

- ❗ Avoid spinning of a drive wheel for an extended period with the ESP® switched off. This may cause serious damage to the drivetrain which is not covered by the Mercedes-Benz Limited Warranty.

### Switching on the ESP®

- ▶ Press ESP® switch ① until the ESP® warning lamp  in the instrument cluster goes out.  
You are now again in normal driving mode with the ESP® switched on.

## Anti-theft systems

### Immobilizer

The immobilizer prevents unauthorized persons from starting your vehicle.

When leaving the vehicle, always take the SmartKey with you and lock the vehicle. The engine can be started by anyone with a valid SmartKey that is left inside the vehicle.

### Activating

- ▶ Remove the SmartKey from the starter switch.

### Deactivating

- ▶ Switch on the ignition.
- ❗ Starting the engine will also deactivate the immobilizer.  
In the event that the engine cannot be started (yet the vehicle's battery is charged), the system is not operational. Contact an authorized Mercedes-Benz

Center or call 1-800-FOR-MERCEdes (in the USA), or 1-800-387-0100 (in Canada).

### Anti-theft alarm system

Once the alarm system has been armed, a visual and audible alarm is triggered when someone opens

- a door
- the tailgate
- the hood

The alarm will stay on even if the activating element (a door, for example) is immediately closed.

The alarm system will also be triggered when

- the vehicle is opened with the mechanical key
- a door is opened from the inside
- the tailgate is opened from the inside

To cancel the alarm after it has been triggered, see "Canceling the alarm" (> page 55).



- ▶ **Arming:** Lock the vehicle with the SmartKey.  
The turn signal lamps flash three times to indicate that the vehicle is locked. Indicator lamp ① flashes to indicate that the alarm system is armed.
- ❗ If the turn signal lamps do not flash three times, a door or the tailgate may not be properly closed.



Close the respective element.

- ▶ **Disarming:** Unlock the vehicle with the SmartKey.  
The turn signal lamps flash once to indicate that the alarm system is disarmed.

**i** The vehicle will lock and the alarm system will rearm automatically again after approximately 40 seconds unless you open a door or the tailgate.

### Tow-away alarm

Once the tow-away alarm is armed, a visual and audible alarm will be triggered when someone attempts to raise the vehicle.

To cancel the alarm after it has been triggered, see “Canceling the alarm” (▷ page 55).

- ▶ **Arming:** Lock the vehicle with the SmartKey.  
The tow-away alarm is armed after about 30 seconds automatically.
- ▶ **Disarming:** Unlock the vehicle with the SmartKey.  
The tow-away alarm remains disarmed until you lock the vehicle again.

### Disabling tow-away alarm

To prevent triggering the tow-away alarm, disable the tow-away alarm feature before towing the vehicle, or when parking on a surface subject to movement, such as a ferry or auto train.





- ▶ Remove the SmartKey from the starter switch.
- ▶ Press tow-away alarm switch ①.  
Indicator lamp ② comes on briefly.
- ▶ Exit and lock the vehicle.

The tow-away alarm remains disabled until you lock the vehicle again.

### Canceling the alarm

To cancel the alarm, do one of the following:

- ▶ Insert the SmartKey in the starter switch.
- ▶ Press button  or  on the SmartKey.



<b>Vehicle equipment</b> .....	58
<b>Locking and unlocking</b> .....	58
<b>Starter switch positions</b> .....	62
<b>Seats</b> .....	62
<b>Multifunction steering wheel</b> .....	67
<b>Mirrors</b> .....	69
<b>Memory function</b> .....	70
<b>Lighting</b> .....	72
<b>Wipers</b> .....	79
<b>Power windows</b> .....	81
<b>Driving and parking</b> .....	82
<b>Automatic transmission</b> .....	87
<b>Transfer case</b> .....	91
<b>Differential locks</b> .....	93
<b>Instrument cluster</b> .....	95
<b>Control system</b> .....	97
<b>Driving systems</b> .....	112
<b>Climate control system</b> .....	119
<b>Front windshield defroster</b> .....	124
<b>Rear window defroster</b> .....	125
<b>Power tilt/sliding sunroof</b> .....	125
<b>Loading and storing</b> .....	126
<b>Useful features</b> .....	131



### Vehicle equipment

**i** This Operator's Manual describes all features, standard or optional, potentially available for your vehicle at the time of purchase. Please be aware that your vehicle might not be equipped with all features described in this manual.

### Locking and unlocking

#### Notes

**⚠** Observe Safety notes, see page 44.

When unlocking the vehicle, all turn signal lamps flash once. The locking knobs in the doors move up. The anti-theft alarm system is disarmed.

When locking the vehicle, all turn signal lamps flash three times. The locking knobs in the doors move down. The anti-theft alarm system is armed.

All doors, the hood and the tailgate must be closed.

**!** If you cannot lock or unlock the vehicle with the SmartKey, the batteries in the SmartKey are discharged, the SmartKey is malfunctioning, or the vehicle battery is drained.

- Check the batteries in the SmartKey and replace them if necessary.
- Use the mechanical key to unlock the driver's door and the tailgate.
- Use the mechanical key to lock the vehicle.
- Have the vehicle battery and the vehicle battery connections checked at an authorized Mercedes-Benz Center.

If the SmartKey is malfunctioning, contact Roadside Assistance or an authorized Mercedes-Benz Center.



### SmartKey

Your vehicle comes supplied with two SmartKeys, each with remote control and a removable mechanical key.

The SmartKey centrally locks and unlocks:

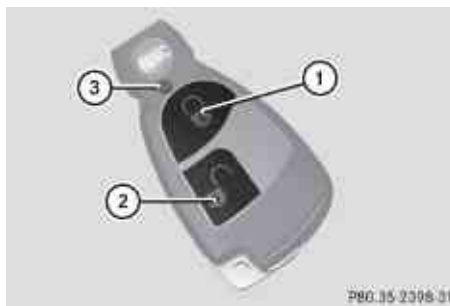
- the doors
- the tailgate
- the fuel filler flap



- ①  Lock button
- ②  Unlock button
- ③  Battery check lamp

**i** USA only:

This device complies with Part 15 of the FCC Rules. Operation is subject to the following two conditions:

1. This device may not cause harmful interference, and
2. this device must accept any interference received, including interference that may cause undesired operation.

Any unauthorized modification to this device could void the user's authority to operate the equipment.

**i** Canada only:

This device complies with RSS-210 of Industry Canada. Operation is subject to the following two conditions:

1. This device may not cause interference, and
2. this device must accept any interference received, including interference that may cause undesired operation of the device.

Any unauthorized modification to this device could void the user's authority to operate the equipment.



**Factory setting**

- ▶ **Global unlocking:** Press button . The vehicle will lock again automatically and rearm the anti-theft alarm system within approximately 40 seconds of unlocking if neither door nor tailgate is opened.



- ▶ **Global locking:** Press button .

**Selective setting**

If you frequently travel alone, you may wish to reprogram the SmartKey. Pressing button  will then only unlock the driver's door and the fuel filler flap.

- ▶ **Switching on/off:** Press and hold buttons  and  simultaneously for approximately 6 seconds until battery check lamp ③ (▷ page 58) flashes twice.

The SmartKey will then function as follows:

- ▶ **Unlocking driver's door and fuel filler flap:** Press button  once.
- ▶ **Global unlocking:** Press button  twice.
- ▶ **Global locking:** Press button .

**Checking SmartKey batteries**



- ▶ Press button  or  on the SmartKey.

Battery check lamp ③ (▷ page 58) comes on briefly to indicate that the SmartKey batteries are in order.

If the battery check lamp does not come on briefly during check, the SmartKey batteries are discharged.

- ▶ Replace the batteries (▷ page 225).

**i** You can obtain the required batteries at any authorized Mercedes-Benz Center.

**i** If the batteries are checked within signal range of the vehicle, pressing button  or  will lock or unlock the vehicle accordingly.

**Loss of the SmartKey**

If you lose your SmartKey or mechanical key, you should do the following:

- ▶ Have the SmartKey deactivated by an authorized Mercedes-Benz Center.
- ▶ Report the loss of the SmartKey or the mechanical key to your car insurance company immediately.
- ▶ Have the mechanical lock replaced if necessary.

Any authorized Mercedes-Benz Center will be glad to supply you with a replacement.

**Opening the doors from the inside**

You can open a locked door from the inside. Open door only when conditions are safe to do so.

## 60 Locking and unlocking

## Controls in detail



Example illustration driver's door

If the vehicle has previously been locked with the SmartKey, opening a door or the tailgate from the inside will trigger the anti-theft alarm system.

To cancel the alarm, see (▷ page 55).

- ▶ **Front doors:** Pull on inside door handle (2) on the respective front door. If the door was locked, locking knob (1) will move up.
- ▶ **Rear doors:** Pull up locking knob on the respective rear door to unlock door.
- ▶ Pull on the inside door handle on the respective rear door.

### Automatic central locking

The doors and the tailgate lock automatically when the vehicle is set into motion.

You can open a locked door from the inside. Open door only when conditions are safe to do so.

The doors and the tailgate are designed to unlock automatically after an accident if the force of the impact exceeds a preset threshold.

The vehicle locks automatically when the ignition is switched on and the wheels are turning at vehicle speeds of above 9 mph (15 km/h). You could therefore lock yourself out when the vehicle is pushed or towed or is on a test stand.

You can deactivate the automatic central locking using the control system (▷ page 108).

### Locking and unlocking from the inside

 **Observe Safety notes, see page 44.**

You can lock or unlock the vehicle from inside using the central locking switches. This can be useful, for example, if you want to lock the vehicle before starting to drive.

The central locking switches do not lock or unlock the fuel filler flap.



- ▶ **Locking:** Press central locking switch (2). When all doors and the tailgate are closed, the vehicle locks.
- ▶ **Unlocking:** Press central unlocking switch (1).

You can open a locked door from inside at any time. Open door only when conditions are safe to do so.

If the vehicle was previously locked with the central locking switch

- and the SmartKey is set to factory settings, the complete vehicle is unlocked when a front door is opened from the inside
- and the SmartKey is set to selective settings, only the front door opened from the inside is unlocked

If the vehicle was previously locked centrally with the SmartKey, it will not unlock using the central unlocking switch.

## Tailgate

### **Warning!**

Make sure the tailgate is closed when the engine is running and while driving. Among other dangers, deadly carbon monoxide (CO) gases may enter vehicle interior resulting in unconsciousness and death.

### **Warning!**

The tailgate swings open to one side. Always make sure there is sufficient clearance for the tailgate.

Make sure the tailgate is closed when the engine is running and while driving. Among other dangers, deadly carbon monoxide (CO) gases may enter vehicle interior resulting in unconsciousness and death.

## Opening the tailgate from the outside

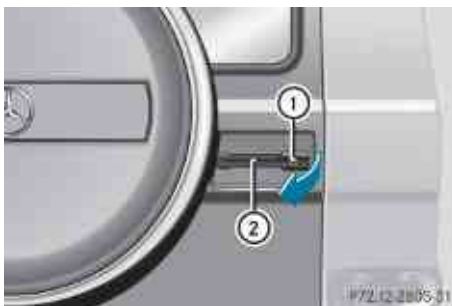

- ▶ Unlock the vehicle (▷ page 58).
- ▶ Press lock cylinder ① and pull on handle ②.
- ▶ Open the tailgate to the side.

## Closing the tailgate from the outside

### **Observe Safety notes, see page 44.**

### **Warning!**

To prevent possible personal injury, always keep hands and fingers away from the cargo compartment opening when closing the tailgate. Be especially careful when small children are around.

To prevent an inadvertent lockout, do not place the SmartKey in the cargo compartment.

## Opening the tailgate from the inside



- ▶ Pull on inside door handle ②.

### **If the door was locked:**

- ▶ Pull up locking knob ①.
- ▶ Pull on inside door handle ②.

## Separately locking and unlocking the tailgate

To deny any unauthorized person access to the tailgate, lock it separately with the mechanical key.



- ▶ **Locking:** Close the tailgate.
- ▶ Remove the mechanical key from the SmartKey (▷ page 221).

- ▶ Insert the mechanical key in the lock cylinder.
- ▶ Turn the mechanical key clockwise to position **2** and remove the mechanical key in that position to lock the tailgate.

The tailgate remains locked even when the vehicle is centrally unlocked.

You can only cancel the separate tailgate locking mode by means of the mechanical key.

- ▶ **Unlocking:** Remove the mechanical key from the SmartKey (▷ page 221).
- ▶ Insert the mechanical key in the lock cylinder.
- ▶ Turn the mechanical key counterclockwise to neutral position **1** and remove the mechanical key in that position to unlock the tailgate.  
You can now open the tailgate.

### Controls in detail

#### Starter switch positions

##### SmartKey

⚠ **Observe Safety notes, see page 44.**



Starter switch

- 0** For removing SmartKey (gear selector lever must be in park position **P**)
- 1** Power supply for some electrical consumers, e.g. radio
- 2** Ignition (power supply for all electrical consumers) and driving position
- 3** Starting position

When you switch on the ignition, all lamps (except low-beam headlamp indicator lamp, high-beam headlamp indicator lamp, and turn signal indicator lamps unless activated) in the instrument cluster come on. If a lamp in the instrument cluster fails to come on when the ignition is switched on, have it checked and replaced if necessary. If a lamp in the instrument cluster remains on after starting the engine or comes on while driving, refer to “Lamps in instrument cluster” (▷ page 213).

If the SmartKey is left in starter switch position **0** for an extended period of time, it can no longer be turned in the starter switch. In this case, the steering is locked. To unlock, remove SmartKey from the starter switch and reinsert.

The steering is locked when the SmartKey is removed from the starter switch.

⚠ If the SmartKey cannot be turned in the starter switch, the vehicle battery may not be sufficiently charged.

- Check the vehicle battery and charge it if necessary.
- Get a jump start.

Always remove the SmartKey from the starter switch when the engine is not in operation. This will help to prevent accelerated vehicle battery discharge or a completely discharged vehicle battery.

#### Seats

##### Safety notes

##### ⚠ **Warning!**

In order to avoid possible loss of vehicle control, all seat, head restraint, steering wheel, and rear view mirror adjustments, as well as fastening of seat belts, must be done before the vehicle is put into motion.



 **Warning!**

Do not adjust the driver's seat while driving. Adjusting the seat while driving could cause the driver to lose control of the vehicle.

Never ride in a moving vehicle with the seat backrest in an excessively reclined position as this can be dangerous. You could slide under the seat belt in a collision. If you slide under it, the seat belt would apply force at the abdomen or neck. That could cause serious or fatal injuries. The seat backrest and seat belts provide the best restraint when the wearer is in a position that is as upright as possible and seat belts are properly positioned on the body.

 **Warning!**

Your seat must be adjusted so that you can correctly fasten your seat belt.

Observe the following points:

- Adjust the seat backrest until your arms are slightly angled when holding the steering wheel.
- Adjust the seat to a comfortable seating position that still allows you to reach the accelerator/brake pedal safely. The position should be as far back as possible with the driver still able to operate the controls properly.
- Adjust the head restraint so that it is as close to the head as possible and the center of the head restraint supports the back of the head at eye level.
- Never place hands under the seat or near any moving parts while a seat is being adjusted.

Failure to do so could result in an accident and/or serious personal injury.

 **Warning!**

According to accident statistics, children are safer when properly restrained in the rear seating positions than in the front seating position. Thus, we strongly recommend that

children be placed in the rear seats whenever possible. Regardless of seating position, children 12 years old and under must be seated and properly secured in an appropriately sized infant restraint, toddler restraint, or booster seat recommended for the size and weight of the child. For additional information, see "Children in the vehicle".

A child's risk of serious or fatal injuries is significantly increased if the child restraints are not properly secured in the vehicle and/or the child is not properly secured in the child restraint.

 **Warning!**

For your protection, drive only with properly positioned head restraints.

Adjust the head restraint so that it is as close to the head as possible and the center of the head restraint supports the back of the head at eye level. This will reduce the potential for injury to the head and neck in the event of an accident or similar situation.

Do not drive the vehicle without the seat head restraints. Head restraints are intended to help reduce injuries during an accident.

### Seat adjustment

-  When moving the seats, make sure
- there are no items in the footwell or behind the seat
  - the cup holder next to the armrest is removed
  - the cup holder in the front passenger footwell is folded closed
- Otherwise, you could damage the seats.

### Power seats

-  The memory function (▷ page 70) lets you store the settings for the seat position together with the settings for the steering wheel and the exterior rear view mirrors.

- ▶ Switch on the ignition.
- or
- ▶ Open the respective door.



- ▶ **Seat fore and aft adjustment:** Press the switch forward or backward in direction of arrow ③.
- ▶ **Seat backrest tilt:** Press the switch forward or backward in direction of arrow ②.
- ▶ **Seat height:** Press the switch up or down in direction of arrow ⑤.
- ▶ **Seat cushion tilt:** Press the switch up or down in direction of arrow ④ until your upper legs are lightly supported.
- ▶ **Head restraint height:** Press the switch up or down in direction of arrow ①.

#### Head restraint fore and aft adjustment

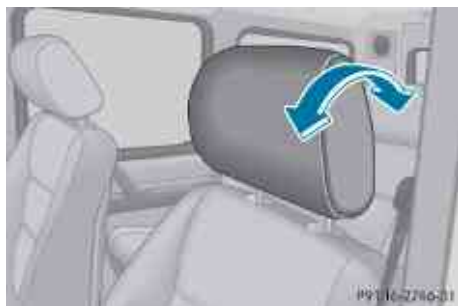

- ▶ Adjust the head restraint to the desired position by pushing or pulling on the upper edge of the head restraint cushion.

#### Removing and installing front seat head restraints

- ▶ **i** Tilt the seat backrest rearward for easier removal and installation of the head restraints.



- ▶ **Removing:** Press switch ① upwards and hold until the head restraint is fully extended.
- ▶ Pull out the head restraint with both hands.
- ▶ **Installing:** Press switch ① upwards and hold for about 5 seconds.
- ▶ Insert the head restraint into openings on the seat backrest.
- ▶ **i** The guide bar with the detent must be on the left.
- ▶ Push the head restraint down until it engages.
- ▶ Adjust the head restraint to the desired position.

#### Rear seat head restraints

##### **⚠ Warning!**

For safety reasons, always drive with the rear head restraints in the upright position when the rear seats are occupied.

Keep the area around head restraints clear of articles (e.g. clothing) to not obstruct the folding operation of the head restraints.

 **Warning!**

For your protection, drive only with properly positioned head restraints.

Adjust the head restraint in such a way that it is as close to the head as possible and the center of the head restraint supports the back of the head at eye level. This will reduce the potential for injury to the head and neck in the event of an accident or similar situation.

With a rear seat occupied, make sure to move the respective head restraint up from the lowest non-use position and have the occupant adjust the head restraint properly.

Do not drive the vehicle without the seat head restraints installed when the rear seats are occupied. Head restraints are intended to help reduce injuries during an accident.

**Rear seat head restraint height adjustment**

- ▶ **Raising:** Pull head restraint upward to the desired position.
- ▶ **Lowering:** Push head restraint downward to the desired position.

**Rear seat head restraints, removing and installing**

- ▶ **Removing:** Pull out the head restraint with both hands.
- ▶ **i** The head restraint(s) should be stored in a secure place.
- ▶ **Installing:** Insert the head restraint into openings on the seat backrest.
- ▶ Push the head restraint down to the stop.
- ▶ Adjust the head restraint to the desired position.

**Multicontour seat**

The multicontour seat has a movable seat cushion and inflatable air cushions built into the seat backrest to provide additional lumbar and side support.

The seat cushion depth, seat backrest cushion-height and curvature can be continuously varied with switches on the inside of each front seat when the ignition is switched on.

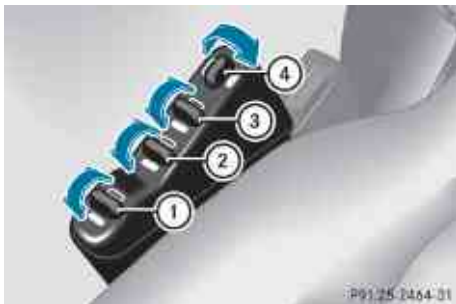

- ▶ Switch on the ignition.
- ▶ **Seat cushion depth:** Adjust the seat cushion depth to the length of your upper leg using switch ①.
- ▶ **Seat backrest contour:** Adjust the contour of the seat backrest to the desired position using switches ② and ③.
- ▶ **Seat backrest side bolsters:** Adjust the side bolsters so that they provide good lateral support using switch ④.

### Seat ventilation



The blue indicator lamps in seat ventilation switch ① come on to show which ventilation level you have selected.

- ▶ **i** The seat ventilation for the driver's seat can be activated using the summer opening feature (▶ page 82).
- ▶ Switch on the ignition.
- ▶ **Switching on:** Press seat ventilation switch ①.

Three blue indicator lamps in the switch come on.

- ▶ Press seat ventilation switch ① repeatedly until the desired ventilation level is set.
- ▶ **Switching off:** Press seat ventilation switch ① repeatedly until all indicator lamps go out.

If there is insufficient voltage the seat heating switches off automatically.

### Seat heating

#### Front seat heating



The red indicator lamps in the switch come on to show which heating level you have selected.

The seat heating switches from level 3 (high) to level 2 after approximately 5 minutes.

The seat heating switches from level 2 to level 1 (low) after approximately 10 minutes.

The seat heating switches off automatically from level 1 after approximately 20 minutes.

- ▶ Switch on the ignition.
- ▶ **Switching on:** Press seat heating switch ①.
- ▶ Three red indicator lamps in the switch come on.
- ▶ Continue pressing seat heating switch ① until desired seat heating level is reached.
- ▶ **Switching off:** Press seat heating switch ① repeatedly until all indicator lamps go out.

If one or more of the indicator lamps in respective seat heating button ① are flashing, there is insufficient voltage available since too many electrical consumers are turned on. The seat heating switches off automatically.

The seat heating will switch back on again automatically as soon as sufficient voltage is available.

### Rear seat heating



- ① Normal heating
- ② Rapid heating

The red indicator lamps in the switch come on to show which heating level you have selected.

The seat heating switches from level **2** (rapid seat heating) to level **1** (normal seat heating) after approximately 5 minutes.

The seat heating switches off automatically from level **1** after approximately 30 minutes.

- ▶ Switch on the ignition.
- ▶ **Switching on seat heating:** Press upper switch position ①.  
A red indicator lamp in the switch comes on.
- ▶ **Switching off seat heating:** Press upper switch position ① once more.
- ▶ **Switching on rapid seat heating:** Press lower switch position ②.  
Both red indicator lamps in the switch come on.
- ▶ **Switching off rapid seat heating:** Press lower switch position ② once more.

If one or both of the indicator lamps in the seat heating switch are flashing, there is insufficient voltage available since too many electrical consumers are turned on. The seat heating switches off automatically.

The seat heating will switch back on again automatically as soon as sufficient voltage is available.

### Multifunction steering wheel

#### Safety notes

##### ⚠ Warning!

Do not adjust the steering wheel while driving. Adjusting the steering wheel while driving could cause the driver to lose control of the vehicle.

The steering wheel adjustment feature can be operated when the driver's door is open. Therefore, do not leave children unattended in the vehicle, or with access to an unlocked vehicle. A child's unsupervised access to a vehicle could result in an accident and/or serious personal injury.

Make sure

- you can reach the steering wheel with your arms slightly bent at the elbows
- you can move your legs freely
- all displays (including malfunction and indicator lamps) on the instrument cluster are clearly visible

### Steering wheel adjustment



- ▶ Switch on the ignition.
- or
- ▶ Open the driver's door.
- ▶ **Adjusting steering wheel in or out:** Move stalk in direction of arrows ①.
- ▶ **Adjusting steering wheel up or down:** Move stalk in direction of arrows ②.

**i** The memory function (▷ page 70) lets you store the settings for the steering wheel together with the settings for the seat position and the exterior rear view mirrors.

### Easy-entry/exit feature

This feature allows the driver an easier entry into and exit from the vehicle. When entering and exiting the vehicle, the steering wheel is in its uppermost position.

The easy-entry/exit feature can be activated or deactivated in the Convenience submenu of the control system (▷ page 108).

#### **⚠ Warning!**

You must make sure no one can become trapped or injured by the moving steering wheel when the easy-entry/exit feature is activated.

To stop steering wheel movement do one of the following:

- Move steering wheel adjustment stalk.
- Press one of the memory position buttons.
- Press the memory button.

Do not leave children unattended in the vehicle, or with access to an unlocked vehicle. Children could open the driver's door and unintentionally activate the easy-entry/exit feature, which could result in an accident and/or serious personal injury.

With the easy-entry/exit feature activated, the steering wheel will return to its last set position when you close the driver's door with the ignition switched on. The steering wheel will also return to its last set position when you insert the SmartKey into the starter switch with the driver's door closed.

**i** The last set steering wheel position is stored when the ignition is switched off or the position is stored in memory (▷ page 71).

With the easy-entry/exit feature activated, the steering wheel tilts upwards when you remove the SmartKey from the starter switch. The steering wheel also tilts upwards when you open the driver's door with the SmartKey in starter switch position **0** or **1**.

**i** When the current position for the steering wheel is in the uppermost tilt position, the steering wheel will no longer be able to move upward when the easy-entry/exit feature is activated.

The adjustment procedure is briefly interrupted when the engine is started.

#### **⚠ Warning!**

Let the system complete the adjustment procedure before setting the vehicle in motion. All steering wheel adjustment must be completed before setting the vehicle in motion. Driving off with the steering wheel

still adjusting could cause the driver to lose control of the vehicle.

### Heated steering wheel

The steering wheel heating warms up the leather area of the steering wheel.



- ▶ Switch on the ignition.
- ▶ **Switching on:** Turn switch at the tip of the stalk in direction of arrow ①. Indicator lamp ③ comes on.

**i** The steering wheel heating may be suspended temporarily. However, indicator lamp ③ remains on. The steering wheel heating is suspended when the temperature of the vehicle interior is above 86°F (30°C). It is also suspended when the temperature of the steering wheel is above 95°F (35°C).

When these conditions do not apply anymore, steering wheel heating continues.

- ▶ **Switching off:** Turn switch at the tip of stalk in direction of arrow ②. Indicator lamp ③ goes out.
- i** Indicator lamp ③ flashes or goes out in case of power surge or undervoltage or if the steering wheel heating malfunctions.
- i** The steering wheel heating switches off automatically when you remove the SmartKey from the starter switch.

For more information on the steering wheel, see “Multifunction steering wheel” (▷ page 97).

### Mirrors

#### Notes

Adjust the interior and exterior rear view mirrors before driving so that you have a good view of the road and traffic conditions.

#### Interior rear view mirror

- ▶ Adjust the interior rear view mirror manually.

#### Exterior rear view mirrors

##### **⚠ Warning!**

Exercise care when using the passenger-side exterior rear view mirror. The mirror surface is convex (outwardly curved surface for a wider field of view). Objects in mirror are closer than they appear. Check your interior rear view mirror and glance over your shoulder before changing lanes.

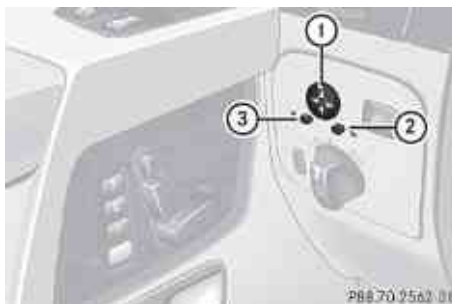

- ▶ Switch on the ignition.
- ▶ Press button ③ for the driver's side exterior rear view mirror or button ② for the passenger-side exterior rear view mirror.

- ▶ Press adjustment button ① up, down, left or right according to the desired setting.

**!** If an exterior rear view mirror was forcibly hit from the front, manually snap it back into place.

- i** At low ambient temperatures, the exterior rear view mirrors will be heated automatically.

#### Auto-dimming rear view mirrors

The exterior rear view mirror on the driver's side and the interior rear view mirror will respond automatically to glare when the ignition is switched on and incoming light from headlamps falls on the sensor in the interior rear view mirror.

The rear view mirrors will not react if the automatic transmission is set to reverse gear **R** or the interior lighting is switched on.

#### **⚠ Warning!**

The auto-dimming function does not react if incoming light is not aimed directly at sensors in the interior rear view mirror.

The interior rear view mirror and the exterior rear view mirror on the driver's side do not react, for example, when transporting cargo which covers the rear window.

Light hitting the mirror(s) at certain angles (incident light) could blind you. As a result, you may not be able to observe traffic conditions and could cause an accident.

#### Activating exterior rear view mirror parking position

This feature is only available in Canada vehicles.

Follow these steps to activate the mirror parking position so that the passenger-side exterior rear view mirror will be turned downward to the stored position.

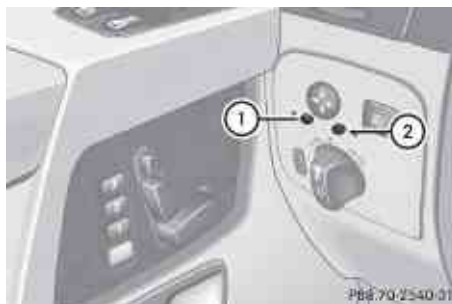

- ▶ Make sure you have stored a parking position for the passenger-side exterior rear view mirror (> page 71).
- ▶ Switch on the ignition.
- ▶ Press button ② for the passenger-side exterior rear view mirror.
- ▶ Shift the automatic transmission into reverse gear **R**.

The passenger-side exterior rear view mirror will be turned downward to the stored position.

The exterior rear view mirror returns to its previously stored driving position

- 10 seconds after you have put the gear selector lever out of position reverse gear **R**
- immediately once your vehicle exceeds a speed of approximately 6 mph (10 km/h)
- immediately when you press button ① for driver's side exterior rear view mirror

#### Memory function

##### Notes

With the memory function you can store up to three different configurations per front seat.

Each memory position button on the driver's side can store all of the following settings:

- Seat position
- Multicontour seat: previously saved setting



- Steering wheel position
- Exterior rear view mirrors' position

### **Warning!**

Do not activate the memory function while driving. Activating the memory function while driving could cause the driver to lose control of the vehicle.

Each memory position button on the front passenger side can store all of the following settings:

- Seat position
- Multicontour seat: previously saved setting



### **Storing positions into memory**

- ▶ Adjust the seats.
- ▶ On the driver's side, additionally adjust the steering wheel and exterior rear view mirrors to the desired positions.
- ▶ Press memory button ②.
- ▶ Press memory button ② once and within 3 seconds press one memory position button ①, ② or ③.

All settings are stored to the selected position.

### **Recalling positions from memory**

- ▶ Press and hold desired memory position button ①, ② or ③ until the seat has completely moved to the stored position. On the driver's side, also wait for the steering wheel and exterior rear view mirrors to move to the stored position.
- ① Releasing the memory position button stops movement to the stored positions immediately.

### **Storing exterior rear view mirror parking position**

This feature is only available in Canada vehicles.

For easier parking, you can adjust the passenger-side exterior rear view mirror so that you can see the right rear wheel as soon as you engage reverse gear **R**.

For information on activating the parking position, see (▶ page 70).

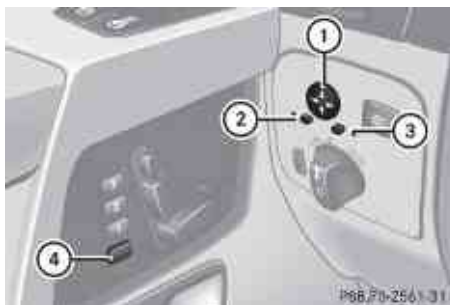

- ▶ Stop the vehicle.
- ▶ Switch on the ignition.
- ▶ Press button ③.  
The passenger-side exterior rear view mirror is selected.
- ▶ Adjust the passenger-side exterior rear view mirror with adjustment button ① so that you see the rear wheel and the road curb.

- ▶ Press memory button ④.
- ▶ Within 3 seconds, press bottom of adjustment button ①.  
The parking position is stored if the mirror does not move.

**i** If the mirror does move, repeat the above steps. After the setting is stored, you can move the mirror again.

## Lighting

### Notes

**i** If you drive in countries where vehicles drive on the other side of the road than the country where the vehicle is registered, you must have the headlamps modified for symmetrical low beams. Relevant information can be obtained at any authorized Mercedes-Benz Center.

### Exterior lamp switch



- 1 Standing lamps, left
- 2 Standing lamps, right
- 3 Off  
Daytime running lamp mode
- 4 Automatic headlamp mode  
Daytime running lamp mode
- 5 Parking lamps (also tail lamps, license plate lamps, side marker lamps and instrument panel lamps)
- 6 Low-beam headlamps or high-beam headlamps

7 Front fog lamps

8 Rear fog lamp

**i** If you hear a warning signal you have forgotten to switch off the low-beam headlamps or the parking lamps before opening the driver's door.

In addition, the message **Switch Off Lights** appears in the multifunction display.

Switch off the low-beam headlamps or the parking lamps.

If the message **Turn off lights or remove key** appears in the multifunction display remove the SmartKey from the starter switch or switch off the headlamps.

**!** Failure to switch off the exterior lamps when leaving the vehicle may result in a discharged battery.

### Low-beam headlamps

The low-beam headlamps can be switched on and off with the exterior lamp switch.

▶ **Switching on:** Turn the exterior lamp switch to position .

The following lamps come on:

- Low-beam headlamps
- Tail lamps
- Parking lamps
- License plate lamps
- Side marker lamps
- Instrument panel lamps
- Green indicator lamp in the instrument cluster

▶ **Switching off:** Turn the exterior lamp switch to position .

## Automatic headlamp mode



The following lamps come on and go out automatically depending on the brightness of the ambient light:

- Low-beam headlamps
- Tail lamps
- Parking lamps
- License plate lamps
- Side marker lamps

### **Warning!**

If the exterior lamp switch is set to **AUTO**, the headlamps will not automatically come on under foggy conditions.

To minimize risk to you and to others, activate headlamps by turning exterior lamp switch to  when driving or when traffic and/or ambient lighting conditions require you to do so.

In low ambient lighting conditions, only switch from position **AUTO** to  with the vehicle at a standstill in a safe location. Switching from **AUTO** to  will briefly switch off the headlamps. Doing so while driving in low ambient lighting conditions may result in an accident.

The automatic headlamp feature is only an aid to the driver. The driver is responsible for the operation of the vehicle's lights at all times.

- ▶ **Switching on:** Turn the exterior lamp switch to position **AUTO**.

The following lamps come on and go out depending on the brightness of the ambient light with the SmartKey in starter switch position **1**:

- tail lamps
- parking lamps
- license plate lamps
- side marker lamps

When the engine is running, the low-beam headlamps will also come on and turn off automatically.

**Canada only:** High-beam headlamps are only available with the exterior lamp switch in position .

## Daytime running lamp mode

In Canada, the daytime running lamp mode is mandatory and therefore in a constant mode.

In the USA, the daytime running lamp mode is deactivated by default.

- ▶ Activate the daytime running lamp mode using the control system, see "Setting daytime running lamp mode (USA only)" (> page 106).
- ▶ Turn the exterior lamp switch to position **0** or **AUTO**.

When the engine is running, the low-beam headlamps come on.

In low ambient lighting conditions, the following lamps will come on additionally:

- Tail lamps
- Parking lamps
- License plate lamps
- Side marker lamps

With the daytime running lamp mode activated and the engine running, you cannot switch off the low-beam headlamps manually.

### **Canada only**

With the exterior lamp switch in position **0** or **AUTO**, you cannot switch on the high-beam headlamps.

The high-beam flasher is available at all times.

- ▶ For nighttime driving turn the exterior lamp switch to position  to permit activation of the high-beam headlamps.

When the engine is running, and you

- shift from a driving position to neutral position **N** or park position **P** with the vehicle at a standstill, the low-beam headlamps will go out with a delay of 3 minutes
- turn the exterior lamp switch to position , the low-beam headlamps, the tail



and parking lamps, the license plate lamps and the side marker lamps come on

- turn the exterior lamp switch to position , the manual headlamp mode has priority over the daytime running lamp mode

The corresponding exterior lamps come on (▷ page 72).

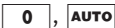

### USA only

In high ambient lighting conditions you can switch on the high-beam headlamps with the exterior lamp switch in position .

In low ambient lighting conditions you can switch on the high-beam headlamps with the exterior lamp switch in position ,  or .

The high-beam flasher is available at all times.

- ▶ For nighttime driving turn the exterior lamp switch to position  to permit activation of the high-beam headlamps.



When the engine is running, and you turn the exterior lamp switch to position  or , the manual headlamp mode has priority over the daytime running lamp mode.



The corresponding exterior lamps come on (▷ page 72).

### Fog lamps

Fog lamps cannot be switched on with the exterior lamp switch in position .





#### **Warning!**

In low ambient lighting or foggy conditions, only switch from position  to  with the vehicle at a standstill in a safe location.

Switching from  to  will briefly switch off the headlamps. Doing so while driving in low ambient lighting conditions may result in an accident.

Fog lamps will operate with the parking lamps and/or the low-beam headlamps on. Fog lamps should only be used in conjunction with low-beam headlamps. Consult your State or

Province Motor Vehicle Regulations regarding permissible lamp operation.

- ▶ Turn the exterior lamp switch to position  or  (▷ page 72).
- ▶ **Switching on front fog lamps:** Pull out the exterior lamp switch to first stop. The green indicator lamp  in the exterior lamp switch comes on.
- ▶ **Switching on rear fog lamp:** Pull out the exterior lamp switch to second stop. The rear fog lamp, the front fog lamps and the yellow indicator lamp  in the exterior lamp switch come on.
- ▶ **Switching off front fog lamps/rear fog lamp:** Push in the exterior lamp switch to its stop.



### Locator lighting and night security illumination

Locator lighting and night security illumination are described in the “Control system” section, see “Setting locator lighting” (▷ page 106) and “Setting night security illumination (Headlamps delayed shut-off feature)” (▷ page 107).

#### Combination switch



## High beam



- ▶ Turn the exterior lamp switch to position  (▷ page 72).
- ▶ **Switching on:** Push the combination switch in direction of arrow ①. The high-beam headlamp indicator lamp  in the instrument cluster comes on.
- ▶ **Switching off:** Pull the combination switch in direction of arrow ② to its original position.

## High-beam flasher

- ▶ **Switching on:** Pull the combination switch briefly in direction of arrow ②.

## Turn signals



- ▶ Press the combination switch in direction of arrow ① or ②. The corresponding turn signal indicator lamp  or  in the instrument cluster flashes.
- The combination switch resets automatically after major steering wheel movements.
- ❗ To signal minor directional changes such as changing lanes, press combination switch only to point of resistance and release. The corresponding turn signal lamps will flash three times.

## Hazard warning flasher

The hazard warning flasher can be switched on at all times, even with the SmartKey removed from the starter switch.

The hazard warning flasher comes on automatically when an air bag deploys.



- ▶ **Switching on:** Press hazard warning flasher switch ①. All turn signal lamps are flashing.

❗ With the hazard warning flasher activated and the combination switch set for either left or right turn, only the respective left or right turn signals will operate when the ignition is switched on.

- ▶ **Switching off:** Press hazard warning flasher switch ① again.

❗ If the hazard warning flasher has been activated automatically, press hazard warning flasher switch ① to switch it off.

## Headlamp cleaning system



- ▶ Switch on the ignition.
- ▶ Press headlamp cleaning button ①.

The headlamps are cleaned with a high-pressure water jet.

The headlamps will be cleaned automatically when you have

- switched on the headlamps and
- the windshield wipers have wiped the windshield with washer fluid fifteen times

For information on filling up the washer reservoir, see “Washer system and headlamp cleaning system” (> page 153).

### Corner-illuminating front fog lamps

The corner-illuminating front fog lamps improve illumination of the area in the direction into which you are turning.

The corner-illuminating front fog lamps will only operate

- in low ambient lighting conditions
- at vehicle speeds below 25 mph (40 km/h)
- with the front fog lamps switched off
- when the engine is running

### Switching on

- ▶ Turn the exterior lamp switch to position  or **AUTO**.

or

- ▶ Activate the daytime running lamp mode (> page 73).
- ▶ Switch on the left or right turn signal, depending on whether you are turning left or right.

The respective front fog lamp comes on. If you have switched on the turn signal for one side but turn the steering wheel in the other direction, the corner-illuminating

front fog lamp comes on on the side of the turn signal.

or

- ▶ Turn steering wheel in the desired direction.  
Driving forward: The front fog lamp on the side of your steering direction comes on.  
Driving in reverse: The front fog lamp opposite to your steering direction comes on.

The corner-illuminating front fog lamps will come on automatically depending on the steering angle, even if you did not switch on either turn signal. If the corner-illuminating front fog lamps came on automatically, they will also go out automatically depending on the steering angle and vehicle speed.

The corner-illuminating front fog lamps temporarily come on on both sides of the vehicle if you turn the steering wheel in one direction and then again in the other direction shortly thereafter.

The corner-illuminating front fog lamp remains lit for a short time only. It then goes out automatically.

### Switching off



- ▶ Switch off the left or right turn signal.
- or
- ▶ Steer straight ahead.

- i** There may be a brief delay before the corner-illuminating front fog lamps go out.

### Interior lighting in the front

The interior lighting controls are located in the overhead control panel.



- ① Left reading lamp
- ②  Left reading lamp on/off
- ③ Right reading lamp
- ④  Right reading lamp on/off
- ⑤ Rocker switch for automatic control and manual control
- ⑥ Interior lamp

### Automatic control



- ▶ **Activating:** Press rocker switch ⑤ to center position.  
The interior lighting (except cargo compartment lamps) comes on in darkness, when you
  - unlock the vehicle
  - remove the SmartKey from the starter switch
  - open a front door (the interior lighting in the front comes on)
  - open a rear door (the interior lighting in the rear comes on)

The interior lighting goes out after a short time (▷ page 108).

- ❗ If a door remains open, the interior lamps go out automatically after a few minutes when the SmartKey is removed.

- ▶ **Deactivating:** Press symbol  on rocker switch ⑤.

### Manual control

- ❗ An interior lamp switched on manually does not go out automatically.  
Leaving an interior lamp switched on for an extended period of time with the engine turned off could result in a discharged battery.
- ▶ **Switching on interior lighting:** Press symbol  on rocker switch ⑤.
- ▶ **Switching off interior lighting:** Press rocker switch ⑤ to center position to activate the automatic control.
- ▶ **Switching on/off front reading lamps:** Press respective button .



### Interior lighting in the rear

- ❗ An interior lamp switched on manually does not go out automatically.  
Leaving an interior lamp switched on for an extended period of time with the engine turned off could result in a discharged battery.

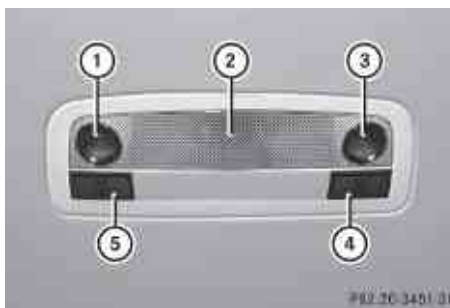
The rear interior lamp is located above the rear seat bench.



- ① Left reading lamp
- ② Rear interior lamp
- ③ Right reading lamp

- ④  Right rear reading lamp on/off
- ⑤  Left rear reading lamp on/off

### Reading lamps

- **Switching on/off:** Press respective reading lamp switch .

### Switching rear interior lamp on/off manually

The switch for the rear interior lamp and the cargo compartment lamps is located in the overhead control panel.



- **Switching rear interior lamp on/off:** Press switch ①.  
The cargo compartment lamps will also come on and off.

### Switching rear interior lamp on/off automatically

The rear interior lamp switches on and off automatically when the automatic control is switched on (► page 77) and a rear door is opened or closed.

- ❗ The rear interior lamp cannot be switched off with switch ① (► page 78) located in the front overhead control panel.

### Cargo compartment lamps

The switch for the cargo compartment lamps and the rear interior lamp is located in the overhead control panel.



The cargo compartment lamps are located above the rear window.

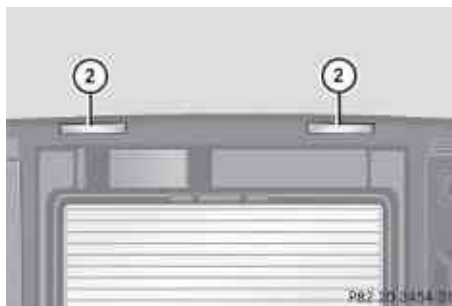

- **Switching cargo compartment lamps ② on/off:** Press switch ①.

- ❗ When opening the tailgate, cargo compartment lamps ② come on automatically. Switching off the cargo compartment lamps using switch ① in the overhead control panel then is not possible.  
You can switch off cargo compartment lamps ② if the tailgate should remain open for a longer period of time, see “Switching cargo compartment lamps off and on with the tailgate open” (► page 79).



### Switching cargo compartment lamps off and on with the tailgate open

#### **Warning!**

To prevent possible personal injury, always keep hands and fingers away from the cargo compartment opening when closing the tailgate. Be especially careful when small children are around.

#### **Warning!**

Make sure the tailgate is closed when the engine is running and while driving. Among other dangers, deadly carbon monoxide (CO) gases may enter vehicle interior resulting in unconsciousness and death.

-  To prevent the vehicle battery from being discharged, switch off the cargo compartment lamps if the tailgate should remain open for a longer period of time.



### Switching off

- ▶ Open the tailgate (▶ page 61).
- ▶ Press door lock ① down in direction of arrow until it engages.

-  Do not close the tailgate if the lock is engaged in down position. The lock could otherwise be damaged. When locking the tailgate, it is important that the door lock be in the same original position as shown in the illustration. To return door lock ① to its original position, press lock cylinder ②.

### Switching on

- ▶ Press lock cylinder ② to activate the cargo compartment lamps again. The cargo compartment lamps will come on.

## Wipers

### Notes

-  Do not operate the wipers when the windshield/rear window is dry. Dust that accumulates on a windshield/rear window might scratch the glass and/or damage the wiper blades when wiping occurs on a dry windshield/rear window. If it is necessary to operate the wipers in dry weather conditions, always operate the wipers with washer fluid.



Combination switch

- ① Single wipe  
Wiping with washer fluid
- ② Switching on windshield wipers

- ▶ Switch on the ignition.

## Windshield wipers

### Switching on/off

0	Windshield wipers off
I	Intermittent wiping

- |     |                    |
|-----|--------------------|
| II  | Normal wiper speed |
| III | Fast wiper speed   |

- ▶ Turn the combination switch in direction of arrow ② to the desired position, depending on the intensity of the rain.

### Intermittent wiping

Only switch on intermittent wiping under wet weather conditions or in the presence of precipitation.

When you select intermittent wiping, the rain sensor is activated. The rain sensor sets a suitable wiping interval depending on the wetness of the sensor surface automatically.

**!** Do not leave windshield wipers on an intermittent setting when the vehicle is taken to an automatic car wash or during windshield cleaning. Windshield wipers will operate in the presence of water sprayed on the windshield, and windshield wipers may be damaged as a result.

**!** If you have set intermittent wiping, dirt on the surface of the rain sensor or optical effects may cause the windshield wipers to wipe in an undesired fashion. This could then damage the windshield wiper blades or scratch the windshield. You should therefore switch off the windshield wipers when weather conditions are dry.

Intermittent wiping interval is dependent on wetness of windshield. After the initial wipe, pauses between wipes are controlled by the rain sensor automatically.

- ▶ Turn the combination switch to position **I**. Intermittent wiping is interrupted when the vehicle is at a standstill and a front door is opened. This protects persons getting into or out of the vehicle from being sprayed.

Intermittent wiping will be continued when all doors are closed and

- the automatic transmission is in drive position **D** or reverse gear **R**

or

- the wiper setting is changed using the combination switch

### Single wipe

- ▶ Press the combination switch briefly in direction of arrow ① to the resistance point. The windshield wipers wipe one time without washer fluid.

### Wiping with washer fluid

- ▶ Press the combination switch in direction of arrow ① past the resistance point. The windshield wipers operate with washer fluid.

**i** To prevent smears on the windshield or noisy/chattering wiper blades, wipe with washer fluid every now and then even when it is raining.

For information on filling up the washer reservoir, see “Washer system and headlamp cleaning system” (> page 153).

For information on cleaning the headlamps with washer fluid, see “Headlamp cleaning system” (> page 75).

### Rear window wiper/washer

The rear window wiper engages automatically when the automatic transmission is shifted into reverse gear **R** with the windshield wipers switched on.



- ▶ Switch on the ignition.
- ▶ **Activating intermittent wiping:** Press switch ①.  
Indicator lamp ② comes on.
- ▶ **Deactivating intermittent wiping:** Press switch ① again.  
Indicator lamp ② goes out.
- ▶ **Wiping with washer fluid:** Press and hold switch ③.  
The rear window is wiped for another 5 seconds after switch ③ is released.

For information on filling up the washer reservoir, see “Washer system and headlamp cleaning system” (▷ page 153).

### Problems with wipers

- !** If anything blocks the wipers (leaves, snow, etc.), switch them off immediately. For safety reasons, stop the vehicle in a safe location, and
- - remove the SmartKey from the starter switch
  - engage the parking brake
- before attempting to remove any blockage.
- Remove blockage.
  - Turn the wipers on again.

If the windshield wipers fail to function at all with the combination switch in position I,

- set the combination switch to the next higher wiper speed
- have the windshield wipers checked at the nearest authorized Mercedes-Benz Center

## Power windows

### Opening and closing

The door windows are opened and closed electrically. The switches for all door windows are located on the driver’s door control panel. The switches for the respective door windows are located on the front passenger door and on the rear doors.

- i** Operating the rear door windows from the rear is not possible when you activate the override switch (▷ page 49).

**⚠ Observe Safety notes, see page 44.**

### **⚠ Warning!**

When closing the door windows, make sure there is no danger of anyone being harmed by the closing procedure.

Activate the override switch when children are riding in the back seats of the vehicle. The children may otherwise injure themselves, e.g. by becoming trapped in the window opening.

The closing of the door windows can be immediately halted by releasing the switch or by releasing button  on the SmartKey.

### **⚠ Warning!**

Do not keep any part of your body up against the window pane when opening a window. The downward motion of the pane may pull that part of your body down between the window pane and the door frame and trap it there. If there is a risk of entrapment, release the switch and pull it to close the window.

- i** You can also open or close the windows using the SmartKey, see “Summer opening feature” (▷ page 82) and “Convenience closing feature” (▷ page 82).



- ① Override switch (► page 49)
- ② Left front door window
- ③ Right front door window
- ④ Right rear door window
- ⑤ Left rear door window

- Switch on the ignition.
- **Opening/closing:** Press or pull and hold switch ② to ⑤ to the resistance point. The corresponding door window will move downwards or upwards until you release the switch.
- **Express opening:** Press switch ② to ⑤ past the resistance point and release. The corresponding door window opens completely.
- **Stopping during express opening:** Press or pull the respective switch again.

### Summer opening feature

When the weather is warm, you can ventilate the vehicle before driving off by simultaneously

- opening the windows
- opening the tilt/sliding sunroof

The summer opening feature can only be activated via the remote control of the SmartKey. The SmartKey must be in close proximity to the driver's outside door handle.

- Aim transmitter eye of the SmartKey at the driver's outside door handle.
- Press and hold button  on the SmartKey until the windows and the tilt/

sliding sunroof have reached the desired position.  
The vehicle unlocks.

- Release button  on the SmartKey to interrupt the opening procedure.



### Convenience closing feature

When locking the vehicle, you can simultaneously close the windows and the tilt/sliding sunroof.



#### **Warning!**

When closing the windows and the tilt/sliding sunroof, make sure there is no danger of anyone being harmed by the closing procedure.

If potential danger exists, proceed as follows:

- Release button  to stop the closing procedure. To open, press and hold button . To continue the closing procedure after making sure that there is no danger of anyone being harmed by the closing procedure, press and hold button .

The SmartKey must be in close proximity to the driver's outside door handle.

- Aim transmitter eye of the SmartKey at the driver's outside door handle.
- Press and hold button  on the SmartKey until the windows and the tilt/sliding sunroof are completely closed.
- Release button  on the SmartKey to interrupt the closing procedure.

### Driving and parking

#### Safety notes

#### **Warning!**

Make sure absolutely no objects are obstructing the pedals' range of movement. Keep the driver's footwell clear of all obstacles. If there are any floor mats or

carpets in the footwell, make sure the pedals still have sufficient clearance.

During sudden driving or braking maneuvers the objects could get caught between the pedals. You could then no longer brake or accelerate. This could lead to accidents and injury.

#### **Warning!**

With the engine not running, there is no power assistance for the brake and steering systems. In this case, it is important to keep in mind that a considerably higher degree of effort is necessary to brake and steer the vehicle. Adapt your driving accordingly.

### Starting the engine

#### **Warning!**

Inhalation of exhaust gas is hazardous to your health. All exhaust gas contains carbon monoxide (CO), and inhaling it can cause unconsciousness and possible death.

Do not run the engine in confined areas (such as a garage) which are not properly ventilated. If you think that exhaust gas fumes are entering the vehicle while driving, have the cause determined and corrected immediately. If you must drive under these conditions, drive only with at least one window fully open at all times.

### Automatic transmission

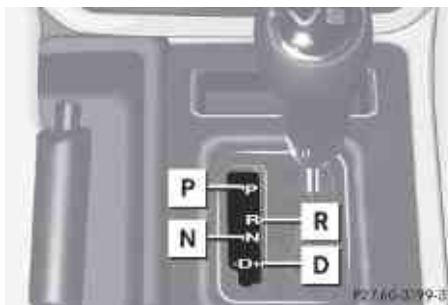

Gearshift pattern for automatic transmission

- P** Park position with gear selector lever lock
- R** Reverse gear
- N** Neutral position
- D** Drive position

For more information, see “Automatic transmission” (▷ page 87).

- ▶ Make sure the automatic transmission is in park position **P**.

### Starting

- ▶ Do not depress the accelerator pedal.
- ▶ Turn the SmartKey in the starter switch to position **3** (▷ page 62) and release it. The engine starts automatically.

### Starting difficulties

-  Remember that extended starting attempts can drain the battery.

If the SmartKey is left in starter switch position **0** for an extended period of time, it can no longer be turned in the starter switch. In this case, the steering is locked.

- ▶ To unlock, remove the SmartKey from the starter switch and reinsert.

### The engine does not start. You can hear the starter.

There could be a malfunction in the engine electronics or in the fuel supply system.

- ▶ Turn the SmartKey in the starter switch to position **0** and repeat the starting procedure.

If the engine does not start after several starting attempts:

- ▶ Contact an authorized Mercedes-Benz Center or call Roadside Assistance.

### The engine does not start. You cannot hear the starter.

The battery may not be sufficiently charged.

- ▶ Get a jump start (▷ page 237).

If the engine will not start despite a jump start:

- ▶ Contact an authorized Mercedes-Benz Center or call Roadside Assistance.

The starter has been exposed to excessive temperatures.

- ▶ Let the starter cool for about 2 minutes.
- ▶ Repeat the starting procedure.

If the engine does not start after several starting attempts:

- ▶ Contact an authorized Mercedes-Benz Center or call Roadside Assistance.

### Driving off

#### **Warning!**

On slippery road surfaces, never downshift in order to obtain braking action. This could result in drive wheel slip and reduced vehicle control. Your vehicle's ABS will not prevent this type of loss of control.

- ❗ Do not run a cold engine at high engine speeds. Running a cold engine at high engine speeds may shorten the service life of the engine. This is not covered by the Mercedes-Benz Limited Warranty.
- ❗ If an acoustic warning sounds and the message Release Parking Brake appears in the multifunction display when

driving off, you have forgotten to release the parking brake.

Release the parking brake.

- ❗ Avoid spinning of a drive wheel. This may cause serious damage to the drivetrain which is not covered by the Mercedes-Benz Limited Warranty.
- ❗ Simultaneously depressing the accelerator pedal and applying the brakes reduces engine performance and causes premature brake and drivetrain wear which is not covered by the Mercedes-Benz Limited Warranty.

- i Once the vehicle is in motion, the automatic central locking system engages and the locking knobs in the doors move down.  
The automatic door lock feature can be deactivated (▷ page 108).

### Automatic transmission

#### **Warning!**

It is dangerous to shift the automatic transmission out of park position **P** or neutral position **N** if the engine speed is higher than idle speed. If your foot is not firmly on the brake pedal, the vehicle could accelerate quickly forward or in reverse. You could lose control of the vehicle and hit someone or something. Only shift into gear when the engine is idling normally and when your right foot is firmly on the brake pedal.

- ❗ Only shift the automatic transmission into reverse gear **R** or park position **P** when the vehicle is stopped. Otherwise the automatic transmission could be damaged.
- ▶ Depress the brake pedal.  
The gear selector lever lock is released.
- ▶ Shift the automatic transmission into drive position **D** or reverse gear **R**.

**i** Shifting the automatic transmission out of park position **P** is only possible with the brake pedal depressed.

Only depressing the brake pedal releases the gear selector lever lock.

- ▶ Wait for the gear selection process to complete before setting the vehicle in motion.
- ▶ If engaged, release the parking brake.
- ▶ Release the brake pedal.
- ▶ Carefully depress the accelerator pedal.

After a cold start, the automatic transmission shifts at a higher engine revolution. This allows the catalytic converter to reach its operating temperature earlier.

For more information on driving, see “Driving instructions” (▷ page 176).

For information on off-road driving, see “Off-road driving” (▷ page 179).

### Problems while driving

#### The engine runs erratically and misfires

- An ignition cable may be damaged.
- The engine electronics may not be operating properly.
- Unburned gasoline may have entered the catalytic converter and damaged it.
- ▶ Give very little gas.
- ▶ Have the problem checked at an authorized Mercedes-Benz Center as soon as possible.

#### The coolant temperature is above 248°F (120°C)

The coolant is too hot and is no longer cooling the engine.

- ▶ Stop the vehicle in a safe location as soon as possible.
- ▶ Turn off the engine immediately.

- ▶ Allow the engine and coolant to cool off.
- ▶ Check the coolant level and add coolant if necessary (▷ page 152).

### In case of accident

If the vehicle is leaking fuel:

- ▶ Do not start the engine under any circumstances.
- ▶ Exit the vehicle at a safe distance from the roadway.
- ▶ Notify local fire and/or police authorities.

If the extent of the damage cannot be determined:

- ▶ Contact an authorized Mercedes-Benz Center or call Roadside Assistance.

If no damage on major assemblies, fuel system, and engine mount can be determined:

- ▶ Start the engine in the usual manner.

### Parking

#### Warning!

Do not park this vehicle in areas where combustible materials such as grass, hay or leaves can come into contact with the hot exhaust system. These materials could be ignited and cause a vehicle fire.

Vehicle movement can cause serious personal injury or damage to the vehicle or the vehicle drivetrain. Therefore, always do the following before turning off the engine and leaving the vehicle:

- Keep right foot on the brake pedal.
- Engage the parking brake.
- Shift the automatic transmission into park position **P**.
- Slowly release the brake pedal.
- When parked on an incline, always turn the front wheels towards the road curb.

- Turn the SmartKey in the starter switch to position **0** and remove the SmartKey from the starter switch.
- Take the SmartKey with you and lock the vehicle when leaving.

### Parking brake

#### Warning!



Engaging the parking brake while the vehicle is in motion can cause the rear wheels to lock up. You could lose control of the vehicle and cause an accident. In addition, the vehicle's brake lights do not light up when the parking brake is engaged.



#### Warning!

When leaving the vehicle, always remove the SmartKey from the starter switch, take it with you, and lock the vehicle. Do not leave children unattended in the vehicle, or with access to an unlocked vehicle. Children could release the parking brake and/or shift the automatic transmission out of park position **P**, either of which could result in an accident and/or serious personal injury.



- ▶ **Releasing:** Pull up slightly on parking brake lever ① and press release button ②.
- ▶ Push parking brake lever ① down to its original position.  
When the ignition is switched on or the engine is running, the brake warning lamp

 (USA only) or  (Canada only) in the instrument cluster goes out.

- ▶ **Engaging:** Pull up parking brake lever ① firmly.  
When the engine is running, the brake warning lamp  (USA only) or  (Canada only) in the instrument cluster comes on.

### Turning off the engine

#### Warning!

Do not turn off the engine before the vehicle has come to a complete stop. With the engine not running, there is no power assistance for the brake and steering systems. In this case, it is important to keep in mind that a considerably higher degree of effort is necessary to brake and steer the vehicle.

- ▶ Shift the automatic transmission into park position **P**.
- ▶ Engage the parking brake.
- ▶ **i** Always engage the parking brake in addition to shifting the automatic transmission into park position **P**.  
When parked on an incline, also turn the front wheels towards the road curb.
- ▶ Turn the SmartKey in the starter switch to position **0**.
- ▶ Remove the SmartKey from the starter switch.  
The immobilizer is activated.  
The SmartKey can only be removed from the starter switch with the automatic transmission in park position **P**.



## Automatic transmission

### Introduction

For information on driving with an automatic transmission, see “Driving and parking” (▷ page 82).

#### **Warning!**

Make sure absolutely no objects are obstructing the pedals' range of movement. Keep the driver's footwell clear of all obstacles. If there are any floor mats or carpets in the footwell, make sure the pedals still have sufficient clearance.

During sudden driving or braking maneuvers the objects could get caught between the pedals. You could then no longer brake or accelerate. This could lead to accidents and injury.

-  Allow the engine to warm up under low load use. Do not place full load on the engine until the operating temperature has been reached.

Avoid spinning of a drive wheel for an extended period when driving off on slippery road surfaces.



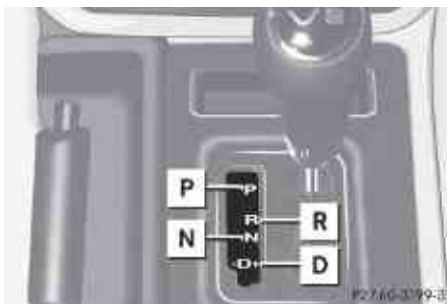

This may cause serious damage to the engine and the drivetrain which is not covered by the Mercedes-Benz Limited Warranty.

-  During the brief warm-up, transmission upshifting is delayed. This allows the catalytic converter to heat up more quickly to operating temperature.

### Gear selector lever





Gearshift pattern for automatic transmission

-  Park position with gear selector lever lock
-  Reverse gear
-  Neutral position
-  Drive position

#### **Warning!**

It is dangerous to shift the automatic transmission out of park position **P** or neutral position **N** if the engine speed is higher than idle speed. If your foot is not firmly on the brake pedal, the vehicle could accelerate quickly forward or in reverse. You could lose control of the vehicle and hit someone or something. Only shift into gear when the engine is idling normally and when your right foot is firmly on the brake pedal.

-  Only shift the automatic transmission into reverse gear **R** or park position **P** when the vehicle is stopped. Otherwise the automatic transmission could be damaged.

-  Shifting the automatic transmission out of park position **P** is only possible with the brake pedal depressed.

Only depressing the brake pedal releases the gear selector lever lock.

-  The current gear selector lever position corresponds with the current transmission position.

The current transmission position **P**, **R**, **N**, or **D** appears in the multifunction display (▷ page 88).

### Shifting procedure

The automatic transmission selects individual gears automatically, depending on:

- the selected gear range (▷ page 89)
- transfer case position (**HIGH** or **LOW**) (▷ page 91)
- the position of the accelerator pedal
- the vehicle speed

With drive position **D** selected, you can influence transmission shifting by limiting or extending the gear range.

### Transmission positions

The current transmission position appears in the multifunction display.



① Transmission position indicator

### Effect

#### **P** Park position

Shift the automatic transmission into park position **P** only when the vehicle is stopped. The park position is not intended to serve as a brake when the vehicle is parked. Rather, the driver should always engage the parking brake in addition to shifting the automatic transmission into park position **P** to secure the vehicle.

The SmartKey can only be removed from the starter switch with the gear selector lever in park position **P**. With the SmartKey removed from the starter switch, the gear selector lever is locked in park position **P**.

If the vehicle's electrical system is malfunctioning, the gear selector lever could remain locked in park position **P**. To unlock the gear selector lever manually, see "Manually unlocking the gear selector lever" (▷ page 222).

#### **R** Reverse gear

Shift the automatic transmission into reverse gear **R** only when the vehicle is stopped.

**Effect****N Neutral position**

No power is transmitted from the engine to the drive axle. When the brakes are released, the vehicle can be moved freely (pushed or towed).

To avoid damage to the transmission, never shift the automatic transmission into neutral position **N** while driving.

Exceptions:

- If the ESP® is deactivated or malfunctioning, shift the automatic transmission into neutral position **N** if the vehicle is in danger of skidding.
- Shift the automatic transmission into neutral position **N** if you have to shift the transfer case.

**!** Coasting the vehicle, or driving for any other reason with the automatic transmission in neutral position **N** can result in transmission damage that is not covered by the Mercedes-Benz Limited Warranty.

**D Drive position**

The automatic transmission shifts automatically. All forward gears are available.

**Driving tips****Kickdown**

Use the kickdown when you want maximum acceleration.

- ▶ Depress the accelerator pedal past the point of resistance.  
Depending on the engine speed the automatic transmission shifts into a lower gear.

**Working on the vehicle****Warning!**

When working on the vehicle, engage the parking brake and shift the automatic transmission into park position **P**. Otherwise the vehicle could roll away which could result in an accident and/or serious personal injury.

**Gear ranges**

With the automatic transmission in drive position **D**, you can limit or extend the gear range, see “One-touch gearshifting” (▷ page 90).

The current gear range appears in the multifunction display.



① Gear range indicator

**!** If the transfer case is in off-road position **LOW**, the automatic transmission will not shift up automatically, even when the engine has reached the speed limit for that gear. There is a risk of damaging the engine.

It is very important to make sure the permissible engine speed is not exceeded.

	Effect
<b>3</b>	With this selection you can use the braking effect of the engine.
<b>2</b>	Allows the use of engine's braking power when driving <ul style="list-style-type: none"> <li>• on steep downgrades</li> <li>• in mountainous regions</li> <li>• under extreme operating conditions</li> </ul>
<b>1</b>	For maximum use of engine's braking effect on very steep or lengthy downgrades.

### One-touch gearshifting

With the automatic transmission in drive position **D**, you can limit or extend the gear range using the gear selector lever.

### Limiting gear range

#### **Warning!**

On slippery road surfaces, never downshift in order to obtain braking action. This could result in drive wheel slip and reduced vehicle control. Your vehicle's ABS will not prevent this type of loss of control.

- ▶ Briefly press the gear selector lever to the left in the **D-** direction.  
The automatic transmission will shift into the next lower gear as permitted by the shift program. This action simultaneously limits the gear range of the automatic transmission.
- i** To avoid overrevving the engine when downshifting, the automatic transmission will not shift into a lower gear if the engine's maximum speed would be exceeded.

### Extending gear range

- ▶ Briefly press the gear selector lever to the right in the **D+** direction.  
The automatic transmission will shift into the next higher gear as permitted by the shift program. This action simultaneously extends the gear range of the automatic transmission.
- i** If you press on the accelerator pedal when the engine has reached the revolution limit of the current gear range, the automatic transmission will upshift beyond any gear range limit selected.

### Canceling gear range limit

- ▶ Press and hold the gear selector lever to the right in the **D+** direction until **D** reappears in the multifunction display.  
The automatic transmission will shift from the current gear range directly into drive position **D**.

### Shifting into optimal gear range

- ▶ Press and hold the gear selector lever to the left in the **D-** direction.  
The automatic transmission will select the gear range suited for optimal acceleration and deceleration automatically. This will involve shifting down one or more gears.

### Emergency operation (limp-home mode)

If vehicle acceleration becomes less responsive or sluggish or the automatic transmission no longer shifts, the automatic transmission is most likely operating in limp-home (emergency operation) mode. In this mode only second gear and reverse gear **R** can be selected.

- ▶ Stop the vehicle in a safe location.
- ▶ Shift the automatic transmission into park position **P**.
- ▶ Turn off the engine.

- ▶ Wait at least 10 seconds before restarting.
- ▶ Restart the engine.
- ▶ Shift the automatic transmission into drive position **D** (for second gear) or reverse gear **R**.
- ▶ Have the automatic transmission checked at an authorized Mercedes-Benz Center as soon as possible.

### Transfer case

For more information on off-road driving, see “Off-road driving” (> page 179).

### Transfer case position

<b>H</b>	<b>HIGH</b> Road position
<b>L</b>	<b>LOW</b> Off-road position This position is intended for driving off-road and steep gradients. The automatic transmission will not upshift automatically to the next higher gear range when driving at the rpm limit. The transfer case supports the engine's driving force (approximately $1/2$ speed). Output is therefore increased.
<b>N</b>	<b>Neutral</b> No power is transmitted from the engine to the drive axle.

### Switching transfer case

The transfer case switch is located on the lower part of the center console.



Transfer case switch

Current transfer case indicator ① appears in the multifunction display.



### ⚠ Warning!

Always wait until the procedure of shifting from HIGH to LOW – and from LOW to HIGH – has been entirely completed. During this procedure do not turn off the engine or shift the automatic transmission into another gear. If you do not wait until the shifting procedure has been entirely completed then it might not be correctly performed. The transfer case might be in neutral, thus interrupting the transfer of power between the engine and the drive axle.

The vehicle is then freely movable, even if a gear has been selected, and could unintentionally be set into motion – particularly on up – or downhill grades. This

could lead to an accident and cause injury to yourself and others.

Please observe related messages appearing in the multifunction display.

### Switching from HIGH to LOW

❗ The shifting procedure can only be performed when the following conditions are met:

- The engine is running.
- The automatic transmission is in neutral position **N**.
- The vehicle is not at a standstill.
- The vehicle speed does not exceed 25 mph (40 km/h).

▶ Press upper half (“LOW”) of the transfer case switch.  
Once the shift is complete, transfer case position L appears in transfer case indicator ①.

If the shifting procedure does not take place, press upper half (“LOW”) of the transfer case switch once more.

▶ Shift the automatic transmission into drive position **D**.

### Switching from LOW to HIGH

❗ The shifting procedure can only be performed when the following conditions are met:

- The engine is running.
- The automatic transmission is in neutral position **N**.
- The vehicle is not at a standstill.
- The vehicle speed does not exceed 43 mph (70 km/h).

▶ Press lower half (“HIGH”) of the transfer case switch.  
Once the shift is complete, transfer case position H appears in transfer case indicator ①.

If the shifting procedure does not take place, press lower half (“HIGH”) of the transfer case switch once more.

▶ Shift the automatic transmission into drive position **D**.

### Messages in the multifunction display

If a shift was not completed and one of the following messages appears in the multifunction display:

- TC shift conditions not fulfilled  
The shift did not take place. At least one shift condition was not met.
  - ▶ Repeat the shifting procedure.
- TC in neutral  
The shift did not take place. The transfer case is in neutral. Transfer case position N appears in transfer case indicator ①.
  - ▶ Repeat the shifting procedure.

#### **Warning!**

If the transfer case is in **Neutral**, the park position **P** of the automatic transmission will not hold the vehicle. The parking brake must be engaged to hold the vehicle in place.

- TC shift procedure canceled  
The shift did not take place.
    - ▶ Repeat the shifting procedure.
  - Transfer case Visit workshop  
There may be a malfunction in the system.
    - ▶ Repeat the shifting procedure.
- If the shifting procedure still does not take place:
- ▶ Have the vehicle checked at an authorized Mercedes-Benz Center as soon as possible.

**i** If the SmartKey is in starter switch position **0** or **1**, an alarm will sound if the transfer case is in **Neutral** and the driver's door is opened.

Switch the transfer case to gear position **HIGH** or **LOW**.

### Differential locks

Differential locks improve the vehicle's tractive power off-road. Switch differential locks

- for off-road driving
- to switch the ABS off during off-road driving
- for driving through water
- when driving on deep snow and icy or fouled surfaces

**!** Do not switch the front axle differential lock when driving around tight corners. This restricts steering ability.

**!** When driving off-road, apply only moderate pressure to the accelerator pedal if the differential locks are switched on.

When operating the vehicle on a single-axle dynamometer – no matter how briefly – you must

- raise the axle not being driven
- or
- disconnect the drive shaft
- and
- switch the transfer case differential lock.

Otherwise the transfer case can be damaged, which is not covered by the Mercedes-Benz Limited Warranty.

#### **Warning!**

Never drive on pavement with differential locks switched.

Steering control will be strongly affected with the differential locks activated.

The ABS, BAS, and ESP<sup>®</sup> are switched off automatically when the transfer case differential lock is activated.

For more information on off-road driving, see “Off-road driving” (▷ page 179).

### A few words about differentials and differential locks

When a vehicle negotiates a turn, wheels on the outside of the curve must travel farther and rotate faster than the inside wheels. The differential, the operation of a set of gears that allows the powered wheels in a vehicle to turn at different speeds, makes this essential function possible.

The drawback is that the differential also sends most of the engine's power to the wheel with the least load or strain on it. For example, if one of a vehicle's powered wheels sits on a patch of snow and spins because there is no traction, all of the engine's power will go to that wheel because the power will take the path of least resistance. Meanwhile, the opposite wheel, sitting on dry pavement where it could get enough grip to start the vehicle moving, sits idle because it receives no power.

The 4-ETS addresses this problem and provides for good control and steering ability by automatically slowing the slipping wheel and thus increasing the power to the other non-slipping drive wheels to get the vehicle moving. The ESP<sup>®</sup> and the 4-ETS in this vehicle feature such intelligent limited-slip differential technology, ideally suited for on-road and light off-road driving. Transfer case position **LOW** (▷ page 91) also enhances off-road driving capabilities.

More extreme off-road conditions may call for another solution, engaging a differential lock or preventing the differential from operating altogether. This vehicle comes with three differential locks: front, transfer case (center), and rear. Each can be engaged simply by pushing dashboard-mounted

switches in sequential order (center, rear, front) (▷ page 94). When the transfer case (center) differential is locked, half of the engine's power is automatically distributed to the front wheels and half to the rear wheels. When the rear differential is locked, power going to the rear wheels is equally distributed, so that both rear wheels turn at the same speed and torque. Please be aware that engaging the differential locks will significantly reduce the steering ability of the vehicle.

For your safety and the safety of others and to prevent damage to the vehicle, the differential locks must not be engaged when driving on paved roads. It is important to understand that during on-road/paved driving, differentials are absolutely necessary for providing the essential control and steering ability of the vehicle. The differential locks, therefore, must not be engaged when driving on paved roads and should only be used to the extent necessary to negotiate off-road conditions which cannot be handled by the systems (the 4-ETS, the ESP®, and the manual switch position "LOW" of transfer case) this vehicle comes equipped with.

### Switching differential locks on and off

The switches are located on the upper part of the center console.

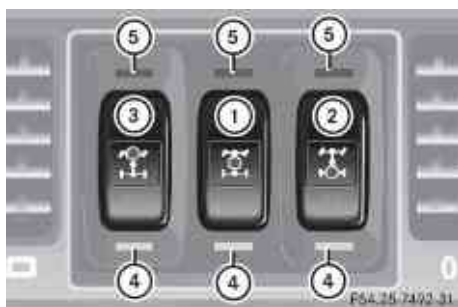

- ① Transfer case (center) differential lock
- ② Rear axle differential lock
- ③ Front differential lock

- ④ Engagement indicator lamps (yellow)
- ⑤ Function indicator lamps (red)

The differential locks can only be switched on in the sequence ①, ②, ③.

### Switching differential locks on

**!** To avoid damage to the transfer case and differential locks:

- Engage the differential locks only at low speed (walking speed, not more than 5 mph [8 km/h]).
- Do not engage the differential locks if the driving wheels are spinning due to lack of traction.
- Do not engage the differential locks on paved roads.

### Transfer case differential lock



▶ Press switch ①.

Yellow engagement indicator lamp ④ for the transfer case differential lock comes on.

The ESP® warning lamp  in the instrument cluster comes on.

When the differential lock engagement operation has been completed, the red function indicator lamp ⑤ comes on.

The message **ABS not available differential locked** appears in the multifunction display.

The ESP® warning lamp  and the  indicator lamp in the instrument cluster come on.

Once the transfer case differential lock is switched on, you can now, if needed, switch on rear axle differential lock ②, or switch on rear axle differential lock ② and front differential lock ③.



### Rear axle differential lock

- ▶ Press switch ②.
- Yellow engagement indicator lamp ④ comes on first, followed by red function indicator lamp ⑤.
- The rear axle differential lock is switched on.

### Front differential lock



- ▶ Press switch ③.
- Yellow engagement indicator lamp ④ comes on first, followed by red function indicator lamp ⑤.
- The front differential lock is switched on.

### Switching differential locks off

There are two different methods to disengage differential locks:

- You can switch the differential locks off in reverse order (③, ②, ①).
- To switch off all differential locks at the same time:
  - ▶ Press switch ①.
  - Yellow engagement indicator lamps ④ go out first. Red function indicator lamps ⑤ go out when the switching process has been carried out in the differential.

To activate the ESP<sup>®</sup>, BAS, and ABS systems, drive again for 3 seconds using a constant driving style.

All messages in the multifunction display disappear. The ESP<sup>®</sup> warning lamp  and the  indicator lamp in the instrument cluster go out.

- ① If red function indicator lamps ⑤ do not go out when the differential locks are disengaged, bring vehicle to a stop and then continue driving. Changing the vehicle load can help to disengage the differential locks.

### Warning!

Always remember to disengage the differential locks when returning to drive on paved roads, see “A few words about differentials and differential locks”.

## Instrument cluster

### Introduction

For a full view illustration of the instrument cluster, see “Instrument cluster” (> page 26).

### Warning!

No messages will be displayed if either the instrument cluster or the multifunction display is inoperative.

As a result, you will not be able to see information about your driving conditions, such as

- speed
- outside temperature
- warning/indicator lamps
- malfunction/warning messages
- failure of any systems

Driving characteristics may be impaired.

If you must continue to drive, please do so with added caution. Contact an authorized Mercedes-Benz Center as soon as possible.



- ① Reset button

For information on changing the instrument cluster settings, e.g. the language, see (▷ page 104).

### Activating the instrument cluster

The instrument cluster is activated when you

- open the driver's door
- switch on the ignition
- press reset button ①
- switch on the exterior lamps

### Adjusting the instrument cluster illumination

Use reset button ① to adjust the illumination brightness for the instrument cluster and the switches on the center console.

- ▶ **To brighten illumination:** Turn reset button ① clockwise until the desired level of illumination is reached.
- ▶ **To dim illumination:** Turn reset button ① counterclockwise until the desired level of illumination is reached.

**i** The instrument cluster illumination is dimmed or brightened automatically to suit ambient light conditions.

The instrument cluster illumination will also be adjusted automatically when you switch on the vehicle's exterior lamps.

### Coolant temperature gauge

The coolant temperature gauge is located on the left side in the instrument cluster (▷ page 26).

#### Warning!

Driving when your engine is overheated can cause some fluids which may have leaked into the engine compartment to catch fire. You could be seriously burned.

Steam from an overheated engine can cause serious burns which can occur just by opening the engine hood. Stay away from the engine if you see or hear steam coming from it.

Stop the vehicle in a safe location away from other traffic. Turn off the engine, get out of the vehicle and do not stand near the vehicle until the engine has cooled down.

During severe operating conditions, e.g. stop-and-go traffic, the coolant temperature may rise close to 248°F (120°C).

**!** Excessive coolant temperature triggers a warning in the multifunction display.

The engine should not be operated with a coolant temperature above 248°F (120°C), i.e. in the red zone of the coolant temperature gauge. Doing so may cause serious engine damage which is not covered by the Mercedes-Benz Limited Warranty.

### Resetting trip odometer

- ▶ Make sure you are viewing the standard display (▷ page 99) in the multifunction display.
- ▶ Press and hold the reset button in the instrument cluster (▷ page 95) until the trip odometer is reset.

### Tachometer

The red marking on the tachometer (▷ page 26) denotes excessive engine speed.

**!** Avoid driving at excessive engine speeds, as it may result in serious engine damage that is not covered by the Mercedes-Benz Limited Warranty.

To help protect the engine, the fuel supply is interrupted if the engine is operated within the red marking.

## Control system

### Introduction

The control system is activated as soon as the starter switch is in position **1** (▷ page 62).

The control system enables you to call up information about your vehicle and to change vehicle settings.

For example, you can use the control system to find out when your vehicle is next due for maintenance service, to set the language for messages in the instrument cluster display, and much more.

### Warning!

A driver's attention to the road and traffic conditions must always be his/her primary focus when driving.

For your safety and the safety of others, selecting features through the multifunction steering wheel should only be done by the driver when traffic and road conditions permit it to be done safely.

Bear in mind that at a speed of just 30 mph (approximately 50 km/h), your vehicle is covering a distance of 44 feet (approximately 14 m) every second.







The control system relays information to the multifunction display.

### Multifunction steering wheel



The displays in the multifunction display and the settings in the control system are controlled by the buttons on the multifunction steering wheel.



Controls in detail

①	Multifunction display
②	Press button  to select submenus in the  Settings menu to set values to set the volume
③	Press button  to answer a call to dial <sup>2</sup> to redial  to end a call to reject an incoming call
④	Press button  to select next or previous menu 

<sup>2</sup> Function only available in telephone menu.

- ⑤ Press button briefly
-  to move within a menu
-  Within **Audio/DVD** menu to select previous or next track, scene or stored station
- Within **Telephone** menu to switch to the phone book and select a name or number

Press and hold button

-  Within **Audio/DVD** menu to select previous or next track with quick search or to select previous or next station in station list or wave band
- Within **Telephone** menu to start the quick search in the phone book

**i** Canada and AMG vehicles:

The steering wheel in this vehicle may vary from steering wheel shown. However, multifunction steering wheel symbols and feature description apply to Canada and AMG vehicles as well.





Depending on the selected menu, pressing the buttons on the multifunction steering wheel will alter what appears in the multifunction display.

The information available in the multifunction display is arranged in menus and accompanying functions and submenus.

The individual functions are then found within the relevant menu (radio or CD operations under **Audio/DVD** menu, for example).

These functions serve to call up relevant information or to customize the settings for your vehicle.

It is helpful to think of the menus, and the functions within each menu, as being arranged in a circular pattern.

- ▶ Press button  or  repeatedly to pass through each menu one after the other.
- ▶ Press button  or  repeatedly to pass through each function display, one after the other, in the current menu.

In the **Settings** menu, instead of functions, you will find a number of submenus for calling up and changing settings. For instructions on using these submenus, see “Settings menu” (▷ page 103).

The number of menus available in the system depends on which optional equipment is installed in your vehicle.

### Multifunction display



- ① Trip odometer
- ② Main odometer
- ③ Transfer case indicator
- ④ Transmission position/gear range indicator
- ⑤ Digital clock
- ⑥ Outside temperature/digital speedometer

For more information on menus displayed in the multifunction display, see “Menu and submenus” (▷ page 99).

## Menus and submenus

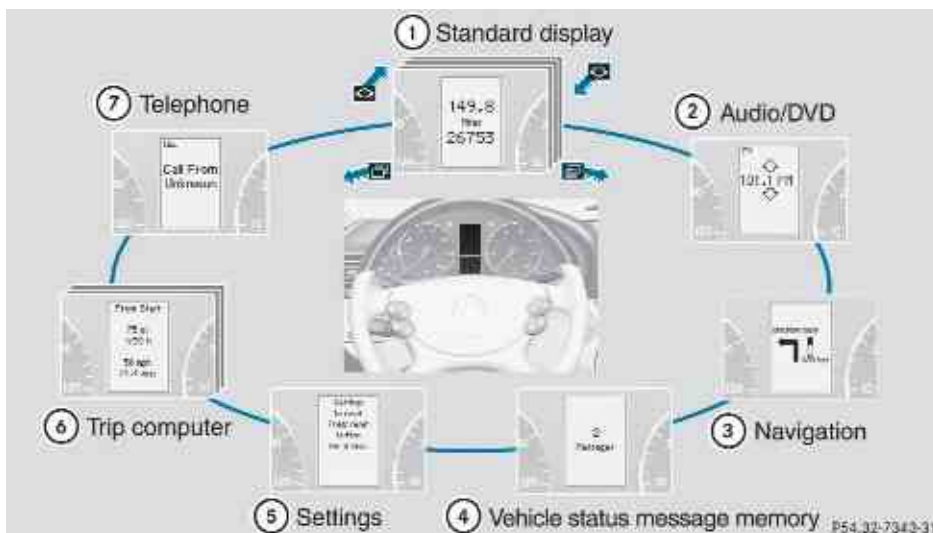

**i** The headings used in the menu table are designed to facilitate navigation within the system and are not necessarily identical to those shown in the multifunction display. The first function displayed in each menu will automatically show you which part of the system you are in.





	Function
①	<b>Standard display</b> menu (▷ page 99)
②	<b>Audio/DVD</b> menu (▷ page 100)
③	<b>Navigation</b> menu (▷ page 102)
④	<b>Vehicle status message memory<sup>3</sup></b> menu (▷ page 102)
⑤	<b>Settings</b> menu (▷ page 103)
⑥	<b>Trip computer</b> menu (▷ page 109)
⑦	<b>Telephone</b> menu (▷ page 110)

## Standard display menu



Standard display

In the standard display, trip odometer ① and main odometer ② appear in the multifunction display.

- ▶ If you see another display, press button  or  repeatedly until the standard display appears.
- ▶ Press button  or  to select the functions in the **Standard display** menu.

<sup>3</sup> The vehicle status message memory menu is only displayed if there is a message stored.

The following functions are available:



- Checking tire inflation pressure with the Advanced TPMS (▷ page 157)
- Calling up digital speedometer or outside temperature (▷ page 100)
- Calling up maintenance service indicator display (▷ page 186)
- Checking engine oil level (▷ page 150)

### Calling up digital speedometer or outside temperature

You can select whether the digital speedometer or the outside temperature appears in the multifunction display (▷ page 105).

#### **Warning!**

The outside temperature indicator is not designed to serve as an ice-warning device and is therefore unsuitable for that purpose. Indicated temperatures just above the freezing point do not guarantee that the road surface is free of ice. The road may still be icy, especially in wooded areas or on bridges.

- ▶ Press button  or  repeatedly until the digital speedometer or the outside temperature appears in the multifunction display.



Digital speedometer



Outside temperature

### Audio/DVD menu

The functions in the **Audio/DVD** menu operate the audio or video equipment which you have currently switched on.

The following functions are available:

- Selecting radio station (▷ page 100)
- Operating audio devices/audio media (▷ page 101)
- Operating video DVD (▷ page 101)



If no audio equipment is currently switched on, the message **AUDIO Off** appears in the multifunction display.

### Selecting radio station

The HD Radio with SIRIUS Satellite Radio is treated as a radio application.

For more information on HD Radio with SIRIUS Satellite Radio, refer to separate COMAND system operating instructions.





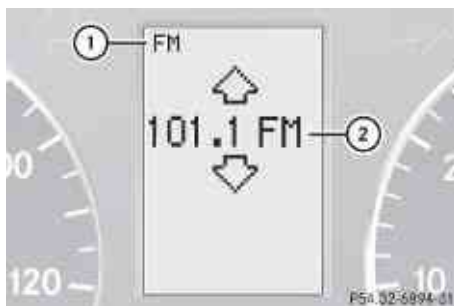

Additional optional satellite radio equipment and a subscription to satellite radio service provider are required for satellite radio operation. Contact an authorized Mercedes-Benz Center for details and availability for your vehicle.

- ▶ Switch on the COMAND system and select radio. Refer to separate COMAND system operating instructions.
- ▶ Press button  or  repeatedly until the currently tuned station appears in the multifunction display.



Example illustration

- ① Wave band setting
- ② Station frequency

- ▶ **Selecting next or previous stored station:** Press button  or  briefly to select a stored station.
- ▶ **Selecting next or previous station in the station list:** Press and hold button  or  to select a station.
- ▶ **Selecting next or previous station in wave band** (Only if no station list is available): Press and hold button  or  to select a station.

You can only store new stations using the corresponding feature on the radio. Refer to separate COMAND system operating instructions.

You can also operate the radio in the usual manner.

### Operating audio devices/audio media

- ▶ Switch on the COMAND system and select the audio device or audio media. Refer to



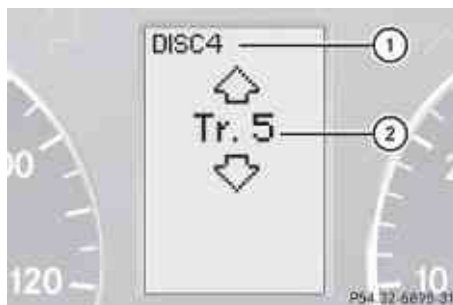

separate COMAND system operating instructions.

- ▶ Press button  or  repeatedly until the **Audio/DVD** menu appears in the multifunction display.





Example illustration

- ① Disc number
- ② Current track

- ▶ **Selecting next or previous track:** Press button  or  briefly.
- ▶ **Selecting a track from the track list (quick search):** Press and hold button  or .

The current track does not appear during Audio AUX mode operation.

### Operating video DVD

- ▶ Switch on the COMAND system and select DVD-Video. Refer to separate COMAND system operating instructions.
- ▶ Press button  or  repeatedly until the **Audio/DVD** menu appears in the multifunction display.

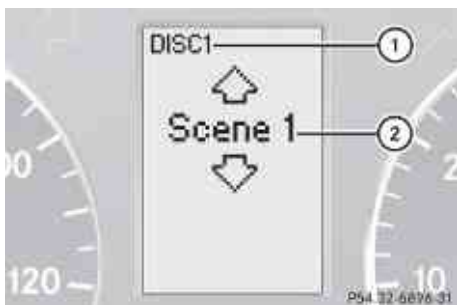



- ① Disc number
- ② Current scene

► Press button  or  to select a scene.

### Navigation menu

The **Navigation** menu contains the functions needed to operate your navigation system.

► Press button  or  repeatedly until the **Navigation** menu appears in the multifunction display.

The message shown in the multifunction display depends on the status of the navigation system:

- With the COMAND system switched off, the message NAVI Off appears in the multifunction display.
- With the COMAND system switched on but route guidance not activated, the direction of travel and, if applicable, the name of the street currently traveled on appear in the multifunction display.
- With the COMAND system switched on and route guidance activated, the direction of travel and maneuver instructions appear in the multifunction display.

Please refer to separate COMAND system operating instructions for instructions on how to activate the route guidance system.



### Vehicle status message memory menu

Use the **Vehicle status message memory** menu to scan malfunction and warning messages that may be stored in the memory. Such messages appear in the multifunction display and are based on conditions or system status the vehicle's system has recorded.

The **Vehicle status message memory** menu only appears if messages have been stored.

#### **Warning!**

Malfunction and warning messages are only indicated for certain systems and are intentionally not very detailed. The malfunction and warning messages are simply a reminder with respect to the operation of certain systems. They do not replace the owner's and/or driver's responsibility to maintain the vehicle's operating safety. Have all required maintenance and safety checks performed on the vehicle. Bring the vehicle to an authorized Mercedes-Benz Center to address the malfunction and warning messages.

► Press button  or  repeatedly until the **Vehicle status message memory** menu appears in the multifunction display. If conditions have occurred causing status messages to be recorded, the number of messages appears in the multifunction display.



- ① Number of recorded status messages



- ▶ Press button  or .

The stored messages will now be displayed in the order in which they have occurred.

For malfunction and warning messages, see “Vehicle status messages in the multifunction display” (▶ page 196).

- ▶ **i** After you have scrolled through all recorded status messages, the first recorded message appears again.

Should the vehicle’s system record any conditions while driving, the number of messages will reappear in the multifunction display when the SmartKey in the starter switch is turned to position **0** or removed from the starter switch.

Except for high-priority messages, the vehicle status message memory will be cleared when you switch off the ignition.

## Settings menu

### Introduction

In the Settings menu there are two functions: The function To reset: Press reset button for 3 secs., with which you can reset all the settings to the original factory settings and a collection of submenus with which you can make individual settings for your vehicle.

The following settings and submenus are available in the Settings menu:



- Resetting to factory settings (▶ page 103)
- Submenus in the Settings menu (▶ page 104)
- Instrument cluster submenu (▶ page 104)
- Lighting submenu (▶ page 106)
- Vehicle submenu (▶ page 108)
- Convenience submenu (▶ page 108)

### Resetting to factory settings

You can reset the functions of all submenus to the factory settings.

For safety reasons, the function Headlamp Mode in the Lighting submenu cannot be reset while driving.

The following message appears in the multifunction display: Cannot be completely reset to factory settings while driving.

- ▶ Press button  or  repeatedly until the Settings menu appears in the multifunction display.



- ▶ Press the reset button in the instrument cluster (▶ page 95) for approximately 3 seconds.



The request to press the reset button once more to confirm appears in the multifunction display.



- ▶ Press the reset button once more. The functions of all the submenus will be reset to factory settings.

The settings you have changed will not be reset unless you confirm the action by pressing the reset button a second time. After approximately 5 seconds, the Settings menu reappears in the multifunction display.

### Submenus in the Settings menu

▶ Press button  or  repeatedly until the Settings menu appears in the multifunction display.



▶ Press button .

The collection of the submenus appears in the multifunction display. There are more submenus than can be simultaneously displayed.





▶ Press button .

The selection marker moves to the next submenu.

▶ Scroll down with button , scroll up with button .

▶ With the selection marker on the desired submenu, use button  to access the individual functions within that submenu.

▶ Once within the submenu, use button  to move to the next function or button  to move to the previous function within that submenu.

▶ Use button  or  to change the settings of the respective function.

The following lists show what settings can be changed within the various menus. Detailed instructions on making individual settings can be found on the following pages.

### Instrument cluster submenu

- Selecting speedometer display mode (▷ page 105)
- Selecting language (▷ page 105)
- Selecting display (digital speedometer or outside temperature) for status indicator (▷ page 105)

### Lighting submenu

- Setting daytime running lamp mode (USA only) (▷ page 106)
- Setting locator lighting (▷ page 106)
- Setting night security illumination (Headlamps delayed shut-off feature) (▷ page 107)
- Setting interior lighting delayed shut-off (▷ page 108)

### Vehicle submenu

- Setting automatic central locking (▷ page 108)

### Convenience submenu

- Activating easy-entry/exit feature (▷ page 109)







### Instrument cluster submenu

Access the Inst. Cluster submenu via the Settings menu. Use the Inst. Cluster submenu to change the instrument cluster display settings.



The following functions are available:

- Selecting speedometer display mode (▷ page 105)
- Selecting language (▷ page 105)
- Selecting display (digital speedometer or outside temperature) for status indicator (▷ page 105)







### Selecting speedometer display mode

- ▶ Press button  or  repeatedly until the Settings menu appears in the multifunction display.
- ▶ Press button .
- ▶ Move the selection marker with button  or  to the Inst. Cluster submenu.
- ▶ Press button  or  repeatedly until the message Disp.Unit Speed-/Odom. appears in the multifunction display. The selection marker is on the current setting.





- ▶ Press button  or  to set speedometer unit to Km or Miles.







### Selecting language

- ▶ Press button  or  repeatedly until the Settings menu appears in the multifunction display.
- ▶ Press button .
- ▶ Move the selection marker with button  or  to the Inst. Cluster submenu.
- ▶ Press button  or  repeatedly until the message Language appears in the multifunction display. The selection marker is on the current setting.





- ▶ Press button  or  to select the language to be used for the multifunction display messages.

### Selecting display (digital speedometer or outside temperature) for status indicator

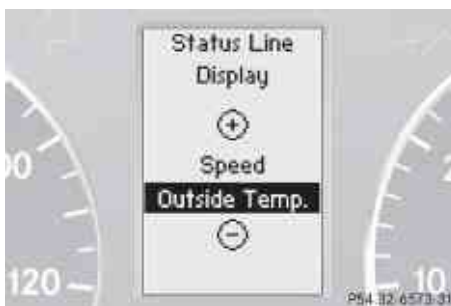
- ▶ Press button  or  repeatedly until the Settings menu appears in the multifunction display.
- ▶ Press button .
- ▶ Move the selection marker with button  or  to the Instr. Cluster submenu.
- ▶ Press button  or  repeatedly until the message Status Line Display appears in the multifunction display. The selection marker is on the current setting.



- ▶ Press button  or  to select the desired setting. The selected display is then shown continuously in the status indicator (lower display).

The other display now appears in the **Standard display** menu (▷ page 99).







### Lighting submenu

Access the Lighting submenu via the Settings menu. Use the Lighting submenu to change the lamp and lighting settings on your vehicle.



The following functions are available:

- Setting daytime running lamp mode (USA only) (▷ page 106)
- Setting locator lighting (▷ page 106)
- Setting night security illumination (▷ page 107)
- Setting interior lighting delayed shut-off (▷ page 108)

### Setting daytime running lamp mode (USA only)

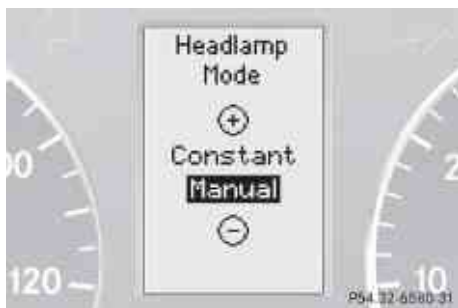
- ▶ Press button  or  repeatedly until the Settings menu appears in the multifunction display.
- ▶ Press button .
- ▶ Move the selection marker with button  or  to the Lighting submenu.
- ▶ Press button  or  repeatedly until the message **Headlamp Mode** appears in the multifunction display. The selection marker is on the current setting.



- ▶ Press button  or  to select manual operation (Manual) or daytime running lamp mode (Constant).

With daytime running lamp mode activated and the exterior lamp switch in position  or **AUTO**, the low-beam headlamps are switched on when the engine is running.

In low ambient light conditions the following lamps will come on additionally:

- Parking lamps
- Tail lamps
- License plate lamps
- Side marker lamps

For more information on the daytime running lamp mode, see “Lighting” (▷ page 73).

For safety reasons, changing the setting for the daytime running lamp mode is not possible while the vehicle is in motion.

The following message appears in the multifunction display:

Settings can only be made at a standstill.

For safety reasons, resetting all the functions of all submenus to the factory settings while driving (▷ page 103) will not deactivate the daytime running lamp mode.

### Setting locator lighting







With the locator lighting feature activated and the exterior lamp switch in position **AUTO**, the following lamps will come on during darkness when the vehicle is unlocked using button  on the SmartKey:

- Parking lamps
- Tail lamps
- License plate lamps
- Side marker lamps
- Front fog lamps



The locator lighting goes out when the driver's door is opened.

If you do not open the driver's door after unlocking the vehicle with the SmartKey, the

lamps will go out automatically after approximately 40 seconds.

- ▶ Press button  or  repeatedly until the Settings menu appears in the multifunction display.
- ▶ Press button .
- ▶ Move the selection marker with button  or  to the Lighting submenu.
- ▶ Press button  or  repeatedly until the message Surround Lighting appears in the multifunction display. The selection marker is on the current setting.



- ▶ Press button  or  to switch the locator lighting function On or Off.
- ▶ Turn the exterior lamp switch to position **AUTO** when exiting the vehicle. The locator lighting feature is activated.

### Setting night security illumination (Headlamps delayed shut-off feature)







Use this function to set whether you would like the exterior lamps to remain on for 15 seconds during darkness after exiting the vehicle and closing all doors.

With the headlamps delayed shut-off feature activated and the exterior lamp switch in position **AUTO** before the engine is turned off, the following lamps will come on when the engine is turned off:



- Parking lamps
- Tail lamps
- License plate lamps

- Side marker lamps
- Front fog lamps

If, after turning off the engine, you do not open a door or do not close an opened door, the lamps will automatically go out after 60 seconds.

- ▶ Press button  or  repeatedly until the Settings menu appears in the multifunction display.
- ▶ Press button .
- ▶ Move the selection marker with button  or  to the Lighting submenu.
- ▶ Press button  or  repeatedly until the message Headl. delay Switch Off appears in the multifunction display. The selection marker is on the current setting.









- ▶ Press button  or  to switch the headlamps delayed shut-off feature On or Off.
- ▶ Turn the exterior lamp switch to position **AUTO** before turning off the engine. The headlamps delayed shut-off feature is activated.

You can temporarily deactivate the headlamps delayed shut-off feature:



- ▶ Before exiting the vehicle, turn the SmartKey in the starter switch to position **0**.
- ▶ Then turn it to position **2** and back to position **0**.  
The headlamps delayed shut-off feature is deactivated. It will reactivate as soon as you start the engine.

### Setting interior lighting delayed shut-off

Use this function to set whether you would like the interior lighting to remain on for 10 seconds during darkness after you have removed the SmartKey from the starter switch.

- ▶ Press button  or  repeatedly until the Settings menu appears in the multifunction display.
- ▶ Press button .
- ▶ Move the selection marker with button  or  to the Lighting submenu.
- ▶ Press button  or  repeatedly until the message Interior Light Delay.Sw.Off appears in the multifunction display.  
The selection marker is on the current setting.









- ▶ Press button  or  to switch the interior lighting delayed shut-off feature On or Off.

### Vehicle submenu



Access the Vehicle submenu via the Settings menu. Use the Vehicle submenu to set the automatic central locking.

#### Setting automatic central locking

Use this function to activate or deactivate the automatic central locking. With the automatic central locking system activated, the vehicle is centrally locked at a vehicle speed of approximately 9 mph (15 km/h).

- ▶ Press button  or  repeatedly until the Settings menu appears in the multifunction display.
- ▶ Press button .
- ▶ Move the selection marker with button  or  to the Vehicle submenu.
- ▶ Press button  or  repeatedly until the message Automatic Door Lock appears in the multifunction display.  
The selection marker is on the current setting.



- ▶ Press button  or  to switch the automatic central locking On or Off.

### Convenience submenu

Access the Convenience submenu via the Settings menu. Use the Convenience submenu to activate the easy-entry/exit feature.

### Activating easy-entry/exit feature

Use this function to activate and deactivate the easy-entry/exit feature (▷ page 68).







#### **Warning!**

You must make sure no one can become trapped or injured by the moving steering wheel when the easy-entry/exit feature is activated.



To stop steering wheel movement do one of the following:

- Move steering wheel adjustment stalk.
- Press one of the memory position buttons.
- Press the memory button.

Do not leave children unattended in the vehicle, or with access to an unlocked vehicle. Children could open the driver's door and unintentionally activate the easy-entry/exit feature, which could result in an accident and/or serious personal injury.

- ▶ Press button  or  repeatedly until the Settings menu appears in the multifunction display.
- ▶ Press button .
- ▶ Move the selection marker with button  or  to the Convenience submenu.
- ▶ Press button  or  repeatedly until the message Easy-entry Function appears in the multifunction display. The selection marker is on the current setting.



- ▶ Press button  or  to switch the easy-entry feature On or Off.

### Trip computer menu

Use the **Trip computer** menu to call up statistical data on your vehicle.

The following information is available:

- Fuel consumption statistics since start (▷ page 109)
- Fuel consumption statistics since last reset (▷ page 110)
- Resetting fuel consumption statistics (▷ page 110)
- Distance to empty (▷ page 110)

When you enter the **Trip computer** menu, you will always see the fuel consumption statistics since start first.

### Fuel consumption statistics since start

- ▶ Press button  or  repeatedly until the message From Start appears in the multifunction display.

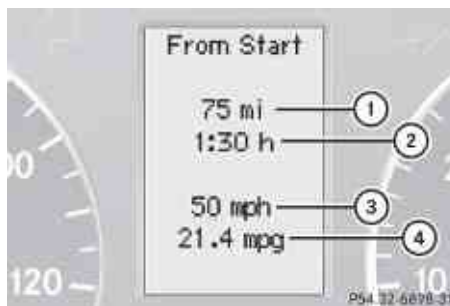





- ① Distance driven since start
- ② Time elapsed since start
- ③ Average speed since start
- ④ Average fuel consumption since start

All statistics stored since the last engine start will be reset approximately 4 hours after the SmartKey in the starter switch is turned to position **0** or removed from the starter switch.

Resetting will not occur if you turn the SmartKey back to position **1** or **2** within this time period.



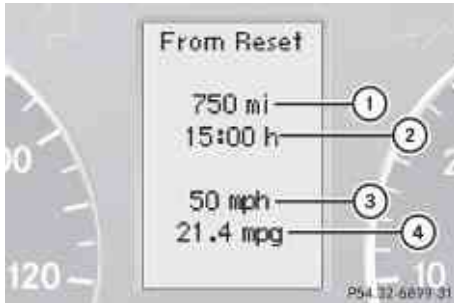

### Fuel consumption statistics since last reset

- ▶ Press button  or  repeatedly until the message From Start appears in the multifunction display.
- ▶ Press button  or  repeatedly until the message From Reset appears in the multifunction display.







- ① Distance driven since last reset
- ② Time elapsed since last reset
- ③ Average speed since last reset
- ④ Average fuel consumption since last reset

### Resetting fuel consumption statistics

- ▶ Press button  or  repeatedly until the message From Start appears in the multifunction display.
- ▶ Press button  or  repeatedly until the reading that you want to reset appears in the multifunction display.
- ▶ Press and hold the reset button in the instrument cluster until the respective values are reset to 0.

The fuel consumption statistics reset automatically to 0 after 99 999 miles or 9 999 hours, whichever occurs first.

### Distance to empty

- ▶ Press button  or  repeatedly until the message From Start appears in the multifunction display.
- ▶ Press button  or  repeatedly until the message Range: appears in the multifunction display.  
The calculated remaining driving range based on the current fuel tank level appears in the multifunction display.  
If only very little fuel is left in the tank, a fuel pump  appears instead of the remaining driving range.





### Telephone menu

#### Warning!

A driver's attention to the road must always be his/her primary focus when driving. For your safety and the safety of others, we recommend that you pull over to a safe location and stop before placing or taking a telephone call. If you choose to use the telephone while driving, please use the hands-free device and only use the telephone when weather, road and traffic conditions permit. Some jurisdictions prohibit the driver from using a mobile phone while driving a vehicle. Bear in mind that at a speed of just 30 mph (approximately 50 km/h), your vehicle is covering a distance of 44 feet (approximately 14 m) every second.



You can connect your telephone to the COMAND system via Bluetooth®, see separate COMAND system operating instructions.

- ▶ Switch on the COMAND system.  
Refer to separate COMAND system operating instructions.
- ▶ Press button  or  repeatedly until the message TEL appears in the multifunction display.  
One of the following messages will appear in the multifunction display:
  - No Service: No network is available.
  - Bluetooth Ready: The telephone has not been connected to the COMAND system via Bluetooth® yet.
    - ▶ Connect the telephone to the COMAND system via Bluetooth®.
  - Ready or name of the network provider (if available): The telephone has found a network and is ready for use. You can operate it using the control system.

### Answering a call

When your telephone is ready to receive calls, you can answer a call at any time. In the multifunction display you will then see the following message, or if available, the caller ID (number or name):







- ▶ Press button .  
You have answered the call.



### Ending a call or rejecting an incoming call

- ▶ Press button .

### Dialing a number from the phone book

When your telephone is ready to receive calls, you may select and dial a number from the phone book at any time.

- ▶ Press button  or  repeatedly until the message TEL appears in the multifunction display.
- ▶ Press button  or  repeatedly until the desired name appears in the multifunction display.

If you press and hold button  or  for longer than 1 second, the system scrolls rapidly through the list of names until you release the button again. The stored names are displayed in alphabetical order.

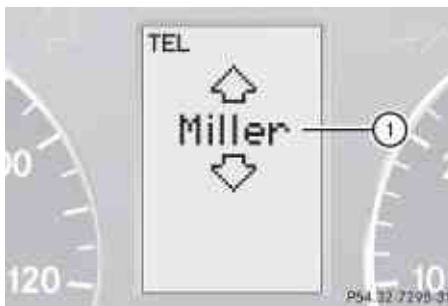

- ① Selected name from the phone book

- ▶ Press button .  
The control system dials the selected phone number.  
If the connection is successful and this feature is supported by your network provider, the name of the party (if stored in your phone book) you are calling will appear in the multifunction display.

The control system stores the dialed number in the redial memory.







or

- ▶ Press button  if you do not want to make the call.

**Controls in detail**

### Redialing

The control system stores the most recently dialed phone numbers. This eliminates the need to search through your entire phone book.

- ▶ Press button  or  repeatedly until the message TEL appears in the multifunction display.
- ▶ Press button . The first number in the redial memory appears in the multifunction display.
- ▶ Press button  or  repeatedly until the desired number or name appears in the multifunction display.
- ▶ Press button . The control system dials the selected phone number.

### Driving systems

#### Introduction

- Cruise control
- All-wheel drive (4MATIC)
- Rear Parking Assist
- Rear view camera

The ABS, BAS, EBB, ESP® and 4-ETS driving safety systems are described in the “Safety and security” section (▶ page 50).

#### Cruise control

The cruise control maintains the speed you set for your vehicle automatically.

The use of the cruise control is recommended for driving at a constant speed for extended periods of time.

The currently set speed or last set speed (“Resume” function) appears in the multifunction display for approximately 2 seconds.

- i** The cruise control should not be activated during off-road driving.

#### Warning!

The cruise control is a convenience system designed to assist the driver during vehicle operation. The driver is and must always remain responsible for the vehicle’s speed and for safe brake operation.

Only use the cruise control if the road, traffic, and weather conditions make it advisable to travel at a constant speed.

- The use of the cruise control can be dangerous on winding roads or in heavy traffic because conditions do not allow safe driving at a constant speed.
- The use of the cruise control can be dangerous on slippery roads. Rapid changes in tire traction can result in wheel spin and loss of control.
- Deactivate the cruise control when driving in fog.

The “Resume” function should only be operated if the driver is fully aware of the previously set speed and wishes to resume this particular preset speed.



- ① Setting current or higher speed
- ② Setting current or lower speed
- ③ Canceling the cruise control
- ④ Resume to last set speed

### Activating cruise control

You can activate the cruise control at a vehicle speed above 20 mph (30 km/h).

You cannot activate the cruise control

- when you brake
- when you have engaged the parking brake
- when the automatic transmission is in park position **P**, reverse gear **R**, or neutral position **N**
- the ESP® is switched off or has switched off due to a malfunction

### Setting current speed

- ▶ Accelerate or decelerate to the desired speed.
- ▶ Briefly lift the cruise control lever in direction of arrow ① or press in direction of arrow ②.
- ▶ Remove your foot from the accelerator pedal.

**i** On uphill or downhill grades, the cruise control may not be able to maintain the set speed. Once the grade eases, the set speed will be resumed.

### Canceling cruise control

- ▶ Depress the brake pedal.

or

- ▶ Briefly push the cruise control lever in direction of arrow ③.

The last set speed is stored for later use.

The last stored speed is deleted from memory when the engine is turned off.

The cruise control also switches off automatically when

- the vehicle speed falls below 20 mph (30 km/h)
- the ESP® is in operation
- the ESP® is switched off with the ESP® switch
- the ESP® has switched off due to a malfunction
- you shift the automatic transmission into neutral position **N** while driving

Depressing the accelerator pedal does not deactivate the cruise control. After a brief acceleration (e.g. for passing), the cruise control will resume the last set speed.

### Changing the set speed

#### **Warning!**

Keep in mind that it may take a brief moment until the vehicle has made the necessary adjustments.

Increase or decrease the set vehicle speed to a value that the prevailing road conditions and legal speed limits permit. Otherwise, sudden and unexpected acceleration or deceleration of the vehicle could cause an accident and/or serious injury to you and others.

When you use the cruise control lever to decelerate, the transmission will automatically downshift if the engine's braking power does not brake the vehicle sufficiently.

- ▶ **Increasing:** Lift the cruise control lever in direction of arrow ① and hold it up until the desired speed is reached.
- ▶ **Decreasing:** Press the cruise control lever in direction of arrow ② and hold it down until the desired speed is reached.
- ▶ Release the cruise control lever.  
The new speed is set and the vehicle will accelerate or decelerate.

#### Fine adjustment in 1 mph (Canada: 1 km/h) increments

- ▶ **Increasing:** Briefly tip the cruise control lever in direction of arrow ①.
- ▶ **Decreasing:** Briefly tip the cruise control lever in direction of arrow ②.

#### Setting stored speed (Resume function)

##### **Warning!**

The set speed stored in memory should only be set again if prevailing road conditions and legal speed limits permit. Possible acceleration or deceleration differences arising from returning to the preset speed could cause an accident and/or serious injury to you and others.

- ▶ Briefly pull the cruise control lever in direction of arrow ④.
- ▶ Remove your foot from the accelerator pedal.

The last stored speed is deleted from memory when the engine is turned off.

#### Hill start assist system

##### **Warning!**

The hill start assist system is not designed to function as a parking brake. It does not prevent the vehicle from moving when parked on an incline.

Always engage the parking brake in addition to shifting the automatic transmission into park position **P**.

On uphill grades, the hill start assist system maintains the pressure in the brake system for approximately 1 second after you have released the brake pedal. Therefore, you can start off smoothly without the vehicle moving immediately after releasing the brake pedal.

- ▶ Depress the brake pedal.
- ▶ Shift the automatic transmission into drive position **D** or reverse gear **R**.
- ▶ Release the brake pedal.
- ▶ Carefully depress the accelerator pedal.

The hill start assist system is inactive

- when starting off on a level road or downhill grades
- with the automatic transmission in neutral position **N**
- with the parking brake engaged
- if the ESP<sup>®</sup> has switched off due to a malfunction

#### All-wheel drive (4MATIC)

Your vehicle is equipped with all-wheel drive (4MATIC). Both, the front and rear axle, are powered at all times when the vehicle is being operated. The 4MATIC improves traction in conjunction with the ESP<sup>®</sup> (▷ page 52) and the Electronic Traction System (4-ETS) (▷ page 53).

##### **Warning!**

If a drive wheel is spinning due to insufficient traction:

- While driving off, apply as little throttle as possible.
- While driving, ease up on the accelerator pedal.
- Adapt your speed and driving style to the prevailing road conditions.

Failure to observe these guidelines could cause the vehicle to skid.

The 4MATIC cannot prevent accidents resulting from excessive speed.

- !** When towing the vehicle with all wheels on the ground, the gear selector lever must be in neutral position **N** and the SmartKey must be in starter switch position **2**.

When towing the vehicle with all wheels on the ground, the vehicle may be towed only for distances up to 30 miles (50 km) and at a speed not to exceed 30 mph (50 km/h). If the vehicle is towed with one axle raised (observe instructions regarding flexible drive shaft and propeller shafts), the engine must be shut off and the SmartKey must be in starter switch position **1**. Otherwise, the 4-ETS may become engaged which may cause loss of towing control.

- !** Only conduct operational or performance tests on a two-axle dynamometer. If such tests are necessary, contact an authorized Mercedes-Benz Center. You could otherwise seriously damage the brake system and/or the transfer case which is not covered by the Mercedes-Benz Limited Warranty.

- i** In winter operation, the maximum effectiveness of the 4MATIC is only achieved with winter tires (> page 175) or snow chains as required.

### Rear Parking Assist system

The Rear Parking Assist system is an electronic parking aid with ultrasonic sensors designed to assist the driver during parking maneuvers. It indicates the relative distance between the rear of the vehicle and an obstacle visually and audibly.

The Rear Parking Assist system is activated automatically when you switch on the ignition

and the automatic transmission is in reverse gear **R**.

The Rear Parking Assist system monitors the rear surroundings of your vehicle with four sensors in the rear bumper.

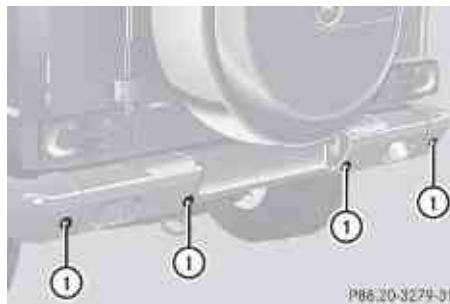

To function properly, sensors ① must be free of dirt, ice, snow and slush. Clean sensors ① regularly, being careful not to scratch or damage sensors ①, see “Cleaning the Rear Parking Assist system sensors” (> page 190).

#### **Warning!**

The Rear Parking Assist is a supplemental system. It is not intended to, nor does it replace, the need for extreme care. The responsibility during parking and other critical maneuvers always remains with the driver.

#### **Warning!**

Make sure no persons or animals are in or near the area in which you are parking/ maneuvering. Otherwise, they could be injured.

- !** Special attention must be paid to objects with smooth surfaces or low silhouettes (e.g. trailer couplings, painted posts, elevated crossbars or road curbs). Such objects may not be detected by the system and can damage the vehicle.

During parking maneuvers, pay special attention to objects located above or below the height of the sensors (e.g. street curbs, painted posts, or trailer hitches etc.). The Rear Parking Assist system will not detect

such objects at close range and damage to your vehicle or the object may result.

**!** Ultrasonic signals from outside sources (e.g. truck air brakes, car wash, or jackhammers) may impair the operation of the Rear Parking Assist system.

### Range of the sensors

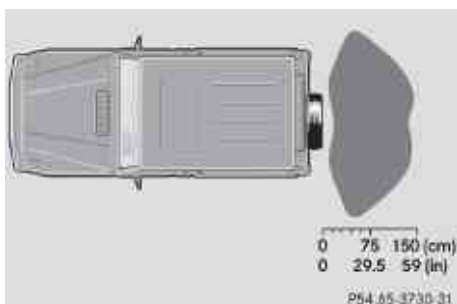
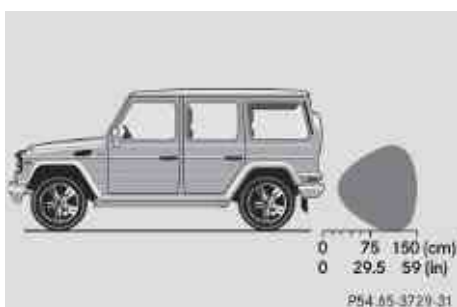

### Sensors

Center	approx. 59 in (150 cm)
Corners	approx. 40 in (100 cm)

### Minimum distance

Center	approx. 8 in (20 cm)
Corners	approx. 8 in (20 cm)

If the Rear Parking Assist system detects an obstacle in this range, all the distance warning segments illuminate and you hear a warning signal. If the obstacle is closer than the minimum distance, the actual distance

may no longer be indicated by the Rear Parking Assist system.

### Warning indicators

Visual signals indicate to the driver the relative distance between the sensors and an obstacle.



The warning indicator is divided into four yellow and two red distance segments ①. The Rear Parking Assist system is ready to measure when you hear a signal and readiness indicator ② is illuminated.

As your vehicle approaches an object, one or more distance segments ① will illuminate, depending on the distance. When the sixth distance segment illuminates, you have reached the minimum distance.

An intermittent acoustic warning will sound when the fourth yellow distance segment illuminates. This signal quickens with each additional distance segment lit. When the sixth distance segment illuminates, the acoustic warning becomes a constant signal. The signal is canceled when the automatic transmission is shifted into drive position **D**, or park position **P**.

### Rear Parking Assist system malfunction

If no distance segments illuminate and no acoustic warning sounds, there is a malfunction in the Rear Parking Assist system.

- ▶ Have the Rear Parking Assist system checked at an authorized Mercedes-Benz Center as soon as possible.

### Rear view camera

The rear view camera is an optical parking aid. The area behind the vehicle appears in the COMAND system display as a mirror image, like in the rear view mirror.

#### **Warning!**

Make sure no persons or animals are in or near the area in which you are parking/maneuvering. Otherwise, they could be injured.

#### **Warning!**

The rear view camera is only an aid and may display obstacles from a distorted perspective or inaccurately, or may not display obstacles at all. The rear view camera does not relieve you of the responsibility to be cautious, take care and pay careful attention. The rear view camera may not show objects which are

- very close to the rear bumper
- under the rear bumper
- under the spare wheel
- nearby behind the spare wheel

You are responsible for safety at all times and must continue to pay attention to the immediate surroundings when parking and maneuvering. This includes the area behind, in front of, and beside the vehicle. Otherwise you could endanger yourself and/or others.

#### **Warning!**

The rear view camera either will not function or will not function to its full capability if

- the tailgate is open
- it is raining very hard, snowing or foggy
- it is night or you are parking/maneuvering your vehicle in an area where it is very dark
- the camera is exposed to a very bright white light
- the immediate surroundings are illuminated with fluorescent light (the display may flicker)
- there is a sudden change in temperature, e.g. if you drive into a heated garage from the cold (lens condensation)
- the camera lens is dirty or covered
- the rear of your vehicle is damaged

In this case, have the position and setting of the camera checked by a qualified specialist workshop. Mercedes-Benz recommends that you contact a Mercedes-Benz Center for this purpose.

Do not use the rear view camera in these situations. Otherwise you could injure yourself or others and/or damage property including your vehicle while parking/maneuvering.



Camera lens ① must be free of dirt, ice, snow, and slush to function properly. Clean the camera lens regularly. Being careful not to scratch or damage the camera lens, see

“Cleaning the rear view camera lens”  
(▷ page 190).

### Switching on/off

- ▶ **Switching on:** Switch on the ignition.
  - ▶ Switch on the COMAND system.
  - ▶ Shift the automatic transmission to reverse gear **R**.  
The area behind the vehicle appears in the COMAND system display.
- i** The image from the rear view camera will no longer be displayed if you select another

function on the COMAND system while reverse gear **R** is engaged. To display the image again, disengage and reengage reverse gear **R**.

- ▶ **Switching off:** Shift the automatic transmission into park position **P**, neutral position **N**, or drive position **D**.
- or
- ▶ Select another function on the COMAND system.





Climate control system



Control panel

Climate control



Controls in detail

Function	Recommendation/Notes	
① Air volume control		(▷ page 123)
Climate control on/off	<b>i</b> Switches on the climate control system.	(▷ page 121)
② Temperature control, driver's side	<b>i</b> Set the temperature to 72°F (22°C).	(▷ page 121)
③ Temperature control, passenger side	<b>i</b> Set the temperature to 72°F (22°C).	(▷ page 121)
④ Air distribution control		(▷ page 123)
⑤  Rear window defroster (USA only)		(▷ page 125)
 Rear window defroster (Canada only)		

	Function	Recommendation/Notes	
⑥	AC cooling on/off	<b>i</b> Switches on the air conditioning. The indicator lamp in button  comes on.	(▷ page 121)
	Residual heat/ventilation	<b>i</b> With the engine turned off, it is possible to continue to heat or ventilate the interior.	(▷ page 124)
⑦	Air distribution and air volume (automatic mode)		(▷ page 121)
⑧	Air recirculation	<b>i</b> Only use this function for a short time, e.g. in a tunnel. Otherwise, the windows can fog up due to lack of fresh air.	(▷ page 124)
⑨	 Front defroster (USA only)	<b>i</b> Keep this setting selected only until the windshield or the side windows are clear again.	(▷ page 123)
	 Front defroster (Canada only)		

### Notes on climate control system

The climate control system is operational whenever the engine is running. You can operate the climate control system in either the automatic or manual mode. The system cools or heats the interior depending on the selected interior temperature and the current outside temperature.

It can only function optimally when you are driving with the windows and the tilt/sliding sunroof closed.

Nearly all dust particles, pollutants and odors are filtered out before outside air enters the passenger compartment through the air distribution system.

#### **Warning!**

Severe conditions (e.g. strong air pollution) may require replacement of the filter before its scheduled replacement interval. A clogged filter will reduce the air volume to the interior and the windows could fog up, impairing visibility and endangering you and others. Have a clogged filter replaced as soon as

possible at an authorized Mercedes-Benz Center.

The air conditioning will not engage (no cooling) if the **A/C** mode (▷ page 121) is deactivated.

#### **Warning!**

Follow the recommended settings for heating and cooling given on the following pages. Otherwise the windows could fog up, impairing visibility and endangering you and others.

- ▶ Keep the air intake grille in front of the windshield free of snow and debris.

- i** If the vehicle interior is hot, ventilate the interior before driving off, see “Summer opening feature” (▷ page 82). The climate control will then adjust the interior temperature to the set value much faster.

### Deactivating the climate control system

- ▶ **Deactivating:** Set air volume control ① (▷ page 119) to position 0.
- ▶ **Reactivating:** Set air volume control ① to any speed.  
The previous settings are once again in effect.

### Air conditioning

The air conditioning is operational while the engine is running and cools the interior air to the temperature set by the operator. In addition, the air conditioning dehumidifies the interior air and helps prevent window fogging.

#### **Warning!**

If you switch off the cooling function, the vehicle will not be cooled when weather conditions are warm. The windows can fog up more quickly. Window fogging may impair visibility and endanger you and others.

- ① Condensation may drip out from underneath the vehicle. This is normal and not an indication of a malfunction.

### Deactivating

It is possible to deactivate the air conditioning. The interior air will then no longer be cooled or dehumidified.

- ▶ Press button .  
The indicator lamp in the button goes out.  
The cooling function switches off after a short delay.

### Activating

Moist air can fog up the windows. You can dehumidify the interior air with the air conditioning.

- ▶ Press button .  
The indicator lamp in the button comes on.

The air conditioning uses the refrigerant R134a. This refrigerant is free of CFCs which are harmful to the ozone layer.

- ❗ If the air conditioning cannot be activated again, this indicates that the air conditioning is losing refrigerant. The compressor has turned off.  
Have the air conditioning checked at the nearest authorized Mercedes-Benz Center.



### Automatic mode

When operating the climate control system in automatic mode, the interior air temperature, air volume and air distribution are adjusted automatically.

In automatic mode, cooling with dehumidification is switched on. This function can be switched off if necessary.

#### **Warning!**

If you switch off the cooling function, the vehicle will not be cooled when weather conditions are warm. The windows can fog up more quickly. Window fogging may impair visibility and endanger you and others.

- ▶ Set the desired temperature (▷ page 121).
- ▶ **Activating:** Press button .  
The indicator lamp in the button comes on.  
The air volume and air distribution are adjusted automatically.
- ▶ **Deactivating:** Press button  again.  
The indicator lamp in the button goes out.  
Automatic control of air volume and air distribution are switched off.

### Setting temperature

You can adjust the air temperature on each side of the passenger compartment. You should raise or lower the temperature setting in small increments, preferably starting at 72°F (22°C).

- **Increasing/decreasing:** Turn temperature control ② and/or ③ (► page 119) slightly clockwise or counterclockwise.

- ❗ If you turn the temperature control fully clockwise or counterclockwise for one side of the vehicle, you are increasing or decreasing the temperature for the other side of the vehicle as well.

### Adjusting air vents

#### ⚠ Warning!

When operating the climate control, the air that enters the passenger compartment through the air vents can be very hot or very cold (depending on the set temperature). This may cause burns or frostbite to unprotected skin in the immediate area of the air vents.

Always keep sufficient distance between unprotected parts of the body and the air vents. If necessary, use the air distribution adjustment to direct the air to air vents in the vehicle interior that are not in the immediate area of unprotected skin.

For best possible performance of the climate control:

- Keep the air intake grille in front of the windshield free of snow, leaves, sticks, and any other debris.
- Always keep all air vents and grilles in the passenger compartment free from obstruction.
- ❗ For draft-free ventilation, move the adjustable center and side air vents to the middle position.

### Center air vents

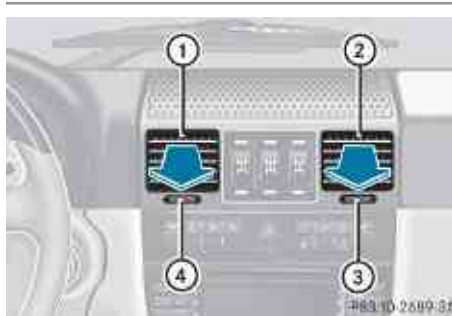

- ① Left center air vent, adjustable
- ② Right center air vent, adjustable
- ③ Thumbwheel for air volume control for adjustable right center air vent
- ④ Thumbwheel for air volume control for adjustable left center air vent

- **Opening/closing:** Turn thumbwheels ③ and ④ in the required direction.

### Side air vents



Example illustration passenger side

- ① Right side defroster air vent, fixed
- ② Right side air vent, adjustable
- ③ Thumbwheel for air volume control for adjustable right side air vent

- **Opening/closing:** Turn thumbwheel ③ in the required direction.

### Rear center console air vents

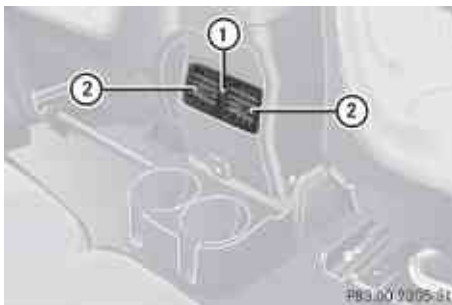

- ① Thumbwheel for air volume control for rear center air vents
- ② Right rear center air vent, adjustable
- ③ Left rear center air vent, adjustable

► **Opening/closing:** Turn thumbwheel ① upward or downward.

### Adjusting air distribution

The symbols on the control represent the following functions:

Symbol	Function
	Directs air to the windshield and through the side defroster air vents
	Directs air into the entire vehicle interior
	Directs air to the footwells and through the side air vents
	Directs air through the center and side air vents

The air distribution can be adjusted manually.

- Turn air distribution control ④ (▷ page 119) to the desired symbol. The air distribution is adjusted according to the chosen setting.

<sup>4</sup> USA only

<sup>5</sup> Canada only

You can also turn the control to a position between two symbols.

### Adjusting air volume

- **Decrease/increase:** Turn air volume control ① (▷ page 119) clockwise or counterclockwise.

### Front defroster

You can use this setting to defrost the windshield, for example if it is iced up.

You can also defog the windshield and the side windows.

- i** Keep this setting selected only until the windshield or the side windows are clear again.

- **Activating:** Press button <sup>4</sup> or <sup>5</sup>. The indicator lamp in the button comes on.

The climate control switches to the following functions automatically:

- cooling on to dehumidify
- most efficient blower speed and heating power, depending on outside temperature
- air flows onto the windshield and the front side windows
- the air recirculation mode is switched off

- i** If you have activated on the defrost function with button or , you cannot make any other settings.

- **Deactivating:** Press button or again.

The indicator lamp in the button goes out.



The previous settings are once again in effect.

## 124 Front windshield defroster

**Windshield fogged on the outside**

- ▶ Switch the windshield wipers on (▷ page 79).

If the automatic mode of the climate control is switched off:

- ▶ Turn air distribution control to position  or .

**Air recirculation mode**

Switch to air recirculation mode to prevent unpleasant odors from entering the vehicle from the outside (e.g. before driving through a tunnel). This setting cuts off the intake of outside air and recirculates the air in the passenger compartment.

**⚠ Warning!**

Fogged windows impair visibility, endangering you and others. If the windows begin to fog on the inside, switching off the air recirculation mode immediately should clear interior window fogging. If interior window fogging persists, make sure the air conditioning is activated, or press button

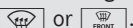

- ▶ **Activating:** Press button . The indicator lamp in the button comes on.

- i** The air recirculation mode is activated automatically at high outside temperatures.

The indicator lamp in button  is not lit when the air recirculation mode is switched on automatically.

If the air conditioning has been turned off or the outside temperature is below 41°F (5°C), the air recirculation mode will not switch on automatically.

A quantity of outside air is added after approximately 30 minutes.



- ▶ **Deactivating:** Press button  again. The indicator lamp in the button goes out.

- i** The manually selected air recirculation mode is deactivated automatically:
  - after 5 minutes if the outside temperature is below approximately 41°F (5°C)
  - after 5 minutes if the air conditioning is turned off
  - after 30 minutes if the outside temperature is above approximately 41°F (5°C)

**Residual heat and ventilation**

With the engine switched off, it is possible to continue to heat or ventilate the interior for up to 30 minutes. This feature makes use of the residual heat produced by the engine.

- i** How long the system will provide heating depends on the coolant temperature and the selected temperature. The blower will run at low speed regardless of the air distribution control setting.

- ▶ **Activating:** Switch off the ignition.
- ▶ Press button . The indicator lamp in the button comes on.
- ▶ **Deactivating:** Press button . The indicator lamp in the button goes out.

The residual heat is deactivated automatically:

- when the ignition is switched on
- after approximately 30 minutes
- if the battery voltage drops
- if the coolant temperature is too low

**Front windshield defroster**

The windshield defroster uses a large amount of power. To keep battery drain to a minimum, switch off the windshield defroster as soon as the windshield is clear.

The windshield defroster switches off automatically after 10 minutes.

If you switch on the windshield defroster for the fourth time in succession, it will switch off automatically after 5 minutes.

You cannot switch on the windshield defroster if the outside temperature is above 50°F (10°C).

#### **Warning!**

Any accumulation of snow and ice should be removed from the windshield before driving. Visibility could otherwise be impaired, endangering you and others.



- ▶ Switch on the ignition.
- ▶ **Switching on:** Press windshield defroster switch ①.  
Indicator lamp ② comes on.
- ▶ **Switching off:** Press windshield defroster switch ① once more.  
Indicator lamp ② goes out.

**!** If too many electrical consumers are operating simultaneously and there is insufficient voltage in the battery, indicator lamp ② in windshield defroster switch ① starts flashing. After approximately 30 seconds the system responds automatically by switching the windshield defroster off.

<sup>6</sup> USA only





<sup>7</sup> Canada only

### Rear window defroster

#### **Warning!**

Any accumulation of snow and ice should be removed from the rear window before driving. Visibility could otherwise be impaired, endangering you and others.

The rear window defroster uses a large amount of power. To keep the battery drain to a minimum, switch off the defroster as soon as the rear window is clear. The defroster is switched off automatically after approximately 6 to 17 minutes of operation depending on the outside temperature.

- ▶ Switch on the ignition.
- ▶ **Switching on:** Press button <sup>6</sup> or <sup>7</sup> on the respective climate control panel. The indicator lamp in the button comes on.
- ▶ **Switching off:** Press button  or  again.
- ▶ Switch off consumers that are currently not needed if required.

As soon as the battery has sufficient voltage, the rear window defroster switches back on automatically.

### Power tilt/sliding sunroof

#### Opening and closing

#### **Warning!**

When closing the tilt/sliding sunroof, make sure there is no danger of anyone being harmed by the closing procedure.

The opening procedure of the tilt/sliding sunroof can be immediately halted by releasing the sunroof switch or, if the sunroof switch was moved past the resistance point and released, by moving the sunroof switch in any direction.

The closing procedure of the tilt/sliding sunroof can be immediately halted by releasing the sunroof switch. The closing procedure of the tilt/sliding sunroof can be immediately reversed by moving the sunroof switch in direction ① or ④.

In a vehicle rollover, occupants not wearing their seat belts or not wearing them properly may be thrown out of the opening. Such an opening also presents a potential for injury for occupants wearing their seat belts properly as entire body parts or portions of them may protrude from the passenger compartment.

 **Observe Safety notes, see page 44.**

 The tilt/sliding sunroof can be opened or closed manually should an electrical malfunction occur (▷ page 223).

 To avoid damaging the seals, do not transport any objects with sharp edges which can stick out of the tilt/sliding sunroof.

Do not open the tilt/sliding sunroof if there is snow or ice on the roof, as this could result in malfunctions.

If you cannot open or close the tilt/sliding sunroof due to a malfunction contact Roadside Assistance or an authorized Mercedes-Benz Center.

 Please keep in mind that weather conditions can sometimes change rapidly. Make sure to close the tilt/sliding sunroof when leaving the vehicle. If water enters the vehicle interior, vehicle electronics could be damaged which is not covered by the Mercedes-Benz Limited Warranty.

 You can also open or close the tilt/sliding sunroof using the SmartKey, see “Summer opening feature” (▷ page 82) and “Convenience closing feature” (▷ page 82).



Sunroof switch

- ① Raising
- ② Lowering
- ③ Closing
- ④ Opening

- ▶ Switch on the ignition.
- ▶ **Opening, closing, raising and lowering manually:** Move and hold the sunroof switch to the resistance point in direction of arrow ① to ④.
- ▶ Release the sunroof switch when the desired position is reached.
- ▶ **Express opening:** To open the tilt/sliding sunroof completely, move the sunroof switch past the resistance point in direction of arrow ④ and release.
- ▶ **Stopping during express opening:** Move the sunroof switch in any direction.

## Loading and storing

### Loading instructions

#### **Warning!**

Always fasten items being carried as securely as possible using cargo tie-down rings and fastening materials appropriate for the weight and size of the load.

In an accident, during hard braking or sudden maneuvers, loose items will be thrown around inside the vehicle. This can cause injury to



vehicle occupants unless the items are securely fastened in the vehicle.

To help avoid personal injury during a collision or sudden maneuver, exercise care when transporting cargo. Do not pile luggage or cargo higher than the seat backrests.

Never drive a vehicle with the tailgate open. Deadly carbon monoxide (CO) gases may enter vehicle interior resulting in unconsciousness and death.

### Load distribution

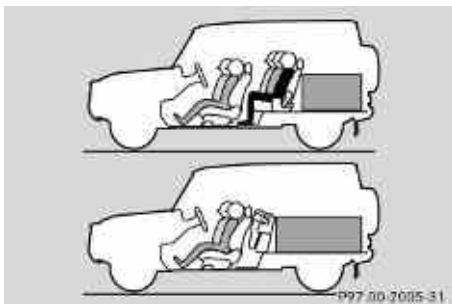

The Gross Vehicle Weight (GVW) which is the weight of the vehicle including

- fuel
- tools
- spare wheel
- installed accessories
- passengers
- luggage/cargo

It must never exceed the load limit and the Gross Vehicle Weight Rating (GVWR) for your vehicle. The load limit and the GVWR are specified on the placard located on the driver's door B-pillar (▷ page 246).

In addition, the load must be distributed so that the weight on each axle never exceeds the Gross Axle Weight Rating (GAWR) for the front and rear axle. The GVWR and GAWR for your vehicle are indicated on the certification label located on the driver's door B-pillar (▷ page 246).

For more information, see "Tire and Loading Information" (▷ page 161).

The handling characteristics of a fully loaded vehicle depend greatly on the load distribution. It is therefore recommended to load the vehicle according to the illustration shown. The heaviest items are to be placed towards the front of the vehicle.

- ❗ The cargo compartment is the preferred place to carry objects. The expanded cargo volume (▷ page 128) should only be used for items which do not fit in the cargo compartment alone.

Please pay attention to and comply with the following instructions when loading the vehicle and transporting cargo:

- Always pad off sharp edges.
- Always place items being carried against front or rear seat backrests, and fasten them as securely as possible.
- The heaviest portion of the cargo should always be kept as low as possible against front or rear seat backrests.



For additional safety when transporting cargo while the rear seats are unoccupied, fasten the outer seat belts crosswise into the opposite side buckles ①.

### Roof rack

This vehicle is not intended to carry items on its roof. Thus roof rails and any roof-mounted devices must not be used.

#### **Warning!**

Do not load items on the roof. It may cause instability during some maneuvers which could result in an accident.

### Parcel net

#### **Warning!**

Parcel nets are intended for storing light-weight items only, such as road maps, mail, etc.

Heavy objects, objects with sharp edges, or fragile objects may not be transported in the parcel nets. In an accident, during hard braking, or sudden maneuvers, they could be thrown around inside the vehicle and cause injury to vehicle occupants.

Parcel nets cannot protect transported goods in the event of an accident.

A parcel net is located in the front passenger footwell.

### Cargo tie-down rings

Your vehicle is equipped with four cargo tie-down rings.

Always follow loading instructions (▷ page 126).

Carefully secure cargo by applying even load on all cargo tie-down rings with rope of sufficient strength to hold down the cargo.



### Expanding cargo volume

To expand the cargo volume, you can fold the left and right rear seat backrests and the rear seat bench forward.

#### **Warning!**

Always lock seat backrest in its upright position when the rear seat bench is occupied, or the extended cargo volume is not in use.

Check for secure locking by pushing and pulling on the seat backrest.

In an accident, during hard braking or sudden maneuvers, loose items will be thrown around inside the vehicle. This can cause injury to vehicle occupants unless the items are securely fastened in the vehicle.

To help avoid personal injury during a collision or sudden maneuver, exercise care when transporting cargo.

#### **Warning!**

Never drive a vehicle with the tailgate open. Deadly carbon monoxide (CO) gases may enter vehicle interior resulting in unconsciousness and death.

#### **Warning!**

Failure to assure that the seat bench and seat backrests are locked into place could result in an increased chance of injury in an accident.

Never place hands under seat or near any moving parts while a seat is being adjusted. For safety reasons, the rear seat bench must only be adjusted when the vehicle is stationary.

Never drive a vehicle with the tailgate open. Deadly carbon monoxide (CO) gases may enter vehicle interior resulting in unconsciousness and death.

- ❗ Before folding the rear seat backrest and the rear seat bench forward, make sure that all containers in the rear cup holder are removed.

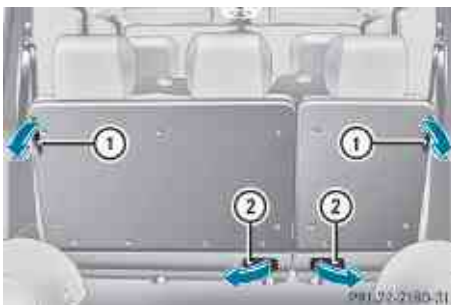

- ▶ **Folding rear seat backrest:** Pull release lever ① in direction of arrow and fold the rear seat backrest forward until it locks into place.
- ▶ **Folding rear seat bench:** Remove the middle rear seat head restraint (> page 65).
- ▶ If necessary, pull the driver's and/or front passenger seat forward.
- ▶ Fold the rear seat backrests forward.
- ▶ Pull release lever ② in direction of arrow.
- ▶ Fold the rear seat bench forward.
- ▶ Adjust front seats to desired position.
- ▶ **Returning rear seat bench to original position:** Fold the rear seat bench together with the rear seat backrest rearward until it locks into place.
- ▶ Install the middle rear seat head restraint (> page 65).

- ▶ **Returning rear seat backrest to original position:** Relieve the tension on the rear seat backrest and pull release lever ①.
- ▶ Raise the rear seat backrest until it locks into place.
- ❗ Make sure that the seat belt is not pinched when folding rear seat backrest.
- ▶ Check for secure locking by pushing and pulling on the rear seat backrest.

### Cargo compartment cover blind

The cargo compartment cover blind can be installed behind the rear seat bench.

- ❗ With the cargo compartment cover blind installed, do not pile luggage higher than the lower edges of the rear side windows.

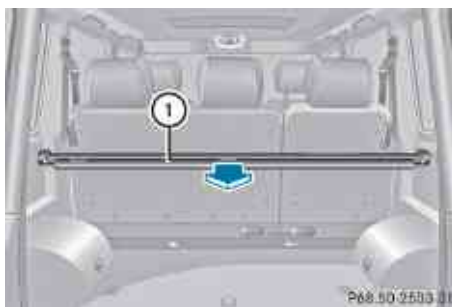

- ▶ **Rolling out:** Grip the blind strap and pull cargo compartment cover blind ① rearward across the cargo compartment.
- ▶ Engage cargo compartment cover blind ① into the mounts to the left and right of the tailgate.
- ▶ **Rolling up:** Disengage cargo compartment cover blind ① from the mounts and guide retraction.

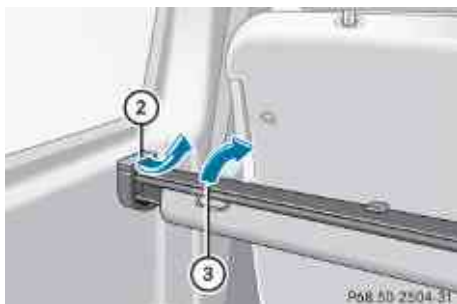

- ▶ **Removing:** Roll up cargo compartment cover blind (3).
- ▶ Open latch (2) on the right and left side of cargo compartment cover blind (3) in direction of the arrow.
- ▶ Pull cargo compartment cover blind (3) out upwards.
- ▶ **Installing:** Open latch (2) on the right and left side.
- ▶ Place cargo compartment cover blind (3) into recesses.
- ▶ Press the right and left side of cargo compartment cover blind (3) down until it locks into place.
- ▶ Close latch (2) on the right and left side.
- ▶ Make sure the blind is securely fastened.

### Storage compartments

#### **Warning!**

To help avoid personal injury during a collision or sudden maneuver, exercise care when storing objects in the vehicle. Put luggage or cargo in the cargo compartment if possible. Do not pile luggage or cargo higher than the seat backrests.

Parcel nets cannot secure hard or heavy objects.

Keep compartment lids closed. This will help to prevent stored objects from being thrown about and injuring vehicle occupants during

- braking
- vehicle maneuvers
- an accident

#### **Warning!**

Do not load items on the roof. It may cause instability during some maneuvers which could result in an accident.

### Front storage compartments

#### Glove box

An media interface is located in the glove box. For information on media interface, see separate COMAND system operating instructions.

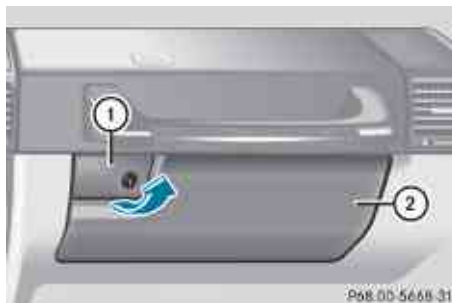

- ▶ **Opening:** Pull glove box lid release (1).
- ▶ **Closing:** Push glove box lid (2) upwards until it engages.

#### Locking and unlocking the glove box

You can lock the glove box, e.g. when the vehicle is in the shop for service.

The glove box can only be locked or unlocked with the mechanical key.

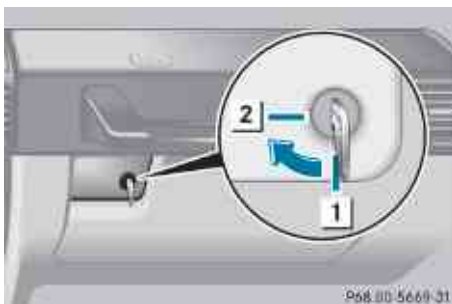

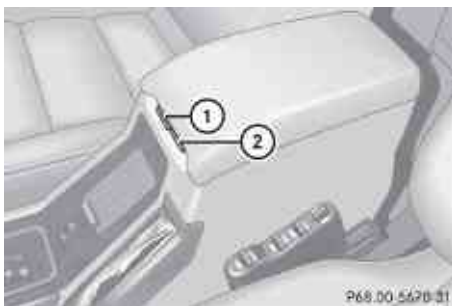

- 1 Glove box unlocked
- 2 Glove box locked

### Storage compartment/storage tray below armrest



- ▶ **Opening storage tray:** Press button ② and lift up armrest cover.
- ▶ **Closing storage tray:** Lower armrest cover until it engages in lock.
- ▶ **Opening storage compartment:** Press button ② and lift up armrest cover.
- ▶ **Closing storage compartment:** Lower armrest cover until it engages in lock.

**i** Located in the cover of the storage tray is a storage area for small items.

**i** The Roadside Assistance button  (▷ page 137) and the Information button  (▷ page 138) are located in the storage tray.

### Storage box in front of armrest



- ▶ **Opening storage box:** Slide storage box cover ① upward.
- ▶ **Closing storage box:** Slide storage box cover ① downward.

### Rear storage compartments

#### Storage bags

##### **Warning!**

Storage bags are intended for storing light-weight items only.

Heavy objects, objects with sharp edges or fragile objects may not be transported in the storage bag. In an accident, during hard braking, or sudden maneuvers, they could be thrown around inside the vehicle and cause injury to vehicle occupants.

Storage bags cannot protect transported goods in the event of an accident.

Storage bags are located on the back of the front seats.

### Useful features

#### Cup holders

##### **Warning!**

In order to help prevent spilling liquids on vehicle occupants and/or vehicle equipment, only use containers that fit into the cup holder. Use lids on open containers and do

not fill containers to a height where the contents, especially hot liquids, could spill during braking, vehicle maneuvers, or in an accident. Liquids spilled on vehicle occupants may cause serious personal injury. Liquids spilled on vehicle equipment may cause damage not covered by the Mercedes-Benz Limited Warranty.

When not in use, keep the cup holder closed. An open cup holder may cause injury to you or others when contacted during braking, vehicle maneuvers, or in an accident.

Keep in mind that objects placed in the cup holder may come loose during braking, vehicle maneuvers, or in an accident and be thrown around in the vehicle interior. Objects thrown around in the vehicle interior may cause an accident and/or serious personal injury.

### Cup holder next to armrest



- Place bracket of cup holder ① into recess indicated by arrow of cup holder base ②.

If the cup holder is no longer in use, it can for example, be stored in the glove box or storage compartment below the armrest.

### Cup holder in front passenger footwell



- Swing cup holder ① upwards until it clicks into place.
- ⚠ Fold the cup holder closed before moving the front passenger seat fully forward.

### Cup holder in rear passenger footwell



- ⚠ Before folding the rear seat backrest and the rear seat bench forward, make sure that all containers in the rear cup holder are removed.

### Sun visors

#### ⚠ Warning!

Do not use the vanity mirror while driving. Keep the vanity mirrors in the sun visors closed while vehicle is in motion. Reflected glare can endanger you and others.

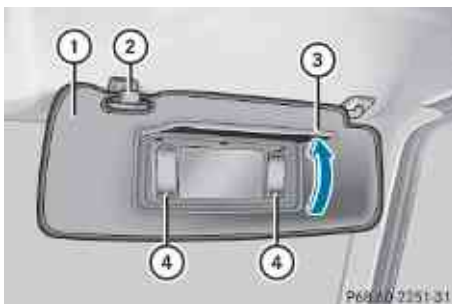

- ① Sun visor
- ② Mounting
- ③ Vanity mirror cover
- ④ Vanity mirror lamps

### Glare through the windshield

- ▶ Flip sun visor ① down when you experience glare.

### Glare through a door window

- ▶ Close vanity mirror cover ③ if opened.
- ▶ Disengage sun visor ① from mounting ②.
- ▶ Pivot sun visor ① to the side.

### Vanity mirror

The mirror lamp only functions when the sun visor is engaged in mounting.

- ▶ Flip sun visor ① down.
- ▶ Lift up vanity mirror cover ③.  
Vanity mirror lamps ④ comes on.

## Ashtrays

### Center console ashtray

#### **Warning!**

Remove front ashtray insert only with vehicle standing still.

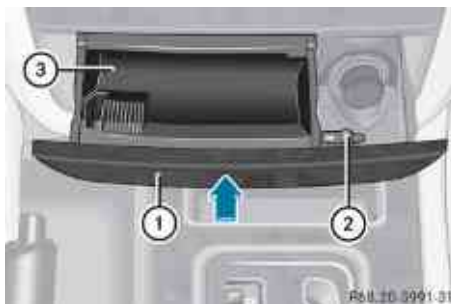

- ▶ **Opening:** Briefly touch at top of cover ①.
- ▶ **Removing ashtray insert:** Secure vehicle from movement by engaging the parking brake.
  - ▶ Shift the automatic transmission into neutral position **N**.
  - ▶ Push sliding knob ② to the right.
  - ▶ Remove ashtray insert ③ from ashtray frame.
- ▶ **Reinstalling ashtray insert:** Push ashtray insert ③ down into the ashtray frame until it engages.
- ▶ **Closing:** Push at top of cover plate ① to close ashtray.

### Rear door ashtray



- ▶ **Opening:** Pull at top of cover ②
- ▶ **Removing ashtray insert:** Push down on catch ①.
- ▶ Pull out ashtray insert ③.

- ▶ **Reinstalling ashtray insert:** Position ashtray insert ③.
- ▶ **Closing:** Push at top of cover ②.

### Cigarette lighter

⚠ **Observe Safety notes, see page 44.**

#### ⚠ Warning!

Never touch the heating element or sides of the cigarette lighter; they are extremely hot. Hold the knob only.

Make sure that any children traveling with you do not injure themselves or start a fire with the hot cigarette lighter.

When leaving the vehicle, always remove the SmartKey from the starter switch, take it with you, and lock the vehicle. Do not leave children unattended in the vehicle, or with access to an unlocked vehicle. A child's unsupervised access to a vehicle could result in an accident and/or serious personal injury.

If the engine is off and the cigarette lighter is being used extensively, the vehicle battery may become discharged.



- ▶ Switch on the ignition.
- ▶ Open the ashtray (▶ page 133).
- ▶ Push in cigarette lighter ①. Cigarette lighter ① will pop out automatically when hot.

! The lighter socket can be used to accommodate 12V DC electrical accessories (up to a maximum of 180 W)

designed for use with the standard “cigarette lighter” plug type. Keep in mind, however, that connecting accessories to the lighter socket (for example extensive connecting and disconnecting, or using plugs that do not fit properly) can damage the lighter socket. With the socket damaged, the lighter may not function properly any longer.

### Power outlets

The power outlets can be used to accommodate 12V DC electrical accessories (e.g. auxiliary lamps, mobile phone chargers) up to a maximum of 15 A (180 W).

- ▶ Switch on the ignition.

#### Power outlet in front passenger footwell



#### Power outlet in rear center console





### Power outlet in cargo compartment



If the engine is off and the power outlets are being used extensively, the vehicle battery may become discharged.

### Tele Aid

**!** In order to activate the Tele Aid system, a subscriber agreement must be completed. To ensure your system is activated and operational, please press button  to perform the acquaintance call. Failure to complete either of these steps may result in a system that is not activated.

If you have any questions regarding activation, please call the Response Center at 1-800-756-9018 (in the USA) or 1-888-923-8367 (in Canada).

Shortly after the completion of your Tele Aid acquaintance call, you will receive a user ID and password in the mail. You may use this password to access the Tele Aid section in “Owner’s Online” at [www.mbusa.com](http://www.mbusa.com) (USA only). The “My Tele Aid” section will give you access to account information, remote door unlock and more.

The Tele Aid system is available if

- it has been activated and is operational. Activation requires a subscription for

monitoring services, connection and cellular air time.

- vehicle battery power is available.
- the relevant cellular phone network and GPS signals are available and pass the information on to the Response Center.

**i** Location of the vehicle on a map is only possible if the vehicle is able to receive signals from the GPS satellite network and pass the information on to the Response Center.

### The Tele Aid system

(Telematic Alarm Identification on Demand)  
The Tele Aid system consists of three types of response:

- Automatic and manual emergency
- Roadside Assistance
- Information

The Tele Aid system is operational providing that the vehicle’s battery is charged, properly connected, not damaged, and cellular and GPS coverage is available. The Tele Aid system utilizes the cellular network for communication and the GPS (Global Positioning System) satellites for vehicle location. If either of these signals are unavailable, the Tele Aid system may not function and if this occurs, assistance must be summoned by other means.

**i** A Tele Aid call cannot be canceled. Even if the Tele Aid system is not activated or operational, the system will attempt to connect the respective call. This may take as long as 5 minutes or more. As long as the Tele Aid system attempts to connect a call, you cannot operate the audio system or the COMAND system. Also, most functions in the control system, such as the telephone function, are suspended. Therefore, it is not advisable to initiate any Tele Aid call unless the Tele Aid system is activated and operational.

To adjust the speaker volume during a Tele Aid call do the following:

- ▶ Press button  or  on the multifunction steering wheel.

or





- ▶ Use the adjustment button on your COMAND system.

### System self-test

The system performs a self-test after you have switched on the ignition.

#### **Warning!**



A malfunction in the system has been detected if any or all of the following conditions occur:

- The indicator lamp in the SOS button does not come on during the system self-test.
- The indicator lamp in Roadside Assistance button  does not come on during the system self-test.
- The indicator lamp in Information button  does not come on during the system self-test.
- The indicator lamp in the SOS button, Roadside Assistance button , or Information button  remains illuminated constantly in red after the system self-test.
- The message *Tele Aid Inoperative* appears in the multifunction display after the system self-test.

If a malfunction is indicated as outlined above, the system may not operate as expected. In case of an emergency, help will have to be summoned by other means.

Have the system checked at the nearest Mercedes-Benz Center or contact the Response Center at 1-800-756-9018 (in the USA) or 1-888-923-8367 (in Canada) as soon as possible.

### Emergency calls

 In order to activate the Tele Aid system, a subscriber agreement must be completed. To ensure your system is activated and operational, please press button  to perform the acquaintance call. Failure to complete either of these steps may result in a system that is not activated.

If you have any questions regarding activation, please call the Response Center at 1-800-756-9018 (in the USA) or 1-888-923-8367 (in Canada).

An emergency call is initiated automatically following an accident in which the Emergency Tensioning Devices (ETDs) or air bags deploy.

An emergency call can also be initiated manually (▷ page 137).

Once the emergency call is in progress, the indicator lamp in the SOS button will begin to flash. The message *Connecting Call* appears in the multifunction display and the COMAND system is muted. When the connection is established, the message *Call Connected* appears in the multifunction display.

All information relevant to the emergency, such as the location of the vehicle (determined by the GPS satellite location system), vehicle model, identification number and color are generated.

A voice connection between the Response Center and the occupants of the vehicle will be established automatically soon after the emergency call has been initiated. The Response Center will attempt to determine the nature of the emergency more precisely, provided they can speak to an occupant of the vehicle.

 If no vehicle occupant responds, an ambulance will be sent to the vehicle immediately.

**⚠ Warning!**

If the indicator lamp in the SOS button is flashing continuously and there was no voice connection to the Response Center established, then the Tele Aid system could not initiate an emergency call (e.g. the relevant cellular phone network is not available).

The message **Call Failed** appears in the multifunction display for approximately 10 seconds.

Should this occur, assistance must be summoned by other means.

- i** The “911” emergency call system is a public service. Using it without due cause is a criminal offense.

**Initiating an emergency call manually**

- ▶ Briefly press on cover ① to open.
- ▶ Press SOS button ② briefly. The indicator lamp in SOS button ② will flash until the emergency call is concluded.
- ▶ Wait for a voice connection to the Response Center.
- ▶ Close cover ① after the emergency call is concluded.

**⚠ Warning!**

If you feel at any way in jeopardy when in the vehicle (e.g. smoke or fire in the vehicle, vehicle in a dangerous road location), please do not wait for voice contact after you have pressed the emergency button. Carefully leave the vehicle and move to a safe location.

The Response Center will automatically contact local emergency officials with the vehicle's approximate location if they receive an automatic SOS signal and cannot make voice contact with the vehicle occupants.

**Roadside Assistance button**

- ▶ Open the storage tray (▷ page 131).



- ▶ Press and hold Roadside Assistance button ① for longer than 2 seconds. A call to a Mercedes-Benz Roadside Assistance dispatcher will be initiated. The indicator lamp in Roadside Assistance button ① will flash while the call is in progress. The message **Connecting Call** will appear in the multifunction display and the COMAND system is muted.

When the connection is established, the message **Call Connected** appears in the multifunction display. The Tele Aid system will transmit data generating the vehicle identification number, model, color and location (subject to availability of cellular and GPS signals).

- i** The COMAND system display indicates that a Tele Aid call is in progress. While the call is connected you can change to the navigation menu by pressing the NAVI button on the COMAND system. Spoken commands are not available.

A voice connection between the Roadside Assistance dispatcher and the occupants of the vehicle will be established.

- Describe the nature of the need for assistance.

The Mercedes-Benz Roadside Assistance dispatcher will either dispatch a qualified Mercedes-Benz technician or arrange to tow your vehicle to the nearest authorized Mercedes-Benz Center. For services such as labor and/or towing, charges may apply. Refer to the Roadside Assistance manual for more information.

Sign and Drive services (USA:only):

Services such as a jump start, a few gallons of fuel or the replacement of a flat tire with the vehicle spare tire are obtainable at no charge.

- ❗ If the indicator lamp in Roadside Assistance button ① is flashing continuously and there was no voice connection to the Response Center established, then the Tele Aid system could not initiate a Roadside Assistance call (e.g. the relevant cellular phone network is not available). The message **Call Failed** appears in the multifunction display.

- **Terminating calls:** Press button  on the multifunction steering wheel.

or

- Press the respective button for ending a telephone call on the COMAND system.

### Information button

- Open the storage tray (► page 131).



- Press and hold Information button ① for longer than 2 seconds.

A call to the Customer Assistance Center will be initiated. The indicator lamp in Information button ① will flash while the call is in progress. The message **Connecting Call** will appear in the multifunction display and the COMAND system is muted.

When the connection is established, the message **Call Connected** appears in the multifunction display. The Tele Aid system will transmit data generating the vehicle identification number, model, color and location (subject to availability of cellular and GPS signals).

- ❗ The COMAND system display indicates that a Tele Aid call is in progress. While the call is connected you can change to the navigation menu by pressing the NAVI button on the COMAND system. Spoken commands are not available.

A voice connection between the Customer Assistance Center representative and the occupants of the vehicle will be established. Information regarding the operation of your vehicle, the nearest authorized Mercedes-Benz Center or Mercedes-Benz USA products and services is available to you.

For more details concerning the Tele Aid system, please visit [www.mbusa.com](http://www.mbusa.com) (USA only), log in to "Owner's Online" and visit the "My Tele Aid" section to learn more.

- ❗ If the indicator lamp in Information button ① is flashing continuously and there was no voice connection to the Response Center established, then the Tele Aid system could not initiate an Information call (e.g. the relevant cellular phone network is not available). The message **Call Failed** appears in the multifunction display.

► **Terminating calls:** Press button  on the multifunction steering wheel.

or

► Press the respective button for ending a telephone call on the COMAND system.

### Call priority

If other service calls such as a Roadside Assistance call or Information call are active, an emergency call is still possible. In this case, the emergency call will take priority and override all other active calls.

The indicator lamp in the respective button flashes until the call is concluded. Emergency calls can only be terminated by a Response Center or Customer Assistance Center representative. All other calls can be terminated by pressing button  on the multifunction steering wheel or the respective button for ending a telephone call on the COMAND system.

### Destination Download to the COMAND system

**i** The components and operating principles of the COMAND system can be found in the separate COMAND operating instructions.

Destination Download allows you access to a database of over 10 million points of interest (POIs) that can be downloaded to your vehicle's navigation system. If you know the destination, the address can be downloaded, or can be provided with points of interests near your location.

The Response Center can transmit destination data to the COMAND system during the connection with the Roadside Assistance or Customer Assistance Center. The transmitted data can contain address details for a Mercedes-Benz Center or POIs.

### Route guidance

The system calculates the route and subsequently starts the route guidance to the defined address.

**i** If you select No, you can save the address to your address book.

**i** The Destination Download feature is available if the relevant mobile phone network is available and data connection is possible.

### Search and Send

“Search & Send” is a navigation destination address entry service. For more information on “Search & Send”, refer to separate COMAND system operating instructions.

### Remote door unlock

In case you have locked your vehicle unintentionally (e.g. SmartKey inside vehicle), and the reserve SmartKey is not available:

- Contact the Response Center at 1-800-756-9018 (in the USA) or 1-888-923-8367 (in Canada). You will be asked to provide your password.
- Then return to your vehicle at the time arranged with the Response Center and press the tailgate lock for a minimum of 20 seconds until the indicator lamp in the SOS button is flashing.

The message *Connecting Call* appears in the multifunction display.

As an alternative, you may unlock the vehicle via Internet in the “My Tele Aid” section of “Owner’s Online”, using your ID and password (USA only).

The Response Center will then unlock your vehicle with the remote door unlocking feature.

**i** The remote door unlock feature is available if the relevant cellular phone network is available.

The SOS button will flash and the message *Connecting Call* will appear in the multifunction display to indicate receipt of the door unlock command.

Once the vehicle is unlocked, a Response Center specialist will attempt to establish voice contact with the vehicle occupants. If the tailgate lock was pressed for more than 20 seconds before door unlock authorization was received by the Response Center, you must wait 15 minutes before pressing the tailgate lock again.

### Stolen Vehicle Recovery services

In the event your vehicle was stolen:

- ▶ Report the incident to the police. The police will issue a numbered incident report.
- ▶ Pass this number on to the Response Center along with your password. The Response Center will then attempt to covertly contact the vehicle's Tele Aid system. Once the vehicle is located, the Response Center will contact the local law enforcement and you. The vehicle's location will only be provided to law enforcement.

**i** If the anti-theft alarm stays on for more than 30 seconds, the Tele Aid system initiates a call to the Response Center automatically. The Tele Aid system will initiate the call provided that

- you have subscribed to the Tele Aid service
- the Tele Aid service has been activated properly
- the necessary mobile phone, power supply and GPS coverage are available

### Garage door opener

The integrated remote control can operate up to three separately controlled devices compatible with HomeLink® or some other systems.

### Warning!

Before programming the integrated remote control to a garage door opener or gate operator, make sure people and objects are out of the way of the device to prevent potential harm or damage. When programming a garage door opener, the door moves up or down. When programming a gate operator, the gate opens or closes.

Do not use the integrated remote control with any garage door opener that lacks safety stop and reverse features as required by U.S. federal safety standards (this includes any garage door opener model manufactured before April 1, 1982). A garage door that cannot detect an object - signaling the door to stop and reverse - does not meet current U.S. federal safety standards.

When programming a garage door opener, park vehicle outside the garage.

Do not run the engine while programming the integrated remote control. Inhalation of exhaust gas is hazardous to your health. All exhaust gas contains carbon monoxide (CO), and inhaling it can cause unconsciousness and possible death.

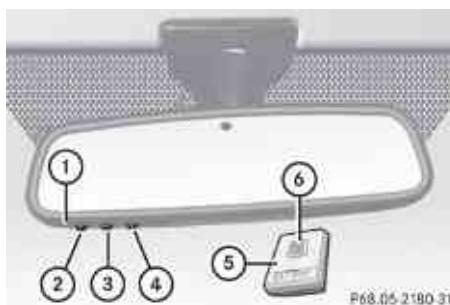

Interior rear view mirror with integrated remote control

Hand-held remote control ⑤ is not part of the vehicle equipment.

## Programming the integrated remote control

- ▶ **Step 1:** Switch on the ignition.
- ▶ **Step 2:** If you have previously programmed a signal transmitter button and wish to retain its programming, proceed to step 3.

or

- ▶ If you are programming the integrated remote control for the first time, press and hold the two outer signal transmitter buttons ② and ④ and release them when indicator lamp ① begins to flash after approximately 20 seconds.

Do not hold the button for longer than 30 seconds.

This procedure erases any previous settings for all three channels and initializes the memory. If you later wish to program a second and/or third hand-held transmitter to the remaining two signal transmitter buttons, do not repeat this step and begin directly with step 3.

- ▶ **Step 3:** Hold the end of hand-held remote control ⑤ of the device you wish to train approximately 2 to 12 in (5 to 30 cm) away from the signal transmitter button (②, ③ or ④) to be programmed, while keeping indicator lamp ① in view.

- ▶ **Step 4:** Using both hands, simultaneously press hand-held remote control button ⑥ and the desired signal transmitter button (②, ③ or ④). Do not release the buttons until step 5 is completed. Indicator lamp ① will flash, first slowly and then rapidly.

**i** Indicator lamp ① flashes immediately the first time the signal transmitter button is programmed. If this button has already been programmed, the indicator lamp will start flashing after 20 seconds.

- ▶ **Step 5:** After indicator lamp ① changes from a slow to a rapidly flashing light,

release the hand-held remote control button and the signal transmitter button.

- ▶ **Step 6:** Press and hold the just-trained signal transmitter button (②, ③ or ④) and observe indicator lamp ①. If indicator lamp ① stays on constantly, programming is complete and your device should activate when the respective signal transmitter button (②, ③ or ④) is pressed and released.

**i** If indicator lamp ① flashes rapidly for approximately 2 seconds and then turns to a constant light, continue with programming steps 8 through 12 as your garage door opener may be equipped with the “rolling code” feature.

- ▶ **Step 7:** To program the remaining two signal transmitter buttons, repeat the steps above starting with step 3.

### Rolling code programming

To train a garage door opener (or other rolling code devices) with the rolling code feature, follow these instructions after completing the “Programming” portion (steps 1 through 6) of this text. A second person may make the following training procedures quicker and easier.

- ▶ **Step 8:** Locate the “training” button on the garage door opener motor head unit.

**i** Exact location and color of the button may vary by garage door opener brand. Depending on manufacturer, the “training” button may also be referred to as “learn” or “smart” button. If there is difficulty locating the transmitting button, refer to the garage door opener Operator’s Manual.

- ▶ **Step 9:** Press the “training” button on the garage door opener motor head unit. The “training light” is activated.

You have 30 seconds to initiate the following two steps.

- ▶ **Step 10:** Return to the vehicle and firmly press, hold for 2 seconds and release the

programmed signal transmitter button (②, ③ or ④).

- ▶ **Step 11:** Press, hold for 2 seconds and release same signal transmitter button a second time to complete the training process.

**i** Some garage door openers (or other rolling code equipped devices) may require you to press, hold for 2 seconds and release the same signal transmitter button a third time to complete the training process.

- ▶ **Step 12:** Confirm the garage door operation by pressing the programmed signal transmitter button (②, ③ or ④).
- ▶ **Step 13:** To program the remaining two signal transmitter buttons, repeat the steps above starting with step 3.

### Gate operator/Canadian programming

Canadian radio-frequency laws require transmitter signals to “time-out” (or quit) after several seconds of transmission which may not be long enough for the integrated signal transmitter to pick up the signal during programming. Similar to this Canadian law, some U.S. gate operators are designed to “time-out” in the same manner.

If you live in Canada or if you are having difficulties programming a gate operator (regardless of where you live) by using the programming procedures, replace step 4 with the following:

- ▶ **Step 4:** Press and hold the signal transmitter button (②, ③ or ④). Do not release this button until it has been successfully trained.
- ▶ While still holding down the signal transmitter button (②, ③ or ④), “cycle” your hand-held remote control button ⑥ as follows: Press and hold button ⑥ for 2 seconds, then release it for 2 seconds, and again press and hold it for 2 seconds. Repeat this sequence on the hand-held

remote control until the frequency signal has been learned.

Upon successful training, indicator lamp ① will flash slowly and then rapidly after several seconds.

- ▶ Proceed with programming step 5 and step 6 to complete.

**i** Upon completion of programming the integrated remote control, make sure you retain the hand-held remote control that came with the garage door opener, gate operator or other device. You may need it for use in other vehicles, for future programming of an integrated remote control, or simply for continued use as a hand-held remote control to operate the respective device in other situations.

### Reprogramming a single signal transmitter button

To program a device using a signal transmitter button previously trained, follow these steps:

- ▶ Switch on the ignition.
- ▶ Press and hold the desired signal transmitter button (②, ③ or ④). Do not release the button. Indicator lamp ① will begin to flash after 20 seconds.
- ▶ Without releasing the signal transmitter button, proceed with programming starting with step 3.

### Operation of integrated remote control

- ▶ Switch on the ignition.
- ▶ Select and press the appropriate integrated signal transmitter button (②, ③ or ④) to activate the remote controlled device. The integrated remote control transmitter continues to send the signal as long as the button is pressed – up to 20 seconds.



## Erasing the integrated remote control memory

- i** If you sell your vehicle, erase the codes of all three channels.
- ▶ Switch on the ignition.
- ▶ Simultaneously press and hold outer signal transmitter buttons ② and ④, for approximately 20 seconds, until indicator lamp ① flashes rapidly. Do not hold for longer than 30 seconds.  
The codes of all three channels are erased.

## Programming tips

If you are having difficulty programming the integrated remote control, here are some helpful tips:

- Check the frequency of hand-held remote control ⑤ (typically located on the reverse side of the remote). The integrated remote control is compatible with radio-frequency devices operating between 280-390 MHz.
- Put a new battery in hand-held remote control ⑤. This will increase the likelihood of the hand-held remote control sending a faster and more accurate signal to the integrated remote control.
- While performing step 3, hold hand-held remote control ⑤ at different lengths and angles from the signal transmitter button (②, ③ or ④) you are programming. Attempt varying angles at the distance of 2 to 12 inches (5 to 30 cm) away or the same angle at varying distances.
- If another hand-held remote control is available for the same device, try the programming steps again using that other hand-held remote control. Make sure new batteries are in the hand-held remote control before beginning the procedure.
- Straighten the antenna wire from the garage door opener assembly. This may help improve transmitting and/or receiving signals.

- i** Certain types of garage door openers are incompatible with the integrated remote control. If you should experience further difficulties with programming the integrated remote control, contact an authorized Mercedes-Benz Center, or call the Mercedes-Benz Customer Assistance Center (in the USA) at 1-800-FOR-MERCEdes, or Customer Service (in Canada) at 1-800-387-0100.

- i** USA only:  
This device complies with Part 15 of the FCC Rules. Operation is subject to the following two conditions:

1. This device may not cause harmful interference, and
2. this device must accept any interference received, including interference that may cause undesired operation.

Any unauthorized modification to this device could void the user's authority to operate the equipment.

- i** Canada only:  
This device complies with RSS-210 of Industry Canada. Operation is subject to the following two conditions:

1. This device may not cause interference, and
2. this device must accept any interference received, including interference that may cause undesired operation of the device.

Any unauthorized modification to this device could void the user's authority to operate the equipment.

### Floormats

#### **Warning!**

Whenever you are using floormats, make sure there is enough clearance and that the floormats are securely fastened.

Floormats should always be securely fastened using the fastening equipment.

Before driving off, check that the floormats are securely in place and adjust them if necessary. A loose floormat could slip and hinder proper functioning of the pedals.

Do not place several floormats on top of each other as this may impair pedal movement.

-  To install or remove the floormat more easily, move the driver's seat or front passenger seat as far to the rear as possible.

<b>Vehicle equipment</b> .....	146
<b>The first 1000 miles (1500 km)</b> .....	146
<b>At the gas station</b> .....	146
<b>Engine compartment</b> .....	148
<b>Tires and wheels</b> .....	154
<b>Winter driving</b> .....	175
<b>Driving instructions</b> .....	176
<b>Maintenance</b> .....	185
<b>Vehicle care</b> .....	187

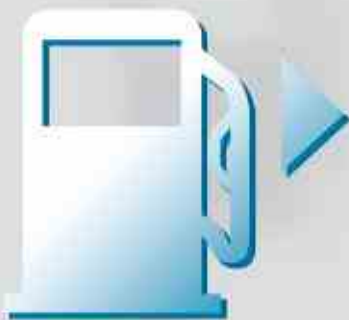

### Vehicle equipment

- i** This Operator's Manual describes all features, standard or optional, potentially available for your vehicle at the time of purchase. Please be aware that your vehicle might not be equipped with all features described in this manual.

### The first 1000 miles (1500 km)

The more cautiously you treat your vehicle during the break-in period, the more satisfied you will be with its performance later on.

- Drive your vehicle during the first 1000 miles (1500 km) at varying but moderate vehicle and engine speeds.
- During this period, avoid heavy loads (full throttle driving) and excessive engine speeds (no more than  $\frac{2}{3}$  of maximum rpm in each gear).
- Shift gears in a timely manner.
- Avoid accelerating by kickdown.
- Do not attempt to slow the vehicle down by shifting to a lower gear using the gear selector lever.
- Select gear ranges **3, 2** or **1** (▷ page 89) only when driving at moderate speeds (for hill driving).

After 1000 miles (1500 km) you may gradually increase vehicle and engine speeds to the permissible maximum.

#### **i** Additional instructions for AMG vehicles:

- During the first 1000 miles (1500 km), do not exceed a speed of 85 mph (140 km/h).
- During this period, avoid engine speeds above 4500 rpm in each gear.
- Shift gears in a timely manner.
- Avoid off-road driving during the break-in period until the oil change in the front and rear axle at 2000 miles (3000 km)

has been performed. Please refer to Maintenance Booklet.

All of the above instructions, as may apply to your vehicle type, also apply when driving the first 1000 miles (1500 km) after the engine, the transfer case, the front differential or the rear differential has been replaced.

- i** Always obey applicable speed limits.

### At the gas station

#### Refueling

##### **⚠ Warning!**

Gasoline is highly flammable and poisonous. It burns violently and can cause serious personal injury.

Never allow sparks, flames or smoking materials near gasoline!

Turn off the engine before refueling.

Whenever you are around gasoline, avoid inhaling fumes and any skin or clothing contact. Extinguish all smoking materials.

Direct skin contact with fuels and the inhalation of fuel vapors are damaging your health.

##### **⚠ Warning!**

Overfilling of the fuel tank may create pressure in the system which could cause a gas discharge. This could cause the gas to spray back out when removing the fuel pump nozzle, which could cause personal injury.

- i** Never refuel vehicles with gasoline engine with diesel fuel. Even small amounts of diesel fuel will damage the fuel system and engine. Damage resulting from the use of non-approved fuels or fuel additives or resulting from mixing gasoline with diesel fuel is not covered by the Mercedes-Benz Limited Warranty.

- i** If you have accidentally filled the tank with incorrect or non-approved fuel, do not

switch on the ignition. Otherwise the incorrect or non-approved fuel will get into the fuel lines. The fuel system must be drained completely. Contact an authorized Mercedes-Benz Center to have the fuel system drained completely.

**!** To prevent damage to the catalytic converters, only use premium unleaded gasoline in this vehicle.

Any noticeable irregularities in engine operation should be repaired promptly.

Otherwise, excessive unburned fuel may reach the catalytic converter, causing it to overheat and potentially start a fire.

**i** Only use premium unleaded gasoline with a minimum Posted Octane Rating of 91 (average of 96 RON/86 MON). Information on gasoline quality can normally be found on the fuel pump. Please contact gas station personnel in case labels on the pump cannot be found. For more information on gasoline, see “Premium unleaded gasoline” (▷ page 254), see “Fuel requirements” (▷ page 255), or contact an authorized Mercedes-Benz Center, or visit [www.mbusa.com](http://www.mbusa.com) (USA only).



The fuel filler flap is located on the right-hand side of the vehicle towards the rear.

Locking/unlocking the vehicle with the SmartKey automatically locks/unlocks the fuel filler flap.

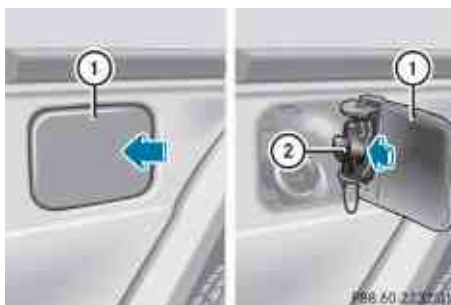
**i** In case the central locking system does not release the fuel filler flap, see “Fuel filler flap” (▷ page 223).



▶ Turn off the engine.

**i** Leaving the engine running and the fuel filler cap open can cause the yellow fuel tank reserve warning lamp to flash and the malfunction indicator lamp  (USA only) or  (Canada only) to illuminate. For more information, see also “Practical hints” (▷ page 218).

▶ Remove the SmartKey from the starter switch.

▶ **Opening:** Press fuel filler flap ① at the point indicated by the arrow.

▶ Turn fuel filler cap ② counterclockwise.

▶ Take off fuel filler cap ②.

**!** The fuel filler cap is tethered to the fuel filler neck. Do not drop the cap. It could damage the vehicle paint finish.

▶ Place fuel filler cap ② in direction of arrow into the holder.

▶ Fully insert filler nozzle unit and refuel.

▶ Only fill your tank until the filler nozzle unit cuts out – **do not top off or overfill.**

**!** When refueling the vehicle, make certain that no gasoline comes into contact with the rear side marker to prevent damaging the lens.

▶ **Closing:** Turn fuel filler cap ② clockwise until it audibly engages.

**i** Make sure to close the fuel filler flap before locking your vehicle as the flap

locking pin prevents closing after you have locked the vehicle.

- Close fuel filler flap ①.

### Check regularly and before a long trip

For information on quantities and requirements of operating agents, see “Fuels, coolants, lubricants, etc.” (► page 252).

Check the following:

- Engine oil level (► page 149)
- Tire inflation pressure (► page 156)
- Coolant level (► page 152)
- Vehicle lighting (► page 226)
- Washer system and headlamp cleaning system (► page 153)
- Brake fluid (► page 152)

## Operation

### Engine compartment

#### Hood

#### ⚠ Warning!

Do not pull the release lever while the vehicle is in motion. Otherwise the hood could be forced open by passing air flow.

This could cause the hood to come loose and injure you and/or others.

#### Opening

#### ⚠ Warning!

If you see flames or smoke coming from the engine compartment, or if the coolant temperature gauge indicates that the engine is overheated, do not open the hood. Move away from vehicle and do not open the hood until the engine has cooled. If necessary, call the fire department.

#### ⚠ Warning!

You could be injured when the hood is open – even when the engine is turned off.

Parts of the engine can become very hot. To prevent burns, let the engine cool completely before touching any components on the vehicle. Comply with all relevant safety precautions.

#### ⚠ Warning!

To help prevent personal injury, stay clear of moving parts when the hood is open and the engine is running.

The radiator fan may continue to run for approximately 30 seconds or may even restart after the engine has been turned off. Stay clear of fan blades.

#### ⚠ Warning!

The engine is equipped with a transistorized ignition system. Because of the high voltage it is dangerous to touch any components (ignition coils, spark plug sockets, diagnostic socket) of the ignition system

- with the engine running
- while starting the engine
- when the ignition is switched on and the engine is turned manually



- Pull hood lock release lever ①. The hood is unlocked.

- ⚠ To avoid damage to the windshield wipers or hood, never open the hood if the wiper

arms are folded forward away from the windshield.



- ▶ Lift hood up slightly.
- ▶ Push safety hook ② in direction of arrow.
- ▶ Pull up on hood.  
The hood will be automatically held open at shoulder height by gas-filled struts.

### Closing

#### **Warning!**

When closing the hood, use extreme caution not to catch hands or fingers. Be careful that you do not close the hood on anyone.

Make sure the hood is securely engaged before driving off. Do not continue driving if the hood can no longer engage after an accident, for example. The hood could otherwise come loose while the vehicle is in motion and injure you and/or others.

- ▶ Let the hood drop from a height of approximately 1 ft (30 cm).
- ▶ Check to make sure the hood is fully closed.  
If you can raise the hood at a point above the turn signals to the left and right of the hood, then it is not properly closed. Open it again and let it drop with somewhat greater force.

### Engine oil

The amount of oil your engine needs will depend on a number of factors, including driving style. Increased oil consumption can occur when the vehicle is new or the vehicle is driven frequently at higher engine speeds. Engine oil consumption checks should only be made after the vehicle break-in period.

**!** Do not use any special lubricant additives, as these may damage the drive assemblies. Using special additives not approved by Mercedes-Benz may cause damage not covered by the Mercedes-Benz Limited Warranty.

For further information contact an authorized Mercedes-Benz Center.

### Notes on checking engine oil level

When checking the oil level the vehicle must be parked on level ground.

**G 550:** The vehicle must have been stationary for at least 5 minutes with the engine turned off.

**G 55 AMG:** With the engine at operating temperature, the vehicle must have been stationary for at least 5 minutes with the engine turned off.

With the engine not at operating temperature, the vehicle must have been stationary for at least 30 minutes with the engine turned off.

### Checking engine oil level with the oil dipstick

On the G 550, you can check the engine oil level with the oil dipstick.

- ▶ Open the hood (▷ page 148).

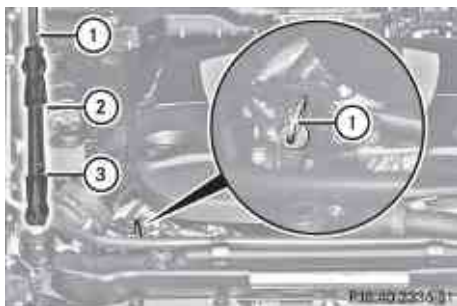

## Operation

- ▶ Pull out oil dipstick ①.
- ▶ Wipe oil dipstick ① clean.
- ▶ Fully insert oil dipstick ① into the dipstick guide tube.
- ▶ Pull out oil dipstick ① again after approximately 3 seconds to obtain accurate reading.  
The oil level is correct when it is between lower (min) mark ③ and upper (max) mark ② of oil dipstick ①.

**i** The filling quantity between the upper and lower marks on the oil dipstick is approximately 2.1 US qt. (2.0 l).



- ▶ If necessary, add engine oil.

For more information on engine oil, see “Fuels, coolants, lubricants etc.”  
(▷ page 252).

For information on messages in the multifunction display concerning engine oil, see the “Practical hints” section  
(▷ page 207).



### Checking engine oil level with the control system

On the G 55 AMG, you can check the engine oil level with the control system.

- ▶ Switch on the ignition.  
The standard display appears in the multifunction display (▷ page 99).
- ▶ Press button  or  on the multifunction steering wheel repeatedly until the following message appears in the multifunction display:

One of the following messages will subsequently appear in the multifunction display:

- Engine Oil Level OK
- Add 1.0 qt to reach maximum oil level.  
(Canada: 1.0 liter)
- Add 1.5 qts to reach maximum oil level.  
(Canada: 1.5 liters)
- Add 2.0 qts to reach maximum oil level.  
(Canada: 2.0 liters)

**i** If you want to interrupt the checking procedure, press button  or  on the multifunction steering wheel.

- ▶ If necessary, add engine oil.

For more information on engine oil, see “Fuels, coolants, lubricants etc.”  
(▷ page 252).



**Other display messages**

If the ignition is not switched on, the following message appears in the multifunction display:

Switch  
ignition on to  
check engine  
oil level.

- ▶ Switch on the ignition.

If you see the message:

Observe  
Waiting Time

- ▶ If the engine is at operating temperature, wait 5 minutes before repeating check procedure.
- ▶ If the engine is not at operating temperature yet, you must wait 30 minutes before checking oil.

If you see the message:

Engine Oil  
Level  
Not With  
Engine On

- ▶ Turn off the engine.
- ▶ If the engine is at operating temperature, wait 5 minutes before checking oil.
- ▶ If the engine is not at operating temperature yet, you must wait 30 minutes before checking oil.

If there is excess engine oil with the engine at normal operating temperature, the following message appears in the multifunction display:

Engine Oil  
Reduce Oil  
Level

- ▶ Have excess oil siphoned or drained off. Contact an authorized Mercedes-Benz Center.

- ❗ Excess oil must be siphoned or drained off. It could cause damage to the engine and emission control system not covered by the Mercedes-Benz Limited Warranty.

For information on messages in the multifunction display concerning engine oil, see the “Practical hints” section (▷ page 207).

**Adding engine oil**

- ❗ Only use approved engine oils and oil filters required for vehicles with Maintenance System. For a listing of approved engine oils and oil filters, contact an authorized Mercedes-Benz Center or visit [www.mbusa.com](http://www.mbusa.com) (USA only).

Using engine oils and oil filters of specification other than those expressly required for the Maintenance System, or changing of oil and oil filter at change intervals longer than those called for by the Maintenance System will result in engine or emission control system damage not covered by the Mercedes-Benz Limited Warranty.



G 550

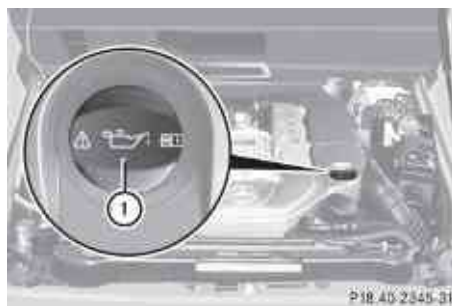

G 55 AMG

## 152 Engine compartment

- ▶ Unscrew filler cap ① from filler neck.
- ▶ Add engine oil as required. Be careful not to overfill with oil.

Be careful not to spill any oil when adding. Avoid environmental damage caused by oil entering the ground or water.

**!** Excess oil must be siphoned or drained off. It could cause damage to the engine and emission control system not covered by the Mercedes-Benz Limited Warranty.

- ▶ Screw filler cap ① back on filler neck.

For more information on engine oil, see the "Technical data" section (▶ page 252) and (▶ page 253).

## Operation

## Brake fluid level

**!** If you find that the brake fluid in the brake fluid reservoir has fallen to the minimum mark or below, have the brake system checked for brake pad thickness and leaks immediately. Contact an authorized Mercedes-Benz Center immediately. Do not add brake fluid as this will not solve the problem. For more information, see "Practical hints".

When checking the brake fluid level, the vehicle must be parked on level ground.

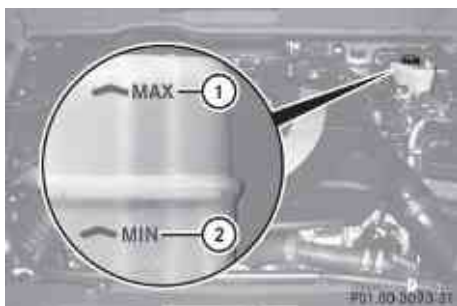

The brake fluid level is correct when it is between lower mark (MIN) ② and upper mark (MAX) ① of the brake fluid reservoir.

## Coolant level

The engine coolant is a mixture of water and anticorrosion/antifreeze.

When checking the coolant level, the vehicle must be parked on level ground, and the coolant temperature must be below 158°F (70°C).

**⚠ Warning!**

In order to avoid any potentially serious burns:

- Use extreme caution when opening the hood if there are any signs of steam or coolant leaking from the cooling system, or if the coolant temperature gauge indicates that the coolant is overheated.
- Do not remove pressure cap on coolant reservoir if coolant temperature is above 158°F (70°C). Allow engine to cool down before removing cap. The coolant reservoir contains hot fluid and is under pressure.
- Using a rag, slowly open the cap approximately 1/2 turn to relieve excess pressure. If opened immediately, scalding hot fluid and steam will be blown out under pressure.
- Do not spill antifreeze on hot engine parts. Antifreeze contains ethylene glycol which may burn if it comes into contact with hot engine parts.

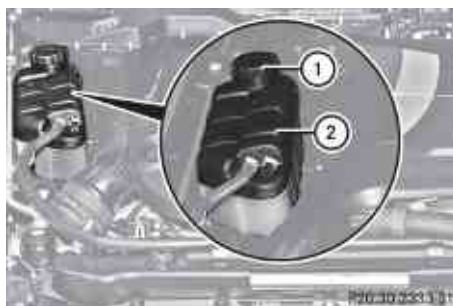

- ▶ Using a rag, turn cap ① slowly approximately  $1/2$  turn counterclockwise to release any excess pressure.
- ▶ Continue turning cap ① counterclockwise and remove it.

The coolant level is correct if the level

- for cold coolant: reaches the top of the mark (plastic bridge) in coolant expansion tank ②
  - for warm coolant: is approximately 0.6 in (1.5 cm) higher
- ▶ Add coolant as required.
  - ▶ Attach and tighten cap ①.

For more information on coolant, see the “Technical data” section (▶ page 253) and (▶ page 255).

### Washer system and headlamp cleaning system

#### Warning!

Washer solvent/antifreeze is highly flammable. Do not spill washer solvent/antifreeze on hot engine parts, because it may ignite and burn. You could be seriously burned.

- ❗ Always use washer solvent/antifreeze where temperatures may fall below freezing point. Failure to do so could result in damage to the washer system/fluid reservoir.
- ❗ Only use washer fluid which is suitable for plastic lenses. Improper washer fluid can damage the plastic lenses of the headlamps.
- ❗ Do not use distilled or deionized water in the washer fluid reservoir. Otherwise, the washer fluid level sensor could be damaged.



Fluid for the washer system, rear window washer system, and the headlamp cleaning system is supplied from the washer fluid reservoir.

During all seasons, add MB Windshield Washer Concentrate “MB SummerFit” to water. Premix the washer fluid in a suitable container.

- ▶ **Opening washer fluid reservoir:** Pull tab of cap ① upwards.
- ▶ Refill the washer fluid reservoir with MB Windshield Washer Concentrate “MB SummerFit” and water (or commercially available premixed washer solvent/antifreeze, depending on ambient temperatures) (▶ page 257).
- ▶ **Closing washer fluid reservoir:** Press cap ① onto filler hole until it engages.

For more information, see “Washer system and headlamp cleaning system” (▶ page 253).

### Transmission fluid level

The transmission fluid level does not need to be checked. If you notice transmission fluid loss or gearshifting malfunctions, have an authorized Mercedes-Benz Center check the transmission.

## Tires and wheels

### Safety notes

Contact an authorized Mercedes-Benz Center for information on tested and recommended rims and tires for summer and winter operation. They can also offer advice concerning tire service and purchase.

#### **Warning!**

Replace rims or tires with the same designation, manufacturer and type as shown on the original part. For further information contact an authorized Mercedes-Benz Center. If incorrectly sized rims and tires are mounted, the wheel brakes or suspension components can be damaged. Also, the operating clearance of the wheels and the tires may no longer be correct.

#### **Warning!**

Worn, old tires can cause accidents. If the tire tread is worn to minimum tread depth, or if the tires have sustained damage, replace them.

When replacing rims, only use genuine Mercedes-Benz wheel bolts specified for the particular rim type. Failure to do so can result in the bolts loosening and possibly an accident.

Retreaded tires are not tested or recommended by Mercedes-Benz, since previous damage cannot always be recognized on retreads. The operating safety of the vehicle cannot be assured when such tires are used.

#### **Warning!**

If you feel a sudden significant vibration or ride disturbance, or you suspect that possible damage to your vehicle has occurred, you should turn on the hazard warning flashers, carefully slow down, and drive with caution to an area which is a safe distance from the road. Inspect the tires and the vehicle underbody for possible damage. If the vehicle or tires

appear unsafe, have the vehicle towed to the nearest authorized Mercedes-Benz Center or tire dealer for repairs.

#### **Warning!**

Do not drive with a flat tire. A flat tire affects the ability to steer or brake the vehicle. You could lose control of the vehicle. Continued driving with a flat tire or driving at high speed with a flat tire will cause excessive heat build-up and possibly a fire.

### Important guidelines

- Only use sets of tires and rims of the same type and make.
- Tires must be of the correct size for the rim.
- Break in new tires for approximately 60 miles (100 km) at moderate speeds.
- Regularly check the tires and rims for damage. Dented or bent rims can cause tire inflation pressure loss and damage to the tire beads.
- If vehicle is heavily loaded, check tire inflation pressure and correct as required.
- Do not allow your tires to wear down too far. Adhesion properties on wet roads are sharply reduced at tread depths of less than  $\frac{1}{8}$  in (3 mm).
- When replacing individual tires, you should mount new tires on the front wheels first (on vehicles with same-sized wheels all around).

### Recommended tire inflation pressure

#### **Warning!**

Follow recommended tire inflation pressures. Do not underinflate tires. Underinflated tires wear excessively and/or unevenly, adversely affect handling and fuel economy, and are more likely to fail from being overheated.

Do not overinflate tires. Overinflated tires can adversely affect handling and ride comfort, wear unevenly, increase stopping distance, and result in sudden deflation (blowout) because they are more likely to become punctured or damaged by road debris, potholes etc.

Do not overload the tires by exceeding the specified load limit as indicated on the Tire and Loading Information placard on the driver's door B-pillar. Overloading the tires can overheat them, possibly causing a blowout. Overloading the tires can also result in handling or steering problems, or brake failure.

Your vehicle is equipped with the Tire and Loading Information placard located on the driver's door B-pillar (▷ page 161).

The tire inflation pressure should be checked regularly. Only adjust the tire inflation pressure on cold tires. The tires can be considered cold if the vehicle has been parked for at least 3 hours or driven less than 1 mile (1.6 km). Depending on the ambient temperature, the driving speed and the tire load, the tire temperature changes. When the tire temperature changes by 18°F (10°C), the tire inflation pressure will change by approximately 1.5 psi (0.1 bar). Keep this in mind when checking tire inflation pressure on warm tires and adjust the tire pressure only if the tire inflation pressure is too low for the current operating conditions. If you check the tire inflation pressure when the tires are warm, the reading will be higher than the cold reading. This is normal. Do not let air out to match the specified cold tire inflation pressure. Otherwise, the tire will be underinflated.

Follow recommended cold tire inflation pressures listed on Tire and Loading Information placard on the driver's door B-pillar.

Keeping the tires properly inflated provides the best handling, tread life and riding comfort.

In addition to the Tire and Loading Information placard on the driver's door B-pillar, also consult the tire inflation pressure label (if available) on the inside of the filler flap for any additional information pertaining to special driving situations. For more information, see "Important notes on tire inflation pressure" (▷ page 155).

**i** Data shown on Tire and Loading Information placard example are for illustration purposes only. Tire data are specific to each vehicle and may vary from data shown in the following illustration. Refer to Tire and Loading Information placard on vehicle for actual data specific to your vehicle.



The Tire and Loading Information placard lists the recommended cold tire inflation pressures ① for maximum loaded vehicle weight. The tire inflation pressures listed apply to the tires installed as original equipment.

### Important notes on tire inflation pressure

#### **⚠ Warning!**

If the tire inflation pressure drops repeatedly, check the tires for punctures from foreign objects and/or whether air is leaking from the valves or from around the rim.

Tire temperature and tire inflation pressure are also increased while driving, depending on the driving speed and the tire load.

If you will be driving your vehicle at high speeds of 100 mph (160 km/h) or higher, where it is legal and conditions allow, consult the tire inflation pressure label on the inside of the fuel filler flap (if available) on how to adjust the cold tire inflation pressure. If you do not adjust the tire inflation pressure, excessive heat can build up and result in sudden tire failure.

If your vehicle is not equipped with the tire inflation pressure label on the inside of the fuel filler flap, contact an authorized Mercedes-Benz Center for proper tire inflation pressure.

- i** Driving comfort may be reduced when the tire inflation pressure is adjusted to the value for speeds above 100 mph (160 km/h) as specified on the tire inflation pressure label located on the inside of the fuel filler flap.

Make sure to readjust the tire inflation pressure for normal driving speeds.

Some vehicles may have supplemental tire inflation pressure information for vehicle loads less than the maximum loaded vehicle condition. If such information is provided, it can be found on the tire inflation pressure label located on the inside of the fuel filler flap.

### Potential problems associated with underinflated and overinflated tires

#### Underinflated tires

##### **Warning!**

Follow recommended tire inflation pressures. Do not underinflate tires. Underinflated tires wear excessively and/or unevenly, adversely affect handling and fuel economy, and are more likely to fail from being overheated.

Underinflated tires can

- cause excessive and uneven tire wear
- adversely affect fuel economy

- lead to tire failure from being overheated
- adversely affect handling characteristics

#### Overinflated tires

##### **Warning!**

Follow recommended tire inflation pressures. Do not overinflate tires. Overinflated tires can adversely affect handling and ride comfort, wear unevenly, increase stopping distance, and result in sudden deflation (blowout) because they are more likely to become punctured or damaged by road debris, potholes etc.

Overinflated tires can

- adversely affect handling characteristics
- cause uneven tire wear
- be more prone to damage from road hazards
- adversely affect ride comfort
- increase stopping distance

#### Checking tire inflation pressure

#### Safety notes

##### **Warning!**

Follow recommended tire inflation pressures. Do not underinflate tires. Underinflated tires wear excessively and/or unevenly, adversely affect handling and fuel economy, and are more likely to fail from being overheated.

Do not overinflate tires. Overinflated tires can adversely affect handling and ride comfort, wear unevenly, increase stopping distance, and result in sudden deflation (blowout) because they are more likely to become punctured or damaged by road debris, potholes etc.

Do not overload the tires by exceeding the specified load limit as indicated on the Tire and Loading Information placard on the driver's door B-pillar. Overloading the tires

can overheat them, possibly causing a blowout. Overloading the tires can also result in handling or steering problems, or brake failure.

Check the tire inflation pressure at least every other week.

Check and adjust the tire inflation pressure when the tires are cold (▷ page 155).

### Checking tire inflation pressure manually

Follow the steps below to achieve correct tire inflation pressure:

- ▶ Remove the cap from the valve on one tire.
- ▶ Firmly press a tire gauge onto the valve.
- ▶ Read the tire inflation pressure on the tire gauge and check against the recommended tire inflation pressure on the Tire and Loading Information placard on the driver's door B-pillar (▷ page 161). If necessary, add air to achieve the recommended tire inflation pressure.
- ▶ If you have overfilled the tire, release tire inflation pressure by pushing the metal stem of the valve with e.g. a tip of a pen. Then recheck the tire inflation pressure with the tire gauge.
- ▶ Install the valve cap.
- ▶ Repeat this procedure for each tire.

### Advanced Tire Pressure Monitoring System (Advanced TPMS)

Your vehicle is equipped with the Advanced Tire Pressure Monitoring System (Advanced TPMS). It measures the tire inflation pressure in the vehicle's tires and issue warnings in case of pressure loss in one or more of the tires.

The TPMS is equipped with a combination low tire pressure/ TPMS malfunction telltale (USA) or a low tire pressure telltale (Canada) in the instrument cluster. Depending on how the telltale illuminates, it indicates a low tire pressure condition or a malfunction in the TPMS system itself:

- If the telltale illuminates continuously, one or more of your tires is significantly underinflated. There is no malfunction in the TPMS.
- USA only: If the telltale flashes for 60 seconds and then stays illuminated, the TPMS system itself is not operating properly.

The TPMS only functions on wheels that are equipped with the proper electronic sensors.

#### **Warning!**

The TPMS does not indicate a warning for wrongly selected inflation pressures. Always adjust tire inflation pressure according to the Tire and Loading Information placard or, if available, on the supplemental tire inflation pressure information on the inside of the fuel filler flap.

The TPMS is not able to issue a warning due to a sudden dramatic loss of pressure (e.g. tire blowout caused by a foreign object). In this case bring the vehicle to a halt by carefully applying the brakes and avoiding abrupt steering maneuvers.

#### **Warning!**

Each tire, including the spare (if provided), should be checked every other week when cold and inflated to the inflation pressure recommended by the vehicle manufacturer on the Tire and Loading Information placard on the driver's door B-pillar or, if available, the tire inflation pressure label on the inside of the fuel filler flap. If your vehicle has tires of a different size than the size indicated on the vehicle placard or the tire inflation pressure label, you should determine the proper tire inflation pressure for those tires.

As an added safety feature, your vehicle has been equipped with a tire pressure monitoring system (TPMS) that illuminates a low tire pressure telltale when one or more of your tires are significantly underinflated.

Accordingly, when the low tire pressure telltale illuminates, you should stop and check your tires as soon as possible, and inflate them to the proper pressure. Driving on a significantly underinflated tire causes the tire to overheat and can lead to tire failure.

Underinflation also reduces fuel efficiency and tire tread life, and may affect the vehicle's handling and stopping ability. Please note that the TPMS is not a substitute for proper tire maintenance, and it is the driver's responsibility to maintain correct tire pressure, even if underinflation has not reached the level to trigger illumination of the TPMS low tire pressure telltale.

USA only:

Your vehicle has also been equipped with a TPMS malfunction indicator to indicate when the system is not operating properly. The TPMS malfunction indicator is combined with the low tire pressure telltale. When the system detects a malfunction, the telltale will flash for approximately 1 minute and then remain continuously illuminated. This sequence will continue upon subsequent vehicle start-ups as long as the malfunction exists. When the malfunction indicator is illuminated, the system may not be able to detect or signal low tire pressure as intended. TPMS malfunctions may occur for a variety of reasons, including the installation of replacement or alternate tires or wheels on the vehicle that prevent the TPMS from functioning properly. Always check the TPMS malfunction telltale after replacing one or more tires or wheels on your vehicle to ensure that the replacement or alternate tires and wheels allow the TPMS to continue to function properly.





**i** USA only:

If a condition causing the TPMS to malfunction develops, it may take up to 10 minutes for the system to signal a malfunction using the TPMS telltale flashing and illumination sequence.

The telltale extinguishes after a few minutes driving if the malfunction has been corrected.

Tire pressure inquiries are made using the multifunction display. The current tire inflation pressure for each tire appears in the multifunction display after a few minutes of driving.

**i** Possible differences between the readings of a tire pressure gauge of an air hose, e.g. gas station equipment, and the vehicle's control system can occur. The tire pressure displayed by the control system apply to sea level. In high-altitude locations, the reading on a tire pressure gauge will be higher than the reading issued by the vehicle's control system. Do not reduce the tire inflation pressure under such circumstances.

- ▶ Switch on the ignition.
- ▶ Press button  or  on the multifunction steering wheel repeatedly until the standard display appears in the multifunction display (▷ page 99).
- ▶ Press button  or  until the current inflation pressure for each tire appears in the multifunction display.

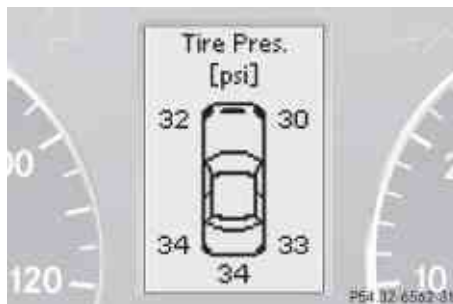

When the vehicle has been parked for longer than 20 minutes, the message Tire



pressure displayed only after driving for a few minutes. appears in the multifunction display.

**i** With a spare wheel mounted, the system may still indicate the tire inflation pressure of the removed road wheel for some minutes. If this happens, keep in mind that the indicated value where the spare wheel is mounted does not reflect the actual spare tire inflation pressure.

**i** USA only:

This device complies with Part 15 of the FCC Rules. Operation is subject to the following two conditions:

1. This device may not cause harmful interference, and
2. this device must accept any interference received, including interference that may cause undesired.

Any unauthorized modification to this device could void the user's authority to operate the equipment.

**i** Canada only:

This device complies with RSS-210 of Industry Canada. Operation is subject to the following two conditions:

1. This device may not cause interference, and
2. this device must accept any interference received, including interference that may cause undesired operation of the device.

Any unauthorized modification to this device could void the user's authority to operate the equipment.

### Tire inflation pressure warnings

If the system detects a significant loss of tire inflation pressure in one or more than one tire, a message appears in the multifunction display. In addition, an acoustic warning sounds and the low tire pressure telltale in the instrument cluster comes on.



The respective tire is indicated by a red rectangle.

### Restarting Advanced TPMS

#### **Warning!**

It is the driver's responsibility to set the tire inflation pressure to the recommended cold tire inflation pressure. Underinflated tires affect the ability to steer or brake the vehicle. You might lose control over the vehicle.



When you restart the TPMS, the system sets new reference values for each tire.

The TPMS must be restarted when you have adjusted the tire inflation pressure to a new level (e.g. because of different load or driving conditions). The TPMS is then recalibrated to the current tire inflation pressures.

**i** Canada only:

The TPMS usually recognizes tire pressure adjustments and sets new reference values automatically. You can, however, restart the TPMS manually as described.

Restart the TPMS after adjusting the tire inflation pressure to the inflation pressure recommended for the vehicle operating condition. Tire pressure should only be adjusted on cold tires. Observe the recommended tire inflation pressure on the Tire and Loading Information placard on the driver's door B-pillar. Some vehicles may have supplemental tire pressure information for driving at high speeds or for vehicle loads less than the maximum loaded vehicle condition. If such information is provided, it can be found on the inside of the fuel filler flap.

- ▶ Press button  or  repeatedly until you see the current inflation pressure for each tire appear in the display or the following message appears in the multifunction display:

Tire pressure  
displayed  
only after  
driving for  
a few minutes.

- ▶ Press the reset button ( $\triangleright$  page 95). The following message will appear in the multifunction display:

Restart  
Tire Pres.  
Monitor?

- ▶ **If you wish to confirm:** Press button



The following message will appear in the multifunction display:

Tire Pres.  
Monitor  
Restarted

After driving a few minutes the system verifies that the current tire inflation pressures are within the system's specified range. Afterwards the current tire inflation pressures are accepted as reference values and then monitored.

- ▶ **If you wish to cancel:** Press button



- i** When the wheel positions have been changed, the air pressure of a tire may be displayed for the wrong position temporarily. After driving for a few minutes, the air pressure will be shown for the correct position.

- i** With a spare wheel mounted, the system may still indicate the tire inflation pressure of the removed road wheel for some minutes. If this happens, keep in mind that the indicated value where the spare wheel

is mounted does not reflect the actual spare tire inflation pressure.

### Maximum tire inflation pressure

#### **Warning!**

Never exceed the maximum tire inflation pressure. Follow recommended tire inflation pressures.

Do not underinflate tires. Underinflated tires wear excessively and/or unevenly, adversely affect handling and fuel economy, and are more likely to fail from being overheated.

Do not overinflate tires. Overinflated tires can adversely affect handling and ride comfort, wear unevenly, increase stopping distance, and result in sudden deflation (blowout) because they are more likely to become punctured or damaged by road debris, potholes etc.



- i** For illustration purposes only. Actual data on tires are specific to each vehicle and may vary from data shown in above illustration.

This is the maximum permissible tire inflation pressure **1** for the tire.

Always follow the recommended tire inflation pressure ( $\triangleright$  page 154) for proper tire inflation.

## Loading the vehicle

Two labels on your vehicle show how much weight it may properly carry.

- (1) The Tire and Loading Information placard can be found on the driver's door B-pillar. This placard tells you important information about the number of people that can be in the vehicle and the total weight that can be carried in the vehicle. It also contains information on the proper size and recommended tire inflation pressures for the original equipment tires on your vehicle.
- (2) The certification label, also found on the driver's door B-pillar. It tells you about the gross weight capacity of your vehicle, called the Gross Vehicle Weight Rating (GVWR). The GVWR includes the weight of the vehicle, all occupants, fuel and cargo. The certification label also tells you about the front and rear axle weight capacity, called the Gross Axle Weight Rating (GAWR).

The GAWR is the total allowable weight that can be carried by a single axle (front or rear). Never exceed the GVWR or GAWR for either the front axle or rear axle.



① Driver's door B-pillar

Following is a discussion on how to work with the information contained on the Tire and Loading Information placard with regards to loading your vehicle.

## Tire and Loading Information

### Warning!

Do not overload the tires by exceeding the specified load limit as indicated on the Tire and Loading Information placard on the driver's door B-pillar. Overloading the tires can overheat them, possibly causing a blowout. Overloading the tires can also result in handling or steering problems, or brake failure.

## Tire and Loading Information placard

- ① Data shown on Tire and Loading Information placard example are for illustration purposes only. Load limit data are specific to each vehicle and may vary from data shown in the following illustration. Refer to Tire and Loading Information placard on vehicle for actual data specific to your vehicle.



The Tire and Loading Information placard showing load limit information ① is located on the driver's door B-pillar (▷ page 161).

- Locate the statement “The combined weight of occupants and cargo should never exceed XXX kilograms or XXX lbs.” on the Tire and Loading Information placard.

The combined weight of all occupants, cargo/luggage and trailer tongue load (if applicable) should never exceed the weight referenced in that statement.

## Seating capacity



The seating capacity gives you important information on the number of occupants that can be in the vehicle. Observe front and rear seating capacity. The Tire and Loading Information placard showing seating capacity ① is located on the driver's door B-pillar (▷ page 161).

**i** Data shown on Tire and Loading Information placard example are for illustration purposes only. Seating capacity data are specific to each vehicle and may vary from data shown in the following illustration. Refer to Tire and Loading Information placard on vehicle for actual data specific to your vehicle.

### Steps for determining correct load limit

The following steps have been developed as required of all manufacturers under Title 49, Code of U.S. Federal Regulations, Part 575 pursuant to the "National Traffic and Motor Vehicle Safety Act of 1966".

- ▶ **Step 1:** Locate the statement "The combined weight of occupants and cargo should never exceed XXX kg or XXX lbs." on your vehicle's Tire and Loading Information placard.
- ▶ **Step 2:** Determine the combined weight of the driver and passengers that will be riding in your vehicle.
- ▶ **Step 3:** Subtract the combined weight of the driver and passengers from XXX kilograms or XXX lbs.

▶ **Step 4:** The resulting figure equals the available amount of cargo and luggage load capacity. For example, if the "XXX" amount equals 1400 lbs and there will be five 150 lbs passengers in your vehicle, the amount of available cargo and luggage load capacity is 650 lbs  
(1400 - 750 (5 x 150) = 650 lbs).

▶ **Step 5:** Determine the combined weight of luggage and cargo being loaded on the vehicle. That weight may not safely exceed the available cargo and luggage load capacity calculated in step 4.

▶ **Step 6 (if applicable):** If your vehicle will be towing a trailer, load from your trailer will be transferred to your vehicle. Consult this manual to determine how this reduces the available cargo and luggage load capacity of your vehicle (▷ page 164).

The following table shows examples on how to calculate total and cargo load capacities with varying seating configurations and number and size of occupants. The following examples use a load limit of 1500 lbs. **This is for illustration purposes only.** Make sure you are using the actual load limit for your vehicle stated on the vehicle's Tire and Loading Information placard (▷ page 162).

		Example 1	Example 2	Example 3
<b>Step 1</b>	<b>Combined weight limit of occupants and cargo from Tire and Loading Information placard</b>	1 500 lbs	1 500 lbs	1 500 lbs

		Example 1	Example 2	Example 3
<b>Step 2</b>	<b>Number of occupants (driver and passengers)</b>	5	3	1
	<b>Seating configuration</b>	front: 2 rear: 3	front: 1 rear: 2	front: 1
	<b>Occupants weight</b>	Occupant 1: 150 lbs Occupant 2: 180 lbs Occupant 3: 160 lbs Occupant 4: 140 lbs Occupant 5: 120 lbs	Occupant 1: 200 lbs Occupant 2: 190 lbs Occupant 3: 150 lbs	Occupant 1: 150 lbs
	<b>Combined weight of all occupants</b>	750 lbs	540 lbs	150 lbs

		Example 1	Example 2	Example 3
<b>Step 3</b>	<b>Available cargo/ luggage and trailer tongue weight (total load limit from Tire and Loading Information placard minus combined weight of all occupants)</b>	1 500 lbs - 750 lbs = 750 lbs	1 500 lbs - 540 lbs = 960 lbs	1 500 lbs - 150 lbs = 1 350 lbs

The higher the weight of all occupants, the less cargo and luggage load capacity is available.

For more information, see “Trailer tongue load” (▷ page 164).

### Certification label

Even after careful determination of the combined weight of all occupants, cargo and the trailer tongue load (if applicable) (▷ page 164) as to not exceed the permissible load limit, you must make sure your vehicle never exceeds the Gross Vehicle

Weight Rating (GVWR) and the Gross Axle Weight Rating (GAWR) for either the front or rear axle. You can obtain the GVWR and GAWR from the certification label. The certification label can be found on the driver's door B-pillar, see the "Technical data" section (> page 246).

**Gross Vehicle Weight Rating (GVWR):** The total weight of the vehicle, all occupants, all cargo, and the trailer tongue load (if applicable) must never exceed the GVWR.

**Gross Axle Weight Rating (GAWR):** The total allowable weight that can be carried by a single axle (front or rear).

To assure that your vehicle does not exceed the maximum permissible weight limits (GVWR and GAWR for front and rear axle), have the loaded vehicle (including driver, passengers and all cargo and, if applicable, trailer fully loaded) weighed on a suitable commercial scale.

### Trailer tongue load

The tongue load of any trailer is an important weight to measure because it affects the load you can carry in your vehicle. If a trailer is towed, the tongue load must be added to the weight of all occupants riding and any cargo you are carrying in the vehicle. The tongue load typically is 10% of the trailer weight and everything loaded in it.

If an approved Mercedes-Benz trailer hitch is available for your G-Class vehicle model, consult the instructions included in the trailer hitch kit for vehicle towing capacity, permissible gross trailer weight, trailer tongue weight rating, and instructions on loading and towing a trailer.

### Maximum tire load

#### Warning!

Do not overload the tires by exceeding the specified load limit as indicated on the Tire and Loading Information placard on the driver's door B-pillar. Overloading the tires can overheat them, possibly causing a blowout. Overloading the tires can also result in handling or steering problems, or brake failure.



**i** For illustration purposes only. Actual data on tires are specific to each vehicle and may vary from data shown in above illustration.

The maximum tire load rating ① is the maximum weight the tires are designed to support.

For more information on tire load rating, see (> page 169).

For information on calculating total and cargo load capacities, see (> page 162).

### Direction of rotation

Unidirectional tires offer added advantages, such as better hydroplaning performance. To benefit, however, you must make sure the tires rotate in the direction specified.

An arrow on the sidewall indicates the intended direction of rotation of the tire.

Spare wheels may be mounted against the direction of rotation (spinning) even with a unidirectional tire for temporary use only until

the regular drive wheel has been repaired or replaced. Always observe and follow applicable temporary use restrictions and speed limitations indicated on the spare wheel.

### Tire care and maintenance

#### Warning!

Regularly check the tires for damage. Damaged tires can cause tire inflation pressure loss. As a result, you could lose control of your vehicle.

Worn, old tires can cause accidents. If the tire tread is worn to minimum tread depth, or if the tires have sustained damage, replace them.

Check the tire inflation pressure at least every other week. For more information on checking tire inflation pressure, see “Recommended tire inflation pressure” (▷ page 154).

### Tire inspection

Every time you check the tire inflation pressure, you should also inspect your tires for the following:

- excessive treadwear (▷ page 165)
- cord or fabric showing through the tire’s rubber
- bumps, bulges, cuts, cracks or splits in the tread or side of the tire

Replace the tire if you find any of the above conditions.

Make sure you also inspect the spare tire periodically for condition and inflation. Spare tires will age and become worn over time even if never used, and thus should be inspected and replaced when necessary.

### Life of tire

#### Warning!

Tires and spare tire should be replaced after 6 years, regardless of the remaining tread.

The service life of a tire is dependent upon varying factors including but not limited to:

- Driving style
- Tire inflation pressure
- Distance driven

### Tread depth

#### Warning!

Although the applicable federal motor vehicle safety laws consider a tire to be worn when the treadwear indicators (TWI) become visible at approximately  $\frac{1}{16}$  in (1.6 mm), we recommend that you do not allow your tires to wear down to that level. As tread depth approaches  $\frac{1}{8}$  in (3 mm), the adhesion properties on a wet road are sharply reduced. Depending upon the weather and/or road surface (conditions), the tire traction varies widely.

Do not allow your tires to wear down too far. Adhesion properties on wet roads are sharply reduced at tread depths of less than  $\frac{1}{8}$  in (3 mm).

Treadwear indicators (TWI) are required by law. These indicators are located in six places on the tread circumference and become visible at a tread depth of approximately  $\frac{1}{16}$  in (1.6 mm), at which point the tire is considered worn and should be replaced.

The recommended minimum tire tread depth for summer tires is  $\frac{1}{8}$  in (3 mm). The recommended minimum tire tread depth for winter tires is  $\frac{1}{6}$  in (4 mm).

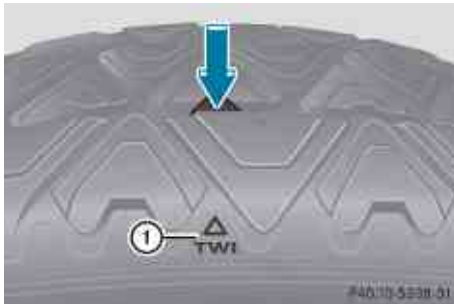

Treadwear indicator ① appears as a solid band across the tread.

### Storing tires

- ❗ Keep unmounted tires in a cool, dry place with as little exposure to light as possible. Protect tires from contact with oil, grease and fuels.

### Cleaning tires

- ❗ Never use a round nozzle to power wash tires. The intense jet of water can result in damage to the tire. Always replace a damaged tire.

### Uniform Tire Quality Grading Standards



The Uniform Tire Quality Grading is a U.S. Government requirement designed to give drivers consistent and reliable information regarding tire performance. Tire manufacturers are required to grade tires

based on three performance factors: treadwear ①, traction ②, and temperature resistance ③. Although not a Government of Canada requirement, all tires made for sale in North America have these grades branded on the sidewall.

- ❗ For illustration purposes only. Actual data on tires are specific to each vehicle and may vary from data shown in above illustration.

Quality grades can be found, where applicable, on the tire sidewall between tread shoulder and maximum section width. For example:

Treadwear	Traction	Temperature
200	AA	A

All passenger car tires must conform to federal safety requirements in addition to these grades.

### Treadwear

The treadwear grade is a comparative rating based on the wear rate of the tire when tested under controlled conditions on a specified U.S. Government test course. For example, a tire graded 150 would wear one and one-half ( $1 \frac{1}{2}$ ) times as well on the government course as a tire graded 100.

The relative performance of tires depends upon the actual conditions of their use, however, and may depart significantly from the norm due to variations in driving habits, service practices and differences in road characteristics and climate.

### Traction

#### ⚠ Warning!

The traction grade assigned to this tire is based on straight-ahead braking traction tests, and does not include acceleration, cornering, hydroplaning, or peak traction characteristics.



The traction grades, from highest to lowest, are AA, A, B, and C. Those grades represent the tire's ability to stop on wet pavement as measured under controlled conditions on specified government test surfaces of asphalt and concrete. A tire marked C may have poor traction performance.

#### **Warning!**

If ice has formed on the road, tire traction will be substantially reduced. Under such weather conditions, drive, steer and brake with extreme caution.

The safe speed on a wet, snow covered or icy road is always lower than on a dry road.

You should pay particular attention to the condition of the road whenever the outside temperature is close to the freezing point.

Mercedes-Benz recommends winter tires (> page 175) with a minimum tread depth of approximately  $\frac{1}{6}$  in (4 mm) on all four wheels for the winter season to ensure normal balanced handling characteristics. On packed snow, they can reduce your stopping distance compared to summer tires. Stopping distance, however, is still considerably greater than when the road is not covered with snow or ice. Exercise appropriate caution.

**!** Avoid spinning of a drive wheel. This may cause serious damage to the drivetrain which is not covered by the Mercedes-Benz Limited Warranty.

### Temperature

#### **Warning!**

The temperature grade for this tire is established for a tire that is properly inflated and not overloaded. Excessive speed, underinflation, or excessive loading, either separately or in combination, can cause excessive heat build-up and possible tire failure.

The temperature grades are A (the highest), B, and C, representing the tire's resistance to

the generation of heat and its ability to dissipate heat when tested under controlled conditions on a specified indoor laboratory test wheel. Sustained high temperature can cause the material of the tire to degenerate and reduce tire life, and excessive temperature can lead to sudden tire failure. The grade C corresponds to a level of performance which all passenger car tires must meet under the Federal Motor Vehicle Safety Standard No. 109. Grades B and A represent higher levels of performance on the laboratory test wheel than the minimum required by law.

### Rotating tires

#### **Warning!**

Rotate front and rear wheels only if the tires are of the same dimension.

If your vehicle is equipped with mixed-size tires (different tire dimensions front vs. rear), tire rotation is not possible.

#### **Warning!**

Have the tightening torque checked after changing a wheel. Wheels could become loose if not tightened with a torque of 96 lb-ft (130 Nm).

Only use genuine Mercedes-Benz wheel bolts specified for your vehicle's rims.

Tire rotation can be performed on vehicles with tires of the same dimension all around. If your vehicle is equipped with tires of the same dimension all around, tires can be rotated, observing a front-to-rear rotation pattern that will maintain the intended rotation (spinning) direction of the tire (> page 164).

In some cases, such as when your vehicle is equipped with mixed-size tires (different tire dimension front vs. rear), tire rotation is not possible.

If applicable to your vehicle's tire configuration, tires can be rotated according

to the tire manufacturer's recommended intervals in the tire manufacturer's warranty pamphlet located in your vehicle literature portfolio. If none is available, tires should be rotated every 3 000 to 6 000 miles (5 000 to 10 000 km), or sooner if necessary, according to the degree of tire wear. The same rotation (spinning) direction must be maintained.

Rotate tires before the characteristic tire wear pattern becomes visible (shoulder wear on front tires and tread center wear on rear tires).

Thoroughly clean the mounting face of wheels and brake disks, i.e. the inner side of the wheels/tires, during each rotation. Check for and ensure proper tire inflation pressure.

For information on wheel change, see "Flat tire" (▷ page 232).

## Operation

### Tire labeling

Besides tire name (sales designation) and manufacturer name, a number of markings can be found on a tire.

Following are some explanations for the markings on your vehicle's tires:

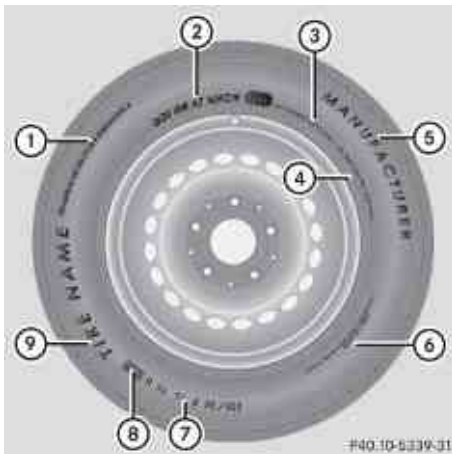

- ① Uniform Tire Quality Grading Standards (▷ page 166)
- ② DOT, Tire Identification Number (▷ page 171)

- ③ Maximum tire load (▷ page 164)
- ④ Maximum tire inflation pressure (▷ page 160)
- ⑤ Manufacturer
- ⑥ Tire ply material (▷ page 172)
- ⑦ Tire size designation, load and speed rating (▷ page 168)
- ⑧ Load identification (▷ page 171)
- ⑨ Tire name

**i** For illustration purposes only. Actual data on tires are specific to each vehicle and may vary from data shown in above illustration.

For more information, see "Rims and tires" (▷ page 250).

### Tire size designation, load and speed rating



- ① Tire width
- ② Aspect ratio in %
- ③ Radial tire code
- ④ Rim diameter
- ⑤ Tire load rating
- ⑥ Tire speed rating

**i** For illustration purposes only. Actual data on tires are specific to each vehicle and may vary from data shown in above illustration.

General: Depending on the design standards used, the tire size molded into the sidewall may have no letter or a letter preceding the tire size designation.

No letter preceding the size designation (as illustrated above): Passenger car tire based on European design standards.

Letter “P” preceding the size designation: Passenger car tire based on U.S. design standards.

Letter “LT” preceding the size designation: Light Truck tire based on U.S. design standards.

Letter “T” preceding the size designation: Temporary spare tires which are high pressure compact spares designed for temporary emergency use only.

### Tire width

Tire width ① indicates the nominal tire width in millimeters.

### Aspect ratio

Aspect ratio ② is the dimensional relationship between tire section height and section width and is expressed in percentage. The aspect ratio is arrived at by dividing section height by section width.

### Tire code

Tire code ③ indicates the tire construction type. The “R” stands for radial tire type. Letter “D” means diagonal or bias ply construction; letter “B” means belted-bias ply construction.

At the tire manufacturer’s option, any tire with a speed capability above 149 mph (240 km/h) can include a “ZR” in the size designation (for example: 245/40 ZR 18). For additional information, see “Tire speed rating” (▷ page 169).

### Rim diameter

Rim diameter ④ is the diameter of the bead seat, not the diameter of the rim edge. The rim diameter is indicated in inches (in).

### Tire load rating

#### Warning!

The tire load rating must always be at least half of the GAWR of your vehicle. Otherwise,

tire failure may be the result which may cause an accident and/or serious injury to you or others.

Always replace rims and tires with the same designation, manufacturer and type as shown on the original part.

#### Warning!

Do not overload the tires by exceeding the specified load limit as indicated on the Tire and Loading Information placard on the driver’s door B-pillar. Overloading the tires can overheat them, possibly causing a blowout. Overloading the tires can also result in handling or steering problems, or brake failure.

Tire load rating ⑤ is a numerical code associated with the maximum load a tire can support.

For example, a load rating of 91 corresponds to a maximum load of 1356 lb (615 kg) the tire is designed to support. See also “Maximum tire load” (▷ page 164) where the maximum load associated with the load index is indicated in kilograms and lbs.

For additional information on tire load rating, see “Load identification” (▷ page 171).

### Tire speed rating

#### Warning!

Even when permitted by law, never operate a vehicle at speeds greater than the maximum speed rating of the tires.



Exceeding the maximum speed for which tires are rated can lead to sudden tire failure, causing loss of vehicle control and possibly resulting in an accident and/or serious personal injury and possible death, for you and for others.

Regardless of the tire speed rating, local speed limits should be obeyed. Use prudent driving speeds appropriate to prevailing conditions.

Tire speed rating ⑥ indicates the approved maximum speed for the tire.

## Summer tires

Index	Speed rating
Q	up to 100 mph (160 km/h)
R	up to 106 mph (170 km/h)
S	up to 112 mph (180 km/h)
T	up to 118 mph (190 km/h)
H	up to 130 mph (210 km/h)
V	up to 149 mph (240 km/h)
W	up to 168 mph (270 km/h)
Y	up to 186 mph (300 km/h)
ZR...Y	up to 186 mph (300 km/h)
ZR...(..Y)	above 186 mph (300 km/h)
ZR	above 149 mph (240 km/h)



- At the tire manufacturer's option, any tire with a speed capability above 149 mph (240 km/h) can include a "ZR" in the size designation (for example: 245/40 ZR18). To determine the maximum speed capability of the tire, the service description for the tire must be referred to. The service description is comprised of tire load rating  and tire speed rating . If your tire includes "ZR" in the size designation and no service description is given, the tire manufacturer must be consulted for the maximum speed capability. If a service description is given, the speed capability is limited by the speed symbol in the service description. Example: 245/40 ZR18 97Y. In this example, "97Y" is the service description. The letter "Y" designates the speed rating and the speed capability of the tire is limited to 186 mph (300 km/h).
- Any tire with a speed capability above 186 mph (300 km/h) must include a "ZR"

<sup>8</sup> or M+S  for winter tires

in the size designation AND the service description must be placed in parenthesis. Example: 275/40 ZR 18 (99Y). The "(Y)" speed rating in parenthesis designates the maximum speed capability of the tire as being above 186 mph (300 km/h). Consult the tire manufacturer for the actual maximum permissible speed of the tire.

## All-season and winter tires

Index	Speed rating
Q M+S <sup>8</sup>	up to 100 mph (160 km/h)
T M+S <sup>8</sup>	up to 118 mph (190 km/h)
H M+S <sup>8</sup>	up to 130 mph (210 km/h)
V M+S <sup>8</sup>	up to 149 mph (240 km/h)

 Not all M+S rated tires provide special winter performance. Make sure the tires you use show M+S and the mountain/snowflake  marking on the tire sidewall. These tires meet specific snow traction performance requirements of the Rubber Manufacturers Association (RMA) and the Rubber Association of Canada (RAC) and have been designed specifically for use in snow conditions.

An electronic speed limiter prevents your vehicle from exceeding a speed of 130 mph (210 km/h).

The factory equipped tires on your vehicle may have a tire speed rating above the maximum speed permitted by the electronic speed limiter.

Make sure your tires have the required tire speed rating as specified for your vehicle in the "Technical data" section ( page 250), for example when purchasing new tires.

If you are uncertain about the correct reading of the information given on a tire's sidewall,

any authorized Mercedes-Benz Center will be glad to assist you.

### Load identification



**i** For illustration purposes only. Actual data on tires are specific to each vehicle and may vary from data shown in above illustration.

In addition to tire load rating, special load identification ① may be molded into the tire sidewall following the letter designating the tire speed rating ⑥ (▷ page 168).

- No specification given: absence of any text (like in above example) indicates a standard load (SL) tire.
- XL or Extra Load: designates an extra load (or reinforced) tire.
- Light Load: designates a light load tire.
- C, D, E: designates load range associated with the maximum load a tire can carry at a specified pressure.

### DOT, Tire Identification Number (TIN)

U.S. tire regulations require each new tire manufacturer or tire retreader to mold a TIN into or onto a sidewall of each tire produced.



The TIN is a unique identifier which facilitates efforts by tire manufacturers to notify purchasers in recall situations or other safety matters concerning tires and gives purchasers the means to easily identify such tires.

The TIN is comprised of “Manufacturer’s identification mark” ②, “Tire size” ③, “Tire type code” ④ and “Date of manufacture” ⑤.

**i** For illustration purposes only. Actual data on tires are specific to each vehicle and may vary from data shown in above illustration.

### DOT (Department of Transportation)

Tire branding symbol ① denotes that the tire meets requirements of the U.S. Department of Transportation.

### Manufacturer’s identification mark

Manufacturer’s identification mark ② denotes the tire manufacturer.

New tires have a mark with two symbols.

Retreaded tires have a mark with four symbols. For more information on retreaded tires, see (▷ page 154).

### Tire size

Code ③ indicates the tire size.

### Tire type code

Tire type code ④ may, at the option of the manufacturer, be used as a descriptive code for identifying significant characteristics of the tire.

### Date of manufacture

The date of manufacture ⑤ identifies the week and year of manufacture.

The first two figures identify the week, starting with “01” to represent the first full week of the calendar year. The second two figures represent the year.

For example, “3202” represents the 32nd week of 2002.

Operation

### Tire ply material



**i** For illustration purposes only. Actual data on tires are specific to each vehicle and may vary from data shown in above illustration.

This marking tells you about the type of cord and number of plies in the sidewall ① and under the tread ②.

### Tire and loading terminology

#### Accessory weight

The combined weight (in excess of those standard items which may be replaced) of automatic transmission, power steering, power brakes, power windows, power seats, radio, and heater, to the extent that these items are available as factory-installed equipment (whether installed or not).

#### Air pressure

The amount of air inside the tire pressing outward on each square inch of the tire. Air pressure is expressed in pounds per square inch (psi), or kilopascal (kPa) or bar.

#### Aspect ratio

Dimensional relationship between tire section height and section width expressed in percentage.

#### Bar

Another metric unit for air pressure. There are 14.5038 pounds per square inch (psi) to 1 bar; there are 100 kilopascals (kPa) to 1 bar.

#### Bead

The tire bead contains steel wires wrapped by steel cords that hold the tire onto the rim.

#### Cold tire inflation pressure

Tire inflation pressure when your vehicle has been sitting for at least 3 hours or driven no more than 1 mile (1.6 km).

#### Curb weight

The weight of a motor vehicle with standard equipment including the maximum capacity of fuel, oil, and coolant, and, if so equipped, air conditioning and additional optional equipment, but without passengers and cargo.

### **DOT (Department of Transportation)**

A tire branding symbol which denotes the tire meets requirements of the U.S. Department of Transportation.

### **GAWR (Gross Axle Weight Rating)**

The GAWR is the maximum permissible axle weight. The gross vehicle weight on each axle must never exceed the GAWR for the front and rear axle indicated on the certification label located on the driver's door B-pillar.

### **GTW (Gross Trailer Weight)**

The GTW is the weight of the trailer plus the weight of all cargo, equipment, luggage etc. loaded on the trailer.

### **GVW (Gross Vehicle Weight)**

The GVW comprises the weight of the vehicle including fuel, tools, spare wheel, installed accessories, passengers and cargo and, if applicable, trailer tongue load. The GVW must never exceed the GVWR indicated on the certification label located on the driver's door B-pillar.

### **GVWR (Gross Vehicle Weight Rating)**

This is the maximum permissible vehicle weight of the fully loaded vehicle (weight of the vehicle including all options, passengers, fuel, and cargo and, if applicable, trailer tongue load). It is indicated on certification label located on the driver's door B-pillar.

### **Kilopascal (kPa)**

The metric unit for air pressure. There are 6.9 kPa to 1 psi; another metric unit for air pressure is bar. There are 100 kilopascals (kPa) to 1 bar.

### **Maximum load rating**

The maximum load in kilograms and pounds that can be carried by the tire.

### **Maximum loaded vehicle weight**

The sum of curb weight, accessory weight, total load limit, and production options weight.

### **Maximum permissible tire inflation pressure**

This number is the greatest amount of air pressure that should ever be put in the tire.

### **Normal occupant weight**

The number of occupants the vehicle is designed to seat, multiplied by 68 kilograms (150 lb).

### **Occupant distribution**

The distribution of occupants in a vehicle at their designated seating positions.

### **Production options weight**

The combined weight of those installed regular production options weighing over 5 lbs (2.3 kilograms) in excess of those standard items which they replace, not previously considered in curb weight or accessory weight, including heavy duty brakes, ride levelers, roof rack, heavy duty battery, and special trim.

### **PSI (Pounds per square inch)**

A standard unit of measure for air pressure.

### **Recommended tire inflation pressure**

The recommended tire inflation pressure for normal driving conditions is listed on the Tire and Loading Information placard located on the driver's door B-pillar and provides best handling, tread life and riding comfort. If so equipped, supplemental information

pertaining to special driving situations can be found on the tire inflation pressure label on the inside of the fuel filler flap.

### **Rim**

---

A metal support for a tire or a tire and tube assembly upon which the tire beads are seated.

### **Sidewall**

---

The portion of a tire between the tread and the bead.

### **TIN (Tire Identification Number)**

---

Unique identifier which facilitates efforts by tire manufacturers to notify purchasers in recall situations or other safety matters concerning tires and gives purchasers the means to easily identify such tires. The TIN is comprised of “Manufacturer’s identification mark”, “Tire size”, “Tire type code” and “Date of manufacture”.

### **Tire load rating**

---

Numerical code associated with the maximum load a tire can support.

### **Tire ply composition and material used**

---

This indicates the number of plies or the number of layers of rubber-coated fabric in the tire tread and sidewall. Tire manufacturers also must indicate the ply materials in the tire and sidewall, which include steel, nylon, polyester, and others.

### **Tire speed rating**

---

Part of tire designation; indicates the speed range for which a tire is approved.

### **Total load limit**

---

Rated cargo and luggage load plus 68 kilograms (150 lb) times the vehicle’s designated seating capacity.

### **Traction**

---

Force exerted by the vehicle on the road via the tires. The amount of grip provided.

### **Tread**

---

The portion of a tire that comes into contact with the road.

### **Treadwear indicators**

---

Narrow bands, sometimes called “wear bars” that show across the tread of a tire when only  $\frac{1}{16}$  in (1.6 mm) of tread remains.

### **TWR (Tongue Weight Rating)**

---

Maximum permissible weight on trailer tongue.

### **Uniform Tire Quality Grading Standards**

---

A tire information system that provides consumers with ratings for a tire’s traction, temperature and treadwear. Ratings are determined by tire manufacturers using U.S. government testing procedures. The ratings are molded into the sidewall of the tire.

### **Vehicle maximum load on the tire**

---

Load on an individual tire that is determined by distributing to each axle its share of the maximum loaded vehicle weight and dividing it by two.



## Winter driving

### General information

Have your vehicle winterized at an authorized Mercedes-Benz Center.

### Winter tires

#### **Warning!**

Winter tires with a tread depth of less than  $\frac{1}{8}$  in (4 mm) must be replaced. They are no longer suitable for winter operation.

#### **Warning!**

If you use your spare wheel when winter tires are fitted on the other wheels, be aware that the difference in tire characteristics may very well impair turning stability and that overall driving stability may be reduced. Adapt your driving style accordingly.

Have the spare wheel replaced by regular road wheel with a winter tire at the nearest authorized Mercedes-Benz Center.

Always use winter tires at temperatures below 45°F (7°C) and whenever wintry road conditions prevail. Not all M+S rated tires provide special winter performance. Make sure the tires you use show the mountain/snowflake  marking on the tire sidewall. These tires meet specific snow traction performance requirements of the Rubber Manufacturers Association (RMA) and the Rubber Association of Canada (RAC) and have been designed specifically for use in snow conditions. Use of winter tires is the only way to achieve the maximum effectiveness of your vehicle's driving safety systems such as the ABS and the ESP® in winter operation.

For safe handling, make sure all mounted winter tires are of the same make and have the same tread design.

For information on winter tires for your vehicle model, see the "Technical data" section (▷ page 250).

Always observe the speed rating of the winter tires installed on your vehicle.

### Snow chains

 Some tire sizes do not leave adequate clearance for snow chains. To help avoid serious damage to your vehicle or tires, make sure the use of snow chains is permissible as specified in the "Technical data" section of this Operator's Manual.

Snow chains should only be driven on snow-covered roads at speeds not to exceed 30 mph (50 km/h). Remove chains as soon as possible when driving on roads without snow.

Observe the following guidelines when using snow chains:

- Use of snow chains is not permissible with all wheel/tire combinations (▷ page 250).
- Use snow chains in pairs and on rear wheels only. Follow the manufacturer's mounting instructions.

 If snow chains are mounted to the front wheels, they may scrape against the body or axle components. The tires or the vehicle could be damaged as a result.

- Only use snow chains that are approved by Mercedes-Benz. Any authorized Mercedes-Benz Center will be glad to advise you on this subject.
- Use of snow chains may be prohibited depending on location. Always check local and state laws before installing snow chains.

 When driving with snow chains, you may wish to switch off the ESP® (▷ page 52) before setting the vehicle in motion. This will improve the vehicle's traction.

**Winter driving instructions** **Warning!**

If the vehicle becomes stuck in snow, make sure snow is kept clear of the exhaust pipe and from around the vehicle with the engine running. Otherwise, deadly carbon monoxide (CO) gases may enter vehicle interior resulting in unconsciousness and death.

To assure sufficient fresh air ventilation, open a window slightly on the side of the vehicle not facing the wind.

 **Warning!**

The outside temperature indicator is not designed to serve as an ice-warning device and is therefore unsuitable for that purpose.

Indicated temperatures just above the freezing point do not guarantee that the road surface is free of ice. The road may still be icy, especially in wooded areas or on bridges.

 **Warning!**

On slippery road surfaces, never downshift in order to obtain braking action. This could result in drive wheel slip and reduced vehicle control. Your vehicle's ABS will not prevent this type of control loss.

Do not engage the transfer case in position **LOW** when driving on ice or packed snow. At speeds below 18 mph (30 km/h) vehicle steering is adversely affected by the LOW-RANGE ABS.

The most important rule for slippery or icy roads is to drive sensibly and to avoid abrupt acceleration, braking and steering maneuvers. Do not use the cruise control system under such conditions.

When the vehicle is in danger of skidding, shift the automatic transmission to neutral position **N**. Try to keep the vehicle under control by corrective steering action.

 For information on driving with snow chains, see "Snow chains" (▷ page 175).

Road salts and chemicals can adversely affect braking efficiency. Increased pedal force may become necessary to produce the normal brake effect.

Depressing the brake pedal periodically when traveling at length on salt-strewn roads can bring road-salt-impaired braking efficiency back to normal.

If the vehicle is parked after being driven on salt-treated roads, the braking efficiency should be tested as soon as possible after driving is resumed.

 **Warning!**

Make sure not to endanger any other road users when carrying out these braking maneuvers.

**Driving instructions****Drive sensibly – save fuel**

To save fuel you should:

- Keep tires at the recommended inflation pressures.
- Remove unnecessary loads.
- Allow engine to warm up under low load use.
- Avoid frequent acceleration and deceleration.
- Have all maintenance work performed at the intervals specified in the Maintenance Booklet and as required by the Maintenance system. Contact an authorized Mercedes-Benz Center.

Fuel consumption is also increased by driving in cold weather, in stop-and-go traffic, on short trips and in mountainous areas.

## Drinking and driving

### Warning!

Drinking and driving and/or taking drugs and driving are very dangerous combinations. Even a small amount of alcohol or drugs can affect your reflexes, perceptions and judgment.

The possibility of a serious or even fatal accident are greatly increased when you drink or take drugs and drive.

Do not drink or take drugs and drive or allow anyone to drive who has been drinking or taking drugs.

## Pedals

### Warning!

Make sure absolutely no objects are obstructing the pedals' range of movement. Keep the driver's footwell clear of all obstacles. If there are any floor mats or carpets in the footwell, make sure that the pedals still have sufficient clearance.

During sudden driving or braking maneuvers, the objects could get caught between the pedals. You could then no longer brake or accelerate. This could lead to accidents and injury.

## Power assistance

### Warning!

There is no power assistance for the steering and the service brake when the engine is not running.

Steering and braking requires significantly more effort and you could lose control of the vehicle and cause an accident as a result.

Do not turn off the engine while the vehicle is in motion.

## Brakes

### Downhill grades

 When driving down long and steep grades, relieve the load on the brakes by shifting into a lower gear to use the engine's braking power. This helps prevent overheating of the brakes and reduces wear.

When using the engine's braking power, a drive wheel may not spin for an extended period of time, e.g. on slippery road surfaces. This may cause serious damage to the drivetrain which is not covered by the Mercedes-Benz Limited Warranty.

### Continuous or hard braking

#### Warning!

Resting your foot on the brake pedal will cause excessive and premature wear of the brake pads.

It can also result in the brakes overheating, thereby significantly reducing their effectiveness. It may not be possible to stop the vehicle in sufficient time to avoid an accident.

After hard braking, it is advisable to drive on for some time, rather than immediately park, so that the air stream will cool down the brakes faster.

### Wet roads

#### Warning!

After driving in heavy rain for some time without applying the brakes or through water deep enough to wet brake components, the first braking action may be somewhat reduced and increased pedal pressure may be necessary to obtain expected brake effect. Maintain a safe distance from vehicles in front.

To help prevent brake disk corrosion after driving on wet or salt-covered roads, it is advisable to brake the vehicle with

considerable force prior to parking. The heat generated serves to dry the brakes.

### Salt-covered roads

#### Warning!

A layer of salt on the brake discs and the brake linings may cause a delay in the braking effect, resulting in a significantly increased braking distance, which could lead to an accident.

To avoid this danger, you should:

- occasionally brake carefully when you are driving on salt-covered roads, so that any layer of salt that may have built up on the brake discs and the brake linings is removed without putting other road users at risk
- maintain a greater distance to the vehicle ahead and drive with particular care
- carefully apply the brakes at the end of a trip and immediately after commencing a new trip, so that salt residues are removed from the brake disc

### Brake service

 The brake fluid level in the reservoir may be too low if the brake warning lamp in the instrument cluster comes on although the parking brake is released. Observe additional messages in the multifunction display that may appear.

Brake pad wear or a leak in the system may be the reason for low brake fluid in the reservoir.



Have the brake system inspected immediately. Contact an authorized Mercedes-Benz Center.

All checks and service work on the brake system should be carried out by qualified technicians only. Contact an authorized Mercedes-Benz Center.

Only install brake pads and use brake fluid recommended by Mercedes-Benz.

#### Warning!

If other than recommended brake pads are installed, or other than recommended brake fluid is used, the braking properties of the vehicle can be degraded to an extent that safe braking is substantially impaired. This could result in an accident.

-  Only conduct operational or performance tests on a two-axle dynamometer. If such tests are necessary, contact an authorized Mercedes-Benz Center. You could otherwise seriously damage the brake system or the transfer case which is not covered by the Mercedes-Benz Limited Warranty.
-  Because the ESP<sup>®</sup> operates automatically, the engine and ignition must be shut off (SmartKey in starter switch position **0** or **1**) when the parking brake is being tested on a brake test dynamometer. Such testing should be no longer than 10 seconds.

Active braking action through the ESP<sup>®</sup> may otherwise seriously damage the brake system which is not covered by the Mercedes-Benz Limited Warranty.

If your brake system is normally only subjected to moderate loads, you should occasionally test the effectiveness of the brakes by applying above-normal braking pressure at higher speeds. This will also enhance the grip of the brake pads.

#### Warning!

Make sure not to endanger any other road users when carrying out these braking maneuvers.

### Driving off

Warm up the engine smoothly. Do not place full load on the engine until the operating temperature has been reached.

**!** When driving off on a slippery surface, do not allow a drive wheel to spin for an extended period with the ESP® switched off. Doing so may cause serious damage to the drivetrain which is not covered by the Mercedes-Benz Limited Warranty.

**!** Simultaneously depressing the accelerator pedal and applying the brakes reduces engine performance and causes premature brake and drivetrain wear which is not covered by the Mercedes-Benz Limited Warranty.

### Hydroplaning

Depending on the depth of the water layer on the road, hydroplaning may occur, even at low speeds and with new tires. In heavy rain or when conditions indicate possible hydroplaning:

- ▶ Reduce vehicle speed.
- ▶ Avoid track grooves in the road.
- ▶ Apply brakes cautiously.

### Standing water

**!** Do not drive through flooded areas. Before driving through water, determine its depth.

If you must drive through standing water, drive slowly to prevent water from entering the passenger compartment or the engine compartment. Water in these areas could cause damage to electrical components or wiring of the engine or transmission, or could result in water being ingested by the engine through the air intake causing severe internal engine damage. Any such

damage is not covered by the Mercedes-Benz Limited Warranty.

Prevent water from entering the passenger compartment or the engine compartment. If you must drive through standing water, keep in mind that

- the maximum depth of the water may not exceed 19 in (48 cm)
- you must drive slowly

For more information, see “Driving through water” (▷ page 182).

### Off-road driving

#### Warning!

Do not load items on the roof. It may cause instability during some maneuvers which could result in an accident.

Drive slowly in unknown terrain. This will make it easier to recognize unexpected obstacles and avoid damage to the vehicle.

To help avoid the vehicle rolling over, never turn it around on steep inclines. If the vehicle cannot complete the attempted climb, back it down in reverse gear.

Do not drive along the side of a slope. The vehicle might otherwise rollover. If in doing so the vehicle begins to show a tendency to roll, immediately steer into a line of gravity (straight up or downhill).

Never let the vehicle roll backwards in idle. You may lose control of the vehicle if you use only the service brake. For information on driving downhill, see “Driving downhill”.

#### Warning!

Sand, dirt, mud and other material having friction property can cause exceptional wear and tear as well as brake failure.

Have the brakes checked for dirt build-up and cleaned. There is otherwise a risk that full braking power may not be available in an emergency.

Read this chapter carefully before you begin off-road travel.

Familiarize yourself with the vehicle characteristics and gear changing before you attempt any difficult terrain off-road driving. We recommend that you start out with easy off-road travel.

### Special driving features for off-road driving

The following driving features are available for specific kind of operation:

- ABS (▷ page 51)
- ESP® (▷ page 52)
- 4-ETS (▷ page 53)
- Differential locks (▷ page 93)
- Transfer case (▷ page 91)

### Off-road driving rules

- Engage the transfer case in position **LOW** before driving under off-road conditions (▷ page 91).
- If necessary, activate differential locks (▷ page 93).  
The ABS, BAS and ESP® are switched off automatically when the differential locks are activated.
- Fasten items being carried as securely as possible (▷ page 126).

**!** Observe the following during off-road driving:

- Keep doors, tailgate, windows, and tilt/sliding sunroof closed whenever driving off-road.
- Switch the cruise control off.
- Adjust vehicle speed to condition of terrain. The more uneven, rutty and steeper the terrain, the lower the speed should be. Drive through water slowly at an even speed, avoiding a bow wave.

- Be especially careful when driving in unknown territory. It may be necessary to get out of the vehicle and scout the path you intend to take.
- Watch out for obstacles, such as rocks, holes, tree stumps and ruts.
- Avoid excessive engine speeds – drive at moderate engine speeds (max. 3000 rpm).
- Before driving through water, determine its depth.
- Do not stop vehicle while immersed in water, and do not shut off the engine.
- In sandy soil, drive at a steady speed as allowed by conditions. This helps overcome the vehicle rolling resistance and reduces the likelihood of the vehicle sinking into the ground.
- Do not initiate jumps with the vehicle. It interrupts the forward momentum of the vehicle.
- Always drive onto slopes with the engine running and the vehicle in gear.
- Do not shift automatic transmission into neutral position **N**.
- Inspect the vehicle for possible damage after each off-road trip.

#### **Warning!**

Do not reduce the tire inflation pressure before driving through sand. However, if you do so, remember to correct the tire inflation pressure before continuing your trip. Driving with reduced tire inflation pressure increases the risk of losing control of the vehicle and rolling over.

### Checklist before off-road driving

#### Engine oil level

- Check the engine oil level (▷ page 149).

Only with a proper oil level can the vehicle obtain a trouble-free oil supply, even on steep gradients.

- !** If an engine oil level warning message appears in the multifunction display while driving, stop the vehicle in a safe location or as soon as it is safe to do so. Check the engine oil level.

The engine oil level warning messages should not be ignored. Extended driving with the message displayed could result in serious engine damage that is not covered by the Mercedes-Benz Limited Warranty.

### Tires

- Check the tread depth and maintain specified tire inflation pressure. A placard with the recommended tire inflation pressures is located on the driver's door B-pillar (▷ page 161).
- Check tires for possible damage and remove foreign objects.
- Replace missing valve caps.

### Rims

- Dented or bent rims can cause tire inflation pressure loss and damage the tire beads. For this reason, check and, if necessary, change rims before driving off-road.

### Vehicle tool kit

- Check if the jack (▷ page 195) is functional.
- Always take the vehicle tool kit, a strong tow rope, a shovel and a small plank (to put under the jack on sandy soil) with you.

### Driving in steep terrain



Slope angle

- ① Overhang angle, front
- ② Overhang angle, rear

	①	②
G 550	37°	31°
G 55 AMG	23°	26°

- Comply with the warnings (▷ page 179) and rules for off-road driving (▷ page 180).
  - Driving on embankments, slopes and other steep inclines should only be done straight up or downhill, i. e. in the line of gravity. Maximum vehicle climbing ability is a 80% grade which is equivalent to a slope angle of approximately 38°. Keep in mind that the climbing ability of the vehicle depends on terrain conditions.
  - Shift automatic transmission into gear range **2** or **1** (▷ page 89).
  - Drive slowly.
  - Utilize the engine's braking power when descending a slope, observe the engine speed (do not overrev the engine). Apply the service brake as needed.
- i** For maximum engine speed, see "Tachometer" (▷ page 96) and see vehicle specification for your vehicle (▷ page 248).
- Check the brakes after a lengthy downgrade drive.

**⚠ Warning!**

Never turn the vehicle around on steep inclines. The vehicle might roll over. If the vehicle cannot complete the attempted climb, back it down in reverse gear.

**Traction in steep terrain**

Be easy on the accelerator and watch for continuous wheel traction when driving in steep terrain.

- i** The 4-ETS helps greatly when starting out on a steep incline when the front wheels have then the tendency to slip due to the weight shifting away from the front axle. The 4-ETS recognizes the situation and limits the torque for the front wheels by braking them. Simultaneously the torque for the rear wheels is increased.

**Driving across a hilltop**

Decelerate just ahead of a hilltop (do not shift automatic transmission into neutral position **N**), to prevent the vehicle from speeding up too much after climbing a hill.

Use the momentum of the vehicle to drive across the hilltop.

After climbing a hill, driving in this manner prevents the vehicle from:

- losing ground contact when cresting hills
- losing its forward momentum
- speeding up too much after climbing the hill

**Driving downhill**

- Shift automatic transmission into gear range **1** (▷ page 89).
- Drive downhill observing the same rules as driving uphill (▷ page 181).
- i** The special LOW RANGE – ABS (▷ page 51) setting allows for precise and brief (cyclical) blocking of the front wheels, permitting them to dig into loose ground.

Remember that, when stopped, the front wheels slide across a surface and thus lose their ability to steer the vehicle.

**Driving through water****① Fording depth, 20 in (50 cm)**

- Before driving through water, determine its depth.
- !** The water depth must not exceed 20 in (50 cm). The ground under the water might not be firm which could result the water being deeper than expected when driving the vehicle through it. Please note that the water level is correspondingly lower for flowing water.
- Comply with the warnings (▷ page 179) and rules for off-road driving (▷ page 180).
- Switch off the exterior lamps as well as the climate control.
- Shift automatic transmission into gear range **1** or **2** (▷ page 89).
- Avoid high engine speeds.
- Enter and leave the water only at a shallow spot, driving at walking speed.
- !** Never accelerate before driving into the water. The bow wave could force water into the engine and auxiliary equipment, thus damaging them.
- Drive through the water slowly and at a constant speed.
- Do not stop vehicle while immersed in water, and do not shut off the engine.



- !** Do not open any of the vehicle's doors while driving through water. Water could otherwise enter the vehicle interior and damage the vehicle's electronics, as well as the interior equipment.
- There is a very high level of driving resistance in water. The surface is slippery and may not be firm, making pulling away in water difficult and dangerous.
  - Make sure that only small bow waves are formed when driving the vehicle through water.
  - Clean mud off the tire tread after driving through water.
  - To dry the brakes, apply pressure to the brake pedal several times while driving after leaving the water.

### Crossing obstacles



- !** Obstacles can damage the vehicle underbody or suspension components. If possible use the assistance of a second person outside the vehicle to scout the path you intend to take and check for adequate ground clearance when you cross obstacles with your vehicle. The person assisting you outside the vehicle should always be a safe distance away from the vehicle and positioned so that he or she cannot get hurt in case of any unexpected vehicle movement.
- After off-road driving or crossing obstacles, inspect vehicle for any damage, especially

vehicle underbody and suspension components. Failure to do so can adversely affect the vehicle's future performance, including increased chance of an accident.

When driving over tree stumps, big rocks and other obstacles, observe the following rules:

- Comply with the warnings (▷ page 179) and rules for off-road driving (▷ page 180).
- Avoid high engine speeds.
- Shift automatic transmission into gear range **1** (▷ page 89).
- Check the vehicle clearance before crossing obstacles.
- Cross obstacles (e. g. tree stumps or big rocks) very slowly by aiming one of the front wheels at the center of the obstacle, and repeat same with the rear wheel.

- !** Special attention is needed when you cross obstacles on a steep incline.

The vehicle could slide sideways as a result of its possible slanted position which in turn may result in the vehicle tipping or rolling over.

### Driving on sand

#### **Warning!**

Do not reduce the tire inflation pressure before driving through sand. However, if you do so, remember to correct the tire inflation pressure before continuing your trip. Driving with reduced tire inflation pressure increases the risk of losing control of the vehicle and rolling over.

When driving on sand, observe the following rules:

- Avoid high engine speeds.
- Shift automatic transmission into a gear range that is appropriate for the terrain.
- In sandy soil, drive at a steady speed as conditions permit. This helps overcome the vehicle rolling resistance and reduce the

likelihood of the vehicle sinking into the ground.

- Drive in tracks of other vehicles if they are not too deep and you have sufficient clearance.

### Ruts

A number of off-road tracks or other byways have deep ruts which can cause the underbody to come in contact with the ground.

**!** Check that the ruts are not too deep and your vehicle's clearance is sufficient. Otherwise:

- your vehicle may be damaged
- the underbody of the vehicle may come in contact with the ground and you may get stuck
- Avoid high engine speeds.
- Comply with the warnings (▷ page 179) and rules for off-road driving (▷ page 180).
- Shift automatic transmission into gear range **1** (▷ page 89).
- Drive next to the ruts rather than through them if at all possible.
- If the ruts are too deep to drive in, drive with one side of the vehicle on the grassy center strip if the route permits.

### Returning from off-road driving

#### **Warning!**

Never drive on pavement with activated differential locks. Engaged front axle differential locks limits ability to move around curves.

If you feel a sudden significant vibration or ride disturbance, or you suspect that possible damage to your vehicle has occurred, you should turn on the hazard warning flashers, carefully slow down, and drive with caution to an area which is a safe distance from the road.

Inspect the tires and the vehicle underbody for possible damage. If the vehicle or tires appear unsafe, have the vehicle towed to the nearest authorized Mercedes-Benz Center or tire dealer for repairs.

Off-road driving increases strain on the vehicle.

We recommend that you inspect the vehicle for possible damage after each off-road trip. Recognizing any damage and a subsequent timely repair reduces the chance of a possible breakdown or accident later on.

Proceed as follows:

- Switch the transfer case to position **HIGH** (▷ page 91).
- Switch differential locks off (▷ page 93).
- Clean all exterior lamps and check for possible damage.
- Clean the front and rear license plate.
- Remove excessive dirt from tires, wheels, wheel housings, and underbody. For instance, after driving in mud, clean the radiator, chassis, engine, brakes, and wheels from extreme dirt using a strong jet of water.
- Check tires for possible damage.
- Inspect vehicle underbody, oil pan, brake hoses, etc., as well as vehicle underbody for possible damage.
- Check for brush or branches caught in the underbody.
- **!** Brush or branches could increase the possibility of a fire, as well as cut fuel and/or brake lines, puncture rubber bellows of the axles or drive shafts.
- After continued operation in mud, sand, water or other dirty conditions clean the brake discs, wheels, brake pads and check and clean axle joints.
- Conduct a brake test.

### Driving abroad

If you plan to drive the vehicle outside the U.S. or Canada, you should request dealer network information for your destination from any authorized Mercedes-Benz Center.

### Control and operation of radio transmitters

#### Safety notes

##### **Warning!**

Please do not forget that your primary responsibility is to drive the vehicle. A driver's attention to the road must always be his/her primary focus when driving. For your safety and the safety of others, we recommend that you pull over to a safe location and stop before placing or taking a telephone call.

If you choose to use the telephone<sup>9</sup> while driving, please use the hands-free device and only use the telephone when road, weather and traffic conditions permit. Some jurisdictions prohibit the driver from using a mobile telephone while driving a vehicle.

Only operate the audio system or COMAND<sup>9</sup> (Cockpit Management and Data System) if road, weather and traffic conditions permit. Otherwise, you may not be able to observe traffic conditions and could endanger yourself and others.

Bear in mind that at a speed of just 30 mph (approximately 50 km/h), your vehicle is covering a distance of 44 feet (approximately 14 m) every second.

### Emission control

Certain systems of the engine serve to keep the toxic components of the exhaust gases within permissible limits required by law. These systems will function properly only when maintained strictly according to factory

specifications. Any adjustments on the engine should, therefore, be carried out only by qualified Mercedes-Benz Center authorized technicians.

Engine adjustments should not be altered in any way. Moreover, the specified service procedures must be carried out regularly according to Mercedes-Benz servicing requirements. For details refer to the Maintenance Booklet.

##### **Warning!**

Inhalation of exhaust gas is hazardous to your health. All exhaust gas contains carbon monoxide (CO), and inhaling it can cause unconsciousness and possible death.

Do not run the engine in confined areas (such as a garage) which are not properly ventilated. If you think that exhaust gas fumes are entering the vehicle while driving, have the cause determined and corrected immediately. If you must drive under these conditions, drive only with at least one window fully open at all times.

### Maintenance

#### Notes

The Maintenance System in your vehicle tracks the distance driven and the time elapsed since the last maintenance service. It calculates other maintenance service work required, and calls for the next maintenance service accordingly.

We strongly recommend that you have your vehicle serviced at an authorized Mercedes-Benz Center, in accordance with the Maintenance Booklet at the times called for by the maintenance service indicator.

-  Failure to have the vehicle maintained in accordance with the Maintenance Booklet and maintenance service indicator at the designated times/mileage will result in

<sup>9</sup> Observe all legal requirements.

vehicle damage not covered by the Mercedes-Benz Limited Warranty.

### Maintenance service indicator message

The maintenance service indicator message will notify you when the next maintenance service is due.



Service A In XXXXX Miles (km)

Service A In XXX Days

Service A Due Now



The type of maintenance service due is indicated in the multifunction display:

-  Basic service (A)
-  Extended service (B)

Refer to Maintenance Booklet for a listing of maintenance services and intervals they need to be performed at.

### Clearing the maintenance service indicator message

The maintenance service indicator message is cleared automatically

- after approximately 10 seconds when you switch on the ignition
- after approximately 10 seconds when reaching the service threshold while driving
- after approximately 30 seconds, once the suggested maintenance service term has passed



- ▶ **Clearing the maintenance service indicator message manually:** Press reset button ① on the instrument cluster. The standard display appears in the multifunction display.

### Maintenance service term exceeded

If you have exceeded the suggested maintenance service term, you will see the following message in the multifunction display:

Service A Exceeded By XXXXX Miles (Km)



In addition, a signal sounds when the message appears.

Any authorized Mercedes-Benz Center will reset the maintenance service indicator following a completed maintenance service.





### Calling up the maintenance service indicator display

- ① The menu overview can be found on (▷ page 99).

You can call up the maintenance service indicator display at any time to check when the next maintenance service is due.

- ▶ Switch on the ignition.
- ▶ Press button  or  on the multifunction steering wheel repeatedly

until the standard display (▷ page 99) appears in the multifunction display.

- ▶ Press button  or  on the multifunction steering wheel until the maintenance service indicator display with the service symbol  or  and the maintenance service deadline appears in the multifunction display.

- i** If the battery is disconnected, the days of disconnection will not be included in the count shown by the maintenance service indicator. To arrive at the true maintenance service deadline, you will need to subtract these days from the days shown in the maintenance service indicator message or maintenance service indicator display. Do not confuse the maintenance service indicator with the engine oil level indicator .

### Resetting the maintenance service indicator

In the event that the maintenance service on your vehicle is not carried out at an authorized Mercedes-Benz Center, you can have the maintenance service indicator reset.

The automotive maintenance facility carrying out the maintenance service will find the information for resetting the maintenance service indicator in the maintenance-relevant literature for your vehicle.

Such literature is available from any authorized Mercedes-Benz Center or directly from Mercedes-Benz.

- !** If the maintenance service indicator was inadvertently reset, have an authorized Mercedes-Benz Center correct it. Only reset if the proper maintenance service has been performed. Resetting the system without performing the proper maintenance service as called for by the maintenance service indicator will result in engine damage and/or other vehicle

damage not covered by the Mercedes-Benz Limited Warranty.

## Vehicle care

### Cleaning and care of the vehicle

#### Notes

Regular and proper care will help to maintain the value of your vehicle.

#### Warning!

Many cleaning products can be hazardous. Some are poisonous, others are flammable. Always follow the instructions on the particular container. Always open your vehicle's doors or windows when cleaning the inside.

Never use fluids or solvents that are not designed for cleaning your vehicle.

Always lock away cleaning products and keep them out of reach of children.

- !** When cleaning the vehicle, do not use scouring agents. Never apply strong force and only use a soft, wet cloth or sponge. Otherwise you may scratch or damage the surface to be cleaned.

While in operation, even while parked, your vehicle is subjected to varying external influences which, if gone unchecked, can attack the paintwork as well as the vehicle underbody and cause lasting damage.

Such damage is caused not only by extreme and varying climatic conditions, but also by:

- Air pollution
- Road salt
- Tar
- Gravel and stone chipping

To avoid paint damage, you should immediately remove:

- Grease and oil
- Fuel

- Coolant
- Brake fluid
- Bird droppings
- Insects
- Tree resins etc.

Frequent washing reduces and/or eliminates the aggressiveness and potency of the above adverse influences.

More frequent washings are necessary to deal with unfavorable conditions:

- near the ocean
- in industrial areas (smoke, exhaust emissions)
- during winter operation

You should check your vehicle from time to time for stone chipping or other damage. Any damage should be repaired as soon as possible to prevent corrosion.

In doing so, do not neglect the underbody of the vehicle. A prerequisite for a thorough check is a washing of the underbody followed by a thorough inspection. Damaged areas need to be re-undercoated.

Your vehicle has been treated at the factory with a wax-base rustproofing in the body cavities which will last for the lifetime of the vehicle. Post-production treatment is neither necessary nor recommended by Mercedes-Benz because of the possibility of incompatibility between materials used in the production process and others applied later.

We have selected vehicle-care products and compiled recommendations which are specially matched to our vehicles and which always reflect the latest technology. You can obtain Mercedes-Benz approved vehicle-care products at an authorized Mercedes-Benz Center.

Scratches, corrosive deposits, corrosion or damage due to negligent or incorrect care cannot always be removed or repaired with the vehicle-care products recommended

here. In such cases it is best to seek aid at an authorized Mercedes-Benz Center.

The following topics deal with the cleaning and care of your vehicle and give important "how-to" information as well as references to Mercedes-Benz approved vehicle-care products.

### Power washer

---

**!** Follow the instructions provided by the power washer manufacturer on maintaining a distance between the vehicle and the nozzle of the power washer.

Never use a round nozzle to power-wash tires. The intense jet of water can result in damage to the tire.

Always replace a damaged tire.

Always keep the jet of water moving across the surface. Do not aim directly at electrical parts, electrical connectors, seals, or other rubber parts.

### Tar stains

---

Quickly remove tar stains before they dry and become more difficult to remove. A tar remover is recommended.

### Paintwork, painted body components

---

**!** Affixing stickers, magnets, adhesive tape or similar materials to painted body components may damage the paintwork.

Mercedes-Benz approved Paint Care should be applied when water drops on the paint surface do not "bead up". This should normally be done every 3 to 5 months, depending on the climate and washing detergent used.

Mercedes-Benz approved Paint Cleaner should be applied if the paint surface shows signs of embedded dirt (i.e. loss of gloss).

Do not apply any of these products or wax if your vehicle is parked in the sun or if the hood is still hot.

- ▶ Use the appropriate MB-Touch-Up Stick for quick and provisional repairs of minor paint damage (i.e. chips from stones, vehicle doors, etc.).

### Engine cleaning

Prior to cleaning the engine compartment, make sure to protect electrical components and connectors from contact with water and cleaning agents.

Corrosion protection, such as MB Anticorrosion Wax should be applied to the engine compartment after every engine cleaning. Before applying, all control linkage bushings and joints should be lubricated. The poly-V-belt and all pulleys should be protected from any wax.

### Vehicle washing

In the winter, thoroughly remove all traces of road salt as soon as possible.

When washing the vehicle underbody, do not forget to clean the inner sides of the wheels.

### Hand-wash

- ▶ Do not use hot water or wash your vehicle in direct sunlight.
- ▶ Only use a soft, wet cloth or sponge to clean the vehicle.
- ▶ Only use a mild vehicle wash detergent, such as Mercedes-Benz approved Car Shampoo.
- ▶ Thoroughly spray the vehicle with a diffused jet of water.
- ▶ Do not spray directly towards the ventilation intake.
- ▶ Use plenty of water and rinse the sponge and chamois frequently.
- ▶ Rinse with clean water and thoroughly dry with a chamois.  
Do not allow cleaning agents to dry on the finish.

### Automatic car wash

You can have your vehicle washed in an automatic car wash from the start. Brushless car washes are preferable.

- ▶ To protect the filter system, activate the air recirculation mode using button  on the climate control panel.

**!** Do not clean your vehicle in an automatic touchless car wash which uses caustic spray. Caustic spray will damage the paint or ornamental moldings.

If the vehicle is very dirty, prewash it before running it through the automatic car wash.

**!** Make sure the combination switch is set to wiper setting **0**. Otherwise, the rain sensor could activate and cause the wipers to move unintentionally. This may lead to vehicle damage.

Due to the width of the vehicle, fold in exterior rear view mirrors prior to running the vehicle through an automatic car wash to prevent damage to the mirrors.

When leaving the automatic car wash, make sure the mirrors are folded out.

After running the vehicle through an automatic car wash, wipe any wax off of the windshield and the wiper blade inserts. This will prevent smears and reduce wiping noise which can be caused by residual wax on the windshield.

### Ornamental moldings

- ▶ For regular cleaning and care of ornamental moldings, use a damp cloth.

**!** Do not use chrome cleaner on ornamental moldings. Although ornamental moldings may have chrome appearance, they could be made of anodized aluminum that will be damaged when cleaned with chrome cleaner. Instead, use a damp cloth to clean those ornamental moldings.

For very dirty ornamental moldings of which you are sure are chrome-plated, use

a chrome cleaner. If in doubt whether an ornamental molding is chrome-plated, contact an authorized Mercedes-Benz Center.

### Headlamps, brake lamps, tail lamps, side markers, turn signal lenses

- ▶ Use a mild vehicle wash detergent, such as Mercedes-Benz approved Car Shampoo, with plenty of water.

❗ Only use window cleaning solutions that are suitable for plastic lamp lenses. Window cleaning solutions which are not suitable may damage the plastic lamp lenses of the headlamps. Therefore, do not use abrasives, solvents or cleaners that contain solvents.

### Cleaning the Rear Parking Assist system sensors

Rear Parking Assist system sensors are located in the rear bumper.



- ▶ Only clean Rear Parking Assist system sensors ① by hand.
  - ▶ Use a mild vehicle wash detergent, such as Mercedes-Benz approved Car Shampoo, with plenty of water and a soft, non-scratching cloth to clean Rear Parking Assist system sensors ① on the bumper.
- ❗ Applying strong pressure may damage the sensor covers.

### Cleaning the rear view camera lens



- ▶ Only use clean water and a soft, non-scratching cloth to clean rear view camera lens ①.

Be careful not to apply wax to rear view camera lens ① when waxing the vehicle. If necessary, remove the wax using the Mercedes-Benz approved Car Shampoo with plenty of water.

❗ Do not clean the camera and the area around the camera

- with a high-pressure cleaner
- with a dry cloth and strong pressure
- with aggressive cleaning agents

You could otherwise damage the camera.

### Cleaning the windows and the wiper blades

#### ⚠ Warning!

For safety reasons, switch off wipers and remove SmartKey from starter switch before cleaning the windshield and/or the wiper blades. Otherwise, the wiper motor could suddenly turn on and cause injury.

❗ Do not pull on the wiper blade inserts. They could tear.



- ▶ Fold the wiper arms forward until they snap into place.
- ▶ Clean the windshield and the wiper blade inserts with a clean cloth and mild detergent solution.
- ▶ Use a soft, clean cloth and a mild window cleaning solution on all outside and inside glass surfaces.

An automotive glass cleaner is recommended.

- ❗ Fold the windshield wiper arms back onto the windshield before turning the SmartKey in the starter switch.

Hold on to the wiper when folding the wiper arm back. If released, the force of the impact from the tensioning spring could crack the windshield.

- ❗ To clean the window interior, do not use a dry cloth, abrasives, solvents or cleaners containing solvents. Do not touch the inside of the front, rear or side windows with hard objects such as an ice scraper or ring. Doing so may damage the windows.

### Light alloy wheels

If possible, clean wheels once a week.

- ▶ Use Mercedes-Benz approved Wheel Care, a soft bristle brush and a strong spray of water for cleaning the light alloy wheels.

- ❗ Only use acid-free cleaning materials. Acid may cause corrosion or damage the clear coat.

- ❗ The vehicle should not be parked for an extended period of time immediately after it has been cleaned. This applies especially after the wheel rims have been cleaned with wheel rim cleaner. Wheel rim cleaners can lead to increased corrosion of the brake disks and brake pads. Non-approved wheel cleaners may also damage the wheel paint if the vehicle is not driven after cleaning.

Therefore, the vehicle's brake system should always be warmed-up before it is parked after cleaning. Drive your vehicle for several minutes to allow the brakes to dry. When applying Mercedes-Benz approved Tire Care and Mercedes-Benz approved Wheel Care products, take care not to spray them on the brake disks.

### Plastic and rubber parts

- ▶ Use a gentle dishwashing detergent or mild detergent for delicate fabrics as a washing solution.
- ▶ Wipe with a cloth moistened in a lukewarm solution. The surface may temporarily change color. If this is the case, wait for it to dry.

#### Warning!

Do not use cleaners or cockpit care sprays containing solvents to clean the cockpit or the steering wheel. Cleaners containing solvents will make the surface porous and vehicle occupants could suffer serious injuries from plastic parts coming loose in the event of air bag deployment.

- ❗ Do not use oil, wax or scouring agents. Otherwise you may scratch or damage the surface.

### Hard plastic trim items

- ▶ Use Mercedes-Benz approved Interior Care on a soft, lint-free cloth and apply with light pressure.

### COMAND display

- ❗ You must switch off the COMAND display and allow it to cool prior to cleaning.
- ❗ Do not use any liquids or cleaning agents. These can damage or even destroy the audio display screen.

- ▶ Use a standard microfiber cloth and apply with light pressure.

### Steering wheel and gear selector lever

- ▶ Wipe with a damp cloth and dry thoroughly or clean with Mercedes-Benz approved Leather Care.

### Carpets

- ▶ Use Mercedes-Benz approved Carpet and Fabric Care for cleaning the carpets.

### Headliner

- ▶ Use a soft bristle brush or a dry-shampoo cleaner in case of excessive dirt.

### Seat belts

- ▶ Only use clear, lukewarm water and soap.

**!** The seat belts must not be treated with chemical cleaning agents. Do not dry the seat belts at temperatures above 176°F (80°C) or in direct sunlight.

#### **⚠ Warning!**

Do not bleach or dye seat belts as this may severely weaken them. In a crash they may not be able to provide adequate protection.

### Upholstery

Using aftermarket seat covers or wearing clothing that have the tendency to give off coloring (e.g. when wet, etc.) may cause the upholstery to become permanently discolored. By lining the seats with a proper intermediate cover, contact-discoloration will be prevented.

### Leather upholstery

Please note that leather upholstery is a natural product and is therefore subject to a natural aging process. Leather upholstery may also react to certain ambient influences such as high humidity or high temperature by showing wrinkles for example.

- ▶ Wipe leather upholstery with a damp cloth and dry thoroughly or clean with Mercedes-Benz approved Leather Care.

**!** To avoid damage to leather upholstery:

- Wipe with light pressure only.
- Do not clean with abrasive cleaning agents such as scouring milk or powder.
- Do not soak the leather upholstery.  
As leather is a natural product, it could otherwise harden or become porous.
- Exercise particular care when cleaning perforated leather as its underside should not become wet.

### Wood trims

- ▶ Only use water and a damp cloth to clean wood trims in your vehicle.

**!** Do not use solvents like tar remover or wheel cleaner nor polishes or waxes as these may be abrasive.

### Chrome-plated exhaust tip

Regular cleaning and care of chrome-plated exhaust tips will help to maintain their shine and the classy appearance.

- ▶ Use Mercedes-Benz approved Chrome Polishing Paste each time the vehicle has been washed, especially during the winter.

**!** Do not use alkaline cleaners such as wheel cleaners as they could cause corrosion.

<b>Vehicle equipment</b> .....	194
<b>Where will I find ...?</b> .....	194
<b>Vehicle status messages in the multifunction display</b> .....	196
<b>What to do if ...</b> .....	213
<b>Unlocking/locking manually</b> .....	221
<b>Opening/closing manually</b> .....	223
<b>Brush guard</b> .....	224
<b>Replacing SmartKey batteries</b> .....	225
<b>Replacing bulbs</b> .....	226
<b>Replacing wiper blades</b> .....	231
<b>Flat tire</b> .....	232
<b>Battery</b> .....	236
<b>Jump starting</b> .....	237
<b>Towing the vehicle</b> .....	239
<b>Fuses</b> .....	242



### Vehicle equipment

**i** This Operator's Manual describes all features, standard or optional, potentially available for your vehicle at the time of purchase. Please be aware that your vehicle might not be equipped with all features described in this manual.

### Where will I find ...?

#### First aid kit

**i** Check expiration dates and contents for completeness at least once a year and replace missing/expired items.

The first aid kit is stored in the storage pocket in the front passenger door.

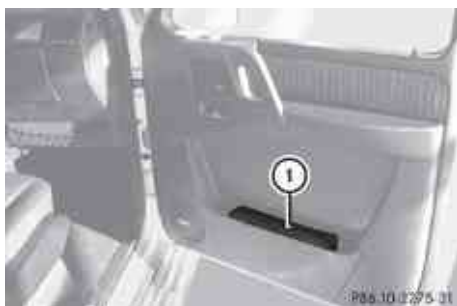

① First aid kit

#### Vehicle tool kit

The vehicle tool kit includes:

- Tool bag with
  - Fuse extractor
  - Socket wrench for opening/closing the power tilt/sliding sunroof in an emergency
  - Pump handle for jack
  - Screwdriver
  - Wheel wrench
- Jack

The tool bag is located in a storage compartment in the rear footwell.

The jack is located in a storage compartment under the rear seat bench on the passenger side.

► **Removing tool bag:** Open the rear door on the driver's side.

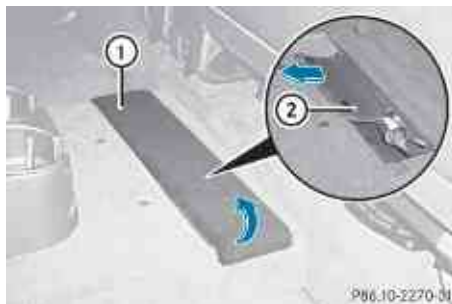

Tool bag

- Fold cover ① to the side.
- Remove the tool bag from the storage compartment using tab ②.

► **Removing jack:** Open the rear door on the passenger side.

► Fold the rear seat bench forward (▷ page 128).



Jack

- Open cover ③.
- Open tab ④.
- Remove the jack from the storage compartment.

## Jack

### **Warning!**

Only use the jack supplied with your vehicle to lift the vehicle briefly for wheel changes. If you use the jack for any other purpose, you or others could be injured, as the jack is designed only for the purpose of changing a wheel.

When using the jack, observe the safety notes in the "Mounting the spare wheel" section and the notes on the jack.

- ▶ Take the pump handle (three pieces) and jack from the vehicle tool kit (▷ page 194).

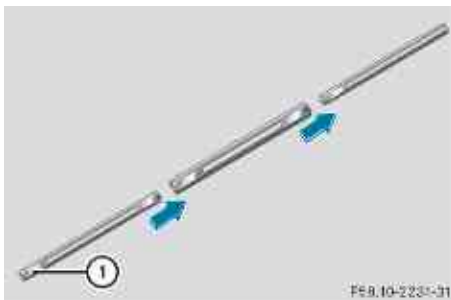

Pump handle

- ▶ Assemble the pump handle.

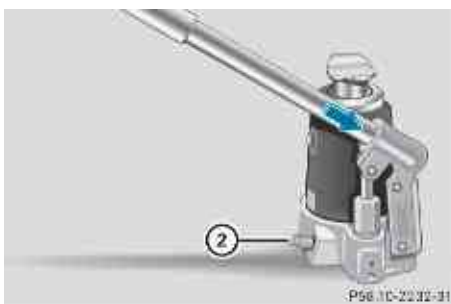

Jack

- ▶ Set indent ① of the pump handle onto release bolt ② of the jack.
- ▶ Using the pump handle, turn release bolt ② clockwise until its stop. Release bolt ② is closed.
- ▶ Remove the pump handle from release bolt ②.
- ▶ Set the pump handle into the pump lever as indicated by the arrow.

Before placing the pump handle and the jack back into the vehicle tool kit:

- ▶ Press the jack piston in again and close the release bolt by using the pump handle.
- ▶ Disassemble the pump handle.

## Spare wheel

### **Observe Safety notes, see page 232.**

The spare wheel is located under a cover on the outside of the vehicle's tailgate.

- ▶ **Removing:** Take the screwdriver from the vehicle tool kit (▷ page 194).



- ▶ Open lock ① using the screwdriver.
- i** You can also use a coin to open the lock.
- ▶ Fold tab ② downwards.



- ▶ Pull cover ring ③ slightly outwards in direction of arrows and remove.
- ▶ Pull cover plate ④ towards you.

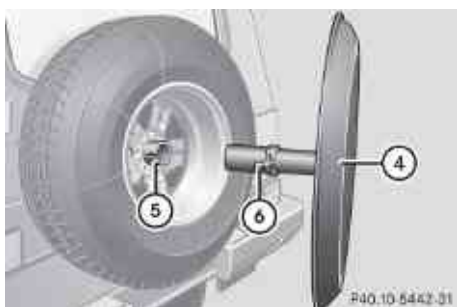

- ▶ Remove cover plate ④.



- ▶ Unscrew mounting screws ⑦.
- ▶ Remove the spare wheel.

#### **Warning!**

Make sure no one is injured when removing the spare wheel.  
Grip wheel from the sides.

Keep hands from beneath the wheel.

After mounting the spare wheel:

- ▶ Transport the damaged wheel on the spare wheel carrier, see “Storing the spare wheel after use” for instructions.
- ▶ Repair or replace the damaged tire as soon as possible and return the spare tire as original spare.

For information on mounting the spare wheel, see “Flat tire” (▷ page 232).

#### Storing the spare wheel after use

- ▶ Secure the spare wheel with mounting screws ⑦ on the spare wheel carrier (▷ page 196). Make sure the spare wheel cannot come loose.
- ▶ Make sure catch ⑥ engages in recess ⑤ when mounting cover plate ④ (▷ page 196).
- ▶ Make sure tab ② (▷ page 195) faces downwards when mounting cover ring ③ (▷ page 196).
- ▶ For safety reasons, check regularly that the spare wheel is securely fastened.

#### Vehicle status messages in the multifunction display

##### Notes





Warning and malfunction messages appear in the multifunction display located in the instrument cluster.





Certain warning and malfunction messages are accompanied by an audible signal.

Address these messages accordingly and follow the additional instructions given in this Operator’s Manual.

Selecting the **Vehicle status message memory** menu in the control system (▷ page 102) displays both cleared and uncleared messages.

High-priority messages appear in the multifunction display in red color.

Certain messages of high priority cannot be cleared from the multifunction display using the reset button (▷ page 95) or button , ,  or  on the multifunction steering wheel.

Other messages of high priority and messages of less immediate priority can be cleared from the multifunction display using the reset button or button , ,  or  on the multifunction steering wheel. They are then stored in the **Vehicle status message memory** menu (▷ page 102). Remember that clearing a message will only make the message disappear. Clearing a message will not correct the condition that caused the message to appear.

#### **Warning!**

All categories of messages contain important information which should be taken note of and, where a malfunction is indicated, addressed as soon as possible at an authorized Mercedes-Benz Center.

Failure to repair the condition noted may cause damage not covered by the Mercedes-

Benz Limited Warranty, or result in property damage or personal injury.

#### **Warning!**

No messages will be displayed if either the instrument cluster or the multifunction display is inoperative.

As a result, you will not be able to see information about your driving conditions, such as

- speed
- outside temperature
- warning/indicator lamps
- malfunction/warning messages
- failure of any systems

Driving characteristics may be impaired.

If you must continue to drive, please do so with added caution. Contact an authorized Mercedes-Benz Center as soon as possible.

On the pages that follow, you will find a compilation of the most important warning and malfunction messages that may appear in the multifunction display.

For your convenience the messages are divided into text messages (▷ page 198) and symbol messages (▷ page 202).

## Text messages

## Safety systems

Display messages		Possible causes/consequences and ► Solutions
ABS	ABS not available Differential Locked	You have engaged the differential locks. ► The ABS switches on again after the differential locks have been disengaged.
ABS	ABS, ESP Inoperative See Operator's Manual	The brake system is still functioning normally but due to a malfunction, the ABS, the BAS, the EBB, the ESP® and the 4-ETS are unavailable. ► Continue driving with added caution. Wheels may lock during hard braking, reducing steering capability. ► Have the system checked at an authorized Mercedes-Benz Center as soon as possible. Failure to follow these instructions increases the risk of an accident.
ESP	Inoperative See Operator's Manual	The brake system is still functioning normally but due to a malfunction or an interruption in the power supply the ABS, the BAS, EBB, the ESP® and the 4-ETS are unavailable. ► Continue driving with added caution. Wheels may lock during hard braking, reducing steering capability. ► Have the system checked at an authorized Mercedes-Benz Center as soon as possible. Failure to follow these instructions increases the risk of an accident.



Display messages		Possible causes/consequences and ► Solutions
SRS	Restraint System Malfunction Service Required	<p>There is a malfunction in the Supplemental Restraint Systems (SRS). The air bags or the Emergency Tensioning Devices (ETDs) could deploy unexpectedly or fail to activate in an accident.</p> <ul style="list-style-type: none"> <li>► Drive with added caution to the nearest authorized Mercedes-Benz Center and have the system checked immediately.</li> </ul>
SRS	Restraint System Service Required	<p>There is a malfunction in the Supplemental Restraint Systems (SRS). The air bags or the Emergency Tensioning Devices (ETDs) could deploy unexpectedly or fail to activate in an accident.</p> <ul style="list-style-type: none"> <li>► Drive with added caution to the nearest authorized Mercedes-Benz Center and have the system checked immediately.</li> </ul>

Practical hints

 **Warning!**

In the event a malfunction of the SRS is indicated as outlined above, the SRS may not be operational.

For your safety, we strongly recommend that you contact an authorized Mercedes-Benz Center immediately to have the system checked. Otherwise the SRS may not be activated when needed in an accident, which could result in serious or fatal injury, or it might deploy unexpectedly and unnecessarily which could also result in injury.

**Driving systems**

Display messages		Possible causes/consequences and ► Solutions
AAS	Service Required	<p>On inclines, the vehicle may start to roll down upon releasing the accelerator pedal.</p> <ul style="list-style-type: none"> <li>► Continue driving with added caution.</li> <li>► Have the system checked at an authorized Mercedes-Benz Center as soon as possible.</li> </ul> <p>Failure to follow these instructions increases the risk of an accident.</p>
Cruise Cont. And SPEEDTRONIC	Inoperative	<p>The cruise control is malfunctioning.</p> <ul style="list-style-type: none"> <li>► Have the cruise control checked at an authorized Mercedes-Benz Center.</li> </ul>

## Tires

Display messages		Possible causes/consequences and ► Solutions
Tire pressure displayed only	after driving for a few minutes.	The tire inflation pressure is being checked. ► Drive the vehicle for a few minutes.
Tire Pres. Monitor	Inoperative	The Advanced TPMS is malfunctioning. ► Have the Advanced TPMS checked at an authorized Mercedes-Benz Center.
Tire Pres. Monitor Inoperative	No Wheel Sensors	There are wheels without appropriate wheel sensors mounted (e.g. winter tires). ► Have the Advanced TPMS checked at an authorized Mercedes-Benz Center. ► Have the appropriate wheel sensors installed at an authorized Mercedes-Benz Center.
Wheel Sensor	Missing	One or more sensors are defect (e.g. battery is empty). The respective tire is indicated by - - instead of the tire inflation pressure in the multifunction display. ► Have the Advanced TPMS checked at an authorized Mercedes-Benz Center. ► Have the wheel sensors installed at an authorized Mercedes-Benz Center.
		One or more wheels without appropriate wheel sensors mounted (e.g. spare tire). The respective tire is indicated by - - instead of the tire inflation pressure in the multifunction display. ► Have the Advanced TPMS checked at an authorized Mercedes-Benz Center. ► Have the wheel sensors installed at an authorized Mercedes-Benz Center.
Tire Pres. Monitor	Currently Unavailable	The Advanced TPMS is unable to monitor the tire inflation pressure due to a nearby radio interference source or insufficient power supply.  As soon as the causes of the malfunction have been removed, the Advanced TPMS becomes active again automatically after a few minutes of driving.

Display messages		Possible causes/consequences and ► Solutions
Correct The Tire Pres.		<p>The tire pressure is too low in one or more tires. or The tire pressures of the individual tires differ from each other significantly. The tire pressure values are shown in the multifunction display.</p> <ul style="list-style-type: none"> <li>► Check and correct tire inflation pressure as required (► page 156).</li> </ul>
Caution Tire defect		<p>One or more tires are deflating. The respective tire is indicated in the multifunction display.</p> <ul style="list-style-type: none"> <li>► Carefully bring the vehicle to a halt, avoiding abrupt steering and braking maneuvers.</li> <li>► If necessary, change the wheel (► page 232).</li> </ul>
Check Tires		<p>The tire pressure in one or more tires is already below the minimum value. The respective tire is indicated in the multifunction display.</p> <ul style="list-style-type: none"> <li>► Carefully bring the vehicle to a halt, avoiding abrupt steering and braking maneuvers.</li> <li>► Check and adjust tire pressure as required.</li> <li>► If necessary, change the wheel (► page 232).</li> </ul>

 **Warning!**

Do not drive with a flat tire. A flat tire affects the ability to steer or brake the vehicle. You may lose control of the vehicle. Continued driving with a flat tire will cause excessive heat build-up and possibly a fire.

 **Warning!**

Follow recommended tire inflation pressures.

Do not underinflate tires. Underinflated tires wear excessively and/or unevenly, adversely affect handling and fuel economy, and are more likely to fail from being overheated.

Do not overinflate tires. Overinflated tires can adversely affect handling and ride comfort, wear unevenly, increase stopping distance, and result in sudden deflation (blowout) because they are more likely to become punctured or damaged by road debris, potholes etc.

## Symbol messages

## Brake

## Display messages

## Possible causes/consequences and ► Solutions

Brake  
Wear

The brake pads have reached their wear limit.

- Have the brake pads replaced as soon as possible.

- ! Brake pad thickness must be visually inspected by a qualified technician at the intervals specified in the Maintenance Booklet.

## Practical hints

## Display messages

## Possible causes/consequences and ► Solutions



(USA only)

(Canada  
only)Release  
Parking  
Brake

You are driving with the parking brake engaged. In addition an acoustic warning sounds.

- Release the parking brake.



(USA only)

(Canada  
only)Check  
Brake  
Fluid  
Level

There is insufficient brake fluid in the reservoir.

Risk of accident!

- Stop the vehicle in a safe location or as soon as it is safe to do so.
- Engage the parking brake
- Do **not** drive any further.
- Contact an authorized Mercedes-Benz Center or call Roadside Assistance.

Do not add brake fluid! This will not solve the problem.

**Warning!**

Driving with the message Check Brake Fluid Level displayed can result in an accident. Have your brake system checked immediately.





Do not add brake fluid before checking the brake system. Overfilling the brake fluid reservoir can result in spilling brake fluid on hot engine parts and the brake fluid catching fire. You can be seriously burned.

- ! If you find that the brake fluid in the brake fluid reservoir has fallen to the minimum mark or below, have the brake system checked for brake pad thickness and leaks.

## Safety systems

Display messages	Possible causes/consequences and ► Solutions
 SOS Tele Aid Inoperative	One or more main functions of the Tele Aid system are malfunctioning. ► Have the Tele Aid system checked at an authorized Mercedes-Benz Center.

## Driving systems

Display messages	Possible causes/consequences and ► Solutions
 Transfer Case Service Required	The transfer case is malfunctioning. ► Do not switch the transfer case on. ► Contact an authorized Mercedes-Benz Center as soon as possible.
 TC Shift Procedure Canceled	The shift process in the transfer case was canceled because of a malfunction. ► Repeat the shift process (▷ page 91).
 TC Shift Conditions Not Fulfilled	You have not met the shift conditions for a selection process in the transfer case. ► Repeat the shift process (▷ page 91).
 TC In Neutral	No gear has been selected in the transfer case, it is in <b>Neutral</b> . ► Engage transfer case to gear position <b>HIGH</b> or <b>LOW</b> (▷ page 91).







Practical hints

### **Warning!**

If the transfer case is in **Neutral**, the park position **P** of the automatic transmission will



not hold the vehicle. The parking brake must be engaged to hold the vehicle in place.

## Vehicle

Display messages	Possible causes/consequences and ► Solutions
	The tailgate is open. ► Close the tailgate (▷ page 61).
	You are driving with the hood open. ► Stop the vehicle in a safe location as soon as it is safe to do so. ► Close the hood (▷ page 149). There is otherwise danger of an accident.
	You are driving with at least one door open. ► Close all doors.
 Remove Key	You have forgotten to remove the SmartKey. ► Remove the SmartKey from the starter switch.
 Get a new key.	The SmartKey is malfunctioning. ► Contact an authorized Mercedes-Benz Center.
 Bluetooth Ready	The telephone has not yet been connected to the COMAND system via Bluetooth®. ► Connect the telephone to the COMAND system via Bluetooth®.
 Top Up Washer Fluid	The fluid level has dropped to approximately $\frac{1}{3}$ of total reservoir capacity. ► Add washer fluid (▷ page 153).

## Practical hints

## Engine

Display messages	Possible causes/consequences and ► Solutions
	Certain electronic systems are unable to relay information to the control system. The coolant temperature gauge or the tachometer may have failed. ► Have the electronic systems checked at an authorized Mercedes-Benz Center.
 Top Up Coolant See Operator's Manual	The coolant level is too low. ► Add coolant (▷ page 152). ► If you have to add coolant frequently, have the cooling system checked at an authorized Mercedes-Benz Center.

 **Warning!**

Do not spill antifreeze on hot engine parts. Antifreeze contains ethylene glycol which may burn if it comes into contact with hot engine parts. You could be seriously burned.

**!** Do not ignore the low engine coolant level warning. Extended driving with the message and symbol displayed may cause serious engine damage not covered by the Mercedes-Benz Limited Warranty.

Do not drive without sufficient amount of coolant in the cooling system. The engine will overheat causing major engine damage.

Display messages	Possible causes/consequences and ► Solutions
 <p>Coolant Stop. Turn Engine Off</p>	<p>The coolant is too hot.</p> <ul style="list-style-type: none"> <li>► Stop the vehicle immediately as soon as it is safe to do so.</li> <li>► Turn off the engine immediately.</li> <li>► Engage the parking brake.</li> <li>► Only start the engine again after the message disappears. You could otherwise damage the engine.</li> <li>► Observe the coolant temperature gauge in the instrument cluster.</li> <li>► If the temperature rises again: Contact an authorized Mercedes-Benz Center immediately.</li> </ul> <p>During severe operation conditions and stop-and-go city traffic, the coolant temperature may rise close to 248°F (120°C).</p>



 **Warning!**

Driving when your engine is overheated can cause some fluids which may have leaked into the engine compartment to catch fire. You could be seriously burned.





Steam from an overheated engine can cause serious burns which can occur just by opening the engine hood. Stay away from the engine if you see or hear steam coming from it.

Stop the vehicle in a safe location away from other traffic. Turn off the engine, get out of the vehicle and do not stand near the vehicle until the engine has cooled down.

**!** The engine should not be operated with the coolant temperature above 248°F (120°C). Doing so may cause serious damage which is not covered by the Mercedes-Benz Limited Warranty.

Display messages		Possible causes/consequences and ► Solutions
	Coolant Stop, Turn Engine Off	<p>The poly-V-belt could be broken.</p> <ul style="list-style-type: none"> <li>► Stop the vehicle immediately as soon as it is safe to do so.</li> <li>► Turn off the engine immediately.</li> <li>► Check the poly-V-belt.</li> <li>► <b>If it is broken:</b> Do not continue to drive. Otherwise the engine will overheat due to an inoperative water pump which may result in damage to the engine. Contact an authorized Mercedes-Benz Center.</li> <li>► <b>If it is intact:</b> Do not continue to drive the vehicle with this message displayed. Doing so could result in serious engine damage that is not covered by the Mercedes-Benz Limited Warranty.</li> <li>► Observe the coolant temperature gauge in the instrument cluster.</li> <li>► Drive to the nearest authorized Mercedes-Benz Center immediately.</li> </ul>
		<p>The cooling fan for the coolant is malfunctioning.</p> <ul style="list-style-type: none"> <li>► Observe the coolant temperature gauge in the instrument cluster.</li> </ul> <p>If the coolant temperature is below 248°F (120°C), you may continue driving to an authorized Mercedes-Benz Center.</p> <ul style="list-style-type: none"> <li>► Avoid placing heavy loads on the engine (e.g. by driving uphill) as well as stop-and-go traffic.</li> <li>► Have the fan replaced as soon as possible.</li> </ul>
		<p>The battery is no longer charging.</p> <p>Possible causes:</p> <ul style="list-style-type: none"> <li>• alternator malfunctioning</li> <li>• broken poly-V-belt</li> </ul> <ul style="list-style-type: none"> <li>► Stop immediately in a safe location or as soon as it is safe to do so and check the poly-V-belt.</li> <li>► <b>If it is broken:</b> Do not continue to drive. Otherwise the engine will overheat due to an inoperative water pump which may result in damage to the engine. Contact an authorized Mercedes-Benz Center.</li> <li>► <b>If it is intact:</b> Drive to the nearest authorized Mercedes-Benz Center immediately. Adjust driving to be consistent with reduced braking responsiveness.</li> </ul>



Display messages		Possible causes/consequences and ► Solutions
		<p>The battery has insufficient voltage.</p> <ul style="list-style-type: none"> <li>► Turn off unnecessary electrical consumers.</li> <li>► Have the battery and the alternator checked at an authorized Mercedes-Benz Center as soon as possible.</li> </ul>
		<p>The battery was charged with a battery charger or jump started.</p> <ul style="list-style-type: none"> <li>► Have the battery and the alternator checked at an authorized Mercedes-Benz Center as soon as possible.</li> </ul>
	<p>Engine Oil Level Service Required</p>	<p>The engine oil has dropped to a critical level.</p> <ul style="list-style-type: none"> <li>► Check the engine oil level (► page 149) and add engine oil as required (► page 151).</li> <li>► If you must add engine oil frequently, have the engine checked for possible leaks.</li> </ul> <p>You have added too much engine oil. There is a risk of damaging the engine or the catalytic converter.</p> <ul style="list-style-type: none"> <li>► Have oil siphoned or drained off. Observe all legal requirements with respect to its disposal.</li> </ul> <p>It may be that there is water in the engine oil.</p> <ul style="list-style-type: none"> <li>► Have the engine oil at an authorized Mercedes-Benz Center.</li> </ul> <p>The measuring system is malfunctioning.</p> <ul style="list-style-type: none"> <li>► Have the measuring system checked at an authorized Mercedes-Benz Center.</li> </ul>
	<p>At next gas station add 1.0 qt engine oil. (USA only) At next gas station add 1.0 liter engine oil. (Canada only)</p>	<p>The engine oil level is too low.</p> <ul style="list-style-type: none"> <li>► Add engine oil (► page 151) and check the engine oil level (► page 149).</li> <li>► If you must add engine oil frequently, have the engine checked for possible leaks.</li> </ul>

If the message **At next gas station add 1 qt. (Canada: 1 liter) engine oil.** appears while the engine is running and at operating temperature, the engine oil level has dropped to approximately the minimum level.

The message will be stored in the vehicle status message memory after you have cleared it from the multifunction display.





Visually check for oil leaks. If there are no obvious oil leaks, drive to the nearest service

station to refill your engine oil to the required level.





For information on approved engine oils contact an authorized Mercedes-Benz Center or visit **www.mbusa.com** (USA only).





**!** Engine oil level warnings should not be ignored. Extended driving with the symbol displayed could result in serious engine damage that is not covered by the Mercedes-Benz Limited Warranty.

### Practical hints

Display messages	Possible causes/consequences and ► Solutions
 <p>Engine Oil Level Stop, Turn Engine Off</p>	<p>There is no oil in the engine. There is a danger of engine damage.</p> <ul style="list-style-type: none"> <li>► Stop the vehicle in a safe location or as soon as it is safe to do so.</li> <li>► Turn off the engine.</li> <li>► Engage the parking brake.</li> <li>► Add engine oil (► page 151) and check the engine oil level (► page 149).</li> </ul>
 <p>Reserve Fuel</p>	<p>The fuel level has dropped below the reserve mark.</p> <ul style="list-style-type: none"> <li>► Refuel at the next gas station.</li> </ul>
 <p>Gas cap is open.</p>	<p>A loss of pressure has been detected in the fuel system. The fuel cap may not be closed properly or the fuel system may be leaky.</p> <ul style="list-style-type: none"> <li>► Check the fuel cap (► page 147).</li> <li>► <b>If it is not closed properly:</b> Close the fuel cap.</li> <li>► <b>If it is closed properly:</b> Have the fuel system checked at an authorized Mercedes-Benz Center.</li> </ul>
 <p>Clean Fuel Filter</p>	<p>There is water in the fuel filter.</p> <ul style="list-style-type: none"> <li>► Have the water drained at an authorized Mercedes-Benz Center as soon as possible.</li> </ul>





## Lamps

Display messages	Possible causes/consequences and ► Solutions
 Reverse Lamp Right	The right backup lamp is malfunctioning. ► Replace the bulb as soon as possible (▷ page 226).
 Brake Lamp Left or Brake Lamp Right	The left or right brake lamp is malfunctioning. ► Replace the bulb as soon as possible (▷ page 226).
 3rd Brake Lamp	The high-mounted brake lamp is malfunctioning. This message will only appear if all LEDs have stopped working. ► Contact an authorized Mercedes-Benz Center as soon as possible.
 Front Foglamp Left or Front Foglamp Right	The left or right front fog lamp is malfunctioning. ► Replace the bulb as soon as possible (▷ page 226).
 Front Left Side Marker Lamp or Front Right Side Marker Lamp	The front left side or right side marker lamp is malfunctioning. ► Replace the bulb as soon as possible (▷ page 226).



Display messages		Possible causes/consequences and ► Solutions
	Parking Lamp Front Left Auxiliary Bulb On or Parking Lamp Front Right Auxiliary Bulb On	The left or right front parking lamp is malfunctioning. A substitute bulb is being used. ► Contact an authorized Mercedes-Benz Center as soon as possible.
	High Beam Left or High Beam Right	The left or right high-beam lamp is malfunctioning. ► Contact an authorized Mercedes-Benz Center as soon as possible.
	License Plate Lamp, Left or License Plate Lamp, Right	The left or right license plate lamp is malfunctioning. ► Replace the bulb as soon as possible (► page 226).
	AUTO-Light Inoperative	The light sensor is malfunctioning. The headlamps come on automatically. ► Contact an authorized Mercedes-Benz Center as soon as possible.  To switch off the headlamps (U.S. vehicles only): ► In the control system, set daytime running lamp mode to manual (► page 106). ► Switch off the headlamps using the exterior lamp switch (► page 72).
	Low Beam Left or Low Beam Right	The left or right low-beam lamp is malfunctioning. ► Contact an authorized Mercedes-Benz Center as soon as possible.

## Vehicle status messages in the multifunction display



211

Display messages	Possible causes/consequences and ► Solutions	
	Rear Foglamp Auxiliary Bulb On	<p>The rear fog lamp is malfunctioning. A substitute bulb is being used.</p> <p>► Replace the bulb as soon as possible (▷ page 226).</p>
	Switch Off Lights	<p>You have removed the SmartKey from the starter switch, opened the driver's door and left the headlamps on.</p> <p>► Turn the exterior lamp switch to <b>0</b> or <b>AUTO</b> (▷ page 72).</p>
	Turn off lights or remove key	<p>The exterior lamp switch is set to <b>AUTO</b> and you have forgotten to remove the SmartKey from the starter switch. The parking lamps remain switched on.</p> <p>► Remove the SmartKey from the starter switch. or ► Switch off the headlamps.</p>
	Tail Lamp, Left Auxiliary Bulb On or Tail Lamp, Right Auxiliary Bulb On	<p>The left or right tail lamp is malfunctioning. A substitute bulb is being used.</p> <p>► Replace the bulb as soon as possible (▷ page 226).</p>
	Turn Signal Rear Left Auxiliary Bulb On or Turn Signal Rear Right Auxiliary Bulb On	<p>The left or right rear turn signal lamp is malfunctioning. A substitute bulb is being used.</p> <p>► Replace the bulb as soon as possible (▷ page 226).</p>

Practical hints

Display messages	Possible causes/consequences and ► Solutions
 <p>Turn Signal Front Left Auxiliary Bulb On or Turn Signal Front Right Auxiliary Bulb On</p>	<p>The left or right front turn signal lamp is malfunctioning. A substitute bulb is being used.</p> <p>► Replace the bulb as soon as possible (► page 226).</p>
 <p>Turn Signal In Left Mirror or Turn Signal In Right Mirror</p>	<p>The turn signal in the left or right exterior rear view mirror is malfunctioning. This message will only appear if all LEDs have stopped working.</p> <p>► Contact an authorized Mercedes-Benz Center as soon as possible.</p>

## Tires

Display messages	Possible causes/consequences and ► Solutions
 <p>Correct The Tire Pres.</p>	<p>The tire pressure is too low in one or more tires. or The tire pressure of the individual tires differ from each other significantly.</p> <p>► Check and correct tire inflation pressure as required (► page 156).</p>
 <p>Tire Pres. Caution Tire Defect</p>	<p>One or more tires are deflating.</p> <p>► Carefully bring the vehicle to a halt, avoiding abrupt steering and braking maneuvers. ► If necessary, change the wheel (► page 232).</p>

Display messages	Possible causes/consequences and ► Solutions
 <p data-bbox="361 272 431 390">Tire Pres. Check Tires</p>	<p data-bbox="514 272 1106 327">The tire pressure in one or more tires is already below the minimum value.</p> <ul style="list-style-type: none"> <li data-bbox="514 338 1067 396">► Carefully bring the vehicle to a halt, avoiding abrupt steering and braking maneuvers.</li> <li data-bbox="514 404 979 428">► Check and adjust tire pressure as required.</li> <li data-bbox="514 437 998 464">► If necessary, change the wheel (► page 232).</li> </ul>

 **Warning!**

Do not drive with a flat tire. A flat tire affects the ability to steer or brake the vehicle. You may lose control of the vehicle. Continued driving with a flat tire will cause excessive heat build-up and possibly a fire.

 **Warning!**

Follow recommended tire inflation pressures.

Do not underinflate tires. Underinflated tires wear excessively and/or unevenly, adversely affect handling and fuel economy, and are more likely to fail from being overheated.

Do not overinflate tires. Overinflated tires can adversely affect handling and ride comfort, wear unevenly, increase stopping distance, and result in sudden deflation (blowout) because they are more likely to become punctured or damaged by road debris, potholes etc.

## What to do if ...



### Lamps in instrument cluster

#### Notes







If any of the following lamps in the instrument cluster fails to come on during the bulb self-check when switching on the ignition, have the respective bulb checked and replaced if necessary.

When you switch on the ignition, all lamps (except high-beam headlamp indicator lamp, and turn signal indicator lamps unless activated) in the instrument cluster come on. If a lamp in the instrument cluster fails to come on when the ignition is switched on, have it checked and replaced if necessary.

## Brake

Problem	Possible causes/consequences and ► Solutions
 The yellow ABS indicator lamp comes on while the engine is running.	<p>The ABS has detected a malfunction and switched off. The BAS, the EBB, the ESP<sup>®</sup> and the 4-ETS are also switched off (see messages in multifunction display).</p> <p>The brake system is still functioning normally but without the systems specified above available.</p> <p>If the ABS control unit is malfunctioning, other systems such as the navigation system or the automatic transmission may also be malfunctioning.</p> <ul style="list-style-type: none"> <li>► Continue driving with added caution. Wheels may lock during hard braking, reducing steering capability.</li> <li>► Read and observe messages that may appear in the multifunction display (▷ page 196).</li> <li>► Have the system checked at an authorized Mercedes-Benz Center as soon as possible.</li> </ul> <p>Failure to follow these instructions increases the risk of an accident.</p>
 The yellow ABS indicator lamp comes on while the engine is running.	<p>The ABS has switched off due to insufficient power supply. The battery might not be charged sufficiently.</p> <p>When the voltage is above the required value again, the ABS is operational again and the ABS indicator lamp should go out.</p> <ul style="list-style-type: none"> <li>► If the ABS indicator lamp does not go out: Have the alternator and the battery checked.</li> <li>► If necessary, have the alternator and battery checked.</li> </ul>
 The yellow ABS indicator lamp comes on while the engine is running.	<p>You have engaged the differential locks. The ABS, the BAS, the EBB, the ESP<sup>®</sup> and the 4-ETS are switched off.</p> <ul style="list-style-type: none"> <li>► The driving systems will switch on again after the differential locks have been disengaged.</li> </ul>



Problem	Possible causes/consequences and ► Solutions
 (USA only)  (Canada only)  The red brake warning lamp and the yellow ABS malfunction indicator lamp comes on while driving and an acoustic warning sounds for approximately 5 seconds.	The EBB switched off due to a malfunction. <ul style="list-style-type: none"> <li>► Continue driving with added caution.</li> <li>► Have the system checked at an authorized Mercedes-Benz Center as soon as possible.</li> </ul> Failure to follow these instructions increases the risk of an accident.
 (USA only)  The red brake warning lamp comes on while driving and an acoustic warning sounds.	You are driving with the parking brake engaged. <ul style="list-style-type: none"> <li>► Release the parking brake.</li> </ul>
 (USA only)  The red brake warning lamp comes on while the engine is running.	There is insufficient brake fluid in the reservoir. <ul style="list-style-type: none"> <li>► Risk of accident! Do not drive any further. Stop the vehicle in a safe location as soon as it is safe to do so.</li> <li>► Engage the parking brake.</li> <li>► Read and observe messages that may appear in the multifunction display (► page 196).</li> <li>► Contact an authorized Mercedes-Benz Center. Do not add brake fluid! This will not solve the problem.</li> </ul>

 **Warning!**

Driving with the brake warning lamp illuminated can result in an accident. Have your brake system checked immediately if the brake warning lamp stays on. Do not add brake fluid before checking the brake system. Overfilling the brake fluid reservoir can result in spilling brake fluid on hot engine parts and

the brake fluid catching fire. You can be seriously burned.

**!** If you find that the brake fluid in the brake fluid reservoir has fallen to the minimum mark or below, have the brake system checked for brake pad thickness and leaks.

## Safety systems

Problem	Possible causes/consequences and ► Solutions
 The red seat belt telltale comes on for a maximum of 6 seconds after starting the engine.	The seat belt telltale reminds you and your passengers to fasten your seat belts before driving off. ► Fasten your seat belts.

Problem	Possible causes/consequences and ► Solutions
 The red SRS indicator lamp comes on while driving.	There is a malfunction in the restraint systems. The air bags or Emergency Tensioning Devices (ETDs) could deploy unexpectedly or fail to activate in an accident. ► Drive with added caution to the nearest authorized Mercedes-Benz Center.



### Practical hints

#### **Warning!**

In the event a malfunction of the SRS is indicated as outlined above, the SRS may not be operational.

For your safety, we strongly recommend that you contact an authorized Mercedes-Benz





Center immediately to have the system checked. Otherwise the SRS may not be activated when needed in an accident, which could result in serious or fatal injury, or it might deploy unexpectedly and unnecessarily which could also result in injury.

Problem	Possible causes/consequences and ► Solutions
 The yellow ESP® warning lamp comes on while the engine is running.	<p>The ESP® has been switched off. Risk of accident!</p> <p>When the ESP® is switched off it will not stabilize the vehicle if the system recognizes that the vehicle starts to skid or that a wheel is spinning. The cruise control is deactivated and cannot be switched on.</p> <ul style="list-style-type: none"><li>► Switch the ESP® back on. Exceptions: (▷ page 53).</li><li>► If leaving the ESP® switched off, adapt your speed and driving to the prevailing road and weather conditions.</li><li>► If the ESP® cannot be switched back on: Have the system checked at an authorized Mercedes-Benz Center as soon as possible.</li></ul> <p>You have engaged the differential locks. The ABS, BAS, EBB, ESP® and 4-ETS are switched off.</p> <ul style="list-style-type: none"><li>► The driving systems will switch on again after the differential locks have been disengaged.</li></ul>
 The yellow ESP® warning lamp flashes while driving.	<p>The ESP® or the 4-ETS has come into operation because of detected traction loss in at least one tire. The cruise control is deactivated.</p> <ul style="list-style-type: none"><li>► When driving off, apply as little throttle as possible.</li><li>► While driving, ease up on the accelerator pedal.</li><li>► Adapt your speed and driving to the prevailing road and weather conditions.</li><li>► Do not deactivate the ESP®. Exceptions: (▷ page 53).</li></ul> <p>Failure to follow these instructions increases the risk of an accident.</p>



**Vehicle**

Problem	Possible causes/consequences and ► Solutions
The yellow fuel tank reserve warning lamp in the fuel gauge comes on while driving.	The fuel level has gone below the reserve mark. ► Refuel at the next gas station.
The yellow fuel tank reserve warning lamp in the fuel gauge comes on when the engine is running.	The fuel cap is not closed properly. ► Close the fuel cap.

**Practical hints****Engine**

Problem	Possible causes/consequences and ► Solutions
 (USA only)  (Canada only) The yellow engine malfunction indicator lamp comes on when the engine is running.	There may be a malfunction in: <ul style="list-style-type: none"> <li>• The fuel management system</li> <li>• The ignition system</li> <li>• The emission control system</li> <li>• Systems which affect emissions</li> </ul> Such malfunctions may result in excessive emissions values and may switch the engine to limp-home (emergency operation) mode. ► Have the vehicle checked as soon as possible at an authorized Mercedes-Benz Center.
 (USA only)  (Canada only) The yellow engine malfunction indicator lamp comes on when the engine is running.	A loss of pressure has been detected in the fuel system. The fuel cap may not be closed properly or the fuel system may be leaky. ► Check the fuel cap (▷ page 146). ► <b>If it is not closed properly:</b> Close the fuel cap. ► <b>If it is closed properly:</b> Have the fuel system checked by an authorized Mercedes-Benz Center.

## Tires

Problem	Possible causes/consequences and ► Solutions
 USA only: Combination low tire pressure telltale/TPMS malfunction telltale for the Advanced TPMS illuminates continuously. Canada only: Low tire pressure telltale for the Advanced TPMS illuminates continuously.	<p>The Advanced TPMS detects a loss of pressure in at least one tire.</p> <ul style="list-style-type: none"> <li>► Carefully bring the vehicle to a halt, avoiding abrupt steering and braking maneuvers. Observe the traffic situation around you.</li> <li>► Read and observe messages in the multifunction display (► page 196).</li> </ul> <p>If the tire inflation pressure in the respective tire(s) has (have) been corrected, the combination low tire pressure/TPMS malfunction telltale goes out after a few minutes of driving.</p>
 USA only: Combination low tire pressure telltale/TPMS malfunction telltale for the Advanced TPMS flashes 60 seconds and then stays illuminated.	<p>There is a malfunction in the Advanced TPMS.</p> <ul style="list-style-type: none"> <li>► Read and observe messages in the multifunction display (► page 196).</li> <li>► Have the Advanced TPMS checked by an authorized Mercedes-Benz Center.</li> </ul> <p>After the malfunction has been remedied, the combination low tire pressure/TPMS malfunction telltale goes out after a few minutes of driving.</p>

 **Warning!**

Each tire, including the spare (if provided), should be checked every other week when cold and inflated to the inflation pressure recommended by the vehicle manufacturer on the Tire and Loading Information placard on the driver's door B-pillar or, if available, the tire inflation pressure label on the inside of the fuel filler flap. If your vehicle has tires of a different size than the size indicated on the vehicle placard or the tire inflation pressure label, you should determine the proper tire inflation pressure for those tires.

As an added safety feature, your vehicle has been equipped with a tire pressure monitoring system (TPMS) that illuminates a low tire pressure telltale when one or more of your tires are significantly underinflated. Accordingly, when the low tire pressure telltale illuminates, you should stop and check your tires as soon as possible, and inflate them to the proper pressure. Driving on a significantly underinflated tire causes the tire to overheat and can lead to tire failure. Underinflation also reduces fuel efficiency and tire tread life, and may affect the vehicle's

handling and stopping ability. Please note that the TPMS is not a substitute for proper tire maintenance, and it is the driver's responsibility to maintain correct tire pressure, even if underinflation has not reached the level to trigger illumination of the TPMS low tire pressure telltale.

USA only:

Your vehicle has also been equipped with a TPMS malfunction indicator to indicate when the system is not operating properly. The TPMS malfunction indicator is combined with the low tire pressure telltale. When the system detects a malfunction, the telltale will flash for approximately 1 minute and then remain continuously illuminated. This

sequence will continue upon subsequent vehicle start-ups as long as the malfunction exists. When the malfunction indicator is illuminated, the system may not be able to detect or signal low tire pressure as intended. TPMS malfunctions may occur for a variety of reasons, including the installation of replacement or alternate tires or wheels on the vehicle that prevent the TPMS from functioning properly. Always check the TPMS malfunction telltale after replacing one or more tires or wheels on your vehicle to ensure that the replacement or alternate tires and wheels allow the TPMS to continue to function properly.

### Lamp in center console

#### Problem

#### Possible causes/consequences and ► Solutions



The front passenger front air bag off indicator lamp illuminates and remains illuminated (▷ page 38).

A BabySmart™ child seat is installed on the passenger seat. Therefore the front passenger front air bag is switched off.

The system is malfunctioning when there is no BabySmart™ child seat installed on the passenger seat.

► Have the system checked as soon as possible at an authorized Mercedes-Benz Center.



The front passenger front air bag off indicator lamp does not illuminate or does not remain illuminated with a BabySmart™ child seat properly installed on the passenger seat.

The system is malfunctioning.

► Make sure there is nothing between seat cushion and child seat.

► Check installation of the child seat (▷ page 47).

If the front passenger front air bag off indicator lamp remains out:

► Have the system checked as soon as possible at an authorized Mercedes-Benz Center.

Do not use the BabySmart™ restraint to transport children on the front passenger seat until the system has been repaired.

## Unlocking/locking manually

### Unlocking the vehicle

If you cannot unlock the vehicle with the SmartKey, unlock the driver's door and the tailgate using the mechanical key.

- i** Unlocking and opening the driver's door or the tailgate with the mechanical key will trigger the anti-theft alarm system.

To cancel the alarm, insert the SmartKey in the starter switch.

### Removing the mechanical key



- ▶ Move locking tab ① in direction of arrow.
- ▶ Slide mechanical key ② out of the housing.

### Unlocking the driver's door



- ▶ Insert mechanical key ② into the lock cylinder.
- ▶ Turn mechanical key ② counterclockwise to position 1 until the locking knob moves up. The driver's door is unlocked.
- ▶ Remove mechanical key ②.
- ▶ Press lock cylinder and pull on door handle to open the driver's door.

### Unlocking the tailgate

#### **Warning!**

The tailgate swings open to one side. Always make sure there is sufficient clearance for the tailgate.

Make sure the tailgate is closed when the engine is running and while driving. Among other dangers, deadly carbon monoxide (CO) gases may enter vehicle interior resulting in unconsciousness and death.

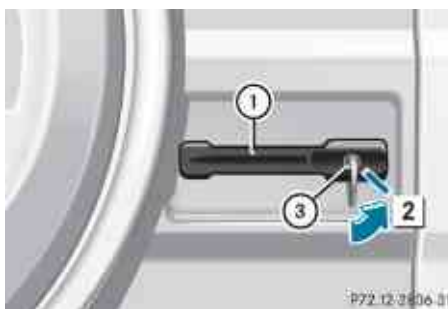

- ▶ Insert mechanical key ③ into the lock cylinder.
- ▶ Turn mechanical key ③ counterclockwise to position 2.
- ▶ Remove mechanical key ③.
- ▶ Press lock cylinder and pull on door handle ① to open the tailgate.

## 222 Unlocking/locking manually

**Locking the vehicle**

If you cannot lock the vehicle with the SmartKey, lock it as follows:

- ▶ Close the front passenger door, the rear doors, and the tailgate.
- ▶ Open the driver's door.
- ▶ Press the central locking switch (▷ page 60).  
The locking knobs of the front passenger door, the rear doors, and the tailgate move down.

- ▶ **If the vehicle battery is disconnected or drained:** Press down the locking knobs on the front passenger door, the rear doors, and the tailgate.
- ▶ Exit the vehicle.
- ▶ Close the driver's door.



- ▶ Remove mechanical key ② from the SmartKey (▷ page 221).
- ▶ Insert mechanical key ② into the lock cylinder.
- ▶ Turn mechanical key ② clockwise to position ①.  
The vehicle is locked.
- ▶ Turn mechanical key ② back and remove it from the lock cylinder.
- ▶ Check if the tailgate is locked.
- ▶ If necessary, lock the tailgate with the mechanical key (▷ page 61).

- ① This procedure does not arm the anti-theft alarm system, nor does it lock the fuel filler flap.

**Manually unlocking the gear selector lever**

If the vehicle's electrical system is malfunctioning, the gear selector lever could remain locked in park position **P**. In this case the gear selector lever can be unlocked manually, e.g. to tow the vehicle.

- ▶ Engage the parking brake.



- ▶ Insert suitable tool ① (e.g. a ball point pen) into the covered opening.
- ▶ Simultaneously push tool ① downward and move the gear selector lever out of park position **P**.
- ▶ Remove tool ①.  
The gear selector lever is unlocked.

The cover returns to its closed position after moving the gear selector lever to the positions **D+** and **D-**.

- ① The gear selector lever is locked again as soon as you move it back to park position **P**.



### Fuel filler flap

#### **Warning!**

Avoid contact with the vehicle walls as they may contain sharp edges. Otherwise, you could injure yourself while releasing the fuel filler flap.

In case the central locking system does not release the fuel filler flap, you can open it manually.

The fuel filler flap release is located on the passenger side in the cargo compartment behind the side trim panel.

- ▶ Open the tailgate (▷ page 61).



- ▶ Remove edge protection ① in direction of arrow ②.
- i** Before removing side trim panel ③ completely, the electrical connectors must be disconnected.
- ▶ Pull off side trim panel ③ in direction of arrow ④ so the electrical connectors are accessible.
- ▶ Disconnect the electrical connectors.
- ▶ Remove side trim panel ③ completely.



- ▶ Pull fuel filler flap release ⑤ upwards in direction of arrow.
- ▶ Open the fuel filler flap (▷ page 146).
- ▶ Connect the electrical connectors.
- ▶ Reinstall side trim panel ③ (▷ page 224).
- ▶ Reinstall edge protection ①.
- ▶ Close the tailgate.

### Opening/closing manually

#### Power tilt/sliding sunroof

You can open or close the power tilt/sliding sunroof manually should an electrical malfunction occur.

The power tilt/sliding sunroof drive is located on the driver's side in the cargo compartment behind the side trim panel.

- ▶ Open the tailgate (▷ page 61).



## 224 Brush guard

- ▶ Remove edge protection ① in direction of arrow ②.
- ▶ **i** Before removing side trim panel ③ completely, the electrical connectors must be disconnected.
- ▶ Pull off side trim panel ③ in direction of arrow ④ so the electrical connectors are accessible.
- ▶ Disconnect electrical connectors.
- ▶ Remove side trim panel ③ completely.
- ▶ Connect electrical connectors.
- ▶ Reinstall side trim panel ③. Shackles ⑥ in side trim panel ③ must be hooked in side wall ⑦.
- ▶ Reinstall edge protection ①.
- ▶ Close the tailgate.
- ▶ Store the tool bag with the vehicle tools in the designated storage compartment.

## Practical hints

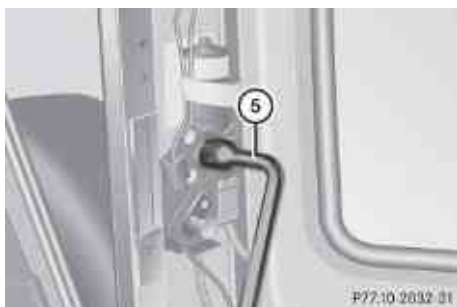

⑤ Socket wrench

- ▶ Take the tool bag out of its storage compartment (▷ page 194).
- ▶ Take socket wrench ⑤ out of the tool bag.
- ▶ **Closing/raising:** Turn socket wrench ⑤ clockwise.
- ▶ **Opening/lowering:** Turn socket wrench ⑤ counterclockwise.



## Brush guard



## ⚠ Warning!

The brush guard is designed solely to enhance the appearance of the vehicle and help protect grille and headlights from minor mishaps, either on- or off road.

Since the safety characteristics are limited in the event of an accident, brush guard are not intended to prevent injury or damage in the event of an accident. Also check state and local regulations on installation and use.

Raise and lower brush guard in an open space with plenty of room.

- ▶ **i** Only lower brush guard to clean headlamps.

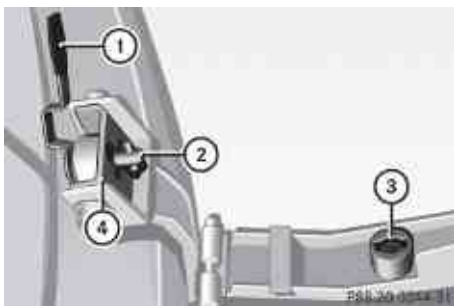

- ▶ **Lowering:** While holding brush guard firmly, open quick lock ② using locking and unlocking handle ①.
- ▶ Gently lower brush guard until it reaches its fully lowered position.
- ▶ **Raising and securing:** Flip up brush guard until it contacts end stop joint ④. Quick lock stop pin must engage the cross slot recess in lock ③.
- ▶ Now turn quick lock ② so that quick lock ② makes contact with end stop joint ④.
- ▶ Lock quick lock ② on both sides of brush guard using locking and unlocking handle ①.

⚠ Make sure both quick stop pins are seated fully in lock.

### Replacing SmartKey batteries

If the batteries in the SmartKey are discharged, the vehicle can no longer be locked or unlocked. It is recommended to have the batteries replaced at an authorized Mercedes-Benz Center.

#### ⚠ Warning!

Batteries contain poisonous and corrosive substances. Therefore, keep the batteries out of reach of children.

If a battery is swallowed, seek medical help immediately.

#### ⚠ Warning!

SmartKey batteries contain perchlorate material, which may require special handling and regard for the environment. Check with your local government's disposal guidelines. California residents, see [www.dtsc.ca.gov/HazardousWaste/Perchlorate/index.cfm](http://www.dtsc.ca.gov/HazardousWaste/Perchlorate/index.cfm).

Batteries contain materials that can harm the environment if disposed of improperly. Recycling of batteries is the preferred method of disposal. Many states/provinces require sellers of batteries to accept old batteries for recycling.

When inserting the batteries, make sure they are clean and free of lint.

When replacing batteries, always replace both batteries.

- ⓘ The required replacement batteries are available at any authorized Mercedes-Benz Center.

Replacement batteries: Lithium, type CR 2025 or equivalent.

- ▶ Remove the mechanical key from the SmartKey (▶ page 221).



- ▶ Insert mechanical key ① in direction of arrow in side opening.
- ▶ Using mechanical key ①, push slide ② to unlatch battery compartment ③.
- ▶ Pull battery compartment ③ out of the SmartKey housing in direction of arrow.

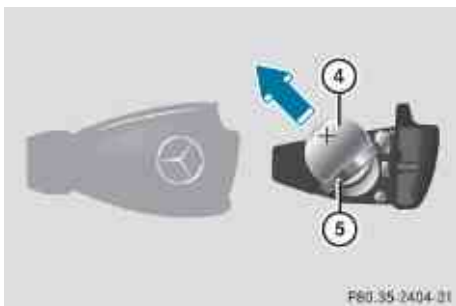

## Practical hints

- ▶ Pull out batteries (4) in direction of arrow.
- ▶ Insert new batteries (4) under contact spring (5) with the positive terminal (+) side facing up.
- ▶ Return battery compartment (3) into SmartKey housing until it locks into place.
- ▶ Slide mechanical key (1) back into the SmartKey.
- ▶ Check the operation of the SmartKey.

## Replacing bulbs

## Safety notes

Safe vehicle operation depends to a large degree on proper exterior lighting and signaling.

Correct headlamp adjustment is extremely important. Have headlamps checked and readjusted at regular intervals and when a bulb has been replaced. Contact an authorized Mercedes-Benz Center for headlamp adjustment.

**⚠ Warning!**

Bulbs and bulb sockets can be very hot. Allow the lamp to cool down before changing a bulb.

Keep bulbs out of reach of children.

Halogen lamps contain pressurized gas. A bulb can explode if you:

- touch or move it when hot
- drop the bulb
- scratch the bulb

Wear eye and hand protection.

Because of high voltage in Xenon lamps, it is dangerous to replace the bulb or repair the lamp and its components. We recommend that you have such work done by a qualified technician.

- ❗ Since replacing bulbs is a technically highly demanding process, we recommend to have them replaced at an authorized Mercedes-Benz Center.
- ❗ If the headlamps or front fog lamps are fogged up on the inside as a result of high humidity, driving the vehicle a distance with the lights on should clear up the fogging.

## Bulbs



P54.00-5739-01

## Front lamps

Lamp	Type
① Additional turn signal lamp	LED
② Locator lighting lamp	W 6 W
③ Turn signal lamp	1 156 NA
④ Side marker lamp	T 4 W
⑤ Bi-Xenon headlamp: Low and high beam <sup>10</sup>	D 1S-35 W
Parking and standing lamp	W 5 W Blue Vision
⑥ Front fog lamp	H 11 (55 W)

## Rear lamps

Lamp	Type
⑦ High-mounted brake lamp	LED
⑧ Turn signal lamp	PY 21 W
Brake and tail lamp	P 21/5 W
Tail, parking and standing lamp	W 5 W
⑨ Backup lamp	P 21 W
⑩ License plate lamps	C 5 W
⑪ Rear fog lamp	P 21 W
⑫ Side marker lamp	T 4 W

## Notes on bulb replacement

- Only use 12-volt bulbs of the same type and with the specified watt rating.
- Switch the lights off before changing a bulb to prevent short circuits.

- Always use a clean lint-free cloth when handling bulbs.
- Your hands should be dry and free of oil and grease.
- If the newly installed bulb does not come on, contact an authorized Mercedes-Benz Center.

**i** Mercedes-Benz recommends using Longlife (LL) bulbs.

Have the LEDs and bulbs for the following lamps replaced at an authorized Mercedes-Benz Center:

- Additional turn signal lamps in the exterior rear view mirrors
- Bi-Xenon lamps
- Front parking and standing lamps
- Locator lighting lamps in the exterior rear view mirrors
- High-mounted brake lamp

**!** Do not replace the LEDs yourself. You could otherwise damage the LEDs or parts of the vehicle. Only have the LEDs replaced at an authorized Mercedes-Benz Center.

## Replacing bulbs for front lamps

Before you start to replace a bulb for a front lamp, do the following:

- ▶ Switch off the ignition.
- ▶ Turn the exterior lamp switch to position **0**.

## Bi-Xenon headlamp

### Warning!

Do not remove the cover for the Bi-Xenon headlamp. Because of high voltage in Xenon lamps, it is dangerous to replace the bulb or repair the lamp and its components. It is

<sup>10</sup> Bi-Xenon headlamps: Low beam and high beam use the same D 1S-35 W lamp. Do not replace the Bi-Xenon bulbs yourself. Contact an authorized Mercedes-Benz Center.

## 228 Replacing bulbs

recommended to have such work done by a qualified technician.

### Front fog lamp bulb



Example illustration: Right front fog lamp (left front fog lamp laterally reversed)

- ▶ Loosen and remove securing screws ①.
- ▶ Remove front fog lamp trim panel ② in direction of arrow and the seal.



- ▶ Loosen and remove front fog lamp-securing screws ③.
- ⓘ Do not turn adjusting screw ④. If adjusting screw ④ is turned, the front fog lamp adjustment must be checked at a Mercedes-Benz Center.
- ▶ Remove front fog lamp ⑤.

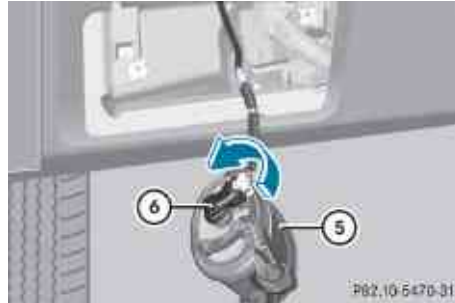

- ▶ Hold front fog lamp ⑤, gently push onto bulb socket ⑥, and turn bulb socket ⑥ counterclockwise to its stop.
- ▶ Pull bulb socket ⑥ out of front fog lamp ⑤.

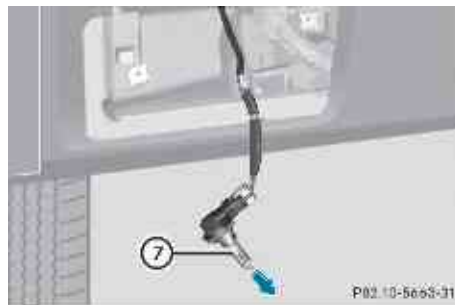

- ▶ Pull bulb ⑦ out of its bulb socket.
- ▶ Insert the new bulb into the bulb socket ⑥.
- ▶ Hold front fog lamp ⑤, insert bulb socket ⑥ into front fog lamp ⑤, and turn bulb socket ⑥ clockwise to its stop.
- ▶ Insert front fog lamp ⑤ and install and tighten front fog lamp-securing screws ③.
- ▶ Install front fog lamp trim panel ② and the seal.
- ▶ Install and tighten securing screws ①.

### Front turn signal lamp bulb

- ▶ G 55 AMG only: Disengage the turn signal guard from the clip in the rear and fold it forward. Make sure the turn signal guard does not strike painted surfaces.

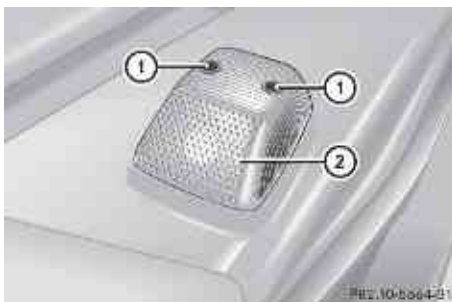

- ▶ Loosen and remove securing screws ①.
- ▶ Remove turn signal lens ②.



- ▶ Press bulb ③ gently into the socket, turn counterclockwise and remove it.
- ▶ Press the new bulb gently into the socket and turn clockwise until it engages.
- ▶ Reinstall turn signal lens ②.
- ▶ Install and tighten securing screws ①.

**i** Do not overtighten securing screws ①. Otherwise turn signal lens ② could be damaged.

- ▶ G 55 AMG only: Remount the turn signal guard.

### Side marker lamp bulb

The following description applies to both, the front and the rear side marker lamps.

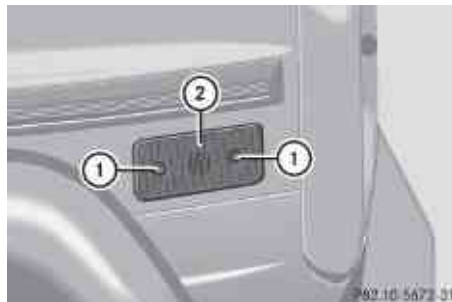

Example illustration: Front side marker

- ▶ Loosen and remove securing screws ①.
- ▶ Remove side marker lamp housing ②.



- ▶ Remove dust cover ③.
- ▶ Press catch aside and pull out the bulb socket with the bulb from side marker lamp housing ②.



- ▶ Gently press onto bulb ④ and turn counterclockwise out of its bulb socket.
- ▶ Gently press the new bulb into the bulb socket and turn clockwise until it engages.

## 230 Replacing bulbs

- ▶ Insert the bulb socket back into side marker lamp housing ②.
  - ▶ Reinstall dust cover ③.
  - ▶ Reinstall side marker lamp housing ②.
  - ▶ Install and tighten securing screws ①.
- i** Do not overtighten securing screws ①. Otherwise side marker lamp housing ② could be damaged.

## Practical hints

**Replacing bulbs for rear lamps**

Before you start to replace a bulb for a rear lamp, do the following:

- ▶ Switch off the ignition.
- ▶ Turn the exterior lamp switch to position **0**.

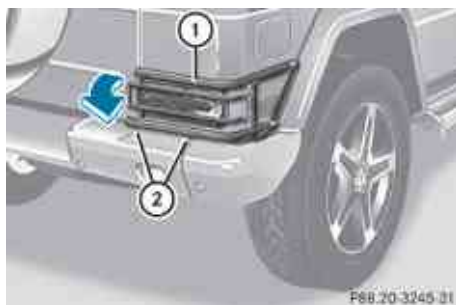
**Removing/installing rear lamp guard (G 55 AMG only)**

- ▶ Remove screws ②.
- ▶ Swivel rear lamp guard ① outward. Make sure the guard does not strike painted surfaces.
- ▶ Swivel rear lamp guard ① back after replacing bulbs and fasten it with screws ②.

**Tail lamp unit**

- ▶ G 55 AMG only: Remove the rear lamp guard.



Example illustration: Left tail lamp lens (right tail lamp lens laterally reversed)

- ▶ Loosen and remove securing screws ①.
- ▶ Remove tail lamp lens ②.



Example illustration: Left tail lamp unit (right tail lamp unit laterally reversed)

- ③ Turn signal lamp bulb
  - ④ Brake, tail, parking and standing lamp bulb
  - ⑤ Tail, parking and standing lamp bulb
- ▶ Gently press onto respective bulb ③, ④, or ⑤ and turn counterclockwise out of its bulb socket.
  - ▶ Gently press the new bulb into the bulb socket and turn clockwise until it engages.
  - ▶ Reinstall tail lamp lens ②.
  - ▶ Install and tighten securing screws ①.



- i** Do not overtighten securing screws ①. Otherwise tail lamp lens ② could be damaged.
- ▶ G 55 AMG only: Reinstall rear lamp guard ① (> page 230).

### Rear fog lamp/Backup lamp

The following description applies to both, the rear fog lamp and the backup lamp.

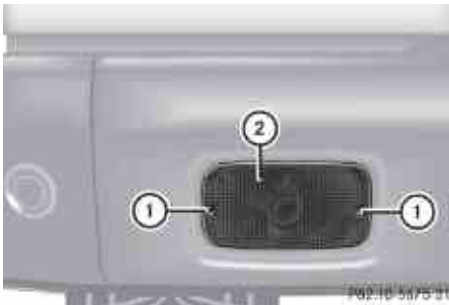

Example illustration: Rear fog lamp

- ▶ Loosen and remove securing screws ①.
- ▶ Remove lamp lens ②.



- ▶ Gently press onto bulb ③ and turn counterclockwise out of its bulb socket.
- ▶ Gently press the new bulb into the bulb socket and turn clockwise until it engages.
- ▶ Reinstall lamp lens ②.
- ▶ Install and tighten securing screws ①.
- i** Do not overtighten securing screws ①. Otherwise lamp lens ② could be damaged.

### License plate lamps

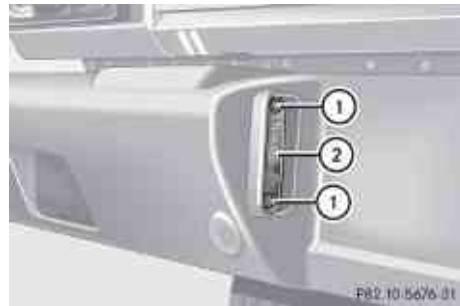

- ▶ Loosen and remove securing screws ①.
- ▶ Remove license plate lamp lens ②.



- ▶ Replace tubular bulb ③.
- ▶ Reinstall license plate lamp lens ②.
- ▶ Install and tighten securing screws ①.
- i** Do not overtighten securing screws ①. Otherwise license plate lamp lens ② could be damaged.

### Replacing wiper blades

#### Safety notes

##### **⚠ Warning!**

For safety reasons, switch off wipers and remove SmartKey from starter switch before replacing a wiper blade. Otherwise, the wiper motor could suddenly turn on and cause injury.

**⚠ Warning!**

Wiper blades are components that are subject to wear and tear. Replace the wiper blades twice a year, preferably in the spring and fall. Otherwise the windows will not be properly wiped. As a result, you may not be able to observe surrounding traffic conditions and could cause an accident.

**Practical hints**

❗ Never open the hood when a front wiper arm is folded forward.

Hold on to the wiper when folding a wiper arm back. If released, the force of the impact from the tensioning spring could crack the windshield or the rear window.

Do not allow a wiper arm to contact the windshield glass or the rear window without a wiper blade inserted.

Mercedes-Benz recommends that you have this work carried out at an authorized Mercedes-Benz Center.

- ▶ Remove the SmartKey from the starter switch.

**Removing wiper blades**

❗ Do not pull on the wiper blade inserts. They could tear.

- ▶ Fold the wiper arm forward until it snaps into place.

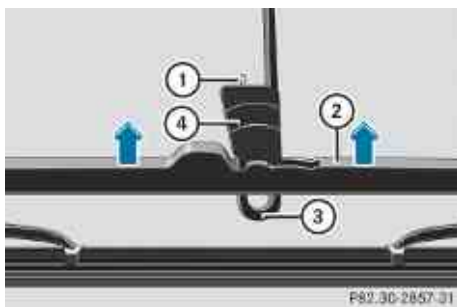

- ▶ Turn wiper blade (2) at a right angle to wiper arm (3).
- ▶ Press safety tab (1) of attachment link (4) down and slide wiper blade (2) from the end of wiper arm (3).
- ▶ Remove wiper blade (2).

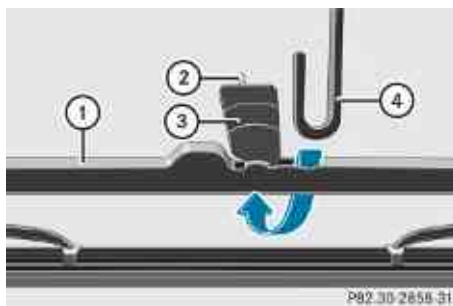
**Installing wiper blades**

- ▶ Guide wiper blade (1) so that opening goes through wiper arm (4).
- ▶ Press wiper blade (1) into wiper arm (4) until safety tab (2) engages in attachment link (3).
- ▶ Fold the wiper arm backward to rest on the windshield.

❗ Make sure the wiper blades are properly installed. Improperly installed wiper blades may cause windshield damage.

**Flat tire****Safety notes**

When you replace the vehicle's tires, you can use the spare wheel as a regular road wheel. However, the spare tire may not be older than 6 years. In addition, the rim and tire must be of same size and model as the regular road wheels.

 **Warning!**

If the spare tire is more than 6 years old or is not the same model as the regular tires, have the spare tire replaced with a new tire at the nearest Mercedes-Benz Center.

Never operate the vehicle with more than one spare wheel mounted.

 **Warning!**

G 55 AMG:

Rim and tire size of spare wheel and regular wheel differ. Handling will be adversely affected when the spare wheel is used.

Do not exceed the maximum speed of 50 mph (80 km/h).

### Preparing the vehicle

- ▶ Park the vehicle in a safe distance from moving traffic on a hard, flat surface when possible.
- ▶ Turn on the hazard warning flasher.
- ▶ Turn the steering wheel so that the front wheels are in a straight-ahead position.
- ▶ Engage the parking brake.
- ▶ Shift the automatic transmission into park position **P**.
- ▶ Turn off the engine.
- ▶ Remove the SmartKey from the starter switch.
- ▶ Have any passenger exit the vehicle at a safe distance from the roadway. Open doors only when conditions are safe to do so.

### Mounting the spare wheel

#### Introduction

- ▶ Prepare the vehicle as described (▷ page 233).

 **Warning!**

You must remove the spare wheel from the spare wheel carrier before lifting the vehicle. Otherwise the vehicle could fall off the jack and injure you or others.

- ▶ Remove the spare wheel from the spare wheel carrier.
- ▶ Take the vehicle tool kit out of the vehicle.
- ▶ Take the jack out of the vehicle.

For information on where to find the respective items, see “Where will I find ...?” (▷ page 194) and (▷ page 195).

### Lifting the vehicle

 **Warning!**

When jacking up the vehicle, only use the jack which has been specifically approved by Mercedes-Benz for your vehicle.

The jack is designed exclusively for jacking up the vehicle under the axle housing. Make sure the jack is positioned correctly under the axle housing. The jack must always be vertical when in use, especially on inclines or declines.

The jack is intended only for lifting the vehicle briefly for wheel changes. It is not suited for performing maintenance work under the vehicle. To help avoid personal injury, use the jack only to lift the vehicle during a wheel change.

Never get beneath the vehicle while it is supported by the jack. Keep hands and feet away from the area under the lifted vehicle. Always lower the vehicle onto sufficient capacity jackstands before working under the vehicle.

Always firmly engage the parking brake and block the wheels with wheel chocks or other sizeable objects before raising the vehicle with the jack. Do not disengage the parking brake while the vehicle is raised.

Make sure that the ground on which the vehicle is standing and where you place the

## 234 Flat tire

jack is solid, level and not slippery. If necessary, use a large underlay. On slippery surfaces, such as tiled floors, you should use a non-slip underlay, for example a rubber mat. Do not use wooden blocks or similar objects to support the jack. Otherwise the jack may not be able to achieve its load-bearing capacity if it is not at its full height.

Never start the engine when the vehicle is raised.

Also observe the notes on the jack.

## Practical hints

- ▶ Prevent the vehicle from rolling away by blocking wheels with wheel chocks (not included) or other sizeable objects.

When changing wheel on a level surface:

- ▶ Place one wheel chock or other sizeable object in front of and another wheel chock or other sizeable object behind the wheel that is diagonally opposite to the wheel being changed.

Always try lifting the vehicle using the jack on a level surface. However, should circumstances require you to do so on a hill, place a wheel chock or other sizeable object and the other wheel chock or sizeable object as follows:

- ▶ Place wheel chocks or other sizeable objects on the downhill side blocking both wheels of the axle not being worked on.

 **Warning!**

Only jack up the vehicle on level ground or on slight inclines/declines. Otherwise, the vehicle could fall off the jack and injure you or others.



- ▶ On the wheel to be changed, loosen but do not yet remove the wheel bolts (approximately one full turn with wheel wrench ①).

- ❗ Do not position the jack on the body of the vehicle, as this may cause damage to the vehicle.



- ▶ Place the jack on firm ground.
- ▶ Position the jack under the axle housing so that it is always vertical as seen from the side, even if the vehicle is parked on an incline.

Make sure the the jack is positioned correctly under the axle housing. The axle must fall into the jack contour.

- ▶ Jack up the vehicle until the wheel is a maximum of 1.2 in (3 cm) from the ground.

### Removing the wheel

- ▶ Unscrew and remove the wheel bolts.

- ❗ Do not place wheel bolts in sand or dirt. This could result in damage to the wheel bolts and wheel hub threads.

- ▶ Remove the wheel.

### Attaching the spare wheel

#### ⚠ Warning!

Always replace wheel bolts that are damaged or rusted.

Never apply oil or grease to wheel bolts.

Damaged wheel hub threads should be repaired immediately. Do not continue to drive under these circumstances! Contact an authorized Mercedes-Benz Center or call Roadside Assistance.

Incorrect wheel bolts or improperly tightened wheel bolts can cause the wheel to come off. This could cause an accident. Be sure to use the correct wheel bolts.

#### ⚠ Warning!

Only use genuine Mercedes-Benz wheel bolts. Other wheel bolts may come loose.

Do not tighten the wheel bolts when the vehicle is raised. Otherwise the vehicle could fall off the jack.

- ▶ Clean contact surfaces of wheel and wheel hub.

- ❗ To avoid paint damage, place wheel flat against hub and hold it there while installing first wheel bolt.

- ▶ Guide the spare wheel onto the wheel hub and push it on.
- ▶ Insert the wheel bolts and tighten them slightly.

### Lowering the vehicle

- ▶ Using the pump handle, turn the release bolt of the jack counterclockwise approximately one turn.

- ⓘ Never turn the release bolt of the jack more than one or two revolutions. Otherwise hydraulic fluid can escape.

- ▶ Lower the vehicle until the vehicle is resting fully on its own weight.

- ▶ Remove the jack.



- ▶ Tighten the five wheel bolts evenly, following the diagonal sequence illustrated (① to ⑤), until all bolts are tight. Observe a tightening torque of 96 lb-ft (130 Nm).

#### ⚠ Warning!

Have the tightening torque checked after changing a wheel. The wheels could come loose if they are not tightened to a torque of 96 lb-ft (130 Nm).

- ▶ Disassemble the pump handle.
- ▶ Press the jack piston in and close the release bolt.
- ▶ Store the jack and the other vehicle tools in the designated storage space.
- ▶ After changing the wheel, secure the damaged wheel on the spare wheel carrier (▷ page 195). Make sure the wheel cannot come loose.
- ▶ Check the tire inflation pressure and correct it if necessary. Follow recommended cold tire inflation pressures listed on the Tire and Loading Information placard on the driver's door B-pillar (▷ page 161).

## Battery

### Safety notes

A battery should always be sufficiently charged in order to achieve its rated service life. Refer to Maintenance Booklet for battery maintenance intervals.

If you use your vehicle mostly for short-distance trips, you will need to have the battery charge checked more frequently.

When replacing a battery, always use a battery approved by Mercedes-Benz.

If you do not intend to operate your vehicle for an extended period of time, contact an authorized Mercedes-Benz Center about steps you need to observe.

### Practical hints

#### **Warning!**

Observe all safety instructions and precautions when handling automotive batteries.



Risk of explosion.



Fire, open flames and smoking are prohibited when handling batteries. Avoid creating sparks.



Battery acid is caustic. Do not allow it to come into contact with skin, eyes or clothing.

Wear suitable protective clothing, especially gloves, apron and faceguard.



Wear eye protection.

Rinse any acid spills immediately with clear water. Contact a physician if necessary.



Keep children away.



Follow the instructions in this Operator's Manual.

Batteries contain materials that can harm the environment if disposed of improperly. Large 12-volt storage batteries contain lead.

Recycling of batteries is the preferred method of disposal. Many states (USA only) or provinces (Canada only) require sellers of batteries to accept old batteries for recycling.

#### **Warning!**

Failure to follow these instructions can result in severe injury or death.

Never lean over batteries while connecting. You might get injured.

Battery fluid contains sulfuric acid. Do not allow this fluid to come in contact with eyes, skin or clothing. In case it does, immediately flush affected area with water and seek medical help if necessary.

A battery will also produce hydrogen gas, which is flammable and explosive. Keep flames or sparks away from battery, avoid improper connection of jumper cables, smoking etc.

#### **Warning!**

Do not place metal objects on the battery as this could result in a short circuit.

Use leak-proof batteries only to avoid the risk of acid burns in the event of an accident.

Take care that you do not become statically charged, e.g. by wearing synthetic clothing or rubbing against textiles. For this reason, you also should not pull or push the battery over carpets or other synthetic materials.

Never touch the battery first. First touch the outside body of the vehicle in order to release any possible electrostatic charges.

Do not rub the battery with rags or cloths. The battery could explode if touched due to electrostatic charge or due to spark formation.

**!** As any other battery, the battery may discharge if do not operate the vehicle for an extended period of time. Have the battery disconnect at a qualified workshop or an authorized Mercedes-Benz Center in such a case. You may also connect an accessory battery charge unit expressly approved by Mercedes-Benz for your vehicle model to maintain the battery charge. Contact an authorized Mercedes-Benz Center for further information.

The battery, the battery ventilation hose and the lateral plug must always be securely installed when the vehicle is in operation.

**!** Never loosen or detach battery terminal clamps while the engine is running or the SmartKey is in the starter switch. Otherwise the alternator and other electronic components could be severely damaged.

Have the battery checked regularly at an authorized Mercedes-Benz Center.

Refer to Maintenance Booklet for maintenance intervals or contact an authorized Mercedes-Benz Center for further information.

### **Charging the battery**

#### **Warning!**

Never charge a battery while still installed in the vehicle unless the accessory battery charge unit approved by Mercedes-Benz is being used. Gases may escape during charging and cause explosions that may result in paint damage, corrosion or personal injury.

An accessory battery charge unit specially adapted for Mercedes-Benz vehicles and tested and approved by Mercedes-Benz is available. It permits the charging of the battery in its installed position. Contact an authorized Mercedes-Benz Center for information and availability.

Charge battery in accordance with the separate instructions for the accessory battery charger.

Have batteries charged at an authorized Mercedes-Benz Center. If you charge the batteries yourself, follow the operating instructions for your charging device.

Only use a battery charge unit with a maximum charging voltage of 14.8 V.

► Charge battery in accordance with the instructions of the battery charger manufacturer.

### **Jump starting**

#### **Warning!**

Failure to follow these directions will cause damage to the electronic components, and can lead to a battery explosion and severe injury or death.

Never lean over batteries while connecting or jump starting. You might get injured.

Battery fluid contains sulfuric acid. Do not allow this fluid to come in contact with eyes, skin or clothing. In case it does, immediately flush affected area with water, and seek medical help if necessary.

A battery will also produce hydrogen gas, which is flammable and explosive. Keep flames or sparks away from battery, avoid improper connection of jumper cables, smoking, etc.

Attempting to jump start a frozen battery can result in it exploding, causing personal injury.

Read all instructions before proceeding.

## 238 Jump starting

**!** Do not tow-start the vehicle. You could otherwise seriously damage the automatic transmission which is not covered by the Mercedes-Benz Limited Warranty.

**!** Jump starting should only be performed using the jump-start terminals located in the engine compartment.

Avoid repeated and lengthy starting attempts.

Do not attempt to start the engine using a battery quick-charge unit.

If the engine does not run after several unsuccessful starting attempts, have it checked at the nearest authorized Mercedes-Benz Center.

Excessive unburned fuel generated by repeated failed starting attempts may damage the catalytic converter and may present a fire risk.

Make sure the jumper cables do not have loose or missing insulation.

Make sure the cable clamps do not touch any other metal part while the other end is still attached to a battery.

If the battery is discharged, the engine can be started with jumper cables and the fully charged battery of another vehicle or an equivalent starter pack. Observe the following:

- Access to the battery is not possible on all vehicles. If you cannot access the battery of the other vehicle, provide jump start

power by an external battery or starter pack.

- Jump starting should only be performed when the engine and catalytic converter are cold.
  - Do not start the engine if the battery is frozen. Let the battery thaw out first.
  - Only jump start from batteries with the same voltage rating (12 V). Jump starting with a more powerful battery could damage the vehicle's electrical system. Such damage will not be covered by the Mercedes-Benz Limited Warranty.
  - Only use jumper cables with sufficient cross-section and insulated terminal clamps.
  - Always make sure the jumper cables are not on or near pulleys, fans or other parts that move when an engine is started or running.
  - Should the battery be drained completely, let the donating power source charge the vehicle for several minutes before reattempting the starting process.
- ▶ Make sure the two vehicles do not touch.
  - ▶ Switch off all electrical consumers.
  - ▶ Engage the parking brake.
  - ▶ Make sure the automatic transmission is in park position **P**.
  - ▶ Open the hood (▷ page 148).



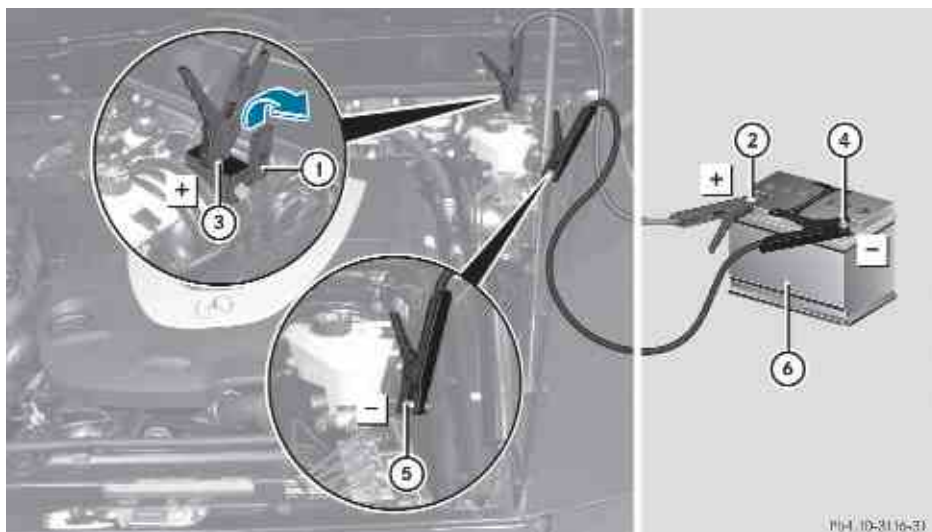

Position ⑥ represents the charged battery of another vehicle or an equivalent starter pack.

- ▶ Flip up cover ① of positive terminal ③ in direction of arrow.

**!** Never invert the terminal connections!

- ▶ Connect positive terminal ② of charged battery ⑥ with positive terminal ③ with a jumper cable. Clamp the cable to positive terminal ② of charged battery ⑥ first.
- ▶ Start engine of the vehicle with charged battery ⑥ and run at idle speed.
- ▶ Connect negative terminal ④ of charged battery ⑥ with negative terminal ⑤ with a jumper cable. Clamp the cable to negative terminal ④ of charged battery ⑥ first.
- ▶ Start engine of the vehicle with the discharged battery and run at idle speed. You can now turn on the electrical consumers. Do not switch on the headlamps under any circumstances.
- ▶ Remove the jumper cables from negative terminals ④ and ⑤ first.

- ▶ Remove the jumper cables from positive terminals ② and ③. You can now switch on the headlamps.
- ▶ Slide cover ① from positive terminal ③ back.
- ▶ Have the battery checked at the nearest authorized Mercedes-Benz Center.

## Towing the vehicle

### Safety notes

Mercedes-Benz recommends that the vehicle be transported with all wheels off the ground using flatbed or appropriate wheel lift/dolly equipment. This method is preferable to other types of towing.

- !** To prevent damage during transport, do not tie down vehicle by its chassis or suspension parts.

If circumstances do not permit the recommended towing methods, the vehicle may be towed with all wheels on the ground only so far as necessary to have the vehicle moved to a safe location where the recommended towing methods can be employed.

**!** Before towing the vehicle observe the following instructions:

- Do not tow-start the vehicle. You could otherwise seriously damage the automatic transmission which is not covered by the Mercedes-Benz Limited Warranty.
- Do not tow with sling-type equipment. Towing with sling-type equipment over bumpy roads will damage radiator and supports.
- Towing of the vehicle should only be done using the towing eye. Never attach a tow cable, tow rope or tow rod to the vehicle chassis, frame or suspension parts.

**!** When towing the vehicle with all wheels on the ground, the gear selector lever must be in neutral position **N** and the SmartKey must be in starter switch position **2**.

When towing the vehicle with all wheels on the ground, the vehicle may be towed only for distances up to 30 miles (50 km) and at a speed not to exceed 30 mph (50 km/h). If the vehicle is towed with one axle raised (observe instructions regarding flexible drive shaft and propeller shafts), the engine must be shut off and the SmartKey must be in starter switch position **1**. Otherwise, the 4-ETS may become engaged which may cause loss of towing control.

#### **Warning!**

If circumstances require towing the vehicle with all wheels on the ground, always tow with a tow bar if:

- the engine will not run
- there is a malfunction in the brake system
- there is a malfunction in the power supply or in the vehicle's electrical system

This is necessary to adequately control the towed vehicle.

Prior to towing the vehicle with all wheels on the ground, make sure the SmartKey is in starter switch position **2**.

If the SmartKey is left in the starter switch position **0** for an extended period of time, it can no longer be turned in the switch. In this case, the steering is locked. To unlock, remove SmartKey from starter switch and reinsert.

#### **Warning!**

With the engine not running, there is no power assistance for the brake and steering systems. In this case, it is important to keep in mind that a considerably higher degree of effort is necessary to brake and steer the vehicle. Adapt your driving accordingly.

- i** If the battery is disconnected or discharged
  - the SmartKey will not turn in the starter switch
  - the automatic transmission will remain in park position **P**
  - For more information see “Battery” (> page 236) or “Jump starting” (> page 237).
  - For information on manually unlocking the gear selector lever, see (> page 222)
- i** When towing the vehicle with all wheels on the ground, note the following:
 

With the automatic central locking activated and the SmartKey in starter switch position **2**, the vehicle doors lock if a wheel is turning at vehicle speeds of approximately 9 mph (15 km/h) or above. To prevent the vehicle doors from locking, deactivate the automatic central locking (> page 108).
- i** To signal turns while being towed with hazard warning flasher in use, turn the SmartKey in starter switch to position **2**

and activate combination switch for left or right turn signal in usual manner – only the selected turn signal will operate. Upon canceling the turn signal, the hazard warning flasher will operate again.

### Towing eyes

#### Front towing eyes

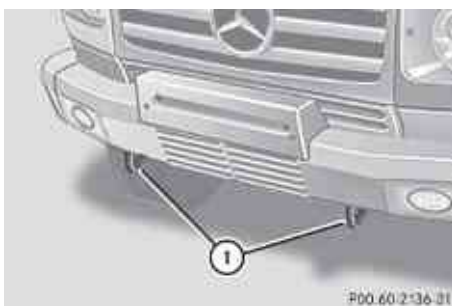

① Towing eyes

#### Rear towing eye

The rear towing eye is located on the driver's side under the rear bumper.



① Towing eye

### Transporting the vehicle

When transporting the vehicle, you can use the towing eyes for pulling the vehicle onto a trailer or transporter.

- ▶ Move the gear selector lever to neutral position **N**.
- ▶ Shift the transfer case to neutral position **N**.
- ▶ To avoid damaging the vehicle, it should only be tied down on the wheels/wheel rims, not on chassis components such as the transverse link or trailing arm.

### Towing the vehicle - various problem scenarios

- ❗ When removing drive shaft, place M10 nuts on bolts as distance sleeves and tighten using M8 nuts. Always install new self-locking nuts when reinstalling the drive shaft.
- ▶ Comply with all towing information (▷ page 239).

### In case of engine damage, transmission damage or malfunctions in electrical equipment

- ▶ Move the gear selector lever to neutral position **N**.
- ▶ Shift the transfer case to neutral position **N**.

### In case of transfer case damage or for towing vehicle distances exceeding 30 miles (50 km)

The propeller shafts to the drive axles must be removed.

### In case of front axle damage

Raise the front axle when towing. The propeller shaft between the rear axle and the transfer case must be removed.

### In case of rear axle damage

When the rear axle is raised, the vehicle can only be towed with a wheel lift or a dolly placed under its front wheels.

### Stranded vehicle

Freeing a stranded vehicle, on which the wheels are dug into sand or mud, should be done with the greatest of care, especially if the vehicle is heavily loaded.

Note the following when freeing a stranded vehicle:

- Avoid pulling the vehicle abruptly or diagonally, since it could result in damage to the chassis alignment.
- Never try to free a vehicle that is still coupled to a trailer.
- If possible, a vehicle equipped with a trailer hitch receiver should be pulled backward in its own previously made tracks.

## Fuses

### Introduction

The electrical fuses in your vehicle serve to switch off malfunctioning power circuits. If a fuse is blown, the components and systems secured by that fuse will stop operating.

#### **Warning!**

Only use fuses approved by Mercedes-Benz with the specified amperage for the system in question and do not attempt to repair or bridge a blown fuse. Using other than approved fuses or using repaired or bridged fuses may cause an overload leading to a fire, and/or cause damage to electrical components and/or systems. Have the cause determined and remedied by an authorized Mercedes-Benz Center.

A blown fuse must be replaced by an appropriate spare fuse (recognizable by its color or the fuse rating given on the fuse) of the amperage recommended in the fuse chart. Any Mercedes-Benz Center will be glad to advise you on this subject.

**i** In case of a blown fuse contact Roadside Assistance or an authorized Mercedes-Benz Center.

If a newly inserted fuse blows again, have the cause determined and rectified by an authorized Mercedes-Benz Center.

A fuse chart is located in the fuse box in the passenger compartment. The fuse chart explains the fuse allocation and fuse amperages.

### Before replacing fuses

- ▶ Engage the parking brake.
- ▶ Make sure the automatic transmission is in park position **P**.
- ▶ Switch off all electrical consumers.
- ▶ Turn off the engine.
- ▶ Remove the SmartKey from the starter switch.

### Fuse boxes in passenger compartment

**!** The fuse box cover must be properly positioned as described. Otherwise, moisture or dirt could enter the fuse box and possibly impair fuse operation.

### Fuse box in dashbord



- ▶ Open the driver's door.
- ▶ **Opening:** Remove cover ① in direction of the arrows.

### Fuse box in front passenger footwell

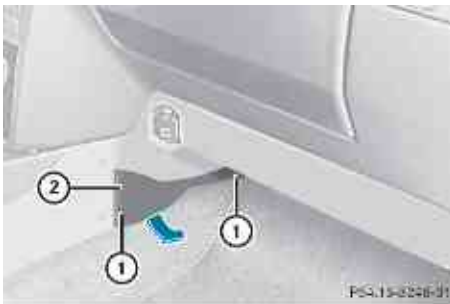

- ▶ Open the front passenger door.
- ▶ **Opening:** Unscrew mounting screws ①.
- ▶ Remove cover ② in direction of the arrow.

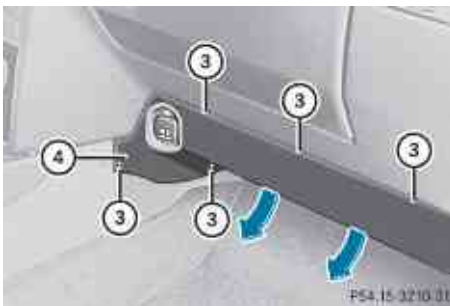

- ▶ Unscrew mounting screws ③.
- ▶ Remove cover ④ in direction of the arrows.



- ▶ **i** To make changing the fuses easier, fuse box ⑤ can be folded down slightly.
- ▶ Unscrew mounting screws ⑥.
- ▶ Fold fuse box ⑤ downward in direction of the arrow.

### Fuse box in middle tunnel

#### Removing front end stops

##### **Warning!**

Do not drive the vehicle when the front end stops are not correctly installed. Failure to reinstall stops as indicated may result in serious injury in certain frontal crashes.

Adjust the front passenger seat as far as possible rearward from the dashboard when the seat is occupied. Comply with information on occupant safety section.

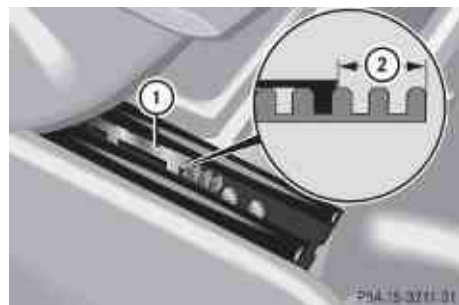

Front end stop on the right seat rail, left seat rail laterally reversed

- ① Front end stop
- ② Spacing

- ▶ Open the front passenger door.
- ▶ Remove both front end stops ① of the front passenger seat tracks using a screwdriver.
- ▶ Move front passenger seat fully forward.

**!** When reinstalling front passenger seat track stops, place end stops in correct position. For your safety, maintain proper spacing.

Practical hints

### Opening fuse box



- ▶ Unscrew mounting screws ①.
- ▶ Remove cover ② in direction of the arrow.

### Fuse box in battery box

The battery box is located under a cover in the rear footwell.

Replacement of fuses can only be performed at a Mercedes-Benz Center.

<b>Vehicle equipment</b> .....	246
<b>Parts service</b> .....	246
<b>Warranty coverage</b> .....	246
<b>Identification labels</b> .....	246
<b>Vehicle specification G 550 (463.237)</b> .....	248
<b>Vehicle specification G 55 AMG (463.271)</b> .....	249
<b>Rims and tires</b> .....	250
<b>Fuels, coolants, lubricants, etc.</b> .....	252



### Vehicle equipment

**i** This Operator's Manual describes all features, standard or optional, potentially available for your vehicle at the time of purchase. Please be aware that your vehicle might not be equipped with all features described in this manual.

### Parts service

All authorized Mercedes-Benz Centers maintain a stock of Genuine Mercedes-Benz Parts required for maintenance and repair work. In addition, strategically located parts distribution centers provide quick and reliable parts service.

More than 300 000 different parts for Mercedes-Benz models are available.

Genuine Mercedes-Benz Parts are subjected to stringent quality inspections. Each part has been specifically developed, manufactured or selected for and adapted to Mercedes-Benz vehicles.

Therefore, Genuine Mercedes-Benz Parts should be installed.

**!** Do not use non-genuine Mercedes-Benz parts and accessories not authorized by Mercedes-Benz. Doing so could damage the vehicle, which is not covered by the Mercedes-Benz Limited Warranty. Also, it could compromise the vehicle's durability or safety.

### Warranty coverage

Your vehicle is covered under the terms of the warranties printed in the Service and Warranty Information booklet.

Your authorized Mercedes-Benz Center will exchange or repair any defective parts originally installed in the vehicle in accordance with the terms of the following warranties:

- New Vehicle Limited Warranty
- Emission System Warranty
- Emission Performance Warranty
- California, Connecticut, Maine, Massachusetts, New York, Pennsylvania, Rhode Island, and Vermont Emission Control Systems Warranty
- State Warranty Enforcement Laws (Lemon Laws)

Replacement parts and accessories are covered by the Mercedes-Benz Parts and Accessories warranties, copies of which are available at any authorized Mercedes-Benz Center.

### Loss of Service and Warranty Information booklet

Should you lose your Service and Warranty Information booklet, have an authorized Mercedes-Benz Center arrange for a replacement. It will be mailed to you.

### Identification labels

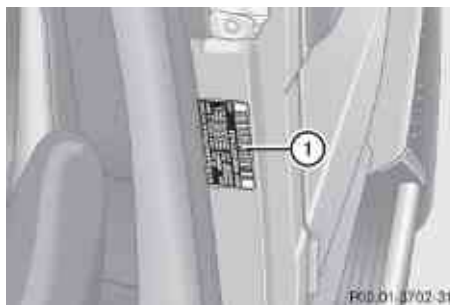



The Vehicle Identification Number (VIN) can be found

- on certification label ① on the driver's door B-pillar
- on the frame in the passenger-side front wheel house (▷ page 247)
- on the lower edge of the windshield (▷ page 247)



Example certification label (U.S. vehicles)

- ② VIN
- ③ Paintwork code



Example certification label (Canada vehicles)

- ② VIN
- ③ Paintwork code

**i** Data shown on certification label are for illustration purposes only. These data are specific to each vehicle and may vary from data shown in the illustration. Refer to certification label on vehicle for actual data specific to your vehicle.

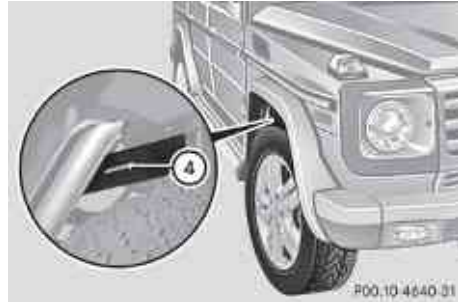

- ④ VIN (on frame in passenger-side front wheel house)



- ⑤ VIN (on lower edge of windshield)

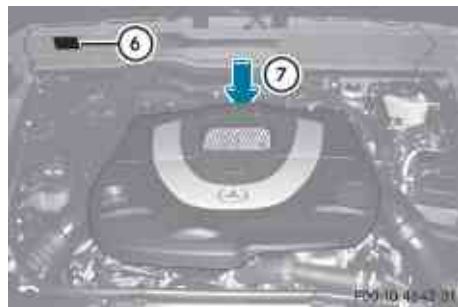

Example illustration G 550

- ⑥ Emission control information label, includes both federal and California certification exhaust emission standards
- ⑦ Engine number (engraved on engine)

**i** When ordering parts, please specify vehicle identification and engine number.

248 **Vehicle specification G 550 (463.237)****Vehicle specification G 550 (463.237)**

The quoted data apply only to the standard vehicle. Contact an authorized Mercedes-Benz Center for the corresponding data of all special bodies and special equipment.

<b>Engine G 550</b>	
<b>Engine, type</b>	273
<b>Mode of operation</b>	4-stroke engine, gasoline injection
<b>No. of cylinders</b>	8
<b>Bore</b>	3.86 in (98.00 mm)
<b>Stroke</b>	3.56 in (90.50 mm)
<b>Total piston displacement</b>	333.3 cu in (5 461 cm <sup>3</sup> )
<b>Compression ratio</b>	10.7:1
<b>Output acc. to SAE J 1349<sup>11</sup></b>	382 hp/6 000 rpm (285 kW/6 000 rpm)
<b>Maximum torque acc. to SAE J 1349</b>	391 lb-ft/ 2 800 - 4 800 rpm (530 Nm/ 2 800 - 4 800 rpm)
<b>Maximum engine speed</b>	6 500 rpm
<b>Firing order</b>	1-5-4-2-6-3-7-8
<b>Poly-V-belt</b>	2 404 mm

**Electrical system G 550**

<b>Alternator</b>	14 V/180 A
<b>Starter motor</b>	12 V/1.4 kW
<b>Battery</b>	12 V/95 Ah
<b>Spark plugs, type</b>	NGK PLKR 7A
<b>Spark plugs, electrode gap</b>	0.031 in (0.8 mm)
<b>Spark plugs, tightening torque</b>	15 - 18 lb-ft (20 - 25 Nm)

**Main dimensions G 550**

<b>Overall vehicle length<sup>12</sup></b>	186.2 in (4 730 mm)
<b>Overall vehicle width<sup>13</sup></b>	79.7 in (2 025 mm)
<b>Overall vehicle height</b>	77.8 in (1 977 mm)
<b>Wheelbase</b>	112.2 in (2 850 mm)
<b>Track, front</b>	59.7 in (1 515 mm)
<b>Track, rear</b>	59.7 in (1 515 mm)
<b>Ground clearance, front</b>	8.5 in (217 mm)
<b>Ground clearance, rear</b>	8.1 in (205 mm)
<b>Turning circle</b>	43.6 ft (13.3 m)

Technical data

<sup>11</sup> Premium fuel required. Performance may vary with fuel octane rating.

<sup>12</sup> Inc. spare wheel.

<sup>13</sup> Exterior rear view mirrors folded out.

## Vehicle specification G 55 AMG (463.271)

249

Weights and ratings G 550	
<b>Gross Vehicle Weight Rating (GVWR)<sup>14</sup></b>	6 615 lb (3 000 kg)
<b>Gross Axle Weight Rating (GAWR), front<sup>15</sup></b>	3 110 lb (1 410 kg)
<b>Gross Axle Weight Rating (GAWR), rear<sup>15</sup></b>	3 965 lb (1 800 kg)

Vehicle specification G 55 AMG  
(463.271)

The quoted data apply only to the standard vehicle. Contact an authorized Mercedes-Benz Center for the corresponding data of all special bodies and special equipment.

Engine G 55 AMG	
<b>Engine, type</b>	113
<b>Mode of operation</b>	4-stroke engine, gasoline injection
<b>No. of cylinders</b>	8
<b>Bore</b>	3.82 in (97.00 mm)
<b>Stroke</b>	3.62 in (92.00 mm)
<b>Total piston displacement</b>	331.9 cu in (5 439 cm <sup>3</sup> )
<b>Compression ratio</b>	9.0:1

Engine G 55 AMG	
<b>Output acc. to SAE J 1349<sup>16</sup></b>	500 hp/6 100 rpm (373 kW/6 100 rpm)
<b>Maximum torque acc. to SAE J 1349</b>	516 lb-ft/2 750 - 4 000 rpm (700 Nm/2 750 - 4 000 rpm)
<b>Maximum engine speed</b>	6 500 rpm
<b>Firing order</b>	1-5-4-2-6-3-7-8
<b>Poly-V-belt</b>	Belt one: 1 289 mm Belt two: 2 449 mm

Electrical system G 55 AMG	
<b>Alternator</b>	14 V/180 A
<b>Starter motor</b>	12 V/1.7 kW
<b>Battery</b>	12 V/90 Ah
<b>Spark plugs, type</b>	NGK ILFR 6A
<b>Spark plugs, electrode gap</b>	0.039 in (1.0 mm)
<b>Spark plugs, tightening torque</b>	15 - 22 lb-ft (20 - 30 Nm)

Main dimensions G 55 AMG	
<b>Overall vehicle length</b>	186.2 in (4 730 mm) <sup>17</sup> 188.2 in (4 780 mm) <sup>18</sup>

Technical data

<sup>14</sup> The GVWR is the maximum permissible vehicle weight. The Gross Vehicle Weight (GVW) comprises weight of vehicle including fuel, tools, spare wheel, installed accessories, passengers, cargo, and if applicable, trailer tongue load. The GVW must never exceed the GVWR.

<sup>15</sup> The GAWR is the maximum permissible axle weight.

<sup>16</sup> Premium fuel required. Performance may vary with fuel octane rating.

<sup>17</sup> Inc. spare wheel.

<sup>18</sup> Inc. spare wheel and brush guard (U.S. vehicles only).

**Main dimensions G 55 AMG**

<b>Overall vehicle width<sup>19</sup></b>	79.7 in (2 025 mm)
<b>Overall vehicle height</b>	77.4 in (1 965 mm)
<b>Wheelbase</b>	112.2 in (2 850 mm)
<b>Track, front</b>	59.1 in (1 501 mm)
<b>Track, rear</b>	59.1 in (1 501 mm)
<b>Ground clearance, front</b>	7.9 in (200 mm)
<b>Ground clearance, rear</b>	7.9 in (200 mm)
<b>Turning circle</b>	43.6 ft (13.3 m)

**Weights and ratings G 55 AMG**

<b>Gross Vehicle Weight Rating (GVWR)<sup>20</sup></b>	6 615 lb (3 000 kg)
<b>Gross Axle Weight Rating (GAWR), front<sup>21</sup></b>	3 263 lb (1 480 kg)
<b>Gross Axle Weight Rating (GAWR), rear<sup>21</sup></b>	3 965 lb (1 800 kg)

**Rims and tires****Notes**

- !** Only use tires which have been tested and approved by Mercedes-Benz. Tires approved by Mercedes-Benz are developed to provide best possible performance in conjunction with the driving safety systems

on your vehicle such as the ABS or the ESP®. Tires specially developed for your vehicle and tested and approved by Mercedes-Benz can be identified by finding the following on the tire's sidewall:

- MO = Mercedes-Benz Original equipment tires

May not apply to all approved tires. For information on tested and approved tires, contact an authorized Mercedes-Benz Center.

Using tires other than those approved by Mercedes-Benz may result in damage that is not covered by the Mercedes-Benz Limited Warranty.

- !** Using tires other than those approved by Mercedes-Benz can have detrimental effects, such as

- poor handling characteristics
- increased noise
- increased fuel consumption

Moreover, tires and rims not approved by Mercedes-Benz may, under load, exhibit dimensional variations and different tire deformation characteristics that could cause them to come into contact with the vehicle body or axle parts. Damage to the tires or the vehicle may be the result.

- i** Further information on tires and rims is available at any authorized Mercedes-Benz Center. A placard with the recommended tire inflation pressures is located on the driver's door B-pillar. Some vehicles may have supplemental tire inflation pressure information for driving at high speeds or for vehicle loads less than the maximum loaded vehicle condition. If such information is provided, it can be found on the placard located on the inside of the fuel

<sup>19</sup> Exterior rear view mirrors folded out.

<sup>20</sup> The GVWR is the maximum permissible vehicle weight. The Gross Vehicle Weight (GVW) comprises weight of vehicle including fuel, tools, spare wheel, installed accessories, passengers, cargo, and if applicable, trailer tongue load. The GVW must never exceed the GVWR.

<sup>21</sup> The GAWR is the maximum permissible axle weight.

filler flap. The tire inflation pressure should be checked regularly and should only be adjusted on cold tires. Follow tire manufacturer's maintenance recommendation included with the vehicle.

For information on recommended tire inflation pressure and supplemental tire inflation pressure information for special driving situations, see (▷ page 154).

**i** The following pages also list the approved rim and tire sizes for equipping your vehicle with winter tires. Winter tires are not

available as standard or optional factory equipment, but can be purchased from an authorized Mercedes-Benz Center.

Equipping your vehicle with winter tires approved for your vehicle model may require the purchase of rims of the recommended size for use with these winter tires. This depends on vehicle model and the standard or optional factory-equipped wheel rim/tire configuration on your vehicle. For more information contact an authorized Mercedes-Benz Center.

### Same size tires

		G 550	G 55 AMG
18" wheels	Rims (light alloy)	7.5 J x 18 H2	7.5 J x 18 H2
	Wheel offset	1.69 in (43 mm)	1.69 in (43 mm)
	All-season tires <sup>22</sup>	265/60 R18 110V M+S	—
	Winter tires <sup>22,23</sup>	—	265/60 R18 109H M+S 

		G 55 AMG
19" wheels	AMG rims (light alloy)	9.5 J x 19 H2
	Wheel offset	1.97 in (50 mm)
	All-season tires <sup>22,24</sup>	275/55 R19 111V M+S

### Spare wheel

	G 550	G 55 AMG
Rim (light alloy)	7.5 J x 18 H2	7.5 J x 18 H2
Wheel offset	1.69 in (43 mm)	1.69 in (43 mm)
All-season tire <sup>25</sup>	265/60 R18 110V M+S	265/60 R18 110V M+S

<sup>22</sup> Radial-ply tires.

<sup>23</sup> Not available as factory equipment.

<sup>24</sup> Must not be used with snow chains.

<sup>25</sup> Radial-ply tire.

252 **Fuels, coolants, lubricants, etc.****Fuels, coolants, lubricants, etc.****Capacities**

Vehicle components and their respective lubricants must match. Therefore only use products tested and approved by Mercedes-Benz.

For information on tested and approved products, contact an authorized Mercedes-Benz Center or visit [www.mbusa.com](http://www.mbusa.com) (USA only).

fluids. Otherwise you could endanger persons or the environment.

Keep service fluids out of the reach of children.

For health reasons, you should prevent service fluids from coming into direct contact with your skin or clothing.

If a service fluid is swallowed, contact a physician immediately.

 **Warning!**

Comply with all valid regulations with respect to handling, storing, and disposing of service

**Technical data**

	<b>Model</b>	<b>Capacity</b>	<b>Fuels, coolants, lubricants, etc.</b>
<b>Engine with oil filter</b>	G 550	9.5 US qt (9.0 l)	Approved engine oils
	G 55 AMG	9.0 US qt (8.5 l)	
<b>Automatic transmission</b>	G 550	9.5 US qt (9.0 l)	MB Automatic Transmission Fluid
	G 55 AMG	9.0 US qt (8.5 l)	
<b>Front axle</b>	G 550	1.5 US qt (1.4 l)	Hypoid Gear Oil (SAE 85W-90)
	G 55 AMG		Hypoid Gear Oil (Castrol SAF-XJ)
<b>Rear axle</b>	G 550	1.9 US qt (1.8 l)	Hypoid Gear Oil (SAE 85W-90)
	G 55 AMG		Hypoid Gear Oil (Castrol SAF-XJ)
<b>Transfer case</b>	All models	2.96 US qt (2.8 l)	MB part no. A 001 989 28 03 10
<b>Differential lock mechanism</b>	All models	0.47 - 0.63 US qt (0.45 - 0.6 l)	Brake fluid DOT 3+4, (SAE J 1703)
<b>Power steering</b>	All models	approx. 1.06 US qt (1.0 l)	MB Power Steering Fluid, or approved Dexron III ATF
<b>Brake system</b>	All models	0.87 US qt (0.82 l)	MB Brake Fluid (DOT 4+)

	Model	Capacity	Fuels, coolants, lubricants, etc.
<b>Cooling system</b>	G 550	approx. 12.8 US qt (12.1 l)	MB 325.0 Anticorrosion/ Antifreeze
	G 55 AMG	approx. 13.4 US qt (12.7 l)	
<b>Fuel tank</b>	G 550	25.4 US gal (96.0 l)	Premium unleaded gasoline (Minimum Posted Octane 91 [Avg. of 96 RON/86 MON])
	G 55 AMG	25.1 US gal (95.0 l)	
<b>Fuel tank reserve</b>	All models	approx. 5.3 US gal (20.0 l)	
<b>Air conditioning system</b>	All models	–	R134a refrigerant and special PAG lubricant oil (never R 12)
<b>Washer system and headlamp cleaning system</b>	All models	7.9 US qt (7.5 l)	MB Windshield Washer Concentrate <sup>26</sup> (▷ page 257) Washer fluid mixing ratio (▷ page 257)

### Approved engine oils

Engine oils are specifically tested for their suitability in our engines and durability for our service intervals. Therefore, only use approved engine oils and oil filters required for vehicles with Maintenance System.

For a listing of approved engine oils and oil filters, contact an authorized Mercedes-Benz Center or visit [www.mbusa.com](http://www.mbusa.com) (USA only).

**!** Using engine oils and oil filters of a specification other than those expressly required for the Maintenance System, or changing of oil and oil filter at change intervals longer than those called for by the Maintenance System will result in engine or emission control system damage not covered by the Mercedes-Benz Limited Warranty.

Please follow Maintenance System recommendations for scheduled oil changes. Failure to do so will result in engine or emission control system damage not covered by the Mercedes-Benz Limited Warranty.

Mercedes-Benz recommends MOBIL OIL. Use the table below to determine the MB sheet number.

Model	Engine, type	MB sheet number
G 550	273	229.5
G 55 AMG	113	229.5

**i** MB sheet numbers are printed on the outside of oil containers.

<sup>26</sup> Mixed with water or commercially available premixed washer solvent/antifreeze.

## 254 Fuels, coolants, lubricants, etc.

### Viscosity grades for engine oils

Using the chart below, select oil viscosity according to the lowest air temperature expected before the next oil change.

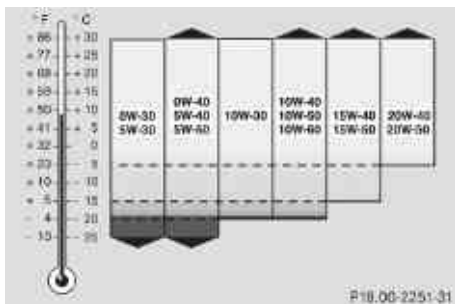

### Engine oil additives

- ❗ Do not blend oil additives with engine oil. They may damage the engine. Damage or malfunctions resulting from blending oil additives are not covered by the Mercedes-Benz Limited Warranty.

### Air conditioning refrigerant

R134a (HFC) refrigerant and special PAG lubricating oil are used in the air conditioning system.

- ❗ Never use R 12 (CFC) or mineral-based lubricating oil. Otherwise damage to the system will occur.

### Brake fluid

#### ⚠ Warning!

During vehicle operation, the boiling point of the brake fluid is continuously reduced through the absorption of moisture from the atmosphere.

Under extremely strenuous operating conditions, this moisture content can lead to the formation of bubbles in the system, thus reducing the system's efficiency.

Therefore, the brake fluid must be replaced regularly. Refer to your vehicle's Maintenance Booklet for replacement interval.

Only brake fluid approved by Mercedes-Benz is recommended. Any authorized Mercedes-Benz Center will provide you with additional information.

### Premium unleaded gasoline

#### ⚠ Warning!

Gasoline is highly flammable and poisonous. It burns violently and can cause serious personal injury.

Never allow sparks, flames or smoking materials near gasoline!

Turn off the engine before refueling.

Whenever you are around gasoline, avoid inhaling fumes and any skin or clothing contact. Extinguish all smoking materials.

Direct skin contact with fuels and the inhalation of fuel vapors are damaging your health.

- ❗ To maintain the engine's durability and performance, premium unleaded gasoline must be used.

If premium unleaded gasoline is not available and low octane gasoline is used, follow these precautions:

- Have the fuel tank only partially filled with unleaded regular gasoline and fill up with premium unleaded gasoline as soon as possible.
- Avoid full throttle driving and abrupt acceleration.
- Do not exceed an engine speed of 3000 rpm if the vehicle is loaded with a light load such as two persons and no luggage.
- Do not exceed  $\frac{2}{3}$  of maximum accelerator pedal position if the vehicle



is fully loaded or operating in mountainous terrain.

### Fuel requirements

Only use premium unleaded gasoline. The octane number (posted at the pump) must be 91 min. It is an average of both the Research Octane Number (RON) and the Motor Octane Number (MON):  $(RON+MON)/2$ . This is also known as the ANTI-KNOCK INDEX.

Reformulated gasolines (RFG) and/or unleaded gasoline containing oxygenates such as ethanol, TAME, ETBE, IPA, IBA, and TBA can be used provided the ratio of any one of these oxygenates to gasoline does not exceed 10%; MTBE must not exceed 15%.

The ratio of methanol to gasoline must not exceed 3% plus additional cosolvents.

Using mixtures of ethanol and methanol is not allowed. Gasohol, which contains 10% ethanol and 90% unleaded gasoline, can be used.

These blends must also meet all other fuel requirements, such as resistance to spark knock, boiling range, vapor pressure, etc.

### Gasoline additives

A major concern among engine manufacturers is carbon build-up caused by gasoline. Mercedes-Benz recommends only the use of quality gasoline containing additives that prevent the build-up of carbon deposits.

After an extended period of using fuels without such additives carbon deposits can build up, especially on the intake valves and in the combustion area, leading to engine performance problems such as:

- Warm-up hesitation
- Unstable idle
- Knocking/pinging

- Misfire
- Power loss

In areas where carbon deposits may be encountered due to lack of availability of gasoline which contains these additives, Mercedes-Benz recommends the use of additives approved by us for use on Mercedes-Benz vehicles.

Contact an authorized Mercedes-Benz Center or visit [www.mbusa.com](http://www.mbusa.com) (USA only) for a listing of approved product(s). Follow directions on product label.

Do not blend other fuel additives with fuel. This only results in unnecessary cost and may be harmful to the engine operation.

**!** Damage or malfunction resulting from poor fuel quality or from blending additional fuel additives other than those tested and approved by us for use on Mercedes-Benz vehicles are not covered by the Mercedes-Benz Limited Warranty or by any pre-owned or Extended Limited warranties.

### Coolants

The engine coolant is a mixture of water and anticorrosion/antifreeze, which provides:

- Corrosion protection
- Freeze protection
- Boiling protection (by increasing the boiling point)

The cooling system was filled at the factory with a coolant providing freeze protection to approximately -35°F (-37°C) and corrosion protection.

**!** Add premixed coolant solution only. Adding water and MB 325.0 Anticorrosion/Antifreeze separately from each other, could cause engine damage not covered by the Mercedes-Benz Limited Warranty.

If the antifreeze mixture is effective to -35°F (-37°C), the boiling point of the coolant in the

pressurized cooling system is reached at approximately 266°F (130°C).

The coolant solution must be used year round to provide the necessary corrosion protection and increase boil-over protection. Refer to the Maintenance Booklet for replacement interval.

Coolant system design and coolant used determine the replacement interval. The replacement interval published in the Maintenance Booklet is only applicable if MB 325.0 Anticorrosion/Antifreeze solution or other Mercedes-Benz approved products of equal specification are used to renew the coolant concentration or bring it back up to the proper level.

For information on other Mercedes-Benz approved products of equal specification, contact an authorized Mercedes-Benz Center or visit **www.mbusa.com** (USA only).

To provide important corrosion protection, the solution must be at least 50% anticorrosion/antifreeze (equivalent to freeze protection to approximately -35°F [-37°C]).

If you use a solution that is more than 55% anticorrosion/antifreeze (freeze protection to approximately -49°F [-45°C]), the engine temperature will increase due to the lower heat transfer capability of the solution.

Therefore, do not use more than this amount of anticorrosion/antifreeze.

If the coolant level is low, water and MB 325.0 Anticorrosion/Antifreeze should be used to bring it up to the proper level (have cooling system checked for signs of leakage). Please make sure the mixture is in accordance with label instructions.

The water in the cooling system must meet minimum requirements, which are usually satisfied by normal drinking water.

If you are not sure about the water quality, contact an authorized Mercedes-Benz Center.

### **Anticorrosion/antifreeze**

Your vehicle contains a number of aluminum parts. The use of aluminum components in motor vehicle engines necessitates that anticorrosion/antifreeze coolant used in such engines be specifically formulated to protect the aluminum parts. Failure to use such anticorrosion/antifreeze coolant will result in a significantly shortened service life. Therefore, the following product is strongly recommended for use in your vehicle: MB 325.0 Anticorrosion/Antifreeze agent.

Before the start of the winter season (or once a year in hot southern regions), you should have the anticorrosion/antifreeze concentration checked.

The coolant is also regularly checked each time you bring your vehicle to an authorized Mercedes-Benz Center for service.

	Model	Approximate freeze protection	
		-35°F (-37°C)	-49°F (-45°C)
Cooling system	G 550	6.4 US qt (6.05 l)	7.1 US qt (6.7 l)
	G 55 AMG	6.7 US qt (6.35 l)	7.4 US qt (7.0 l)

### Washer system and headlamp cleaning system

#### Warning!

Washer solvent/antifreeze is highly flammable. Do not spill washer solvent/antifreeze on hot engine parts, because it may ignite and burn. You could be seriously burned.

- ▶ Use MB Windshield Washer Concentrate “MB SummerFit”.
- ▶ Mix with water for temperatures above freezing point.
- ▶ Mix with commercially available premixed washer solvent/antifreeze for temperatures below freezing point.

### Washer fluid mixing ratio

For temperatures above freezing point:  
1 part “MB SummerFit” to 100 parts water  
(1.34 fl oz [40 ml] “MB SummerFit” to 1 gal [4.0 l] water)

For temperatures below freezing point:  
1 part “MB SummerFit” to 100 parts solvent  
(1.34 fl oz [40 ml] “MB SummerFit” to 1 gal [4.0 l] solvent)







## Service and Literature

Your authorized Mercedes-Benz Center has trained technicians and Genuine Mercedes-Benz Parts to service your vehicle properly. For expert advice and quality service, contact an authorized Mercedes-Benz Center.

If you are interested in obtaining service literature for your vehicle, please contact an authorized Mercedes-Benz Center.

We consider this the best way for you to obtain accurate information for your vehicle.

For further information you can find us on the Mercedes-Benz web-site **www.mbusa.com** (USA only) or **www.mercedes-benz.ca** (Canada only).

### **Warning!**

To help avoid personal injury, be extremely careful when performing any service work or repairs. Improper or incomplete service or the use of incorrect or inappropriate parts or materials may damage the vehicle or its equipment, which may in turn result in personal injury.

If you have any questions about carrying out any type of service, turn to the advice of an authorized Mercedes-Benz Center.

We reserve the right to make changes in design and equipment. Therefore, information, illustrations and descriptions in this Operator's Manual might differ from your vehicle.

Reprinting, translation and copying, even of excerpts, is not permitted without our prior authorization in writing.

Press time January 15, 2009

GSP/OIS

Printed in U. S. A.



4635844182

Order no. 6515 4101 13 Part no. 463 584 41 82 Edition B 2009